

Schema IRD_XML_Spezifikation.xsd

schema location: http://xml.ir-d.de/rst/schema/rfc/V5.0.0/IRD_XML_Spezifikation.xsd
attributeFormDefault:
elementFormDefault: **unqualified**
targetNamespace: **http://xml.ir-d.de/rst**

Elements

[GEMeldung](#)
[GESelbstauskunft](#)
[GESTorno](#)
[IRDMeldungAntwort](#)
[IRDSelbstauskunftAntwort](#)
[IRDStornoAntwort](#)

schema location: <http://xml.ir-d.de/rst/schema/rfc/V5.0.0/GEMeldung.xsd>
attributeFormDefault:
elementFormDefault: **unqualified**
targetNamespace: **http://xml.ir-d.de/emg**

Complex types

[GeMeldung](#)

schema location: <http://xml.ir-d.de/rst/schema/rfc/V5.0.0/GESTorno.xsd>
attributeFormDefault:
elementFormDefault: **unqualified**
targetNamespace: **http://xml.ir-d.de/stn**

Complex types

[GeStorno](#)

schema location: <http://xml.ir-d.de/rst/schema/rfc/V5.0.0/IRDMeldungAntwort.xsd>
attributeFormDefault:
elementFormDefault: **unqualified**
targetNamespace: **http://xml.ir-d.de/irdma**

Complex types

[meldungAntwort](#)

schema location: <http://xml.ir-d.de/rst/schema/rfc/V5.0.0/IRDStornoAntwort.xsd>
attributeFormDefault:
elementFormDefault: **unqualified**
targetNamespace: **http://xml.ir-d.de/irdsa**

Complex types

[stornoAntwort](#)

schema location: <http://xml.ir-d.de/rst/schema/rfc/V5.0.0/GESelbstauskunft.xsd>
attributeFormDefault:
elementFormDefault: **unqualified**
targetNamespace: **http://xml.ir-d.de/sak**

Complex types

[GeSelbstauskunft](#)

schema location: <http://xml.ir-d.de/rst/schema/rfc/V5.0.0/IRDSelbstauskunftAntwort.xsd>
attributeFormDefault:
elementFormDefault: **unqualified**
targetNamespace: **http://xml.ir-d.de/irdsaa**

Complex types

[selbstauskunftAntwort](#)

schema location: <http://xml.ir-d.de/rst/schema/rfc/V5.0.0/Bausteine/Meldung.xsd>
attributeFormDefault:
elementFormDefault: **unqualified**
targetNamespace: **http://xml.ir-d.de/emg**

Complex types

[Meldung](#)

schema location: <http://xml.ir-d.de/rst/schema/rfc/V5.0.0/Bausteine/Storno.xsd>
attributeFormDefault:
elementFormDefault: **unqualified**
targetNamespace: **http://xml.ir-d.de/stn**

Complex types

[Storno](#)

schema location: <http://xml.ir-d.de/rst/schema/rfc/V5.0.0/Bausteine/MeldungIrd.xsd>
attributeFormDefault:
elementFormDefault: **unqualified**
targetNamespace: **http://xml.ir-d.de/irdma**

Complex types

[MeldungIrd](#)

schema location: <http://xml.ir-d.de/rst/schema/rfc/V5.0.0/Bausteine/EmpfangsbestaetigungBasis.xsd>
attributeFormDefault:
elementFormDefault: **unqualified**
targetNamespace: **http://xml.ir-d.de/irdma**

Complex types

[EmpfangsbestaetigungBasis](#)

schema location: <http://xml.ir-d.de/rst/schema/rfc/V5.0.0/Bausteine/HinweisBasis.xsd>
attributeFormDefault:
elementFormDefault: **unqualified**
targetNamespace: **http://xml.ir-d.de/irdma**

Complex types

[HinweisBasis](#)

schema location: <http://xml.ir-d.de/rst/schema/rfc/V5.0.0/Bausteine/Warnung.xsd>
attributeFormDefault:
elementFormDefault: **unqualified**
targetNamespace: **http://xml.ir-d.de/irdma**

Complex types

[Warnung](#)

schema location: <http://xml.ir-d.de/rst/schema/rfc/V5.0.0/Bausteine/BestaetigungBasis.xsd>
attributeFormDefault:
elementFormDefault: **unqualified**
targetNamespace: **http://xml.ir-d.de/irdma**

Complex types

[BestaetigungBasis](#)

schema location: <http://xml.ir-d.de/rst/schema/rfc/V5.0.0/Bausteine/Storno.xsd>
attributeFormDefault:
elementFormDefault: **unqualified**
targetNamespace: **http://xml.ir-d.de/irdsa**

Complex types

[Storno](#)

schema location: <http://xml.ir-d.de/rst/schema/rfc/V5.0.0/Bausteine/EmpfangsbestaetigungBasis.xsd>
attributeFormDefault:
elementFormDefault: **unqualified**
targetNamespace: **http://xml.ir-d.de/irdsa**

Complex types

[EmpfangsbestaetigungBasis](#)

schema location: <http://xml.ir-d.de/rst/schema/rfc/V5.0.0/Bausteine/HinweisBasis.xsd>
attributeFormDefault:
elementFormDefault: **unqualified**
targetNamespace: **http://xml.ir-d.de/irdsa**

Complex types

[HinweisBasis](#)

schema location: <http://xml.ir-d.de/rst/schema/rfc/V5.0.0/Bausteine/Selbstauskunft.xsd>
attributeFormDefault:
elementFormDefault: **unqualified**
targetNamespace: **http://xml.ir-d.de/sak**

Complex types

[Selbstauskunft](#)

schema location: <http://xml.ir-d.de/rst/schema/rfc/V5.0.0/Bausteine/Selbstauskunft.xsd>
attributeFormDefault:
elementFormDefault: **unqualified**
targetNamespace: **http://xml.ir-d.de/irdsaa**

Complex types

[Selbstauskunft](#)

schema location: <http://xml.ir-d.de/rst/schema/rfc/V5.0.0/Bausteine/EmpfangsbestaetigungBasis.xsd>
attributeFormDefault:
elementFormDefault: **unqualified**
targetNamespace: **http://xml.ir-d.de/irdsaa**

Complex types

[EmpfangsbestaetigungBasis](#)

schema location: <http://xml.ir-d.de/rst/schema/rfc/V5.0.0/Bausteine/MeldungBasis.xsd>
attributeFormDefault:
elementFormDefault: **unqualified**
targetNamespace: **http://xml.ir-d.de/emg**

Complex types

[MeldungBasis](#)

schema location: <http://xml.ir-d.de/rst/schema/rfc/V5.0.0/Bausteine/Fall.xsd>
attributeFormDefault:
elementFormDefault: **unqualified**
targetNamespace: **http://xml.ir-d.de/emg**

Complex types

[Fall](#)

schema location: http://xml.ir-d.de/rst/schema/rfc/V5.0.0/Datentypen/IRD_DatenTypen.xsd
attributeFormDefault:
elementFormDefault: **unqualified**
targetNamespace: **http://xml.ir-d.de/stn**

Simple types

[DatumText](#)

[Freitext250](#)

[Freitext500](#)

[HashString](#)

[HashWert](#)

[ICD](#)

[IdBsnr](#)

[IdEinrichtung](#)

[IdStandort](#)

[IrdArtikellId](#)

[IrdSpezVersion](#)

[JaLeer](#)

[Meldebestaetigung](#)

[OPS](#)

[String2](#)

[String20](#)

[String7](#)

[Sw](#)

[Transfervnummer](#)

[Versionsnummer](#)

[Zahl1](#)

[Zahl1_1](#)

[Zahl2](#)

[Zahl2_1](#)
[Zahl3](#)
[Zahl3_1](#)
[Zahl3mitNull](#)
[Zahl4](#)
[Zahl5](#)
[Zahl5mitNull](#)

schema location: <http://xml.ir-d.de/rst/schema/rfc/V5.0.0/Bausteine/MeldungIrdBasis.xsd>
attributeFormDefault:
elementFormDefault: **unqualified**
targetNamespace: **http://xml.ir-d.de/stn**

Complex types
[MeldungIrdBasis](#)

schema location: <http://xml.ir-d.de/rst/schema/rfc/V5.0.0/Bausteine/StornoFallBasis.xsd>
attributeFormDefault:
elementFormDefault: **unqualified**
targetNamespace: **http://xml.ir-d.de/stn**

Complex types
[StornoFallBasis](#)

schema location: http://xml.ir-d.de/rst/schema/rfc/V5.0.0/Datentypen/IRD_DatenTypen.xsd
attributeFormDefault:
elementFormDefault: **unqualified**
targetNamespace: **http://xml.ir-d.de/irdma**

Simple types
[DatumText](#)
[Freitext250](#)
[Freitext500](#)
[HashString](#)
[HashWert](#)
[ICD](#)
[IdBsnr](#)
[IdEinrichtung](#)
[IdStandort](#)
[IrdArtikelId](#)
[IrdSpezVersion](#)
[JaLeer](#)
[Meldebestaetigung](#)
[OPS](#)
[String2](#)
[String20](#)
[String7](#)
[Sw](#)
[Transfervnummer](#)
[Versionsnummer](#)

[Zahl1](#)
[Zahl1_1](#)
[Zahl2](#)
[Zahl2_1](#)
[Zahl3](#)
[Zahl3_1](#)
[Zahl3mitNull](#)
[Zahl4](#)
[Zahl5](#)
[Zahl5mitNull](#)

schema location: <http://xml.ir-d.de/rst/schema/rfc/V5.0.0/Bausteine/MeldungIrdBasis.xsd>
attributeFormDefault:
elementFormDefault: **unqualified**
targetNamespace: **http://xml.ir-d.de/irdma**

Complex types
[MeldungIrdBasis](#)

schema location: <http://xml.ir-d.de/rst/schema/rfc/V5.0.0/Bausteine/MeldungIrdFallBasis.xsd>
attributeFormDefault:
elementFormDefault: **unqualified**
targetNamespace: **http://xml.ir-d.de/irdma**

Complex types
[MeldungIrdFallBasis](#)

schema location: http://xml.ir-d.de/rst/schema/rfc/V5.0.0/Datentypen/IRD_DatenTypen.xsd
attributeFormDefault:
elementFormDefault: **unqualified**
targetNamespace: **http://xml.ir-d.de/irdsa**

Simple types
[DatumText](#)
[Freitext250](#)
[Freitext500](#)
[HashString](#)
[HashWert](#)
[ICD](#)
[IdBsnr](#)
[IdEinrichtung](#)
[IdStandort](#)
[IrdArtikelId](#)
[IrdSpezVersion](#)
[JaLeer](#)
[Meldebestaetigung](#)
[OPS](#)
[String2](#)
[String20](#)
[String7](#)

[Sw](#)
[Transfervummer](#)
[Versionsnummer](#)
[Zahl1](#)
[Zahl1_1](#)
[Zahl2](#)
[Zahl2_1](#)
[Zahl3](#)
[Zahl3_1](#)
[Zahl3mitNull](#)
[Zahl4](#)
[Zahl5](#)
[Zahl5mitNull](#)

schema location: <http://xml.ir-d.de/rst/schema/rfc/V5.0.0/Bausteine/MeldungIrdBasis.xsd>
attributeFormDefault:
elementFormDefault: **unqualified**
targetNamespace: **http://xml.ir-d.de/irdsa**

Complex types
[MeldungIrdBasis](#)

schema location: <http://xml.ir-d.de/rst/schema/rfc/V5.0.0/Bausteine/StornoFallBasis.xsd>
attributeFormDefault:
elementFormDefault: **unqualified**
targetNamespace: **http://xml.ir-d.de/irdsa**

Complex types
[StornoFallBasis](#)

schema location: http://xml.ir-d.de/rst/schema/rfc/V5.0.0/Datentypen/IRD_DatenTypen.xsd
attributeFormDefault:
elementFormDefault: **unqualified**
targetNamespace: **http://xml.ir-d.de/sak**

Simple types
[DatumText](#)
[Freitext250](#)
[Freitext500](#)
[HashString](#)
[HashWert](#)
[ICD](#)
[IdBsnr](#)
[IdEinrichtung](#)
[IdStandort](#)
[IrdArtikelId](#)
[IrdSpezVersion](#)
[JaLeer](#)
[Meldebestaetigung](#)
[OPS](#)

[String2](#)
[String20](#)
[String7](#)
[Sw](#)
[Transfervnummer](#)
[Versionsnummer](#)
[Zahl1](#)
[Zahl1_1](#)
[Zahl2](#)
[Zahl2_1](#)
[Zahl3](#)
[Zahl3_1](#)
[Zahl3mitNull](#)
[Zahl4](#)
[Zahl5](#)
[Zahl5mitNull](#)

schema location: <http://xml.ir-d.de/rst/schema/rfc/V5.0.0/Bausteine/MeldungIrdBasis.xsd>
attributeFormDefault:
elementFormDefault: **unqualified**
targetNamespace: **http://xml.ir-d.de/sak**

Complex types
[MeldungIrdBasis](#)

schema location: <http://xml.ir-d.de/rst/schema/rfc/V5.0.0/Bausteine/SelbstauskunftFallBasis.xsd>
attributeFormDefault:
elementFormDefault: **unqualified**
targetNamespace: **http://xml.ir-d.de/sak**

Complex types
[SelbstauskunftFallBasis](#)

schema location: http://xml.ir-d.de/rst/schema/rfc/V5.0.0/Datentypen/IRD_DatenTypen.xsd
attributeFormDefault:
elementFormDefault: **unqualified**
targetNamespace: **http://xml.ir-d.de/irdsaa**

Simple types
[DatumText](#)
[Freitext250](#)
[Freitext500](#)
[HashString](#)
[HashWert](#)
[ICD](#)
[IdBsnr](#)
[IdEinrichtung](#)
[IdStandort](#)
[IrdArtikelId](#)
[IrdSpezVersion](#)

[JaLeer](#)
[Meldebestaetigung](#)
[OPS](#)
[String2](#)
[String20](#)
[String7](#)
[Sw](#)
[Transfervummer](#)
[Versionsnummer](#)
[Zahl1](#)
[Zahl1 1](#)
[Zahl2](#)
[Zahl2 1](#)
[Zahl3](#)
[Zahl3 1](#)
[Zahl3mitNull](#)
[Zahl4](#)
[Zahl5](#)
[Zahl5mitNull](#)

schema location: <http://xml.ir-d.de/rst/schema/rfc/V5.0.0/Bausteine/MeldungIrdBasis.xsd>
attributeFormDefault:
elementFormDefault: **unqualified**
targetNamespace: **http://xml.ir-d.de/irdsaa**

Complex types
[MeldungIrdBasis](#)

schema location: <http://xml.ir-d.de/rst/schema/rfc/V5.0.0/Bausteine/SelbstauskunftFallBasis.xsd>
attributeFormDefault:
elementFormDefault: **unqualified**
targetNamespace: **http://xml.ir-d.de/irdsaa**

Complex types
[SelbstauskunftFallBasis](#)

schema location: http://xml.ir-d.de/rst/schema/rfc/V5.0.0/Datentypen/IRD_DatenTypen.xsd
attributeFormDefault:
elementFormDefault: **unqualified**
targetNamespace: **http://xml.ir-d.de/emg**

Simple types
[DatumText](#)
[Freitext250](#)
[Freitext500](#)
[HashString](#)
[HashWert](#)
[ICD](#)
[IdBsnr](#)
[IdEinrichtung](#)

[IdStandort](#)
[IrdArtikelId](#)
[IrdSpezVersion](#)
[JaLeer](#)
[Meldebestaetigung](#)
[OPS](#)
[String2](#)
[String20](#)
[String7](#)
[Sw](#)
[Transfervummer](#)
[Versionsnummer](#)
[Zahl1](#)
[Zahl1_1](#)
[Zahl2](#)
[Zahl2_1](#)
[Zahl3](#)
[Zahl3_1](#)
[Zahl3mitNull](#)
[Zahl4](#)
[Zahl5](#)
[Zahl5mitNull](#)

schema location: <http://xml.ir-d.de/rst/schema/rfc/V5.0.0/Bausteine/FallBasis.xsd>
attributeFormDefault:
elementFormDefault: **unqualified**
targetNamespace: **http://xml.ir-d.de/emg**

Complex types
[FallBasis](#)

schema location: <http://xml.ir-d.de/rst/schema/rfc/V5.0.0/Bausteine/AusloeserBasis.xsd>
attributeFormDefault:
elementFormDefault: **unqualified**
targetNamespace: **http://xml.ir-d.de/emg**

Complex types
[AusloeserBasis](#)

schema location: <http://xml.ir-d.de/rst/schema/rfc/V5.0.0/Bausteine/Patientenaufnahme.xsd>
attributeFormDefault:
elementFormDefault: **unqualified**
targetNamespace: **http://xml.ir-d.de/emg**

Complex types
[Patientenaufnahme](#)

schema location: <http://xml.ir-d.de/rst/schema/rfc/V5.0.0/Bausteine/Operation.xsd>
attributeFormDefault:
elementFormDefault: **unqualified**
targetNamespace: **http://xml.ir-d.de/emg**

Complex types

[Operation](#)

schema location: <http://xml.ir-d.de/rst/schema/rfc/V5.0.0/Bausteine/Entlassung.xsd>
attributeFormDefault:
elementFormDefault: **unqualified**
targetNamespace: **http://xml.ir-d.de/emg**

Complex types

[Entlassung](#)

schema location: <http://xml.ir-d.de/rst/schema/rfc/V5.0.0/Bausteine/PostoperationAortenklappe.xsd>
attributeFormDefault:
elementFormDefault: **unqualified**
targetNamespace: **http://xml.ir-d.de/emg**

Complex types

[PostoperationAortenklappe](#)

schema location: http://xml.ir-d.de/rst/schema/rfc/V5.0.0/Datentypen/IRD_Wertelisten.xsd
attributeFormDefault:
elementFormDefault: **qualified**
targetNamespace: **http://xml.ir-d.de/stn**

Simple types

[enum 0044](#)
[enum 0050](#)
[enum 0060](#)
[enum 0061](#)
[enum 0062](#)
[enum 0065](#)
[enum 0067](#)
[enum 0068](#)
[enum 0069](#)
[enum 0070](#)
[enum 0071](#)
[enum 0075](#)
[enum 0076](#)
[enum 0080](#)
[enum 0100](#)
[enum 0102](#)
[enum 0103](#)
[enum 0104](#)

[enum 0105](#)
[enum 0106](#)
[enum 0107](#)
[enum 0110](#)
[enum 0111](#)
[enum 0112](#)
[enum 0113](#)
[enum 0114](#)
[enum 0116](#)
[enum 0118](#)
[enum 0120](#)
[enum 0121](#)
[enum 0122](#)
[enum 0123](#)
[enum 0124](#)
[enum 0126](#)
[enum 0128](#)
[enum 0131](#)
[enum 0170](#)
[enum 0190](#)
[enum 0191](#)
[enum 0200](#)
[enum 0202](#)
[enum 0204](#)
[enum 0206](#)
[enum 0210](#)
[enum 0211](#)
[enum 0212](#)
[enum 0220](#)
[enum 0222](#)
[enum 0252](#)
[enum 0254](#)
[enum 0256](#)
[enum 0262](#)
[enum 0264](#)
[enum 0266](#)
[enum 0270](#)
[enum 0271](#)
[enum 0280](#)
[enum 0281](#)
[enum 0282](#)
[enum 0290](#)
[enum 0292](#)
[enum 0293](#)
[enum 0300](#)
[enum 0301](#)
[enum 0302](#)
[enum 0318](#)
[enum 0320](#)
[enum 0322](#)
[enum 0324](#)
[enum 0338](#)
[enum 0339](#)
[enum 0341](#)
[enum 0342](#)
[enum 0343](#)
[enum 0346](#)
[enum 0347](#)
[enum 0348](#)
[enum 0350](#)
[enum 0351](#)
[enum 0352](#)
[enum 0353](#)
[enum 0354](#)
[enum 0357](#)

[enum 0358](#)
[enum 0359](#)
[enum 0360](#)
[enum 0361](#)
[enum 0362](#)
[enum 0363](#)
[enum 0364](#)
[enum 0365](#)
[enum 0366](#)
[enum 0367](#)
[enum 0368](#)
[enum 0369](#)
[enum 0370](#)
[enum 0371](#)
[enum 0372](#)
[enum 0373](#)
[enum 0374](#)
[enum 0375](#)
[enum 0376](#)
[enum 0377](#)
[enum 0378](#)
[enum 0379](#)
[enum 0380](#)
[enum 0381](#)
[enum 0382](#)
[enum 0383](#)
[enum 0384](#)
[enum 0385](#)
[enum 0388](#)
[enum 0389](#)
[enum 0390](#)
[enum 0391](#)
[enum 0398](#)
[enum 0399](#)

schema location: http://xml.ir-d.de/rst/schema/rfc/V5.0.0/Datentypen/IRD_Wertelisten.xsd

attributeFormDefault:

elementFormDefault:

qualified

targetNamespace:

<http://xml.ir-d.de/irdma>

Simple types

[enum 0044](#)
[enum 0050](#)
[enum 0060](#)
[enum 0061](#)
[enum 0062](#)
[enum 0065](#)
[enum 0067](#)
[enum 0068](#)
[enum 0069](#)
[enum 0070](#)
[enum 0071](#)
[enum 0075](#)
[enum 0076](#)
[enum 0080](#)
[enum 0100](#)
[enum 0102](#)
[enum 0103](#)
[enum 0104](#)
[enum 0105](#)

[enum 0106](#)
[enum 0107](#)
[enum 0110](#)
[enum 0111](#)
[enum 0112](#)
[enum 0113](#)
[enum 0114](#)
[enum 0116](#)
[enum 0118](#)
[enum 0120](#)
[enum 0121](#)
[enum 0122](#)
[enum 0123](#)
[enum 0124](#)
[enum 0126](#)
[enum 0128](#)
[enum 0131](#)
[enum 0170](#)
[enum 0190](#)
[enum 0191](#)
[enum 0200](#)
[enum 0202](#)
[enum 0204](#)
[enum 0206](#)
[enum 0210](#)
[enum 0211](#)
[enum 0212](#)
[enum 0220](#)
[enum 0222](#)
[enum 0252](#)
[enum 0254](#)
[enum 0256](#)
[enum 0262](#)
[enum 0264](#)
[enum 0266](#)
[enum 0270](#)
[enum 0271](#)
[enum 0280](#)
[enum 0281](#)
[enum 0282](#)
[enum 0290](#)
[enum 0292](#)
[enum 0293](#)
[enum 0300](#)
[enum 0301](#)
[enum 0302](#)
[enum 0318](#)
[enum 0320](#)
[enum 0322](#)
[enum 0324](#)
[enum 0338](#)
[enum 0339](#)
[enum 0341](#)
[enum 0342](#)
[enum 0343](#)
[enum 0346](#)
[enum 0347](#)
[enum 0348](#)
[enum 0350](#)
[enum 0351](#)
[enum 0352](#)
[enum 0353](#)
[enum 0354](#)
[enum 0357](#)
[enum 0358](#)

[enum 0359](#)
[enum 0360](#)
[enum 0361](#)
[enum 0362](#)
[enum 0363](#)
[enum 0364](#)
[enum 0365](#)
[enum 0366](#)
[enum 0367](#)
[enum 0368](#)
[enum 0369](#)
[enum 0370](#)
[enum 0371](#)
[enum 0372](#)
[enum 0373](#)
[enum 0374](#)
[enum 0375](#)
[enum 0376](#)
[enum 0377](#)
[enum 0378](#)
[enum 0379](#)
[enum 0380](#)
[enum 0381](#)
[enum 0382](#)
[enum 0383](#)
[enum 0384](#)
[enum 0385](#)
[enum 0388](#)
[enum 0389](#)
[enum 0390](#)
[enum 0391](#)
[enum 0398](#)
[enum 0399](#)

schema location: http://xml.ir-d.de/rst/schema/rfc/V5.0.0/Datentypen/IRD_Wertelisten.xsd
attributeFormDefault:
elementFormDefault: **qualified**
targetNamespace: **http://xml.ir-d.de/irdsa**

Simple types

[enum 0044](#)
[enum 0050](#)
[enum 0060](#)
[enum 0061](#)
[enum 0062](#)
[enum 0065](#)
[enum 0067](#)
[enum 0068](#)
[enum 0069](#)
[enum 0070](#)
[enum 0071](#)
[enum 0075](#)
[enum 0076](#)
[enum 0080](#)
[enum 0100](#)
[enum 0102](#)
[enum 0103](#)
[enum 0104](#)
[enum 0105](#)
[enum 0106](#)

[enum 0107](#)
[enum 0110](#)
[enum 0111](#)
[enum 0112](#)
[enum 0113](#)
[enum 0114](#)
[enum 0116](#)
[enum 0118](#)
[enum 0120](#)
[enum 0121](#)
[enum 0122](#)
[enum 0123](#)
[enum 0124](#)
[enum 0126](#)
[enum 0128](#)
[enum 0131](#)
[enum 0170](#)
[enum 0190](#)
[enum 0191](#)
[enum 0200](#)
[enum 0202](#)
[enum 0204](#)
[enum 0206](#)
[enum 0210](#)
[enum 0211](#)
[enum 0212](#)
[enum 0220](#)
[enum 0222](#)
[enum 0252](#)
[enum 0254](#)
[enum 0256](#)
[enum 0262](#)
[enum 0264](#)
[enum 0266](#)
[enum 0270](#)
[enum 0271](#)
[enum 0280](#)
[enum 0281](#)
[enum 0282](#)
[enum 0290](#)
[enum 0292](#)
[enum 0293](#)
[enum 0300](#)
[enum 0301](#)
[enum 0302](#)
[enum 0318](#)
[enum 0320](#)
[enum 0322](#)
[enum 0324](#)
[enum 0338](#)
[enum 0339](#)
[enum 0341](#)
[enum 0342](#)
[enum 0343](#)
[enum 0346](#)
[enum 0347](#)
[enum 0348](#)
[enum 0350](#)
[enum 0351](#)
[enum 0352](#)
[enum 0353](#)
[enum 0354](#)
[enum 0357](#)
[enum 0358](#)
[enum 0359](#)

[enum 0360](#)
[enum 0361](#)
[enum 0362](#)
[enum 0363](#)
[enum 0364](#)
[enum 0365](#)
[enum 0366](#)
[enum 0367](#)
[enum 0368](#)
[enum 0369](#)
[enum 0370](#)
[enum 0371](#)
[enum 0372](#)
[enum 0373](#)
[enum 0374](#)
[enum 0375](#)
[enum 0376](#)
[enum 0377](#)
[enum 0378](#)
[enum 0379](#)
[enum 0380](#)
[enum 0381](#)
[enum 0382](#)
[enum 0383](#)
[enum 0384](#)
[enum 0385](#)
[enum 0388](#)
[enum 0389](#)
[enum 0390](#)
[enum 0391](#)
[enum 0398](#)
[enum 0399](#)

schema location: http://xml.ir-d.de/rst/schema/rfc/V5.0.0/Datentypen/IRD_Wertelisten.xsd
attributeFormDefault:
elementFormDefault: **qualified**
targetNamespace: <http://xml.ir-d.de/sak>

Simple types
[enum 0044](#)
[enum 0050](#)
[enum 0060](#)
[enum 0061](#)
[enum 0062](#)
[enum 0065](#)
[enum 0067](#)
[enum 0068](#)
[enum 0069](#)
[enum 0070](#)
[enum 0071](#)
[enum 0075](#)
[enum 0076](#)
[enum 0080](#)
[enum 0100](#)
[enum 0102](#)
[enum 0103](#)
[enum 0104](#)
[enum 0105](#)
[enum 0106](#)
[enum 0107](#)

[enum 0110](#)
[enum 0111](#)
[enum 0112](#)
[enum 0113](#)
[enum 0114](#)
[enum 0116](#)
[enum 0118](#)
[enum 0120](#)
[enum 0121](#)
[enum 0122](#)
[enum 0123](#)
[enum 0124](#)
[enum 0126](#)
[enum 0128](#)
[enum 0131](#)
[enum 0170](#)
[enum 0190](#)
[enum 0191](#)
[enum 0200](#)
[enum 0202](#)
[enum 0204](#)
[enum 0206](#)
[enum 0210](#)
[enum 0211](#)
[enum 0212](#)
[enum 0220](#)
[enum 0222](#)
[enum 0252](#)
[enum 0254](#)
[enum 0256](#)
[enum 0262](#)
[enum 0264](#)
[enum 0266](#)
[enum 0270](#)
[enum 0271](#)
[enum 0280](#)
[enum 0281](#)
[enum 0282](#)
[enum 0290](#)
[enum 0292](#)
[enum 0293](#)
[enum 0300](#)
[enum 0301](#)
[enum 0302](#)
[enum 0318](#)
[enum 0320](#)
[enum 0322](#)
[enum 0324](#)
[enum 0338](#)
[enum 0339](#)
[enum 0341](#)
[enum 0342](#)
[enum 0343](#)
[enum 0346](#)
[enum 0347](#)
[enum 0348](#)
[enum 0350](#)
[enum 0351](#)
[enum 0352](#)
[enum 0353](#)
[enum 0354](#)
[enum 0357](#)
[enum 0358](#)
[enum 0359](#)
[enum 0360](#)

[enum 0361](#)
[enum 0362](#)
[enum 0363](#)
[enum 0364](#)
[enum 0365](#)
[enum 0366](#)
[enum 0367](#)
[enum 0368](#)
[enum 0369](#)
[enum 0370](#)
[enum 0371](#)
[enum 0372](#)
[enum 0373](#)
[enum 0374](#)
[enum 0375](#)
[enum 0376](#)
[enum 0377](#)
[enum 0378](#)
[enum 0379](#)
[enum 0380](#)
[enum 0381](#)
[enum 0382](#)
[enum 0383](#)
[enum 0384](#)
[enum 0385](#)
[enum 0388](#)
[enum 0389](#)
[enum 0390](#)
[enum 0391](#)
[enum 0398](#)
[enum 0399](#)

schema location: http://xml.ir-d.de/rst/schema/rfc/V5.0.0/Datentypen/IRD_Wertelisten.xsd
attributeFormDefault:
elementFormDefault: **qualified**
targetNamespace: <http://xml.ir-d.de/irdsaa>

Simple types
[enum 0044](#)
[enum 0050](#)
[enum 0060](#)
[enum 0061](#)
[enum 0062](#)
[enum 0065](#)
[enum 0067](#)
[enum 0068](#)
[enum 0069](#)
[enum 0070](#)
[enum 0071](#)
[enum 0075](#)
[enum 0076](#)
[enum 0080](#)
[enum 0100](#)
[enum 0102](#)
[enum 0103](#)
[enum 0104](#)
[enum 0105](#)
[enum 0106](#)
[enum 0107](#)
[enum 0110](#)

[enum 0111](#)
[enum 0112](#)
[enum 0113](#)
[enum 0114](#)
[enum 0116](#)
[enum 0118](#)
[enum 0120](#)
[enum 0121](#)
[enum 0122](#)
[enum 0123](#)
[enum 0124](#)
[enum 0126](#)
[enum 0128](#)
[enum 0131](#)
[enum 0170](#)
[enum 0190](#)
[enum 0191](#)
[enum 0200](#)
[enum 0202](#)
[enum 0204](#)
[enum 0206](#)
[enum 0210](#)
[enum 0211](#)
[enum 0212](#)
[enum 0220](#)
[enum 0222](#)
[enum 0252](#)
[enum 0254](#)
[enum 0256](#)
[enum 0262](#)
[enum 0264](#)
[enum 0266](#)
[enum 0270](#)
[enum 0271](#)
[enum 0280](#)
[enum 0281](#)
[enum 0282](#)
[enum 0290](#)
[enum 0292](#)
[enum 0293](#)
[enum 0300](#)
[enum 0301](#)
[enum 0302](#)
[enum 0318](#)
[enum 0320](#)
[enum 0322](#)
[enum 0324](#)
[enum 0338](#)
[enum 0339](#)
[enum 0341](#)
[enum 0342](#)
[enum 0343](#)
[enum 0346](#)
[enum 0347](#)
[enum 0348](#)
[enum 0350](#)
[enum 0351](#)
[enum 0352](#)
[enum 0353](#)
[enum 0354](#)
[enum 0357](#)
[enum 0358](#)
[enum 0359](#)
[enum 0360](#)
[enum 0361](#)

[enum 0362](#)
[enum 0363](#)
[enum 0364](#)
[enum 0365](#)
[enum 0366](#)
[enum 0367](#)
[enum 0368](#)
[enum 0369](#)
[enum 0370](#)
[enum 0371](#)
[enum 0372](#)
[enum 0373](#)
[enum 0374](#)
[enum 0375](#)
[enum 0376](#)
[enum 0377](#)
[enum 0378](#)
[enum 0379](#)
[enum 0380](#)
[enum 0381](#)
[enum 0382](#)
[enum 0383](#)
[enum 0384](#)
[enum 0385](#)
[enum 0388](#)
[enum 0389](#)
[enum 0390](#)
[enum 0391](#)
[enum 0398](#)
[enum 0399](#)

schema location: http://xml.ir-d.de/rst/schema/rfc/V5.0.0/Datentypen/IRD_Wertelisten.xsd
attributeFormDefault:
elementFormDefault: **qualified**
targetNamespace: <http://xml.ir-d.de/emg>

Simple types

[enum 0044](#)
[enum 0050](#)
[enum 0060](#)
[enum 0061](#)
[enum 0062](#)
[enum 0065](#)
[enum 0067](#)
[enum 0068](#)
[enum 0069](#)
[enum 0070](#)
[enum 0071](#)
[enum 0075](#)
[enum 0076](#)
[enum 0080](#)
[enum 0100](#)
[enum 0102](#)
[enum 0103](#)
[enum 0104](#)
[enum 0105](#)
[enum 0106](#)
[enum 0107](#)
[enum 0110](#)
[enum 0111](#)

[enum 0112](#)
[enum 0113](#)
[enum 0114](#)
[enum 0116](#)
[enum 0118](#)
[enum 0120](#)
[enum 0121](#)
[enum 0122](#)
[enum 0123](#)
[enum 0124](#)
[enum 0126](#)
[enum 0128](#)
[enum 0131](#)
[enum 0170](#)
[enum 0190](#)
[enum 0191](#)
[enum 0200](#)
[enum 0202](#)
[enum 0204](#)
[enum 0206](#)
[enum 0210](#)
[enum 0211](#)
[enum 0212](#)
[enum 0220](#)
[enum 0222](#)
[enum 0252](#)
[enum 0254](#)
[enum 0256](#)
[enum 0262](#)
[enum 0264](#)
[enum 0266](#)
[enum 0270](#)
[enum 0271](#)
[enum 0280](#)
[enum 0281](#)
[enum 0282](#)
[enum 0290](#)
[enum 0292](#)
[enum 0293](#)
[enum 0300](#)
[enum 0301](#)
[enum 0302](#)
[enum 0318](#)
[enum 0320](#)
[enum 0322](#)
[enum 0324](#)
[enum 0338](#)
[enum 0339](#)
[enum 0341](#)
[enum 0342](#)
[enum 0343](#)
[enum 0346](#)
[enum 0347](#)
[enum 0348](#)
[enum 0350](#)
[enum 0351](#)
[enum 0352](#)
[enum 0353](#)
[enum 0354](#)
[enum 0357](#)
[enum 0358](#)
[enum 0359](#)
[enum 0360](#)
[enum 0361](#)
[enum 0362](#)

[enum 0363](#)
[enum 0364](#)
[enum 0365](#)
[enum 0366](#)
[enum 0367](#)
[enum 0368](#)
[enum 0369](#)
[enum 0370](#)
[enum 0371](#)
[enum 0372](#)
[enum 0373](#)
[enum 0374](#)
[enum 0375](#)
[enum 0376](#)
[enum 0377](#)
[enum 0378](#)
[enum 0379](#)
[enum 0380](#)
[enum 0381](#)
[enum 0382](#)
[enum 0383](#)
[enum 0384](#)
[enum 0385](#)
[enum 0388](#)
[enum 0389](#)
[enum 0390](#)
[enum 0391](#)
[enum 0398](#)
[enum 0399](#)

schema location: <http://xml.ir-d.de/rst/schema/rfc/V5.0.0/Bausteine/PatientenaufnahmeBasis.xsd>
attributeFormDefault:
elementFormDefault: **unqualified**
targetNamespace: **http://xml.ir-d.de/emg**

Complex types
[PatientenaufnahmeBasis](#)

schema location: <http://xml.ir-d.de/rst/schema/rfc/V5.0.0/Bausteine/PatientenaufnahmeBrustimplantatBasis.xsd>
attributeFormDefault:
elementFormDefault: **unqualified**
targetNamespace: **http://xml.ir-d.de/emg**

Complex types
[PatientenaufnahmeBrustimplantatBasis](#)

schema location: <http://xml.ir-d.de/rst/schema/rfc/V5.0.0/Bausteine/PatientenaufnahmeKardiologie.xsd>
attributeFormDefault:
elementFormDefault: **unqualified**
targetNamespace: **http://xml.ir-d.de/emg**

Complex types

[PatientenaufnahmeKardiologie](#)

schema location: <http://xml.ir-d.de/rst/schema/rfc/V5.0.0/Bausteine/OperationBasis.xsd>
attributeFormDefault:
elementFormDefault: **unqualified**
targetNamespace: **http://xml.ir-d.de/emg**

Complex types

[OperationBasis](#)

schema location: <http://xml.ir-d.de/rst/schema/rfc/V5.0.0/Bausteine/OperationBrustimplantat.xsd>
attributeFormDefault:
elementFormDefault: **unqualified**
targetNamespace: **http://xml.ir-d.de/emg**

Complex types

[OperationBrustimplantat](#)

schema location: <http://xml.ir-d.de/rst/schema/rfc/V5.0.0/Bausteine/OperationEndoprothese.xsd>
attributeFormDefault:
elementFormDefault: **unqualified**
targetNamespace: **http://xml.ir-d.de/emg**

Complex types

[OperationEndoprothese](#)

schema location: <http://xml.ir-d.de/rst/schema/rfc/V5.0.0/Bausteine/OperationAortenklappe.xsd>
attributeFormDefault:
elementFormDefault: **unqualified**
targetNamespace: **http://xml.ir-d.de/emg**

Complex types

[OperationAortenklappe](#)

schema location: <http://xml.ir-d.de/rst/schema/rfc/V5.0.0/Bausteine/Artikelidentifikation.xsd>
attributeFormDefault:
elementFormDefault: **unqualified**
targetNamespace: **http://xml.ir-d.de/emg**

Complex types

[Artikelidentifikation](#)

schema location: <http://xml.ir-d.de/rst/schema/rfc/V5.0.0/Bausteine/Zubehoer.xsd>
attributeFormDefault:
elementFormDefault: **unqualified**
targetNamespace: **http://xml.ir-d.de/emg**

Complex types

[Zubehoer](#)

schema location: <http://xml.ir-d.de/rst/schema/rfc/V5.0.0/Bausteine/EntlassungBasis.xsd>
attributeFormDefault:
elementFormDefault: **unqualified**
targetNamespace: **http://xml.ir-d.de/emg**

Complex types

[EntlassungBasis](#)

schema location: <http://xml.ir-d.de/rst/schema/rfc/V5.0.0/Bausteine/DiagnoseBrustimplantatBasis.xsd>
attributeFormDefault:
elementFormDefault: **unqualified**
targetNamespace: **http://xml.ir-d.de/emg**

Complex types

[DiagnoseBrustimplantatBasis](#)

schema location: <http://xml.ir-d.de/rst/schema/rfc/V5.0.0/Bausteine/DiagnoseEndoprotheseBasis.xsd>
attributeFormDefault:
elementFormDefault: **unqualified**
targetNamespace: **http://xml.ir-d.de/emg**

Complex types

[DiagnoseEndoprotheseBasis](#)

schema location: <http://xml.ir-d.de/rst/schema/rfc/V5.0.0/Bausteine/DiagnoseAortenklappeBasis.xsd>
attributeFormDefault:
elementFormDefault: **unqualified**
targetNamespace: **http://xml.ir-d.de/emg**

Complex types

[DiagnoseAortenklappeBasis](#)

schema location: <http://xml.ir-d.de/rst/schema/rfc/V5.0.0/Bausteine/PostoperationAortenklappeBasis.xsd>
attributeFormDefault:
elementFormDefault: **unqualified**
targetNamespace: **http://xml.ir-d.de/emg**

Complex types

[PostoperationAortenklappeBasis](#)

schema location: <http://xml.ir-d.de/rst/schema/rfc/V5.0.0/Bausteine/AntikoagulansAortenklappeBasis.xsd>
attributeFormDefault:
elementFormDefault: **unqualified**
targetNamespace: **http://xml.ir-d.de/emg**

Complex types

[AntikoagulansAortenklappeBasis](#)

schema location: <http://xml.ir-d.de/rst/schema/rfc/V5.0.0/Bausteine/PatientenaufnahmeKardiologieBasis.xsd>
attributeFormDefault:
elementFormDefault: **unqualified**
targetNamespace: **http://xml.ir-d.de/emg**

Complex types

[PatientenaufnahmeKardiologieBasis](#)

schema location: <http://xml.ir-d.de/rst/schema/rfc/V5.0.0/Bausteine/PatientenaufnahmeAortenklappe.xsd>
attributeFormDefault:
elementFormDefault: **unqualified**
targetNamespace: **http://xml.ir-d.de/emg**

Complex types

[PatientenaufnahmeAortenklappe](#)

schema location: <http://xml.ir-d.de/rst/schema/rfc/V5.0.0/Bausteine/OperationBrustimplantatBasis.xsd>
attributeFormDefault:
elementFormDefault: **unqualified**
targetNamespace: **http://xml.ir-d.de/emg**

Complex types

[OperationBrustimplantatBasis](#)

schema location: <http://xml.ir-d.de/rst/schema/rfc/V5.0.0/Bausteine/VorbehandlungBrustimplantatBasis.xsd>
attributeFormDefault:
elementFormDefault: **unqualified**
targetNamespace: **http://xml.ir-d.de/emg**

Complex types

[VorbehandlungBrustimplantatBasis](#)

schema location: <http://xml.ir-d.de/rst/schema/rfc/V5.0.0/Bausteine/MassnahmeBrustimplantatBasis.xsd>
attributeFormDefault:
elementFormDefault: **unqualified**
targetNamespace: **http://xml.ir-d.de/emg**

Complex types

[MassnahmeBrustimplantatBasis](#)

schema location: <http://xml.ir-d.de/rst/schema/rfc/V5.0.0/Bausteine/OperationsdetailBrustimplantatBasis.xsd>
attributeFormDefault:
elementFormDefault: **unqualified**
targetNamespace: **http://xml.ir-d.de/emg**

Complex types

[OperationsdetailBrustimplantatBasis](#)

schema location: <http://xml.ir-d.de/rst/schema/rfc/V5.0.0/Bausteine/BefundBrustimplantatBasis.xsd>
attributeFormDefault:
elementFormDefault: **unqualified**
targetNamespace: **http://xml.ir-d.de/emg**

Complex types

[BefundBrustimplantatBasis](#)

schema location: <http://xml.ir-d.de/rst/schema/rfc/V5.0.0/Bausteine/ProzedurenSchluesselBrustimplantatBasis.xsd>
attributeFormDefault:
elementFormDefault: **unqualified**
targetNamespace: **http://xml.ir-d.de/emg**

Complex types

[ProzedurenSchluesselBrustimplantatBasis](#)

schema location: <http://xml.ir-d.de/rst/schema/rfc/V5.0.0/Bausteine/OperationEndoprotheseBasis.xsd>
attributeFormDefault:
elementFormDefault: **unqualified**
targetNamespace: **http://xml.ir-d.de/emg**

Complex types

[OperationEndoprotheseBasis](#)

schema location: <http://xml.ir-d.de/rst/schema/rfc/V5.0.0/Bausteine/VorbehandlungEndoprotheseBasis.xsd>
attributeFormDefault:
elementFormDefault: **unqualified**
targetNamespace: **http://xml.ir-d.de/emg**

Complex types

[VorbehandlungEndoprotheseBasis](#)

schema location: <http://xml.ir-d.de/rst/schema/rfc/V5.0.0/Bausteine/ProzedurenSchluesselEndoprotheseBasis.xsd>
attributeFormDefault:
elementFormDefault: **unqualified**
targetNamespace: **http://xml.ir-d.de/emg**

Complex types

[ProzedurenSchluesselEndoprotheseBasis](#)

schema location: <http://xml.ir-d.de/rst/schema/rfc/V5.0.0/Bausteine/OperationAortenklappeBasis.xsd>
attributeFormDefault:
elementFormDefault: **unqualified**
targetNamespace: **http://xml.ir-d.de/emg**

Complex types

[OperationAortenklappeBasis](#)

schema location: <http://xml.ir-d.de/rst/schema/rfc/V5.0.0/Bausteine/TaviAortenklappeBasis.xsd>
attributeFormDefault:
elementFormDefault: **unqualified**
targetNamespace: **http://xml.ir-d.de/emg**

Complex types

[TaviAortenklappeBasis](#)

schema location: <http://xml.ir-d.de/rst/schema/rfc/V5.0.0/Bausteine/ProzedurenSchluesselAortenklappeBasis.xsd>
attributeFormDefault:
elementFormDefault: **unqualified**
targetNamespace: **http://xml.ir-d.de/emg**

Complex types

[ProzedurenSchluesselAortenklappeBasis](#)

schema location: <http://xml.ir-d.de/rst/schema/rfc/V5.0.0/Bausteine/FailureGrundAortenklappeBasis.xsd>
attributeFormDefault:
elementFormDefault: **unqualified**
targetNamespace: **http://xml.ir-d.de/emg**

Complex types

[FailureGrundAortenklappeBasis](#)

schema location: <http://xml.ir-d.de/rst/schema/rfc/V5.0.0/Bausteine/PciAortenklappeBasis.xsd>
attributeFormDefault:
elementFormDefault: **unqualified**
targetNamespace: **http://xml.ir-d.de/emg**

Complex types

[PciAortenklappeBasis](#)

schema location: <http://xml.ir-d.de/rst/schema/rfc/V5.0.0/Bausteine/KomplikationAortenklappeBasis.xsd>
attributeFormDefault:
elementFormDefault: **unqualified**
targetNamespace: **http://xml.ir-d.de/emg**

Complex types

[KomplikationAortenklappeBasis](#)

schema location: <http://xml.ir-d.de/rst/schema/rfc/V5.0.0/Bausteine/ArtikelidentifikationBasis.xsd>
attributeFormDefault:
elementFormDefault: **unqualified**
targetNamespace: **http://xml.ir-d.de/emg**

Complex types

[ArtikelidentifikationBasis](#)

schema location: <http://xml.ir-d.de/rst/schema/rfc/V5.0.0/Bausteine/Artikelbeschreibung.xsd>
attributeFormDefault:
elementFormDefault: **unqualified**
targetNamespace: **http://xml.ir-d.de/emg**

Complex types

[Artikelbeschreibung](#)

schema location: <http://xml.ir-d.de/rst/schema/rfc/V5.0.0/Bausteine/ZubehoerBasis.xsd>
attributeFormDefault:
elementFormDefault: **unqualified**
targetNamespace: **http://xml.ir-d.de/emg**

Complex types

[ZubehoerBasis](#)

schema location: <http://xml.ir-d.de/rst/schema/rfc/V5.0.0/Bausteine/ZubehoerBrustimplantatBasis.xsd>
attributeFormDefault:
elementFormDefault: **unqualified**
targetNamespace: **http://xml.ir-d.de/emg**

Complex types

[ZubehoerBrustimplantatBasis](#)

schema location: <http://xml.ir-d.de/rst/schema/rfc/V5.0.0/Bausteine/PatientenaufnahmeAortenklappeBasis.xsd>
attributeFormDefault:
elementFormDefault: **unqualified**
targetNamespace: **http://xml.ir-d.de/emg**

Complex types

[PatientenaufnahmeAortenklappeBasis](#)

schema location: <http://xml.ir-d.de/rst/schema/rfc/V5.0.0/Bausteine/InfektionAortenklappeBasis.xsd>
attributeFormDefault:
elementFormDefault: **unqualified**
targetNamespace: **http://xml.ir-d.de/emg**

Complex types

[InfektionAortenklappeBasis](#)

schema location: <http://xml.ir-d.de/rst/schema/rfc/V5.0.0/Bausteine/ArtikelbeschreibungBasis.xsd>
attributeFormDefault:
elementFormDefault: **unqualified**
targetNamespace: **http://xml.ir-d.de/emg**

Complex types

[ArtikelbeschreibungBasis](#)

schema location: <http://xml.ir-d.de/rst/schema/rfc/V5.0.0/Bausteine/ArtikelBrustimplantatBasis.xsd>
attributeFormDefault:
elementFormDefault: **unqualified**
targetNamespace: **http://xml.ir-d.de/emg**

Complex types

[ArtikelBrustimplantatBasis](#)

schema location: <http://xml.ir-d.de/rst/schema/rfc/V5.0.0/Bausteine/ArtikelEndoprotheseBasis.xsd>
attributeFormDefault:
elementFormDefault: **unqualified**
targetNamespace: **http://xml.ir-d.de/emg**

Complex types

[ArtikelEndoprotheseBasis](#)

schema location: <http://xml.ir-d.de/rst/schema/rfc/V5.0.0/Bausteine/ArtikelAortenklappeBasis.xsd>
attributeFormDefault:
elementFormDefault: **unqualified**
targetNamespace: **http://xml.ir-d.de/emg**

Complex types

[ArtikelAortenklappeBasis](#)

element GEMeldung

diagram	<p>Meldung einer implantatbezogenen Massnahme nach § 16 IRegG. Hier: Meldung/Korrektur der Gesundheitseinrichtung an die Registerstelle. Die Meldung muss wohlgeformt und im Sinne dieses Schemas gültig sein. ...</p>
namespace	http://xml.ir-d.de/rst
type	emg:GeMeldung
properties	content complex
children	meldung
annotation	documentation Meldung einer implantatbezogenen Massnahme nach § 16 IRegG. Hier: Meldung/Korrektur der Gesundheitseinrichtung an die Registerstelle. Die Meldung muss wohlgeformt und im Sinne dieses Schemas gültig sein.
source	<pre><element name="GEMeldung" type="emg:GeMeldung"> <annotation> <documentation>Meldung einer implantatbezogenen Massnahme nach § 16 IRegG. Hier: Meldung/Korrektur der Gesundheitseinrichtung an die Registerstelle. Die Meldung muss wohlgeformt und im Sinne dieses Schemas gültig sein. </documentation> </annotation> </element></pre>

element GESelbstauskunft

diagram	<p>Selbstauskunftersuchen an die Registerstelle.</p>
namespace	http://xml.ir-d.de/rst
type	sak:GeSelbstauskunft
properties	content complex
children	meldung
annotation	documentation Selbstauskunftersuchen an die Registerstelle.
source	<pre><element name="GESelbstauskunft" type="sak:GeSelbstauskunft"> <annotation> <documentation>Selbstauskunftersuchen an die Registerstelle.</documentation> </annotation> </element></pre>

```

</annotation>
</element>

```

element **GEStorno**

diagram	<p>Stornierung einer Meldung mit allen evtl. erfolgten Korrekturen der Gesundheitseinrichtung an die Registerstelle.</p>
namespace	http://xml.ir-d.de/rst
type	stn:GeStorno
properties	content complex
children	meldung
annotation	<p>documentation Stornierung einer Meldung mit allen evtl. erfolgten Korrekturen der Gesundheitseinrichtung an die Registerstelle.</p>
source	<pre> <element name="GEStorno" type="stn:GeStorno"> <annotation> <documentation>Stornierung einer Meldung mit allen evtl. erfolgten Korrekturen der Gesundheitseinrichtung an die Registerstelle.</documentation> </annotation> </element> </pre>

element **IRDMeldungAntwort**

diagram	<p>Antwort der Registerstelle auf eine Meldung/Korrektur der Gesundheitseinrichtung.</p>
namespace	http://xml.ir-d.de/rst
type	irdma:meldungAntwort
properties	content complex

children	meldung empfangsbestaetigung fehler warnung bestaetigung
annotation	documentation Antwort der Registerstelle auf eine Meldung/Korrektur der Gesundheitseinrichtung.
source	<pre><element name="IRDMeldungAntwort" type="irdma:meldungAntwort"> <annotation> <documentation>Antwort der Registerstelle auf eine Meldung/Korrektur der Gesundheitseinrichtung.</documentation> </annotation> </element></pre>

element IRDSelbstauskunftAntwort

diagram	
namespace	http://xml.ir-d.de/rst
type	irdsaa:selbstauskunftAntwort
properties	content complex
children	meldung empfangsbestaetigung
annotation	documentation Antwort der Registerstelle auf ein Selbstauskunftersuchen der Gesundheitseinrichtung.
source	<pre><element name="IRDSelbstauskunftAntwort" type="irdsaa:selbstauskunftAntwort"> <annotation> <documentation>Antwort der Registerstelle auf ein Selbstauskunftersuchen der Gesundheitseinrichtung.</documentation> </annotation> </element></pre>

element IRDStornoAntwort

diagram	
namespace	http://xml.ir-d.de/rst
type	irdsa:stornoAntwort

properties	content complex
children	meldung empfangsbestaetigung fehler
annotation	documentation Antwort der Registerstelle auf ein Storno einer Meldung mit allen evtl. erfolgten Korrekturen der Gesundheitseinrichtung.
source	<pre> <element name="IRDStornoAntwort" type="irdsa:stornoAntwort"> <annotation> <documentation>Antwort der Registerstelle auf ein Storno einer Meldung mit allen evtl. erfolgten Korrekturen der Gesundheitseinrichtung.</documentation> </annotation> </element> </pre>

complexType **GeMeldung**

diagram	<pre> classDiagram class GeMeldung { +meldung emg:Meldung } </pre>
namespace	http://xml.ir-d.de/emg
children	meldung
used by	element GEMeldung
source	<pre> <complexType name="GeMeldung"> <sequence> <element name="meldung" type="emg:Meldung"/> </sequence> </complexType> </pre>

element **GeMeldung/meldung**

diagram	
type	Meldung
properties	content complex
children	MEL_IrdIdGesundheitseinrichtung MEL_StandortId MEL_Bsnr MEL_IrdSpezVersion MEL_SwName MEL_SwHersteller MEL_SwVersion fall
source	<code><element name="meldung" type="emg:Meldung"/></code>

complexType **GeStorno**

diagram	
namespace	http://xml.ir-d.de/stn
children	meldung
used by	element GEstorno
source	<pre><complexType name="GeStorno"> <sequence> <element name="meldung" type="stn:Storno"/> </sequence></pre>

```
</complexType>
```

element **GeStorno/meldung**

diagram	
type	Storno
properties	content complex
children	MEL_IrdIdGesundheitseinrichtung fall
source	<pre><element name="meldung" type="stn:Storno"/></pre>

complexType **meldungAntwort**

diagram	
namespace	http://xml.ir-d.de/irdma
children	meldung empfangsbestaetigung fehler warnung bestaetigung
used by	element IRDMeldungAntwort
source	<pre><complexType name="meldungAntwort"> <sequence> <element name="meldung" type="irdma:MeldungIrd"/> <element name="empfangsbestaetigung" type="irdma:EmpfangsbestaetigungBasis"/> <choice> <element name="fehler" type="irdma:HinweisBasis" maxOccurs="unbounded"/> <element name="warnung" type="irdma:Warnung"/> <element name="bestaetigung" type="irdma:BestaetigungBasis"/> </choice> </sequence> </complexType></pre>

```

</sequence>
</complexType>

```

element meldungAntwort/meldung

diagram	<p>The diagram illustrates the 'meldung' element structure. It is a complex content type of type 'irdma:MeldungIrd'. It contains two child elements: 'MEL_IrdIdGesundheitseinrichtung' (type 'IdEinrichtung', pattern '(IRD-GE-[0-9]{8})') and 'fall' (type 'MeldungIrdFallBasis').</p>
type	MeldungIrd
properties	content complex
children	MEL_IrdIdGesundheitseinrichtung fall
source	<code><element name="meldung" type="irdma:MeldungIrd"/></code>

element meldungAntwort/empfangsbestaetigung

diagram	<p>The diagram illustrates the 'empfangsbestaetigung' element structure. It is a complex content type of type 'irdma:EmpfangsbestaetigungBasis'. It contains two child elements: 'EBG_Empfangsbestaetigung' (type 'Freitext250', fixed 'Hiermit wird der Einga...', min/maxLen 250) and 'EBG_DatumZeitEmpfang' (type 'xs:dateTime').</p>
type	EmpfangsbestaetigungBasis
properties	content complex
children	EBG_Empfangsbestaetigung EBG_DatumZeitEmpfang
source	<code><element name="empfangsbestaetigung" type="irdma:EmpfangsbestaetigungBasis"/></code>

element **meldungAntwort/fehler**

diagram	
type	HinweisBasis
properties	minOcc 1 maxOcc unbounded content complex
children	HNW Datenelement HNW Meldung HNW Wert
source	<code><element name="fehler" type="irdma:HinweisBasis" maxOccurs="unbounded"/></code>

element **meldungAntwort/warnung**

diagram	
type	Warnung
properties	content complex
children	bestaetigung hinweis
source	<code><element name="warnung" type="irdma:Warnung"/></code>

element **meldungAntwort/bestaetigung**

diagram	
type	BestaetigungBasis
properties	content complex
children	BEG Meldebestaetigung ID BEG DatumZeitMeldebestaetigung BEG AusloesendeOpsListe BEG Produktzuordnung BEG Hash String BEG Hash Wert
source	<code><element name="bestaetigung" type="irdma:BestaetigungBasis"/></code>

complexType **stornoAntwort**

diagram	
namespace	http://xml.ir-d.de/irdsa
children	meldung empfangsbestaetigung fehler
used by	element IRDStornoAntwort
source	<pre> <complexType name="stornoAntwort"> <sequence> <element name="meldung" type="irdsa:Storno"/> <element name="empfangsbestaetigung" type="irdsa:EmpfangsbestaetigungBasis"/> <element name="fehler" type="irdsa:HinweisBasis" minOccurs="0" </pre>

```

maxOccurs="unbounded"/>
</sequence>
</complexType>

```

element **stornoAntwort/meldung**

diagram	
type	Storno
properties	content complex
children	MEL_IrdIdGesundheitseinrichtung fall
source	<code><element name="meldung" type="irdsa:Storno"/></code>

element **stornoAntwort/empfangsbestaetigung**

diagram	
type	EmpfangsbestaetigungBasis
properties	content complex
children	EBG_Empfangsbestaetigung EBG_DatumZeitEmpfang
source	<code><element name="empfangsbestaetigung" type="irdsa:EmpfangsbestaetigungBasis"/></code>

element **stornoAntwort/fehler**

diagram	
type	HinweisBasis
properties	minOcc 0 maxOcc unbounded content complex
children	HNW Datenelement HNW Meldung HNW Wert
source	<code><element name="fehler" type="irdsa:HinweisBasis" minOccurs="0" maxOccurs="unbounded"/></code>

complexType **GeSelbstauskunft**

diagram	
namespace	http://xml.ir-d.de/sak
children	meldung
used by	element GESelbstauskunft
source	<pre><complexType name="GeSelbstauskunft"> <sequence> <element name="meldung" type="sak:Selbstauskunft"/> </sequence> </complexType></pre>

element **GeSelbstauskunft/meldung**

diagram	
type	Selbstauskunft

properties	content complex
children	MEL_IrdIdGesundheitseinrichtung fall
source	<code><element name="meldung" type="sak:Selbstauskunft"/></code>

complexType **selbstauskunftAntwort**

diagram	
namespace	http://xml.ir-d.de/irdsaa
children	meldung empfangsbestaetigung
used by	element IRDSelbstauskunftAntwort
source	<pre> <complexType name="selbstauskunftAntwort"> <sequence> <element name="meldung" type="irdsaa:Selbstauskunft"/> <element name="empfangsbestaetigung" type="irdsaa:EmpfangsbestaetigungBasis"/> </sequence> </complexType> </pre>

element **selbstauskunftAntwort/meldung**

diagram	
type	Selbstauskunft
properties	content complex
children	MEL_IrdIdGesundheitseinrichtung fall
source	<code><element name="meldung" type="irdsaa:Selbstauskunft"/></code>

element **selbstauskunftAntwort/empfangsbestaetigung**

diagram	
type	EmpfangsbestaetigungBasis
properties	content complex
children	EBG Empfangsbestaetigung EBG DatumZeitEmpfang
source	<code><element name="empfangsbestaetigung" type="irdsaa:EmpfangsbestaetigungBasis"/></code>

complexType **Meldung**

diagram	
namespace	http://xml.ir-d.de/emg

type	extension of MeldungBasis
properties	base MeldungBasis
children	MEL IrdIdGesundheitseinrichtung MEL StandortId MEL Bsnr MEL IrdSpezVersion MEL SwName MEL SwHersteller MEL SwVersion fall
used by	element GeMeldung/meldung
source	<pre> <complexType name="Meldung"> <complexContent> <extension base="MeldungBasis"> <sequence> <element name="fall" type="Fall"/> </sequence> </extension> </complexContent> </complexType> </pre>

element **Meldung/fall**

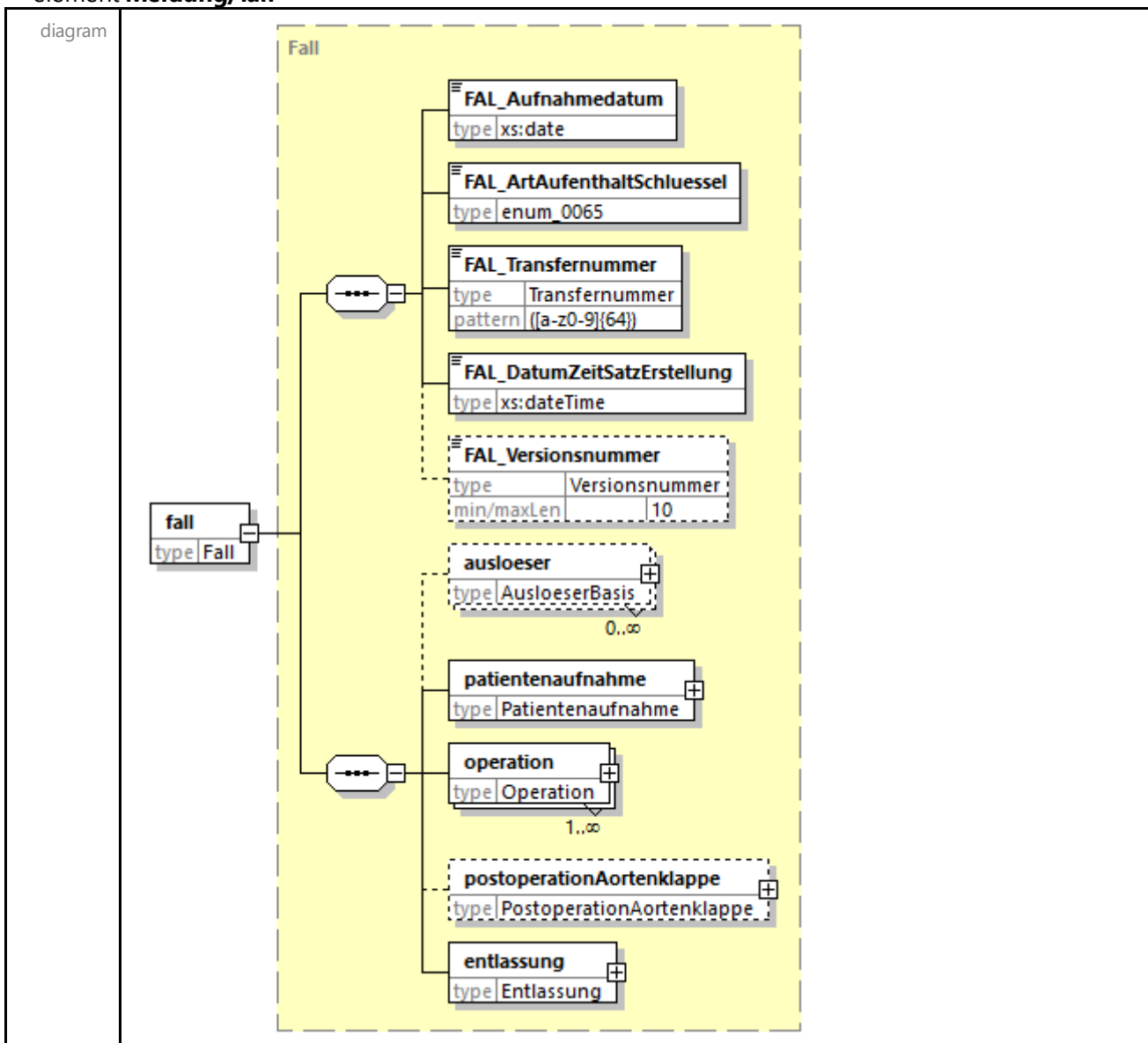

type	Fall
properties	content complex
children	FAL_Aufnahmedatum FAL_ArtAufenthaltSchluessel FAL_Transfernummer FAL_DatumZeitSatzErstellung FAL_Versionsnummer ausloeser patientenaufnahme operation postoperationAortenklappe entlassung
source	<code><element name="fall" type="Fall"/></code>

complexType **Storno**

diagram	
namespace	http://xml.ir-d.de/stn
type	extension of MeldungIrdBasis
properties	base MeldungIrdBasis
children	MEL_IrdIdGesundheitseinrichtung fall
used by	element GeStorno/meldung
source	<pre> <complexType name="Storno"> <complexContent> <extension base="MeldungIrdBasis"> <sequence> <element name="fall" type="StornoFallBasis"/> </sequence> </extension> </complexContent> </complexType> </pre>

element **Storno/fall**

diagram	
type	StornoFallBasis
properties	content complex
children	FAL_Transfernummer FAL_Aufnahmedatum

source	<code><element name="fall" type="StornoFallBasis"/></code>
--------	--

complexType MeldungIrd

diagram	
namespace	http://xml.ir-d.de/irdma
type	extension of MeldungIrdBasis
properties	base MeldungIrdBasis
children	MEL_IrdIdGesundheitseinrichtung fall
used by	element meldungAntwort/meldung
source	<pre> <complexType name="MeldungIrd"> <complexContent> <extension base="MeldungIrdBasis"> <sequence> <element name="fall" type="MeldungIrdFallBasis"/> </sequence> </extension> </complexContent> </complexType> </pre>

element MeldungIrd/fall

diagram	
type	MeldungIrdFallBasis
properties	content complex
children	FAL Transfernummer FAL DatumZeitSatzErstellung
source	<code><element name="fall" type="MeldungIrdFallBasis"/></code>

complexType **EmpfangsbestaetigungBasis**

diagram	
namespace	http://xml.ir-d.de/irdma
children	EBG Empfangsbestaetigung EBG DatumZeitEmpfang
used by	element meldungAntwort/empfangsbestaetigung
source	<pre><complexType name="EmpfangsbestaetigungBasis"> <sequence> <element name="EBG_Empfangsbestaetigung" type="Freitext250" fixed="Hiermit wird der Eingang Ihrer Anfrage bestätigt"/> <element name="EBG_DatumZeitEmpfang" type="xs:dateTime"/> </sequence> </complexType></pre>

element **EmpfangsbestaetigungBasis/EBG_Empfangsbestaetigung**

diagram							
type	Freitext250						
properties	content simple fixed Hiermit wird der Eingang Ihrer Anfrage bestätigt						
facets	<table border="1"> <thead> <tr> <th>Kind</th> <th>Value</th> <th>Annotation</th> </tr> </thead> <tbody> <tr> <td>maxLength</td> <td>250</td> <td></td> </tr> </tbody> </table>	Kind	Value	Annotation	maxLength	250	
Kind	Value	Annotation					
maxLength	250						
source	<pre><element name="EBG_Empfangsbestaetigung" type="Freitext250" fixed="Hiermit wird der Eingang Ihrer Anfrage bestätigt"/></pre>						

element **EmpfangsbestaetigungBasis/EBG_DatumZeitEmpfang**

diagram	
type	dateTime
properties	content simple
source	<pre><element name="EBG_DatumZeitEmpfang" type="xs:dateTime"/></pre>

complexType **HinweisBasis**

diagram	
namespace	http://xml.ir-d.de/irdma
children	HNW_Datenelement HNW Meldung HNW Wert
used by	elements meldungAntwort/fehler Warnung/hinweis
source	<pre><complexType name="HinweisBasis"> <sequence> <element name="HNW_Datenelement" type="Freitext500"/> <element name="HNW_Meldung" type="Freitext500"/> <element name="HNW_Wert" type="Freitext500"/> </sequence> </complexType></pre>

element **HinweisBasis/HNW_Datenelement**

diagram							
type	Freitext500						
properties	content simple						
facets	<table border="1"> <thead> <tr> <th>Kind</th> <th>Value</th> <th>Annotation</th> </tr> </thead> <tbody> <tr> <td>maxLength</td> <td>500</td> <td></td> </tr> </tbody> </table>	Kind	Value	Annotation	maxLength	500	
Kind	Value	Annotation					
maxLength	500						
source	<pre><element name="HNW_Datenelement" type="Freitext500"/></pre>						

element **HinweisBasis/HNW_Meldung**

diagram							
type	Freitext500						
properties	content simple						
facets	<table border="1"> <thead> <tr> <th>Kind</th> <th>Value</th> <th>Annotation</th> </tr> </thead> <tbody> <tr> <td>maxLength</td> <td>500</td> <td></td> </tr> </tbody> </table>	Kind	Value	Annotation	maxLength	500	
Kind	Value	Annotation					
maxLength	500						
source	<pre><element name="HNW_Meldung" type="Freitext500"/></pre>						

element **HinweisBasis/HNW_Wert**

diagram							
type	Freitext500						
properties	content simple						
facets	<table border="1"> <thead> <tr> <th>Kind</th> <th>Value</th> <th>Annotation</th> </tr> </thead> <tbody> <tr> <td>maxLength</td> <td>500</td> <td></td> </tr> </tbody> </table>	Kind	Value	Annotation	maxLength	500	
Kind	Value	Annotation					
maxLength	500						
source	<code><element name="HNW_Wert" type="Freitext500"/></code>						

complexType **Warnung**

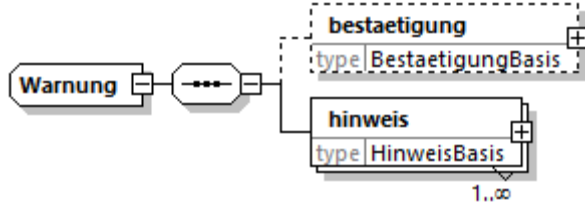
diagram	
namespace	http://xml.ir-d.de/irdma
children	bestaetigung hinweis
used by	element meldungAntwort/warnung
source	<pre> <complexType name="Warnung"> <sequence> <element name="bestaetigung" type="BestaetigungBasis" minOccurs="0"/> <element name="hinweis" type="HinweisBasis" maxOccurs="unbounded"/> </sequence> </complexType> </pre>

element **Warnung/bestaetigung**

diagram	
type	BestaetigungBasis
properties	minOcc 0 maxOcc 1 content complex
children	BEG Meldebestaetigung ID BEG DatumZeitMeldebestaetigung BEG AusloesendeOpsListe BEG Produktzuordnung BEG Hash String BEG Hash Wert
source	<code><element name="bestaetigung" type="BestaetigungBasis" minOccurs="0"/></code>

element **Warnung/hinweis**

diagram	
type	HinweisBasis
properties	minOcc 1 maxOcc unbounded content complex

children	HNW Datenelement HNW Meldung HNW Wert
source	<code><element name="hinweis" type="HinweisBasis" maxOccurs="unbounded"/></code>

complexType **BestaetigungBasis**

diagram	
namespace	http://xml.ir-d.de/irdma
children	BEG Meldebestaetigung ID BEG DatumZeitMeldebestaetigung BEG AusloesendeOpsListe BEG Produktzuordnung BEG Hash String BEG Hash Wert
used by	elements meldungAntwort/bestaetigung Warnung/bestaetigung
source	<pre> <complexType name="BestaetigungBasis"> <sequence> <element name="BEG_Meldebestaetigung_ID" type="Meldebestaetigung"/> <element name="BEG_DatumZeitMeldebestaetigung" type="xs:dateTime"/> <element name="BEG_AusloesendeOpsListe" type="Freitext250" minOccurs="0"/> <element name="BEG_Produktzuordnung" type="xs:boolean"/> <element name="BEG_Hash_String" type="HashString"/> <element name="BEG_Hash_Wert" type="HashWert"/> </sequence> </complexType> </pre>

element **BestaetigungBasis/BEG_Meldebestaetigung_ID**

diagram	
type	Meldebestaetigung
properties	content simple

facets	Kind Value Annotation length 10
source	<code><element name="BEG_Meldebestaetigung_ID" type="Meldebestaetigung"/></code>

element **BestaetigungBasis/BEG_DatumZeitMeldebestaetigung**

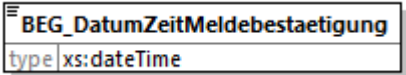
diagram	
type	dateTime
properties	content simple
source	<code><element name="BEG_DatumZeitMeldebestaetigung" type="xs:dateTime"/></code>

element **BestaetigungBasis/BEG_AusloesendeOpsListe**

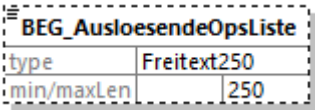
diagram	
type	Freitext250
properties	minOcc 0 maxOcc 1 content simple
facets	Kind Value Annotation maxLength 250
source	<code><element name="BEG_AusloesendeOpsListe" type="Freitext250" minOccurs="0"/></code>

element **BestaetigungBasis/BEG_Produktzuordnung**

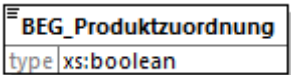
diagram	
type	boolean
properties	content simple
source	<code><element name="BEG_Produktzuordnung" type="xs:boolean"/></code>

element **BestaetigungBasis/BEG_Hash_String**

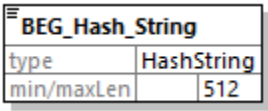
diagram	
type	HashString
properties	content simple
facets	Kind Value Annotation maxLength 512

source	<code><element name="BEG_Hash_String" type="HashString"/></code>
--------	--

element **BestaetigungBasis/BEG_Hash_Wert**

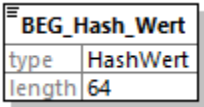
diagram	
type	HashWert
properties	content simple
facets	Kind Value Annotation length 64
source	<code><element name="BEG_Hash_Wert" type="HashWert"/></code>

complexType **Storno**

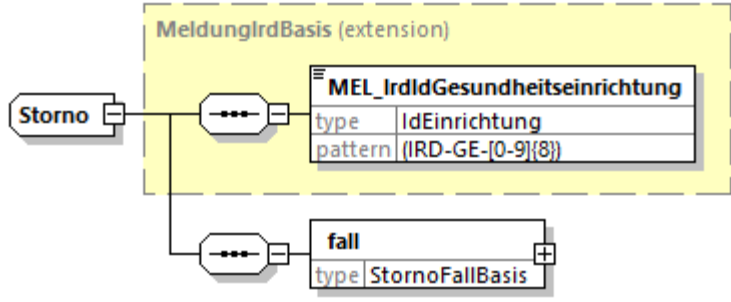
diagram	
namespace	http://xml.ir-d.de/irdsa
type	extension of MeldungIrdBasis
properties	base MeldungIrdBasis
children	MEL_IrdIdGesundheitseinrichtung fall
used by	element stornoAntwort/meldung
source	<pre> <complexType name="Storno"> <complexContent> <extension base="MeldungIrdBasis"> <sequence> <element name="fall" type="StornoFallBasis"/> </sequence> </extension> </complexContent> </complexType> </pre>

element **Storno/fall**

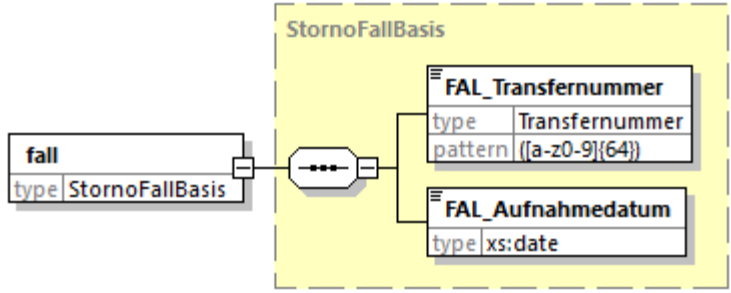
diagram	
type	StornoFallBasis
properties	content complex
children	FAL Transfernummer FAL Aufnahmedatum
source	<code><element name="fall" type="StornoFallBasis"/></code>

complexType **EmpfangsbestaetigungBasis**

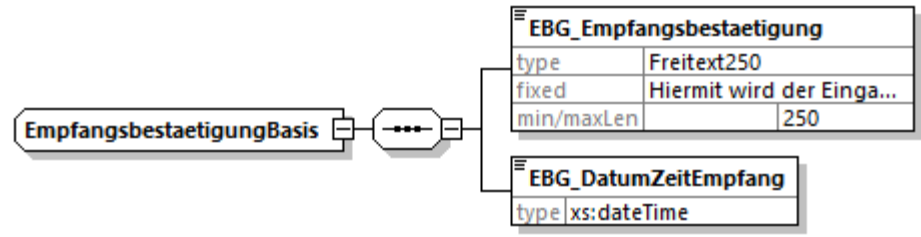
diagram	
namespace	http://xml.ir-d.de/irdsa
children	EBG Empfangsbestaetigung EBG DatumZeitEmpfang
used by	element stornoAntwort/empfangsbestaetigung
source	<pre> <complexType name="EmpfangsbestaetigungBasis"> <sequence> <element name="EBG_Empfangsbestaetigung" type="Freitext250" fixed="Hiermit wird der Eingang Ihrer Anfrage bestätigt"/> <element name="EBG_DatumZeitEmpfang" type="xs:dateTime"/> </sequence> </complexType> </pre>

element **EmpfangsbestaetigungBasis/EBG_Empfangsbestaetigung**

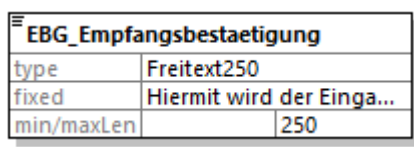
diagram							
type	Freitext250						
properties	content simple fixed Hiermit wird der Eingang Ihrer Anfrage bestätigt						
facets	<table border="1"> <thead> <tr> <th>Kind</th> <th>Value</th> <th>Annotation</th> </tr> </thead> <tbody> <tr> <td>maxLength</td> <td>250</td> <td></td> </tr> </tbody> </table>	Kind	Value	Annotation	maxLength	250	
Kind	Value	Annotation					
maxLength	250						
source	<code><element name="EBG_Empfangsbestaetigung" type="Freitext250" fixed="Hiermit</code>						

wird der Eingang Ihrer Anfrage bestätigt"/>

element **EmpfangsbestaetigungBasis/EBG_DatumZeitEmpfang**

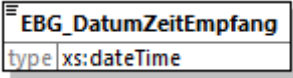
diagram	
type	dateTime
properties	content simple
source	<code><element name="EBG_DatumZeitEmpfang" type="xs:dateTime"/></code>

complexType **HinweisBasis**

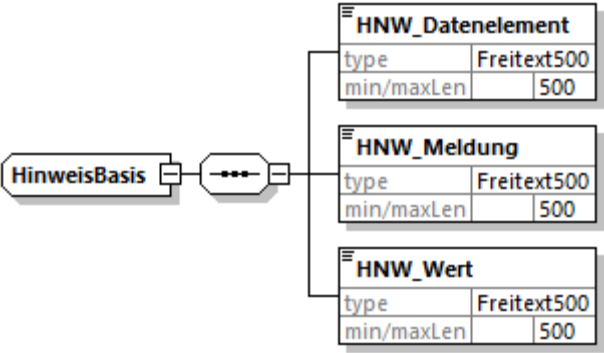
diagram	
namespace	http://xml.ir-d.de/irdsa
children	HNW_Datenelement HNW_Meldung HNW_Wert
used by	element stornoAntwort/fehler
source	<pre><complexType name="HinweisBasis"> <sequence> <element name="HNW_Datenelement" type="Freitext500"/> <element name="HNW_Meldung" type="Freitext500"/> <element name="HNW_Wert" type="Freitext500"/> </sequence> </complexType></pre>

element **HinweisBasis/HNW_Datenelement**

diagram							
type	Freitext500						
properties	content simple						
facets	<table border="1"> <thead> <tr> <th>Kind</th> <th>Value</th> <th>Annotation</th> </tr> </thead> <tbody> <tr> <td>maxLength</td> <td>500</td> <td></td> </tr> </tbody> </table>	Kind	Value	Annotation	maxLength	500	
Kind	Value	Annotation					
maxLength	500						
source	<code><element name="HNW_Datenelement" type="Freitext500"/></code>						

element HinweisBasis/HNW_Meldung

diagram							
type	Freitext500						
properties	content simple						
facets	<table border="1"> <thead> <tr> <th>Kind</th> <th>Value</th> <th>Annotation</th> </tr> </thead> <tbody> <tr> <td>maxLength</td> <td>500</td> <td></td> </tr> </tbody> </table>	Kind	Value	Annotation	maxLength	500	
Kind	Value	Annotation					
maxLength	500						
source	<code><element name="HNW_Meldung" type="Freitext500"/></code>						

element HinweisBasis/HNW_Wert

diagram							
type	Freitext500						
properties	content simple						
facets	<table border="1"> <thead> <tr> <th>Kind</th> <th>Value</th> <th>Annotation</th> </tr> </thead> <tbody> <tr> <td>maxLength</td> <td>500</td> <td></td> </tr> </tbody> </table>	Kind	Value	Annotation	maxLength	500	
Kind	Value	Annotation					
maxLength	500						
source	<code><element name="HNW_Wert" type="Freitext500"/></code>						

complexType Selbstauskunft

diagram	
namespace	http://xml.ir-d.de/sak
type	extension of MeldungIrdBasis
properties	base MeldungIrdBasis
children	MEL_IrdIdGesundheitseinrichtung fall
used by	element GeSelbstauskunft/meldung
source	<pre> <complexType name="Selbstauskunft"> <complexContent> <extension base="MeldungIrdBasis"> <sequence> <element name="fall" type="SelbstauskunftFallBasis"/> </sequence> </extension> </complexContent> </complexType> </pre>

```

</complexContent>
</complexType>

```

element **Selbstauskunft/fall**

diagram	
type	SelbstauskunftFallBasis
properties	content complex
children	FAL_Transfernummer
source	<code><element name="fall" type="SelbstauskunftFallBasis"/></code>

complexType **Selbstauskunft**

diagram	
namespace	http://xml.ir-d.de/irdsaa
type	extension of MeldungIrdBasis
properties	base MeldungIrdBasis
children	MEL_IrdIdGesundheitseinrichtung fall
used by	element selbstauskunftAntwort/meldung
source	<pre> <complexType name="Selbstauskunft"> <complexContent> <extension base="MeldungIrdBasis"> <sequence> <element name="fall" type="SelbstauskunftFallBasis"/> </sequence> </extension> </complexContent> </complexType> </pre>

element **Selbstauskunft/fall**

diagram	
type	SelbstauskunftFallBasis
properties	content complex
children	FAL_Transfernummer
source	<code><element name="fall" type="SelbstauskunftFallBasis"/></code>

complexType **EmpfangsbestaetigungBasis**

diagram	
namespace	http://xml.ir-d.de/irdsaa
children	EBG_Empfangsbestaetigung EBG_DatumZeitEmpfang
used by	element selbstauskunftAntwort/empfangsbestaetigung
source	<pre> <complexType name="EmpfangsbestaetigungBasis"> <sequence> <element name="EBG_Empfangsbestaetigung" type="Freitext250" fixed="Hiermit wird der Eingang Ihrer Anfrage bestätigt"/> <element name="EBG_DatumZeitEmpfang" type="xs:dateTime"/> </sequence> </complexType> </pre>

element **EmpfangsbestaetigungBasis/EBG_Empfangsbestaetigung**

diagram							
type	Freitext250						
properties	content simple fixed Hiermit wird der Eingang Ihrer Anfrage bestätigt						
facets	<table border="1"> <thead> <tr> <th>Kind</th> <th>Value</th> <th>Annotation</th> </tr> </thead> <tbody> <tr> <td>maxLength</td> <td>250</td> <td></td> </tr> </tbody> </table>	Kind	Value	Annotation	maxLength	250	
Kind	Value	Annotation					
maxLength	250						
source	<code><element name="EBG_Empfangsbestaetigung" type="Freitext250" fixed="Hiermit wird der Eingang Ihrer Anfrage bestätigt"/></code>						

element **EmpfangsbestaetigungBasis/EBG_DatumZeitEmpfang**

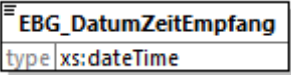
diagram	
type	dateTime
properties	content simple
source	<code><element name="EBG_DatumZeitEmpfang" type="xs:dateTime"/></code>

complexType **MeldungBasis**

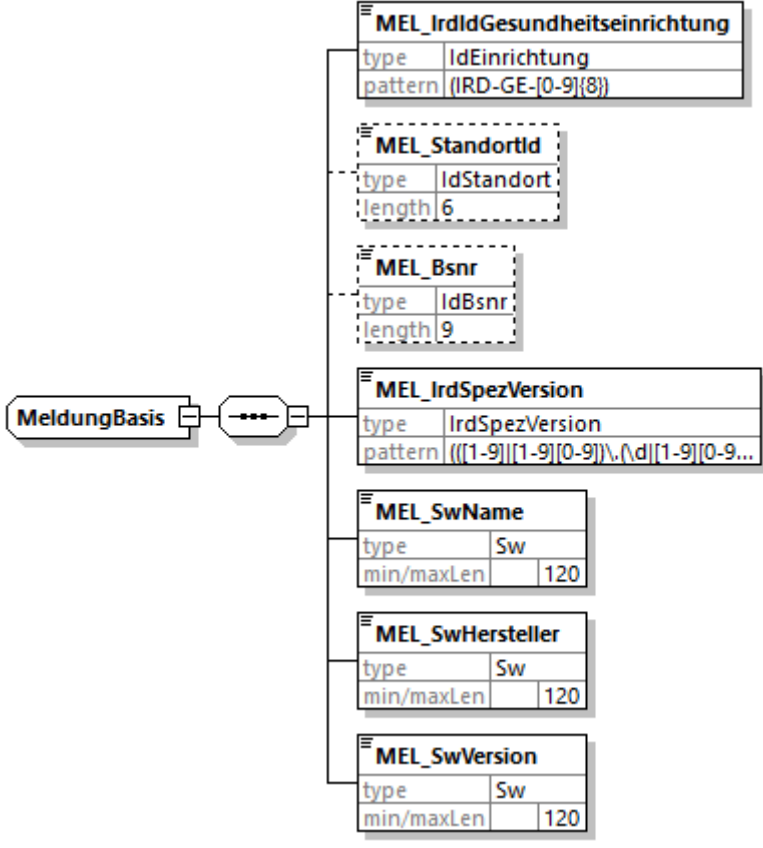
diagram	
namespace	http://xml.ir-d.de/emg
children	MEL_IrdIdGesundheitseinrichtung MEL_StandortId MEL_Bsnr MEL_IrdSpezVersion MEL_SwName MEL_SwHersteller MEL_SwVersion
used by	complexType Meldung
source	<pre> <complexType name="MeldungBasis"> <sequence> <element name="MEL_IrdIdGesundheitseinrichtung" type="IdEinrichtung"/> <element name="MEL_StandortId" type="IdStandort" minOccurs="0"/> <element name="MEL_Bsnr" type="IdBsnr" minOccurs="0"/> <element name="MEL_IrdSpezVersion" type="IrdSpezVersion"/> <element name="MEL_SwName" type="Sw"/> <element name="MEL_SwHersteller" type="Sw"/> <element name="MEL_SwVersion" type="Sw"/> </sequence> </pre>

	<code></complexType></code>
--	-----------------------------------

element **MeldungBasis/MEL_IrdIdGesundheitseinrichtung**

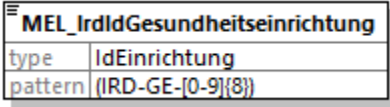
diagram							
type	IdEinrichtung						
properties	content simple						
facets	<table border="1"><thead><tr><th>Kind</th><th>Value</th><th>Annotation</th></tr></thead><tbody><tr><td>pattern</td><td>(IRD-GE-[0-9]{8})</td><td></td></tr></tbody></table>	Kind	Value	Annotation	pattern	(IRD-GE-[0-9]{8})	
Kind	Value	Annotation					
pattern	(IRD-GE-[0-9]{8})						
source	<code><element name="MEL_IrdIdGesundheitseinrichtung" type="IdEinrichtung"/></code>						

element **MeldungBasis/MEL_StandortId**

diagram							
type	IdStandort						
properties	minOcc 0 maxOcc 1 content simple						
facets	<table border="1"><thead><tr><th>Kind</th><th>Value</th><th>Annotation</th></tr></thead><tbody><tr><td>length</td><td>6</td><td></td></tr></tbody></table>	Kind	Value	Annotation	length	6	
Kind	Value	Annotation					
length	6						
source	<code><element name="MEL_StandortId" type="IdStandort" minOccurs="0"/></code>						

element **MeldungBasis/MEL_Bsnr**

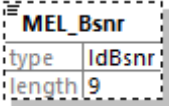
diagram							
type	IdBsnr						
properties	minOcc 0 maxOcc 1 content simple						
facets	<table border="1"><thead><tr><th>Kind</th><th>Value</th><th>Annotation</th></tr></thead><tbody><tr><td>length</td><td>9</td><td></td></tr></tbody></table>	Kind	Value	Annotation	length	9	
Kind	Value	Annotation					
length	9						
source	<code><element name="MEL_Bsnr" type="IdBsnr" minOccurs="0"/></code>						

element **MeldungBasis/MEL_IrdSpezVersion**

diagram	
type	IrdSpezVersion

properties	content simple
facets	Kind Value Annotation pattern (([1-9] [1-9][0-9])\.\d{1-9}[0-9])\.\d{1-9}[0-9])
source	<code><element name="MEL_IrdSpezVersion" type="IrdSpezVersion"/></code>

element MeldungBasis/MEL_SwName

diagram	
type	Sw
properties	content simple
facets	Kind Value Annotation maxLength 120
source	<code><element name="MEL_SwName" type="Sw"/></code>

element MeldungBasis/MEL_SwHersteller

diagram	
type	Sw
properties	content simple
facets	Kind Value Annotation maxLength 120
source	<code><element name="MEL_SwHersteller" type="Sw"/></code>

element MeldungBasis/MEL_SwVersion

diagram	
type	Sw
properties	content simple
facets	Kind Value Annotation maxLength 120
source	<code><element name="MEL_SwVersion" type="Sw"/></code>

complexType **Fall**

<p>diagram</p>	
<p>namespace</p>	<p>http://xml.ir-d.de/emg</p>
<p>type</p>	<p>extension of FallBasis</p>
<p>properties</p>	<p>base FallBasis</p>
<p>children</p>	<p>FAL Aufnahmedatum FAL ArtAufenthaltSchluessel FAL Transfernummer FAL DatumZeitSatzErstellung FAL Versionsnummer ausloeser patientenaufnahme operation postoperationAortenklappe entlassung</p>
<p>used by</p>	<p>element Meldung/fall</p>
<p>source</p>	<pre> <complexType name="Fall"> <complexContent> <extension base="FallBasis"> <sequence> <element name="ausloeser" type="AusloeserBasis" minOccurs="0" maxOccurs="unbounded"/> <element name="patientenaufnahme" type="Patientenaufnahme"/> <element name="operation" type="Operation" maxOccurs="unbounded"/> <element name="postoperationAortenklappe" type="PostoperationAortenklappe" minOccurs="0"/> <element name="entlassung" type="Entlassung"/> </sequence> </extension> </complexContent> </complexType> </pre>

```

</sequence>
</extension>
</complexContent>
</complexType>

```

element Fall/ausloeser

diagram	
type	AusloeserBasis
properties	minOcc 0 maxOcc unbounded content complex
children	ALR_ProzedurenSchluessel
source	<code><element name="ausloeser" type="AusloeserBasis" minOccurs="0" maxOccurs="unbounded"/></code>

element Fall/patientenaufnahme

diagram	
type	Patientenaufnahme
properties	content complex
children	PAT Alter PAT Groesse PAT Gewicht PAT GeschlechtSchluessel patientenaufnahmeBrustimplantat patientenaufnahmeKardiologie
source	<code><element name="patientenaufnahme" type="Patientenaufnahme"/></code>

element **Fall/operation**

<p>diagram</p>	
<p>type</p>	<p>Operation</p>
<p>properties</p>	<p>minOcc 1 maxOcc unbounded content complex</p>
<p>children</p>	<p>OPE LaufendeNummer OPE Datum OPE SeitenLokalisationSchluessel OPE AsaSchluessel OPE ImplantattypSchluessel operationBrustimplantat operationEndoprothese operationAortenklappe artikelidentifikation zubehoer</p>
<p>source</p>	<pre><element name="operation" type="Operation" maxOccurs="unbounded"/></pre>

element Fall/postoperationAortenklappe

diagram

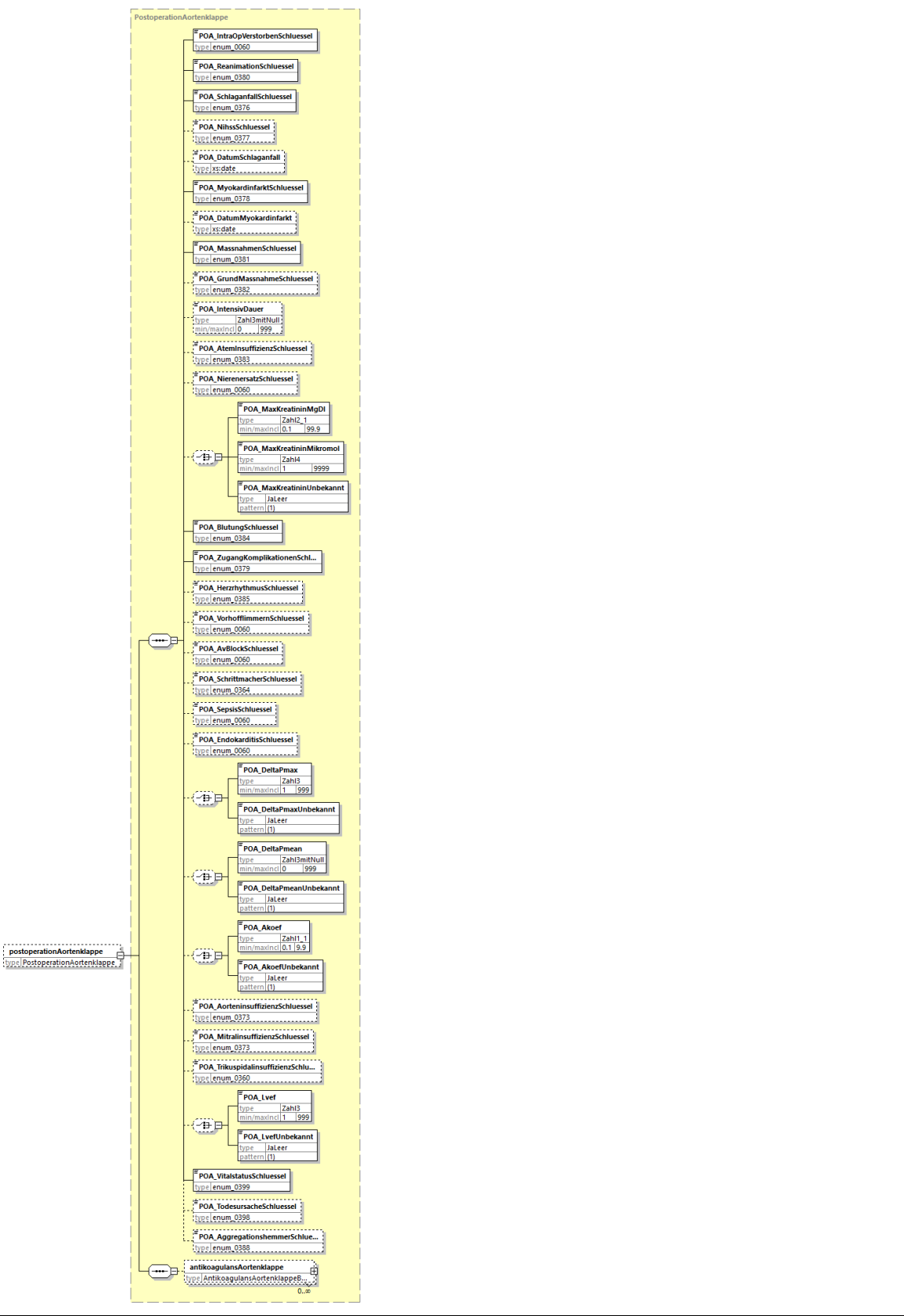

type [PostoperationAortenklappe](#)

properties
 minOcc 0
 maxOcc 1
 content complex

children	POA IntraOpVerstorbenSchluessel POA ReanimationSchluessel POA SchlaganfallSchluessel POA NihssSchluessel POA DatumSchlaganfall POA MyokardinfarktSchluessel POA DatumMyokardinfarkt POA MassnahmenSchluessel POA GrundMassnahmeSchluessel POA IntensivDauer POA AtemInsuffizienzSchluessel POA NierenersatzSchluessel POA MaxKreatininMgDI POA MaxKreatininMikromol POA MaxKreatininUnbekannt POA BlutungSchluessel POA ZugangKomplikationenSchluessel POA HerzrhythmusSchluessel POA VorhofflimmernSchluessel POA AvBlockSchluessel POA SchrittmacherSchluessel POA SepsisSchluessel POA EndokarditisSchluessel POA DeltaPmax POA DeltaPmaxUnbekannt POA DeltaPmean POA DeltaPmeanUnbekannt POA Akoef POA AkoefUnbekannt POA AorteninsuffizienzSchluessel POA MitralinsuffizienzSchluessel POA TrikuspidalinsuffizienzSchluessel POA Lvef POA LvefUnbekannt POA VitalstatusSchluessel POA TodesursacheSchluessel POA AggregationshemmerSchluessel antikoagulansAortenklappe
source	<pre><element name="postoperationAortenklappe" type="PostoperationAortenklappe" minOccurs="0"/></pre>

element **Fall/entlassung**

diagram	
type	Entlassung
properties	content complex
children	ENT_Datum ENT_GrundSchluessel diagnoseBrustimplantat diagnoseEndoprothese diagnoseAortenklappe
source	<pre><element name="entlassung" type="Entlassung"/></pre>

simpleType **DatumText**

namespace	http://xml.ir-d.de/stn						
type	restriction of string						
properties	base xs:string						
facets	<table border="0"> <tr> <td>Kind</td> <td>Value</td> <td>Annotation</td> </tr> <tr> <td>pattern</td> <td>((([0-9]{4})([0-9]{2})?([0-9]{2})?)?)</td> <td></td> </tr> </table>	Kind	Value	Annotation	pattern	((([0-9]{4})([0-9]{2})?([0-9]{2})?)?)	
Kind	Value	Annotation					
pattern	((([0-9]{4})([0-9]{2})?([0-9]{2})?)?)						
annotation	documentation Facette zur Festlegung des freien Datumformats: JJJJ[-MM][-TT]						

source	<pre> <simpleType name="DatumText"> <annotation> <documentation>Facette zur Festlegung des freien Datumformats: JJJJ[-MM[- TT]]</documentation> </annotation> <restriction base="xs:string"> <pattern value="((([0-9]{4})([-][0-9]{2})?([-][0-9]{2})?)"/> </restriction> </simpleType> </pre>
--------	---

simpleType **Freitext250**

namespace	http://xml.ir-d.de/stn						
type	restriction of string						
properties	base xs:string						
facets	<table border="1"> <thead> <tr> <th>Kind</th> <th>Value</th> <th>Annotation</th> </tr> </thead> <tbody> <tr> <td>maxLength</td> <td>250</td> <td></td> </tr> </tbody> </table>	Kind	Value	Annotation	maxLength	250	
Kind	Value	Annotation					
maxLength	250						
annotation	documentation Facette zur Festlegung des Freitextes von 250 Zeichen						
source	<pre> <simpleType name="Freitext250"> <annotation> <documentation>Facette zur Festlegung des Freitextes von 250 Zeichen</documentation> </annotation> <restriction base="xs:string"> <maxLength value="250"/> </restriction> </simpleType> </pre>						

simpleType **Freitext500**

namespace	http://xml.ir-d.de/stn						
type	restriction of string						
properties	base xs:string						
facets	<table border="1"> <thead> <tr> <th>Kind</th> <th>Value</th> <th>Annotation</th> </tr> </thead> <tbody> <tr> <td>maxLength</td> <td>500</td> <td></td> </tr> </tbody> </table>	Kind	Value	Annotation	maxLength	500	
Kind	Value	Annotation					
maxLength	500						
annotation	documentation Facette zur Festlegung des Freitextes von 500 Zeichen						
source	<pre> <simpleType name="Freitext500"> <annotation> <documentation>Facette zur Festlegung des Freitextes von 500 Zeichen</documentation> </annotation> <restriction base="xs:string"> <maxLength value="500"/> </restriction> </simpleType> </pre>						

simpleType **HashString**

namespace	http://xml.ir-d.de/stn
-----------	------------------------

type	restriction of string						
properties	base xs:string						
facets	<table border="1"> <thead> <tr> <th>Kind</th> <th>Value</th> <th>Annotation</th> </tr> </thead> <tbody> <tr> <td>maxLength</td> <td>512</td> <td></td> </tr> </tbody> </table>	Kind	Value	Annotation	maxLength	512	
Kind	Value	Annotation					
maxLength	512						
annotation	documentation Facette zur Festlegung des Hash-Strings der Meldebestätigung						
source	<pre><simpleType name="HashString"> <annotation> <documentation>Facette zur Festlegung des Hash-Strings der Meldebestätigung</documentation> </annotation> <restriction base="xs:string"> <maxLength value="512"/> </restriction> </simpleType></pre>						

simpleType HashWert

namespace	http://xml.ir-d.de/stn						
type	restriction of string						
properties	base xs:string						
facets	<table border="1"> <thead> <tr> <th>Kind</th> <th>Value</th> <th>Annotation</th> </tr> </thead> <tbody> <tr> <td>length</td> <td>64</td> <td></td> </tr> </tbody> </table>	Kind	Value	Annotation	length	64	
Kind	Value	Annotation					
length	64						
annotation	documentation Facette zur Festlegung des Hashwertes der Meldebestätigung						
source	<pre><simpleType name="HashWert"> <annotation> <documentation>Facette zur Festlegung des Hashwertes der Meldebestätigung</documentation> </annotation> <restriction base="xs:string"> <length value="64"/> </restriction> </simpleType></pre>						

simpleType ICD

namespace	http://xml.ir-d.de/stn						
type	restriction of string						
properties	base xs:string						
facets	<table border="1"> <thead> <tr> <th>Kind</th> <th>Value</th> <th>Annotation</th> </tr> </thead> <tbody> <tr> <td>pattern</td> <td>([a-zA-Z][0-9]{2}\.[0-9]{1,2})?(:[RLB])?</td> <td></td> </tr> </tbody> </table>	Kind	Value	Annotation	pattern	([a-zA-Z][0-9]{2}\.[0-9]{1,2})?(:[RLB])?	
Kind	Value	Annotation					
pattern	([a-zA-Z][0-9]{2}\.[0-9]{1,2})?(:[RLB])?						
annotation	documentation Facette zur Festlegung des ICD Code						
source	<pre><simpleType name="ICD"> <annotation> <documentation>Facette zur Festlegung des ICD Code</documentation> </annotation> <restriction base="xs:string"> <pattern value="([a-zA-Z][0-9]{2}\.[0-9]{1,2})?(:[RLB])?" /> </restriction> </simpleType></pre>						

	<code></simpleType></code>
--	----------------------------------

simpleType IdBsnr

namespace	http://xml.ir-d.de/stn						
type	restriction of string						
properties	base xs:string						
facets	<table border="1"> <thead> <tr> <th>Kind</th> <th>Value</th> <th>Annotation</th> </tr> </thead> <tbody> <tr> <td>length</td> <td>9</td> <td></td> </tr> </tbody> </table>	Kind	Value	Annotation	length	9	
Kind	Value	Annotation					
length	9						
annotation	documentation Facette zur Festlegung der Betriebsstättennummer						
source	<pre><simpleType name="IdBsnr"> <annotation> <documentation>Facette zur Festlegung der Betriebsstättennummer</documentation> </annotation> <restriction base="xs:string"> <length value="9"/> </restriction> </simpleType></pre>						

simpleType IdEinrichtung

namespace	http://xml.ir-d.de/stn						
type	restriction of string						
properties	base xs:string						
used by	element MeldungIrdBasis/MEL_IrdIdGesundheitseinrichtung						
facets	<table border="1"> <thead> <tr> <th>Kind</th> <th>Value</th> <th>Annotation</th> </tr> </thead> <tbody> <tr> <td>pattern</td> <td>(IRD-GE-[0-9]{8})</td> <td></td> </tr> </tbody> </table>	Kind	Value	Annotation	pattern	(IRD-GE-[0-9]{8})	
Kind	Value	Annotation					
pattern	(IRD-GE-[0-9]{8})						
annotation	documentation Facette zur Festlegung der Gesundheitseinrichtung-ID						
source	<pre><simpleType name="IdEinrichtung"> <annotation> <documentation>Facette zur Festlegung der Gesundheitseinrichtung- ID</documentation> </annotation> <restriction base="xs:string"> <pattern value="(IRD-GE-[0-9]{8})"/> </restriction> </simpleType></pre>						

simpleType IdStandort

namespace	http://xml.ir-d.de/stn						
type	restriction of string						
properties	base xs:string						
facets	<table border="1"> <thead> <tr> <th>Kind</th> <th>Value</th> <th>Annotation</th> </tr> </thead> <tbody> <tr> <td>length</td> <td>6</td> <td></td> </tr> </tbody> </table>	Kind	Value	Annotation	length	6	
Kind	Value	Annotation					
length	6						
annotation	documentation Facette zur Festlegung der Standort-ID						

source	<pre> <simpleType name="IdStandort"> <annotation> <documentation>Facette zur Festlegung der Standort-ID</documentation> </annotation> <restriction base="xs:string"> <length value="6"/> </restriction> </simpleType> </pre>
--------	--

simpleType IrdArtikkelId

namespace	http://xml.ir-d.de/stn						
type	restriction of string						
properties	base xs:string						
facets	<table border="1"> <thead> <tr> <th>Kind</th> <th>Value</th> <th>Annotation</th> </tr> </thead> <tbody> <tr> <td>maxLength</td> <td>16</td> <td></td> </tr> </tbody> </table>	Kind	Value	Annotation	maxLength	16	
Kind	Value	Annotation					
maxLength	16						
annotation	documentation Facette zur Festlegung der IrdNummer						
source	<pre> <simpleType name="IrdArtikelId"> <annotation> <documentation>Facette zur Festlegung der IrdNummer</documentation> </annotation> <restriction base="xs:string"> <maxLength value="16"/> </restriction> </simpleType> </pre>						

simpleType IrdSpezVersion

namespace	http://xml.ir-d.de/stn						
type	restriction of string						
properties	base xs:string						
facets	<table border="1"> <thead> <tr> <th>Kind</th> <th>Value</th> <th>Annotation</th> </tr> </thead> <tbody> <tr> <td>pattern</td> <td>(([1-9] [1-9][0-9])\.\d{1}[0-9])\.\d{1}[0-9])</td> <td></td> </tr> </tbody> </table>	Kind	Value	Annotation	pattern	(([1-9] [1-9][0-9])\.\d{1}[0-9])\.\d{1}[0-9])	
Kind	Value	Annotation					
pattern	(([1-9] [1-9][0-9])\.\d{1}[0-9])\.\d{1}[0-9])						
annotation	documentation Facette zur Festlegung der Version der IRD-Spezifikation						
source	<pre> <simpleType name="IrdSpezVersion"> <annotation> <documentation>Facette zur Festlegung der Version der IRD- Spezifikation</documentation> </annotation> <restriction base="xs:string"> <pattern value="(([1-9] [1-9][0-9])\.\d{1}[0-9])\.\d{1}[0-9])"/> </restriction> </simpleType> </pre>						

simpleType JaLeer

namespace	http://xml.ir-d.de/stn
type	restriction of integer

properties	base xs:integer
facets	Kind Value Annotation pattern (1)
annotation	documentation Facette zur Festlegung des Unbekannt-Wertes (Bedeutung 1=true)
source	<pre><simpleType name="JaLeer"> <annotation> <documentation>Facette zur Festlegung des Unbekannt-Wertes (Bedeutung 1=true)</documentation> </annotation> <restriction base="xs:integer"> <pattern value="(1)"/> </restriction> </simpleType></pre>

simpleType Meldebestaetigung

namespace	http://xml.ir-d.de/stn
type	restriction of string
properties	base xs:string
facets	Kind Value Annotation length 10
annotation	documentation Facette zur Festlegung der Meldebestätigungslaenge von 10 Zeichen
source	<pre><simpleType name="Meldebestaetigung"> <annotation> <documentation>Facette zur Festlegung der Meldebestätigungslaenge von 10 Zeichen</documentation> </annotation> <restriction base="xs:string"> <length value="10"/> </restriction> </simpleType></pre>

simpleType OPS

namespace	http://xml.ir-d.de/stn
type	restriction of string
properties	base xs:string
facets	Kind Value Annotation pattern ([135689]\-([0-9]){2}([a-zA-Z0-9]){1}\.([a-zA-Z0-9]{1,2}))*(:[RLB])?)
annotation	documentation Facette zur Festlegung des Prozedurenschluessels
source	<pre><simpleType name="OPS"> <annotation> <documentation>Facette zur Festlegung des Prozedurenschluessels</documentation> </annotation> <restriction base="xs:string"> <pattern value="([135689]\-([0-9]){2}([a-zA-Z0-9]){1}\.([a-zA-Z0-9]{1,2}))*(:[RLB])?" /> </restriction></pre>

	<code></simpleType></code>
--	----------------------------------

simpleType **String2**

namespace	http://xml.ir-d.de/stn						
type	restriction of string						
properties	base xs:string						
facets	<table border="1"> <thead> <tr> <th>Kind</th> <th>Value</th> <th>Annotation</th> </tr> </thead> <tbody> <tr> <td>pattern</td> <td>([0-9]{2})</td> <td></td> </tr> </tbody> </table>	Kind	Value	Annotation	pattern	([0-9]{2})	
Kind	Value	Annotation					
pattern	([0-9]{2})						
annotation	documentation Facette zur Festlegung des kodierten Entlassungsgrundes						
source	<pre><simpleType name="String2"> <annotation> <documentation>Facette zur Festlegung des kodierten Entlassungsgrundes</documentation> </annotation> <restriction base="xs:string"> <pattern value="([0-9]{2})"/> </restriction> </simpleType></pre>						

simpleType **String20**

namespace	http://xml.ir-d.de/stn						
type	restriction of string						
properties	base xs:string						
facets	<table border="1"> <thead> <tr> <th>Kind</th> <th>Value</th> <th>Annotation</th> </tr> </thead> <tbody> <tr> <td>maxLength</td> <td>20</td> <td></td> </tr> </tbody> </table>	Kind	Value	Annotation	maxLength	20	
Kind	Value	Annotation					
maxLength	20						
annotation	documentation Facette zur Festlegung von: Artikel-, Ident-, Serien-, Lot-Nummer des Produkts						
source	<pre><simpleType name="String20"> <annotation> <documentation>Facette zur Festlegung von: Artikel-, Ident-, Serien-, Lot-Nummer des Produkts</documentation> </annotation> <restriction base="xs:string"> <maxLength value="20"/> </restriction> </simpleType></pre>						

simpleType **String7**

namespace	http://xml.ir-d.de/stn						
type	restriction of string						
properties	base xs:string						
facets	<table border="1"> <thead> <tr> <th>Kind</th> <th>Value</th> <th>Annotation</th> </tr> </thead> <tbody> <tr> <td>pattern</td> <td>([0-9]{7})</td> <td></td> </tr> </tbody> </table>	Kind	Value	Annotation	pattern	([0-9]{7})	
Kind	Value	Annotation					
pattern	([0-9]{7})						
annotation	documentation Facette zur Festlegung eines Katalogcodes						
source	<pre><simpleType name="String7"></pre>						

	<pre> <annotation> <documentation>Facette zur Festlegung eines Katalogkodes</documentation> </annotation> <restriction base="xs:string"> <pattern value="([0-9]{7})"/> </restriction> </simpleType> </pre>
--	--

simpleType **Sw**

namespace	http://xml.ir-d.de/stn						
type	restriction of string						
properties	base xs:string						
facets	<table border="1"> <thead> <tr> <th>Kind</th> <th>Value</th> <th>Annotation</th> </tr> </thead> <tbody> <tr> <td>maxLength</td> <td>120</td> <td></td> </tr> </tbody> </table>	Kind	Value	Annotation	maxLength	120	
Kind	Value	Annotation					
maxLength	120						
annotation	documentation Facette für Merkmale der externen Software						
source	<pre> <simpleType name="Sw"> <annotation> <documentation>Facette für Merkmale der externen Software</documentation> </annotation> <restriction base="xs:string"> <maxLength value="120"/> </restriction> </simpleType> </pre>						

simpleType **Transfervummer**

namespace	http://xml.ir-d.de/stn						
type	restriction of string						
properties	base xs:string						
used by	element StornoFallBasis/FAL Transfervummer						
facets	<table border="1"> <thead> <tr> <th>Kind</th> <th>Value</th> <th>Annotation</th> </tr> </thead> <tbody> <tr> <td>pattern</td> <td>([a-z0-9]{64})</td> <td></td> </tr> </tbody> </table>	Kind	Value	Annotation	pattern	([a-z0-9]{64})	
Kind	Value	Annotation					
pattern	([a-z0-9]{64})						
annotation	documentation Facette zur Festlegung der Transfervummer						
source	<pre> <simpleType name="Transfervummer"> <annotation> <documentation>Facette zur Festlegung der Transfervummer</documentation> </annotation> <restriction base="xs:string"> <pattern value="([a-z0-9]{64})"/> </restriction> </simpleType> </pre>						

simpleType **Versionsnummer**

namespace	http://xml.ir-d.de/stn
type	restriction of string
properties	base xs:string

facets	<table border="1"> <thead> <tr> <th>Kind</th> <th>Value</th> <th>Annotation</th> </tr> </thead> <tbody> <tr> <td>maxLength</td> <td>10</td> <td></td> </tr> </tbody> </table>	Kind	Value	Annotation	maxLength	10	
Kind	Value	Annotation					
maxLength	10						
annotation	documentation Facette zur Festlegung der Versionsnummer des gelieferten Datensatzes						
source	<pre><simpleType name="Versionsnummer"> <annotation> <documentation>Facette zur Festlegung der Versionsnummer des gelieferten Datensatzes</documentation> </annotation> <restriction base="xs:string"> <maxLength value="10"/> </restriction> </simpleType></pre>						

simpleType Zahl1

namespace	http://xml.ir-d.de/stn									
type	restriction of positiveInteger									
properties	base xs:positiveInteger									
facets	<table border="1"> <thead> <tr> <th>Kind</th> <th>Value</th> <th>Annotation</th> </tr> </thead> <tbody> <tr> <td>minInclusive</td> <td>1</td> <td></td> </tr> <tr> <td>maxInclusive</td> <td>9</td> <td></td> </tr> </tbody> </table>	Kind	Value	Annotation	minInclusive	1		maxInclusive	9	
Kind	Value	Annotation								
minInclusive	1									
maxInclusive	9									
annotation	documentation Facette zur Festlegung der 1-stelligen Ganzzahlenwerte									
source	<pre><simpleType name="Zahl1"> <annotation> <documentation>Facette zur Festlegung der 1-stelligen Ganzzahlenwerte</documentation> </annotation> <restriction base="xs:positiveInteger"> <minInclusive value="1"/> <maxInclusive value="9"/> </restriction> </simpleType></pre>									

simpleType Zahl1_1

namespace	http://xml.ir-d.de/stn															
type	restriction of decimal															
properties	base xs:decimal															
facets	<table border="1"> <thead> <tr> <th>Kind</th> <th>Value</th> <th>Annotation</th> </tr> </thead> <tbody> <tr> <td>minInclusive</td> <td>0.1</td> <td></td> </tr> <tr> <td>maxInclusive</td> <td>9.9</td> <td></td> </tr> <tr> <td>totalDigits</td> <td>2</td> <td></td> </tr> <tr> <td>fractionDigits</td> <td>1</td> <td></td> </tr> </tbody> </table>	Kind	Value	Annotation	minInclusive	0.1		maxInclusive	9.9		totalDigits	2		fractionDigits	1	
Kind	Value	Annotation														
minInclusive	0.1															
maxInclusive	9.9															
totalDigits	2															
fractionDigits	1															
annotation	documentation Facette zur Festlegung des Formats [N].[N]															
source	<pre><simpleType name="Zahl1_1"> <annotation> <documentation>Facette zur Festlegung des Formats [N].[N]</documentation> </annotation> <restriction base="xs:decimal"></pre>															

	<pre> <totalDigits value="2"/> <fractionDigits value="1"/> <minInclusive value="0.1"/> <maxInclusive value="9.9"/> </restriction> </simpleType> </pre>
--	--

simpleType Zahl2

namespace	http://xml.ir-d.de/stn									
type	restriction of positiveInteger									
properties	base xs:positiveInteger									
facets	<table border="1"> <thead> <tr> <th>Kind</th> <th>Value</th> <th>Annotation</th> </tr> </thead> <tbody> <tr> <td>minInclusive</td> <td>1</td> <td></td> </tr> <tr> <td>maxInclusive</td> <td>99</td> <td></td> </tr> </tbody> </table>	Kind	Value	Annotation	minInclusive	1		maxInclusive	99	
Kind	Value	Annotation								
minInclusive	1									
maxInclusive	99									
annotation	documentation Facette zur Festlegung der 2-stelligen Ganzzahlenwerte									
source	<pre> <simpleType name="Zahl2"> <annotation> <documentation>Facette zur Festlegung der 2-stelligen Ganzzahlenwerte</documentation> </annotation> <restriction base="xs:positiveInteger"> <minInclusive value="1"/> <maxInclusive value="99"/> </restriction> </simpleType> </pre>									

simpleType Zahl2_1

namespace	http://xml.ir-d.de/stn															
type	restriction of decimal															
properties	base xs:decimal															
facets	<table border="1"> <thead> <tr> <th>Kind</th> <th>Value</th> <th>Annotation</th> </tr> </thead> <tbody> <tr> <td>minInclusive</td> <td>0.1</td> <td></td> </tr> <tr> <td>maxInclusive</td> <td>99.9</td> <td></td> </tr> <tr> <td>totalDigits</td> <td>3</td> <td></td> </tr> <tr> <td>fractionDigits</td> <td>1</td> <td></td> </tr> </tbody> </table>	Kind	Value	Annotation	minInclusive	0.1		maxInclusive	99.9		totalDigits	3		fractionDigits	1	
Kind	Value	Annotation														
minInclusive	0.1															
maxInclusive	99.9															
totalDigits	3															
fractionDigits	1															
annotation	documentation Facette zur Festlegung des Formats [NN].[N]															
source	<pre> <simpleType name="Zahl2_1"> <annotation> <documentation>Facette zur Festlegung des Formats [NN].[N]</documentation> </annotation> <restriction base="xs:decimal"> <totalDigits value="3"/> <fractionDigits value="1"/> <minInclusive value="0.1"/> <maxInclusive value="99.9"/> </restriction> </simpleType> </pre>															

simpleType **Zahl3**

namespace	http://xml.ir-d.de/stn									
type	restriction of positiveInteger									
properties	base xs:positiveInteger									
facets	<table border="1"> <thead> <tr> <th>Kind</th> <th>Value</th> <th>Annotation</th> </tr> </thead> <tbody> <tr> <td>minInclusive</td> <td>1</td> <td></td> </tr> <tr> <td>maxInclusive</td> <td>999</td> <td></td> </tr> </tbody> </table>	Kind	Value	Annotation	minInclusive	1		maxInclusive	999	
Kind	Value	Annotation								
minInclusive	1									
maxInclusive	999									
annotation	documentation Facette zur Festlegung der 3-stelligen Ganzzahlenwerte									
source	<pre><simpleType name="Zahl3"> <annotation> <documentation>Facette zur Festlegung der 3-stelligen Ganzzahlenwerte</documentation> </annotation> <restriction base="xs:positiveInteger"> <minInclusive value="1"/> <maxInclusive value="999"/> </restriction> </simpleType></pre>									

simpleType **Zahl3_1**

namespace	http://xml.ir-d.de/stn															
type	restriction of decimal															
properties	base xs:decimal															
facets	<table border="1"> <thead> <tr> <th>Kind</th> <th>Value</th> <th>Annotation</th> </tr> </thead> <tbody> <tr> <td>minInclusive</td> <td>0.1</td> <td></td> </tr> <tr> <td>maxInclusive</td> <td>999.9</td> <td></td> </tr> <tr> <td>totalDigits</td> <td>4</td> <td></td> </tr> <tr> <td>fractionDigits</td> <td>1</td> <td></td> </tr> </tbody> </table>	Kind	Value	Annotation	minInclusive	0.1		maxInclusive	999.9		totalDigits	4		fractionDigits	1	
Kind	Value	Annotation														
minInclusive	0.1															
maxInclusive	999.9															
totalDigits	4															
fractionDigits	1															
annotation	documentation Facette zur Festlegung des Formats [NNN].[N]															
source	<pre><simpleType name="Zahl3_1"> <annotation> <documentation>Facette zur Festlegung des Formats [NNN].[N]</documentation> </annotation> <restriction base="xs:decimal"> <totalDigits value="4"/> <fractionDigits value="1"/> <minInclusive value="0.1"/> <maxInclusive value="999.9"/> </restriction> </simpleType></pre>															

simpleType **Zahl3mitNull**

namespace	http://xml.ir-d.de/stn
-----------	------------------------

type	restriction of integer									
properties	base xs:integer									
facets	<table border="1"> <thead> <tr> <th>Kind</th> <th>Value</th> <th>Annotation</th> </tr> </thead> <tbody> <tr> <td>minInclusive</td> <td>0</td> <td></td> </tr> <tr> <td>maxInclusive</td> <td>999</td> <td></td> </tr> </tbody> </table>	Kind	Value	Annotation	minInclusive	0		maxInclusive	999	
Kind	Value	Annotation								
minInclusive	0									
maxInclusive	999									
annotation	documentation Facette zur Festlegung der 3-stelligen Ganzzahlenwerte inklusive "0"									
source	<pre><simpleType name="Zahl3mitNull"> <annotation> <documentation>Facette zur Festlegung der 3-stelligen Ganzzahlenwerte inklusive "0"</documentation> </annotation> <restriction base="xs:integer"> <minInclusive value="0"/> <maxInclusive value="999"/> </restriction> </simpleType></pre>									

simpleType **Zahl4**

namespace	http://xml.ir-d.de/stn									
type	restriction of positiveInteger									
properties	base xs:positiveInteger									
facets	<table border="1"> <thead> <tr> <th>Kind</th> <th>Value</th> <th>Annotation</th> </tr> </thead> <tbody> <tr> <td>minInclusive</td> <td>1</td> <td></td> </tr> <tr> <td>maxInclusive</td> <td>9999</td> <td></td> </tr> </tbody> </table>	Kind	Value	Annotation	minInclusive	1		maxInclusive	9999	
Kind	Value	Annotation								
minInclusive	1									
maxInclusive	9999									
annotation	documentation Facette zur Festlegung der 4-stelligen Ganzzahlenwerte									
source	<pre><simpleType name="Zahl4"> <annotation> <documentation>Facette zur Festlegung der 4-stelligen Ganzzahlenwerte</documentation> </annotation> <restriction base="xs:positiveInteger"> <minInclusive value="1"/> <maxInclusive value="9999"/> </restriction> </simpleType></pre>									

simpleType **Zahl5**

namespace	http://xml.ir-d.de/stn									
type	restriction of positiveInteger									
properties	base xs:positiveInteger									
facets	<table border="1"> <thead> <tr> <th>Kind</th> <th>Value</th> <th>Annotation</th> </tr> </thead> <tbody> <tr> <td>minInclusive</td> <td>1</td> <td></td> </tr> <tr> <td>maxInclusive</td> <td>99999</td> <td></td> </tr> </tbody> </table>	Kind	Value	Annotation	minInclusive	1		maxInclusive	99999	
Kind	Value	Annotation								
minInclusive	1									
maxInclusive	99999									
annotation	documentation Facette zur Festlegung der 5-stelligen Ganzzahlenwerte									
source	<pre><simpleType name="Zahl5"> <annotation></pre>									

	<pre> <documentation>Facette zur Festlegung der 5-stelligen Ganzzahlenwerte</documentation> </annotation> <restriction base="xs:positiveInteger"> <minInclusive value="1"/> <maxInclusive value="99999"/> </restriction> </simpleType> </pre>
--	---

simpleType **Zahl5mitNull**

namespace	http://xml.ir-d.de/stn									
type	restriction of integer									
properties	base xs:integer									
facets	<table border="1"> <thead> <tr> <th>Kind</th> <th>Value</th> <th>Annotation</th> </tr> </thead> <tbody> <tr> <td>minInclusive</td> <td>0</td> <td></td> </tr> <tr> <td>maxInclusive</td> <td>99999</td> <td></td> </tr> </tbody> </table>	Kind	Value	Annotation	minInclusive	0		maxInclusive	99999	
Kind	Value	Annotation								
minInclusive	0									
maxInclusive	99999									
annotation	documentation Facette zur Festlegung der 5-stelligen Ganzzahlenwerte inklusive "0"									
source	<pre> <simpleType name="Zahl5mitNull"> <annotation> <documentation>Facette zur Festlegung der 5-stelligen Ganzzahlenwerte inklusive "0"</documentation> </annotation> <restriction base="xs:integer"> <minInclusive value="0"/> <maxInclusive value="99999"/> </restriction> </simpleType> </pre>									

complexType **MeldungIrdBasis**

diagram	<pre> classDiagram class MeldungIrdBasis class MEL_IrdIdGesundheitseinrichtung { type IdEinrichtung pattern ((IRD-GE-[0-9]{8})) } MeldungIrdBasis "1" -- "*" MEL_IrdIdGesundheitseinrichtung </pre>
namespace	http://xml.ir-d.de/stn
children	MEL_IrdIdGesundheitseinrichtung
used by	complexType Storno
source	<pre> <complexType name="MeldungIrdBasis"> <sequence> <element name="MEL_IrdIdGesundheitseinrichtung" type="IdEinrichtung"/> </sequence> </complexType> </pre>

element **MeldungIrdBasis/MEL_IrdIdGesundheitseinrichtung**

diagram							
type	IdEinrichtung						
properties	content simple						
facets	<table border="1"> <tr> <td>Kind</td> <td>Value</td> <td>Annotation</td> </tr> <tr> <td>pattern</td> <td>(IRD-GE-[0-9]{8})</td> <td></td> </tr> </table>	Kind	Value	Annotation	pattern	(IRD-GE-[0-9]{8})	
Kind	Value	Annotation					
pattern	(IRD-GE-[0-9]{8})						
source	<code><element name="MEL_IrdIdGesundheitseinrichtung" type="IdEinrichtung"/></code>						

complexType **StornoFallBasis**

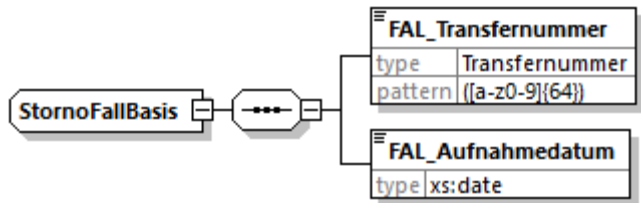
diagram	
namespace	http://xml.ir-d.de/stn
children	FAL_Transfernummer FAL_Aufnahmedatum
used by	element Storno/fall
source	<pre> <complexType name="StornoFallBasis"> <sequence> <element name="FAL_Transfernummer" type="Transfervummer"/> <element name="FAL_Aufnahmedatum" type="xs:date"/> </sequence> </complexType> </pre>

element **StornoFallBasis/FAL_Transfernummer**

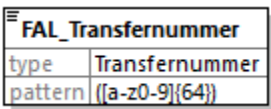
diagram							
type	Transfervummer						
properties	content simple						
facets	<table border="1"> <tr> <td>Kind</td> <td>Value</td> <td>Annotation</td> </tr> <tr> <td>pattern</td> <td>([a-z0-9]{64})</td> <td></td> </tr> </table>	Kind	Value	Annotation	pattern	([a-z0-9]{64})	
Kind	Value	Annotation					
pattern	([a-z0-9]{64})						
source	<code><element name="FAL_Transfernummer" type="Transfervummer"/></code>						

element **StornoFallBasis/FAL_Aufnahmedatum**

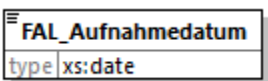
diagram	
---------	---

type	date
properties	content simple
source	<code><element name="FAL_Aufnahmedatum" type="xs:date"/></code>

simpleType DatumText

namespace	http://xml.ir-d.de/irdma						
type	restriction of string						
properties	base xs:string						
facets	<table border="1"> <thead> <tr> <th>Kind</th> <th>Value</th> <th>Annotation</th> </tr> </thead> <tbody> <tr> <td>pattern</td> <td>(([0-9]{4})([0-9]{2})?([0-9]{2})?)</td> <td></td> </tr> </tbody> </table>	Kind	Value	Annotation	pattern	(([0-9]{4})([0-9]{2})?([0-9]{2})?)	
Kind	Value	Annotation					
pattern	(([0-9]{4})([0-9]{2})?([0-9]{2})?)						
annotation	documentation Facette zur Festlegung des freien Datumformats: JJJ[-MM[-TT]]						
source	<pre><simpleType name="DatumText"> <annotation> <documentation>Facette zur Festlegung des freien Datumformats: JJJ[-MM[-TT]]</documentation> </annotation> <restriction base="xs:string"> <pattern value="(([0-9]{4})([0-9]{2})?([0-9]{2})?)"/> </restriction> </simpleType></pre>						

simpleType Freitext250

namespace	http://xml.ir-d.de/irdma						
type	restriction of string						
properties	base xs:string						
used by	elements BestaetigungBasis/BEG AusloesendeOpsListe EmpfangsbestaetigungBasis/EBG Empfangsbestaetigung						
facets	<table border="1"> <thead> <tr> <th>Kind</th> <th>Value</th> <th>Annotation</th> </tr> </thead> <tbody> <tr> <td>maxLength</td> <td>250</td> <td></td> </tr> </tbody> </table>	Kind	Value	Annotation	maxLength	250	
Kind	Value	Annotation					
maxLength	250						
annotation	documentation Facette zur Festlegung des Freitextes von 250 Zeichen						
source	<pre><simpleType name="Freitext250"> <annotation> <documentation>Facette zur Festlegung des Freitextes von 250 Zeichen</documentation> </annotation> <restriction base="xs:string"> <maxLength value="250"/> </restriction> </simpleType></pre>						

simpleType Freitext500

namespace	http://xml.ir-d.de/irdma
type	restriction of string
properties	base xs:string

used by	elements HinweisBasis/HNW Datenelement HinweisBasis/HNW Meldung HinweisBasis/HNW Wert
facets	Kind Value Annotation maxLength 500
annotation	documentation Facette zur Festlegung des Freitextes von 500 Zeichen
source	<pre><simpleType name="Freitext500"> <annotation> <documentation>Facette zur Festlegung des Freitextes von 500 Zeichen</documentation> </annotation> <restriction base="xs:string"> <maxLength value="500"/> </restriction> </simpleType></pre>

simpleType HashString

namespace	http://xml.ir-d.de/irdma
type	restriction of string
properties	base xs:string
used by	element BestaetigungBasis/BEG Hash String
facets	Kind Value Annotation maxLength 512
annotation	documentation Facette zur Festlegung des Hash-Strings der Meldebestätigung
source	<pre><simpleType name="HashString"> <annotation> <documentation>Facette zur Festlegung des Hash-Strings der Meldebestätigung</documentation> </annotation> <restriction base="xs:string"> <maxLength value="512"/> </restriction> </simpleType></pre>

simpleType HashWert

namespace	http://xml.ir-d.de/irdma
type	restriction of string
properties	base xs:string
used by	element BestaetigungBasis/BEG Hash Wert
facets	Kind Value Annotation length 64
annotation	documentation Facette zur Festlegung des Hashwertes der Meldebestätigung
source	<pre><simpleType name="HashWert"> <annotation> <documentation>Facette zur Festlegung des Hashwertes der Meldebestätigung</documentation> </annotation> <restriction base="xs:string"></pre>

	<pre> <length value="64"/> </restriction> </simpleType> </pre>
--	--

simpleType ICD

namespace	http://xml.ir-d.de/irdma						
type	restriction of string						
properties	base xs:string						
facets	<table border="1"> <thead> <tr> <th>Kind</th> <th>Value</th> <th>Annotation</th> </tr> </thead> <tbody> <tr> <td>pattern</td> <td>([a-zA-Z][0-9]{2}(\.[0-9]{1,2})?(:[RLB])?)</td> <td></td> </tr> </tbody> </table>	Kind	Value	Annotation	pattern	([a-zA-Z][0-9]{2}(\.[0-9]{1,2})?(:[RLB])?)	
Kind	Value	Annotation					
pattern	([a-zA-Z][0-9]{2}(\.[0-9]{1,2})?(:[RLB])?)						
annotation	documentation Facette zur Festlegung des ICD Code						
source	<pre> <simpleType name="ICD"> <annotation> <documentation>Facette zur Festlegung des ICD Code</documentation> </annotation> <restriction base="xs:string"> <pattern value="([a-zA-Z][0-9]{2}(\.[0-9]{1,2})?(:[RLB])?)"/> </restriction> </simpleType> </pre>						

simpleType IdBsnr

namespace	http://xml.ir-d.de/irdma						
type	restriction of string						
properties	base xs:string						
facets	<table border="1"> <thead> <tr> <th>Kind</th> <th>Value</th> <th>Annotation</th> </tr> </thead> <tbody> <tr> <td>length</td> <td>9</td> <td></td> </tr> </tbody> </table>	Kind	Value	Annotation	length	9	
Kind	Value	Annotation					
length	9						
annotation	documentation Facette zur Festlegung der Betriebsstättennummer						
source	<pre> <simpleType name="IdBsnr"> <annotation> <documentation>Facette zur Festlegung der Betriebsstättennummer</documentation> </annotation> <restriction base="xs:string"> <length value="9"/> </restriction> </simpleType> </pre>						

simpleType IdEinrichtung

namespace	http://xml.ir-d.de/irdma						
type	restriction of string						
properties	base xs:string						
used by	element MeldungIrdBasis/MEL_IrdIdGesundheitseinrichtung						
facets	<table border="1"> <thead> <tr> <th>Kind</th> <th>Value</th> <th>Annotation</th> </tr> </thead> <tbody> <tr> <td>pattern</td> <td>(IRD-GE-[0-9]{8})</td> <td></td> </tr> </tbody> </table>	Kind	Value	Annotation	pattern	(IRD-GE-[0-9]{8})	
Kind	Value	Annotation					
pattern	(IRD-GE-[0-9]{8})						

annotation	documentation Facette zur Festlegung der Gesundheitseinrichtung-ID
source	<pre><simpleType name="IdEinrichtung"> <annotation> <documentation>Facette zur Festlegung der Gesundheitseinrichtung-ID</documentation> </annotation> <restriction base="xs:string"> <pattern value="(IRD-GE-[0-9]{8})"/> </restriction> </simpleType></pre>

simpleType **IdStandort**

namespace	http://xml.ir-d.de/irdma						
type	restriction of string						
properties	base xs:string						
facets	<table border="1"> <thead> <tr> <th>Kind</th> <th>Value</th> <th>Annotation</th> </tr> </thead> <tbody> <tr> <td>length</td> <td>6</td> <td></td> </tr> </tbody> </table>	Kind	Value	Annotation	length	6	
Kind	Value	Annotation					
length	6						
annotation	documentation Facette zur Festlegung der Standort-ID						
source	<pre><simpleType name="IdStandort"> <annotation> <documentation>Facette zur Festlegung der Standort-ID</documentation> </annotation> <restriction base="xs:string"> <length value="6"/> </restriction> </simpleType></pre>						

simpleType **IrdArtikelId**

namespace	http://xml.ir-d.de/irdma						
type	restriction of string						
properties	base xs:string						
facets	<table border="1"> <thead> <tr> <th>Kind</th> <th>Value</th> <th>Annotation</th> </tr> </thead> <tbody> <tr> <td>maxLength</td> <td>16</td> <td></td> </tr> </tbody> </table>	Kind	Value	Annotation	maxLength	16	
Kind	Value	Annotation					
maxLength	16						
annotation	documentation Facette zur Festlegung der IrdNummer						
source	<pre><simpleType name="IrdArtikelId"> <annotation> <documentation>Facette zur Festlegung der IrdNummer</documentation> </annotation> <restriction base="xs:string"> <maxLength value="16"/> </restriction> </simpleType></pre>						

simpleType **IrdSpezVersion**

namespace	http://xml.ir-d.de/irdma
-----------	--------------------------

type	restriction of string						
properties	base xs:string						
facets	<table border="1"> <thead> <tr> <th>Kind</th> <th>Value</th> <th>Annotation</th> </tr> </thead> <tbody> <tr> <td>pattern</td> <td>(([1-9] [1-9][0-9])\.\d{1-3})\.\d{1-3}</td> <td></td> </tr> </tbody> </table>	Kind	Value	Annotation	pattern	(([1-9] [1-9][0-9])\.\d{1-3})\.\d{1-3}	
Kind	Value	Annotation					
pattern	(([1-9] [1-9][0-9])\.\d{1-3})\.\d{1-3}						
annotation	documentation Facette zur Festlegung der Version der IRD-Spezifikation						
source	<pre><simpleType name="IrdSpezVersion"> <annotation> <documentation>Facette zur Festlegung der Version der IRD- Spezifikation</documentation> </annotation> <restriction base="xs:string"> <pattern value="(([1-9] [1-9][0-9])\.\d{1-3})\.\d{1-3}"/> </restriction> </simpleType></pre>						

simpleType **JaLeer**

namespace	http://xml.ir-d.de/irdma						
type	restriction of integer						
properties	base xs:integer						
facets	<table border="1"> <thead> <tr> <th>Kind</th> <th>Value</th> <th>Annotation</th> </tr> </thead> <tbody> <tr> <td>pattern</td> <td>(1)</td> <td></td> </tr> </tbody> </table>	Kind	Value	Annotation	pattern	(1)	
Kind	Value	Annotation					
pattern	(1)						
annotation	documentation Facette zur Festlegung des Unbekannt-Wertes (Bedeutung 1=true)						
source	<pre><simpleType name="JaLeer"> <annotation> <documentation>Facette zur Festlegung des Unbekannt-Wertes (Bedeutung 1=true)</documentation> </annotation> <restriction base="xs:integer"> <pattern value="(1)"/> </restriction> </simpleType></pre>						

simpleType **Meldebestaetigung**

namespace	http://xml.ir-d.de/irdma						
type	restriction of string						
properties	base xs:string						
used by	element BestaetigungBasis/BEG Meldebestaetigung ID						
facets	<table border="1"> <thead> <tr> <th>Kind</th> <th>Value</th> <th>Annotation</th> </tr> </thead> <tbody> <tr> <td>length</td> <td>10</td> <td></td> </tr> </tbody> </table>	Kind	Value	Annotation	length	10	
Kind	Value	Annotation					
length	10						
annotation	documentation Facette zur Festlegung der Meldebestätigungslaenge von 10 Zeichen						
source	<pre><simpleType name="Meldebestaetigung"> <annotation> <documentation>Facette zur Festlegung der Meldebestätigungslaenge von 10 Zeichen</documentation> </annotation> <restriction base="xs:string"></pre>						

	<pre><length value="10"/> </restriction> </simpleType></pre>
--	--

simpleType OPS

namespace	http://xml.ir-d.de/irdma		
type	restriction of string		
properties	base xs:string		
facets	Kind	Value	Annotation
	pattern	(([135689]\-([0-9]){2}([a-zA-Z0-9]){1}\.([a-zA-Z0-9]{1,2}))*(:[RLB])?)	
annotation	documentation Facette zur Festlegung des Prozedurenschlussels		
source	<pre><simpleType name="OPS"> <annotation> <documentation>Facette zur Festlegung des Prozedurenschlussels</documentation> </annotation> <restriction base="xs:string"> <pattern value="([135689]\-([0-9]){2}([a-zA-Z0-9]){1}\.([a-zA-Z0-9]{1,2}))*(:[RLB])?" /> </restriction> </simpleType></pre>		

simpleType String2

namespace	http://xml.ir-d.de/irdma		
type	restriction of string		
properties	base xs:string		
facets	Kind	Value	Annotation
	pattern	([0-9]{2})	
annotation	documentation Facette zur Festlegung des kodierten Entlassungsgrundes		
source	<pre><simpleType name="String2"> <annotation> <documentation>Facette zur Festlegung des kodierten Entlassungsgrundes</documentation> </annotation> <restriction base="xs:string"> <pattern value="([0-9]{2})" /> </restriction> </simpleType></pre>		

simpleType String20

namespace	http://xml.ir-d.de/irdma		
type	restriction of string		
properties	base xs:string		
facets	Kind	Value	Annotation
	maxLength	20	

annotation	documentation Facette zur Festlegung von: Artikel-, Ident-, Serien-, Lot-Nummer des Produkts
source	<pre> <simpleType name="String20"> <annotation> <documentation>Facette zur Festlegung von: Artikel-, Ident-, Serien-, Lot-Nummer des Produkts</documentation> </annotation> <restriction base="xs:string"> <maxLength value="20"/> </restriction> </simpleType> </pre>

simpleType String7

namespace	http://xml.ir-d.de/irdma						
type	restriction of string						
properties	base xs:string						
facets	<table border="1"> <thead> <tr> <th>Kind</th> <th>Value</th> <th>Annotation</th> </tr> </thead> <tbody> <tr> <td>pattern</td> <td>([0-9]{7})</td> <td></td> </tr> </tbody> </table>	Kind	Value	Annotation	pattern	([0-9]{7})	
Kind	Value	Annotation					
pattern	([0-9]{7})						
annotation	documentation Facette zur Festlegung eines Katalogkodes						
source	<pre> <simpleType name="String7"> <annotation> <documentation>Facette zur Festlegung eines Katalogkodes</documentation> </annotation> <restriction base="xs:string"> <pattern value="([0-9]{7})"/> </restriction> </simpleType> </pre>						

simpleType Sw

namespace	http://xml.ir-d.de/irdma						
type	restriction of string						
properties	base xs:string						
facets	<table border="1"> <thead> <tr> <th>Kind</th> <th>Value</th> <th>Annotation</th> </tr> </thead> <tbody> <tr> <td>maxLength</td> <td>120</td> <td></td> </tr> </tbody> </table>	Kind	Value	Annotation	maxLength	120	
Kind	Value	Annotation					
maxLength	120						
annotation	documentation Facette für Merkmale der externen Software						
source	<pre> <simpleType name="Sw"> <annotation> <documentation>Facette für Merkmale der externen Software</documentation> </annotation> <restriction base="xs:string"> <maxLength value="120"/> </restriction> </simpleType> </pre>						

simpleType Transfervummer

namespace	http://xml.ir-d.de/irdma
-----------	--------------------------

type	restriction of string						
properties	base xs:string						
used by	element MeldungIrdFallBasis/FAL Transfernummer						
facets	<table border="1"> <thead> <tr> <th>Kind</th> <th>Value</th> <th>Annotation</th> </tr> </thead> <tbody> <tr> <td>pattern</td> <td>([a-z0-9]{64})</td> <td></td> </tr> </tbody> </table>	Kind	Value	Annotation	pattern	([a-z0-9]{64})	
Kind	Value	Annotation					
pattern	([a-z0-9]{64})						
annotation	documentation Facette zur Festlegung der Transfernummer						
source	<pre><simpleType name="Transfernummer"> <annotation> <documentation>Facette zur Festlegung der Transfernummer</documentation> </annotation> <restriction base="xs:string"> <pattern value="([a-z0-9]{64})"/> </restriction> </simpleType></pre>						

simpleType **Versionsnummer**

namespace	http://xml.ir-d.de/irdma						
type	restriction of string						
properties	base xs:string						
facets	<table border="1"> <thead> <tr> <th>Kind</th> <th>Value</th> <th>Annotation</th> </tr> </thead> <tbody> <tr> <td>maxLength</td> <td>10</td> <td></td> </tr> </tbody> </table>	Kind	Value	Annotation	maxLength	10	
Kind	Value	Annotation					
maxLength	10						
annotation	documentation Facette zur Festlegung der Versionsnummer des gelieferten Datensatzes						
source	<pre><simpleType name="Versionsnummer"> <annotation> <documentation>Facette zur Festlegung der Versionsnummer des gelieferten Datensatzes</documentation> </annotation> <restriction base="xs:string"> <maxLength value="10"/> </restriction> </simpleType></pre>						

simpleType **Zahl1**

namespace	http://xml.ir-d.de/irdma									
type	restriction of positiveInteger									
properties	base xs:positiveInteger									
facets	<table border="1"> <thead> <tr> <th>Kind</th> <th>Value</th> <th>Annotation</th> </tr> </thead> <tbody> <tr> <td>minInclusive</td> <td>1</td> <td></td> </tr> <tr> <td>maxInclusive</td> <td>9</td> <td></td> </tr> </tbody> </table>	Kind	Value	Annotation	minInclusive	1		maxInclusive	9	
Kind	Value	Annotation								
minInclusive	1									
maxInclusive	9									
annotation	documentation Facette zur Festlegung der 1-stelligen Ganzzahlenwerte									
source	<pre><simpleType name="Zahl1"> <annotation> <documentation>Facette zur Festlegung der 1-stelligen Ganzzahlenwerte</documentation> </annotation> <restriction base="xs:positiveInteger"></pre>									

	<pre> <minInclusive value="1"/> <maxInclusive value="9"/> </restriction> </simpleType> </pre>
--	---

simpleType **Zahl1_1**

namespace	http://xml.ir-d.de/irdma															
type	restriction of decimal															
properties	base xs:decimal															
facets	<table border="1"> <thead> <tr> <th>Kind</th> <th>Value</th> <th>Annotation</th> </tr> </thead> <tbody> <tr> <td>minInclusive</td> <td>0.1</td> <td></td> </tr> <tr> <td>maxInclusive</td> <td>9.9</td> <td></td> </tr> <tr> <td>totalDigits</td> <td>2</td> <td></td> </tr> <tr> <td>fractionDigits</td> <td>1</td> <td></td> </tr> </tbody> </table>	Kind	Value	Annotation	minInclusive	0.1		maxInclusive	9.9		totalDigits	2		fractionDigits	1	
Kind	Value	Annotation														
minInclusive	0.1															
maxInclusive	9.9															
totalDigits	2															
fractionDigits	1															
annotation	documentation Facette zur Festlegung des Formats [N].[N]															
source	<pre> <simpleType name="Zahl1_1"> <annotation> <documentation>Facette zur Festlegung des Formats [N].[N]</documentation> </annotation> <restriction base="xs:decimal"> <totalDigits value="2"/> <fractionDigits value="1"/> <minInclusive value="0.1"/> <maxInclusive value="9.9"/> </restriction> </simpleType> </pre>															

simpleType **Zahl2**

namespace	http://xml.ir-d.de/irdma									
type	restriction of positiveInteger									
properties	base xs:positiveInteger									
facets	<table border="1"> <thead> <tr> <th>Kind</th> <th>Value</th> <th>Annotation</th> </tr> </thead> <tbody> <tr> <td>minInclusive</td> <td>1</td> <td></td> </tr> <tr> <td>maxInclusive</td> <td>99</td> <td></td> </tr> </tbody> </table>	Kind	Value	Annotation	minInclusive	1		maxInclusive	99	
Kind	Value	Annotation								
minInclusive	1									
maxInclusive	99									
annotation	documentation Facette zur Festlegung der 2-stelligen Ganzzahlenwerte									
source	<pre> <simpleType name="Zahl2"> <annotation> <documentation>Facette zur Festlegung der 2-stelligen Ganzzahlenwerte</documentation> </annotation> <restriction base="xs:positiveInteger"> <minInclusive value="1"/> <maxInclusive value="99"/> </restriction> </simpleType> </pre>									

simpleType **Zahl2_1**

namespace	http://xml.ir-d.de/irdma															
type	restriction of decimal															
properties	base xs:decimal															
facets	<table border="1"> <thead> <tr> <th>Kind</th> <th>Value</th> <th>Annotation</th> </tr> </thead> <tbody> <tr> <td>minInclusive</td> <td>0.1</td> <td></td> </tr> <tr> <td>maxInclusive</td> <td>99.9</td> <td></td> </tr> <tr> <td>totalDigits</td> <td>3</td> <td></td> </tr> <tr> <td>fractionDigits</td> <td>1</td> <td></td> </tr> </tbody> </table>	Kind	Value	Annotation	minInclusive	0.1		maxInclusive	99.9		totalDigits	3		fractionDigits	1	
Kind	Value	Annotation														
minInclusive	0.1															
maxInclusive	99.9															
totalDigits	3															
fractionDigits	1															
annotation	documentation Facette zur Festlegung des Formats [NN].[N]															
source	<pre><simpleType name="Zahl2_1"> <annotation> <documentation>Facette zur Festlegung des Formats [NN].[N]</documentation> </annotation> <restriction base="xs:decimal"> <totalDigits value="3"/> <fractionDigits value="1"/> <minInclusive value="0.1"/> <maxInclusive value="99.9"/> </restriction> </simpleType></pre>															

simpleType **Zahl3**

namespace	http://xml.ir-d.de/irdma									
type	restriction of positiveInteger									
properties	base xs:positiveInteger									
facets	<table border="1"> <thead> <tr> <th>Kind</th> <th>Value</th> <th>Annotation</th> </tr> </thead> <tbody> <tr> <td>minInclusive</td> <td>1</td> <td></td> </tr> <tr> <td>maxInclusive</td> <td>999</td> <td></td> </tr> </tbody> </table>	Kind	Value	Annotation	minInclusive	1		maxInclusive	999	
Kind	Value	Annotation								
minInclusive	1									
maxInclusive	999									
annotation	documentation Facette zur Festlegung der 3-stelligen Ganzzahlenwerte									
source	<pre><simpleType name="Zahl3"> <annotation> <documentation>Facette zur Festlegung der 3-stelligen Ganzzahlenwerte</documentation> </annotation> <restriction base="xs:positiveInteger"> <minInclusive value="1"/> <maxInclusive value="999"/> </restriction> </simpleType></pre>									

simpleType **Zahl3_1**

namespace	http://xml.ir-d.de/irdma
type	restriction of decimal
properties	base xs:decimal

facets	<table border="1"> <thead> <tr> <th>Kind</th> <th>Value</th> <th>Annotation</th> </tr> </thead> <tbody> <tr> <td>minInclusive</td> <td>0.1</td> <td></td> </tr> <tr> <td>maxInclusive</td> <td>999.9</td> <td></td> </tr> <tr> <td>totalDigits</td> <td>4</td> <td></td> </tr> <tr> <td>fractionDigits</td> <td>1</td> <td></td> </tr> </tbody> </table>	Kind	Value	Annotation	minInclusive	0.1		maxInclusive	999.9		totalDigits	4		fractionDigits	1	
Kind	Value	Annotation														
minInclusive	0.1															
maxInclusive	999.9															
totalDigits	4															
fractionDigits	1															
annotation	documentation Facette zur Festlegung des Formats [NNN].[N]															
source	<pre><simpleType name="Zahl3_1"> <annotation> <documentation>Facette zur Festlegung des Formats [NNN].[N]</documentation> </annotation> <restriction base="xs:decimal"> <totalDigits value="4"/> <fractionDigits value="1"/> <minInclusive value="0.1"/> <maxInclusive value="999.9"/> </restriction> </simpleType></pre>															

simpleType **Zahl3mitNull**

namespace	http://xml.ir-d.de/irdma									
type	restriction of integer									
properties	base xs:integer									
facets	<table border="1"> <thead> <tr> <th>Kind</th> <th>Value</th> <th>Annotation</th> </tr> </thead> <tbody> <tr> <td>minInclusive</td> <td>0</td> <td></td> </tr> <tr> <td>maxInclusive</td> <td>999</td> <td></td> </tr> </tbody> </table>	Kind	Value	Annotation	minInclusive	0		maxInclusive	999	
Kind	Value	Annotation								
minInclusive	0									
maxInclusive	999									
annotation	documentation Facette zur Festlegung der 3-stelligen Ganzzahlenwerte inklusive "0"									
source	<pre><simpleType name="Zahl3mitNull"> <annotation> <documentation>Facette zur Festlegung der 3-stelligen Ganzzahlenwerte inklusive "0"</documentation> </annotation> <restriction base="xs:integer"> <minInclusive value="0"/> <maxInclusive value="999"/> </restriction> </simpleType></pre>									

simpleType **Zahl4**

namespace	http://xml.ir-d.de/irdma									
type	restriction of positiveInteger									
properties	base xs:positiveInteger									
facets	<table border="1"> <thead> <tr> <th>Kind</th> <th>Value</th> <th>Annotation</th> </tr> </thead> <tbody> <tr> <td>minInclusive</td> <td>1</td> <td></td> </tr> <tr> <td>maxInclusive</td> <td>9999</td> <td></td> </tr> </tbody> </table>	Kind	Value	Annotation	minInclusive	1		maxInclusive	9999	
Kind	Value	Annotation								
minInclusive	1									
maxInclusive	9999									
annotation	documentation Facette zur Festlegung der 4-stelligen Ganzzahlenwerte									

source	<pre><simpleType name="Zahl4"> <annotation> <documentation>Facette zur Festlegung der 4-stelligen Ganzzahlenwerte</documentation> </annotation> <restriction base="xs:positiveInteger"> <minInclusive value="1"/> <maxInclusive value="9999"/> </restriction> </simpleType></pre>
--------	---

simpleType Zahl5

namespace	http://xml.ir-d.de/irdma									
type	restriction of positiveInteger									
properties	base xs:positiveInteger									
facets	<table border="1"> <thead> <tr> <th>Kind</th> <th>Value</th> <th>Annotation</th> </tr> </thead> <tbody> <tr> <td>minInclusive</td> <td>1</td> <td></td> </tr> <tr> <td>maxInclusive</td> <td>99999</td> <td></td> </tr> </tbody> </table>	Kind	Value	Annotation	minInclusive	1		maxInclusive	99999	
Kind	Value	Annotation								
minInclusive	1									
maxInclusive	99999									
annotation	documentation Facette zur Festlegung der 5-stelligen Ganzzahlenwerte									
source	<pre><simpleType name="Zahl5"> <annotation> <documentation>Facette zur Festlegung der 5-stelligen Ganzzahlenwerte</documentation> </annotation> <restriction base="xs:positiveInteger"> <minInclusive value="1"/> <maxInclusive value="99999"/> </restriction> </simpleType></pre>									

simpleType Zahl5mitNull

namespace	http://xml.ir-d.de/irdma									
type	restriction of integer									
properties	base xs:integer									
facets	<table border="1"> <thead> <tr> <th>Kind</th> <th>Value</th> <th>Annotation</th> </tr> </thead> <tbody> <tr> <td>minInclusive</td> <td>0</td> <td></td> </tr> <tr> <td>maxInclusive</td> <td>99999</td> <td></td> </tr> </tbody> </table>	Kind	Value	Annotation	minInclusive	0		maxInclusive	99999	
Kind	Value	Annotation								
minInclusive	0									
maxInclusive	99999									
annotation	documentation Facette zur Festlegung der 5-stelligen Ganzzahlenwerte inklusive "0"									
source	<pre><simpleType name="Zahl5mitNull"> <annotation> <documentation>Facette zur Festlegung der 5-stelligen Ganzzahlenwerte inklusive "0"</documentation> </annotation> <restriction base="xs:integer"> <minInclusive value="0"/> <maxInclusive value="99999"/> </restriction> </simpleType></pre>									

complexType MeldungIrdBasis

diagram	
namespace	http://xml.ir-d.de/irdma
children	MEL_IrdIdGesundheitseinrichtung
used by	complexType MeldungIrd
source	<pre><complexType name="MeldungIrdBasis"> <sequence> <element name="MEL_IrdIdGesundheitseinrichtung" type="IdEinrichtung"/> </sequence> </complexType></pre>

element MeldungIrdBasis/MEL_IrdIdGesundheitseinrichtung

diagram							
type	IdEinrichtung						
properties	content simple						
facets	<table border="1"> <thead> <tr> <th>Kind</th> <th>Value</th> <th>Annotation</th> </tr> </thead> <tbody> <tr> <td>pattern</td> <td>(IRD-GE-[0-9]{8})</td> <td></td> </tr> </tbody> </table>	Kind	Value	Annotation	pattern	(IRD-GE-[0-9]{8})	
Kind	Value	Annotation					
pattern	(IRD-GE-[0-9]{8})						
source	<pre><element name="MEL_IrdIdGesundheitseinrichtung" type="IdEinrichtung"/></pre>						

complexType MeldungIrdFallBasis

diagram	
namespace	http://xml.ir-d.de/irdma
children	FAL_Transfernummer FAL_DatumZeitSatzErstellung
used by	element MeldungIrd/fall
source	<pre><complexType name="MeldungIrdFallBasis"> <sequence> <element name="FAL_Transfernummer" type="Transfernummer"/> <element name="FAL_DatumZeitSatzErstellung" type="xs:dateTime"/> </sequence> </complexType></pre>

element MeldungIrdFallBasis/FAL_Transfernummer

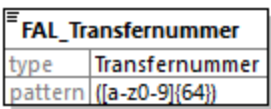
diagram	
type	Transfernummer
properties	content simple
facets	Kind Value Annotation pattern ([a-z0-9]{64})
source	<code><element name="FAL_Transfernummer" type="Transfernummer"/></code>

element MeldungIrdFallBasis/FAL_DatumZeitSatzErstellung

diagram	
type	dateTime
properties	content simple
source	<code><element name="FAL_DatumZeitSatzErstellung" type="xs:dateTime"/></code>

simpleType DatumText

namespace	http://xml.ir-d.de/irdsa
type	restriction of string
properties	base xs:string
facets	Kind Value Annotation pattern ((([0-9]{4})([0-9]{2})?([0-9]{2})?)?)
annotation	documentation Facette zur Festlegung des freien Datumformats: JJJJ[-MM[-TT]]
source	<pre><simpleType name="DatumText"> <annotation> <documentation>Facette zur Festlegung des freien Datumformats: JJJJ[-MM[-TT]]</documentation> </annotation> <restriction base="xs:string"> <pattern value="((([0-9]{4})([0-9]{2})?([0-9]{2})?)?)"/> </restriction> </simpleType></pre>

simpleType Freitext250

namespace	http://xml.ir-d.de/irdsa
type	restriction of string
properties	base xs:string
used by	element EmpfangsbestaetigungBasis/EBG_Empfangsbestaetigung
facets	Kind Value Annotation maxLength 250

annotation	documentation Facette zur Festlegung des Freitextes von 250 Zeichen
source	<pre><simpleType name="Freitext250"> <annotation> <documentation>Facette zur Festlegung des Freitextes von 250 Zeichen</documentation> </annotation> <restriction base="xs:string"> <maxLength value="250"/> </restriction> </simpleType></pre>

simpleType **Freitext500**

namespace	http://xml.ir-d.de/irdsa						
type	restriction of string						
properties	base xs:string						
used by	elements HinweisBasis/HNW Datenelement HinweisBasis/HNW Meldung HinweisBasis/HNW Wert						
facets	<table border="1"> <thead> <tr> <th>Kind</th> <th>Value</th> <th>Annotation</th> </tr> </thead> <tbody> <tr> <td>maxLength</td> <td>500</td> <td></td> </tr> </tbody> </table>	Kind	Value	Annotation	maxLength	500	
Kind	Value	Annotation					
maxLength	500						
annotation	documentation Facette zur Festlegung des Freitextes von 500 Zeichen						
source	<pre><simpleType name="Freitext500"> <annotation> <documentation>Facette zur Festlegung des Freitextes von 500 Zeichen</documentation> </annotation> <restriction base="xs:string"> <maxLength value="500"/> </restriction> </simpleType></pre>						

simpleType **HashString**

namespace	http://xml.ir-d.de/irdsa						
type	restriction of string						
properties	base xs:string						
facets	<table border="1"> <thead> <tr> <th>Kind</th> <th>Value</th> <th>Annotation</th> </tr> </thead> <tbody> <tr> <td>maxLength</td> <td>512</td> <td></td> </tr> </tbody> </table>	Kind	Value	Annotation	maxLength	512	
Kind	Value	Annotation					
maxLength	512						
annotation	documentation Facette zur Festlegung des Hash-Strings der Meldebestätigung						
source	<pre><simpleType name="HashString"> <annotation> <documentation>Facette zur Festlegung des Hash-Strings der Meldebestätigung</documentation> </annotation> <restriction base="xs:string"> <maxLength value="512"/> </restriction> </simpleType></pre>						

simpleType HashWert

namespace	http://xml.ir-d.de/irdsa						
type	restriction of string						
properties	base xs:string						
facets	<table border="1"> <thead> <tr> <th>Kind</th> <th>Value</th> <th>Annotation</th> </tr> </thead> <tbody> <tr> <td>length</td> <td>64</td> <td></td> </tr> </tbody> </table>	Kind	Value	Annotation	length	64	
Kind	Value	Annotation					
length	64						
annotation	documentation Facette zur Festlegung des Hashwertes der Meldebestätigung						
source	<pre> <simpleType name="HashWert"> <annotation> <documentation>Facette zur Festlegung des Hashwertes der Meldebestätigung</documentation> </annotation> <restriction base="xs:string"> <length value="64"/> </restriction> </simpleType> </pre>						

simpleType ICD

namespace	http://xml.ir-d.de/irdsa						
type	restriction of string						
properties	base xs:string						
facets	<table border="1"> <thead> <tr> <th>Kind</th> <th>Value</th> <th>Annotation</th> </tr> </thead> <tbody> <tr> <td>pattern</td> <td>([a-zA-Z][0-9]{2}(\.[0-9]{1,2})?(:[RLB])?)</td> <td></td> </tr> </tbody> </table>	Kind	Value	Annotation	pattern	([a-zA-Z][0-9]{2}(\.[0-9]{1,2})?(:[RLB])?)	
Kind	Value	Annotation					
pattern	([a-zA-Z][0-9]{2}(\.[0-9]{1,2})?(:[RLB])?)						
annotation	documentation Facette zur Festlegung des ICD Code						
source	<pre> <simpleType name="ICD"> <annotation> <documentation>Facette zur Festlegung des ICD Code</documentation> </annotation> <restriction base="xs:string"> <pattern value="([a-zA-Z][0-9]{2}(\.[0-9]{1,2})?(:[RLB])?)"/> </restriction> </simpleType> </pre>						

simpleType IdBsnr

namespace	http://xml.ir-d.de/irdsa						
type	restriction of string						
properties	base xs:string						
facets	<table border="1"> <thead> <tr> <th>Kind</th> <th>Value</th> <th>Annotation</th> </tr> </thead> <tbody> <tr> <td>length</td> <td>9</td> <td></td> </tr> </tbody> </table>	Kind	Value	Annotation	length	9	
Kind	Value	Annotation					
length	9						
annotation	documentation Facette zur Festlegung der Betriebsstättennummer						
source	<pre> <simpleType name="IdBsnr"> <annotation> <documentation>Facette zur Festlegung der Betriebsstättennummer</documentation> </annotation> <restriction base="xs:string"> <length value="9"/> </restriction> </simpleType> </pre>						

	<pre> </annotation> <restriction base="xs:string"> <length value="9"/> </restriction> </simpleType> </pre>
--	--

simpleType IdEinrichtung

namespace	http://xml.ir-d.de/irdsa						
type	restriction of string						
properties	base xs:string						
used by	element MeldungIrdBasis/MEL IrdIdGesundheitseinrichtung						
facets	<table border="1"> <thead> <tr> <th>Kind</th> <th>Value</th> <th>Annotation</th> </tr> </thead> <tbody> <tr> <td>pattern</td> <td>(IRD-GE-[0-9]{8})</td> <td></td> </tr> </tbody> </table>	Kind	Value	Annotation	pattern	(IRD-GE-[0-9]{8})	
Kind	Value	Annotation					
pattern	(IRD-GE-[0-9]{8})						
annotation	documentation Facette zur Festlegung der Gesundheitseinrichtung-ID						
source	<pre> <simpleType name="IdEinrichtung"> <annotation> <documentation>Facette zur Festlegung der Gesundheitseinrichtung- ID</documentation> </annotation> <restriction base="xs:string"> <pattern value="(IRD-GE-[0-9]{8})"/> </restriction> </simpleType> </pre>						

simpleType IdStandort

namespace	http://xml.ir-d.de/irdsa						
type	restriction of string						
properties	base xs:string						
facets	<table border="1"> <thead> <tr> <th>Kind</th> <th>Value</th> <th>Annotation</th> </tr> </thead> <tbody> <tr> <td>length</td> <td>6</td> <td></td> </tr> </tbody> </table>	Kind	Value	Annotation	length	6	
Kind	Value	Annotation					
length	6						
annotation	documentation Facette zur Festlegung der Standort-ID						
source	<pre> <simpleType name="IdStandort"> <annotation> <documentation>Facette zur Festlegung der Standort-ID</documentation> </annotation> <restriction base="xs:string"> <length value="6"/> </restriction> </simpleType> </pre>						

simpleType IrdArtikeld

namespace	http://xml.ir-d.de/irdsa
type	restriction of string
properties	base xs:string

facets	Kind Value Annotation maxLength 16
annotation	documentation Facette zur Festlegung der IrdNummer
source	<pre><simpleType name="IrdArtikelId"> <annotation> <documentation>Facette zur Festlegung der IrdNummer</documentation> </annotation> <restriction base="xs:string"> <maxLength value="16"/> </restriction> </simpleType></pre>

simpleType IrdSpezVersion

namespace	http://xml.ir-d.de/irdsa
type	restriction of string
properties	base xs:string
facets	Kind Value Annotation pattern (([1-9][1-9][0-9])\.\d{1-9}[0-9])\.\d{1-9}[0-9])
annotation	documentation Facette zur Festlegung der Version der IRD-Spezifikation
source	<pre><simpleType name="IrdSpezVersion"> <annotation> <documentation>Facette zur Festlegung der Version der IRD- Spezifikation</documentation> </annotation> <restriction base="xs:string"> <pattern value="(([1-9][1-9][0-9])\.\d{1-9}[0-9])\.\d{1-9}[0-9]"/> </restriction> </simpleType></pre>

simpleType JaLeer

namespace	http://xml.ir-d.de/irdsa
type	restriction of integer
properties	base xs:integer
facets	Kind Value Annotation pattern (1)
annotation	documentation Facette zur Festlegung des Unbekannt-Wertes (Bedeutung 1=true)
source	<pre><simpleType name="JaLeer"> <annotation> <documentation>Facette zur Festlegung des Unbekannt-Wertes (Bedeutung 1=true)</documentation> </annotation> <restriction base="xs:integer"> <pattern value="(1)"/> </restriction> </simpleType></pre>

simpleType **Meldebestaetigung**

namespace	http://xml.ir-d.de/irdsa						
type	restriction of string						
properties	base xs:string						
facets	<table border="1"> <thead> <tr> <th>Kind</th> <th>Value</th> <th>Annotation</th> </tr> </thead> <tbody> <tr> <td>length</td> <td>10</td> <td></td> </tr> </tbody> </table>	Kind	Value	Annotation	length	10	
Kind	Value	Annotation					
length	10						
annotation	documentation Facette zur Festlegung der Meldebestätigungslaenge von 10 Zeichen						
source	<pre> <simpleType name="Meldebestaetigung"> <annotation> <documentation>Facette zur Festlegung der Meldebestätigungslaenge von 10 Zeichen</documentation> </annotation> <restriction base="xs:string"> <length value="10"/> </restriction> </simpleType> </pre>						

simpleType **OPS**

namespace	http://xml.ir-d.de/irdsa						
type	restriction of string						
properties	base xs:string						
facets	<table border="1"> <thead> <tr> <th>Kind</th> <th>Value</th> <th>Annotation</th> </tr> </thead> <tbody> <tr> <td>pattern</td> <td>(([135689]\-([0-9]){2}([a-zA-Z0-9]){1}\.([a-zA-Z0-9]{1,2}))*(:[RLB])?)</td> <td></td> </tr> </tbody> </table>	Kind	Value	Annotation	pattern	(([135689]\-([0-9]){2}([a-zA-Z0-9]){1}\.([a-zA-Z0-9]{1,2}))*(:[RLB])?)	
Kind	Value	Annotation					
pattern	(([135689]\-([0-9]){2}([a-zA-Z0-9]){1}\.([a-zA-Z0-9]{1,2}))*(:[RLB])?)						
annotation	documentation Facette zur Festlegung des Prozedurenschluessels						
source	<pre> <simpleType name="OPS"> <annotation> <documentation>Facette zur Festlegung des Prozedurenschluessels</documentation> </annotation> <restriction base="xs:string"> <pattern value="([135689]\-([0-9]){2}([a-zA-Z0-9]){1}\.([a-zA-Z0- 9]{1,2}))*(:[RLB])?" /> </restriction> </simpleType> </pre>						

simpleType **String2**

namespace	http://xml.ir-d.de/irdsa						
type	restriction of string						
properties	base xs:string						
facets	<table border="1"> <thead> <tr> <th>Kind</th> <th>Value</th> <th>Annotation</th> </tr> </thead> <tbody> <tr> <td>pattern</td> <td>([0-9]{2})</td> <td></td> </tr> </tbody> </table>	Kind	Value	Annotation	pattern	([0-9]{2})	
Kind	Value	Annotation					
pattern	([0-9]{2})						
annotation	documentation Facette zur Festlegung des kodierten Entlassungsgrundes						
source	<pre> <simpleType name="String2"> <annotation> <documentation>Facette zur Festlegung des kodierten Entlassungsgrundes</documentation> </annotation> <restriction base="xs:string"> <pattern value="[0-9]{2}" /> </restriction> </simpleType> </pre>						

	<pre> </annotation> <restriction base="xs:string"> <pattern value="([0-9]{2})"/> </restriction> </simpleType> </pre>
--	--

simpleType **String20**

namespace	http://xml.ir-d.de/irdsa						
type	restriction of string						
properties	base xs:string						
facets	<table border="1"> <thead> <tr> <th>Kind</th> <th>Value</th> <th>Annotation</th> </tr> </thead> <tbody> <tr> <td>maxLength</td> <td>20</td> <td></td> </tr> </tbody> </table>	Kind	Value	Annotation	maxLength	20	
Kind	Value	Annotation					
maxLength	20						
annotation	documentation Facette zur Festlegung von: Artikel-, Ident-, Serien-, Lot-Nummer des Produkts						
source	<pre> <simpleType name="String20"> <annotation> <documentation>Facette zur Festlegung von: Artikel-, Ident-, Serien-, Lot-Nummer des Produkts</documentation> </annotation> <restriction base="xs:string"> <maxLength value="20"/> </restriction> </simpleType> </pre>						

simpleType **String7**

namespace	http://xml.ir-d.de/irdsa						
type	restriction of string						
properties	base xs:string						
facets	<table border="1"> <thead> <tr> <th>Kind</th> <th>Value</th> <th>Annotation</th> </tr> </thead> <tbody> <tr> <td>pattern</td> <td>([0-9]{7})</td> <td></td> </tr> </tbody> </table>	Kind	Value	Annotation	pattern	([0-9]{7})	
Kind	Value	Annotation					
pattern	([0-9]{7})						
annotation	documentation Facette zur Festlegung eines Katalogkodes						
source	<pre> <simpleType name="String7"> <annotation> <documentation>Facette zur Festlegung eines Katalogkodes</documentation> </annotation> <restriction base="xs:string"> <pattern value="([0-9]{7})"/> </restriction> </simpleType> </pre>						

simpleType **Sw**

namespace	http://xml.ir-d.de/irdsa						
type	restriction of string						
properties	base xs:string						
facets	<table border="1"> <thead> <tr> <th>Kind</th> <th>Value</th> <th>Annotation</th> </tr> </thead> <tbody> <tr> <td>maxLength</td> <td>120</td> <td></td> </tr> </tbody> </table>	Kind	Value	Annotation	maxLength	120	
Kind	Value	Annotation					
maxLength	120						

annotation	documentation Facette für Merkmale der externen Software
source	<pre> <simpleType name="Sw"> <annotation> <documentation>Facette für Merkmale der externen Software</documentation> </annotation> <restriction base="xs:string"> <maxLength value="120"/> </restriction> </simpleType> </pre>

simpleType **Transfervummer**

namespace	http://xml.ir-d.de/irdsa						
type	restriction of string						
properties	base xs:string						
used by	element StornoFallBasis/FAL Transfervummer						
facets	<table border="1"> <thead> <tr> <th>Kind</th> <th>Value</th> <th>Annotation</th> </tr> </thead> <tbody> <tr> <td>pattern</td> <td>([a-z0-9]{64})</td> <td></td> </tr> </tbody> </table>	Kind	Value	Annotation	pattern	([a-z0-9]{64})	
Kind	Value	Annotation					
pattern	([a-z0-9]{64})						
annotation	documentation Facette zur Festlegung der Transfervummer						
source	<pre> <simpleType name="Transfervummer"> <annotation> <documentation>Facette zur Festlegung der Transfervummer</documentation> </annotation> <restriction base="xs:string"> <pattern value="([a-z0-9]{64})"/> </restriction> </simpleType> </pre>						

simpleType **Versionsnummer**

namespace	http://xml.ir-d.de/irdsa						
type	restriction of string						
properties	base xs:string						
facets	<table border="1"> <thead> <tr> <th>Kind</th> <th>Value</th> <th>Annotation</th> </tr> </thead> <tbody> <tr> <td>maxLength</td> <td>10</td> <td></td> </tr> </tbody> </table>	Kind	Value	Annotation	maxLength	10	
Kind	Value	Annotation					
maxLength	10						
annotation	documentation Facette zur Festlegung der Versionsnummer des gelieferten Datensatzes						
source	<pre> <simpleType name="Versionsnummer"> <annotation> <documentation>Facette zur Festlegung der Versionsnummer des gelieferten Datensatzes</documentation> </annotation> <restriction base="xs:string"> <maxLength value="10"/> </restriction> </simpleType> </pre>						

simpleType Zahl1

namespace	http://xml.ir-d.de/irdsa									
type	restriction of positiveInteger									
properties	base xs:positiveInteger									
facets	<table border="1"> <thead> <tr> <th>Kind</th> <th>Value</th> <th>Annotation</th> </tr> </thead> <tbody> <tr> <td>minInclusive</td> <td>1</td> <td></td> </tr> <tr> <td>maxInclusive</td> <td>9</td> <td></td> </tr> </tbody> </table>	Kind	Value	Annotation	minInclusive	1		maxInclusive	9	
Kind	Value	Annotation								
minInclusive	1									
maxInclusive	9									
annotation	documentation Facette zur Festlegung der 1-stelligen Ganzzahlenwerte									
source	<pre> <simpleType name="Zahl1"> <annotation> <documentation>Facette zur Festlegung der 1-stelligen Ganzzahlenwerte</documentation> </annotation> <restriction base="xs:positiveInteger"> <minInclusive value="1"/> <maxInclusive value="9"/> </restriction> </simpleType> </pre>									

simpleType Zahl1_1

namespace	http://xml.ir-d.de/irdsa															
type	restriction of decimal															
properties	base xs:decimal															
facets	<table border="1"> <thead> <tr> <th>Kind</th> <th>Value</th> <th>Annotation</th> </tr> </thead> <tbody> <tr> <td>minInclusive</td> <td>0.1</td> <td></td> </tr> <tr> <td>maxInclusive</td> <td>9.9</td> <td></td> </tr> <tr> <td>totalDigits</td> <td>2</td> <td></td> </tr> <tr> <td>fractionDigits</td> <td>1</td> <td></td> </tr> </tbody> </table>	Kind	Value	Annotation	minInclusive	0.1		maxInclusive	9.9		totalDigits	2		fractionDigits	1	
Kind	Value	Annotation														
minInclusive	0.1															
maxInclusive	9.9															
totalDigits	2															
fractionDigits	1															
annotation	documentation Facette zur Festlegung des Formats [N].[N]															
source	<pre> <simpleType name="Zahl1_1"> <annotation> <documentation>Facette zur Festlegung des Formats [N].[N]</documentation> </annotation> <restriction base="xs:decimal"> <totalDigits value="2"/> <fractionDigits value="1"/> <minInclusive value="0.1"/> <maxInclusive value="9.9"/> </restriction> </simpleType> </pre>															

simpleType Zahl2

namespace	http://xml.ir-d.de/irdsa			
type	restriction of positiveInteger			
properties	base xs:positiveInteger			
facets	<table border="1"> <thead> <tr> <th>Kind</th> <th>Value</th> <th>Annotation</th> </tr> </thead> <tbody> </tbody> </table>	Kind	Value	Annotation
Kind	Value	Annotation		

	minInclusive 1 maxInclusive 99
annotation	documentation Facette zur Festlegung der 2-stelligen Ganzzahlenwerte
source	<pre><simpleType name="Zahl2"> <annotation> <documentation>Facette zur Festlegung der 2-stelligen Ganzzahlenwerte</documentation> </annotation> <restriction base="xs:positiveInteger"> <minInclusive value="1"/> <maxInclusive value="99"/> </restriction> </simpleType></pre>

simpleType Zahl2_1

namespace	http://xml.ir-d.de/irdsa															
type	restriction of decimal															
properties	base xs:decimal															
facets	<table border="1"> <thead> <tr> <th>Kind</th> <th>Value</th> <th>Annotation</th> </tr> </thead> <tbody> <tr> <td>minInclusive</td> <td>0.1</td> <td></td> </tr> <tr> <td>maxInclusive</td> <td>99.9</td> <td></td> </tr> <tr> <td>totalDigits</td> <td>3</td> <td></td> </tr> <tr> <td>fractionDigits</td> <td>1</td> <td></td> </tr> </tbody> </table>	Kind	Value	Annotation	minInclusive	0.1		maxInclusive	99.9		totalDigits	3		fractionDigits	1	
Kind	Value	Annotation														
minInclusive	0.1															
maxInclusive	99.9															
totalDigits	3															
fractionDigits	1															
annotation	documentation Facette zur Festlegung des Formats [NN].[N]															
source	<pre><simpleType name="Zahl2_1"> <annotation> <documentation>Facette zur Festlegung des Formats [NN].[N]</documentation> </annotation> <restriction base="xs:decimal"> <totalDigits value="3"/> <fractionDigits value="1"/> <minInclusive value="0.1"/> <maxInclusive value="99.9"/> </restriction> </simpleType></pre>															

simpleType Zahl3

namespace	http://xml.ir-d.de/irdsa									
type	restriction of positiveInteger									
properties	base xs:positiveInteger									
facets	<table border="1"> <thead> <tr> <th>Kind</th> <th>Value</th> <th>Annotation</th> </tr> </thead> <tbody> <tr> <td>minInclusive</td> <td>1</td> <td></td> </tr> <tr> <td>maxInclusive</td> <td>999</td> <td></td> </tr> </tbody> </table>	Kind	Value	Annotation	minInclusive	1		maxInclusive	999	
Kind	Value	Annotation								
minInclusive	1									
maxInclusive	999									
annotation	documentation Facette zur Festlegung der 3-stelligen Ganzzahlenwerte									
source	<pre><simpleType name="Zahl3"> <annotation></pre>									

	<pre> <documentation>Facette zur Festlegung der 3-stelligen Ganzzahlenwerte</documentation> </annotation> <restriction base="xs:positiveInteger"> <minInclusive value="1"/> <maxInclusive value="999"/> </restriction> </simpleType> </pre>
--	---

simpleType **Zahl3_1**

namespace	http://xml.ir-d.de/irdsa															
type	restriction of decimal															
properties	base xs:decimal															
facets	<table border="1"> <thead> <tr> <th>Kind</th> <th>Value</th> <th>Annotation</th> </tr> </thead> <tbody> <tr> <td>minInclusive</td> <td>0.1</td> <td></td> </tr> <tr> <td>maxInclusive</td> <td>999.9</td> <td></td> </tr> <tr> <td>totalDigits</td> <td>4</td> <td></td> </tr> <tr> <td>fractionDigits</td> <td>1</td> <td></td> </tr> </tbody> </table>	Kind	Value	Annotation	minInclusive	0.1		maxInclusive	999.9		totalDigits	4		fractionDigits	1	
Kind	Value	Annotation														
minInclusive	0.1															
maxInclusive	999.9															
totalDigits	4															
fractionDigits	1															
annotation	documentation Facette zur Festlegung des Formats [NNN].[N]															
source	<pre> <simpleType name="Zahl3_1"> <annotation> <documentation>Facette zur Festlegung des Formats [NNN].[N]</documentation> </annotation> <restriction base="xs:decimal"> <totalDigits value="4"/> <fractionDigits value="1"/> <minInclusive value="0.1"/> <maxInclusive value="999.9"/> </restriction> </simpleType> </pre>															

simpleType **Zahl3mitNull**

namespace	http://xml.ir-d.de/irdsa									
type	restriction of integer									
properties	base xs:integer									
facets	<table border="1"> <thead> <tr> <th>Kind</th> <th>Value</th> <th>Annotation</th> </tr> </thead> <tbody> <tr> <td>minInclusive</td> <td>0</td> <td></td> </tr> <tr> <td>maxInclusive</td> <td>999</td> <td></td> </tr> </tbody> </table>	Kind	Value	Annotation	minInclusive	0		maxInclusive	999	
Kind	Value	Annotation								
minInclusive	0									
maxInclusive	999									
annotation	documentation Facette zur Festlegung der 3-stelligen Ganzzahlenwerte inklusive "0"									
source	<pre> <simpleType name="Zahl3mitNull"> <annotation> <documentation>Facette zur Festlegung der 3-stelligen Ganzzahlenwerte inklusive "0"</documentation> </annotation> <restriction base="xs:integer"> <minInclusive value="0"/> <maxInclusive value="999"/> </restriction> </simpleType> </pre>									

	<pre> </restriction> </simpleType> </pre>
--	---

simpleType Zahl4

namespace	http://xml.ir-d.de/irdsa									
type	restriction of positivelnteger									
properties	base xs:positivelnteger									
facets	<table border="1"> <thead> <tr> <th>Kind</th> <th>Value</th> <th>Annotation</th> </tr> </thead> <tbody> <tr> <td>minInclusive</td> <td>1</td> <td></td> </tr> <tr> <td>maxInclusive</td> <td>9999</td> <td></td> </tr> </tbody> </table>	Kind	Value	Annotation	minInclusive	1		maxInclusive	9999	
Kind	Value	Annotation								
minInclusive	1									
maxInclusive	9999									
annotation	documentation Facette zur Festlegung der 4-stelligen Ganzzahlenwerte									
source	<pre> <simpleType name="Zahl4"> <annotation> <documentation>Facette zur Festlegung der 4-stelligen Ganzzahlenwerte</documentation> </annotation> <restriction base="xs:positiveInteger"> <minInclusive value="1"/> <maxInclusive value="9999"/> </restriction> </simpleType> </pre>									

simpleType Zahl5

namespace	http://xml.ir-d.de/irdsa									
type	restriction of positivelnteger									
properties	base xs:positivelnteger									
facets	<table border="1"> <thead> <tr> <th>Kind</th> <th>Value</th> <th>Annotation</th> </tr> </thead> <tbody> <tr> <td>minInclusive</td> <td>1</td> <td></td> </tr> <tr> <td>maxInclusive</td> <td>99999</td> <td></td> </tr> </tbody> </table>	Kind	Value	Annotation	minInclusive	1		maxInclusive	99999	
Kind	Value	Annotation								
minInclusive	1									
maxInclusive	99999									
annotation	documentation Facette zur Festlegung der 5-stelligen Ganzzahlenwerte									
source	<pre> <simpleType name="Zahl5"> <annotation> <documentation>Facette zur Festlegung der 5-stelligen Ganzzahlenwerte</documentation> </annotation> <restriction base="xs:positiveInteger"> <minInclusive value="1"/> <maxInclusive value="99999"/> </restriction> </simpleType> </pre>									

simpleType Zahl5mitNull

namespace	http://xml.ir-d.de/irdsa
type	restriction of integer
properties	base xs:integer

facets	Kind Value Annotation minInclusive 0 maxInclusive 99999
annotation	documentation Facette zur Festlegung der 5-stelligen Ganzzahlenwerte inklusive "0"
source	<pre> <simpleType name="Zahl5mitNull"> <annotation> <documentation>Facette zur Festlegung der 5-stelligen Ganzzahlenwerte inklusive "0"</documentation> </annotation> <restriction base="xs:integer"> <minInclusive value="0"/> <maxInclusive value="99999"/> </restriction> </simpleType> </pre>

complexType MeldungIrdBasis

diagram	
namespace	http://xml.ir-d.de/irdsa
children	MEL_IrdIdGesundheitseinrichtung
used by	complexType Storno
source	<pre> <complexType name="MeldungIrdBasis"> <sequence> <element name="MEL_IrdIdGesundheitseinrichtung" type="IdEinrichtung"/> </sequence> </complexType> </pre>

element MeldungIrdBasis/MEL_IrdIdGesundheitseinrichtung

diagram	
type	IdEinrichtung
properties	content simple
facets	Kind Value Annotation pattern (IRD-GE-[0-9]{8})
source	<pre> <element name="MEL_IrdIdGesundheitseinrichtung" type="IdEinrichtung"/> </pre>

complexType **StornoFallBasis**

diagram	
namespace	http://xml.ir-d.de/irdsa
children	FAL Transfernummer FAL Aufnahmedatum
used by	element Storno/fall
source	<pre><complexType name="StornoFallBasis"> <sequence> <element name="FAL_Transfernummer" type="Transfervummer"/> <element name="FAL_Aufnahmedatum" type="xs:date"/> </sequence> </complexType></pre>

element **StornoFallBasis/FAL_Transfernummer**

diagram							
type	Transfervummer						
properties	content simple						
facets	<table border="1"> <thead> <tr> <th>Kind</th> <th>Value</th> <th>Annotation</th> </tr> </thead> <tbody> <tr> <td>pattern</td> <td>([a-z0-9]{64})</td> <td></td> </tr> </tbody> </table>	Kind	Value	Annotation	pattern	([a-z0-9]{64})	
Kind	Value	Annotation					
pattern	([a-z0-9]{64})						
source	<pre><element name="FAL_Transfernummer" type="Transfervummer"/></pre>						

element **StornoFallBasis/FAL_Aufnahmedatum**

diagram	
type	date
properties	content simple
source	<pre><element name="FAL_Aufnahmedatum" type="xs:date"/></pre>

simpleType **DatumText**

namespace	http://xml.ir-d.de/sak						
type	restriction of string						
properties	base xs:string						
facets	<table border="1"> <thead> <tr> <th>Kind</th> <th>Value</th> <th>Annotation</th> </tr> </thead> <tbody> <tr> <td>pattern</td> <td>(([0-9]{4})([0-9]{2})?([0-9]{2})?)</td> <td></td> </tr> </tbody> </table>	Kind	Value	Annotation	pattern	(([0-9]{4})([0-9]{2})?([0-9]{2})?)	
Kind	Value	Annotation					
pattern	(([0-9]{4})([0-9]{2})?([0-9]{2})?)						

annotation	documentation Facette zur Festlegung des freien Datumformats: JJJ[-MM[-TT]]
source	<pre><simpleType name="DatumText"> <annotation> <documentation>Facette zur Festlegung des freien Datumformats: JJJ[-MM[-TT]]</documentation> </annotation> <restriction base="xs:string"> <pattern value="(([\0-9]{4})([-][\0-9]{2})?([-][\0-9]{2})?)"/> </restriction> </simpleType></pre>

simpleType **Freitext250**

namespace	http://xml.ir-d.de/sak						
type	restriction of string						
properties	base xs:string						
facets	<table border="1"> <thead> <tr> <th>Kind</th> <th>Value</th> <th>Annotation</th> </tr> </thead> <tbody> <tr> <td>maxLength</td> <td>250</td> <td></td> </tr> </tbody> </table>	Kind	Value	Annotation	maxLength	250	
Kind	Value	Annotation					
maxLength	250						
annotation	documentation Facette zur Festlegung des Freitextes von 250 Zeichen						
source	<pre><simpleType name="Freitext250"> <annotation> <documentation>Facette zur Festlegung des Freitextes von 250 Zeichen</documentation> </annotation> <restriction base="xs:string"> <maxLength value="250"/> </restriction> </simpleType></pre>						

simpleType **Freitext500**

namespace	http://xml.ir-d.de/sak						
type	restriction of string						
properties	base xs:string						
facets	<table border="1"> <thead> <tr> <th>Kind</th> <th>Value</th> <th>Annotation</th> </tr> </thead> <tbody> <tr> <td>maxLength</td> <td>500</td> <td></td> </tr> </tbody> </table>	Kind	Value	Annotation	maxLength	500	
Kind	Value	Annotation					
maxLength	500						
annotation	documentation Facette zur Festlegung des Freitextes von 500 Zeichen						
source	<pre><simpleType name="Freitext500"> <annotation> <documentation>Facette zur Festlegung des Freitextes von 500 Zeichen</documentation> </annotation> <restriction base="xs:string"> <maxLength value="500"/> </restriction> </simpleType></pre>						

simpleType HashString

namespace	http://xml.ir-d.de/sak						
type	restriction of string						
properties	base xs:string						
facets	<table border="1"> <thead> <tr> <th>Kind</th> <th>Value</th> <th>Annotation</th> </tr> </thead> <tbody> <tr> <td>maxLength</td> <td>512</td> <td></td> </tr> </tbody> </table>	Kind	Value	Annotation	maxLength	512	
Kind	Value	Annotation					
maxLength	512						
annotation	documentation Facette zur Festlegung des Hash-Strings der Meldebestätigung						
source	<pre> <simpleType name="HashString"> <annotation> <documentation>Facette zur Festlegung des Hash-Strings der Meldebestätigung</documentation> </annotation> <restriction base="xs:string"> <maxLength value="512"/> </restriction> </simpleType> </pre>						

simpleType HashWert

namespace	http://xml.ir-d.de/sak						
type	restriction of string						
properties	base xs:string						
facets	<table border="1"> <thead> <tr> <th>Kind</th> <th>Value</th> <th>Annotation</th> </tr> </thead> <tbody> <tr> <td>length</td> <td>64</td> <td></td> </tr> </tbody> </table>	Kind	Value	Annotation	length	64	
Kind	Value	Annotation					
length	64						
annotation	documentation Facette zur Festlegung des Hashwertes der Meldebestätigung						
source	<pre> <simpleType name="HashWert"> <annotation> <documentation>Facette zur Festlegung des Hashwertes der Meldebestätigung</documentation> </annotation> <restriction base="xs:string"> <length value="64"/> </restriction> </simpleType> </pre>						

simpleType ICD

namespace	http://xml.ir-d.de/sak						
type	restriction of string						
properties	base xs:string						
facets	<table border="1"> <thead> <tr> <th>Kind</th> <th>Value</th> <th>Annotation</th> </tr> </thead> <tbody> <tr> <td>pattern</td> <td> $[a-zA-Z][0-9]{2}(\.[0-9]{1,2})?([RLB])?$ </td> <td></td> </tr> </tbody> </table>	Kind	Value	Annotation	pattern	$[a-zA-Z][0-9]{2}(\.[0-9]{1,2})?([RLB])?$	
Kind	Value	Annotation					
pattern	$[a-zA-Z][0-9]{2}(\.[0-9]{1,2})?([RLB])?$						
annotation	documentation Facette zur Festlegung des ICD Code						
source	<pre> <simpleType name="ICD"> <annotation> <documentation>Facette zur Festlegung des ICD Code</documentation> </annotation> <restriction base="xs:string"> </pre>						

	<pre> <pattern value="([a-zA-Z][0-9]{2}(\.[0-9]{1,2})?([RLB])?)"/> </restriction> </simpleType> </pre>
--	--

simpleType IdBsnr

namespace	http://xml.ir-d.de/sak						
type	restriction of string						
properties	base xs:string						
facets	<table border="1"> <tr> <th>Kind</th> <th>Value</th> <th>Annotation</th> </tr> <tr> <td>length</td> <td>9</td> <td></td> </tr> </table>	Kind	Value	Annotation	length	9	
Kind	Value	Annotation					
length	9						
annotation	documentation Facette zur Festlegung der Betriebsstättennummer						
source	<pre> <simpleType name="IdBsnr"> <annotation> <documentation>Facette zur Festlegung der Betriebsstättennummer</documentation> </annotation> <restriction base="xs:string"> <length value="9"/> </restriction> </simpleType> </pre>						

simpleType IdEinrichtung

namespace	http://xml.ir-d.de/sak						
type	restriction of string						
properties	base xs:string						
used by	element MeldungIrdBasis/MEL_IrdIdGesundheitseinrichtung						
facets	<table border="1"> <tr> <th>Kind</th> <th>Value</th> <th>Annotation</th> </tr> <tr> <td>pattern</td> <td>(IRD-GE-[0-9]{8})</td> <td></td> </tr> </table>	Kind	Value	Annotation	pattern	(IRD-GE-[0-9]{8})	
Kind	Value	Annotation					
pattern	(IRD-GE-[0-9]{8})						
annotation	documentation Facette zur Festlegung der Gesundheitseinrichtung-ID						
source	<pre> <simpleType name="IdEinrichtung"> <annotation> <documentation>Facette zur Festlegung der Gesundheitseinrichtung- ID</documentation> </annotation> <restriction base="xs:string"> <pattern value="(IRD-GE-[0-9]{8})"/> </restriction> </simpleType> </pre>						

simpleType IdStandort

namespace	http://xml.ir-d.de/sak						
type	restriction of string						
properties	base xs:string						
facets	<table border="1"> <tr> <th>Kind</th> <th>Value</th> <th>Annotation</th> </tr> <tr> <td>length</td> <td>6</td> <td></td> </tr> </table>	Kind	Value	Annotation	length	6	
Kind	Value	Annotation					
length	6						

annotation	documentation Facette zur Festlegung der Standort-ID
source	<pre><simpleType name="IdStandort"> <annotation> <documentation>Facette zur Festlegung der Standort-ID</documentation> </annotation> <restriction base="xs:string"> <length value="6"/> </restriction> </simpleType></pre>

simpleType IrdArtikelId

namespace	http://xml.ir-d.de/sak						
type	restriction of string						
properties	base xs:string						
facets	<table border="1"> <thead> <tr> <th>Kind</th> <th>Value</th> <th>Annotation</th> </tr> </thead> <tbody> <tr> <td>maxLength</td> <td>16</td> <td></td> </tr> </tbody> </table>	Kind	Value	Annotation	maxLength	16	
Kind	Value	Annotation					
maxLength	16						
annotation	documentation Facette zur Festlegung der IrdNummer						
source	<pre><simpleType name="IrdArtikelId"> <annotation> <documentation>Facette zur Festlegung der IrdNummer</documentation> </annotation> <restriction base="xs:string"> <maxLength value="16"/> </restriction> </simpleType></pre>						

simpleType IrdSpezVersion

namespace	http://xml.ir-d.de/sak						
type	restriction of string						
properties	base xs:string						
facets	<table border="1"> <thead> <tr> <th>Kind</th> <th>Value</th> <th>Annotation</th> </tr> </thead> <tbody> <tr> <td>pattern</td> <td>(([1-9] [1-9][0-9])\.\d{1}[0-9])\.\d{1}[0-9])</td> <td></td> </tr> </tbody> </table>	Kind	Value	Annotation	pattern	(([1-9] [1-9][0-9])\.\d{1}[0-9])\.\d{1}[0-9])	
Kind	Value	Annotation					
pattern	(([1-9] [1-9][0-9])\.\d{1}[0-9])\.\d{1}[0-9])						
annotation	documentation Facette zur Festlegung der Version der IRD-Spezifikation						
source	<pre><simpleType name="IrdSpezVersion"> <annotation> <documentation>Facette zur Festlegung der Version der IRD- Spezifikation</documentation> </annotation> <restriction base="xs:string"> <pattern value="(([1-9] [1-9][0-9])\.\d{1}[0-9])\.\d{1}[0-9]"/> </restriction> </simpleType></pre>						

simpleType JaLeer

namespace	http://xml.ir-d.de/sak
-----------	------------------------

type	restriction of integer
properties	base xs:integer
facets	Kind Value Annotation pattern (1)
annotation	documentation Facette zur Festlegung des Unbekannt-Wertes (Bedeutung 1=true)
source	<pre><simpleType name="JaLeer"> <annotation> <documentation>Facette zur Festlegung des Unbekannt-Wertes (Bedeutung 1=true)</documentation> </annotation> <restriction base="xs:integer"> <pattern value="(1)"/> </restriction> </simpleType></pre>

simpleType **Meldebestaetigung**

namespace	http://xml.ir-d.de/sak
type	restriction of string
properties	base xs:string
facets	Kind Value Annotation length 10
annotation	documentation Facette zur Festlegung der Meldebestätigungslaenge von 10 Zeichen
source	<pre><simpleType name="Meldebestaetigung"> <annotation> <documentation>Facette zur Festlegung der Meldebestätigungslaenge von 10 Zeichen</documentation> </annotation> <restriction base="xs:string"> <length value="10"/> </restriction> </simpleType></pre>

simpleType **OPS**

namespace	http://xml.ir-d.de/sak
type	restriction of string
properties	base xs:string
facets	Kind Value Annotation pattern ([135689]\-([0-9]){2}([a-zA-Z0-9]){1}\.([a-zA-Z0-9]{1,2})*(:[RLB])?)
annotation	documentation Facette zur Festlegung des Prozedurenschluessels
source	<pre><simpleType name="OPS"> <annotation> <documentation>Facette zur Festlegung des Prozedurenschluessels</documentation> </annotation> <restriction base="xs:string"> <pattern value="([135689]\-([0-9]){2}([a-zA-Z0-9]){1}\.([a-zA-Z0-</pre>

	<pre>9]{1,2}))*(:[RLB])?)" /> </restriction> </simpleType></pre>
--	---

simpleType **String2**

namespace	http://xml.ir-d.de/sak						
type	restriction of string						
properties	base xs:string						
facets	<table border="1"> <thead> <tr> <th>Kind</th> <th>Value</th> <th>Annotation</th> </tr> </thead> <tbody> <tr> <td>pattern</td> <td>([0-9]{2})</td> <td></td> </tr> </tbody> </table>	Kind	Value	Annotation	pattern	([0-9]{2})	
Kind	Value	Annotation					
pattern	([0-9]{2})						
annotation	documentation Facette zur Festlegung des kodierten Entlassungsgrundes						
source	<pre><simpleType name="String2"> <annotation> <documentation>Facette zur Festlegung des kodierten Entlassungsgrundes</documentation> </annotation> <restriction base="xs:string"> <pattern value="([0-9]{2})" /> </restriction> </simpleType></pre>						

simpleType **String20**

namespace	http://xml.ir-d.de/sak						
type	restriction of string						
properties	base xs:string						
facets	<table border="1"> <thead> <tr> <th>Kind</th> <th>Value</th> <th>Annotation</th> </tr> </thead> <tbody> <tr> <td>maxLength</td> <td>20</td> <td></td> </tr> </tbody> </table>	Kind	Value	Annotation	maxLength	20	
Kind	Value	Annotation					
maxLength	20						
annotation	documentation Facette zur Festlegung von: Artikel-, Ident-, Serien-, Lot-Nummer des Produkts						
source	<pre><simpleType name="String20"> <annotation> <documentation>Facette zur Festlegung von: Artikel-, Ident-, Serien-, Lot-Nummer des Produkts</documentation> </annotation> <restriction base="xs:string"> <maxLength value="20" /> </restriction> </simpleType></pre>						

simpleType **String7**

namespace	http://xml.ir-d.de/sak						
type	restriction of string						
properties	base xs:string						
facets	<table border="1"> <thead> <tr> <th>Kind</th> <th>Value</th> <th>Annotation</th> </tr> </thead> <tbody> <tr> <td>pattern</td> <td>([0-9]{7})</td> <td></td> </tr> </tbody> </table>	Kind	Value	Annotation	pattern	([0-9]{7})	
Kind	Value	Annotation					
pattern	([0-9]{7})						
annotation	documentation						

	Facette zur Festlegung eines Katalogkodes
source	<pre><simpleType name="String7"> <annotation> <documentation>Facette zur Festlegung eines Katalogkodes</documentation> </annotation> <restriction base="xs:string"> <pattern value="([0-9]{7})"/> </restriction> </simpleType></pre>

simpleType Sw

namespace	http://xml.ir-d.de/sak						
type	restriction of string						
properties	base xs:string						
facets	<table border="1"> <thead> <tr> <th>Kind</th> <th>Value</th> <th>Annotation</th> </tr> </thead> <tbody> <tr> <td>maxLength</td> <td>120</td> <td></td> </tr> </tbody> </table>	Kind	Value	Annotation	maxLength	120	
Kind	Value	Annotation					
maxLength	120						
annotation	documentation Facette für Merkmale der externen Software						
source	<pre><simpleType name="Sw"> <annotation> <documentation>Facette für Merkmale der externen Software</documentation> </annotation> <restriction base="xs:string"> <maxLength value="120"/> </restriction> </simpleType></pre>						

simpleType Transfervummer

namespace	http://xml.ir-d.de/sak						
type	restriction of string						
properties	base xs:string						
used by	element SelbstauskunftFallBasis/FAL Transfervummer						
facets	<table border="1"> <thead> <tr> <th>Kind</th> <th>Value</th> <th>Annotation</th> </tr> </thead> <tbody> <tr> <td>pattern</td> <td>([a-z0-9]{64})</td> <td></td> </tr> </tbody> </table>	Kind	Value	Annotation	pattern	([a-z0-9]{64})	
Kind	Value	Annotation					
pattern	([a-z0-9]{64})						
annotation	documentation Facette zur Festlegung der Transfervummer						
source	<pre><simpleType name="Transfervummer"> <annotation> <documentation>Facette zur Festlegung der Transfervummer</documentation> </annotation> <restriction base="xs:string"> <pattern value="([a-z0-9]{64})"/> </restriction> </simpleType></pre>						

simpleType Versionsnummer

namespace	http://xml.ir-d.de/sak
-----------	------------------------

type	restriction of string						
properties	base xs:string						
facets	<table border="1"> <thead> <tr> <th>Kind</th> <th>Value</th> <th>Annotation</th> </tr> </thead> <tbody> <tr> <td>maxLength</td> <td>10</td> <td></td> </tr> </tbody> </table>	Kind	Value	Annotation	maxLength	10	
Kind	Value	Annotation					
maxLength	10						
annotation	documentation Facette zur Festlegung der Versionsnummer des gelieferten Datensatzes						
source	<pre><simpleType name="Versionsnummer"> <annotation> <documentation>Facette zur Festlegung der Versionsnummer des gelieferten Datensatzes</documentation> </annotation> <restriction base="xs:string"> <maxLength value="10"/> </restriction> </simpleType></pre>						

simpleType **Zahl1**

namespace	http://xml.ir-d.de/sak									
type	restriction of positiveInteger									
properties	base xs:positiveInteger									
facets	<table border="1"> <thead> <tr> <th>Kind</th> <th>Value</th> <th>Annotation</th> </tr> </thead> <tbody> <tr> <td>minInclusive</td> <td>1</td> <td></td> </tr> <tr> <td>maxInclusive</td> <td>9</td> <td></td> </tr> </tbody> </table>	Kind	Value	Annotation	minInclusive	1		maxInclusive	9	
Kind	Value	Annotation								
minInclusive	1									
maxInclusive	9									
annotation	documentation Facette zur Festlegung der 1-stelligen Ganzzahlenwerte									
source	<pre><simpleType name="Zahl1"> <annotation> <documentation>Facette zur Festlegung der 1-stelligen Ganzzahlenwerte</documentation> </annotation> <restriction base="xs:positiveInteger"> <minInclusive value="1"/> <maxInclusive value="9"/> </restriction> </simpleType></pre>									

simpleType **Zahl1_1**

namespace	http://xml.ir-d.de/sak															
type	restriction of decimal															
properties	base xs:decimal															
facets	<table border="1"> <thead> <tr> <th>Kind</th> <th>Value</th> <th>Annotation</th> </tr> </thead> <tbody> <tr> <td>minInclusive</td> <td>0.1</td> <td></td> </tr> <tr> <td>maxInclusive</td> <td>9.9</td> <td></td> </tr> <tr> <td>totalDigits</td> <td>2</td> <td></td> </tr> <tr> <td>fractionDigits</td> <td>1</td> <td></td> </tr> </tbody> </table>	Kind	Value	Annotation	minInclusive	0.1		maxInclusive	9.9		totalDigits	2		fractionDigits	1	
Kind	Value	Annotation														
minInclusive	0.1															
maxInclusive	9.9															
totalDigits	2															
fractionDigits	1															
annotation	documentation Facette zur Festlegung des Formats [N].[N]															
source	<pre><simpleType name="Zahl1_1"> <annotation></pre>															

	<pre> <documentation>Facette zur Festlegung des Formats [N].[N]</documentation> </annotation> <restriction base="xs:decimal"> <totalDigits value="2"/> <fractionDigits value="1"/> <minInclusive value="0.1"/> <maxInclusive value="9.9"/> </restriction> </simpleType> </pre>
--	--

simpleType **Zahl2**

namespace	http://xml.ir-d.de/sak									
type	restriction of positiveInteger									
properties	base xs:positiveInteger									
facets	<table border="1"> <thead> <tr> <th>Kind</th> <th>Value</th> <th>Annotation</th> </tr> </thead> <tbody> <tr> <td>minInclusive</td> <td>1</td> <td></td> </tr> <tr> <td>maxInclusive</td> <td>99</td> <td></td> </tr> </tbody> </table>	Kind	Value	Annotation	minInclusive	1		maxInclusive	99	
Kind	Value	Annotation								
minInclusive	1									
maxInclusive	99									
annotation	documentation Facette zur Festlegung der 2-stelligen Ganzzahlenwerte									
source	<pre> <simpleType name="Zahl2"> <annotation> <documentation>Facette zur Festlegung der 2-stelligen Ganzzahlenwerte</documentation> </annotation> <restriction base="xs:positiveInteger"> <minInclusive value="1"/> <maxInclusive value="99"/> </restriction> </simpleType> </pre>									

simpleType **Zahl2_1**

namespace	http://xml.ir-d.de/sak															
type	restriction of decimal															
properties	base xs:decimal															
facets	<table border="1"> <thead> <tr> <th>Kind</th> <th>Value</th> <th>Annotation</th> </tr> </thead> <tbody> <tr> <td>minInclusive</td> <td>0.1</td> <td></td> </tr> <tr> <td>maxInclusive</td> <td>99.9</td> <td></td> </tr> <tr> <td>totalDigits</td> <td>3</td> <td></td> </tr> <tr> <td>fractionDigits</td> <td>1</td> <td></td> </tr> </tbody> </table>	Kind	Value	Annotation	minInclusive	0.1		maxInclusive	99.9		totalDigits	3		fractionDigits	1	
Kind	Value	Annotation														
minInclusive	0.1															
maxInclusive	99.9															
totalDigits	3															
fractionDigits	1															
annotation	documentation Facette zur Festlegung des Formats [NN].[N]															
source	<pre> <simpleType name="Zahl2_1"> <annotation> <documentation>Facette zur Festlegung des Formats [NN].[N]</documentation> </annotation> <restriction base="xs:decimal"> <totalDigits value="3"/> <fractionDigits value="1"/> <minInclusive value="0.1"/> </restriction> </simpleType> </pre>															

	<pre><maxInclusive value="99.9"/> </restriction> </simpleType></pre>
--	--

simpleType **Zahl3**

namespace	http://xml.ir-d.de/sak									
type	restriction of positivelnteger									
properties	base xs:positivelnteger									
facets	<table border="1"> <thead> <tr> <th>Kind</th> <th>Value</th> <th>Annotation</th> </tr> </thead> <tbody> <tr> <td>minInclusive</td> <td>1</td> <td></td> </tr> <tr> <td>maxInclusive</td> <td>999</td> <td></td> </tr> </tbody> </table>	Kind	Value	Annotation	minInclusive	1		maxInclusive	999	
Kind	Value	Annotation								
minInclusive	1									
maxInclusive	999									
annotation	documentation Facette zur Festlegung der 3-stelligen Ganzzahlenwerte									
source	<pre><simpleType name="Zahl3"> <annotation> <documentation>Facette zur Festlegung der 3-stelligen Ganzzahlenwerte</documentation> </annotation> <restriction base="xs:positiveInteger"> <minInclusive value="1"/> <maxInclusive value="999"/> </restriction> </simpleType></pre>									

simpleType **Zahl3_1**

namespace	http://xml.ir-d.de/sak															
type	restriction of decimal															
properties	base xs:decimal															
facets	<table border="1"> <thead> <tr> <th>Kind</th> <th>Value</th> <th>Annotation</th> </tr> </thead> <tbody> <tr> <td>minInclusive</td> <td>0.1</td> <td></td> </tr> <tr> <td>maxInclusive</td> <td>999.9</td> <td></td> </tr> <tr> <td>totalDigits</td> <td>4</td> <td></td> </tr> <tr> <td>fractionDigits</td> <td>1</td> <td></td> </tr> </tbody> </table>	Kind	Value	Annotation	minInclusive	0.1		maxInclusive	999.9		totalDigits	4		fractionDigits	1	
Kind	Value	Annotation														
minInclusive	0.1															
maxInclusive	999.9															
totalDigits	4															
fractionDigits	1															
annotation	documentation Facette zur Festlegung des Formats [NNN].[N]															
source	<pre><simpleType name="Zahl3_1"> <annotation> <documentation>Facette zur Festlegung des Formats [NNN].[N]</documentation> </annotation> <restriction base="xs:decimal"> <totalDigits value="4"/> <fractionDigits value="1"/> <minInclusive value="0.1"/> <maxInclusive value="999.9"/> </restriction> </simpleType></pre>															

simpleType **Zahl3mitNull**

namespace	http://xml.ir-d.de/sak									
type	restriction of integer									
properties	base xs:integer									
facets	<table border="1"> <thead> <tr> <th>Kind</th> <th>Value</th> <th>Annotation</th> </tr> </thead> <tbody> <tr> <td>minInclusive</td> <td>0</td> <td></td> </tr> <tr> <td>maxInclusive</td> <td>999</td> <td></td> </tr> </tbody> </table>	Kind	Value	Annotation	minInclusive	0		maxInclusive	999	
Kind	Value	Annotation								
minInclusive	0									
maxInclusive	999									
annotation	documentation Facette zur Festlegung der 3-stelligen Ganzzahlenwerte inklusive "0"									
source	<pre><simpleType name="Zahl3mitNull"> <annotation> <documentation>Facette zur Festlegung der 3-stelligen Ganzzahlenwerte inklusive "0"</documentation> </annotation> <restriction base="xs:integer"> <minInclusive value="0"/> <maxInclusive value="999"/> </restriction> </simpleType></pre>									

simpleType **Zahl4**

namespace	http://xml.ir-d.de/sak									
type	restriction of positiveInteger									
properties	base xs:positiveInteger									
facets	<table border="1"> <thead> <tr> <th>Kind</th> <th>Value</th> <th>Annotation</th> </tr> </thead> <tbody> <tr> <td>minInclusive</td> <td>1</td> <td></td> </tr> <tr> <td>maxInclusive</td> <td>9999</td> <td></td> </tr> </tbody> </table>	Kind	Value	Annotation	minInclusive	1		maxInclusive	9999	
Kind	Value	Annotation								
minInclusive	1									
maxInclusive	9999									
annotation	documentation Facette zur Festlegung der 4-stelligen Ganzzahlenwerte									
source	<pre><simpleType name="Zahl4"> <annotation> <documentation>Facette zur Festlegung der 4-stelligen Ganzzahlenwerte</documentation> </annotation> <restriction base="xs:positiveInteger"> <minInclusive value="1"/> <maxInclusive value="9999"/> </restriction> </simpleType></pre>									

simpleType **Zahl5**

namespace	http://xml.ir-d.de/sak									
type	restriction of positiveInteger									
properties	base xs:positiveInteger									
facets	<table border="1"> <thead> <tr> <th>Kind</th> <th>Value</th> <th>Annotation</th> </tr> </thead> <tbody> <tr> <td>minInclusive</td> <td>1</td> <td></td> </tr> <tr> <td>maxInclusive</td> <td>99999</td> <td></td> </tr> </tbody> </table>	Kind	Value	Annotation	minInclusive	1		maxInclusive	99999	
Kind	Value	Annotation								
minInclusive	1									
maxInclusive	99999									
annotation	documentation									

	Facette zur Festlegung der 5-stelligen Ganzzahlenwerte
source	<pre> <simpleType name="Zahl5"> <annotation> <documentation>Facette zur Festlegung der 5-stelligen Ganzzahlenwerte</documentation> </annotation> <restriction base="xs:positiveInteger"> <minInclusive value="1"/> <maxInclusive value="99999"/> </restriction> </simpleType> </pre>

simpleType **Zahl5mitNull**

namespace	http://xml.ir-d.de/sak									
type	restriction of integer									
properties	base xs:integer									
facets	<table border="1"> <thead> <tr> <th>Kind</th> <th>Value</th> <th>Annotation</th> </tr> </thead> <tbody> <tr> <td>minInclusive</td> <td>0</td> <td></td> </tr> <tr> <td>maxInclusive</td> <td>99999</td> <td></td> </tr> </tbody> </table>	Kind	Value	Annotation	minInclusive	0		maxInclusive	99999	
Kind	Value	Annotation								
minInclusive	0									
maxInclusive	99999									
annotation	documentation Facette zur Festlegung der 5-stelligen Ganzzahlenwerte inklusive "0"									
source	<pre> <simpleType name="Zahl5mitNull"> <annotation> <documentation>Facette zur Festlegung der 5-stelligen Ganzzahlenwerte inklusive "0"</documentation> </annotation> <restriction base="xs:integer"> <minInclusive value="0"/> <maxInclusive value="99999"/> </restriction> </simpleType> </pre>									

complexType **MeldungIrdBasis**

diagram	<pre> classDiagram class MeldungIrdBasis { MEL_IrdIdGesundheitseinrichtung } class MEL_IrdIdGesundheitseinrichtung { type IdEinrichtung pattern (IRD-GE-[0-9]{8}) } MeldungIrdBasis "1" -- "*" MEL_IrdIdGesundheitseinrichtung </pre>
namespace	http://xml.ir-d.de/sak
children	MEL_IrdIdGesundheitseinrichtung
used by	complexType Selbstauskunft
source	<pre> <complexType name="MeldungIrdBasis"> <sequence> <element name="MEL_IrdIdGesundheitseinrichtung" type="IdEinrichtung"/> </sequence> </complexType> </pre>

element MeldungIrdBasis/MEL_IrdIdGesundheitseinrichtung

diagram	
type	IdEinrichtung
properties	content simple
facets	Kind Value Annotation pattern (IRD-GE-[0-9]{8})
source	<code><element name="MEL_IrdIdGesundheitseinrichtung" type="IdEinrichtung"/></code>

complexType SelbstauskunftFallBasis

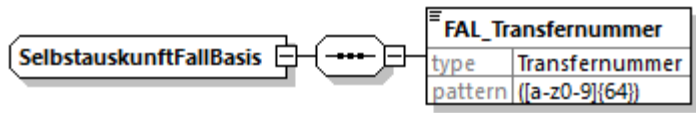
diagram	
namespace	http://xml.ir-d.de/sak
children	FAL_Transfernummer
used by	element Selbstauskunft/fall
source	<code><complexType name="SelbstauskunftFallBasis"> <sequence> <element name="FAL_Transfernummer" type="Transfernummer"/> </sequence> </complexType></code>

element SelbstauskunftFallBasis/FAL_Transfernummer

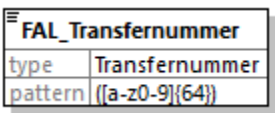
diagram	
type	Transfernummer
properties	content simple
facets	Kind Value Annotation pattern ([a-z0-9]{64})
source	<code><element name="FAL_Transfernummer" type="Transfernummer"/></code>

simpleType DatumText

namespace	http://xml.ir-d.de/irdsaa
type	restriction of string
properties	base xs:string
facets	Kind Value Annotation pattern ((([0-9]{4})([0-9]{2})?([0-9]{2})?)?)
annotation	documentation Facette zur Festlegung des freien Datumformats: JJJ[-MM[-TT]]

source	<pre><simpleType name="DatumText"> <annotation> <documentation>Facette zur Festlegung des freien Datumformats: JJJJ[-MM[- TT]]</documentation> </annotation> <restriction base="xs:string"> <pattern value="((([0-9]{4})?([-][0-9]{2})?([-][0-9]{2})?)"/> </restriction> </simpleType></pre>
--------	--

simpleType **Freitext250**

namespace	http://xml.ir-d.de/irdsaa						
type	restriction of string						
properties	base xs:string						
used by	element EmpfangsbestaetigungBasis/EBG Empfangsbestaetigung						
facets	<table border="1"> <thead> <tr> <th>Kind</th> <th>Value</th> <th>Annotation</th> </tr> </thead> <tbody> <tr> <td>maxLength</td> <td>250</td> <td></td> </tr> </tbody> </table>	Kind	Value	Annotation	maxLength	250	
Kind	Value	Annotation					
maxLength	250						
annotation	documentation Facette zur Festlegung des Freitextes von 250 Zeichen						
source	<pre><simpleType name="Freitext250"> <annotation> <documentation>Facette zur Festlegung des Freitextes von 250 Zeichen</documentation> </annotation> <restriction base="xs:string"> <maxLength value="250"/> </restriction> </simpleType></pre>						

simpleType **Freitext500**

namespace	http://xml.ir-d.de/irdsaa						
type	restriction of string						
properties	base xs:string						
facets	<table border="1"> <thead> <tr> <th>Kind</th> <th>Value</th> <th>Annotation</th> </tr> </thead> <tbody> <tr> <td>maxLength</td> <td>500</td> <td></td> </tr> </tbody> </table>	Kind	Value	Annotation	maxLength	500	
Kind	Value	Annotation					
maxLength	500						
annotation	documentation Facette zur Festlegung des Freitextes von 500 Zeichen						
source	<pre><simpleType name="Freitext500"> <annotation> <documentation>Facette zur Festlegung des Freitextes von 500 Zeichen</documentation> </annotation> <restriction base="xs:string"> <maxLength value="500"/> </restriction> </simpleType></pre>						

simpleType HashString

namespace	http://xml.ir-d.de/irdsaa						
type	restriction of string						
properties	base xs:string						
facets	<table border="1"> <thead> <tr> <th>Kind</th> <th>Value</th> <th>Annotation</th> </tr> </thead> <tbody> <tr> <td>maxLength</td> <td>512</td> <td></td> </tr> </tbody> </table>	Kind	Value	Annotation	maxLength	512	
Kind	Value	Annotation					
maxLength	512						
annotation	documentation Facette zur Festlegung des Hash-Strings der Meldebestätigung						
source	<pre> <simpleType name="HashString"> <annotation> <documentation>Facette zur Festlegung des Hash-Strings der Meldebestätigung</documentation> </annotation> <restriction base="xs:string"> <maxLength value="512"/> </restriction> </simpleType> </pre>						

simpleType HashWert

namespace	http://xml.ir-d.de/irdsaa						
type	restriction of string						
properties	base xs:string						
facets	<table border="1"> <thead> <tr> <th>Kind</th> <th>Value</th> <th>Annotation</th> </tr> </thead> <tbody> <tr> <td>length</td> <td>64</td> <td></td> </tr> </tbody> </table>	Kind	Value	Annotation	length	64	
Kind	Value	Annotation					
length	64						
annotation	documentation Facette zur Festlegung des Hashwertes der Meldebestätigung						
source	<pre> <simpleType name="HashWert"> <annotation> <documentation>Facette zur Festlegung des Hashwertes der Meldebestätigung</documentation> </annotation> <restriction base="xs:string"> <length value="64"/> </restriction> </simpleType> </pre>						

simpleType ICD

namespace	http://xml.ir-d.de/irdsaa						
type	restriction of string						
properties	base xs:string						
facets	<table border="1"> <thead> <tr> <th>Kind</th> <th>Value</th> <th>Annotation</th> </tr> </thead> <tbody> <tr> <td>pattern</td> <td> $[a-zA-Z][0-9]{2}(\.[0-9]{1,2})?([RLB])?$ </td> <td></td> </tr> </tbody> </table>	Kind	Value	Annotation	pattern	$[a-zA-Z][0-9]{2}(\.[0-9]{1,2})?([RLB])?$	
Kind	Value	Annotation					
pattern	$[a-zA-Z][0-9]{2}(\.[0-9]{1,2})?([RLB])?$						
annotation	documentation Facette zur Festlegung des ICD Code						
source	<pre> <simpleType name="ICD"> <annotation> <documentation>Facette zur Festlegung des ICD Code</documentation> </annotation> <restriction base="xs:string"> </pre>						

	<pre> <pattern value="([a-zA-Z][0-9]{2}(\.[0-9]{1,2})?([RLB])?)"/> </restriction> </simpleType> </pre>
--	--

simpleType IdBsnr

namespace	http://xml.ir-d.de/irdsaa						
type	restriction of string						
properties	base xs:string						
facets	<table border="1"> <tr> <th>Kind</th> <th>Value</th> <th>Annotation</th> </tr> <tr> <td>length</td> <td>9</td> <td></td> </tr> </table>	Kind	Value	Annotation	length	9	
Kind	Value	Annotation					
length	9						
annotation	documentation Facette zur Festlegung der Betriebsstättennummer						
source	<pre> <simpleType name="IdBsnr"> <annotation> <documentation>Facette zur Festlegung der Betriebsstättennummer</documentation> </annotation> <restriction base="xs:string"> <length value="9"/> </restriction> </simpleType> </pre>						

simpleType IdEinrichtung

namespace	http://xml.ir-d.de/irdsaa						
type	restriction of string						
properties	base xs:string						
used by	element MeldungIrdBasis/MEL_IrdIdGesundheitseinrichtung						
facets	<table border="1"> <tr> <th>Kind</th> <th>Value</th> <th>Annotation</th> </tr> <tr> <td>pattern</td> <td>(IRD-GE-[0-9]{8})</td> <td></td> </tr> </table>	Kind	Value	Annotation	pattern	(IRD-GE-[0-9]{8})	
Kind	Value	Annotation					
pattern	(IRD-GE-[0-9]{8})						
annotation	documentation Facette zur Festlegung der Gesundheitseinrichtung-ID						
source	<pre> <simpleType name="IdEinrichtung"> <annotation> <documentation>Facette zur Festlegung der Gesundheitseinrichtung- ID</documentation> </annotation> <restriction base="xs:string"> <pattern value="(IRD-GE-[0-9]{8})"/> </restriction> </simpleType> </pre>						

simpleType IdStandort

namespace	http://xml.ir-d.de/irdsaa						
type	restriction of string						
properties	base xs:string						
facets	<table border="1"> <tr> <th>Kind</th> <th>Value</th> <th>Annotation</th> </tr> <tr> <td>length</td> <td>6</td> <td></td> </tr> </table>	Kind	Value	Annotation	length	6	
Kind	Value	Annotation					
length	6						

annotation	documentation Facette zur Festlegung der Standort-ID
source	<pre><simpleType name="IdStandort"> <annotation> <documentation>Facette zur Festlegung der Standort-ID</documentation> </annotation> <restriction base="xs:string"> <length value="6"/> </restriction> </simpleType></pre>

simpleType IrdArtikelId

namespace	http://xml.ir-d.de/irdsaa						
type	restriction of string						
properties	base xs:string						
facets	<table border="1"> <thead> <tr> <th>Kind</th> <th>Value</th> <th>Annotation</th> </tr> </thead> <tbody> <tr> <td>maxLength</td> <td>16</td> <td></td> </tr> </tbody> </table>	Kind	Value	Annotation	maxLength	16	
Kind	Value	Annotation					
maxLength	16						
annotation	documentation Facette zur Festlegung der IrdNummer						
source	<pre><simpleType name="IrdArtikelId"> <annotation> <documentation>Facette zur Festlegung der IrdNummer</documentation> </annotation> <restriction base="xs:string"> <maxLength value="16"/> </restriction> </simpleType></pre>						

simpleType IrdSpezVersion

namespace	http://xml.ir-d.de/irdsaa						
type	restriction of string						
properties	base xs:string						
facets	<table border="1"> <thead> <tr> <th>Kind</th> <th>Value</th> <th>Annotation</th> </tr> </thead> <tbody> <tr> <td>pattern</td> <td>(([1-9] [1-9][0-9])\.\d{1}[1-9][0-9])</td> <td></td> </tr> </tbody> </table>	Kind	Value	Annotation	pattern	(([1-9] [1-9][0-9])\.\d{1}[1-9][0-9])	
Kind	Value	Annotation					
pattern	(([1-9] [1-9][0-9])\.\d{1}[1-9][0-9])						
annotation	documentation Facette zur Festlegung der Version der IRD-Spezifikation						
source	<pre><simpleType name="IrdSpezVersion"> <annotation> <documentation>Facette zur Festlegung der Version der IRD- Spezifikation</documentation> </annotation> <restriction base="xs:string"> <pattern value="(([1-9] [1-9][0-9])\.\d{1}[1-9][0-9])"/> </restriction> </simpleType></pre>						

simpleType JaLeer

namespace	http://xml.ir-d.de/irdsaa
-----------	---------------------------

type	restriction of integer
properties	base xs:integer
facets	Kind Value Annotation pattern (1)
annotation	documentation Facette zur Festlegung des Unbekannt-Wertes (Bedeutung 1=true)
source	<pre><simpleType name="JaLeer"> <annotation> <documentation>Facette zur Festlegung des Unbekannt-Wertes (Bedeutung 1=true)</documentation> </annotation> <restriction base="xs:integer"> <pattern value="(1)"/> </restriction> </simpleType></pre>

simpleType **Meldebestaetigung**

namespace	http://xml.ir-d.de/irdsaa
type	restriction of string
properties	base xs:string
facets	Kind Value Annotation length 10
annotation	documentation Facette zur Festlegung der Meldebestätigungslaenge von 10 Zeichen
source	<pre><simpleType name="Meldebestaetigung"> <annotation> <documentation>Facette zur Festlegung der Meldebestätigungslaenge von 10 Zeichen</documentation> </annotation> <restriction base="xs:string"> <length value="10"/> </restriction> </simpleType></pre>

simpleType **OPS**

namespace	http://xml.ir-d.de/irdsaa
type	restriction of string
properties	base xs:string
facets	Kind Value Annotation pattern ([135689]\-([0-9]){2}([a-zA-Z0-9]){1}\.([a-zA-Z0-9]{1,2})*(:[RLB])?)
annotation	documentation Facette zur Festlegung des Prozedurenschluessels
source	<pre><simpleType name="OPS"> <annotation> <documentation>Facette zur Festlegung des Prozedurenschluessels</documentation> </annotation> <restriction base="xs:string"> <pattern value="([135689]\-([0-9]){2}([a-zA-Z0-9]){1}\.([a-zA-Z0-</pre>

	<pre> 9]{1,2}))*(:[RLB])?)" /> </restriction> </simpleType> </pre>
--	---

simpleType **String2**

namespace	http://xml.ir-d.de/irdsaa						
type	restriction of string						
properties	base xs:string						
facets	<table border="1"> <thead> <tr> <th>Kind</th> <th>Value</th> <th>Annotation</th> </tr> </thead> <tbody> <tr> <td>pattern</td> <td>([0-9]{2})</td> <td></td> </tr> </tbody> </table>	Kind	Value	Annotation	pattern	([0-9]{2})	
Kind	Value	Annotation					
pattern	([0-9]{2})						
annotation	documentation Facette zur Festlegung des kodierten Entlassungsgrundes						
source	<pre> <simpleType name="String2"> <annotation> <documentation>Facette zur Festlegung des kodierten Entlassungsgrundes</documentation> </annotation> <restriction base="xs:string"> <pattern value="([0-9]{2})" /> </restriction> </simpleType> </pre>						

simpleType **String20**

namespace	http://xml.ir-d.de/irdsaa						
type	restriction of string						
properties	base xs:string						
facets	<table border="1"> <thead> <tr> <th>Kind</th> <th>Value</th> <th>Annotation</th> </tr> </thead> <tbody> <tr> <td>maxLength</td> <td>20</td> <td></td> </tr> </tbody> </table>	Kind	Value	Annotation	maxLength	20	
Kind	Value	Annotation					
maxLength	20						
annotation	documentation Facette zur Festlegung von: Artikel-, Ident-, Serien-, Lot-Nummer des Produkts						
source	<pre> <simpleType name="String20"> <annotation> <documentation>Facette zur Festlegung von: Artikel-, Ident-, Serien-, Lot-Nummer des Produkts</documentation> </annotation> <restriction base="xs:string"> <maxLength value="20" /> </restriction> </simpleType> </pre>						

simpleType **String7**

namespace	http://xml.ir-d.de/irdsaa						
type	restriction of string						
properties	base xs:string						
facets	<table border="1"> <thead> <tr> <th>Kind</th> <th>Value</th> <th>Annotation</th> </tr> </thead> <tbody> <tr> <td>pattern</td> <td>([0-9]{7})</td> <td></td> </tr> </tbody> </table>	Kind	Value	Annotation	pattern	([0-9]{7})	
Kind	Value	Annotation					
pattern	([0-9]{7})						
annotation	documentation						

	Facette zur Festlegung eines Katalogkodes
source	<pre><simpleType name="String7"> <annotation> <documentation>Facette zur Festlegung eines Katalogkodes</documentation> </annotation> <restriction base="xs:string"> <pattern value="([0-9]{7})"/> </restriction> </simpleType></pre>

simpleType Sw

namespace	http://xml.ir-d.de/irdsaa						
type	restriction of string						
properties	base xs:string						
facets	<table border="1"> <thead> <tr> <th>Kind</th> <th>Value</th> <th>Annotation</th> </tr> </thead> <tbody> <tr> <td>maxLength</td> <td>120</td> <td></td> </tr> </tbody> </table>	Kind	Value	Annotation	maxLength	120	
Kind	Value	Annotation					
maxLength	120						
annotation	documentation Facette für Merkmale der externen Software						
source	<pre><simpleType name="Sw"> <annotation> <documentation>Facette für Merkmale der externen Software</documentation> </annotation> <restriction base="xs:string"> <maxLength value="120"/> </restriction> </simpleType></pre>						

simpleType Transfervummer

namespace	http://xml.ir-d.de/irdsaa						
type	restriction of string						
properties	base xs:string						
used by	element SelbstauskunftFallBasis/FAL Transfervummer						
facets	<table border="1"> <thead> <tr> <th>Kind</th> <th>Value</th> <th>Annotation</th> </tr> </thead> <tbody> <tr> <td>pattern</td> <td>([a-z0-9]{64})</td> <td></td> </tr> </tbody> </table>	Kind	Value	Annotation	pattern	([a-z0-9]{64})	
Kind	Value	Annotation					
pattern	([a-z0-9]{64})						
annotation	documentation Facette zur Festlegung der Transfervummer						
source	<pre><simpleType name="Transfervummer"> <annotation> <documentation>Facette zur Festlegung der Transfervummer</documentation> </annotation> <restriction base="xs:string"> <pattern value="([a-z0-9]{64})"/> </restriction> </simpleType></pre>						

simpleType Versionsnummer

namespace	http://xml.ir-d.de/irdsaa
-----------	---------------------------

type	restriction of string						
properties	base xs:string						
facets	<table border="1"> <thead> <tr> <th>Kind</th> <th>Value</th> <th>Annotation</th> </tr> </thead> <tbody> <tr> <td>maxLength</td> <td>10</td> <td></td> </tr> </tbody> </table>	Kind	Value	Annotation	maxLength	10	
Kind	Value	Annotation					
maxLength	10						
annotation	documentation Facette zur Festlegung der Versionsnummer des gelieferten Datensatzes						
source	<pre><simpleType name="Versionsnummer"> <annotation> <documentation>Facette zur Festlegung der Versionsnummer des gelieferten Datensatzes</documentation> </annotation> <restriction base="xs:string"> <maxLength value="10"/> </restriction> </simpleType></pre>						

simpleType Zahl1

namespace	http://xml.ir-d.de/irdsaa									
type	restriction of positiveInteger									
properties	base xs:positiveInteger									
facets	<table border="1"> <thead> <tr> <th>Kind</th> <th>Value</th> <th>Annotation</th> </tr> </thead> <tbody> <tr> <td>minInclusive</td> <td>1</td> <td></td> </tr> <tr> <td>maxInclusive</td> <td>9</td> <td></td> </tr> </tbody> </table>	Kind	Value	Annotation	minInclusive	1		maxInclusive	9	
Kind	Value	Annotation								
minInclusive	1									
maxInclusive	9									
annotation	documentation Facette zur Festlegung der 1-stelligen Ganzzahlenwerte									
source	<pre><simpleType name="Zahl1"> <annotation> <documentation>Facette zur Festlegung der 1-stelligen Ganzzahlenwerte</documentation> </annotation> <restriction base="xs:positiveInteger"> <minInclusive value="1"/> <maxInclusive value="9"/> </restriction> </simpleType></pre>									

simpleType Zahl1_1

namespace	http://xml.ir-d.de/irdsaa															
type	restriction of decimal															
properties	base xs:decimal															
facets	<table border="1"> <thead> <tr> <th>Kind</th> <th>Value</th> <th>Annotation</th> </tr> </thead> <tbody> <tr> <td>minInclusive</td> <td>0.1</td> <td></td> </tr> <tr> <td>maxInclusive</td> <td>9.9</td> <td></td> </tr> <tr> <td>totalDigits</td> <td>2</td> <td></td> </tr> <tr> <td>fractionDigits</td> <td>1</td> <td></td> </tr> </tbody> </table>	Kind	Value	Annotation	minInclusive	0.1		maxInclusive	9.9		totalDigits	2		fractionDigits	1	
Kind	Value	Annotation														
minInclusive	0.1															
maxInclusive	9.9															
totalDigits	2															
fractionDigits	1															
annotation	documentation Facette zur Festlegung des Formats [N].[N]															
source	<pre><simpleType name="Zahl1_1"> <annotation></pre>															

	<pre> <documentation>Facette zur Festlegung des Formats [N].[N]</documentation> </annotation> <restriction base="xs:decimal"> <totalDigits value="2"/> <fractionDigits value="1"/> <minInclusive value="0.1"/> <maxInclusive value="9.9"/> </restriction> </simpleType> </pre>
--	--

simpleType Zahl2

namespace	http://xml.ir-d.de/irdsaa									
type	restriction of positiveInteger									
properties	base xs:positiveInteger									
facets	<table border="1"> <thead> <tr> <th>Kind</th> <th>Value</th> <th>Annotation</th> </tr> </thead> <tbody> <tr> <td>minInclusive</td> <td>1</td> <td></td> </tr> <tr> <td>maxInclusive</td> <td>99</td> <td></td> </tr> </tbody> </table>	Kind	Value	Annotation	minInclusive	1		maxInclusive	99	
Kind	Value	Annotation								
minInclusive	1									
maxInclusive	99									
annotation	documentation Facette zur Festlegung der 2-stelligen Ganzzahlenwerte									
source	<pre> <simpleType name="Zahl2"> <annotation> <documentation>Facette zur Festlegung der 2-stelligen Ganzzahlenwerte</documentation> </annotation> <restriction base="xs:positiveInteger"> <minInclusive value="1"/> <maxInclusive value="99"/> </restriction> </simpleType> </pre>									

simpleType Zahl2_1

namespace	http://xml.ir-d.de/irdsaa															
type	restriction of decimal															
properties	base xs:decimal															
facets	<table border="1"> <thead> <tr> <th>Kind</th> <th>Value</th> <th>Annotation</th> </tr> </thead> <tbody> <tr> <td>minInclusive</td> <td>0.1</td> <td></td> </tr> <tr> <td>maxInclusive</td> <td>99.9</td> <td></td> </tr> <tr> <td>totalDigits</td> <td>3</td> <td></td> </tr> <tr> <td>fractionDigits</td> <td>1</td> <td></td> </tr> </tbody> </table>	Kind	Value	Annotation	minInclusive	0.1		maxInclusive	99.9		totalDigits	3		fractionDigits	1	
Kind	Value	Annotation														
minInclusive	0.1															
maxInclusive	99.9															
totalDigits	3															
fractionDigits	1															
annotation	documentation Facette zur Festlegung des Formats [NN].[N]															
source	<pre> <simpleType name="Zahl2_1"> <annotation> <documentation>Facette zur Festlegung des Formats [NN].[N]</documentation> </annotation> <restriction base="xs:decimal"> <totalDigits value="3"/> <fractionDigits value="1"/> <minInclusive value="0.1"/> </restriction> </pre>															

	<pre> <maxInclusive value="99.9"/> </restriction> </simpleType> </pre>
--	--

simpleType **Zahl3**

namespace	http://xml.ir-d.de/irdsaa									
type	restriction of positivelnteger									
properties	base xs:positivelnteger									
facets	<table border="1"> <thead> <tr> <th>Kind</th> <th>Value</th> <th>Annotation</th> </tr> </thead> <tbody> <tr> <td>minInclusive</td> <td>1</td> <td></td> </tr> <tr> <td>maxInclusive</td> <td>999</td> <td></td> </tr> </tbody> </table>	Kind	Value	Annotation	minInclusive	1		maxInclusive	999	
Kind	Value	Annotation								
minInclusive	1									
maxInclusive	999									
annotation	documentation Facette zur Festlegung der 3-stelligen Ganzzahlenwerte									
source	<pre> <simpleType name="Zahl3"> <annotation> <documentation>Facette zur Festlegung der 3-stelligen Ganzzahlenwerte</documentation> </annotation> <restriction base="xs:positiveInteger"> <minInclusive value="1"/> <maxInclusive value="999"/> </restriction> </simpleType> </pre>									

simpleType **Zahl3_1**

namespace	http://xml.ir-d.de/irdsaa															
type	restriction of decimal															
properties	base xs:decimal															
facets	<table border="1"> <thead> <tr> <th>Kind</th> <th>Value</th> <th>Annotation</th> </tr> </thead> <tbody> <tr> <td>minInclusive</td> <td>0.1</td> <td></td> </tr> <tr> <td>maxInclusive</td> <td>999.9</td> <td></td> </tr> <tr> <td>totalDigits</td> <td>4</td> <td></td> </tr> <tr> <td>fractionDigits</td> <td>1</td> <td></td> </tr> </tbody> </table>	Kind	Value	Annotation	minInclusive	0.1		maxInclusive	999.9		totalDigits	4		fractionDigits	1	
Kind	Value	Annotation														
minInclusive	0.1															
maxInclusive	999.9															
totalDigits	4															
fractionDigits	1															
annotation	documentation Facette zur Festlegung des Formats [NNN].[N]															
source	<pre> <simpleType name="Zahl3_1"> <annotation> <documentation>Facette zur Festlegung des Formats [NNN].[N]</documentation> </annotation> <restriction base="xs:decimal"> <totalDigits value="4"/> <fractionDigits value="1"/> <minInclusive value="0.1"/> <maxInclusive value="999.9"/> </restriction> </simpleType> </pre>															

simpleType **Zahl3mitNull**

namespace	http://xml.ir-d.de/irdsaa									
type	restriction of integer									
properties	base xs:integer									
facets	<table border="1"> <thead> <tr> <th>Kind</th> <th>Value</th> <th>Annotation</th> </tr> </thead> <tbody> <tr> <td>minInclusive</td> <td>0</td> <td></td> </tr> <tr> <td>maxInclusive</td> <td>999</td> <td></td> </tr> </tbody> </table>	Kind	Value	Annotation	minInclusive	0		maxInclusive	999	
Kind	Value	Annotation								
minInclusive	0									
maxInclusive	999									
annotation	documentation Facette zur Festlegung der 3-stelligen Ganzzahlenwerte inklusive "0"									
source	<pre><simpleType name="Zahl3mitNull"> <annotation> <documentation>Facette zur Festlegung der 3-stelligen Ganzzahlenwerte inklusive "0"</documentation> </annotation> <restriction base="xs:integer"> <minInclusive value="0"/> <maxInclusive value="999"/> </restriction> </simpleType></pre>									

simpleType **Zahl4**

namespace	http://xml.ir-d.de/irdsaa									
type	restriction of positiveInteger									
properties	base xs:positiveInteger									
facets	<table border="1"> <thead> <tr> <th>Kind</th> <th>Value</th> <th>Annotation</th> </tr> </thead> <tbody> <tr> <td>minInclusive</td> <td>1</td> <td></td> </tr> <tr> <td>maxInclusive</td> <td>9999</td> <td></td> </tr> </tbody> </table>	Kind	Value	Annotation	minInclusive	1		maxInclusive	9999	
Kind	Value	Annotation								
minInclusive	1									
maxInclusive	9999									
annotation	documentation Facette zur Festlegung der 4-stelligen Ganzzahlenwerte									
source	<pre><simpleType name="Zahl4"> <annotation> <documentation>Facette zur Festlegung der 4-stelligen Ganzzahlenwerte</documentation> </annotation> <restriction base="xs:positiveInteger"> <minInclusive value="1"/> <maxInclusive value="9999"/> </restriction> </simpleType></pre>									

simpleType **Zahl5**

namespace	http://xml.ir-d.de/irdsaa									
type	restriction of positiveInteger									
properties	base xs:positiveInteger									
facets	<table border="1"> <thead> <tr> <th>Kind</th> <th>Value</th> <th>Annotation</th> </tr> </thead> <tbody> <tr> <td>minInclusive</td> <td>1</td> <td></td> </tr> <tr> <td>maxInclusive</td> <td>99999</td> <td></td> </tr> </tbody> </table>	Kind	Value	Annotation	minInclusive	1		maxInclusive	99999	
Kind	Value	Annotation								
minInclusive	1									
maxInclusive	99999									
annotation	documentation									

	Facette zur Festlegung der 5-stelligen Ganzzahlenwerte
source	<pre><simpleType name="Zahl5"> <annotation> <documentation>Facette zur Festlegung der 5-stelligen Ganzzahlenwerte</documentation> </annotation> <restriction base="xs:positiveInteger"> <minInclusive value="1"/> <maxInclusive value="99999"/> </restriction> </simpleType></pre>

simpleType **Zahl5mitNull**

namespace	http://xml.ir-d.de/irdsaa									
type	restriction of integer									
properties	base xs:integer									
facets	<table border="1"> <thead> <tr> <th>Kind</th> <th>Value</th> <th>Annotation</th> </tr> </thead> <tbody> <tr> <td>minInclusive</td> <td>0</td> <td></td> </tr> <tr> <td>maxInclusive</td> <td>99999</td> <td></td> </tr> </tbody> </table>	Kind	Value	Annotation	minInclusive	0		maxInclusive	99999	
Kind	Value	Annotation								
minInclusive	0									
maxInclusive	99999									
annotation	documentation Facette zur Festlegung der 5-stelligen Ganzzahlenwerte inklusive "0"									
source	<pre><simpleType name="Zahl5mitNull"> <annotation> <documentation>Facette zur Festlegung der 5-stelligen Ganzzahlenwerte inklusive "0"</documentation> </annotation> <restriction base="xs:integer"> <minInclusive value="0"/> <maxInclusive value="99999"/> </restriction> </simpleType></pre>									

complexType **MeldungIrdBasis**

diagram	<pre>classDiagram class MeldungIrdBasis { MEL_IrdIdGesundheitseinrichtung* } class MEL_IrdIdGesundheitseinrichtung { type IdEinrichtung pattern (IRD-GE-[0-9]{8}) } MeldungIrdBasis "1" -- "*" MEL_IrdIdGesundheitseinrichtung</pre>
namespace	http://xml.ir-d.de/irdsaa
children	MEL_IrdIdGesundheitseinrichtung
used by	complexType Selbstauskunft
source	<pre><complexType name="MeldungIrdBasis"> <sequence> <element name="MEL_IrdIdGesundheitseinrichtung" type="IdEinrichtung"/> </sequence> </complexType></pre>

element **MeldungIrdBasis/MEL_IrdIdGesundheitseinrichtung**

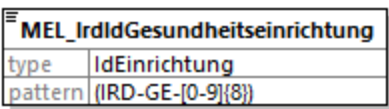
diagram	
type	IdEinrichtung
properties	content simple
facets	Kind Value Annotation pattern (IRD-GE-[0-9]{8})
source	<code><element name="MEL_IrdIdGesundheitseinrichtung" type="IdEinrichtung"/></code>

complexType **SelbstauskunftFallBasis**

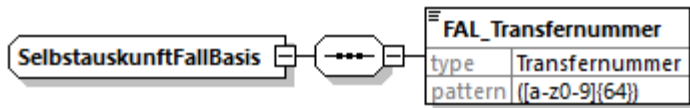
diagram	
namespace	http://xml.ir-d.de/irdsaa
children	FAL_Transfernummer
used by	element Selbstauskunft/fal
source	<code><complexType name="SelbstauskunftFallBasis"> <sequence> <element name="FAL_Transfernummer" type="Transfernummer"/> </sequence> </complexType></code>

element **SelbstauskunftFallBasis/FAL_Transfernummer**

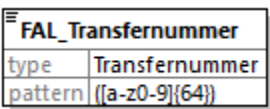
diagram	
type	Transfernummer
properties	content simple
facets	Kind Value Annotation pattern ([a-z0-9]{64})
source	<code><element name="FAL_Transfernummer" type="Transfernummer"/></code>

simpleType **DatumText**

namespace	http://xml.ir-d.de/emg
type	restriction of string
properties	base xs:string
used by	element ArtikelbeschreibungBasis/ARB_DatumImplantierung Explantat
facets	Kind Value Annotation pattern ((([0-9]{4})([0-9]{2})?([0-9]{2})?)?)

annotation	documentation Facette zur Festlegung des freien Datumformats: JJJ[-MM[-TT]]
source	<pre><simpleType name="DatumText"> <annotation> <documentation>Facette zur Festlegung des freien Datumformats: JJJ[-MM[-TT]]</documentation> </annotation> <restriction base="xs:string"> <pattern value="(([\d]{4})([-][\d]{2})?([-][\d]{2})?)"/> </restriction> </simpleType></pre>

simpleType **Freitext250**

namespace	http://xml.ir-d.de/emg						
type	restriction of string						
properties	base xs:string						
used by	elements ArtikelAortenklappeBasis/AAK HerstellerSonstiger ArtikelBrustimplantatBasis/ABI HerstellerSonstiger ArtikelEndoprotheseBasis/AEP HerstellerSonstiger ArtikelbeschreibungBasis/ARB Artikelbezeichnung ArtikelbeschreibungBasis/ARB Barcode OperationEndoprotheseBasis/OEP GrundWechselErlaeuterung VorbehandlungEndoprotheseBasis/VEP VorOpErlaeuterung ZubehoerBrustimplantatBasis/ZBI HerstellerSonstiger ZubehoerBasis/ZUB Artikelbezeichnung						
facets	<table border="1"> <thead> <tr> <th>Kind</th> <th>Value</th> <th>Annotation</th> </tr> </thead> <tbody> <tr> <td>maxLength</td> <td>250</td> <td></td> </tr> </tbody> </table>	Kind	Value	Annotation	maxLength	250	
Kind	Value	Annotation					
maxLength	250						
annotation	documentation Facette zur Festlegung des Freitextes von 250 Zeichen						
source	<pre><simpleType name="Freitext250"> <annotation> <documentation>Facette zur Festlegung des Freitextes von 250 Zeichen</documentation> </annotation> <restriction base="xs:string"> <maxLength value="250"/> </restriction> </simpleType></pre>						

simpleType **Freitext500**

namespace	http://xml.ir-d.de/emg						
type	restriction of string						
properties	base xs:string						
facets	<table border="1"> <thead> <tr> <th>Kind</th> <th>Value</th> <th>Annotation</th> </tr> </thead> <tbody> <tr> <td>maxLength</td> <td>500</td> <td></td> </tr> </tbody> </table>	Kind	Value	Annotation	maxLength	500	
Kind	Value	Annotation					
maxLength	500						
annotation	documentation Facette zur Festlegung des Freitextes von 500 Zeichen						
source	<pre><simpleType name="Freitext500"> <annotation> <documentation>Facette zur Festlegung des Freitextes von 500 Zeichen</documentation> </annotation> <restriction base="xs:string"></pre>						

	<pre> <maxLength value="500"/> </restriction> </simpleType> </pre>
--	--

simpleType HashString

namespace	http://xml.ir-d.de/emg						
type	restriction of string						
properties	base xs:string						
facets	<table border="1"> <thead> <tr> <th>Kind</th> <th>Value</th> <th>Annotation</th> </tr> </thead> <tbody> <tr> <td>maxLength</td> <td>512</td> <td></td> </tr> </tbody> </table>	Kind	Value	Annotation	maxLength	512	
Kind	Value	Annotation					
maxLength	512						
annotation	documentation Facette zur Festlegung des Hash-Strings der Meldebestätigung						
source	<pre> <simpleType name="HashString"> <annotation> <documentation>Facette zur Festlegung des Hash-Strings der Meldebestätigung</documentation> </annotation> <restriction base="xs:string"> <maxLength value="512"/> </restriction> </simpleType> </pre>						

simpleType HashWert

namespace	http://xml.ir-d.de/emg						
type	restriction of string						
properties	base xs:string						
facets	<table border="1"> <thead> <tr> <th>Kind</th> <th>Value</th> <th>Annotation</th> </tr> </thead> <tbody> <tr> <td>length</td> <td>64</td> <td></td> </tr> </tbody> </table>	Kind	Value	Annotation	length	64	
Kind	Value	Annotation					
length	64						
annotation	documentation Facette zur Festlegung des Hashwertes der Meldebestätigung						
source	<pre> <simpleType name="HashWert"> <annotation> <documentation>Facette zur Festlegung des Hashwertes der Meldebestätigung</documentation> </annotation> <restriction base="xs:string"> <length value="64"/> </restriction> </simpleType> </pre>						

simpleType ICD

namespace	http://xml.ir-d.de/emg			
type	restriction of string			
properties	base xs:string			
used by	elements DiagnoseAortenklappeBasis/DAK IcdSchluessel DiagnoseBrustimplantatBasis/DBI IcdSchluessel DiagnoseEndoprotheseBasis/DEP IcdSchluessel			
facets	<table border="1"> <thead> <tr> <th>Kind</th> <th>Value</th> <th>Annotation</th> </tr> </thead> <tbody> </tbody> </table>	Kind	Value	Annotation
Kind	Value	Annotation		

	pattern ([a-zA-Z][0-9]{2}(\.[0-9]{1,2})?(:[RLB])?)
annotation	documentation Facette zur Festlegung des ICD Code
source	<pre> <simpleType name="ICD"> <annotation> <documentation>Facette zur Festlegung des ICD Code</documentation> </annotation> <restriction base="xs:string"> <pattern value="([a-zA-Z][0-9]{2}(\.[0-9]{1,2})?(:[RLB])?)"/> </restriction> </simpleType> </pre>

simpleType IdBsnr

namespace	http://xml.ir-d.de/emg						
type	restriction of string						
properties	base xs:string						
used by	element MeldungBasis/MEL Bsnr						
facets	<table border="1"> <thead> <tr> <th>Kind</th> <th>Value</th> <th>Annotation</th> </tr> </thead> <tbody> <tr> <td>length</td> <td>9</td> <td></td> </tr> </tbody> </table>	Kind	Value	Annotation	length	9	
Kind	Value	Annotation					
length	9						
annotation	documentation Facette zur Festlegung der Betriebsstättennummer						
source	<pre> <simpleType name="IdBsnr"> <annotation> <documentation>Facette zur Festlegung der Betriebsstättennummer</documentation> </annotation> <restriction base="xs:string"> <length value="9"/> </restriction> </simpleType> </pre>						

simpleType IdEinrichtung

namespace	http://xml.ir-d.de/emg						
type	restriction of string						
properties	base xs:string						
used by	element MeldungBasis/MEL IrdIdGesundheitseinrichtung						
facets	<table border="1"> <thead> <tr> <th>Kind</th> <th>Value</th> <th>Annotation</th> </tr> </thead> <tbody> <tr> <td>pattern</td> <td>(IRD-GE-[0-9]{8})</td> <td></td> </tr> </tbody> </table>	Kind	Value	Annotation	pattern	(IRD-GE-[0-9]{8})	
Kind	Value	Annotation					
pattern	(IRD-GE-[0-9]{8})						
annotation	documentation Facette zur Festlegung der Gesundheitseinrichtung-ID						
source	<pre> <simpleType name="IdEinrichtung"> <annotation> <documentation>Facette zur Festlegung der Gesundheitseinrichtung- ID</documentation> </annotation> <restriction base="xs:string"> <pattern value="(IRD-GE-[0-9]{8})"/> </restriction> </simpleType> </pre>						

simpleType IdStandort

namespace	http://xml.ir-d.de/emg
type	restriction of string
properties	base xs:string
used by	element MeldungBasis/MEL StandortId
facets	Kind Value Annotation length 6
annotation	documentation Facette zur Festlegung der Standort-ID
source	<pre><simpleType name="IdStandort"> <annotation> <documentation>Facette zur Festlegung der Standort-ID</documentation> </annotation> <restriction base="xs:string"> <length value="6"/> </restriction> </simpleType></pre>

simpleType IrdArtikelId

namespace	http://xml.ir-d.de/emg
type	restriction of string
properties	base xs:string
used by	element ArtikelidentifikationBasis/ARI IrdNummer
facets	Kind Value Annotation maxLength 16
annotation	documentation Facette zur Festlegung der IrdNummer
source	<pre><simpleType name="IrdArtikelId"> <annotation> <documentation>Facette zur Festlegung der IrdNummer</documentation> </annotation> <restriction base="xs:string"> <maxLength value="16"/> </restriction> </simpleType></pre>

simpleType IrdSpezVersion

namespace	http://xml.ir-d.de/emg
type	restriction of string
properties	base xs:string
used by	element MeldungBasis/MEL IrdSpezVersion
facets	Kind Value Annotation pattern (([1-9] [1-9][0-9])\.\d{1-9}[0-9])\.\d{1-9}[0-9])
annotation	documentation Facette zur Festlegung der Version der IRD-Spezifikation

source	<pre> <simpleType name="IrdSpezVersion"> <annotation> <documentation>Facette zur Festlegung der Version der IRD- Spezifikation</documentation> </annotation> <restriction base="xs:string"> <pattern value="((([1-9] [1-9][0-9]))\.(\\d [1-9][0-9])\.(\\d [1-9][0-9]))"/> </restriction> </simpleType> </pre>
--------	---

simpleType JaLeer

namespace	http://xml.ir-d.de/emg						
type	restriction of integer						
properties	base xs:integer						
used by	<p>elements</p> <ul style="list-style-type: none"> ArtikelAortenklappeBasis/AAK Dislokation ArtikelAortenklappeBasis/AAK HerstellerUnbekannt ArtikelAortenklappeBasis/AAK KlappenTypUnbekannt ArtikelAortenklappeBasis/AAK ProthesenGroesseUnbekannt ArtikelBrustimplantatBasis/ABI FormUnbekannt ArtikelBrustimplantatBasis/ABI FuellungUnbekannt ArtikelBrustimplantatBasis/ABI HerstellerUnbekannt ArtikelBrustimplantatBasis/ABI OberflaecheUnbekannt ArtikelBrustimplantatBasis/ABI VolumenUnbekannt ArtikelEndoprotheseBasis/AEP HerstellerUnbekannt ArtikelbeschreibungBasis/ARB DatumImplantierung ExplantatUnbekannt ArtikelbeschreibungBasis/ARB DatumVerfallUnbekannt ArtikelbeschreibungBasis/ARB LotNummerUnbekannt ArtikelbeschreibungBasis/ARB SerienNummerUnbekannt ArtikelidentifikationBasis/ARI ArtikelkennzeichenUnbekannt OperationAortenklappeBasis/OAK AbgebrochenOhneVerbleib OperationAortenklappeBasis/OAK AbklemmzeitUnbekannt OperationAortenklappeBasis/OAK BypasszeitUnbekannt OperationAortenklappeBasis/OAK DeltaPmeanNachOpUnbekannt OperationAortenklappeBasis/OAK DistanzLcaUnbekannt OperationAortenklappeBasis/OAK DistanzRcaUnbekannt OperationAortenklappeBasis/OAK ImplantationAllograft OperationAortenklappeBasis/OAK PtcaNachDurchmesserUnbekannt OperationAortenklappeBasis/OAK PtcaVorDurchmesserUnbekannt OperationAortenklappeBasis/OAK ZugangsGefaessUnbekannt OperationEndoprotheseBasis/OEP AbgebrochenOhneVerbleib OperationEndoprotheseBasis/OEP Ergaenzungsop PatientenaufnahmeAortenklappeBasis/PAA AkoefUnbekannt PatientenaufnahmeAortenklappeBasis/PAA CtCalciumUnbekannt PatientenaufnahmeAortenklappeBasis/PAA DeltaPmaxUnbekannt PatientenaufnahmeAortenklappeBasis/PAA DeltaPmeanUnbekannt PatientenaufnahmeAortenklappeBasis/PAA DeltaPUnbekannt PatientenaufnahmeKardiologieBasis/PKA KreatininwertUnbekannt PatientenaufnahmeKardiologieBasis/PKA LvefUnbekannt PostoperationAortenklappeBasis/POA AkoefUnbekannt PostoperationAortenklappeBasis/POA DeltaPmaxUnbekannt PostoperationAortenklappeBasis/POA DeltaPmeanUnbekannt PostoperationAortenklappeBasis/POA LvefUnbekannt PostoperationAortenklappeBasis/POA MaxKreatininUnbekannt ZubehoerBrustimplantatBasis/ZBI HerstellerUnbekannt ZubehoerBasis/ZUB ArtikelNummerUnbekannt ZubehoerBasis/ZUB LotNummerUnbekannt ZubehoerBasis/ZUB SerienNummerUnbekannt 						
facets	<table border="0"> <tr> <td>Kind</td> <td>Value</td> <td>Annotation</td> </tr> <tr> <td>pattern</td> <td>(1)</td> <td></td> </tr> </table>	Kind	Value	Annotation	pattern	(1)	
Kind	Value	Annotation					
pattern	(1)						
annotation	<p>documentation</p> <p>Facette zur Festlegung des Unbekannt-Wertes (Bedeutung 1=true)</p>						

source	<pre><simpleType name="JaLeer"> <annotation> <documentation>Facette zur Festlegung des Unbekannt-Wertes (Bedeutung 1=true)</documentation> </annotation> <restriction base="xs:integer"> <pattern value="(1)"/> </restriction> </simpleType></pre>
--------	--

simpleType **Meldebestaetigung**

namespace	http://xml.ir-d.de/emg						
type	restriction of string						
properties	base xs:string						
facets	<table border="1"> <thead> <tr> <th>Kind</th> <th>Value</th> <th>Annotation</th> </tr> </thead> <tbody> <tr> <td>length</td> <td>10</td> <td></td> </tr> </tbody> </table>	Kind	Value	Annotation	length	10	
Kind	Value	Annotation					
length	10						
annotation	documentation Facette zur Festlegung der Meldebestätigungslaenge von 10 Zeichen						
source	<pre><simpleType name="Meldebestaetigung"> <annotation> <documentation>Facette zur Festlegung der Meldebestätigungslaenge von 10 Zeichen</documentation> </annotation> <restriction base="xs:string"> <length value="10"/> </restriction> </simpleType></pre>						

simpleType **OPS**

namespace	http://xml.ir-d.de/emg						
type	restriction of string						
properties	base xs:string						
used by	elements AusloeserBasis/ALR_ProzedurenSchluessel ProzedurenSchluesselAortenklappeBasis/PAK_ProzedurenSchluessel ProzedurenSchluesselBrustimplantatBasis/PBI_ProzedurenSchluessel ProzedurenSchluesselEndoprotheseBasis/PEP_ProzedurenSchluessel						
facets	<table border="1"> <thead> <tr> <th>Kind</th> <th>Value</th> <th>Annotation</th> </tr> </thead> <tbody> <tr> <td>pattern</td> <td> ([135689]\-([0-9]){2}([a-zA-Z0-9]){1}\.([a-zA-Z0-9]{1,2}))*(:[RLB])? </td> <td></td> </tr> </tbody> </table>	Kind	Value	Annotation	pattern	([135689]\-([0-9]){2}([a-zA-Z0-9]){1}\.([a-zA-Z0-9]{1,2}))*(:[RLB])?	
Kind	Value	Annotation					
pattern	([135689]\-([0-9]){2}([a-zA-Z0-9]){1}\.([a-zA-Z0-9]{1,2}))*(:[RLB])?						
annotation	documentation Facette zur Festlegung des Prozedurenschlüssels						
source	<pre><simpleType name="OPS"> <annotation> <documentation>Facette zur Festlegung des Prozedurenschlüssels</documentation> </annotation> <restriction base="xs:string"> <pattern value="([135689]\-([0-9]){2}([a-zA-Z0-9]){1}\.([a-zA-Z0-9]{1,2}))*(:[RLB])?" /> </restriction> </simpleType></pre>						

simpleType **String2**

namespace	http://xml.ir-d.de/emg						
type	restriction of string						
properties	base xs:string						
used by	element EntlassungBasis/ENT GrundSchluessel						
facets	<table border="1"> <thead> <tr> <th>Kind</th> <th>Value</th> <th>Annotation</th> </tr> </thead> <tbody> <tr> <td>pattern</td> <td>([0-9]{2})</td> <td></td> </tr> </tbody> </table>	Kind	Value	Annotation	pattern	([0-9]{2})	
Kind	Value	Annotation					
pattern	([0-9]{2})						
annotation	documentation Facette zur Festlegung des kodierten Entlassungsgrundes						
source	<pre><simpleType name="String2"> <annotation> <documentation>Facette zur Festlegung des kodierten Entlassungsgrundes</documentation> </annotation> <restriction base="xs:string"> <pattern value="([0-9]{2})"/> </restriction> </simpleType></pre>						

simpleType **String20**

namespace	http://xml.ir-d.de/emg						
type	restriction of string						
properties	base xs:string						
used by	elements ArtikelbeschreibungBasis/ARB DatumVerfall ArtikelbeschreibungBasis/ARB LotNummer ArtikelbeschreibungBasis/ARB SerienNummer ArtikelidentifikationBasis/ARI Artikelkennzeichen ZubehoerBasis/ZUB ArtikelNummer ZubehoerBasis/ZUB LotNummer ZubehoerBasis/ZUB SerienNummer						
facets	<table border="1"> <thead> <tr> <th>Kind</th> <th>Value</th> <th>Annotation</th> </tr> </thead> <tbody> <tr> <td>maxLength</td> <td>20</td> <td></td> </tr> </tbody> </table>	Kind	Value	Annotation	maxLength	20	
Kind	Value	Annotation					
maxLength	20						
annotation	documentation Facette zur Festlegung von: Artikel-, Ident-, Serien-, Lot-Nummer des Produkts						
source	<pre><simpleType name="String20"> <annotation> <documentation>Facette zur Festlegung von: Artikel-, Ident-, Serien-, Lot-Nummer des Produkts</documentation> </annotation> <restriction base="xs:string"> <maxLength value="20"/> </restriction> </simpleType></pre>						

simpleType **String7**

namespace	http://xml.ir-d.de/emg
type	restriction of string
properties	base xs:string
used by	elements ArtikelAortenklappeBasis/AAK HerstellerSchluessel ArtikelBrustimplantatBasis/ABI HerstellerSchluessel

	ArtikelEndoprotheseBasis/AEP_HerstellerSchluessel ArtikelEndoprotheseBasis/AEP_LieferantSchluessel
facets	Kind Value Annotation pattern ([0-9]{7})
annotation	documentation Facette zur Festlegung eines Katalogkodes
source	<pre><simpleType name="String7"> <annotation> <documentation>Facette zur Festlegung eines Katalogkodes</documentation> </annotation> <restriction base="xs:string"> <pattern value="([0-9]{7})"/> </restriction> </simpleType></pre>

simpleType Sw

namespace	http://xml.ir-d.de/emg
type	restriction of string
properties	base xs:string
used by	elements MeldungBasis/MEL_SwHersteller MeldungBasis/MEL_SwName MeldungBasis/MEL_SwVersion
facets	Kind Value Annotation maxLength 120
annotation	documentation Facette für Merkmale der externen Software
source	<pre><simpleType name="Sw"> <annotation> <documentation>Facette für Merkmale der externen Software</documentation> </annotation> <restriction base="xs:string"> <maxLength value="120"/> </restriction> </simpleType></pre>

simpleType Transfervummer

namespace	http://xml.ir-d.de/emg
type	restriction of string
properties	base xs:string
used by	element FallBasis/FAL_Transfervummer
facets	Kind Value Annotation pattern ([a-z0-9]{64})
annotation	documentation Facette zur Festlegung der Transfervummer
source	<pre><simpleType name="Transfervummer"> <annotation> <documentation>Facette zur Festlegung der Transfervummer</documentation> </annotation> <restriction base="xs:string"> <pattern value="([a-z0-9]{64})"/> </restriction> </simpleType></pre>

	<code></simpleType></code>
--	----------------------------------

simpleType **Versionsnummer**

namespace	http://xml.ir-d.de/emg						
type	restriction of string						
properties	base xs:string						
used by	element FallBasis/FAL Versionsnummer						
facets	<table border="1"> <thead> <tr> <th>Kind</th> <th>Value</th> <th>Annotation</th> </tr> </thead> <tbody> <tr> <td>maxLength</td> <td>10</td> <td></td> </tr> </tbody> </table>	Kind	Value	Annotation	maxLength	10	
Kind	Value	Annotation					
maxLength	10						
annotation	documentation Facette zur Festlegung der Versionsnummer des gelieferten Datensatzes						
source	<pre><simpleType name="Versionsnummer"> <annotation> <documentation>Facette zur Festlegung der Versionsnummer des gelieferten Datensatzes</documentation> </annotation> <restriction base="xs:string"> <maxLength value="10"/> </restriction> </simpleType></pre>						

simpleType **Zahl1**

namespace	http://xml.ir-d.de/emg									
type	restriction of positiveInteger									
properties	base xs:positiveInteger									
used by	elements OperationAortenklappeBasis/OAK LaesionenAnzahl OperationAortenklappeBasis/OAK ProzedurenAnzahl									
facets	<table border="1"> <thead> <tr> <th>Kind</th> <th>Value</th> <th>Annotation</th> </tr> </thead> <tbody> <tr> <td>minInclusive</td> <td>1</td> <td></td> </tr> <tr> <td>maxInclusive</td> <td>9</td> <td></td> </tr> </tbody> </table>	Kind	Value	Annotation	minInclusive	1		maxInclusive	9	
Kind	Value	Annotation								
minInclusive	1									
maxInclusive	9									
annotation	documentation Facette zur Festlegung der 1-stelligen Ganzzahlenwerte									
source	<pre><simpleType name="Zahl1"> <annotation> <documentation>Facette zur Festlegung der 1-stelligen Ganzzahlenwerte</documentation> </annotation> <restriction base="xs:positiveInteger"> <minInclusive value="1"/> <maxInclusive value="9"/> </restriction> </simpleType></pre>									

simpleType **Zahl1_1**

namespace	http://xml.ir-d.de/emg
type	restriction of decimal
properties	base xs:decimal

used by	elements OperationAortenklappeBasis/OAK ZugangsGefaessdiameter PatientenaufnahmeAortenklappeBasis/PAA Akoef PostoperationAortenklappeBasis/POA Akoef															
facets	<table border="1"> <thead> <tr> <th>Kind</th> <th>Value</th> <th>Annotation</th> </tr> </thead> <tbody> <tr> <td>minInclusive</td> <td>0.1</td> <td></td> </tr> <tr> <td>maxInclusive</td> <td>9.9</td> <td></td> </tr> <tr> <td>totalDigits</td> <td>2</td> <td></td> </tr> <tr> <td>fractionDigits</td> <td>1</td> <td></td> </tr> </tbody> </table>	Kind	Value	Annotation	minInclusive	0.1		maxInclusive	9.9		totalDigits	2		fractionDigits	1	
Kind	Value	Annotation														
minInclusive	0.1															
maxInclusive	9.9															
totalDigits	2															
fractionDigits	1															
annotation	documentation Facette zur Festlegung des Formats [N].[N]															
source	<pre><simpleType name="Zahl1_1"> <annotation> <documentation>Facette zur Festlegung des Formats [N].[N]</documentation> </annotation> <restriction base="xs:decimal"> <totalDigits value="2"/> <fractionDigits value="1"/> <minInclusive value="0.1"/> <maxInclusive value="9.9"/> </restriction> </simpleType></pre>															

simpleType Zahl2

namespace	http://xml.ir-d.de/emg									
type	restriction of positivelnteger									
properties	base xs:positivelnteger									
used by	elements ArtikelAortenklappeBasis/AAK ProthesenGroesse OperationAortenklappeBasis/OAK AortenklappenOpAnzahl OperationAortenklappeBasis/OAK NummerEingriff OperationAortenklappeBasis/OAK PtcaNachAnzahl OperationAortenklappeBasis/OAK PtcaNachDurchmesser OperationAortenklappeBasis/OAK PtcaVorAnzahl OperationAortenklappeBasis/OAK PtcaVorDurchmesser									
facets	<table border="1"> <thead> <tr> <th>Kind</th> <th>Value</th> <th>Annotation</th> </tr> </thead> <tbody> <tr> <td>minInclusive</td> <td>1</td> <td></td> </tr> <tr> <td>maxInclusive</td> <td>99</td> <td></td> </tr> </tbody> </table>	Kind	Value	Annotation	minInclusive	1		maxInclusive	99	
Kind	Value	Annotation								
minInclusive	1									
maxInclusive	99									
annotation	documentation Facette zur Festlegung der 2-stelligen Ganzzahlenwerte									
source	<pre><simpleType name="Zahl2"> <annotation> <documentation>Facette zur Festlegung der 2-stelligen Ganzzahlenwerte</documentation> </annotation> <restriction base="xs:positiveInteger"> <minInclusive value="1"/> <maxInclusive value="99"/> </restriction> </simpleType></pre>									

simpleType Zahl2_1

namespace	http://xml.ir-d.de/emg
type	restriction of decimal

properties	base xs:decimal
used by	elements PatientenaufnahmeKardiologieBasis/PKA KreatininwertMgdl PostoperationAortenklappeBasis/POA MaxKreatininMgdl
facets	Kind Value Annotation minInclusive 0.1 maxInclusive 99.9 totalDigits 3 fractionDigits 1
annotation	documentation Facette zur Festlegung des Formats [NN].[N]
source	<pre><simpleType name="Zahl2_1"> <annotation> <documentation>Facette zur Festlegung des Formats [NN].[N]</documentation> </annotation> <restriction base="xs:decimal"> <totalDigits value="3"/> <fractionDigits value="1"/> <minInclusive value="0.1"/> <maxInclusive value="99.9"/> </restriction> </simpleType></pre>

simpleType Zahl3

namespace	http://xml.ir-d.de/emg
type	restriction of positiveInteger
properties	base xs:positiveInteger
used by	elements ArtikelidentifikationBasis/ARI LaufendeNummer OperationAortenklappeBasis/OAK Abklemmzeit OperationAortenklappeBasis/OAK Aortenklappenannulus OperationAortenklappeBasis/OAK Bypasszeit OperationAortenklappeBasis/OAK DistanzLca OperationAortenklappeBasis/OAK DistanzRca OperationAortenklappeBasis/OAK Eingriffsdauer OperationBasis/OPE LaufendeNummer PatientenaufnahmeAortenklappeBasis/PAA DeltaP PatientenaufnahmeAortenklappeBasis/PAA DeltaPmax PatientenaufnahmeAortenklappeBasis/PAA DeltaPmean PatientenaufnahmeKardiologieBasis/PKA Lvef PostoperationAortenklappeBasis/POA DeltaP max PostoperationAortenklappeBasis/POA Lvef ZubehoerBasis/ZUB LaufendeNummer
facets	Kind Value Annotation minInclusive 1 maxInclusive 999
annotation	documentation Facette zur Festlegung der 3-stelligen Ganzzahlenwerte
source	<pre><simpleType name="Zahl3"> <annotation> <documentation>Facette zur Festlegung der 3-stelligen Ganzzahlenwerte</documentation> </annotation> <restriction base="xs:positiveInteger"> <minInclusive value="1"/> <maxInclusive value="999"/> </restriction> </simpleType></pre>

simpleType **Zahl3_1**

namespace	http://xml.ir-d.de/emg															
type	restriction of decimal															
properties	base xs:decimal															
used by	elements OperationAortenklappeBasis/OAK Durchleuchtungszeit PatientenaufnahmeAortenklappeBasis/PAA StsScore															
facets	<table border="1"> <thead> <tr> <th>Kind</th> <th>Value</th> <th>Annotation</th> </tr> </thead> <tbody> <tr> <td>minInclusive</td> <td>0.1</td> <td></td> </tr> <tr> <td>maxInclusive</td> <td>999.9</td> <td></td> </tr> <tr> <td>totalDigits</td> <td>4</td> <td></td> </tr> <tr> <td>fractionDigits</td> <td>1</td> <td></td> </tr> </tbody> </table>	Kind	Value	Annotation	minInclusive	0.1		maxInclusive	999.9		totalDigits	4		fractionDigits	1	
Kind	Value	Annotation														
minInclusive	0.1															
maxInclusive	999.9															
totalDigits	4															
fractionDigits	1															
annotation	documentation Facette zur Festlegung des Formats [NNN].[N]															
source	<pre><simpleType name="Zahl3_1"> <annotation> <documentation>Facette zur Festlegung des Formats [NNN].[N]</documentation> </annotation> <restriction base="xs:decimal"> <totalDigits value="4"/> <fractionDigits value="1"/> <minInclusive value="0.1"/> <maxInclusive value="999.9"/> </restriction> </simpleType></pre>															

simpleType **Zahl3mitNull**

namespace	http://xml.ir-d.de/emg									
type	restriction of integer									
properties	base xs:integer									
used by	elements OperationAortenklappeBasis/OAK DeltaPmeanNachOp PostoperationAortenklappeBasis/POA DeltaPmean PostoperationAortenklappeBasis/POA IntensivDauer									
facets	<table border="1"> <thead> <tr> <th>Kind</th> <th>Value</th> <th>Annotation</th> </tr> </thead> <tbody> <tr> <td>minInclusive</td> <td>0</td> <td></td> </tr> <tr> <td>maxInclusive</td> <td>999</td> <td></td> </tr> </tbody> </table>	Kind	Value	Annotation	minInclusive	0		maxInclusive	999	
Kind	Value	Annotation								
minInclusive	0									
maxInclusive	999									
annotation	documentation Facette zur Festlegung der 3-stelligen Ganzzahlenwerte inklusive "0"									
source	<pre><simpleType name="Zahl3mitNull"> <annotation> <documentation>Facette zur Festlegung der 3-stelligen Ganzzahlenwerte inklusive "0"</documentation> </annotation> <restriction base="xs:integer"> <minInclusive value="0"/> <maxInclusive value="999"/> </restriction> </simpleType></pre>									

simpleType **Zahl4**

namespace	http://xml.ir-d.de/emg									
type	restriction of positivInteger									
properties	base xs:positivInteger									
used by	elements PatientenaufnahmeKardiologieBasis/PKA KreatininwertMikromol PostoperationAortenklappeBasis/POA MaxKreatininMikromol									
facets	<table border="1"> <thead> <tr> <th>Kind</th> <th>Value</th> <th>Annotation</th> </tr> </thead> <tbody> <tr> <td>minInclusive</td> <td>1</td> <td></td> </tr> <tr> <td>maxInclusive</td> <td>9999</td> <td></td> </tr> </tbody> </table>	Kind	Value	Annotation	minInclusive	1		maxInclusive	9999	
Kind	Value	Annotation								
minInclusive	1									
maxInclusive	9999									
annotation	documentation Facette zur Festlegung der 4-stelligen Ganzzahlenwerte									
source	<pre><simpleType name="Zahl4"> <annotation> <documentation>Facette zur Festlegung der 4-stelligen Ganzzahlenwerte</documentation> </annotation> <restriction base="xs:positiveInteger"> <minInclusive value="1"/> <maxInclusive value="9999"/> </restriction> </simpleType></pre>									

simpleType **Zahl5**

namespace	http://xml.ir-d.de/emg									
type	restriction of positivInteger									
properties	base xs:positivInteger									
used by	elements ArtikelBrustimplantatBasis/ABI Volumen ArtikelEndoprotheseBasis/AEP Menge PatientenaufnahmeAortenklappeBasis/PAA CtCalcium									
facets	<table border="1"> <thead> <tr> <th>Kind</th> <th>Value</th> <th>Annotation</th> </tr> </thead> <tbody> <tr> <td>minInclusive</td> <td>1</td> <td></td> </tr> <tr> <td>maxInclusive</td> <td>99999</td> <td></td> </tr> </tbody> </table>	Kind	Value	Annotation	minInclusive	1		maxInclusive	99999	
Kind	Value	Annotation								
minInclusive	1									
maxInclusive	99999									
annotation	documentation Facette zur Festlegung der 5-stelligen Ganzzahlenwerte									
source	<pre><simpleType name="Zahl5"> <annotation> <documentation>Facette zur Festlegung der 5-stelligen Ganzzahlenwerte</documentation> </annotation> <restriction base="xs:positiveInteger"> <minInclusive value="1"/> <maxInclusive value="99999"/> </restriction> </simpleType></pre>									

simpleType **Zahl5mitNull**

namespace	http://xml.ir-d.de/emg
type	restriction of integer
properties	base xs:integer

used by	element ArtikelBrustimplantatBasis/ABI IntraoperativesVolumen									
facets	<table border="1"> <thead> <tr> <th>Kind</th> <th>Value</th> <th>Annotation</th> </tr> </thead> <tbody> <tr> <td>minInclusive</td> <td>0</td> <td></td> </tr> <tr> <td>maxInclusive</td> <td>99999</td> <td></td> </tr> </tbody> </table>	Kind	Value	Annotation	minInclusive	0		maxInclusive	99999	
Kind	Value	Annotation								
minInclusive	0									
maxInclusive	99999									
annotation	documentation Facette zur Festlegung der 5-stelligen Ganzzahlenwerte inklusive "0"									
source	<pre><simpleType name="Zahl5mitNull"> <annotation> <documentation>Facette zur Festlegung der 5-stelligen Ganzzahlenwerte inklusive "0"</documentation> </annotation> <restriction base="xs:integer"> <minInclusive value="0"/> <maxInclusive value="99999"/> </restriction> </simpleType></pre>									

complexType **FallBasis**

diagram	
namespace	http://xml.ir-d.de/emg
children	FAL Aufnahmedatum FAL ArtAufenthaltSchluessel FAL Transfernummer FAL DatumZeitSatzErstellung FAL Versionsnummer
used by	complexType Fall
source	<pre><complexType name="FallBasis"> <sequence> <element name="FAL_Aufnahmedatum" type="xs:date"/> <element name="FAL_ArtAufenthaltSchluessel" type="enum_0065"/> <element name="FAL_Transfernummer" type="Transfernummer"/> <element name="FAL_DatumZeitSatzErstellung" type="xs:dateTime"/> <element name="FAL_Versionsnummer" type="Versionsnummer" minOccurs="0"/> </sequence> </complexType></pre>

element **FallBasis/FAL_Aufnahmedatum**

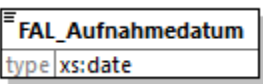
diagram	
type	date
properties	content simple
source	<code><element name="FAL_Aufnahmedatum" type="xs:date"/></code>

element **FallBasis/FAL_ArtAufenthaltSchluessel**

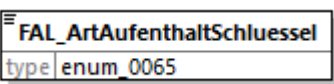
diagram													
type	enum 0065												
properties	content simple												
facets	<table border="1"> <thead> <tr> <th>Kind</th> <th>Value</th> <th>Annotation</th> </tr> </thead> <tbody> <tr> <td>enumeration</td> <td>0065001</td> <td>documentation stationär</td> </tr> <tr> <td>enumeration</td> <td>0065002</td> <td>documentation teilstationär</td> </tr> <tr> <td>enumeration</td> <td>0065003</td> <td>documentation ambulantly</td> </tr> </tbody> </table>	Kind	Value	Annotation	enumeration	0065001	documentation stationär	enumeration	0065002	documentation teilstationär	enumeration	0065003	documentation ambulantly
Kind	Value	Annotation											
enumeration	0065001	documentation stationär											
enumeration	0065002	documentation teilstationär											
enumeration	0065003	documentation ambulantly											
source	<code><element name="FAL_ArtAufenthaltSchluessel" type="enum_0065"/></code>												

element **FallBasis/FAL_Transfernummer**

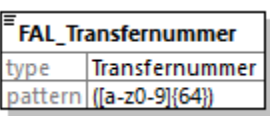
diagram							
type	Transfernummer						
properties	content simple						
facets	<table border="1"> <thead> <tr> <th>Kind</th> <th>Value</th> <th>Annotation</th> </tr> </thead> <tbody> <tr> <td>pattern</td> <td>([a-z0-9]{64})</td> <td></td> </tr> </tbody> </table>	Kind	Value	Annotation	pattern	([a-z0-9]{64})	
Kind	Value	Annotation					
pattern	([a-z0-9]{64})						
source	<code><element name="FAL_Transfernummer" type="Transfernummer"/></code>						

element **FallBasis/FAL_DatumZeitSatzErstellung**

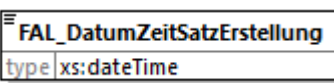
diagram	
type	dateTime
properties	content simple
source	<code><element name="FAL_DatumZeitSatzErstellung" type="xs:dateTime"/></code>

element **FallBasis/FAL_Versionsnummer**

diagram	
type	Versionsnummer
properties	minOcc 0 maxOcc 1 content simple
facets	Kind Value Annotation maxLength 10
source	<code><element name="FAL_Versionsnummer" type="Versionsnummer" minOccurs="0"/></code>

complexType **AusloeserBasis**

diagram	
namespace	http://xml.ir-d.de/emg
children	ALR_ProzedurenSchluessel
used by	element Fall/ausloeser
source	<pre><complexType name="AusloeserBasis"> <sequence> <element name="ALR_ProzedurenSchluessel" type="OPS"/> </sequence> </complexType></pre>

element **AusloeserBasis/ALR_ProzedurenSchluessel**

diagram	
type	OPS
properties	content simple
facets	Kind Value Annotation pattern (([135689]\-([0-9]){2})([a-zA-Z0-9]{1}\.([a-zA-Z0-9]{1,2}))*\:([RLB])?)
source	<code><element name="ALR_ProzedurenSchluessel" type="OPS"/></code>

complexType **Patientenaufnahme**

<p>diagram</p>	
<p>namespace</p>	<p>http://xml.ir-d.de/emg</p>
<p>type</p>	<p>extension of PatientenaufnahmeBasis</p>
<p>properties</p>	<p>base PatientenaufnahmeBasis</p>
<p>children</p>	<p>PAT Alter PAT Groesse PAT Gewicht PAT GeschlechtSchluessel patientenaufnahmeBrustimplantat patientenaufnahmeKardiologie</p>
<p>used by</p>	<p>element Fall/patientenaufnahme</p>
<p>source</p>	<pre><complexType name="Patientenaufnahme"> <complexContent> <extension base="PatientenaufnahmeBasis"> <sequence> <element name="patientenaufnahmeBrustimplantat" type="PatientenaufnahmeBrustimplantatBasis" minOccurs="0"/> <element name="patientenaufnahmeKardiologie" type="PatientenaufnahmeKardiologie" minOccurs="0"/> </sequence> </extension> </complexContent> </complexType></pre>

element **Patientenaufnahme/patientenaufnahmeBrustimplantat**

<p>diagram</p>	
<p>type</p>	<p>PatientenaufnahmeBrustimplantatBasis</p>
<p>properties</p>	<p>minOcc 0 maxOcc 1 content complex</p>
<p>children</p>	<p>PAB AutoimmunerkrankungSchluessel PAB VerlaufAutoimmunerkrankungSchluessel PAB GeschlechtGeburtSchluessel</p>
<p>source</p>	<pre><element name="patientenaufnahmeBrustimplantat" type="PatientenaufnahmeBrustimplantatBasis" minOccurs="0"/></pre>

element **Patientenaufnahme/patientenaufnahmeKardiologie**

<p>diagram</p>	
<p>type</p>	<p>PatientenaufnahmeKardiologie</p>
<p>properties</p>	<p>minOcc 0 maxOcc 1 content complex</p>
<p>children</p>	<p>PKA NyhaSchluessel PKA Lvef PKA LvefUnbekannt PKA DiabetesSchluessel PKA NierenersatzSchluessel PKA KreatininwertMgdl PKA KreatininwertMikromol PKA KreatininwertUnbekannt patientenaufnahmeAortenklappe</p>
<p>source</p>	<pre><element name="patientenaufnahmeKardiologie" type="PatientenaufnahmeKardiologie" minOccurs="0"/></pre>

complexType Operation

<p>diagram</p>	
<p>namespace</p>	<p>http://xml.ir-d.de/emg</p>
<p>type</p>	<p>extension of OperationBasis</p>
<p>properties</p>	<p>base OperationBasis</p>
<p>children</p>	<p>OPE LaufendeNummer OPE Datum OPE SeitenLokalisationSchluessel OPE AsaSchluessel OPE ImplantattypSchluessel operationBrustimplantat operationEndoprothese operationAortenklappe artikelidentifikation zubehoer</p>
<p>used by</p>	<p>element Fall/operation</p>
<p>source</p>	<pre><complexType name="Operation"> <complexContent> <extension base="OperationBasis"> <sequence> <choice> <element name="operationBrustimplantat" type="OperationBrustimplantat"/> <element name="operationEndoprothese" type="OperationEndoprothese"/> <element name="operationAortenklappe" type="OperationAortenklappe"/> </choice> <choice> <element name="artikelidentifikation" type="Artikelidentifikation"/> <element name="zubehoer" type="Zubehoer"/> </choice> </sequence> </extension> </complexContent> </complexType></pre>

```
        </choice>
        <element name="artikelidentifikation" type="Artikelidentifikation"
minOccurs="0" maxOccurs="unbounded"/>
        <element name="zubehoer" type="Zubehoer" minOccurs="0"
maxOccurs="unbounded"/>
    </sequence>
</extension>
</complexContent>
</complexType>
```

element **Operation/operationBrustimplantat**

<p>diagram</p>	
<p>type</p>	<p>OperationBrustimplantat</p>
<p>properties</p>	<p>content complex</p>
<p>children</p>	<p>OBI_ArtEingriffSchluessel OBI_GrundPrimaerEingriffSchluessel OBI_GrundAustauschSchluessel OBI_GrundRevisionExplantationSchluessel OBI_LageSchluessel OBI_ZugangSchluessel OBI_EntfernungAdmNetzSchluessel OBI_VerfahrenswechselSchluessel vorbehandlungBrustimplantat massnahmeBrustimplantat operationsdetailBrustimplantat befundBrustimplantat prozedurenSchluesselBrustimplantat</p>
<p>source</p>	<pre><element name="operationBrustimplantat" type="OperationBrustimplantat"/></pre>

element **Operation/operationEndoprothese**

diagram

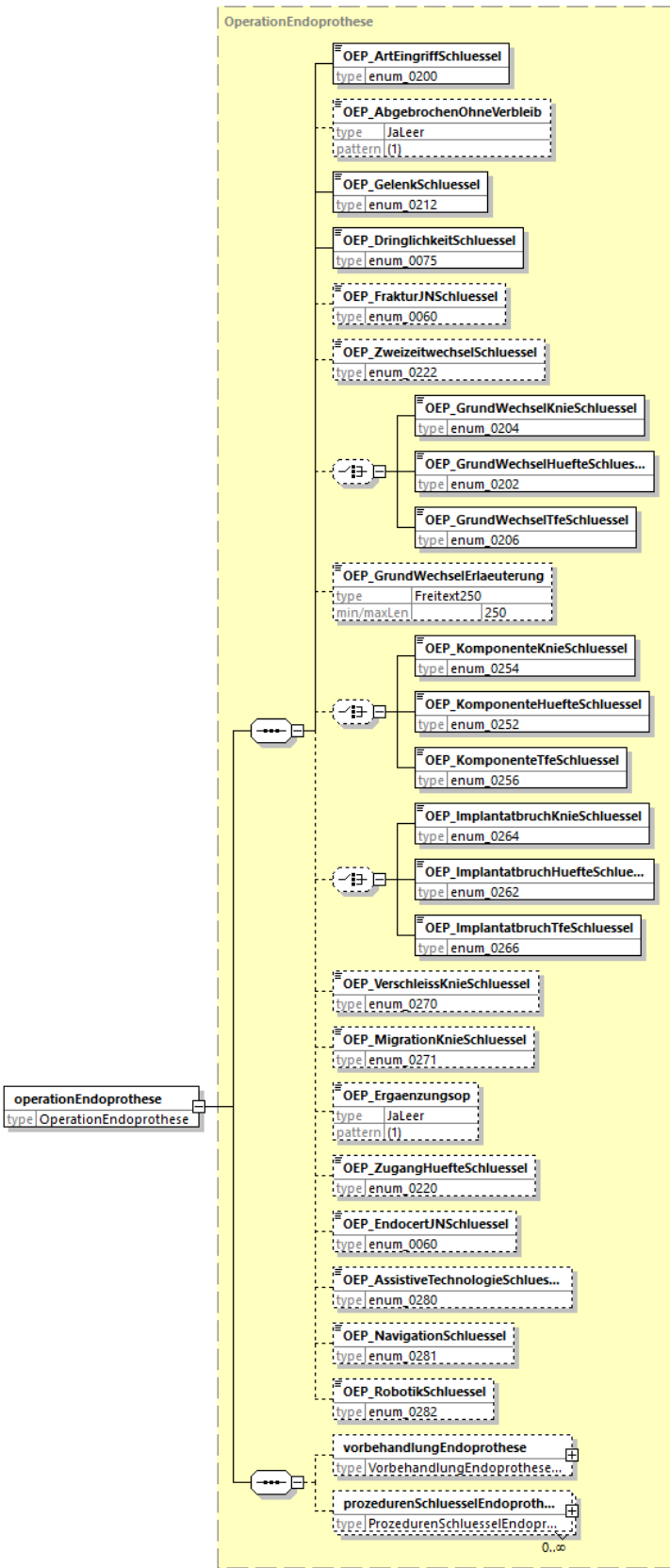

type

[OperationEndoprothese](#)

properties	content complex
children	OEP ArtEingriffSchluessel OEP AbgebrochenOhneVerbleib OEP GelenkSchluessel OEP DringlichkeitSchluessel OEP FrakturJNSchluessel OEP ZweizeitwechselSchluessel OEP GrundWechselKnieSchluessel OEP GrundWechselHuefteSchluessel OEP GrundWechselTfeSchluessel OEP GrundWechselErlaeuterung OEP KomponenteKnieSchluessel OEP KomponenteHuefteSchluessel OEP KomponenteTfeSchluessel OEP ImplantatbruchKnieSchluessel OEP ImplantatbruchHuefteSchluessel OEP ImplantatbruchTfeSchluessel OEP VerschleissKnieSchluessel OEP MigrationKnieSchluessel OEP Ergaenzungsop OEP ZugangHuefteSchluessel OEP EndocertJNSchluessel OEP AssistiveTechnologieSchluessel OEP NavigationSchluessel OEP RobotikSchluessel vorbehandlungEndoprothese prozedurenSchluesselEndoprothese
source	<element name="operationEndoprothese" type="OperationEndoprothese"/>

element Operation/operationAortenklappe

diagram

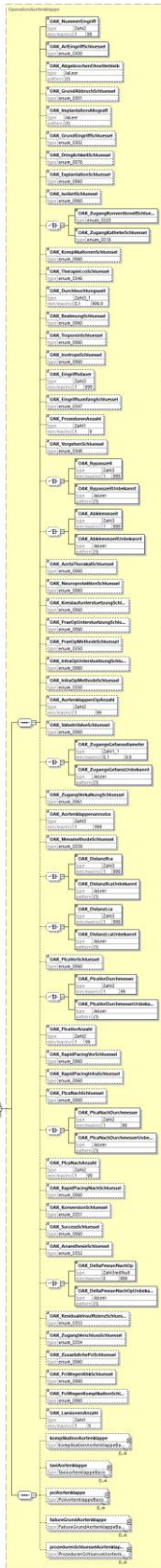

operationAortenklappe
 operationAortenklappe

type	OperationAortenklappe
properties	content complex

children	OAK NummerEingriff OAK ArtEingriffSchluessel OAK AbgebrochenOhneVerbleib OAK GrundAbbruchSchluessel OAK ImplantationAllograft OAK GrundEingriffSchluessel OAK DringlichkeitSchluessel OAK ExplantationSchluessel OAK IsoliertSchluessel OAK ZugangKonventionellSchluessel OAK ZugangKatheterSchluessel OAK KomplikationenSchluessel OAK TherapieLcoSchluessel OAK Durchleuchtungszeit OAK BeatmungSchluessel OAK TroponinSchluessel OAK InotropeSchluessel OAK Eingriffsdauer OAK EingriffsumfangSchluessel OAK ProzedurenAnzahl OAK VorgehenSchluessel OAK Bypasszeit OAK BypasszeitUnbekannt OAK Abklemmzeit OAK AbklemmzeitUnbekannt OAK AortaThorakalSchluessel OAK NeuroprotektionSchluessel OAK KreislaufunterstuetzungSchluessel OAK PraeOpUnterstuetzungSchluessel OAK PraeOpMethodeSchluessel OAK IntraOpUnterstuetzungSchluessel OAK IntraOpMethodeSchluessel OAK AortenklappenOpAnzahl OAK ValveInValveSchluessel OAK ZugangsGefaessdiameter OAK ZugangsGefaessUnbekannt OAK ZugangVerkalkungSchluessel OAK Aortenklappenannulus OAK MessmethodeSchluessel OAK DistanzRca OAK DistanzRcaUnbekannt OAK DistanzLca OAK DistanzLcaUnbekannt OAK PtcaVorSchluessel OAK PtcaVorDurchmesser OAK PtcaVorDurchmesserUnbekannt OAK PtcaVorAnzahl OAK RapidPacingVorSchluessel OAK RapidPacingIntraSchluessel OAK PtcaNachSchluessel OAK PtcaNachDurchmesser OAK PtcaNachDurchmesserUnbekannt OAK PtcaNachAnzahl OAK RapidPacingNachSchluessel OAK KonversionSchluessel OAK SuccessSchluessel OAK AnaesthesieSchluessel OAK DeltaPmeanNachOp OAK DeltaPmeanNachOpUnbekannt OAK ResidualeInsuffizienzSchluessel OAK ZugangVerschlussSchluessel OAK ZusaetzlichePciSchluessel OAK PciWegenKhkSchluessel OAK PciWegenKomplikationSchluessel OAK LaesionenAnzahl komplikationAortenklappe taviAortenklappe pciAortenklappe failureGrundAortenklappe prozedurenSchluesselAortenklappe
source	<element name="operationAortenklappe" type="OperationAortenklappe"/>

element **Operation/artikelidentifikation**

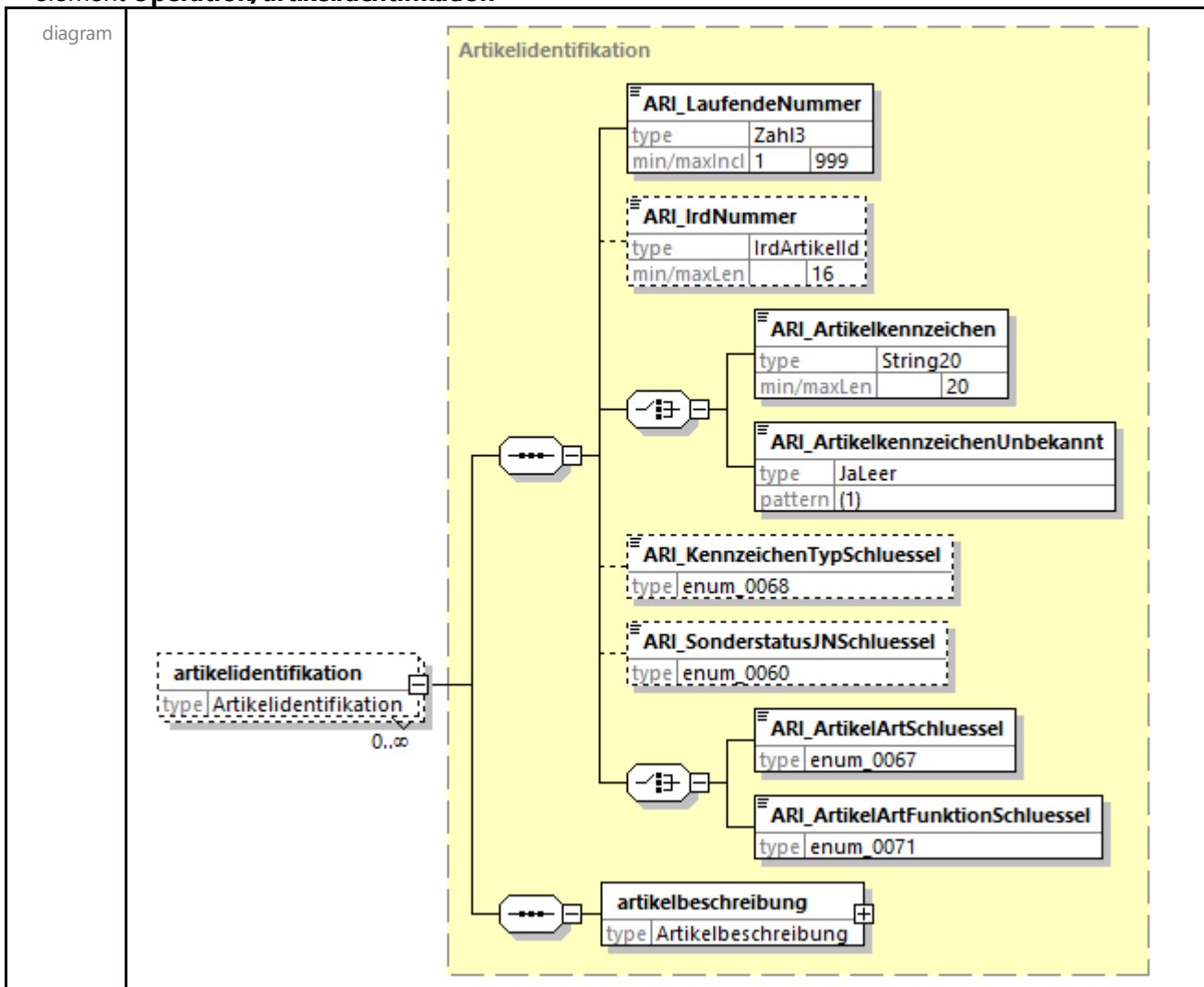

type	Artikelidentifikation
properties	minOcc 0 maxOcc unbounded content complex
children	ARI LaufendeNummer ARI IrdNummer ARI Artikelkennzeichen ARI ArtikelkennzeichenUnbekannt ARI KennzeichenTypSchluessel ARI SonderstatusJNSchluessel ARI ArtikelArtSchluessel ARI ArtikelArtFunktionSchluessel artikelbeschreibung
source	<element name="artikelidentifikation" type="Artikelidentifikation" minOccurs="0" maxOccurs="unbounded"/>

element **Operation/zubehoer**

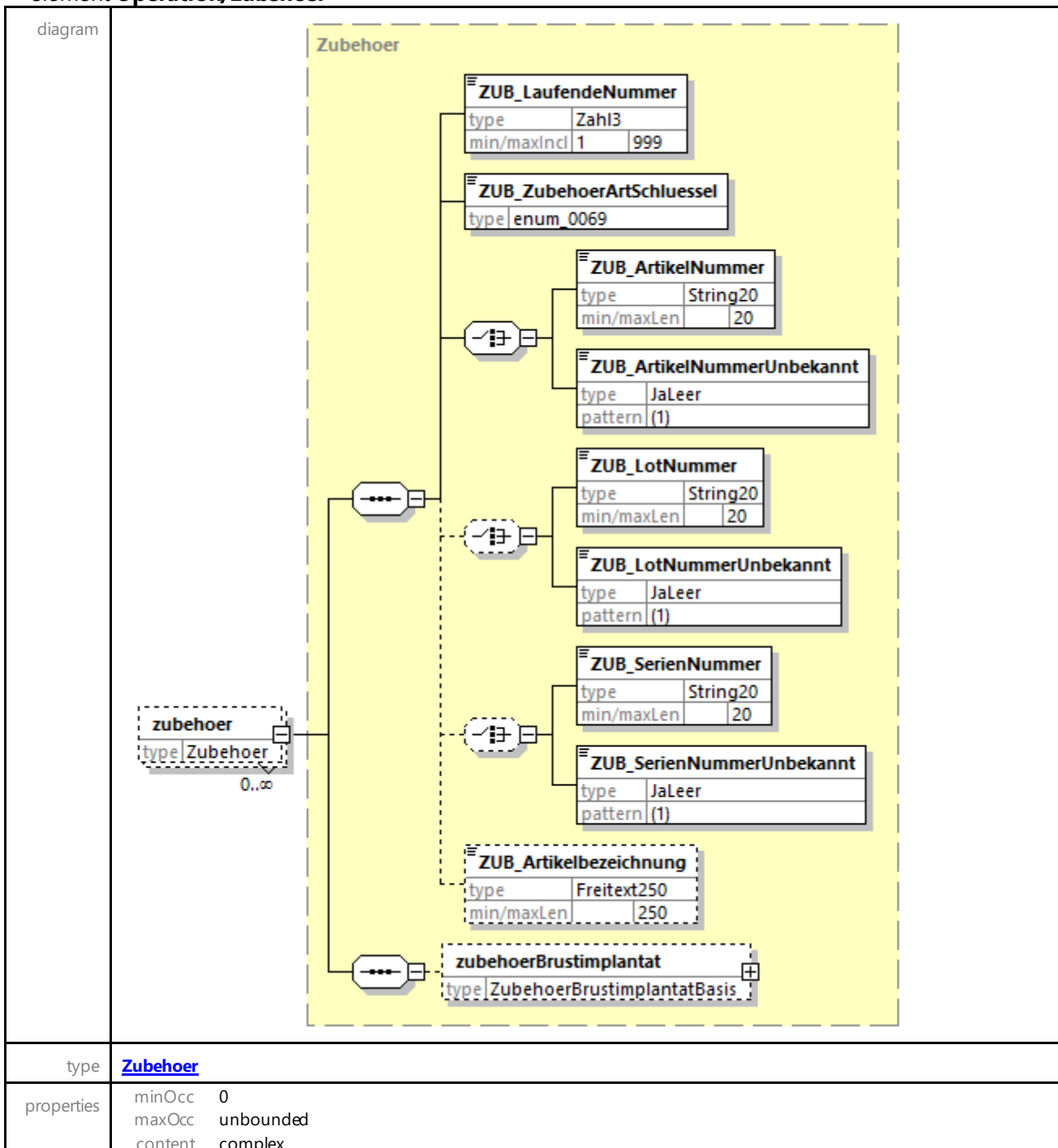

children	ZUB LaufendeNummer ZUB ZubehoerArtSchluessel ZUB ArtikelNummer ZUB ArtikelNummerUnbekannt ZUB LotNummer ZUB LotNummerUnbekannt ZUB SerienNummer ZUB SerienNummerUnbekannt ZUB Artikelbezeichnung zubehoerBrustimplantat
source	<element name="zubehoer" type="Zubehoer" minOccurs="0" maxOccurs="unbounded"/>

complexType **Entlassung**

diagram	
namespace	http://xml.ir-d.de/emg
type	extension of EntlassungBasis
properties	base EntlassungBasis
children	ENT Datum ENT GrundSchluessel diagnoseBrustimplantat diagnoseEndoprothese diagnoseAortenklappe
used by	element Fall/entlassung
source	<pre><complexType name="Entlassung"> <complexContent> <extension base="EntlassungBasis"> <sequence> <element name="diagnoseBrustimplantat" type="DiagnoseBrustimplantatBasis" minOccurs="0" maxOccurs="unbounded"/> <element name="diagnoseEndoprothese" type="DiagnoseEndoprotheseBasis" minOccurs="0" maxOccurs="unbounded"/> <element name="diagnoseAortenklappe" type="DiagnoseAortenklappeBasis" minOccurs="0" maxOccurs="unbounded"/> </sequence> </extension> </complexContent> </complexType></pre>

element **Entlassung/diagnoseBrustimplantat**

diagram	
type	DiagnoseBrustimplantatBasis
properties	minOcc 0 maxOcc unbounded content complex
children	DBI_IcdSchluessel
source	<code><element name="diagnoseBrustimplantat" type="DiagnoseBrustimplantatBasis" minOccurs="0" maxOccurs="unbounded"/></code>

element **Entlassung/diagnoseEndoprothese**

diagram	
type	DiagnoseEndoprotheseBasis
properties	minOcc 0 maxOcc unbounded content complex
children	DEP_IcdSchluessel
source	<code><element name="diagnoseEndoprothese" type="DiagnoseEndoprotheseBasis" minOccurs="0" maxOccurs="unbounded"/></code>

element **Entlassung/diagnoseAortenklappe**

diagram	
type	DiagnoseAortenklappeBasis
properties	minOcc 0 maxOcc unbounded content complex
children	DAK_IcdSchluessel
source	<code><element name="diagnoseAortenklappe" type="DiagnoseAortenklappeBasis" minOccurs="0" maxOccurs="unbounded"/></code>

complexType PostoperationAortenklappe

diagram

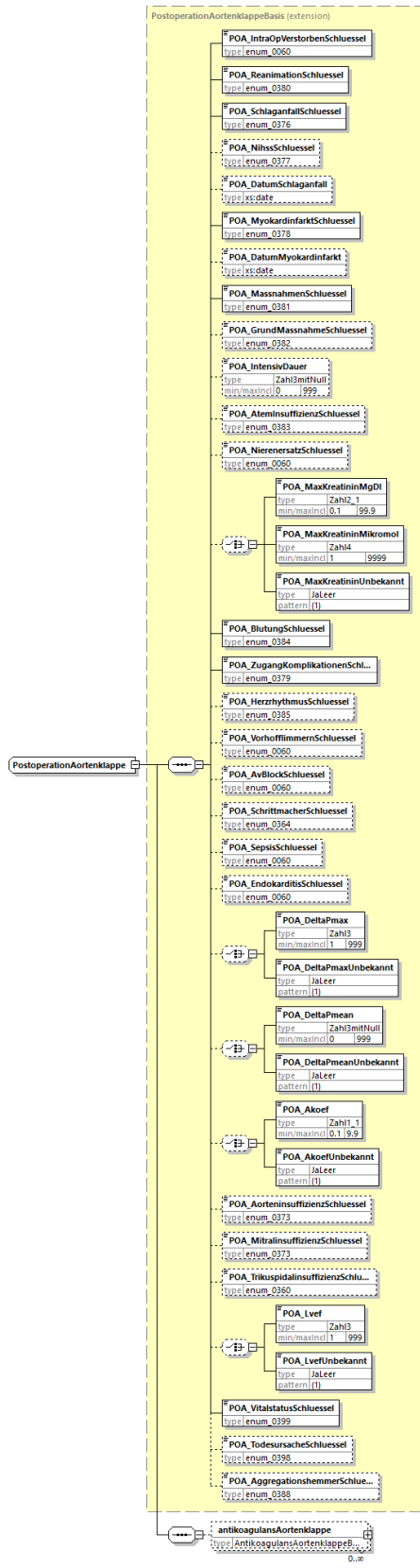

namespace	http://xml.ir-d.de/emg
type	extension of PostoperationAortenklappeBasis

properties	base PostoperationAortenklappeBasis
children	POA IntraOpVerstorbenSchluessel POA ReanimationSchluessel POA SchlaganfallSchluessel POA NihssSchluessel POA DatumSchlaganfall POA MyokardinfarktSchluessel POA DatumMyokardinfarkt POA MassnahmenSchluessel POA GrundMassnahmeSchluessel POA IntensivDauer POA AtemInsuffizienzSchluessel POA NierenersatzSchluessel POA MaxKreatininMgDL POA MaxKreatininMikromol POA MaxKreatininUnbekannt POA BlutungSchluessel POA ZugangKomplikationenSchluessel POA HerzrhythmusSchluessel POA VorhofflimmernSchluessel POA AvBlockSchluessel POA SchrittmacherSchluessel POA SepsisSchluessel POA EndokarditisSchluessel POA DeltaPmax POA DeltaPmaxUnbekannt POA DeltaPmean POA DeltaPmeanUnbekannt POA Akoef POA AkoefUnbekannt POA AorteninsuffizienzSchluessel POA MitralinsuffizienzSchluessel POA TrikuspidalinsuffizienzSchluessel POA Lvef POA LvefUnbekannt POA VitalstatusSchluessel POA TodesursacheSchluessel POA AggregationshemmerSchluessel antikoagulansAortenklappe
used by	element Fall/postoperationAortenklappe
source	<pre><complexType name="PostoperationAortenklappe"> <complexContent> <extension base="PostoperationAortenklappeBasis"> <sequence> <element name="antikoagulansAortenklappe" type="AntikoagulansAortenklappeBasis" minOccurs="0" maxOccurs="unbounded"/> </sequence> </extension> </complexContent> </complexType></pre>

element [PostoperationAortenklappe/antikoagulansAortenklappe](#)

diagram	
type	AntikoagulansAortenklappeBasis
properties	minOcc 0 maxOcc unbounded content complex
children	AKA AntikoagulansSchluessel
source	<pre><element name="antikoagulansAortenklappe" type="AntikoagulansAortenklappeBasis" minOccurs="0" maxOccurs="unbounded"/></pre>

simpleType [enum_0044](#)

namespace	http://xml.ir-d.de/stn		
type	restriction of string		
properties	base xs:string		
facets	Kind	Value	Annotation
	enumeration	0044001	documentation 1= normaler, sonst gesunder Patient
	enumeration	0044002	documentation 2= Patient mit leichter Allgemeinerkrankung
	enumeration	0044003	documentation 3= Patient mit schwerer Allgemeinerkrankung
	enumeration	0044004	documentation

	<p>4= Patient mit schwerer Allgemeinerkrankung, die eine ständige Lebensbedrohung darstellt</p> <p>documentation</p> <p>5= moribunder Patient, der ohne die Operation voraussichtlich nicht überleben wird</p>
enumeration 0044005	
annotation	documentation Kat_ASA
source	<pre> <simpleType name="enum_0044"> <annotation> <documentation>Kat_ASA</documentation> </annotation> <restriction base="xs:string"> <enumeration value="0044001"> <annotation> <documentation>1= normaler, sonst gesunder Patient</documentation> </annotation> </enumeration> <enumeration value="0044002"> <annotation> <documentation>2= Patient mit leichter Allgemeinerkrankung</documentation> </annotation> </enumeration> <enumeration value="0044003"> <annotation> <documentation>3= Patient mit schwerer Allgemeinerkrankung</documentation> </annotation> </enumeration> <enumeration value="0044004"> <annotation> <documentation>4= Patient mit schwerer Allgemeinerkrankung, die eine ständige Lebensbedrohung darstellt</documentation> </annotation> </enumeration> <enumeration value="0044005"> <annotation> <documentation>5= moribunder Patient, der ohne die Operation voraussichtlich nicht überleben wird</documentation> </annotation> </enumeration> </restriction> </simpleType> </pre>

simpleType enum_0050

namespace	http://xml.ir-d.de/stn		
type	restriction of string		
properties	base xs:string		
facets	Kind	Value	Annotation
	enumeration	0050001	documentation rechts
	enumeration	0050002	documentation links
annotation	documentation Kat_RechtsLinks		
source	<pre> <simpleType name="enum_0050"> <annotation> </pre>		

	<pre> <documentation>Kat_RechtsLinks</documentation> </annotation> <restriction base="xs:string"> <enumeration value="0050001"> <annotation> <documentation>rechts</documentation> </annotation> </enumeration> <enumeration value="0050002"> <annotation> <documentation>links</documentation> </annotation> </enumeration> </restriction> </simpleType> </pre>
--	--

simpleType enum_0060

namespace	http://xml.ir-d.de/stn		
type	restriction of string		
properties	base xs:string		
facets	Kind	Value	Annotation
	enumeration	0060001	documentation ja
	enumeration	0060002	documentation nein
annotation	documentation Kat_JaNein		
source	<pre> <simpleType name="enum_0060"> <annotation> <documentation>Kat_JaNein</documentation> </annotation> <restriction base="xs:string"> <enumeration value="0060001"> <annotation> <documentation>ja</documentation> </annotation> </enumeration> <enumeration value="0060002"> <annotation> <documentation>nein</documentation> </annotation> </enumeration> </restriction> </simpleType> </pre>		

simpleType enum_0061

namespace	http://xml.ir-d.de/stn		
type	restriction of string		
properties	base xs:string		
facets	Kind	Value	Annotation
	enumeration	0061001	documentation ja

	enumeration 0061002 documentation nein enumeration 0061099 documentation unbekannt
annotation	documentation Kat_JaNeinUnbekannt
source	<pre> <simpleType name="enum_0061"> <annotation> <documentation>Kat_JaNeinUnbekannt</documentation> </annotation> <restriction base="xs:string"> <enumeration value="0061001"> <annotation> <documentation>ja</documentation> </annotation> </enumeration> <enumeration value="0061002"> <annotation> <documentation>nein</documentation> </annotation> </enumeration> <enumeration value="0061099"> <annotation> <documentation>unbekannt</documentation> </annotation> </enumeration> </restriction> </simpleType> </pre>

simpleType enum 0062

namespace	http://xml.ir-d.de/stn		
type	restriction of string		
properties	base xs:string		
facets	Kind	Value	Annotation
	enumeration	0062001	documentation Stück
	enumeration	0062002	documentation g
	enumeration	0062003	documentation mg
	enumeration	0062004	documentation l
	enumeration	0062005	documentation ml
	enumeration	0062006	documentation cm ³
	enumeration	0062007	documentation mm
	enumeration	0062008	documentation cm
	enumeration	0062009	documentation dm
	enumeration	0062010	documentation m
	enumeration	0062042	documentation andere
annotation	documentation Kat_Einheit		

source

```
<simpleType name="enum_0062">
  <annotation>
    <documentation>Kat_Einheit</documentation>
  </annotation>
  <restriction base="xs:string">
    <enumeration value="0062001">
      <annotation>
        <documentation>Stück</documentation>
      </annotation>
    </enumeration>
    <enumeration value="0062002">
      <annotation>
        <documentation>g</documentation>
      </annotation>
    </enumeration>
    <enumeration value="0062003">
      <annotation>
        <documentation>mg</documentation>
      </annotation>
    </enumeration>
    <enumeration value="0062004">
      <annotation>
        <documentation>l</documentation>
      </annotation>
    </enumeration>
    <enumeration value="0062005">
      <annotation>
        <documentation>ml</documentation>
      </annotation>
    </enumeration>
    <enumeration value="0062006">
      <annotation>
        <documentation>cm3</documentation>
      </annotation>
    </enumeration>
    <enumeration value="0062007">
      <annotation>
        <documentation>mm</documentation>
      </annotation>
    </enumeration>
    <enumeration value="0062008">
      <annotation>
        <documentation>cm</documentation>
      </annotation>
    </enumeration>
    <enumeration value="0062009">
      <annotation>
        <documentation>dm</documentation>
      </annotation>
    </enumeration>
    <enumeration value="0062010">
      <annotation>
        <documentation>m</documentation>
      </annotation>
    </enumeration>
    <enumeration value="0062042">
      <annotation>
        <documentation>andere</documentation>
      </annotation>
    </enumeration>
  </restriction>
</simpleType>
```

	<pre> </enumeration> </restriction> </simpleType> </pre>
--	--

simpleType enum_0065

namespace	http://xml.ir-d.de/stn		
type	restriction of string		
properties	base xs:string		
facets	Kind	Value	Annotation
	enumeration	0065001	documentation stationär
	enumeration	0065002	documentation teilstationär
	enumeration	0065003	documentation ambulant
annotation	documentation Kat_ArtAufenthalt		
source	<pre> <simpleType name="enum_0065"> <annotation> <documentation>Kat_ArtAufenthalt</documentation> </annotation> <restriction base="xs:string"> <enumeration value="0065001"> <annotation> <documentation>stationär</documentation> </annotation> </enumeration> <enumeration value="0065002"> <annotation> <documentation>teilstationär</documentation> </annotation> </enumeration> <enumeration value="0065003"> <annotation> <documentation>ambulant</documentation> </annotation> </enumeration> </restriction> </simpleType> </pre>		

simpleType enum_0067

namespace	http://xml.ir-d.de/stn		
type	restriction of string		
properties	base xs:string		
facets	Kind	Value	Annotation
	enumeration	0067001	documentation Implantat
	enumeration	0067002	documentation Explantat
annotation	documentation Kat_ArtArtikel		
source	<pre> <simpleType name="enum_0067"> </pre>		

	<pre> <annotation> <documentation>Kat_ArtArtikel</documentation> </annotation> <restriction base="xs:string"> <enumeration value="0067001"> <annotation> <documentation>Implantat</documentation> </annotation> </enumeration> <enumeration value="0067002"> <annotation> <documentation>Explantat</documentation> </annotation> </enumeration> </restriction> </simpleType> </pre>
--	---

simpleType enum_0068

namespace	http://xml.ir-d.de/stn		
type	restriction of string		
properties	base xs:string		
facets	Kind	Value	Annotation
	enumeration	0068001	documentation UDI
	enumeration	0068002	documentation Referenz (REF)
annotation	documentation Kat_KennzeichenTyp		
source	<pre> <simpleType name="enum_0068"> <annotation> <documentation>Kat_KennzeichenTyp</documentation> </annotation> <restriction base="xs:string"> <enumeration value="0068001"> <annotation> <documentation>UDI</documentation> </annotation> </enumeration> <enumeration value="0068002"> <annotation> <documentation>Referenz (REF)</documentation> </annotation> </enumeration> </restriction> </simpleType> </pre>		

simpleType enum_0069

namespace	http://xml.ir-d.de/stn		
type	restriction of string		
properties	base xs:string		
facets	Kind	Value	Annotation
	enumeration	0069001	documentation

	enumeration 0069002 Implantat documentation Explantat
annotation	documentation Kat_ArtZubehoer
source	<pre> <simpleType name="enum_0069"> <annotation> <documentation>Kat_ArtZubehoer</documentation> </annotation> <restriction base="xs:string"> <enumeration value="0069001"> <annotation> <documentation>Implantat</documentation> </annotation> </enumeration> <enumeration value="0069002"> <annotation> <documentation>Explantat</documentation> </annotation> </enumeration> </restriction> </simpleType> </pre>

simpleType enum_0070

namespace	http://xml.ir-d.de/stn		
type	restriction of string		
properties	base xs:string		
facets	Kind	Value	Annotation
	enumeration	0070001	documentation weiblich
	enumeration	0070002	documentation männlich
	enumeration	0070003	documentation divers
	enumeration	0070042	documentation unbestimmt
annotation	documentation Kat_Geschlecht		
source	<pre> <simpleType name="enum_0070"> <annotation> <documentation>Kat_Geschlecht</documentation> </annotation> <restriction base="xs:string"> <enumeration value="0070001"> <annotation> <documentation>weiblich</documentation> </annotation> </enumeration> <enumeration value="0070002"> <annotation> <documentation>männlich</documentation> </annotation> </enumeration> <enumeration value="0070003"> <annotation> <documentation>divers</documentation> </annotation> </enumeration> </restriction> </simpleType> </pre>		

	<pre> </annotation> </enumeration> <enumeration value="0070042"> <annotation> <documentation>unbestimmt</documentation> </annotation> </enumeration> </restriction> </simpleType> </pre>
--	--

simpleType enum_0071

namespace	http://xml.ir-d.de/stn		
type	restriction of string		
properties	base xs:string		
facets	Kind	Value	Annotation
	enumeration	0071001	documentation Implantat
	enumeration	0071002	documentation Explantat
	enumeration	0071003	documentation Degeneriertes/defektes Produkt, das funktionslos im Körper verbleibt
annotation	documentation Kat ArtikelArtFunktion		
source	<pre> <simpleType name="enum_0071"> <annotation> <documentation>Kat_ArtikelArtFunktion</documentation> </annotation> <restriction base="xs:string"> <enumeration value="0071001"> <annotation> <documentation>Implantat</documentation> </annotation> </enumeration> <enumeration value="0071002"> <annotation> <documentation>Explantat</documentation> </annotation> </enumeration> <enumeration value="0071003"> <annotation> <documentation>Degeneriertes/defektes Produkt, das funktionslos im Körper verbleibt</documentation> </annotation> </enumeration> </restriction> </simpleType> </pre>		

simpleType enum_0075

namespace	http://xml.ir-d.de/stn		
type	restriction of string		
properties	base xs:string		

facets	<table border="1"> <thead> <tr> <th>Kind</th> <th>Value</th> <th>Annotation</th> </tr> </thead> <tbody> <tr> <td>enumeration</td> <td>0075001</td> <td>documentation elektiv</td> </tr> <tr> <td>enumeration</td> <td>0075002</td> <td>documentation dringlich</td> </tr> <tr> <td>enumeration</td> <td>0075003</td> <td>documentation Notfall</td> </tr> </tbody> </table>	Kind	Value	Annotation	enumeration	0075001	documentation elektiv	enumeration	0075002	documentation dringlich	enumeration	0075003	documentation Notfall
Kind	Value	Annotation											
enumeration	0075001	documentation elektiv											
enumeration	0075002	documentation dringlich											
enumeration	0075003	documentation Notfall											
annotation	documentation Kat_Dringlichkeit												
source	<pre><simpleType name="enum_0075"> <annotation> <documentation>Kat_Dringlichkeit</documentation> </annotation> <restriction base="xs:string"> <enumeration value="0075001"> <annotation> <documentation>elektiv</documentation> </annotation> </enumeration> <enumeration value="0075002"> <annotation> <documentation>dringlich</documentation> </annotation> </enumeration> <enumeration value="0075003"> <annotation> <documentation>Notfall</documentation> </annotation> </enumeration> </restriction> </simpleType></pre>												

simpleType enum_0076

namespace	http://xml.ir-d.de/stn															
type	restriction of string															
properties	base xs:string															
facets	<table border="1"> <thead> <tr> <th>Kind</th> <th>Value</th> <th>Annotation</th> </tr> </thead> <tbody> <tr> <td>enumeration</td> <td>0076001</td> <td>documentation elektiv</td> </tr> <tr> <td>enumeration</td> <td>0076002</td> <td>documentation dringlich</td> </tr> <tr> <td>enumeration</td> <td>0076003</td> <td>documentation Notfall</td> </tr> <tr> <td>enumeration</td> <td>0076004</td> <td>documentation Notfall (Reanimation / ultima ratio)</td> </tr> </tbody> </table>	Kind	Value	Annotation	enumeration	0076001	documentation elektiv	enumeration	0076002	documentation dringlich	enumeration	0076003	documentation Notfall	enumeration	0076004	documentation Notfall (Reanimation / ultima ratio)
Kind	Value	Annotation														
enumeration	0076001	documentation elektiv														
enumeration	0076002	documentation dringlich														
enumeration	0076003	documentation Notfall														
enumeration	0076004	documentation Notfall (Reanimation / ultima ratio)														
annotation	documentation Kat_Dringlichkeit_Reanimation															
source	<pre><simpleType name="enum_0076"> <annotation> <documentation>Kat_Dringlichkeit_Reanimation</documentation> </annotation> <restriction base="xs:string"> <enumeration value="0076001"> <annotation> <documentation>elektiv</documentation> </annotation> </enumeration> </restriction> </simpleType></pre>															

	<pre> </enumeration> <enumeration value="0076002"> <annotation> <documentation>dringlich</documentation> </annotation> </enumeration> <enumeration value="0076003"> <annotation> <documentation>Notfall</documentation> </annotation> </enumeration> <enumeration value="0076004"> <annotation> <documentation>Notfall (Reanimation / ultima ratio)</documentation> </annotation> </enumeration> </restriction> </simpleType> </pre>
--	--

simpleType enum_0080

namespace	http://xml.ir-d.de/stn		
type	restriction of string		
properties	base xs:string		
facets	Kind	Value	Annotation
	enumeration	0080001	documentation Endoprothese Hüfte/Knie
	enumeration	0080002	documentation Brustimplantat
	enumeration	0080003	documentation Aortenklappenprothese
annotation	documentation Kat Implantattyp		
source	<pre> <simpleType name="enum_0080"> <annotation> <documentation>Kat_Implantattyp</documentation> </annotation> <restriction base="xs:string"> <enumeration value="0080001"> <annotation> <documentation>Endoprothese Hüfte/Knie</documentation> </annotation> </enumeration> <enumeration value="0080002"> <annotation> <documentation>Brustimplantat</documentation> </annotation> </enumeration> <enumeration value="0080003"> <annotation> <documentation>Aortenklappenprothese</documentation> </annotation> </enumeration> </restriction> </simpleType> </pre>		

simpleType enum_0100

namespace	http://xml.ir-d.de/stn		
type	restriction of string		
properties	base xs:string		
facets	Kind	Value	Annotation
	enumeration	0100002	documentation Austausch Expander gegen dauerhaftes Brustimplantat
	enumeration	0100003	documentation Wechsel
	enumeration	0100004	documentation Nur Explantation
	enumeration	0100005	documentation Ersteingriff
	enumeration	0100006	documentation Zweizeitige Implantation
annotation	documentation Kat_BI_ArtEingriff		
source	<pre> <simpleType name="enum_0100"> <annotation> <documentation>Kat_BI_ArtEingriff</documentation> </annotation> <restriction base="xs:string"> <enumeration value="0100002"> <annotation> <documentation>Austausch Expander gegen dauerhaftes Brustimplantat</documentation> </annotation> </enumeration> <enumeration value="0100003"> <annotation> <documentation>Wechsel</documentation> </annotation> </enumeration> <enumeration value="0100004"> <annotation> <documentation>Nur Explantation</documentation> </annotation> </enumeration> <enumeration value="0100005"> <annotation> <documentation>Ersteingriff</documentation> </annotation> </enumeration> <enumeration value="0100006"> <annotation> <documentation>Zweizeitige Implantation</documentation> </annotation> </enumeration> </restriction> </simpleType> </pre>		

simpleType enum_0102

namespace	http://xml.ir-d.de/stn
type	restriction of string

properties	base xs:string															
facets	<table border="1"> <thead> <tr> <th>Kind</th> <th>Value</th> <th>Annotation</th> </tr> </thead> <tbody> <tr> <td>enumeration</td> <td>0102001</td> <td>documentation kosmetische Augmentation</td> </tr> <tr> <td>enumeration</td> <td>0102002</td> <td>documentation Rekonstruktion, benigne</td> </tr> <tr> <td>enumeration</td> <td>0102003</td> <td>documentation Rekonstruktion nach Mastektomie aufgrund eines Karzinoms</td> </tr> <tr> <td>enumeration</td> <td>0102004</td> <td>documentation Rekonstruktion nach risikoreduzierender Mastektomie</td> </tr> </tbody> </table>	Kind	Value	Annotation	enumeration	0102001	documentation kosmetische Augmentation	enumeration	0102002	documentation Rekonstruktion, benigne	enumeration	0102003	documentation Rekonstruktion nach Mastektomie aufgrund eines Karzinoms	enumeration	0102004	documentation Rekonstruktion nach risikoreduzierender Mastektomie
Kind	Value	Annotation														
enumeration	0102001	documentation kosmetische Augmentation														
enumeration	0102002	documentation Rekonstruktion, benigne														
enumeration	0102003	documentation Rekonstruktion nach Mastektomie aufgrund eines Karzinoms														
enumeration	0102004	documentation Rekonstruktion nach risikoreduzierender Mastektomie														
annotation	documentation Kat_BI_GrundPrimaereingriff															
source	<pre> <simpleType name="enum_0102"> <annotation> <documentation>Kat_BI_GrundPrimaereingriff</documentation> </annotation> <restriction base="xs:string"> <enumeration value="0102001"> <annotation> <documentation>kosmetische Augmentation</documentation> </annotation> </enumeration> <enumeration value="0102002"> <annotation> <documentation>Rekonstruktion, benigne</documentation> </annotation> </enumeration> <enumeration value="0102003"> <annotation> <documentation>Rekonstruktion nach Mastektomie aufgrund eines Karzinoms</documentation> </annotation> </enumeration> <enumeration value="0102004"> <annotation> <documentation>Rekonstruktion nach risikoreduzierender Mastektomie</documentation> </annotation> </enumeration> </restriction> </simpleType> </pre>															

simpleType enum_0103

namespace	http://xml.ir-d.de/stn																		
type	restriction of string																		
properties	base xs:string																		
facets	<table border="1"> <thead> <tr> <th>Kind</th> <th>Value</th> <th>Annotation</th> </tr> </thead> <tbody> <tr> <td>enumeration</td> <td>0103001</td> <td>documentation simultane Lappendeckung</td> </tr> <tr> <td>enumeration</td> <td>0103002</td> <td>documentation simultane Eigenfettransplantation</td> </tr> <tr> <td>enumeration</td> <td>0103003</td> <td>documentation simultane Mastopexie</td> </tr> <tr> <td>enumeration</td> <td>0103005</td> <td>documentation simultane Mastektomie, Ablatio / hautsparend</td> </tr> <tr> <td>enumeration</td> <td>0103006</td> <td>documentation</td> </tr> </tbody> </table>	Kind	Value	Annotation	enumeration	0103001	documentation simultane Lappendeckung	enumeration	0103002	documentation simultane Eigenfettransplantation	enumeration	0103003	documentation simultane Mastopexie	enumeration	0103005	documentation simultane Mastektomie, Ablatio / hautsparend	enumeration	0103006	documentation
Kind	Value	Annotation																	
enumeration	0103001	documentation simultane Lappendeckung																	
enumeration	0103002	documentation simultane Eigenfettransplantation																	
enumeration	0103003	documentation simultane Mastopexie																	
enumeration	0103005	documentation simultane Mastektomie, Ablatio / hautsparend																	
enumeration	0103006	documentation																	

	<p>enumeration 0103007 simultane Mastektomie, nippelerhaltend documentation Axilla-Dissektion</p> <p>enumeration 0103008 simultane Mastektomie, nippelerhaltend documentation Drainage</p>
annotation	documentation Kat_BI_OperationsdetailPrimaereingriff
source	<pre> <simpleType name="enum_0103"> <annotation> <documentation>Kat_BI_OperationsdetailPrimaereingriff</documentation> </annotation> <restriction base="xs:string"> <enumeration value="0103001"> <annotation> <documentation>simultane Lappendeckung</documentation> </annotation> </enumeration> <enumeration value="0103002"> <annotation> <documentation>simultane Eigenfetttransplantation</documentation> </annotation> </enumeration> <enumeration value="0103003"> <annotation> <documentation>simultane Mastopexie</documentation> </annotation> </enumeration> <enumeration value="0103005"> <annotation> <documentation>simultane Mastektomie, Ablatio / hautsparend</documentation> </annotation> </enumeration> <enumeration value="0103006"> <annotation> <documentation>simultane Mastektomie, nippelerhaltend</documentation> </annotation> </enumeration> <enumeration value="0103007"> <annotation> <documentation>Axilla-Dissektion</documentation> </annotation> </enumeration> <enumeration value="0103008"> <annotation> <documentation>Drainage</documentation> </annotation> </enumeration> </restriction> </simpleType> </pre>

simpleType enum_0104

namespace	http://xml.ir-d.de/stn
type	restriction of string
properties	base xs:string

facets	Kind enumeration	Value 0104001	Annotation documentation Austausch Expander gegen dauerhaftes Brustimplantat
annotation	documentation Kat_BI_GrundAustausch		
source	<pre><simpleType name="enum_0104"> <annotation> <documentation>Kat_BI_GrundAustausch</documentation> </annotation> <restriction base="xs:string"> <enumeration value="0104001"> <annotation> <documentation>Austausch Expander gegen dauerhaftes Brustimplantat</documentation> </annotation> </enumeration> </restriction> </simpleType></pre>		

simpleType enum_0105

namespace	http://xml.ir-d.de/stn		
type	restriction of string		
properties	base xs:string		
facets	Kind	Value	Annotation
	enumeration	0105001	documentation simultane Lappendeckung
	enumeration	0105002	documentation simultane Eigenfetttransplantation
	enumeration	0105003	documentation simultane Mastopexie
	enumeration	0105008	documentation Drainage
	enumeration	0105009	documentation Kapsulektomie, komplett
	enumeration	0105010	documentation Kapsulektomie, partiell
	enumeration	0105011	documentation Neopocket
annotation	documentation Kat_BI_OperationsdetailAustausch		
source	<pre><simpleType name="enum_0105"> <annotation> <documentation>Kat_BI_OperationsdetailAustausch</documentation> </annotation> <restriction base="xs:string"> <enumeration value="0105001"> <annotation> <documentation>simultane Lappendeckung</documentation> </annotation> </enumeration> <enumeration value="0105002"> <annotation> <documentation>simultane Eigenfetttransplantation</documentation> </annotation> </enumeration> <enumeration value="0105003"> <annotation></pre>		

	<pre> <documentation>simultane Mastopexie</documentation> </annotation> </enumeration> <enumeration value="0105008"> <annotation> <documentation>Drainage</documentation> </annotation> </enumeration> <enumeration value="0105009"> <annotation> <documentation>Kapsulektomie, komplett</documentation> </annotation> </enumeration> <enumeration value="0105010"> <annotation> <documentation>Kapsulektomie, partiell</documentation> </annotation> </enumeration> <enumeration value="0105011"> <annotation> <documentation>Neopocket</documentation> </annotation> </enumeration> </restriction> </simpleType> </pre>
--	---

simpleType enum_0106

namespace	http://xml.ir-d.de/stn		
type	restriction of string		
properties	base xs:string		
facets	Kind	Value	Annotation
	enumeration	0106001	documentation Patientenwunsch
	enumeration	0106002	documentation asymptomatisch
	enumeration	0106003	documentation Komplikation
annotation	documentation Kat_BI_GrundRevisionExplantation		
source	<pre> <simpleType name="enum_0106"> <annotation> <documentation>Kat_BI_GrundRevisionExplantation</documentation> </annotation> <restriction base="xs:string"> <enumeration value="0106001"> <annotation> <documentation>Patientenwunsch</documentation> </annotation> </enumeration> <enumeration value="0106002"> <annotation> <documentation>asymptomatisch</documentation> </annotation> </enumeration> <enumeration value="0106003"> <annotation> </pre>		

	<pre> <documentation>Komplikation</documentation> </annotation> </enumeration> </restriction> </simpleType> </pre>
--	--

simpleType enum_0107

namespace	http://xml.ir-d.de/stn		
type	restriction of string		
properties	base xs:string		
facets	Kind	Value	Annotation
	enumeration	0107001	documentation simultane Lappendeckung
	enumeration	0107002	documentation simultane Eigenfetttransplantation
	enumeration	0107003	documentation simultane Mastopexie
	enumeration	0107005	documentation simultane Mastektomie, Ablatio / hautsparend
	enumeration	0107006	documentation simultane Mastektomie, nippelerhaltend
	enumeration	0107007	documentation Axilla-Dissektion
	enumeration	0107008	documentation Drainage
	enumeration	0107009	documentation Kapsulektomie, komplett
	enumeration	0107010	documentation Kapsulektomie, partiell
	enumeration	0107011	documentation Neopocket
annotation	documentation Kat_BI_OperationsdetailRevision		
source	<pre> <simpleType name="enum_0107"> <annotation> <documentation>Kat_BI_OperationsdetailRevision</documentation> </annotation> <restriction base="xs:string"> <enumeration value="0107001"> <annotation> <documentation>simultane Lappendeckung</documentation> </annotation> </enumeration> <enumeration value="0107002"> <annotation> <documentation>simultane Eigenfetttransplantation</documentation> </annotation> </enumeration> <enumeration value="0107003"> <annotation> <documentation>simultane Mastopexie</documentation> </annotation> </enumeration> <enumeration value="0107005"> <annotation> <documentation>simultane Mastektomie, Ablatio / hautsparend</documentation> </pre>		

```

</annotation>
</enumeration>
<enumeration value="0107006">
  <annotation>
    <documentation>simultane Mastektomie, nippelerhaltend</documentation>
  </annotation>
</enumeration>
<enumeration value="0107007">
  <annotation>
    <documentation>Axilla-Dissektion</documentation>
  </annotation>
</enumeration>
<enumeration value="0107008">
  <annotation>
    <documentation>Drainage</documentation>
  </annotation>
</enumeration>
<enumeration value="0107009">
  <annotation>
    <documentation>Kapsulektomie, komplett</documentation>
  </annotation>
</enumeration>
<enumeration value="0107010">
  <annotation>
    <documentation>Kapsulektomie, partiell</documentation>
  </annotation>
</enumeration>
<enumeration value="0107011">
  <annotation>
    <documentation>Neopocket</documentation>
  </annotation>
</enumeration>
</restriction>
</simpleType>

```

simpleType enum_0110

namespace	http://xml.lir-d.de/stn		
type	restriction of string		
properties	base xs:string		
facets	Kind	Value	Annotation
	enumeration	0110001	documentation Bestrahlung
annotation	documentation Kat_BI_VorbehandlungLokal		
source	<pre> <simpleType name="enum_0110"> <annotation> <documentation>Kat_BI_VorbehandlungLokal</documentation> </annotation> <restriction base="xs:string"> <enumeration value="0110001"> <annotation> <documentation>Bestrahlung</documentation> </annotation> </enumeration> </restriction> </pre>		

	<code></simpleType></code>
--	----------------------------------

simpleType enum_0111

namespace	http://xml.ir-d.de/stn												
type	restriction of string												
properties	base xs:string												
facets	<table><thead><tr><th>Kind</th><th>Value</th><th>Annotation</th></tr></thead><tbody><tr><td>enumeration</td><td>0111001</td><td>documentation nein</td></tr><tr><td>enumeration</td><td>0111002</td><td>documentation Lipofilling</td></tr><tr><td>enumeration</td><td>0111003</td><td>documentation Eigengewebstrekonstruktion</td></tr></tbody></table>	Kind	Value	Annotation	enumeration	0111001	documentation nein	enumeration	0111002	documentation Lipofilling	enumeration	0111003	documentation Eigengewebstrekonstruktion
Kind	Value	Annotation											
enumeration	0111001	documentation nein											
enumeration	0111002	documentation Lipofilling											
enumeration	0111003	documentation Eigengewebstrekonstruktion											
annotation	documentation Kat_BI_Verfahrenswechsel												
source	<pre><simpleType name="enum_0111"> <annotation> <documentation>Kat_BI_Verfahrenswechsel</documentation> </annotation> <restriction base="xs:string"> <enumeration value="0111001"> <annotation> <documentation>nein</documentation> </annotation> </enumeration> <enumeration value="0111002"> <annotation> <documentation>Lipofilling</documentation> </annotation> </enumeration> <enumeration value="0111003"> <annotation> <documentation>Eigengewebstrekonstruktion</documentation> </annotation> </enumeration> </restriction> </simpleType></pre>												

simpleType enum_0112

namespace	http://xml.ir-d.de/stn																		
type	restriction of string																		
properties	base xs:string																		
facets	<table><thead><tr><th>Kind</th><th>Value</th><th>Annotation</th></tr></thead><tbody><tr><td>enumeration</td><td>0112001</td><td>documentation subglandulär / epipektoral</td></tr><tr><td>enumeration</td><td>0112002</td><td>documentation subpektoral</td></tr><tr><td>enumeration</td><td>0112003</td><td>documentation subfaszial</td></tr><tr><td>enumeration</td><td>0112004</td><td>documentation sub-flap</td></tr><tr><td>enumeration</td><td>0112005</td><td>documentation subkutan</td></tr></tbody></table>	Kind	Value	Annotation	enumeration	0112001	documentation subglandulär / epipektoral	enumeration	0112002	documentation subpektoral	enumeration	0112003	documentation subfaszial	enumeration	0112004	documentation sub-flap	enumeration	0112005	documentation subkutan
Kind	Value	Annotation																	
enumeration	0112001	documentation subglandulär / epipektoral																	
enumeration	0112002	documentation subpektoral																	
enumeration	0112003	documentation subfaszial																	
enumeration	0112004	documentation sub-flap																	
enumeration	0112005	documentation subkutan																	

	enumeration 0112006 documentation dual plane enumeration 0112042 documentation andere
annotation	documentation Kat_BI_LageImplantat
source	<pre> <simpleType name="enum_0112"> <annotation> <documentation>Kat_BI_LageImplantat</documentation> </annotation> <restriction base="xs:string"> <enumeration value="0112001"> <annotation> <documentation>subglandulär / epipektoral</documentation> </annotation> </enumeration> <enumeration value="0112002"> <annotation> <documentation>subpektoral</documentation> </annotation> </enumeration> <enumeration value="0112003"> <annotation> <documentation>subfaszial</documentation> </annotation> </enumeration> <enumeration value="0112004"> <annotation> <documentation>sub-flap</documentation> </annotation> </enumeration> <enumeration value="0112005"> <annotation> <documentation>subkutan</documentation> </annotation> </enumeration> <enumeration value="0112006"> <annotation> <documentation>dual plane</documentation> </annotation> </enumeration> <enumeration value="0112042"> <annotation> <documentation>andere</documentation> </annotation> </enumeration> </restriction> </simpleType> </pre>

simpleType enum_0113

namespace	http://xml.ir-d.de/stn		
type	restriction of string		
properties	base xs:string		
facets	Kind enumeration	Value 0113001	Annotation documentation Chemotherapie innerhalb der letzten drei Monate

annotation	documentation Kat_BI_VorbehandlungSystemisch
source	<pre> <simpleType name="enum_0113"> <annotation> <documentation>Kat_BI_VorbehandlungSystemisch</documentation> </annotation> <restriction base="xs:string"> <enumeration value="0113001"> <annotation> <documentation>Chemotherapie innerhalb der letzten drei Monate</documentation> </annotation> </enumeration> </restriction> </simpleType> </pre>

simpleType enum_0114

namespace	http://xml.ir-d.de/stn		
type	restriction of string		
properties	base xs:string		
facets	Kind	Value	Annotation
	enumeration	0114001	documentation vollständig
	enumeration	0114002	documentation nein
	enumeration	0114003	documentation teilweise
	enumeration	0114004	documentation nicht vorhanden
annotation	documentation Kat_BI_EntfernungADMNetz		
source	<pre> <simpleType name="enum_0114"> <annotation> <documentation>Kat_BI_EntfernungADMNetz</documentation> </annotation> <restriction base="xs:string"> <enumeration value="0114001"> <annotation> <documentation>vollständig</documentation> </annotation> </enumeration> <enumeration value="0114002"> <annotation> <documentation>nein</documentation> </annotation> </enumeration> <enumeration value="0114003"> <annotation> <documentation>teilweise</documentation> </annotation> </enumeration> <enumeration value="0114004"> <annotation> <documentation>nicht vorhanden</documentation> </annotation> </enumeration> </restriction> </simpleType> </pre>		

	<pre> </restriction> </simpleType> </pre>
--	---

simpleType enum_0116

namespace	http://xml.ir-d.de/stn		
type	restriction of string		
properties	base xs:string		
facets	Kind	Value	Annotation
	enumeration	0116001	documentation Spülung, antibiotisch
	enumeration	0116002	documentation Spülung, antiseptisch
	enumeration	0116003	documentation Spülung, wirkstofffrei
	enumeration	0116004	documentation Spülung, andere
	enumeration	0116005	documentation prä-/perioperative Antibiotika
	enumeration	0116006	documentation postoperative Antibiotika
	enumeration	0116007	documentation Handschuhwechsel vor Implantation
	enumeration	0116008	documentation Implantationshilfe
annotation	documentation Kat_BI_Operationsmassnahme		
source	<pre> <simpleType name="enum_0116"> <annotation> <documentation>Kat_BI_Operationsmassnahme</documentation> </annotation> <restriction base="xs:string"> <enumeration value="0116001"> <annotation> <documentation>Spülung, antibiotisch</documentation> </annotation> </enumeration> <enumeration value="0116002"> <annotation> <documentation>Spülung, antiseptisch</documentation> </annotation> </enumeration> <enumeration value="0116003"> <annotation> <documentation>Spülung, wirkstofffrei</documentation> </annotation> </enumeration> <enumeration value="0116004"> <annotation> <documentation>Spülung, andere</documentation> </annotation> </enumeration> <enumeration value="0116005"> <annotation> <documentation>prä-/perioperative Antibiotika</documentation> </annotation> </enumeration> <enumeration value="0116006"> </pre>		

	<pre> <annotation> <documentation>postoperative Antibiotika</documentation> </annotation> </enumeration> <enumeration value="0116007"> <annotation> <documentation>Handschuhwechsel vor Implantation</documentation> </annotation> </enumeration> <enumeration value="0116008"> <annotation> <documentation>Implantationshilfe</documentation> </annotation> </enumeration> </restriction> </simpleType> </pre>
--	---

simpleType enum_0118

namespace	http://xml.ir-d.de/stn		
type	restriction of string		
properties	base xs:string		
facets	Kind	Value	Annotation
	enumeration	0118001	documentation axillär
	enumeration	0118002	documentation periareolär
	enumeration	0118003	documentation inframammär
	enumeration	0118004	documentation Mastektomienarbe
	enumeration	0118042	documentation anderer
annotation	documentation Kat_BI_Operationszugang		
source	<pre> <simpleType name="enum_0118"> <annotation> <documentation>Kat_BI_Operationszugang</documentation> </annotation> <restriction base="xs:string"> <enumeration value="0118001"> <annotation> <documentation>axillär</documentation> </annotation> </enumeration> <enumeration value="0118002"> <annotation> <documentation>periareolär</documentation> </annotation> </enumeration> <enumeration value="0118003"> <annotation> <documentation>inframammär</documentation> </annotation> </enumeration> <enumeration value="0118004"> <annotation> </pre>		

	<pre> <documentation>Mastektomienarbe</documentation> </annotation> </enumeration> <enumeration value="0118042"> <annotation> <documentation>anderer</documentation> </annotation> </enumeration> </restriction> </simpleType> </pre>
--	---

simpleType enum_0120

namespace	http://xml.ir-d.de/stn		
type	restriction of string		
properties	base xs:string		
facets	Kind	Value	Annotation
	enumeration	0120001	documentation Expander defekt
annotation	documentation Kat_BI_BefundAustausch		
source	<pre> <simpleType name="enum_0120"> <annotation> <documentation>Kat_BI_BefundAustausch</documentation> </annotation> <restriction base="xs:string"> <enumeration value="0120001"> <annotation> <documentation>Expander defekt</documentation> </annotation> </enumeration> </restriction> </simpleType> </pre>		

simpleType enum_0121

namespace	http://xml.ir-d.de/stn		
type	restriction of string		
properties	base xs:string		
facets	Kind	Value	Annotation
	enumeration	0121001	documentation Infektion
	enumeration	0121002	documentation Serom
	enumeration	0121004	documentation Kapsel fibrose
	enumeration	0121005	documentation Implantatruptur
	enumeration	0121006	documentation Fehlpositionierung/Rotation
	enumeration	0121007	documentation BIA-ALCL/-BCL/-SCC, Verdacht
	enumeration	0121008	documentation BIA-ALCL/-BCL/-SCC, pathologisch bestätigt
	enumeration	0121009	documentation

	<p>enumeration 0121010 Brustschmerzen documentation Doppelkapsel</p> <p>enumeration 0121011 documentation Netz-/ADM-bedingte Komplikation, Non-Integration</p> <p>enumeration 0121012 documentation Netz-/ADM-bedingte Komplikation, andere</p> <p>enumeration 0121013 documentation Hautnekrose/exponiertes Implantat</p> <p>enumeration 0121014 documentation BII/ASIA (Brustimplantat assoziierte Symptome), Verdacht</p> <p>enumeration 0121015 documentation Lymphadenopathie</p> <p>enumeration 0121016 documentation Brustkrebs, neu aufgetreten/Rezidiv</p> <p>enumeration 0121042 documentation sonstiger</p>
annotation	documentation Kat BI BefundKomplett
source	<pre> <simpleType name="enum_0121"> <annotation> <documentation>Kat_BI_BefundKomplett</documentation> </annotation> <restriction base="xs:string"> <enumeration value="0121001"> <annotation> <documentation>Infektion</documentation> </annotation> </enumeration> <enumeration value="0121002"> <annotation> <documentation>Serom</documentation> </annotation> </enumeration> <enumeration value="0121004"> <annotation> <documentation>Kapsel fibrose</documentation> </annotation> </enumeration> <enumeration value="0121005"> <annotation> <documentation>Implantatruptur</documentation> </annotation> </enumeration> <enumeration value="0121006"> <annotation> <documentation>Fehlpositionierung/Rotation</documentation> </annotation> </enumeration> <enumeration value="0121007"> <annotation> <documentation>BIA-ALCL/-BCL/-SCC, Verdacht</documentation> </annotation> </enumeration> <enumeration value="0121008"> <annotation> <documentation>BIA-ALCL/-BCL/-SCC, pathologisch bestätigt</documentation> </annotation> </enumeration> </restriction> </pre>

```

<enumeration value="0121009">
  <annotation>
    <documentation>Brustschmerzen</documentation>
  </annotation>
</enumeration>
<enumeration value="0121010">
  <annotation>
    <documentation>Doppelkapsel</documentation>
  </annotation>
</enumeration>
<enumeration value="0121011">
  <annotation>
    <documentation>Netz-/ADM-bedingte Komplikation, Non-
Integration</documentation>
  </annotation>
</enumeration>
<enumeration value="0121012">
  <annotation>
    <documentation>Netz-/ADM-bedingte Komplikation,
andere</documentation>
  </annotation>
</enumeration>
<enumeration value="0121013">
  <annotation>
    <documentation>Hautnekrose/exponiertes Implantat</documentation>
  </annotation>
</enumeration>
<enumeration value="0121014">
  <annotation>
    <documentation>BII/ASIA (Brustimplantat assoziierte Symptome),
Verdacht</documentation>
  </annotation>
</enumeration>
<enumeration value="0121015">
  <annotation>
    <documentation>Lymphadenopathie</documentation>
  </annotation>
</enumeration>
<enumeration value="0121016">
  <annotation>
    <documentation>Brustkrebs, neu aufgetreten/Rezidiv</documentation>
  </annotation>
</enumeration>
<enumeration value="0121042">
  <annotation>
    <documentation>sonstiger</documentation>
  </annotation>
</enumeration>
</restriction>
</simpleType>

```

simpleType enum_0122

namespace	http://xml.ir-d.de/stn
type	restriction of string
properties	base xs:string

facets	<table border="1"> <thead> <tr> <th>Kind</th> <th>Value</th> <th>Annotation</th> </tr> </thead> <tbody> <tr> <td>enumeration</td> <td>0122001</td> <td>documentation ja, ärztlich nachgewiesen</td> </tr> <tr> <td>enumeration</td> <td>0122002</td> <td>documentation nein</td> </tr> <tr> <td>enumeration</td> <td>0122042</td> <td>documentation unbekannt</td> </tr> </tbody> </table>	Kind	Value	Annotation	enumeration	0122001	documentation ja, ärztlich nachgewiesen	enumeration	0122002	documentation nein	enumeration	0122042	documentation unbekannt
Kind	Value	Annotation											
enumeration	0122001	documentation ja, ärztlich nachgewiesen											
enumeration	0122002	documentation nein											
enumeration	0122042	documentation unbekannt											
annotation	documentation Kat_BI_Autoimmunerkrankung												
source	<pre> <simpleType name="enum_0122"> <annotation> <documentation>Kat_BI_Autoimmunerkrankung</documentation> </annotation> <restriction base="xs:string"> <enumeration value="0122001"> <annotation> <documentation>ja, ärztlich nachgewiesen</documentation> </annotation> </enumeration> <enumeration value="0122002"> <annotation> <documentation>nein</documentation> </annotation> </enumeration> <enumeration value="0122042"> <annotation> <documentation>unbekannt</documentation> </annotation> </enumeration> </restriction> </simpleType> </pre>												

simpleType enum_0123

namespace	http://xml.ir-d.de/stn																		
type	restriction of string																		
properties	base xs:string																		
facets	<table border="1"> <thead> <tr> <th>Kind</th> <th>Value</th> <th>Annotation</th> </tr> </thead> <tbody> <tr> <td>enumeration</td> <td>0123001</td> <td>documentation neu aufgetreten</td> </tr> <tr> <td>enumeration</td> <td>0123002</td> <td>documentation verschlechtert</td> </tr> <tr> <td>enumeration</td> <td>0123003</td> <td>documentation keine Veränderung</td> </tr> <tr> <td>enumeration</td> <td>0123004</td> <td>documentation nicht relevant, da Primäreingriff</td> </tr> <tr> <td>enumeration</td> <td>0123042</td> <td>documentation unbekannt</td> </tr> </tbody> </table>	Kind	Value	Annotation	enumeration	0123001	documentation neu aufgetreten	enumeration	0123002	documentation verschlechtert	enumeration	0123003	documentation keine Veränderung	enumeration	0123004	documentation nicht relevant, da Primäreingriff	enumeration	0123042	documentation unbekannt
Kind	Value	Annotation																	
enumeration	0123001	documentation neu aufgetreten																	
enumeration	0123002	documentation verschlechtert																	
enumeration	0123003	documentation keine Veränderung																	
enumeration	0123004	documentation nicht relevant, da Primäreingriff																	
enumeration	0123042	documentation unbekannt																	
annotation	documentation Kat_BI_VerlaufAutoimmunerkrankung																		
source	<pre> <simpleType name="enum_0123"> <annotation> <documentation>Kat_BI_VerlaufAutoimmunerkrankung</documentation> </annotation> <restriction base="xs:string"> <enumeration value="0123001"> <annotation> <documentation>neu aufgetreten</documentation> </pre>																		

	<pre> </annotation> </enumeration> <enumeration value="0123002"> <annotation> <documentation>verschlechtert</documentation> </annotation> </enumeration> <enumeration value="0123003"> <annotation> <documentation>keine Veränderung</documentation> </annotation> </enumeration> <enumeration value="0123004"> <annotation> <documentation>nicht relevant, da Primäreingriff</documentation> </annotation> </enumeration> <enumeration value="0123042"> <annotation> <documentation>unbekannt</documentation> </annotation> </enumeration> </restriction> </simpleType> </pre>
--	---

simpleType enum_0124

namespace	http://xml.ir-d.de/stn		
type	restriction of string		
properties	base xs:string		
facets	Kind	Value	Annotation
	enumeration	0124001	documentation Salzlösung
	enumeration	0124002	documentation Silikongel
	enumeration	0124003	documentation Kombination Silikongel und Salzlösung
	enumeration	0124042	documentation sonstige
annotation	documentation Kat_BI_Fuellung		
source	<pre> <simpleType name="enum_0124"> <annotation> <documentation>Kat_BI_Fuellung</documentation> </annotation> <restriction base="xs:string"> <enumeration value="0124001"> <annotation> <documentation>Salzlösung</documentation> </annotation> </enumeration> <enumeration value="0124002"> <annotation> <documentation>Silikongel</documentation> </annotation> </enumeration> <enumeration value="0124003"> </pre>		

	<pre> <annotation> <documentation>Kombination Silikongel und Salzlösung</documentation> </annotation> </enumeration> <enumeration value="0124042"> <annotation> <documentation>sonstige</documentation> </annotation> </enumeration> </restriction> </simpleType> </pre>
--	--

simpleType enum_0126

namespace	http://xml.ir-d.de/stn		
type	restriction of string		
properties	base xs:string		
facets	Kind	Value	Annotation
	enumeration	0126001	documentation anatomisch (tropfenförmig)
	enumeration	0126002	documentation rund (punktsymmetrisch)
	enumeration	0126042	documentation sonstige
annotation	documentation Kat_BI_Form		
source	<pre> <simpleType name="enum_0126"> <annotation> <documentation>Kat_BI_Form</documentation> </annotation> <restriction base="xs:string"> <enumeration value="0126001"> <annotation> <documentation>anatomisch (tropfenförmig)</documentation> </annotation> </enumeration> <enumeration value="0126002"> <annotation> <documentation>rund (punktsymmetrisch)</documentation> </annotation> </enumeration> <enumeration value="0126042"> <annotation> <documentation>sonstige</documentation> </annotation> </enumeration> </restriction> </simpleType> </pre>		

simpleType enum_0128

namespace	http://xml.ir-d.de/stn		
type	restriction of string		
properties	base xs:string		

facets	<table border="1"> <thead> <tr> <th>Kind</th> <th>Value</th> <th>Annotation</th> </tr> </thead> <tbody> <tr> <td>enumeration</td> <td>0128001</td> <td>documentation glattwandig</td> </tr> <tr> <td>enumeration</td> <td>0128002</td> <td>documentation beschichtet</td> </tr> <tr> <td>enumeration</td> <td>0128003</td> <td>documentation texturiert</td> </tr> </tbody> </table>	Kind	Value	Annotation	enumeration	0128001	documentation glattwandig	enumeration	0128002	documentation beschichtet	enumeration	0128003	documentation texturiert
Kind	Value	Annotation											
enumeration	0128001	documentation glattwandig											
enumeration	0128002	documentation beschichtet											
enumeration	0128003	documentation texturiert											
annotation	documentation Kat_BI_Oberflaeche												
source	<pre><simpleType name="enum_0128"> <annotation> <documentation>Kat_BI_Oberflaeche</documentation> </annotation> <restriction base="xs:string"> <enumeration value="0128001"> <annotation> <documentation>glattwandig</documentation> </annotation> </enumeration> <enumeration value="0128002"> <annotation> <documentation>beschichtet</documentation> </annotation> </enumeration> <enumeration value="0128003"> <annotation> <documentation>texturiert</documentation> </annotation> </enumeration> </restriction> </simpleType></pre>												

simpleType enum_0131

namespace	http://xml.ir-d.de/stn																																				
type	restriction of string																																				
properties	base xs:string																																				
facets	<table border="1"> <thead> <tr> <th>Kind</th> <th>Value</th> <th>Annotation</th> </tr> </thead> <tbody> <tr> <td>enumeration</td> <td>0131001</td> <td>documentation Allergan</td> </tr> <tr> <td>enumeration</td> <td>0131002</td> <td>documentation Establishment Labs</td> </tr> <tr> <td>enumeration</td> <td>0131003</td> <td>documentation Eurosilicone</td> </tr> <tr> <td>enumeration</td> <td>0131004</td> <td>documentation Galatea</td> </tr> <tr> <td>enumeration</td> <td>0131005</td> <td>documentation Integra</td> </tr> <tr> <td>enumeration</td> <td>0131006</td> <td>documentation Lifecell</td> </tr> <tr> <td>enumeration</td> <td>0131007</td> <td>documentation MBP (Medical Biomaterial Products)</td> </tr> <tr> <td>enumeration</td> <td>0131008</td> <td>documentation Mentor</td> </tr> <tr> <td>enumeration</td> <td>0131009</td> <td>documentation Novus Scientific</td> </tr> <tr> <td>enumeration</td> <td>0131010</td> <td>documentation pfmMedical</td> </tr> <tr> <td>enumeration</td> <td>0131011</td> <td>documentation</td> </tr> </tbody> </table>	Kind	Value	Annotation	enumeration	0131001	documentation Allergan	enumeration	0131002	documentation Establishment Labs	enumeration	0131003	documentation Eurosilicone	enumeration	0131004	documentation Galatea	enumeration	0131005	documentation Integra	enumeration	0131006	documentation Lifecell	enumeration	0131007	documentation MBP (Medical Biomaterial Products)	enumeration	0131008	documentation Mentor	enumeration	0131009	documentation Novus Scientific	enumeration	0131010	documentation pfmMedical	enumeration	0131011	documentation
Kind	Value	Annotation																																			
enumeration	0131001	documentation Allergan																																			
enumeration	0131002	documentation Establishment Labs																																			
enumeration	0131003	documentation Eurosilicone																																			
enumeration	0131004	documentation Galatea																																			
enumeration	0131005	documentation Integra																																			
enumeration	0131006	documentation Lifecell																																			
enumeration	0131007	documentation MBP (Medical Biomaterial Products)																																			
enumeration	0131008	documentation Mentor																																			
enumeration	0131009	documentation Novus Scientific																																			
enumeration	0131010	documentation pfmMedical																																			
enumeration	0131011	documentation																																			

	<p>enumeration 0131012 Serag Wiessner documentation nicht belegter Wert</p> <p>enumeration 0131013 documentation nicht belegter Wert</p> <p>enumeration 0131014 documentation nicht belegter Wert</p> <p>enumeration 0131015 documentation nicht belegter Wert</p> <p>enumeration 0131042 documentation sonstiger</p>
annotation	documentation Kat BI_ZubehoerHersteller
source	<pre> <simpleType name="enum_0131"> <annotation> <documentation>Kat_BI_ZubehoerHersteller</documentation> </annotation> <restriction base="xs:string"> <enumeration value="0131001"> <annotation> <documentation>Allergan</documentation> </annotation> </enumeration> <enumeration value="0131002"> <annotation> <documentation>Establishment Labs</documentation> </annotation> </enumeration> <enumeration value="0131003"> <annotation> <documentation>Eurosilicone</documentation> </annotation> </enumeration> <enumeration value="0131004"> <annotation> <documentation>Galatea</documentation> </annotation> </enumeration> <enumeration value="0131005"> <annotation> <documentation>Integra</documentation> </annotation> </enumeration> <enumeration value="0131006"> <annotation> <documentation>Lifecell</documentation> </annotation> </enumeration> <enumeration value="0131007"> <annotation> <documentation>MBP (Medical Biomaterial Products)</documentation> </annotation> </enumeration> <enumeration value="0131008"> <annotation> <documentation>Mentor</documentation> </annotation> </enumeration> <enumeration value="0131009"> <annotation> </pre>

```

    <documentation>Novus Scientific</documentation>
  </annotation>
</enumeration>
<enumeration value="0131010">
  <annotation>
    <documentation>pfmMedical</documentation>
  </annotation>
</enumeration>
<enumeration value="0131011">
  <annotation>
    <documentation>Serag Wiessner</documentation>
  </annotation>
</enumeration>
<enumeration value="0131012">
  <annotation>
    <documentation>nicht belegter Wert</documentation>
  </annotation>
</enumeration>
<enumeration value="0131013">
  <annotation>
    <documentation>nicht belegter Wert</documentation>
  </annotation>
</enumeration>
<enumeration value="0131014">
  <annotation>
    <documentation>nicht belegter Wert</documentation>
  </annotation>
</enumeration>
<enumeration value="0131015">
  <annotation>
    <documentation>nicht belegter Wert</documentation>
  </annotation>
</enumeration>
<enumeration value="0131042">
  <annotation>
    <documentation>sonstiger</documentation>
  </annotation>
</enumeration>
</restriction>
</simpleType>

```

simpleType enum_0170

namespace	http://xml.ir-d.de/stn		
type	restriction of string		
properties	base xs:string		
facets	Kind	Value	Annotation
	enumeration	0170001	documentation weiblich
	enumeration	0170002	documentation männlich
	enumeration	0170003	documentation intersexuell
annotation	documentation Kat_Bl_GeschlechtGeburt		
source	<simpleType name="enum_0170"> <annotation>		

	<pre> <documentation>Kat_BI_GeschlechtGeburt</documentation> </annotation> <restriction base="xs:string"> <enumeration value="0170001"> <annotation> <documentation>weiblich</documentation> </annotation> </enumeration> <enumeration value="0170002"> <annotation> <documentation>männlich</documentation> </annotation> </enumeration> <enumeration value="0170003"> <annotation> <documentation>intersexuell</documentation> </annotation> </enumeration> </restriction> </simpleType> </pre>
--	---

simpleType enum_0190

namespace	http://xml.ir-d.de/stn		
type	restriction of string		
properties	base xs:string		
facets	Kind	Value	Annotation
	enumeration	0190001	documentation Brustimplantat
	enumeration	0190003	documentation Brustexpander
annotation	documentation Kat_BI_Artikeltyp		
source	<pre> <simpleType name="enum_0190"> <annotation> <documentation>Kat_BI_Artikeltyp</documentation> </annotation> <restriction base="xs:string"> <enumeration value="0190001"> <annotation> <documentation>Brustimplantat</documentation> </annotation> </enumeration> <enumeration value="0190003"> <annotation> <documentation>Brustexpander</documentation> </annotation> </enumeration> </restriction> </simpleType> </pre>		

simpleType enum_0191

namespace	http://xml.ir-d.de/stn
-----------	------------------------

type	restriction of string									
properties	base xs:string									
facets	<table border="1"> <thead> <tr> <th>Kind</th> <th>Value</th> <th>Annotation</th> </tr> </thead> <tbody> <tr> <td>enumeration</td> <td>0191001</td> <td>documentation Netz</td> </tr> <tr> <td>enumeration</td> <td>0191002</td> <td>documentation ADM</td> </tr> </tbody> </table>	Kind	Value	Annotation	enumeration	0191001	documentation Netz	enumeration	0191002	documentation ADM
Kind	Value	Annotation								
enumeration	0191001	documentation Netz								
enumeration	0191002	documentation ADM								
annotation	documentation Kat_BI_ZubehoerTyp									
source	<pre><simpleType name="enum_0191"> <annotation> <documentation>Kat_BI_ZubehoerTyp</documentation> </annotation> <restriction base="xs:string"> <enumeration value="0191001"> <annotation> <documentation>Netz</documentation> </annotation> </enumeration> <enumeration value="0191002"> <annotation> <documentation>ADM</documentation> </annotation> </enumeration> </restriction> </simpleType></pre>									

simpleType **enum_0200**

namespace	http://xml.ir-d.de/stn									
type	restriction of string									
properties	base xs:string									
facets	<table border="1"> <thead> <tr> <th>Kind</th> <th>Value</th> <th>Annotation</th> </tr> </thead> <tbody> <tr> <td>enumeration</td> <td>0200001</td> <td>documentation Erst-OP</td> </tr> <tr> <td>enumeration</td> <td>0200002</td> <td>documentation Folgeeingriff</td> </tr> </tbody> </table>	Kind	Value	Annotation	enumeration	0200001	documentation Erst-OP	enumeration	0200002	documentation Folgeeingriff
Kind	Value	Annotation								
enumeration	0200001	documentation Erst-OP								
enumeration	0200002	documentation Folgeeingriff								
annotation	documentation Kat_EP_ArtEingriff									
source	<pre><simpleType name="enum_0200"> <annotation> <documentation>Kat_EP_ArtEingriff</documentation> </annotation> <restriction base="xs:string"> <enumeration value="0200001"> <annotation> <documentation>Erst-OP</documentation> </annotation> </enumeration> <enumeration value="0200002"> <annotation> <documentation>Folgeeingriff</documentation> </annotation> </enumeration> </restriction> </simpleType></pre>									

</simpleType>

simpleType enum_0202

namespace	http://xml.ir-d.de/stn																																													
type	restriction of string																																													
properties	base xs:string																																													
facets	<table><thead><tr><th>Kind</th><th>Value</th><th>Annotation</th></tr></thead><tbody><tr><td>enumeration</td><td>0202001</td><td>documentation Lockerung</td></tr><tr><td>enumeration</td><td>0202002</td><td>documentation Infektion, Verdacht auf</td></tr><tr><td>enumeration</td><td>0202003</td><td>documentation Infektion, gesichert</td></tr><tr><td>enumeration</td><td>0202004</td><td>documentation Luxation, Inlay aus der Pfanne</td></tr><tr><td>enumeration</td><td>0202005</td><td>documentation Luxation, Kopf aus Pfanne/Inlay</td></tr><tr><td>enumeration</td><td>0202006</td><td>documentation Periprothetische Fraktur</td></tr><tr><td>enumeration</td><td>0202007</td><td>documentation Verschleiß des PE-Inlays</td></tr><tr><td>enumeration</td><td>0202008</td><td>documentation Implantatbruch</td></tr><tr><td>enumeration</td><td>0202009</td><td>documentation Implantatfehlloge/Malalignent</td></tr><tr><td>enumeration</td><td>0202010</td><td>documentation Osteolysen bei festem Implantat</td></tr><tr><td>enumeration</td><td>0202011</td><td>documentation Progression der Grunderkrankung</td></tr><tr><td>enumeration</td><td>0202012</td><td>documentation ARMD</td></tr><tr><td>enumeration</td><td>0202013</td><td>documentation Verdacht auf allergische Reaktion</td></tr><tr><td>enumeration</td><td>0202042</td><td>documentation andere Gründe</td></tr></tbody></table>	Kind	Value	Annotation	enumeration	0202001	documentation Lockerung	enumeration	0202002	documentation Infektion, Verdacht auf	enumeration	0202003	documentation Infektion, gesichert	enumeration	0202004	documentation Luxation, Inlay aus der Pfanne	enumeration	0202005	documentation Luxation, Kopf aus Pfanne/Inlay	enumeration	0202006	documentation Periprothetische Fraktur	enumeration	0202007	documentation Verschleiß des PE-Inlays	enumeration	0202008	documentation Implantatbruch	enumeration	0202009	documentation Implantatfehlloge/Malalignent	enumeration	0202010	documentation Osteolysen bei festem Implantat	enumeration	0202011	documentation Progression der Grunderkrankung	enumeration	0202012	documentation ARMD	enumeration	0202013	documentation Verdacht auf allergische Reaktion	enumeration	0202042	documentation andere Gründe
Kind	Value	Annotation																																												
enumeration	0202001	documentation Lockerung																																												
enumeration	0202002	documentation Infektion, Verdacht auf																																												
enumeration	0202003	documentation Infektion, gesichert																																												
enumeration	0202004	documentation Luxation, Inlay aus der Pfanne																																												
enumeration	0202005	documentation Luxation, Kopf aus Pfanne/Inlay																																												
enumeration	0202006	documentation Periprothetische Fraktur																																												
enumeration	0202007	documentation Verschleiß des PE-Inlays																																												
enumeration	0202008	documentation Implantatbruch																																												
enumeration	0202009	documentation Implantatfehlloge/Malalignent																																												
enumeration	0202010	documentation Osteolysen bei festem Implantat																																												
enumeration	0202011	documentation Progression der Grunderkrankung																																												
enumeration	0202012	documentation ARMD																																												
enumeration	0202013	documentation Verdacht auf allergische Reaktion																																												
enumeration	0202042	documentation andere Gründe																																												
annotation	documentation Kat_EP_GrundWechselHuefte																																													
source	<pre><simpleType name="enum_0202"> <annotation> <documentation>Kat_EP_GrundWechselHuefte</documentation> </annotation> <restriction base="xs:string"> <enumeration value="0202001"> <annotation> <documentation>Lockerung</documentation> </annotation> </enumeration> <enumeration value="0202002"> <annotation> <documentation>Infektion, Verdacht auf</documentation> </annotation> </enumeration> <enumeration value="0202003"> <annotation> <documentation>Infektion, gesichert</documentation> </annotation> </enumeration> <enumeration value="0202004"></pre>																																													

```
<annotation>
  <documentation>Luxation, Inlay aus der Pfanne</documentation>
</annotation>
</enumeration>
<enumeration value="0202005">
  <annotation>
    <documentation>Luxation, Kopf aus Pfanne/Inlay</documentation>
  </annotation>
</enumeration>
<enumeration value="0202006">
  <annotation>
    <documentation>Periprothetische Fraktur</documentation>
  </annotation>
</enumeration>
<enumeration value="0202007">
  <annotation>
    <documentation>Verschleiß des PE-Inlays</documentation>
  </annotation>
</enumeration>
<enumeration value="0202008">
  <annotation>
    <documentation>Implantatbruch</documentation>
  </annotation>
</enumeration>
<enumeration value="0202009">
  <annotation>
    <documentation>Implantatfehlage/Malalignent</documentation>
  </annotation>
</enumeration>
<enumeration value="0202010">
  <annotation>
    <documentation>Osteolysen bei festem Implantat</documentation>
  </annotation>
</enumeration>
<enumeration value="0202011">
  <annotation>
    <documentation>Progression der Grunderkrankung</documentation>
  </annotation>
</enumeration>
<enumeration value="0202012">
  <annotation>
    <documentation>ARMD</documentation>
  </annotation>
</enumeration>
<enumeration value="0202013">
  <annotation>
    <documentation>Verdacht auf allergische Reaktion</documentation>
  </annotation>
</enumeration>
<enumeration value="0202042">
  <annotation>
    <documentation>andere Gründe</documentation>
  </annotation>
</enumeration>
</restriction>
</simpleType>
```

simpleType enum_0204

namespace	http://xml.ir-d.de/strn		
type	restriction of string		
properties	base xs:string		
facets	Kind	Value	Annotation
	enumeration	0204001	documentation Lockerung
	enumeration	0204002	documentation Infektion, Verdacht auf
	enumeration	0204003	documentation Infektion, gesichert
	enumeration	0204006	documentation Periprothetische Fraktur
	enumeration	0204007	documentation Verschleiß
	enumeration	0204008	documentation Implantatbruch
	enumeration	0204009	documentation Implantatfehlage/Malalignent
	enumeration	0204010	documentation Osteolysen bei festem Implantat
	enumeration	0204011	documentation Progression der Grunderkrankung
	enumeration	0204012	documentation ARMD
	enumeration	0204013	documentation Verdacht auf allergische Reaktion
	enumeration	0204014	documentation Dislokation/Migration von Komponenten
	enumeration	0204015	documentation Bandinstabilität
	enumeration	0204016	documentation Bewegungseinschränkung
	enumeration	0204042	documentation andere Gründe
annotation	documentation Kat_EP_GrundWechselKnie		
source	<pre> <simpleType name="enum_0204"> <annotation> <documentation>Kat_EP_GrundWechselKnie</documentation> </annotation> <restriction base="xs:string"> <enumeration value="0204001"> <annotation> <documentation>Lockerung</documentation> </annotation> </enumeration> <enumeration value="0204002"> <annotation> <documentation>Infektion, Verdacht auf</documentation> </annotation> </enumeration> <enumeration value="0204003"> <annotation> <documentation>Infektion, gesichert</documentation> </annotation> </enumeration> <enumeration value="0204006"> <annotation> <documentation>Periprothetische Fraktur</documentation> </annotation> </enumeration> </restriction> </simpleType> </pre>		

```
</annotation>
</enumeration>
<enumeration value="0204007">
  <annotation>
    <documentation>Verschleiß</documentation>
  </annotation>
</enumeration>
<enumeration value="0204008">
  <annotation>
    <documentation>Implantatbruch</documentation>
  </annotation>
</enumeration>
<enumeration value="0204009">
  <annotation>
    <documentation>Implantatfehllage/Malalignent</documentation>
  </annotation>
</enumeration>
<enumeration value="0204010">
  <annotation>
    <documentation>Osteolysen bei festem Implantat</documentation>
  </annotation>
</enumeration>
<enumeration value="0204011">
  <annotation>
    <documentation>Progression der Grunderkrankung</documentation>
  </annotation>
</enumeration>
<enumeration value="0204012">
  <annotation>
    <documentation>ARMD</documentation>
  </annotation>
</enumeration>
<enumeration value="0204013">
  <annotation>
    <documentation>Verdacht auf allergische Reaktion</documentation>
  </annotation>
</enumeration>
<enumeration value="0204014">
  <annotation>
    <documentation>Dislokation/Migration von Komponenten</documentation>
  </annotation>
</enumeration>
<enumeration value="0204015">
  <annotation>
    <documentation>Bandinstabilität</documentation>
  </annotation>
</enumeration>
<enumeration value="0204016">
  <annotation>
    <documentation>Bewegungseinschränkung</documentation>
  </annotation>
</enumeration>
<enumeration value="0204042">
  <annotation>
    <documentation>andere Gründe</documentation>
  </annotation>
</enumeration>
</restriction>
</simpleType>
```

simpleType enum 0206

namespace	http://xml.ir-d.de/stn		
type	restriction of string		
properties	base xs:string		
facets	Kind	Value	Annotation
	enumeration	0206001	documentation Lockerung
	enumeration	0206002	documentation Infektion, Verdacht auf
	enumeration	0206003	documentation Infektion, gesichert
	enumeration	0206004	documentation Luxation, Inlay aus der Pfanne
	enumeration	0206005	documentation Luxation, Kopf aus Pfanne/Inlay
	enumeration	0206006	documentation Periprothetische Fraktur
	enumeration	0206007	documentation Verschleiß
	enumeration	0206008	documentation Implantatbruch
	enumeration	0206009	documentation Implantatfehlage/Malalignent
	enumeration	0206010	documentation Osteolysen bei festem Implantat
	enumeration	0206011	documentation Progression der Grunderkrankung
	enumeration	0206012	documentation ARMD
	enumeration	0206013	documentation Verdacht auf allergische Reaktion
	enumeration	0206014	documentation Dislokation/Migration von Komponenten
	enumeration	0206015	documentation Bandinstabilität
	enumeration	0206016	documentation Bewegungseinschränkung
	enumeration	0206042	documentation andere Gründe
annotation	documentation Kat_EP_GrundWechselTFE		
source	<pre> <simpleType name="enum_0206"> <annotation> <documentation>Kat_EP_GrundWechselTFE</documentation> </annotation> <restriction base="xs:string"> <enumeration value="0206001"> <annotation> <documentation>Lockerung</documentation> </annotation> </enumeration> <enumeration value="0206002"> <annotation> <documentation>Infektion, Verdacht auf</documentation> </annotation> </enumeration> <enumeration value="0206003"> <annotation> </pre>		

```
<documentation>Infektion, gesichert</documentation>
</annotation>
</enumeration>
<enumeration value="0206004">
  <annotation>
    <documentation>Luxation, Inlay aus der Pfanne</documentation>
  </annotation>
</enumeration>
<enumeration value="0206005">
  <annotation>
    <documentation>Luxation, Kopf aus Pfanne/Inlay</documentation>
  </annotation>
</enumeration>
<enumeration value="0206006">
  <annotation>
    <documentation>Periprothetische Fraktur</documentation>
  </annotation>
</enumeration>
<enumeration value="0206007">
  <annotation>
    <documentation>Verschleiß</documentation>
  </annotation>
</enumeration>
<enumeration value="0206008">
  <annotation>
    <documentation>Implantatbruch</documentation>
  </annotation>
</enumeration>
<enumeration value="0206009">
  <annotation>
    <documentation>Implantatfehllage/Malalignent</documentation>
  </annotation>
</enumeration>
<enumeration value="0206010">
  <annotation>
    <documentation>Osteolysen bei festem Implantat</documentation>
  </annotation>
</enumeration>
<enumeration value="0206011">
  <annotation>
    <documentation>Progression der Grunderkrankung</documentation>
  </annotation>
</enumeration>
<enumeration value="0206012">
  <annotation>
    <documentation>ARMD</documentation>
  </annotation>
</enumeration>
<enumeration value="0206013">
  <annotation>
    <documentation>Verdacht auf allergische Reaktion</documentation>
  </annotation>
</enumeration>
<enumeration value="0206014">
  <annotation>
    <documentation>Dislokation/Migration von Komponenten</documentation>
  </annotation>
</enumeration>
<enumeration value="0206015">
```

	<pre> <annotation> <documentation>Bandinstabilität</documentation> </annotation> </enumeration> <enumeration value="0206016"> <annotation> <documentation>Bewegungseinschränkung</documentation> </annotation> </enumeration> <enumeration value="0206042"> <annotation> <documentation>andere Gründe</documentation> </annotation> </enumeration> </restriction> </simpleType> </pre>
--	--

simpleType enum_0210

namespace	http://xml.ir-d.de/stn		
type	restriction of string		
properties	base xs:string		
facets	Kind	Value	Annotation
	enumeration	0210001	documentation keine relevante Voroperation
	enumeration	0210002	documentation Osteosynthese/Osteotomie (Becken)
	enumeration	0210003	documentation Osteosynthese/Osteotomie (Femur)
	enumeration	0210004	documentation Osteosynthese/Osteotomie (beides)
	enumeration	0210005	documentation Operation bei Hüftkopfnekrose
	enumeration	0210006	documentation Arthrodese
	enumeration	0210042	documentation andere
annotation	documentation Kat_EP_VoroperationHuefte		
source	<pre> <simpleType name="enum_0210"> <annotation> <documentation>Kat_EP_VoroperationHuefte</documentation> </annotation> <restriction base="xs:string"> <enumeration value="0210001"> <annotation> <documentation>keine relevante Voroperation</documentation> </annotation> </enumeration> <enumeration value="0210002"> <annotation> <documentation>Osteosynthese/Osteotomie (Becken)</documentation> </annotation> </enumeration> <enumeration value="0210003"> <annotation> <documentation>Osteosynthese/Osteotomie (Femur)</documentation> </annotation> </enumeration> </restriction> </simpleType> </pre>		

	<pre> </annotation> </enumeration> <enumeration value="0210004"> <annotation> <documentation>Osteosynthese/Osteotomie (beides)</documentation> </annotation> </enumeration> <enumeration value="0210005"> <annotation> <documentation>Operation bei Hüftkopfnnekrose</documentation> </annotation> </enumeration> <enumeration value="0210006"> <annotation> <documentation>Arthrodese</documentation> </annotation> </enumeration> <enumeration value="0210042"> <annotation> <documentation>andere</documentation> </annotation> </enumeration> </restriction> </simpleType> </pre>
--	---

simpleType enum_0211

namespace	http://xml.ir-d.de/stn		
type	restriction of string		
properties	base xs:string		
facets	Kind	Value	Annotation
	enumeration	0211001	documentation keine relevante Voroperation
	enumeration	0211002	documentation Osteosynthese/Osteotomie (Femur)
	enumeration	0211003	documentation Osteosynthese/Osteotomie (Tibia)
	enumeration	0211004	documentation Osteosynthese/Osteotomie (Patella)
	enumeration	0211005	documentation Osteosynthese/Osteotomie (mehrere)
	enumeration	0211006	documentation Kapsel-/Bandapparat
	enumeration	0211007	documentation Arthrodese
	enumeration	0211042	documentation andere
annotation	documentation Kat_EP_VoroperationKnie		
source	<pre> <simpleType name="enum_0211"> <annotation> <documentation>Kat_EP_VoroperationKnie</documentation> </annotation> <restriction base="xs:string"> <enumeration value="0211001"> <annotation> <documentation>keine relevante Voroperation</documentation> </annotation> </pre>		

```

</enumeration>
<enumeration value="0211002">
  <annotation>
    <documentation>Osteosynthese/Osteotomie (Femur)</documentation>
  </annotation>
</enumeration>
<enumeration value="0211003">
  <annotation>
    <documentation>Osteosynthese/Osteotomie (Tibia)</documentation>
  </annotation>
</enumeration>
<enumeration value="0211004">
  <annotation>
    <documentation>Osteosynthese/Osteotomie (Patella)</documentation>
  </annotation>
</enumeration>
<enumeration value="0211005">
  <annotation>
    <documentation>Osteosynthese/Osteotomie (mehrere)</documentation>
  </annotation>
</enumeration>
<enumeration value="0211006">
  <annotation>
    <documentation>Kapsel-/Bandapparat</documentation>
  </annotation>
</enumeration>
<enumeration value="0211007">
  <annotation>
    <documentation>Arthrodesse</documentation>
  </annotation>
</enumeration>
<enumeration value="0211042">
  <annotation>
    <documentation>andere</documentation>
  </annotation>
</enumeration>
</restriction>
</simpleType>

```

simpleType **enum_0212**

namespace	http://xml.ir-d.de/stn		
type	restriction of string		
properties	base xs:string		
facets	Kind	Value	Annotation
	enumeration	0212001	documentation Hüfte
	enumeration	0212002	documentation Knie
	enumeration	0212003	documentation Totaler Femurersatz inkl. Durchsteck-Prothese
annotation	documentation Kat_EP_Gelenk		
source	<simpleType name="enum_0212"> <annotation> <documentation>Kat_EP_Gelenk</documentation> </annotation>		

	<pre> <restriction base="xs:string"> <enumeration value="0212001"> <annotation> <documentation>Hüfte</documentation> </annotation> </enumeration> <enumeration value="0212002"> <annotation> <documentation>Knie</documentation> </annotation> </enumeration> <enumeration value="0212003"> <annotation> <documentation>Totaler Femurersatz inkl. Durchsteck- Prothese</documentation> </annotation> </enumeration> </restriction> </simpleType> </pre>
--	---

simpleType enum 0220

namespace	http://xml.ir-d.de/stn		
type	restriction of string		
properties	base xs:string		
facets	Kind	Value	Annotation
	enumeration	0220001	documentation anterior
	enumeration	0220002	documentation anterolateral
	enumeration	0220003	documentation lateral
	enumeration	0220004	documentation posterior
	enumeration	0220005	documentation posterolateral
	enumeration	0220006	documentation 2-Inzisionen-Zugang
	enumeration	0220042	documentation sonstiger
annotation	documentation Kat_EP_Operationszugang		
source	<pre> <simpleType name="enum_0220"> <annotation> <documentation>Kat_EP_Operationszugang</documentation> </annotation> <restriction base="xs:string"> <enumeration value="0220001"> <annotation> <documentation>anterior</documentation> </annotation> </enumeration> <enumeration value="0220002"> <annotation> <documentation>anterolateral</documentation> </annotation> </enumeration> </restriction> </pre>		

	<pre> <enumeration value="0220003"> <annotation> <documentation>lateral</documentation> </annotation> </enumeration> <enumeration value="0220004"> <annotation> <documentation>posterior</documentation> </annotation> </enumeration> <enumeration value="0220005"> <annotation> <documentation>posterolateral</documentation> </annotation> </enumeration> <enumeration value="0220006"> <annotation> <documentation>2-Inzisionen-Zugang</documentation> </annotation> </enumeration> <enumeration value="0220042"> <annotation> <documentation>sonstiger</documentation> </annotation> </enumeration> </restriction> </simpleType> </pre>
--	---

simpleType enum_0222

namespace	http://xml.ir-d.de/strn		
type	restriction of string		
properties	base xs:string		
facets	Kind	Value	Annotation
	enumeration	0222001	documentation nein
	enumeration	0222002	documentation ja- Ausbau
	enumeration	0222003	documentation ja- Einbau
annotation	documentation Kat_EP_Zweizeitwechsel		
source	<pre> <simpleType name="enum_0222"> <annotation> <documentation>Kat_EP_Zweizeitwechsel</documentation> </annotation> <restriction base="xs:string"> <enumeration value="0222001"> <annotation> <documentation>nein</documentation> </annotation> </enumeration> <enumeration value="0222002"> <annotation> <documentation>ja- Ausbau</documentation> </annotation> </enumeration> </restriction> </simpleType> </pre>		

	<pre> <enumeration value="0222003"> <annotation> <documentation>ja- Einbau</documentation> </annotation> </enumeration> </restriction> </simpleType> </pre>
--	---

simpleType enum_0252

namespace	http://xml.ir-d.de/stn		
type	restriction of string		
properties	base xs:string		
facets	Kind	Value	Annotation
	enumeration	0252001	documentation Pfanne
	enumeration	0252002	documentation Schaft
	enumeration	0252003	documentation beides
annotation	documentation Kat_EP_KomponenteHuefte		
source	<pre> <simpleType name="enum_0252"> <annotation> <documentation>Kat_EP_KomponenteHuefte</documentation> </annotation> <restriction base="xs:string"> <enumeration value="0252001"> <annotation> <documentation>Pfanne</documentation> </annotation> </enumeration> <enumeration value="0252002"> <annotation> <documentation>Schaft</documentation> </annotation> </enumeration> <enumeration value="0252003"> <annotation> <documentation>beides</documentation> </annotation> </enumeration> </restriction> </simpleType> </pre>		

simpleType enum_0254

namespace	http://xml.ir-d.de/stn		
type	restriction of string		
properties	base xs:string		
facets	Kind	Value	Annotation
	enumeration	0254001	documentation Femur
	enumeration	0254002	documentation

	enumeration 0254003 Tibia documentation Patella enumeration 0254004 Tibia documentation mehrere
annotation	documentation Kat_EP_KomponenteKnie
source	<pre> <simpleType name="enum_0254"> <annotation> <documentation>Kat_EP_KomponenteKnie</documentation> </annotation> <restriction base="xs:string"> <enumeration value="0254001"> <annotation> <documentation>Femur</documentation> </annotation> </enumeration> <enumeration value="0254002"> <annotation> <documentation>Tibia</documentation> </annotation> </enumeration> <enumeration value="0254003"> <annotation> <documentation>Patella</documentation> </annotation> </enumeration> <enumeration value="0254004"> <annotation> <documentation>mehrere</documentation> </annotation> </enumeration> </restriction> </simpleType> </pre>

simpleType enum_0256

namespace	http://xml.ir-d.de/stn		
type	restriction of string		
properties	base xs:string		
facets	Kind	Value	Annotation
	enumeration	0256001	documentation Pfanne
	enumeration	0256002	documentation Schaft
	enumeration	0256003	documentation Pfanne und Schaft
	enumeration	0256004	documentation Femur
	enumeration	0256005	documentation Tibia
	enumeration	0256006	documentation Patella
	enumeration	0256007	documentation mehrere
annotation	documentation Kat_EP_KomponenteTFE		

source	<pre> <simpleType name="enum_0256"> <annotation> <documentation>Kat_EP_KomponenteTFE</documentation> </annotation> <restriction base="xs:string"> <enumeration value="0256001"> <annotation> <documentation>Pfanne</documentation> </annotation> </enumeration> <enumeration value="0256002"> <annotation> <documentation>Schaft</documentation> </annotation> </enumeration> <enumeration value="0256003"> <annotation> <documentation>Pfanne und Schaft</documentation> </annotation> </enumeration> <enumeration value="0256004"> <annotation> <documentation>Femur</documentation> </annotation> </enumeration> <enumeration value="0256005"> <annotation> <documentation>Tibia</documentation> </annotation> </enumeration> <enumeration value="0256006"> <annotation> <documentation>Patella</documentation> </annotation> </enumeration> <enumeration value="0256007"> <annotation> <documentation>mehrere</documentation> </annotation> </enumeration> </restriction> </simpleType> </pre>
--------	--

simpleType enum_0262

namespace	http://xml.ir-d.de/stn		
type	restriction of string		
properties	base xs:string		
facets	Kind	Value	Annotation
	enumeration	0262001	documentation Pfanne
	enumeration	0262002	documentation Schaft
	enumeration	0262003	documentation Kopf
	enumeration	0262004	documentation Inlay

	enumeration 0262005 documentation Adapter
	enumeration 0262006 documentation mehrere
annotation	documentation Kat_EP_ImplantatbruchHuefte
source	<pre> <simpleType name="enum_0262"> <annotation> <documentation>Kat_EP_ImplantatbruchHuefte</documentation> </annotation> <restriction base="xs:string"> <enumeration value="0262001"> <annotation> <documentation>Pfanne</documentation> </annotation> </enumeration> <enumeration value="0262002"> <annotation> <documentation>Schaft</documentation> </annotation> </enumeration> <enumeration value="0262003"> <annotation> <documentation>Kopf</documentation> </annotation> </enumeration> <enumeration value="0262004"> <annotation> <documentation>Inlay</documentation> </annotation> </enumeration> <enumeration value="0262005"> <annotation> <documentation>Adapter</documentation> </annotation> </enumeration> <enumeration value="0262006"> <annotation> <documentation>mehrere</documentation> </annotation> </enumeration> </restriction> </simpleType> </pre>

simpleType enum_0264

namespace	http://xml.ir-d.de/stn		
type	restriction of string		
properties	base xs:string		
facets	Kind	Value	Annotation
	enumeration	0264001	documentation Femur
	enumeration	0264002	documentation Tibia
	enumeration	0264003	documentation Inlay
	enumeration	0264004	documentation

	<p>enumeration 0264005 Adapter documentation Verlängerung</p> <p>enumeration 0264006 documentation Schrauben</p> <p>enumeration 0264007 documentation mehrere</p> <p>enumeration 0264042 documentation andere</p>
annotation	documentation Kat_EP_ImplantatbruchKnie
source	<pre> <simpleType name="enum_0264"> <annotation> <documentation>Kat_EP_ImplantatbruchKnie</documentation> </annotation> <restriction base="xs:string"> <enumeration value="0264001"> <annotation> <documentation>Femur</documentation> </annotation> </enumeration> <enumeration value="0264002"> <annotation> <documentation>Tibia</documentation> </annotation> </enumeration> <enumeration value="0264003"> <annotation> <documentation>Inlay</documentation> </annotation> </enumeration> <enumeration value="0264004"> <annotation> <documentation>Adapter</documentation> </annotation> </enumeration> <enumeration value="0264005"> <annotation> <documentation>Verlängerung</documentation> </annotation> </enumeration> <enumeration value="0264006"> <annotation> <documentation>Schrauben</documentation> </annotation> </enumeration> <enumeration value="0264007"> <annotation> <documentation>mehrere</documentation> </annotation> </enumeration> <enumeration value="0264042"> <annotation> <documentation>andere</documentation> </annotation> </enumeration> </restriction> </simpleType> </pre>

simpleType enum_0266

namespace	http://xml.ir-d.de/stn		
type	restriction of string		
properties	base xs:string		
facets	Kind	Value	Annotation
	enumeration	0266001	documentation Pfanne
	enumeration	0266002	documentation Schaft
	enumeration	0266003	documentation Kopf
	enumeration	0266004	documentation Inlay
	enumeration	0266005	documentation Adapter
	enumeration	0266006	documentation Femur
	enumeration	0266007	documentation Tibia
	enumeration	0266008	documentation Verlängerung
	enumeration	0266009	documentation Schrauben
	enumeration	0266010	documentation mehrere
	enumeration	0266042	documentation andere
annotation	documentation Kat_EP_ImplantatbruchTFE		
source	<pre> <simpleType name="enum_0266"> <annotation> <documentation>Kat_EP_ImplantatbruchTFE</documentation> </annotation> <restriction base="xs:string"> <enumeration value="0266001"> <annotation> <documentation>Pfanne</documentation> </annotation> </enumeration> <enumeration value="0266002"> <annotation> <documentation>Schaft</documentation> </annotation> </enumeration> <enumeration value="0266003"> <annotation> <documentation>Kopf</documentation> </annotation> </enumeration> <enumeration value="0266004"> <annotation> <documentation>Inlay</documentation> </annotation> </enumeration> <enumeration value="0266005"> <annotation> <documentation>Adapter</documentation> </annotation> </enumeration> </restriction> </simpleType> </pre>		

	<pre> </enumeration> <enumeration value="0266006"> <annotation> <documentation>Femur</documentation> </annotation> </enumeration> <enumeration value="0266007"> <annotation> <documentation>Tibia</documentation> </annotation> </enumeration> <enumeration value="0266008"> <annotation> <documentation>Verlängerung</documentation> </annotation> </enumeration> <enumeration value="0266009"> <annotation> <documentation>Schrauben</documentation> </annotation> </enumeration> <enumeration value="0266010"> <annotation> <documentation>mehrere</documentation> </annotation> </enumeration> <enumeration value="0266042"> <annotation> <documentation>andere</documentation> </annotation> </enumeration> </restriction> </simpleType> </pre>
--	--

simpleType enum_0270

namespace	http://xml.lir-d.de/stn		
type	restriction of string		
properties	base xs:string		
facets	Kind	Value	Annotation
	enumeration	0270001	documentation PE-Inlay
	enumeration	0270002	documentation patellare Komponente
	enumeration	0270003	documentation beides
annotation	documentation Kat_EP_VerschleissKnie		
source	<pre> <simpleType name="enum_0270"> <annotation> <documentation>Kat_EP_VerschleissKnie</documentation> </annotation> <restriction base="xs:string"> <enumeration value="0270001"> <annotation> <documentation>PE-Inlay</documentation> </annotation> </pre>		

	<pre> </enumeration> <enumeration value="0270002"> <annotation> <documentation>patellare Komponente</documentation> </annotation> </enumeration> <enumeration value="0270003"> <annotation> <documentation>beides</documentation> </annotation> </enumeration> </restriction> </simpleType> </pre>
--	--

simpleType enum_0271

namespace	http://xml.ir-d.de/stn																					
type	restriction of string																					
properties	base xs:string																					
facets	<table border="1"> <thead> <tr> <th>Kind</th> <th>Value</th> <th>Annotation</th> </tr> </thead> <tbody> <tr> <td>enumeration</td> <td>0271001</td> <td>documentation Schraube</td> </tr> <tr> <td>enumeration</td> <td>0271002</td> <td>documentation Inlay</td> </tr> <tr> <td>enumeration</td> <td>0271003</td> <td>documentation patellare Komponente</td> </tr> <tr> <td>enumeration</td> <td>0271004</td> <td>documentation Kopplung</td> </tr> <tr> <td>enumeration</td> <td>0271005</td> <td>documentation mehrere</td> </tr> <tr> <td>enumeration</td> <td>0271042</td> <td>documentation andere</td> </tr> </tbody> </table>	Kind	Value	Annotation	enumeration	0271001	documentation Schraube	enumeration	0271002	documentation Inlay	enumeration	0271003	documentation patellare Komponente	enumeration	0271004	documentation Kopplung	enumeration	0271005	documentation mehrere	enumeration	0271042	documentation andere
Kind	Value	Annotation																				
enumeration	0271001	documentation Schraube																				
enumeration	0271002	documentation Inlay																				
enumeration	0271003	documentation patellare Komponente																				
enumeration	0271004	documentation Kopplung																				
enumeration	0271005	documentation mehrere																				
enumeration	0271042	documentation andere																				
annotation	documentation Kat_EP_MigrationKnie																					
source	<pre> <simpleType name="enum_0271"> <annotation> <documentation>Kat_EP_MigrationKnie</documentation> </annotation> <restriction base="xs:string"> <enumeration value="0271001"> <annotation> <documentation>Schraube</documentation> </annotation> </enumeration> <enumeration value="0271002"> <annotation> <documentation>Inlay</documentation> </annotation> </enumeration> <enumeration value="0271003"> <annotation> <documentation>patellare Komponente</documentation> </annotation> </enumeration> <enumeration value="0271004"> <annotation> <documentation>Kopplung</documentation> </annotation> </enumeration> </restriction> </simpleType> </pre>																					

	<pre> </annotation> </enumeration> <enumeration value="0271005"> <annotation> <documentation>mehrere</documentation> </annotation> </enumeration> <enumeration value="0271042"> <annotation> <documentation>andere</documentation> </annotation> </enumeration> </restriction> </simpleType> </pre>
--	---

simpleType enum_0280

namespace	http://xml.lir-d.de/stn		
type	restriction of string		
properties	base xs:string		
facets	Kind	Value	Annotation
	enumeration	0280001	documentation Ohne
	enumeration	0280002	documentation PSI
	enumeration	0280003	documentation Navigation
	enumeration	0280004	documentation Robotik
	enumeration	0280042	documentation Unbekannt
annotation	documentation Kat_EP_AssistiveTechnologie		
source	<pre> <simpleType name="enum_0280"> <annotation> <documentation>Kat_EP_AssistiveTechnologie</documentation> </annotation> <restriction base="xs:string"> <enumeration value="0280001"> <annotation> <documentation>Ohne</documentation> </annotation> </enumeration> <enumeration value="0280002"> <annotation> <documentation>PSI</documentation> </annotation> </enumeration> <enumeration value="0280003"> <annotation> <documentation>Navigation</documentation> </annotation> </enumeration> <enumeration value="0280004"> <annotation> <documentation>Robotik</documentation> </annotation> </enumeration> </restriction> </simpleType> </pre>		

```

</enumeration>
<enumeration value="0280042">
  <annotation>
    <documentation>Unbekannt</documentation>
  </annotation>
</enumeration>
</restriction>
</simpleType>

```

simpleType enum_0281

namespace	http://xml.ir-d.de/strn		
type	restriction of string		
properties	base xs:string		
facets	Kind	Value	Annotation
	enumeration	0281001	documentation Aesculap - OrthoPilot
	enumeration	0281002	documentation Amplitude - Amplivision
	enumeration	0281003	documentation Johnson & Johnson - VELYS
	enumeration	0281004	documentation Orthokey - Orthokey Miro
	enumeration	0281005	documentation Orthokey - BLU-IGS
	enumeration	0281006	documentation Smith & Nephew - Brainlab Plattformen (TBD)
	enumeration	0281007	documentation Stryker - Stryker NAV3i
	enumeration	0281008	documentation Stryker - Stryker Ortho Q Guidance System
	enumeration	0281009	documentation ThinkSurgical - TMINI
	enumeration	0281010	documentation Zimmer Biomet - Sesamoid Navigation
	enumeration	0281011	documentation Zimmer Biomet - iAssist Navigation
	enumeration	0281012	documentation nicht belegter Wert
	enumeration	0281013	documentation nicht belegter Wert
	enumeration	0281014	documentation nicht belegter Wert
	enumeration	0281015	documentation nicht belegter Wert
	enumeration	0281016	documentation nicht belegter Wert
	enumeration	0281042	documentation sonstige
annotation	documentation Kat_EP_Navigation		
source	<pre> <simpleType name="enum_0281"> <annotation> <documentation>Kat_EP_Navigation</documentation> </annotation> <restriction base="xs:string"> <enumeration value="0281001"> <annotation> <documentation>Aesculap - OrthoPilot</documentation> </pre>		

```

</annotation>
</enumeration>
<enumeration value="0281002">
  <annotation>
    <documentation>Amplitude - Amplivision</documentation>
  </annotation>
</enumeration>
<enumeration value="0281003">
  <annotation>
    <documentation>Johnson & Johnson - VELYS</documentation>
  </annotation>
</enumeration>
<enumeration value="0281004">
  <annotation>
    <documentation>Orthokey - Orthokey Miro</documentation>
  </annotation>
</enumeration>
<enumeration value="0281005">
  <annotation>
    <documentation>Orthokey - BLU-IGS</documentation>
  </annotation>
</enumeration>
<enumeration value="0281006">
  <annotation>
    <documentation>Smith & Nephew - Brainlab Plattformen
(TBD)</documentation>
  </annotation>
</enumeration>
<enumeration value="0281007">
  <annotation>
    <documentation>Stryker - Stryker NAV3i</documentation>
  </annotation>
</enumeration>
<enumeration value="0281008">
  <annotation>
    <documentation>Stryker - Stryker Ortho Q Guidance
System</documentation>
  </annotation>
</enumeration>
<enumeration value="0281009">
  <annotation>
    <documentation>ThinkSurgical - TMINI</documentation>
  </annotation>
</enumeration>
<enumeration value="0281010">
  <annotation>
    <documentation>Zimmer Biomet - Sesamoid Navigation</documentation>
  </annotation>
</enumeration>
<enumeration value="0281011">
  <annotation>
    <documentation>Zimmer Biomet - iAssist Navigation</documentation>
  </annotation>
</enumeration>
<enumeration value="0281012">
  <annotation>
    <documentation>nicht belegter Wert</documentation>
  </annotation>
</enumeration>

```

```

<enumeration value="0281013">
  <annotation>
    <documentation>nicht belegter Wert</documentation>
  </annotation>
</enumeration>
<enumeration value="0281014">
  <annotation>
    <documentation>nicht belegter Wert</documentation>
  </annotation>
</enumeration>
<enumeration value="0281015">
  <annotation>
    <documentation>nicht belegter Wert</documentation>
  </annotation>
</enumeration>
<enumeration value="0281016">
  <annotation>
    <documentation>nicht belegter Wert</documentation>
  </annotation>
</enumeration>
<enumeration value="0281042">
  <annotation>
    <documentation>sonstige</documentation>
  </annotation>
</enumeration>
</restriction>
</simpleType>

```

simpleType enum_0282

namespace	http://xml.ir-d.de/stn		
type	restriction of string		
properties	base xs:string		
facets	Kind	Value	Annotation
	enumeration	0282001	documentation Amplitude - Andy
	enumeration	0282002	documentation Corin - ApolloKnee
	enumeration	0282003	documentation Corin - OMNIBotics
	enumeration	0282004	documentation Microport - Skywalker
	enumeration	0282005	documentation Orthokey - Orthokey Robin
	enumeration	0282006	documentation Smith & Nephew - CORI
	enumeration	0282007	documentation Smith & Nephew - NAVIO
	enumeration	0282008	documentation Stryker - Mako SmartRobotics
	enumeration	0282009	documentation Zimmer Biomet - ROSA
	enumeration	0282010	documentation Johnson & Johnson - VELYS Robotic Assisted Solution
	enumeration	0282011	documentation nicht belegter Wert
	enumeration	0282012	documentation nicht belegter Wert
	enumeration	0282013	documentation

	<p>enumeration 0282014 nicht belegter Wert documentation</p> <p>enumeration 0282015 nicht belegter Wert documentation</p> <p>enumeration 0282042 nicht belegter Wert documentation sonstige</p>
annotation	documentation Kat_EP_Robotik
source	<pre> <simpleType name="enum_0282"> <annotation> <documentation>Kat_EP_Robotik</documentation> </annotation> <restriction base="xs:string"> <enumeration value="0282001"> <annotation> <documentation>Amplitude - Andy</documentation> </annotation> </enumeration> <enumeration value="0282002"> <annotation> <documentation>Corin - ApolloKnee</documentation> </annotation> </enumeration> <enumeration value="0282003"> <annotation> <documentation>Corin - OMNIBotics</documentation> </annotation> </enumeration> <enumeration value="0282004"> <annotation> <documentation>Microport - Skywalker</documentation> </annotation> </enumeration> <enumeration value="0282005"> <annotation> <documentation>Orthokey - Orthokey Robin</documentation> </annotation> </enumeration> <enumeration value="0282006"> <annotation> <documentation>Smith & Nephew - CORI</documentation> </annotation> </enumeration> <enumeration value="0282007"> <annotation> <documentation>Smith & Nephew - NAVIO</documentation> </annotation> </enumeration> <enumeration value="0282008"> <annotation> <documentation>Stryker - Mako SmartRobotics</documentation> </annotation> </enumeration> <enumeration value="0282009"> <annotation> <documentation>Zimmer Biomet - ROSA</documentation> </annotation> </enumeration> </restriction> </simpleType> </pre>

```

<enumeration value="0282010">
  <annotation>
    <documentation>Johnson & Johnson - VELYS Robotic Assisted
Solution</documentation>
  </annotation>
</enumeration>
<enumeration value="0282011">
  <annotation>
    <documentation>nicht belegter Wert</documentation>
  </annotation>
</enumeration>
<enumeration value="0282012">
  <annotation>
    <documentation>nicht belegter Wert</documentation>
  </annotation>
</enumeration>
<enumeration value="0282013">
  <annotation>
    <documentation>nicht belegter Wert</documentation>
  </annotation>
</enumeration>
<enumeration value="0282014">
  <annotation>
    <documentation>nicht belegter Wert</documentation>
  </annotation>
</enumeration>
<enumeration value="0282015">
  <annotation>
    <documentation>nicht belegter Wert</documentation>
  </annotation>
</enumeration>
<enumeration value="0282042">
  <annotation>
    <documentation>sonstige</documentation>
  </annotation>
</enumeration>
</restriction>
</simpleType>

```

simpleType enum 0290

namespace	http://xml.ir-d.de/stn		
type	restriction of string		
properties	base xs:string		
facets	Kind	Value	Annotation
	enumeration	0290001	documentation Hüft-Komponente
	enumeration	0290002	documentation Knie-Komponente
	enumeration	0290003	documentation Modulare Komponente (Hüfte/Knie)
	enumeration	0290004	documentation Knochenzement
	enumeration	0290042	documentation sonstiger
annotation	documentation Kat_EP_Artikeltyp		

source	<pre> <simpleType name="enum_0290"> <annotation> <documentation>Kat_EP_Artikeltyp</documentation> </annotation> <restriction base="xs:string"> <enumeration value="0290001"> <annotation> <documentation>Hüft-Komponente</documentation> </annotation> </enumeration> <enumeration value="0290002"> <annotation> <documentation>Knie-Komponente</documentation> </annotation> </enumeration> <enumeration value="0290003"> <annotation> <documentation>Modulare Komponente (Hüfte/Knie)</documentation> </annotation> </enumeration> <enumeration value="0290004"> <annotation> <documentation>Knochenzement</documentation> </annotation> </enumeration> <enumeration value="0290042"> <annotation> <documentation>sonstiger</documentation> </annotation> </enumeration> </restriction> </simpleType> </pre>
--------	--

simpleType enum_0292

namespace	http://xml.ir-d.de/stn		
type	restriction of string		
properties	base xs:string		
facets	Kind	Value	Annotation
	enumeration	0292001	documentation Pfanne
	enumeration	0292002	documentation Inlay
	enumeration	0292003	documentation Kopf
	enumeration	0292004	documentation Schaft
	enumeration	0292005	documentation Vormontierte Acetabularkomponente (Pfanne mit Inlay)
	enumeration	0292006	documentation Einteilige Femoralkomponente (Schaft mit Kopf)
	enumeration	0292042	documentation sonstiger
annotation	documentation Kat_EP_ArtikeltypHuefte		
source	<pre> <simpleType name="enum_0292"> <annotation> </pre>		

```

<documentation>Kat_EP_ArtikeltypHuefte</documentation>
</annotation>
<restriction base="xs:string">
  <enumeration value="0292001">
    <annotation>
      <documentation>Pfanne</documentation>
    </annotation>
  </enumeration>
  <enumeration value="0292002">
    <annotation>
      <documentation>Inlay</documentation>
    </annotation>
  </enumeration>
  <enumeration value="0292003">
    <annotation>
      <documentation>Kopf</documentation>
    </annotation>
  </enumeration>
  <enumeration value="0292004">
    <annotation>
      <documentation>Schaft</documentation>
    </annotation>
  </enumeration>
  <enumeration value="0292005">
    <annotation>
      <documentation>Vormontierte Acetabularkomponente (Pfanne mit
Inlay)</documentation>
    </annotation>
  </enumeration>
  <enumeration value="0292006">
    <annotation>
      <documentation>Einteilige Femoralkomponente (Schaft mit
Kopf)</documentation>
    </annotation>
  </enumeration>
  <enumeration value="0292042">
    <annotation>
      <documentation>sonstiger</documentation>
    </annotation>
  </enumeration>
</restriction>
</simpleType>

```

simpleType enum_0293

namespace	http://xml.ir-d.de/stn		
type	restriction of string		
properties	base xs:string		
facets	Kind	Value	Annotation
	enumeration	0293001	documentation Tibiakomponente
	enumeration	0293002	documentation Femurkomponente
	enumeration	0293003	documentation Patella
	enumeration	0293004	documentation Insert

	enumeration 0293005 documentation Vormontierte Tibiakomponente mit Insert enumeration 0293042 documentation sonstiger
annotation	documentation Kat_EP_ArtikeltypKnie
source	<pre> <simpleType name="enum_0293"> <annotation> <documentation>Kat_EP_ArtikeltypKnie</documentation> </annotation> <restriction base="xs:string"> <enumeration value="0293001"> <annotation> <documentation>Tibiakomponente</documentation> </annotation> </enumeration> <enumeration value="0293002"> <annotation> <documentation>Femurkomponente</documentation> </annotation> </enumeration> <enumeration value="0293003"> <annotation> <documentation>Patella</documentation> </annotation> </enumeration> <enumeration value="0293004"> <annotation> <documentation>Insert</documentation> </annotation> </enumeration> <enumeration value="0293005"> <annotation> <documentation>Vormontierte Tibiakomponente mit Insert</documentation> </annotation> </enumeration> <enumeration value="0293042"> <annotation> <documentation>sonstiger</documentation> </annotation> </enumeration> </restriction> </simpleType> </pre>

simpleType enum_0300

namespace	http://xml.ir-d.de/stn		
type	restriction of string		
properties	base xs:string		
facets	Kind	Value	Annotation
	enumeration	0300001	documentation konventioneller Aortenklappenersatz
	enumeration	0300002	documentation kathetergestützte Aortenklappenimplantation (TAVI)
annotation	documentation Kat_AK_ArtEingriff		

source	<pre> <simpleType name="enum_0300"> <annotation> <documentation>Kat_AK_ArtEingriff</documentation> </annotation> <restriction base="xs:string"> <enumeration value="0300001"> <annotation> <documentation>konventioneller Aortenklappenersatz</documentation> </annotation> </enumeration> <enumeration value="0300002"> <annotation> <documentation>kathetergestützte Aortenklappenimplantation (TAVI)</documentation> </annotation> </enumeration> </restriction> </simpleType> </pre>
--------	--

simpleType enum_0301

namespace	http://xml.ir-d.de/stn		
type	restriction of string		
properties	base xs:string		
facets	Kind	Value	Annotation
	enumeration	0301001	documentation produktbezogen
	enumeration	0301002	documentation nicht-produktbezogen
annotation	documentation Kat_AK_GrundAbbruch		
source	<pre> <simpleType name="enum_0301"> <annotation> <documentation>Kat_AK_GrundAbbruch</documentation> </annotation> <restriction base="xs:string"> <enumeration value="0301001"> <annotation> <documentation>produktbezogen</documentation> </annotation> </enumeration> <enumeration value="0301002"> <annotation> <documentation>nicht-produktbezogen</documentation> </annotation> </enumeration> </restriction> </simpleType> </pre>		

simpleType enum_0302

namespace	http://xml.ir-d.de/stn		
type	restriction of string		
properties	base xs:string		

facets	<table border="1"> <thead> <tr> <th>Kind</th> <th>Value</th> <th>Annotation</th> </tr> </thead> <tbody> <tr> <td>enumeration</td> <td>0302001</td> <td>documentation Stenose</td> </tr> <tr> <td>enumeration</td> <td>0302002</td> <td>documentation Insuffizienz</td> </tr> <tr> <td>enumeration</td> <td>0302003</td> <td>documentation Stenose und Insuffizienz</td> </tr> <tr> <td>enumeration</td> <td>0302042</td> <td>documentation sonstiger</td> </tr> </tbody> </table>	Kind	Value	Annotation	enumeration	0302001	documentation Stenose	enumeration	0302002	documentation Insuffizienz	enumeration	0302003	documentation Stenose und Insuffizienz	enumeration	0302042	documentation sonstiger
Kind	Value	Annotation														
enumeration	0302001	documentation Stenose														
enumeration	0302002	documentation Insuffizienz														
enumeration	0302003	documentation Stenose und Insuffizienz														
enumeration	0302042	documentation sonstiger														
annotation	documentation Kat_AK_GrundEingriff															
source	<pre> <simpleType name="enum_0302"> <annotation> <documentation>Kat_AK_GrundEingriff</documentation> </annotation> <restriction base="xs:string"> <enumeration value="0302001"> <annotation> <documentation>Stenose</documentation> </annotation> </enumeration> <enumeration value="0302002"> <annotation> <documentation>Insuffizienz</documentation> </annotation> </enumeration> <enumeration value="0302003"> <annotation> <documentation>Stenose und Insuffizienz</documentation> </annotation> </enumeration> <enumeration value="0302042"> <annotation> <documentation>sonstiger</documentation> </annotation> </enumeration> </restriction> </simpleType> </pre>															

simpleType enum_0318

namespace	http://xml.ir-d.de/stn																		
type	restriction of string																		
properties	base xs:string																		
facets	<table border="1"> <thead> <tr> <th>Kind</th> <th>Value</th> <th>Annotation</th> </tr> </thead> <tbody> <tr> <td>enumeration</td> <td>0318001</td> <td>documentation transapikal</td> </tr> <tr> <td>enumeration</td> <td>0318002</td> <td>documentation transaortal</td> </tr> <tr> <td>enumeration</td> <td>0318003</td> <td>documentation transfemoral</td> </tr> <tr> <td>enumeration</td> <td>0318004</td> <td>documentation transaxillär</td> </tr> <tr> <td>enumeration</td> <td>0318042</td> <td>documentation anderer Zugangsweg</td> </tr> </tbody> </table>	Kind	Value	Annotation	enumeration	0318001	documentation transapikal	enumeration	0318002	documentation transaortal	enumeration	0318003	documentation transfemoral	enumeration	0318004	documentation transaxillär	enumeration	0318042	documentation anderer Zugangsweg
Kind	Value	Annotation																	
enumeration	0318001	documentation transapikal																	
enumeration	0318002	documentation transaortal																	
enumeration	0318003	documentation transfemoral																	
enumeration	0318004	documentation transaxillär																	
enumeration	0318042	documentation anderer Zugangsweg																	
annotation	documentation Kat_AK_ZugangKatheter																		

source	<pre> <simpleType name="enum_0318"> <annotation> <documentation>Kat_AK_ZugangKatheter</documentation> </annotation> <restriction base="xs:string"> <enumeration value="0318001"> <annotation> <documentation>transapikal</documentation> </annotation> </enumeration> <enumeration value="0318002"> <annotation> <documentation>transaortal</documentation> </annotation> </enumeration> <enumeration value="0318003"> <annotation> <documentation>transfemorale</documentation> </annotation> </enumeration> <enumeration value="0318004"> <annotation> <documentation>transaxillär</documentation> </annotation> </enumeration> <enumeration value="0318042"> <annotation> <documentation>anderer Zugangsweg</documentation> </annotation> </enumeration> </restriction> </simpleType> </pre>
--------	---

simpleType enum_0320

namespace	http://xml.ir-d.de/stn		
type	restriction of string		
properties	base xs:string		
facets	Kind	Value	Annotation
	enumeration	0320001	documentation konventionelle Sternotomie
	enumeration	0320002	documentation partielle Sternotomie
	enumeration	0320003	documentation parasternaler Zugang
	enumeration	0320042	documentation anderer Zugangsweg
annotation	documentation Kat_AK_ZugangKonventionell		
source	<pre> <simpleType name="enum_0320"> <annotation> <documentation>Kat_AK_ZugangKonventionell</documentation> </annotation> <restriction base="xs:string"> <enumeration value="0320001"> <annotation> <documentation>konventionelle Sternotomie</documentation> </pre>		

	<pre> </annotation> </enumeration> <enumeration value="0320002"> <annotation> <documentation>partielle Sternotomie</documentation> </annotation> </enumeration> <enumeration value="0320003"> <annotation> <documentation>parasternaler Zugang</documentation> </annotation> </enumeration> <enumeration value="0320042"> <annotation> <documentation>anderer Zugangsweg</documentation> </annotation> </enumeration> </restriction> </simpleType> </pre>
--	---

simpleType enum 0322

namespace	http://xml.ir-d.de/stn		
type	restriction of string		
properties	base xs:string		
facets	Kind	Value	Annotation
	enumeration	0322001	documentation nein
	enumeration	0322002	documentation ja, diätetisch behandelt
	enumeration	0322003	documentation ja, orale Medikation
	enumeration	0322004	documentation ja, mit Insulin behandelt
	enumeration	0322005	documentation ja, unbehandelt
	enumeration	0322099	documentation unbekannt
annotation	documentation Kat_AK_Diabetes		
source	<pre> <simpleType name="enum_0322"> <annotation> <documentation>Kat_AK_Diabetes</documentation> </annotation> <restriction base="xs:string"> <enumeration value="0322001"> <annotation> <documentation>nein</documentation> </annotation> </enumeration> <enumeration value="0322002"> <annotation> <documentation>ja, diätetisch behandelt</documentation> </annotation> </enumeration> <enumeration value="0322003"> <annotation> </pre>		

	<pre> <documentation>ja, orale Medikation</documentation> </annotation> </enumeration> <enumeration value="0322004"> <annotation> <documentation>ja, mit Insulin behandelt</documentation> </annotation> </enumeration> <enumeration value="0322005"> <annotation> <documentation>ja, unbehandelt</documentation> </annotation> </enumeration> <enumeration value="0322099"> <annotation> <documentation>unbekannt</documentation> </annotation> </enumeration> </restriction> </simpleType> </pre>
--	---

simpleType enum_0324

namespace	http://xml.ir-d.de/stn		
type	restriction of string		
properties	base xs:string		
facets	Kind	Value	Annotation
	enumeration	0324001	documentation (I): Beschwerdefreiheit, normale körperliche Belastbarkeit
	enumeration	0324002	documentation (II): Beschwerden bei stärkerer körperlicher Belastung
	enumeration	0324003	documentation (III): Beschwerden bei leichter körperlicher Belastung
	enumeration	0324004	documentation (IV): Beschwerden in Ruhe
annotation	documentation Kat_AK_NYHA		
source	<pre> <simpleType name="enum_0324"> <annotation> <documentation>Kat_AK_NYHA</documentation> </annotation> <restriction base="xs:string"> <enumeration value="0324001"> <annotation> <documentation>(I): Beschwerdefreiheit, normale körperliche Belastbarkeit</documentation> </annotation> </enumeration> <enumeration value="0324002"> <annotation> <documentation>(II): Beschwerden bei stärkerer körperlicher Belastung</documentation> </annotation> </enumeration> <enumeration value="0324003"> <annotation> <documentation>(III): Beschwerden bei leichter körperlicher </pre>		

	<pre> Belastung</documentation> </annotation> </enumeration> <enumeration value="0324004"> <annotation> <documentation>(IV): Beschwerden in Ruhe</documentation> </annotation> </enumeration> </restriction> </simpleType> </pre>
--	---

simpleType enum_0338

namespace	http://xml.ir-d.de/stn		
type	restriction of string		
properties	base xs:string		
facets	Kind	Value	Annotation
	enumeration	0338001	documentation LAD
	enumeration	0338002	documentation RCA
	enumeration	0338003	documentation RCX
	enumeration	0338004	documentation Hauptstamm
annotation	documentation Kat_AK_PCIArterien		
source	<pre> <simpleType name="enum_0338"> <annotation> <documentation>Kat_AK_PCIArterien</documentation> </annotation> <restriction base="xs:string"> <enumeration value="0338001"> <annotation> <documentation>LAD</documentation> </annotation> </enumeration> <enumeration value="0338002"> <annotation> <documentation>RCA</documentation> </annotation> </enumeration> <enumeration value="0338003"> <annotation> <documentation>RCX</documentation> </annotation> </enumeration> <enumeration value="0338004"> <annotation> <documentation>Hauptstamm</documentation> </annotation> </enumeration> </restriction> </simpleType> </pre>		

simpleType enum_0339

namespace	http://xml.ir-d.de/stn		
type	restriction of string		
properties	base xs:string		
facets	Kind	Value	Annotation
	enumeration	0339001	documentation TEE
	enumeration	0339002	documentation CT
	enumeration	0339042	documentation andere
annotation	documentation Kat_AK_AnnulusMessmethode		
source	<pre> <simpleType name="enum_0339"> <annotation> <documentation>Kat_AK_AnnulusMessmethode</documentation> </annotation> <restriction base="xs:string"> <enumeration value="0339001"> <annotation> <documentation>TEE</documentation> </annotation> </enumeration> <enumeration value="0339002"> <annotation> <documentation>CT</documentation> </annotation> </enumeration> <enumeration value="0339042"> <annotation> <documentation>andere</documentation> </annotation> </enumeration> </restriction> </simpleType> </pre>		

simpleType enum_0341

namespace	http://xml.ir-d.de/stn		
type	restriction of string		
properties	base xs:string		
facets	Kind	Value	Annotation
	enumeration	0341001	documentation intraprozedural verstorben
	enumeration	0341002	documentation Implantation von mehr als einer Prothese
	enumeration	0341003	documentation gravierende Gefäß- oder Zugangskomplikation (gemäß VARC-3)
	enumeration	0341004	documentation erforderlicher chirurgischer oder interventioneller Eingriff wegen einer Klappenfehlfunktion (gemäß VARC-3)
	enumeration	0341005	documentation >= große strukturelle kardiale Komplikation (gemäß VARC-3)
annotation	documentation Kat_AK_FailureGrund		

source	<pre> <simpleType name="enum_0341"> <annotation> <documentation>Kat_AK_FailureGrund</documentation> </annotation> <restriction base="xs:string"> <enumeration value="0341001"> <annotation> <documentation>intraprozedural verstorben</documentation> </annotation> </enumeration> <enumeration value="0341002"> <annotation> <documentation>Implantation von mehr als einer Prothese</documentation> </annotation> </enumeration> <enumeration value="0341003"> <annotation> <documentation>gravierende Gefäß- oder Zugangskomplikation (gemäß VARC-3)</documentation> </annotation> </enumeration> <enumeration value="0341004"> <annotation> <documentation>erforderlicher chirurgischer oder interventioneller Eingriff wegen einer Klappenfehlfunktion (gemäß VARC-3)</documentation> </annotation> </enumeration> <enumeration value="0341005"> <annotation> <documentation>&gt;= große strukturelle kardiale Komplikation (gemäß VARC-3)</documentation> </annotation> </enumeration> </restriction> </simpleType> </pre>
--------	--

simpleType enum_0342

namespace	http://xml.ir-d.de/stn		
type	restriction of string		
properties	base xs:string		
facets	Kind	Value	Annotation
	enumeration	0342001	documentation Alter
	enumeration	0342002	documentation Frailty
	enumeration	0342003	documentation Hochrisiko
	enumeration	0342004	documentation Prognose-limitierende Zweiterkrankung
	enumeration	0342005	documentation Porzellan-Aorta
	enumeration	0342042	documentation sonstiger
annotation	documentation Kat_AK_Tavi		

source	<pre> <simpleType name="enum_0342"> <annotation> <documentation>Kat_AK_Tavi</documentation> </annotation> <restriction base="xs:string"> <enumeration value="0342001"> <annotation> <documentation>Alter</documentation> </annotation> </enumeration> <enumeration value="0342002"> <annotation> <documentation>Frailty</documentation> </annotation> </enumeration> <enumeration value="0342003"> <annotation> <documentation>Hochrisiko</documentation> </annotation> </enumeration> <enumeration value="0342004"> <annotation> <documentation>Prognose-limitierende Zweiterkrankung</documentation> </annotation> </enumeration> <enumeration value="0342005"> <annotation> <documentation>Porzellan-Aorta</documentation> </annotation> </enumeration> <enumeration value="0342042"> <annotation> <documentation>sonstiger</documentation> </annotation> </enumeration> </restriction> </simpleType> </pre>
--------	---

simpleType enum_0343

namespace	http://xml.ir-d.de/stn		
type	restriction of string		
properties	base xs:string		
facets	Kind	Value	Annotation
	enumeration	0343001	documentation Device-Fehlpositionierung
	enumeration	0343002	documentation Koronarostienverschluss
	enumeration	0343003	documentation Aortendissektion
	enumeration	0343004	documentation Aortenregurgitation > = 2. Grades
	enumeration	0343005	documentation Annulus-Ruptur
	enumeration	0343006	documentation Ruptur-/Perforation einer Herzhöhle ohne Therapiebedarf
	enumeration	0343007	documentation

	<p>enumeration 0343008 Ruptur-/Perforation einer Herzhöhle mit Therapiebedarf documentation Perikardtamponade</p> <p>enumeration 0343009 documentation kardiale Dekompensation</p> <p>enumeration 0343010 documentation Hirnembolie</p> <p>enumeration 0343011 documentation Rhythmusstörungen</p> <p>enumeration 0343012 documentation Device-Embolisation</p> <p>enumeration 0343013 documentation vaskuläre Komplikation</p> <p>enumeration 0343014 documentation Low Cardiac Output</p> <p>enumeration 0343015 documentation schwerwiegende Blutungen (intraprozedural)</p> <p>enumeration 0343016 documentation lebensbedrohliche Blutungen (intraprozedural)</p> <p>enumeration 0343017 documentation Patient verstarb im OP/Katheterlabor</p> <p>enumeration 0343042 documentation sonstiger</p>
annotation	documentation Kat_AK_KomplikationTyp
source	<pre> <simpleType name="enum_0343"> <annotation> <documentation>Kat_AK_KomplikationTyp</documentation> </annotation> <restriction base="xs:string"> <enumeration value="0343001"> <annotation> <documentation>Device-Fehlpositionierung</documentation> </annotation> </enumeration> <enumeration value="0343002"> <annotation> <documentation>Koronarostienverschluss</documentation> </annotation> </enumeration> <enumeration value="0343003"> <annotation> <documentation>Aortendissektion</documentation> </annotation> </enumeration> <enumeration value="0343004"> <annotation> <documentation>Aortenregurgitation &gt; = 2. Grades</documentation> </annotation> </enumeration> <enumeration value="0343005"> <annotation> <documentation>Annulus-Ruptur</documentation> </annotation> </enumeration> <enumeration value="0343006"> <annotation> <documentation>Ruptur-/Perforation einer Herzhöhle ohne Therapiebedarf</documentation> </annotation> </enumeration> </restriction> </simpleType> </pre>

```

<enumeration value="0343007">
  <annotation>
    <documentation>Ruptur-/Perforation einer Herzhöhle mit
Therapiebedarf</documentation>
  </annotation>
</enumeration>
<enumeration value="0343008">
  <annotation>
    <documentation>Perikardtamponade</documentation>
  </annotation>
</enumeration>
<enumeration value="0343009">
  <annotation>
    <documentation>kardiale Dekompensation</documentation>
  </annotation>
</enumeration>
<enumeration value="0343010">
  <annotation>
    <documentation>Hirnembolie</documentation>
  </annotation>
</enumeration>
<enumeration value="0343011">
  <annotation>
    <documentation>Rhythmusstörungen</documentation>
  </annotation>
</enumeration>
<enumeration value="0343012">
  <annotation>
    <documentation>Device-Embolisation</documentation>
  </annotation>
</enumeration>
<enumeration value="0343013">
  <annotation>
    <documentation>vaskuläre Komplikation</documentation>
  </annotation>
</enumeration>
<enumeration value="0343014">
  <annotation>
    <documentation>Low Cardiac Output</documentation>
  </annotation>
</enumeration>
<enumeration value="0343015">
  <annotation>
    <documentation>schwerwiegende Blutungen
(intraprozedural)</documentation>
  </annotation>
</enumeration>
<enumeration value="0343016">
  <annotation>
    <documentation>lebensbedrohliche Blutungen
(intraprozedural)</documentation>
  </annotation>
</enumeration>
<enumeration value="0343017">
  <annotation>
    <documentation>Patient verstarb im OP/Katheterlabor</documentation>
  </annotation>
</enumeration>
<enumeration value="0343042">

```

	<pre> <annotation> <documentation>sonstiger</documentation> </annotation> </enumeration> </restriction> </simpleType> </pre>
--	--

simpleType enum_0346

namespace	http://xml.ir-d.de/stn		
type	restriction of string		
properties	base xs:string		
facets	Kind	Value	Annotation
	enumeration	0346001	documentation keine Therapie erforderlich
	enumeration	0346002	documentation medikamentös
	enumeration	0346003	documentation IABP
	enumeration	0346004	documentation VAD
	enumeration	0346005	documentation ECMO
	enumeration	0346042	documentation sonstige
annotation	documentation Kat AK TherapieLCO		
source	<pre> <simpleType name="enum_0346"> <annotation> <documentation>Kat_AK_TherapieLCO</documentation> </annotation> <restriction base="xs:string"> <enumeration value="0346001"> <annotation> <documentation>keine Therapie erforderlich</documentation> </annotation> </enumeration> <enumeration value="0346002"> <annotation> <documentation>medikamentös</documentation> </annotation> </enumeration> <enumeration value="0346003"> <annotation> <documentation>IABP</documentation> </annotation> </enumeration> <enumeration value="0346004"> <annotation> <documentation>VAD</documentation> </annotation> </enumeration> <enumeration value="0346005"> <annotation> <documentation>ECMO</documentation> </annotation> </enumeration> </restriction> </simpleType> </pre>		

	<pre> <enumeration value="0346042"> <annotation> <documentation>sonstige</documentation> </annotation> </enumeration> </restriction> </simpleType> </pre>
--	---

simpleType enum_0347

namespace	http://xml.ir-d.de/stn		
type	restriction of string		
properties	base xs:string		
facets	Kind	Value	Annotation
	enumeration	0347001	documentation Einzeleingriff
	enumeration	0347002	documentation Kombinationseingriff mit mehreren Prozeduren
annotation	documentation Kat_AK_Eingriffsumfang		
source	<pre> <simpleType name="enum_0347"> <annotation> <documentation>Kat_AK_Eingriffsumfang</documentation> </annotation> <restriction base="xs:string"> <enumeration value="0347001"> <annotation> <documentation>Einzeleingriff</documentation> </annotation> </enumeration> <enumeration value="0347002"> <annotation> <documentation>Kombinationseingriff mit mehreren Prozeduren</documentation> </annotation> </enumeration> </restriction> </simpleType> </pre>		

simpleType enum_0348

namespace	http://xml.ir-d.de/stn		
type	restriction of string		
properties	base xs:string		
facets	Kind	Value	Annotation
	enumeration	0348001	documentation mit HLM
	enumeration	0348002	documentation ohne HLM
	enumeration	0348003	documentation Umstieg von OP ohne HLM auf OP mit HLM
annotation	documentation Kat_AK_OPVorgehen		
source	<pre> <simpleType name="enum_0348"> </pre>		

	<pre> <annotation> <documentation>Kat_AK_OPVorgehen</documentation> </annotation> <restriction base="xs:string"> <enumeration value="0348001"> <annotation> <documentation>mit HLM</documentation> </annotation> </enumeration> <enumeration value="0348002"> <annotation> <documentation>ohne HLM</documentation> </annotation> </enumeration> <enumeration value="0348003"> <annotation> <documentation>Umstieg von OP ohne HLM auf OP mit HLM</documentation> </annotation> </enumeration> </restriction> </simpleType> </pre>
--	---

simpleType enum 0350

namespace	http://xml.ir-d.de/stn		
type	restriction of string		
properties	base xs:string		
facets	Kind	Value	Annotation
	enumeration	0350001	documentation IABP
	enumeration	0350002	documentation Impella
	enumeration	0350003	documentation vv ECMO
	enumeration	0350004	documentation va ECMO
	enumeration	0350042	documentation andere
annotation	documentation Kat_AK_Methode		
source	<pre> <simpleType name="enum_0350"> <annotation> <documentation>Kat_AK_Methode</documentation> </annotation> <restriction base="xs:string"> <enumeration value="0350001"> <annotation> <documentation>IABP</documentation> </annotation> </enumeration> <enumeration value="0350002"> <annotation> <documentation>Impella</documentation> </annotation> </enumeration> <enumeration value="0350003"> <annotation> </pre>		

	<pre> <documentation>vv ECMO</documentation> </annotation> </enumeration> <enumeration value="0350004"> <annotation> <documentation>va ECMO</documentation> </annotation> </enumeration> <enumeration value="0350042"> <annotation> <documentation>andere</documentation> </annotation> </enumeration> </restriction> </simpleType> </pre>
--	--

simpleType enum_0351

namespace	http://xml.ir-d.de/stn		
type	restriction of string		
properties	base xs:string		
facets	Kind	Value	Annotation
	enumeration	0351001	documentation nein
	enumeration	0351002	documentation ja, zu Sternotomie
	enumeration	0351003	documentation ja, zu transapikal
	enumeration	0351004	documentation ja, zu transaortal
	enumeration	0351005	documentation ja, zu transfemoral
	enumeration	0351006	documentation ja, zu transaxillär
	enumeration	0351007	documentation ja, zu anderem endovaskulären Zugang
	enumeration	0351042	documentation ja, zu anderem Zugang
annotation	documentation Kat_AK_Konversion		
source	<pre> <simpleType name="enum_0351"> <annotation> <documentation>Kat_AK_Konversion</documentation> </annotation> <restriction base="xs:string"> <enumeration value="0351001"> <annotation> <documentation>nein</documentation> </annotation> </enumeration> <enumeration value="0351002"> <annotation> <documentation>ja, zu Sternotomie</documentation> </annotation> </enumeration> <enumeration value="0351003"> <annotation> <documentation>ja, zu transapikal</documentation> </pre>		

	<pre> </annotation> </enumeration> <enumeration value="0351004"> <annotation> <documentation>ja, zu transaortal</documentation> </annotation> </enumeration> <enumeration value="0351005"> <annotation> <documentation>ja, zu transfemoral</documentation> </annotation> </enumeration> <enumeration value="0351006"> <annotation> <documentation>ja, zu transaxillär</documentation> </annotation> </enumeration> <enumeration value="0351007"> <annotation> <documentation>ja, zu anderem endovaskulären Zugang</documentation> </annotation> </enumeration> <enumeration value="0351042"> <annotation> <documentation>ja, zu anderem Zugang</documentation> </annotation> </enumeration> </restriction> </simpleType> </pre>
--	---

simpleType enum_0352

namespace	http://xml.ir-d.de/stn		
type	restriction of string		
properties	base xs:string		
facets	Kind	Value	Annotation
	enumeration	0352001	documentation nein
	enumeration	0352002	documentation ja, Intubationsnarkose
	enumeration	0352003	documentation ja, Maskenbeatmung, incl. LAMA
	enumeration	0352042	documentation ja, unbekannt welche
annotation	documentation Kat_AK_Anaesthesie		
source	<pre> <simpleType name="enum_0352"> <annotation> <documentation>Kat_AK_Anaesthesie</documentation> </annotation> <restriction base="xs:string"> <enumeration value="0352001"> <annotation> <documentation>nein</documentation> </annotation> </enumeration> <enumeration value="0352002"> </pre>		

	<pre> <annotation> <documentation>ja, Intubationsnarkose</documentation> </annotation> </enumeration> <enumeration value="0352003"> <annotation> <documentation>ja, Maskenbeatmung, incl. LAMA</documentation> </annotation> </enumeration> <enumeration value="0352042"> <annotation> <documentation>ja, unbekannt welche</documentation> </annotation> </enumeration> </restriction> </simpleType> </pre>
--	---

simpleType enum 0353

namespace	http://xml.ir-d.de/stn		
type	restriction of string		
properties	base xs:string		
facets	Kind	Value	Annotation
	enumeration	0353001	documentation keine
	enumeration	0353002	documentation leichtgradig
	enumeration	0353003	documentation mittelgradig
	enumeration	0353004	documentation hochgradig
	enumeration	0353099	documentation nicht bestimmbar
annotation	documentation Kat_AK_ResidualeArteninsuffizienz		
source	<pre> <simpleType name="enum_0353"> <annotation> <documentation>Kat_AK_ResidualeArteninsuffizienz</documentation> </annotation> <restriction base="xs:string"> <enumeration value="0353001"> <annotation> <documentation>keine</documentation> </annotation> </enumeration> <enumeration value="0353002"> <annotation> <documentation>leichtgradig</documentation> </annotation> </enumeration> <enumeration value="0353003"> <annotation> <documentation>mittelgradig</documentation> </annotation> </enumeration> <enumeration value="0353004"> <annotation> </pre>		

	<pre> <documentation>hochgradig</documentation> </annotation> </enumeration> <enumeration value="0353099"> <annotation> <documentation>nicht bestimmbar</documentation> </annotation> </enumeration> </restriction> </simpleType> </pre>
--	--

simpleType enum_0354

namespace	http://xml.ir-d.de/stn		
type	restriction of string		
properties	base xs:string		
facets	Kind	Value	Annotation
	enumeration	0354001	documentation chirurgisch-offen
	enumeration	0354002	documentation Verschluss-System
	enumeration	0354042	documentation sonstiger
annotation	documentation Kat_AK_Zugangswegverschluss		
source	<pre> <simpleType name="enum_0354"> <annotation> <documentation>Kat_AK_Zugangswegverschluss</documentation> </annotation> <restriction base="xs:string"> <enumeration value="0354001"> <annotation> <documentation>chirurgisch-offen</documentation> </annotation> </enumeration> <enumeration value="0354002"> <annotation> <documentation>Verschluss-System</documentation> </annotation> </enumeration> <enumeration value="0354042"> <annotation> <documentation>sonstiger</documentation> </annotation> </enumeration> </restriction> </simpleType> </pre>		

simpleType enum_0357

namespace	http://xml.ir-d.de/stn		
type	restriction of string		
properties	base xs:string		

facets	<table border="1"> <thead> <tr> <th>Kind</th> <th>Value</th> <th>Annotation</th> </tr> </thead> <tbody> <tr> <td>enumeration</td> <td>0357001</td> <td>documentation keine KHK</td> </tr> <tr> <td>enumeration</td> <td>0357002</td> <td>documentation 1-Gefäßerkrankung</td> </tr> <tr> <td>enumeration</td> <td>0357003</td> <td>documentation 2-Gefäßerkrankung</td> </tr> <tr> <td>enumeration</td> <td>0357004</td> <td>documentation 3-Gefäßerkrankung</td> </tr> <tr> <td>enumeration</td> <td>0357005</td> <td>documentation keine koronare Bildgebung</td> </tr> </tbody> </table>	Kind	Value	Annotation	enumeration	0357001	documentation keine KHK	enumeration	0357002	documentation 1-Gefäßerkrankung	enumeration	0357003	documentation 2-Gefäßerkrankung	enumeration	0357004	documentation 3-Gefäßerkrankung	enumeration	0357005	documentation keine koronare Bildgebung
Kind	Value	Annotation																	
enumeration	0357001	documentation keine KHK																	
enumeration	0357002	documentation 1-Gefäßerkrankung																	
enumeration	0357003	documentation 2-Gefäßerkrankung																	
enumeration	0357004	documentation 3-Gefäßerkrankung																	
enumeration	0357005	documentation keine koronare Bildgebung																	
annotation	documentation Kat AK BefundBildgebung																		
source	<pre> <simpleType name="enum_0357"> <annotation> <documentation>Kat_AK_BefundBildgebung</documentation> </annotation> <restriction base="xs:string"> <enumeration value="0357001"> <annotation> <documentation>keine KHK</documentation> </annotation> </enumeration> <enumeration value="0357002"> <annotation> <documentation>1-Gefäßerkrankung</documentation> </annotation> </enumeration> <enumeration value="0357003"> <annotation> <documentation>2-Gefäßerkrankung</documentation> </annotation> </enumeration> <enumeration value="0357004"> <annotation> <documentation>3-Gefäßerkrankung</documentation> </annotation> </enumeration> <enumeration value="0357005"> <annotation> <documentation>keine koronare Bildgebung</documentation> </annotation> </enumeration> </restriction> </simpleType> </pre>																		

simpleType enum_0358

namespace	http://xml.ir-d.de/stn												
type	restriction of string												
properties	base xs:string												
facets	<table border="1"> <thead> <tr> <th>Kind</th> <th>Value</th> <th>Annotation</th> </tr> </thead> <tbody> <tr> <td>enumeration</td> <td>0358001</td> <td>documentation 0</td> </tr> <tr> <td>enumeration</td> <td>0358002</td> <td>documentation 1</td> </tr> <tr> <td>enumeration</td> <td>0358003</td> <td>documentation 2</td> </tr> </tbody> </table>	Kind	Value	Annotation	enumeration	0358001	documentation 0	enumeration	0358002	documentation 1	enumeration	0358003	documentation 2
Kind	Value	Annotation											
enumeration	0358001	documentation 0											
enumeration	0358002	documentation 1											
enumeration	0358003	documentation 2											

	<p>enumeration 0358004 documentation 3</p> <p>enumeration 0358005 documentation 4</p> <p>enumeration 0358006 documentation 5 oder mehr</p> <p>enumeration 0358098 documentation genaue Anzahl unbekannt (aber mind. 1)</p> <p>enumeration 0358099 documentation unbekannt</p>
annotation	documentation Kat_AK_AnzahlVorOP
source	<pre> <simpleType name="enum_0358"> <annotation> <documentation>Kat_AK_AnzahlVorOP</documentation> </annotation> <restriction base="xs:string"> <enumeration value="0358001"> <annotation> <documentation>0</documentation> </annotation> </enumeration> <enumeration value="0358002"> <annotation> <documentation>1</documentation> </annotation> </enumeration> <enumeration value="0358003"> <annotation> <documentation>2</documentation> </annotation> </enumeration> <enumeration value="0358004"> <annotation> <documentation>3</documentation> </annotation> </enumeration> <enumeration value="0358005"> <annotation> <documentation>4</documentation> </annotation> </enumeration> <enumeration value="0358006"> <annotation> <documentation>5 oder mehr</documentation> </annotation> </enumeration> <enumeration value="0358098"> <annotation> <documentation>genaue Anzahl unbekannt (aber mind. 1)</documentation> </annotation> </enumeration> <enumeration value="0358099"> <annotation> <documentation>unbekannt</documentation> </annotation> </enumeration> </restriction> </simpleType> </pre>

simpleType enum 0359

namespace	http://xml.ir-d.de/stn		
type	restriction of string		
properties	base xs:string		
facets	Kind	Value	Annotation
	enumeration	0359001	documentation nein
	enumeration	0359002	documentation ja - einseitig
	enumeration	0359003	documentation ja - beidseitig
	enumeration	0359042	documentation unbekannt
annotation	documentation Kat AK LVOT		
source	<pre> <simpleType name="enum_0359"> <annotation> <documentation>Kat_AK_LVOT</documentation> </annotation> <restriction base="xs:string"> <enumeration value="0359001"> <annotation> <documentation>nein</documentation> </annotation> </enumeration> <enumeration value="0359002"> <annotation> <documentation>ja - einseitig</documentation> </annotation> </enumeration> <enumeration value="0359003"> <annotation> <documentation>ja - beidseitig</documentation> </annotation> </enumeration> <enumeration value="0359042"> <annotation> <documentation>unbekannt</documentation> </annotation> </enumeration> </restriction> </simpleType> </pre>		

simpleType enum 0360

namespace	http://xml.ir-d.de/stn		
type	restriction of string		
properties	base xs:string		
facets	Kind	Value	Annotation
	enumeration	0360001	documentation keine
	enumeration	0360002	documentation leichtgradig

	enumeration 0360003 documentation mittelgradig enumeration 0360004 documentation hochgradig enumeration 0360005 documentation massive enumeration 0360006 documentation torrential enumeration 0360099 documentation unbekannt
annotation	documentation Kat_AK_TriskupidallInsuffizienz
source	<pre> <simpleType name="enum_0360"> <annotation> <documentation>Kat_AK_TriskupidallInsuffizienz</documentation> </annotation> <restriction base="xs:string"> <enumeration value="0360001"> <annotation> <documentation>keine</documentation> </annotation> </enumeration> <enumeration value="0360002"> <annotation> <documentation>leichtgradig</documentation> </annotation> </enumeration> <enumeration value="0360003"> <annotation> <documentation>mittelgradig</documentation> </annotation> </enumeration> <enumeration value="0360004"> <annotation> <documentation>hochgradig</documentation> </annotation> </enumeration> <enumeration value="0360005"> <annotation> <documentation>massive</documentation> </annotation> </enumeration> <enumeration value="0360006"> <annotation> <documentation>torrential</documentation> </annotation> </enumeration> <enumeration value="0360099"> <annotation> <documentation>unbekannt</documentation> </annotation> </enumeration> </restriction> </simpleType> </pre>

simpleType enum_0361

namespace	http://xml.ir-d.de/stn
-----------	------------------------

type	restriction of string		
properties	base xs:string		
facets	Kind	Value	Annotation
	enumeration	0361001	documentation nein
	enumeration	0361002	documentation ja, letzte(r) innerhalb der letzten 48 Stunden
	enumeration	0361003	documentation ja, letzte(r) innerhalb der letzten 21 Tage
	enumeration	0361004	documentation ja, letzte(r) länger als 21 Tage
	enumeration	0361098	documentation ja, letzter Zeitpunkt unbekannt
	enumeration	0361099	documentation unbekannt
annotation	documentation Kat AK SchockReanimation		
source	<pre> <simpleType name="enum_0361"> <annotation> <documentation>Kat_AK_SchockReanimation</documentation> </annotation> <restriction base="xs:string"> <enumeration value="0361001"> <annotation> <documentation>nein</documentation> </annotation> </enumeration> <enumeration value="0361002"> <annotation> <documentation>ja, letzte(r) innerhalb der letzten 48 Stunden</documentation> </annotation> </enumeration> <enumeration value="0361003"> <annotation> <documentation>ja, letzte(r) innerhalb der letzten 21 Tage</documentation> </annotation> </enumeration> <enumeration value="0361004"> <annotation> <documentation>ja, letzte(r) länger als 21 Tage</documentation> </annotation> </enumeration> <enumeration value="0361098"> <annotation> <documentation>ja, letzter Zeitpunkt unbekannt</documentation> </annotation> </enumeration> <enumeration value="0361099"> <annotation> <documentation>unbekannt</documentation> </annotation> </enumeration> </restriction> </simpleType> </pre>		

simpleType enum_0362

namespace	http://xml.ir-d.de/stn		
type	restriction of string		
properties	base xs:string		
facets	Kind	Value	Annotation
	enumeration	0362001	documentation Sinusrhythmus
	enumeration	0362002	documentation Vorhofflimmern
	enumeration	0362042	documentation anderer Herzrhythmus
annotation	documentation Kat_AK_Herzrhythmus		
source	<pre> <simpleType name="enum_0362"> <annotation> <documentation>Kat_AK_Herzrhythmus</documentation> </annotation> <restriction base="xs:string"> <enumeration value="0362001"> <annotation> <documentation>Sinusrhythmus</documentation> </annotation> </enumeration> <enumeration value="0362002"> <annotation> <documentation>Vorhofflimmern</documentation> </annotation> </enumeration> <enumeration value="0362042"> <annotation> <documentation>anderer Herzrhythmus</documentation> </annotation> </enumeration> </restriction> </simpleType> </pre>		

simpleType enum_0363

namespace	http://xml.ir-d.de/stn		
type	restriction of string		
properties	base xs:string		
facets	Kind	Value	Annotation
	enumeration	0363001	documentation nein
	enumeration	0363002	documentation paroxysmal
	enumeration	0363003	documentation persistierend
	enumeration	0363004	documentation permanent
annotation	documentation Kat_AK_Vorhofflimmern		
source	<pre> <simpleType name="enum_0363"> <annotation> <documentation>Kat AK Vorhofflimmern</documentation> </annotation> </pre>		

	<pre> </annotation> <restriction base="xs:string"> <enumeration value="0363001"> <annotation> <documentation>nein</documentation> </annotation> </enumeration> <enumeration value="0363002"> <annotation> <documentation>paroxysmal</documentation> </annotation> </enumeration> <enumeration value="0363003"> <annotation> <documentation>persistierend</documentation> </annotation> </enumeration> <enumeration value="0363004"> <annotation> <documentation>permanent</documentation> </annotation> </enumeration> </restriction> </simpleType> </pre>
--	--

simpleType enum_0364

namespace	http://xml.ir-d.de/stn		
type	restriction of string		
properties	base xs:string		
facets	Kind	Value	Annotation
	enumeration	0364001	documentation nein
	enumeration	0364002	documentation Schrittmacher ohne CRT-System
	enumeration	0364003	documentation Schrittmacher mit CRT-System
	enumeration	0364004	documentation Defibrillator ohne CRT-System
	enumeration	0364005	documentation Defibrillator mit CRT-System
annotation	documentation Kat_AK_SchrittmacherDefi		
source	<pre> <simpleType name="enum_0364"> <annotation> <documentation>Kat_AK_SchrittmacherDefi</documentation> </annotation> <restriction base="xs:string"> <enumeration value="0364001"> <annotation> <documentation>nein</documentation> </annotation> </enumeration> <enumeration value="0364002"> <annotation> <documentation>Schrittmacher ohne CRT-System</documentation> </annotation> </enumeration> </restriction> </simpleType> </pre>		

	<pre> </enumeration> <enumeration value="0364003"> <annotation> <documentation>Schrittmacher mit CRT-System</documentation> </annotation> </enumeration> <enumeration value="0364004"> <annotation> <documentation>Defibrillator ohne CRT-System</documentation> </annotation> </enumeration> <enumeration value="0364005"> <annotation> <documentation>Defibrillator mit CRT-System</documentation> </annotation> </enumeration> </restriction> </simpleType> </pre>
--	---

simpleType enum_0365

namespace	http://xml.ir-d.de/stn		
type	restriction of string		
properties	base xs:string		
facets	Kind	Value	Annotation
	enumeration	0365001	documentation nein
	enumeration	0365002	documentation ja, operativ
	enumeration	0365003	documentation ja, interventionell
annotation	documentation Kat AK MyokardRevaskularisation		
source	<pre> <simpleType name="enum_0365"> <annotation> <documentation>Kat_AK_MyokardRevaskularisation</documentation> </annotation> <restriction base="xs:string"> <enumeration value="0365001"> <annotation> <documentation>nein</documentation> </annotation> </enumeration> <enumeration value="0365002"> <annotation> <documentation>ja, operativ</documentation> </annotation> </enumeration> <enumeration value="0365003"> <annotation> <documentation>ja, interventionell</documentation> </annotation> </enumeration> </restriction> </simpleType> </pre>		

simpleType enum_0366

namespace	http://xml.ir-d.de/stn		
type	restriction of string		
properties	base xs:string		
facets	Kind	Value	Annotation
	enumeration	0366001	documentation nein
	enumeration	0366002	documentation ja, <= 6 Stunden
	enumeration	0366003	documentation ja, > 6 Stunden bis <= 3 Monate
	enumeration	0366004	documentation ja, > 3 Monate
	enumeration	0366099	documentation unbekannt
annotation	documentation Kat_AK_PCI		
source	<pre> <simpleType name="enum_0366"> <annotation> <documentation>Kat_AK_PCI</documentation> </annotation> <restriction base="xs:string"> <enumeration value="0366001"> <annotation> <documentation>nein</documentation> </annotation> </enumeration> <enumeration value="0366002"> <annotation> <documentation>ja, &lt;= 6 Stunden</documentation> </annotation> </enumeration> <enumeration value="0366003"> <annotation> <documentation>ja, &gt; 6 Stunden bis &lt;= 3 Monate</documentation> </annotation> </enumeration> <enumeration value="0366004"> <annotation> <documentation>ja, &gt; 3 Monate</documentation> </annotation> </enumeration> <enumeration value="0366099"> <annotation> <documentation>unbekannt</documentation> </annotation> </enumeration> </restriction> </simpleType> </pre>		

simpleType enum_0367

namespace	http://xml.ir-d.de/stn
type	restriction of string

properties	base xs:string																																																			
facets	<table border="1"> <thead> <tr> <th>Kind</th> <th>Value</th> <th>Annotation</th> </tr> </thead> <tbody> <tr> <td>enumeration</td> <td>0367001</td> <td>documentation keine</td> </tr> <tr> <td>enumeration</td> <td>0367002</td> <td>documentation Mediastinitis</td> </tr> <tr> <td>enumeration</td> <td>0367003</td> <td>documentation Sepsis</td> </tr> <tr> <td>enumeration</td> <td>0367004</td> <td>documentation broncho-pulmonale Infektion</td> </tr> <tr> <td>enumeration</td> <td>0367005</td> <td>documentation oto-laryngologische Infektion</td> </tr> <tr> <td>enumeration</td> <td>0367006</td> <td>documentation floride Endokarditis</td> </tr> <tr> <td>enumeration</td> <td>0367007</td> <td>documentation Peritonitis</td> </tr> <tr> <td>enumeration</td> <td>0367008</td> <td>documentation Wundinfektion Thorax</td> </tr> <tr> <td>enumeration</td> <td>0367009</td> <td>documentation Pleuraempyem</td> </tr> <tr> <td>enumeration</td> <td>0367010</td> <td>documentation Venenkatheterinfektion</td> </tr> <tr> <td>enumeration</td> <td>0367011</td> <td>documentation Harnwegsinfektion</td> </tr> <tr> <td>enumeration</td> <td>0367012</td> <td>documentation Wundinfektion untere Extremitäten</td> </tr> <tr> <td>enumeration</td> <td>0367013</td> <td>documentation HIV-Infektion</td> </tr> <tr> <td>enumeration</td> <td>0367014</td> <td>documentation Hepatitis B oder C</td> </tr> <tr> <td>enumeration</td> <td>0367015</td> <td>documentation andere Wundinfektion</td> </tr> <tr> <td>enumeration</td> <td>0367042</td> <td>documentation sonstige</td> </tr> </tbody> </table>	Kind	Value	Annotation	enumeration	0367001	documentation keine	enumeration	0367002	documentation Mediastinitis	enumeration	0367003	documentation Sepsis	enumeration	0367004	documentation broncho-pulmonale Infektion	enumeration	0367005	documentation oto-laryngologische Infektion	enumeration	0367006	documentation floride Endokarditis	enumeration	0367007	documentation Peritonitis	enumeration	0367008	documentation Wundinfektion Thorax	enumeration	0367009	documentation Pleuraempyem	enumeration	0367010	documentation Venenkatheterinfektion	enumeration	0367011	documentation Harnwegsinfektion	enumeration	0367012	documentation Wundinfektion untere Extremitäten	enumeration	0367013	documentation HIV-Infektion	enumeration	0367014	documentation Hepatitis B oder C	enumeration	0367015	documentation andere Wundinfektion	enumeration	0367042	documentation sonstige
Kind	Value	Annotation																																																		
enumeration	0367001	documentation keine																																																		
enumeration	0367002	documentation Mediastinitis																																																		
enumeration	0367003	documentation Sepsis																																																		
enumeration	0367004	documentation broncho-pulmonale Infektion																																																		
enumeration	0367005	documentation oto-laryngologische Infektion																																																		
enumeration	0367006	documentation floride Endokarditis																																																		
enumeration	0367007	documentation Peritonitis																																																		
enumeration	0367008	documentation Wundinfektion Thorax																																																		
enumeration	0367009	documentation Pleuraempyem																																																		
enumeration	0367010	documentation Venenkatheterinfektion																																																		
enumeration	0367011	documentation Harnwegsinfektion																																																		
enumeration	0367012	documentation Wundinfektion untere Extremitäten																																																		
enumeration	0367013	documentation HIV-Infektion																																																		
enumeration	0367014	documentation Hepatitis B oder C																																																		
enumeration	0367015	documentation andere Wundinfektion																																																		
enumeration	0367042	documentation sonstige																																																		
annotation	documentation Kat_AK_Infektion																																																			
source	<pre> <simpleType name="enum_0367"> <annotation> <documentation>Kat_AK_Infektion</documentation> </annotation> <restriction base="xs:string"> <enumeration value="0367001"> <annotation> <documentation>keine</documentation> </annotation> </enumeration> <enumeration value="0367002"> <annotation> <documentation>Mediastinitis</documentation> </annotation> </enumeration> <enumeration value="0367003"> <annotation> <documentation>Sepsis</documentation> </annotation> </enumeration> <enumeration value="0367004"> <annotation> <documentation>broncho-pulmonale Infektion</documentation> </annotation> </enumeration> </restriction> </simpleType> </pre>																																																			

```
<enumeration value="0367005">
  <annotation>
    <documentation>oto-laryngologische Infektion</documentation>
  </annotation>
</enumeration>
<enumeration value="0367006">
  <annotation>
    <documentation>floride Endokarditis</documentation>
  </annotation>
</enumeration>
<enumeration value="0367007">
  <annotation>
    <documentation>Peritonitis</documentation>
  </annotation>
</enumeration>
<enumeration value="0367008">
  <annotation>
    <documentation>Wundinfektion Thorax</documentation>
  </annotation>
</enumeration>
<enumeration value="0367009">
  <annotation>
    <documentation>Pleuraempyem</documentation>
  </annotation>
</enumeration>
<enumeration value="0367010">
  <annotation>
    <documentation>Venenkatheterinfektion</documentation>
  </annotation>
</enumeration>
<enumeration value="0367011">
  <annotation>
    <documentation>Harnwegsinfektion</documentation>
  </annotation>
</enumeration>
<enumeration value="0367012">
  <annotation>
    <documentation>Wundinfektion untere Extremitäten</documentation>
  </annotation>
</enumeration>
<enumeration value="0367013">
  <annotation>
    <documentation>HIV-Infektion</documentation>
  </annotation>
</enumeration>
<enumeration value="0367014">
  <annotation>
    <documentation>Hepatitis B oder C</documentation>
  </annotation>
</enumeration>
<enumeration value="0367015">
  <annotation>
    <documentation>andere Wundinfektion</documentation>
  </annotation>
</enumeration>
<enumeration value="0367042">
  <annotation>
    <documentation>sonstige</documentation>
  </annotation>
</enumeration>
```

```

</enumeration>
</restriction>
</simpleType>

```

simpleType enum_0368

namespace	http://xml.ir-d.de/stn		
type	restriction of string		
properties	base xs:string		
facets	Kind	Value	Annotation
	enumeration	0368001	documentation nein
	enumeration	0368002	documentation ja, COPD mit Dauermedikation
	enumeration	0368003	documentation ja, COPD ohne Dauermedikation
	enumeration	0368004	documentation ja, andere Lungenerkrankungen
	enumeration	0368099	documentation unbekannt
annotation	documentation Kat_AK_Lungenerkrankung		
source	<pre> <simpleType name="enum_0368"> <annotation> <documentation>Kat_AK_Lungenerkrankung</documentation> </annotation> <restriction base="xs:string"> <enumeration value="0368001"> <annotation> <documentation>nein</documentation> </annotation> </enumeration> <enumeration value="0368002"> <annotation> <documentation>ja, COPD mit Dauermedikation</documentation> </annotation> </enumeration> <enumeration value="0368003"> <annotation> <documentation>ja, COPD ohne Dauermedikation</documentation> </annotation> </enumeration> <enumeration value="0368004"> <annotation> <documentation>ja, andere Lungenerkrankungen</documentation> </annotation> </enumeration> <enumeration value="0368099"> <annotation> <documentation>unbekannt</documentation> </annotation> </enumeration> </restriction> </simpleType> </pre>		

simpleType enum_0369

namespace	http://xml.ir-d.de/stn		
type	restriction of string		
properties	base xs:string		
facets	Kind	Value	Annotation
	enumeration	0369001	documentation nein
	enumeration	0369002	documentation akut
	enumeration	0369003	documentation chronisch
annotation	documentation Kat_AK_Nierenersatztherapie		
source	<pre> <simpleType name="enum_0369"> <annotation> <documentation>Kat_AK_Nierenersatztherapie</documentation> </annotation> <restriction base="xs:string"> <enumeration value="0369001"> <annotation> <documentation>nein</documentation> </annotation> </enumeration> <enumeration value="0369002"> <annotation> <documentation>akut</documentation> </annotation> </enumeration> <enumeration value="0369003"> <annotation> <documentation>chronisch</documentation> </annotation> </enumeration> </restriction> </simpleType> </pre>		

simpleType enum_0370

namespace	http://xml.ir-d.de/stn		
type	restriction of string		
properties	base xs:string		
facets	Kind	Value	Annotation
	enumeration	0370001	documentation Echokardiographie
	enumeration	0370002	documentation Herzkatheter
	enumeration	0370042	documentation andere
annotation	documentation Kat_AK_AKOEFMessmethode		
source	<pre> <simpleType name="enum_0370"> <annotation> <documentation>Kat_AK_AKOEFMessmethode</documentation> </annotation> <restriction base="xs:string"> </pre>		

	<pre> <enumeration value="0370001"> <annotation> <documentation>Echokardiographie</documentation> </annotation> </enumeration> <enumeration value="0370002"> <annotation> <documentation>Herzkatheter</documentation> </annotation> </enumeration> <enumeration value="0370042"> <annotation> <documentation>andere</documentation> </annotation> </enumeration> </restriction> </simpleType> </pre>
--	--

simpleType enum 0371

namespace	http://xml.ir-d.de/stn		
type	restriction of string		
properties	base xs:string		
facets	Kind	Value	Annotation
	enumeration	0371001	documentation keine
	enumeration	0371002	documentation leicht
	enumeration	0371003	documentation mittel
	enumeration	0371004	documentation schwer
	enumeration	0371099	documentation unbekannt
annotation	documentation Kat_AK_Verkalkungsgrad		
source	<pre> <simpleType name="enum_0371"> <annotation> <documentation>Kat_AK_Verkalkungsgrad</documentation> </annotation> <restriction base="xs:string"> <enumeration value="0371001"> <annotation> <documentation>keine</documentation> </annotation> </enumeration> <enumeration value="0371002"> <annotation> <documentation>leicht</documentation> </annotation> </enumeration> <enumeration value="0371003"> <annotation> <documentation>mittel</documentation> </annotation> </enumeration> <enumeration value="0371004"> </pre>		

	<pre> <annotation> <documentation>schwer</documentation> </annotation> </enumeration> <enumeration value="0371099"> <annotation> <documentation>unbekannt</documentation> </annotation> </enumeration> </restriction> </simpleType> </pre>
--	--

simpleType enum_0372

namespace	http://xml.ir-d.de/stn		
type	restriction of string		
properties	base xs:string		
facets	Kind	Value	Annotation
	enumeration	0372001	documentation nein
	enumeration	0372002	documentation ja, bicuspide
	enumeration	0372003	documentation ja, unicuspide
	enumeration	0372099	documentation unbekannt
annotation	documentation Kat_AK_BiUnicuspideKlappe		
source	<pre> <simpleType name="enum_0372"> <annotation> <documentation>Kat_AK_BiUnicuspideKlappe</documentation> </annotation> <restriction base="xs:string"> <enumeration value="0372001"> <annotation> <documentation>nein</documentation> </annotation> </enumeration> <enumeration value="0372002"> <annotation> <documentation>ja, bicuspide</documentation> </annotation> </enumeration> <enumeration value="0372003"> <annotation> <documentation>ja, unicuspide</documentation> </annotation> </enumeration> <enumeration value="0372099"> <annotation> <documentation>unbekannt</documentation> </annotation> </enumeration> </restriction> </simpleType> </pre>		

simpleType enum_0373

namespace	http://xml.ir-d.de/stn		
type	restriction of string		
properties	base xs:string		
facets	Kind	Value	Annotation
	enumeration	0373001	documentation keine
	enumeration	0373002	documentation leichtgradig
	enumeration	0373003	documentation mittelgradig
	enumeration	0373004	documentation hochgradig
	enumeration	0373099	documentation unbekannt
annotation	documentation Kat_AK_Grad		
source	<pre> <simpleType name="enum_0373"> <annotation> <documentation>Kat_AK_Grad</documentation> </annotation> <restriction base="xs:string"> <enumeration value="0373001"> <annotation> <documentation>keine</documentation> </annotation> </enumeration> <enumeration value="0373002"> <annotation> <documentation>leichtgradig</documentation> </annotation> </enumeration> <enumeration value="0373003"> <annotation> <documentation>mittelgradig</documentation> </annotation> </enumeration> <enumeration value="0373004"> <annotation> <documentation>hochgradig</documentation> </annotation> </enumeration> <enumeration value="0373099"> <annotation> <documentation>unbekannt</documentation> </annotation> </enumeration> </restriction> </simpleType> </pre>		

simpleType enum_0374

namespace	http://xml.ir-d.de/stn
type	restriction of string

properties	base xs:string																								
facets	<table border="1"> <thead> <tr> <th>Kind</th> <th>Value</th> <th>Annotation</th> </tr> </thead> <tbody> <tr> <td>enumeration</td> <td>0374001</td> <td>documentation nein</td> </tr> <tr> <td>enumeration</td> <td>0374002</td> <td>documentation ja, &lt;= 6 Stunden</td> </tr> <tr> <td>enumeration</td> <td>0374003</td> <td>documentation ja, &gt; 6 Stunden bis &lt;= 24 Stunden</td> </tr> <tr> <td>enumeration</td> <td>0374004</td> <td>documentation ja, &gt; 1 bis 7 Tage</td> </tr> <tr> <td>enumeration</td> <td>0374005</td> <td>documentation ja, &gt; 7 bis 21 Tage</td> </tr> <tr> <td>enumeration</td> <td>0374006</td> <td>documentation ja, &gt; 21 Tage</td> </tr> <tr> <td>enumeration</td> <td>0374099</td> <td>documentation unbekannt</td> </tr> </tbody> </table>	Kind	Value	Annotation	enumeration	0374001	documentation nein	enumeration	0374002	documentation ja, <= 6 Stunden	enumeration	0374003	documentation ja, > 6 Stunden bis <= 24 Stunden	enumeration	0374004	documentation ja, > 1 bis 7 Tage	enumeration	0374005	documentation ja, > 7 bis 21 Tage	enumeration	0374006	documentation ja, > 21 Tage	enumeration	0374099	documentation unbekannt
Kind	Value	Annotation																							
enumeration	0374001	documentation nein																							
enumeration	0374002	documentation ja, <= 6 Stunden																							
enumeration	0374003	documentation ja, > 6 Stunden bis <= 24 Stunden																							
enumeration	0374004	documentation ja, > 1 bis 7 Tage																							
enumeration	0374005	documentation ja, > 7 bis 21 Tage																							
enumeration	0374006	documentation ja, > 21 Tage																							
enumeration	0374099	documentation unbekannt																							
annotation	documentation Kat_AK_InfarktAnamnese																								
source	<pre> <simpleType name="enum_0374"> <annotation> <documentation>Kat_AK_InfarktAnamnese</documentation> </annotation> <restriction base="xs:string"> <enumeration value="0374001"> <annotation> <documentation>nein</documentation> </annotation> </enumeration> <enumeration value="0374002"> <annotation> <documentation>ja, &lt;= 6 Stunden</documentation> </annotation> </enumeration> <enumeration value="0374003"> <annotation> <documentation>ja, &gt; 6 Stunden bis &lt;= 24 Stunden</documentation> </annotation> </enumeration> <enumeration value="0374004"> <annotation> <documentation>ja, &gt; 1 bis 7 Tage</documentation> </annotation> </enumeration> <enumeration value="0374005"> <annotation> <documentation>ja, &gt; 7 bis 21 Tage</documentation> </annotation> </enumeration> <enumeration value="0374006"> <annotation> <documentation>ja, &gt; 21 Tage</documentation> </annotation> </enumeration> <enumeration value="0374099"> <annotation> <documentation>unbekannt</documentation> </annotation> </enumeration> </restriction> </pre>																								

	<code></simpleType></code>
--	----------------------------------

simpleType enum_0375

namespace	http://xml.ir-d.de/stn																								
type	restriction of string																								
properties	base xs:string																								
facets	<table><thead><tr><th>Kind</th><th>Value</th><th>Annotation</th></tr></thead><tbody><tr><td>enumeration</td><td>0375001</td><td>documentation keine Symptome oder Angina</td></tr><tr><td>enumeration</td><td>0375002</td><td>documentation Symptome, aber keine Ischämiezeichen</td></tr><tr><td>enumeration</td><td>0375003</td><td>documentation stabile Angina</td></tr><tr><td>enumeration</td><td>0375004</td><td>documentation instabile Angina</td></tr><tr><td>enumeration</td><td>0375005</td><td>documentation Infarkt ohne ST-Hebung (Non-STEMI)</td></tr><tr><td>enumeration</td><td>0375006</td><td>documentation Infarkt mit ST-Hebung (STEMI)</td></tr><tr><td>enumeration</td><td>0375042</td><td>documentation unbekannt</td></tr></tbody></table>	Kind	Value	Annotation	enumeration	0375001	documentation keine Symptome oder Angina	enumeration	0375002	documentation Symptome, aber keine Ischämiezeichen	enumeration	0375003	documentation stabile Angina	enumeration	0375004	documentation instabile Angina	enumeration	0375005	documentation Infarkt ohne ST-Hebung (Non-STEMI)	enumeration	0375006	documentation Infarkt mit ST-Hebung (STEMI)	enumeration	0375042	documentation unbekannt
Kind	Value	Annotation																							
enumeration	0375001	documentation keine Symptome oder Angina																							
enumeration	0375002	documentation Symptome, aber keine Ischämiezeichen																							
enumeration	0375003	documentation stabile Angina																							
enumeration	0375004	documentation instabile Angina																							
enumeration	0375005	documentation Infarkt ohne ST-Hebung (Non-STEMI)																							
enumeration	0375006	documentation Infarkt mit ST-Hebung (STEMI)																							
enumeration	0375042	documentation unbekannt																							
annotation	documentation Kat_AK_KardialeSymptome																								
source	<pre><simpleType name="enum_0375"> <annotation> <documentation>Kat_AK_KardialeSymptome</documentation> </annotation> <restriction base="xs:string"> <enumeration value="0375001"> <annotation> <documentation>keine Symptome oder Angina</documentation> </annotation> </enumeration> <enumeration value="0375002"> <annotation> <documentation>Symptome, aber keine Ischämiezeichen</documentation> </annotation> </enumeration> <enumeration value="0375003"> <annotation> <documentation>stabile Angina</documentation> </annotation> </enumeration> <enumeration value="0375004"> <annotation> <documentation>instabile Angina</documentation> </annotation> </enumeration> <enumeration value="0375005"> <annotation> <documentation>Infarkt ohne ST-Hebung (Non-STEMI)</documentation> </annotation> </enumeration> <enumeration value="0375006"> <annotation> <documentation>Infarkt mit ST-Hebung (STEMI)</documentation> </annotation> </enumeration> </restriction> </simpleType></pre>																								

	<pre> </annotation> </enumeration> <enumeration value="0375042"> <annotation> <documentation>unbekannt</documentation> </annotation> </enumeration> </restriction> </simpleType> </pre>
--	---

simpleType enum_0376

namespace	http://xml.ir-d.de/strn		
type	restriction of string		
properties	base xs:string		
facets	Kind	Value	Annotation
	enumeration	0376001	documentation nein
	enumeration	0376002	documentation ja, ZNS, zerebrovaskuläre Blutung
	enumeration	0376003	documentation ja, ZNS, zerebrovaskuläre Ischämie
	enumeration	0376042	documentation ja, ZNS, andere
annotation	documentation Kat_AK_Schlaganfall		
source	<pre> <simpleType name="enum_0376"> <annotation> <documentation>Kat_AK_Schlaganfall</documentation> </annotation> <restriction base="xs:string"> <enumeration value="0376001"> <annotation> <documentation>nein</documentation> </annotation> </enumeration> <enumeration value="0376002"> <annotation> <documentation>ja, ZNS, zerebrovaskuläre Blutung</documentation> </annotation> </enumeration> <enumeration value="0376003"> <annotation> <documentation>ja, ZNS, zerebrovaskuläre Ischämie</documentation> </annotation> </enumeration> <enumeration value="0376042"> <annotation> <documentation>ja, ZNS, andere</documentation> </annotation> </enumeration> </restriction> </simpleType> </pre>		

simpleType enum_0377

namespace	http://xml.ir-d.de/stn		
type	restriction of string		
properties	base xs:string		
facets	Kind	Value	Annotation
	enumeration	0377001	documentation ja, mild neurological dysfunction: NIHSS 0-5
	enumeration	0377002	documentation ja, moderate neurological dysfunction: NIHSS 6-14
	enumeration	0377003	documentation ja, severe neurological dysfunction: NIHSS >=15
annotation	documentation Kat_AK_Nihss		
source	<pre> <simpleType name="enum_0377"> <annotation> <documentation>Kat_AK_Nihss</documentation> </annotation> <restriction base="xs:string"> <enumeration value="0377001"> <annotation> <documentation>ja, mild neurological dysfunction: NIHSS 0- 5</documentation> </annotation> </enumeration> <enumeration value="0377002"> <annotation> <documentation>ja, moderate neurological dysfunction: NIHSS 6- 14</documentation> </annotation> </enumeration> <enumeration value="0377003"> <annotation> <documentation>ja, severe neurological dysfunction: NIHSS &gt;=15</documentation> </annotation> </enumeration> </restriction> </simpleType> </pre>		

simpleType enum_0378

namespace	http://xml.ir-d.de/stn		
type	restriction of string		
properties	base xs:string		
facets	Kind	Value	Annotation
	enumeration	0378001	documentation nein
	enumeration	0378002	documentation ja, < 48h gemäss VARC-3-Definition
	enumeration	0378003	documentation ja, >= 48h - <= 72h gemäß VARC-3-Definition
	enumeration	0378004	documentation ja, > 72 h gemäß VARC-3 Definition
annotation	documentation Kat_AK_Myokardinfarkt		

source	<pre> <simpleType name="enum_0378"> <annotation> <documentation>Kat_AK_Myokardinfarkt</documentation> </annotation> <restriction base="xs:string"> <enumeration value="0378001"> <annotation> <documentation>nein</documentation> </annotation> </enumeration> <enumeration value="0378002"> <annotation> <documentation>ja, &lt; 48h gemäss VARC-3-Definition</documentation> </annotation> </enumeration> <enumeration value="0378003"> <annotation> <documentation>ja, &gt;= 48h - &lt;= 72h gemäß VARC-3- Definition</documentation> </annotation> </enumeration> <enumeration value="0378004"> <annotation> <documentation>ja, &gt; 72 h gemäß VARC-3 Definition</documentation> </annotation> </enumeration> </restriction> </simpleType> </pre>
--------	--

simpleType enum_0379

namespace	http://xml.ir-d.de/stn		
type	restriction of string		
properties	base xs:string		
facets	Kind	Value	Annotation
	enumeration	0379001	documentation Keine gefäss- oder zugangsassozierte Komplikationen
	enumeration	0379002	documentation Versagen des perkutanen Verschlusssystems
	enumeration	0379003	documentation Geringfügige Gefäßkomplikationen
	enumeration	0379004	documentation Erhebliche Gefäßkomplikationen
annotation	documentation Kat_AK_ZugangKomplikationen		
source	<pre> <simpleType name="enum_0379"> <annotation> <documentation>Kat_AK_ZugangKomplikationen</documentation> </annotation> <restriction base="xs:string"> <enumeration value="0379001"> <annotation> <documentation>Keine gefäss- oder zugangsassozierte Komplikationen</documentation> </annotation> </enumeration> <enumeration value="0379002"> </pre>		

	<pre> <annotation> <documentation>Versagen des perkutanen Verschlussystems</documentation> </annotation> </enumeration> <enumeration value="0379003"> <annotation> <documentation>Geringfügige Gefäßkomplikationen</documentation> </annotation> </enumeration> <enumeration value="0379004"> <annotation> <documentation>Erhebliche Gefäßkomplikationen</documentation> </annotation> </enumeration> </restriction> </simpleType> </pre>
--	---

simpleType enum_0380

namespace	http://xml.ir-d.de/stn		
type	restriction of string		
properties	base xs:string		
facets	Kind	Value	Annotation
	enumeration	0380001	documentation nein
	enumeration	0380002	documentation ja, intraprozedural
	enumeration	0380003	documentation ja, postprozedural
	enumeration	0380004	documentation ja, Zeitpunkt nicht bekannt
annotation	documentation Kat_AK_Reanimation		
source	<pre> <simpleType name="enum_0380"> <annotation> <documentation>Kat_AK_Reanimation</documentation> </annotation> <restriction base="xs:string"> <enumeration value="0380001"> <annotation> <documentation>nein</documentation> </annotation> </enumeration> <enumeration value="0380002"> <annotation> <documentation>ja, intraprozedural</documentation> </annotation> </enumeration> <enumeration value="0380003"> <annotation> <documentation>ja, postprozedural</documentation> </annotation> </enumeration> <enumeration value="0380004"> <annotation> <documentation>ja, Zeitpunkt nicht bekannt</documentation> </annotation> </enumeration> </restriction> </simpleType> </pre>		

```

</annotation>
</enumeration>
</restriction>
</simpleType>

```

simpleType enum_0381

namespace	http://xml.ir-d.de/stn		
type	restriction of string		
properties	base xs:string		
facets	Kind	Value	Annotation
	enumeration	0381001	documentation nein
	enumeration	0381002	documentation Thorakotomie/Rethorakotomie
	enumeration	0381003	documentation kathetergestützte Reintervention
	enumeration	0381004	documentation lokale Reinterventionen
	enumeration	0381005	documentation andere Reintervention
annotation	documentation Kat_AK_Massnahmen		
source	<pre> <simpleType name="enum_0381"> <annotation> <documentation>Kat_AK_Massnahmen</documentation> </annotation> <restriction base="xs:string"> <enumeration value="0381001"> <annotation> <documentation>nein</documentation> </annotation> </enumeration> <enumeration value="0381002"> <annotation> <documentation>Thorakotomie/Rethorakotomie</documentation> </annotation> </enumeration> <enumeration value="0381003"> <annotation> <documentation>kathetergestützte Reintervention</documentation> </annotation> </enumeration> <enumeration value="0381004"> <annotation> <documentation>lokale Reinterventionen</documentation> </annotation> </enumeration> <enumeration value="0381005"> <annotation> <documentation>andere Reintervention</documentation> </annotation> </enumeration> </restriction> </simpleType> </pre>		

simpleType enum_0382

namespace	http://xml.ir-d.de/stn		
type	restriction of string		
properties	base xs:string		
facets	Kind	Value	Annotation
	enumeration	0382001	documentation keine Rethorakotomie / kein weiterer Grund
	enumeration	0382002	documentation Blutung/Hämatom
	enumeration	0382003	documentation Low Cardiac Output
	enumeration	0382004	documentation Tamponade
	enumeration	0382005	documentation Graftprobleme, Ischämie
	enumeration	0382006	documentation Wundinfektion, Mediastinitis
	enumeration	0382007	documentation Dissektion
	enumeration	0382008	documentation Prothesendysfunktion
	enumeration	0382009	documentation instabiles Sternum
	enumeration	0382010	documentation Chylothorax
	enumeration	0382011	documentation lokale Revision im Bereich des Zugangsweges
	enumeration	0382042	documentation anderer Grund
annotation	documentation Kat_AK_Komplikation		
source	<pre> <simpleType name="enum_0382"> <annotation> <documentation>Kat_AK_Komplikation</documentation> </annotation> <restriction base="xs:string"> <enumeration value="0382001"> <annotation> <documentation>keine Rethorakotomie / kein weiterer Grund</documentation> </annotation> </enumeration> <enumeration value="0382002"> <annotation> <documentation>Blutung/Hämatom</documentation> </annotation> </enumeration> <enumeration value="0382003"> <annotation> <documentation>Low Cardiac Output</documentation> </annotation> </enumeration> <enumeration value="0382004"> <annotation> <documentation>Tamponade</documentation> </annotation> </enumeration> <enumeration value="0382005"> </pre>		

```

    <annotation>
      <documentation>Graftprobleme, Ischämie</documentation>
    </annotation>
  </enumeration>
  <enumeration value="0382006">
    <annotation>
      <documentation>Wundinfektion, Mediastinitis</documentation>
    </annotation>
  </enumeration>
  <enumeration value="0382007">
    <annotation>
      <documentation>Dissektion</documentation>
    </annotation>
  </enumeration>
  <enumeration value="0382008">
    <annotation>
      <documentation>Prothesendysfunktion</documentation>
    </annotation>
  </enumeration>
  <enumeration value="0382009">
    <annotation>
      <documentation>instabiles Sternum</documentation>
    </annotation>
  </enumeration>
  <enumeration value="0382010">
    <annotation>
      <documentation>Chylothorax</documentation>
    </annotation>
  </enumeration>
  <enumeration value="0382011">
    <annotation>
      <documentation>lokale Revision im Bereich des
Zugangsweges</documentation>
    </annotation>
  </enumeration>
  <enumeration value="0382042">
    <annotation>
      <documentation>anderer Grund</documentation>
    </annotation>
  </enumeration>
</restriction>
</simpleType>

```

simpleType enum_0383

namespace	http://xml.ir-d.de/stn		
type	restriction of string		
properties	base xs:string		
facets	Kind	Value	Annotation
	enumeration	0383001	documentation nein
	enumeration	0383002	documentation ja, mit forcierter Atemtherapie
	enumeration	0383003	documentation ja, Reintubation oder längerfristige Beatmung
	enumeration	0383004	documentation ja, Tracheotomie

annotation	documentation Kat_AK_RespiratorischeInsuffizienz
source	<pre> <simpleType name="enum_0383"> <annotation> <documentation>Kat_AK_RespiratorischeInsuffizienz</documentation> </annotation> <restriction base="xs:string"> <enumeration value="0383001"> <annotation> <documentation>nein</documentation> </annotation> </enumeration> <enumeration value="0383002"> <annotation> <documentation>ja, mit forcierter Atemtherapie</documentation> </annotation> </enumeration> <enumeration value="0383003"> <annotation> <documentation>ja, Reintubation oder längerfristige Beatmung</documentation> </annotation> </enumeration> <enumeration value="0383004"> <annotation> <documentation>ja, Tracheotomie</documentation> </annotation> </enumeration> </restriction> </simpleType> </pre>

simpleType enum_0384

namespace	http://xml.ir-d.de/stn		
type	restriction of string		
properties	base xs:string		
facets	Kind	Value	Annotation
	enumeration	0384001	documentation keine Blutungskomplikationen
	enumeration	0384002	documentation Geringfügige Blutung (Minor Bleeding - BARC type 2 or 3a)
	enumeration	0384003	documentation Starke Blutung (Major Bleeding - BARC type 3a)
	enumeration	0384004	documentation Lebensbedrohliche Blutung (Life-threatening or disabling bleeding - BARC type 3b or 3c or type 5)
annotation	documentation Kat_AK_Blutungskomplikation		
source	<pre> <simpleType name="enum_0384"> <annotation> <documentation>Kat_AK_Blutungskomplikation</documentation> </annotation> <restriction base="xs:string"> <enumeration value="0384001"> <annotation> <documentation>keine Blutungskomplikationen</documentation> </annotation> </pre>		

	<pre> </enumeration> <enumeration value="0384002"> <annotation> <documentation>Geringfügige Blutung (Minor Bleeding - BARC type 2 or 3a)</documentation> </annotation> </enumeration> <enumeration value="0384003"> <annotation> <documentation>Starke Blutung (Major Bleeding - BARC type 3a)</documentation> </annotation> </enumeration> <enumeration value="0384004"> <annotation> <documentation>Lebensbedrohliche Blutung (Life-threatening or disabling bleeding - BARC type 3b or 3c or type 5)</documentation> </annotation> </enumeration> </restriction> </simpleType> </pre>
--	--

simpleType enum_0385

namespace	http://xml.ir-d.de/stn		
type	restriction of string		
properties	base xs:string		
facets	Kind	Value	Annotation
	enumeration	0385001	documentation Sinusrhythmus
	enumeration	0385002	documentation Vorhofflimmern
	enumeration	0385003	documentation Patient verstorben (kein Herzrhythmus)
	enumeration	0385042	documentation anderer Rhythmus
annotation	documentation Kat_AK_HerzrhythmusEntlassung		
source	<pre> <simpleType name="enum_0385"> <annotation> <documentation>Kat_AK_HerzrhythmusEntlassung</documentation> </annotation> <restriction base="xs:string"> <enumeration value="0385001"> <annotation> <documentation>Sinusrhythmus</documentation> </annotation> </enumeration> <enumeration value="0385002"> <annotation> <documentation>Vorhofflimmern</documentation> </annotation> </enumeration> <enumeration value="0385003"> <annotation> <documentation>Patient verstorben (kein Herzrhythmus)</documentation> </annotation> </enumeration> </restriction> </simpleType> </pre>		

	<pre> </enumeration> <enumeration value="0385042"> <annotation> <documentation>anderer Rhythmus</documentation> </annotation> </enumeration> </restriction> </simpleType> </pre>
--	--

simpleType enum_0388

namespace	http://xml.ir-d.de/strn		
type	restriction of string		
properties	base xs:string		
facets	Kind	Value	Annotation
	enumeration	0388001	documentation nein
	enumeration	0388002	documentation ASS
	enumeration	0388003	documentation ADP-Rezeptor-Antagonist
	enumeration	0388004	documentation Kombination ASS und ADP-Rezeptor-Antagonist
	enumeration	0388042	documentation ja, andere
	enumeration	0388099	documentation unbekannt
annotation	documentation Kat_AK_Plaettchenaggregationshemmer		
source	<pre> <simpleType name="enum_0388"> <annotation> <documentation>Kat_AK_Plaettchenaggregationshemmer</documentation> </annotation> <restriction base="xs:string"> <enumeration value="0388001"> <annotation> <documentation>nein</documentation> </annotation> </enumeration> <enumeration value="0388002"> <annotation> <documentation>ASS</documentation> </annotation> </enumeration> <enumeration value="0388003"> <annotation> <documentation>ADP-Rezeptor-Antagonist</documentation> </annotation> </enumeration> <enumeration value="0388004"> <annotation> <documentation>Kombination ASS und ADP-Rezeptor- Antagonist</documentation> </annotation> </enumeration> <enumeration value="0388042"> <annotation> </pre>		

	<pre> <documentation>ja, andere</documentation> </annotation> </enumeration> <enumeration value="0388099"> <annotation> <documentation>unbekannt</documentation> </annotation> </enumeration> </restriction> </simpleType> </pre>
--	---

simpleType enum_0389

namespace	http://xml.ir-d.de/stn		
type	restriction of string		
properties	base xs:string		
facets	Kind	Value	Annotation
	enumeration	0389001	documentation nein
	enumeration	0389002	documentation Cumarin-Derivate
	enumeration	0389003	documentation Heparinoide
	enumeration	0389004	documentation orale Thrombinantagonisten
	enumeration	0389006	documentation Direkte orale Antikoagulantien (DOAK / NOAK)
	enumeration	0389042	documentation ja, andere
	enumeration	0389099	documentation unbekannt
annotation	documentation Kat_AK_Antikoagulantien		
source	<pre> <simpleType name="enum_0389"> <annotation> <documentation>Kat_AK_Antikoagulantien</documentation> </annotation> <restriction base="xs:string"> <enumeration value="0389001"> <annotation> <documentation>nein</documentation> </annotation> </enumeration> <enumeration value="0389002"> <annotation> <documentation>Cumarin-Derivate</documentation> </annotation> </enumeration> <enumeration value="0389003"> <annotation> <documentation>Heparinoide</documentation> </annotation> </enumeration> <enumeration value="0389004"> <annotation> <documentation>orale Thrombinantagonisten</documentation> </annotation> </pre>		

	<pre> </enumeration> <enumeration value="0389006"> <annotation> <documentation>Direkte orale Antikoagulantien (DOAK / NOAK)</documentation> </annotation> </enumeration> <enumeration value="0389042"> <annotation> <documentation>ja, andere</documentation> </annotation> </enumeration> <enumeration value="0389099"> <annotation> <documentation>unbekannt</documentation> </annotation> </enumeration> </restriction> </simpleType> </pre>
--	---

simpleType enum_0390

namespace	http://xml.ir-d.de/stn		
type	restriction of string		
properties	base xs:string		
facets	Kind	Value	Annotation
	enumeration	0390001	documentation biologisches Klappenmodell
	enumeration	0390002	documentation mechanisches Klappenmodell
annotation	documentation Kat_AK_Artikeltyp		
source	<pre> <simpleType name="enum_0390"> <annotation> <documentation>Kat_AK_Artikeltyp</documentation> </annotation> <restriction base="xs:string"> <enumeration value="0390001"> <annotation> <documentation>biologisches Klappenmodell</documentation> </annotation> </enumeration> <enumeration value="0390002"> <annotation> <documentation>mechanisches Klappenmodell</documentation> </annotation> </enumeration> </restriction> </simpleType> </pre>		

simpleType enum_0391

namespace	http://xml.ir-d.de/stn
type	restriction of string

properties	base xs:string									
facets	<table border="1"> <thead> <tr> <th>Kind</th> <th>Value</th> <th>Annotation</th> </tr> </thead> <tbody> <tr> <td>enumeration</td> <td>0391001</td> <td>documentation chirurgische Klappe</td> </tr> <tr> <td>enumeration</td> <td>0391002</td> <td>documentation TAVI-Klappe</td> </tr> </tbody> </table>	Kind	Value	Annotation	enumeration	0391001	documentation chirurgische Klappe	enumeration	0391002	documentation TAVI-Klappe
Kind	Value	Annotation								
enumeration	0391001	documentation chirurgische Klappe								
enumeration	0391002	documentation TAVI-Klappe								
annotation	documentation Kat_AK_Klappentyp									
source	<pre> <simpleType name="enum_0391"> <annotation> <documentation>Kat_AK_Klappentyp</documentation> </annotation> <restriction base="xs:string"> <enumeration value="0391001"> <annotation> <documentation>chirurgische Klappe</documentation> </annotation> </enumeration> <enumeration value="0391002"> <annotation> <documentation>TAVI-Klappe</documentation> </annotation> </enumeration> </restriction> </simpleType> </pre>									

simpleType enum_0398

namespace	http://xml.ir-d.de/stn												
type	restriction of string												
properties	base xs:string												
facets	<table border="1"> <thead> <tr> <th>Kind</th> <th>Value</th> <th>Annotation</th> </tr> </thead> <tbody> <tr> <td>enumeration</td> <td>0398001</td> <td>documentation kardiovaskuläre Ursache</td> </tr> <tr> <td>enumeration</td> <td>0398002</td> <td>documentation nicht-kardiovaskuläre Ursache</td> </tr> <tr> <td>enumeration</td> <td>0398099</td> <td>documentation Todesursache unbekannt</td> </tr> </tbody> </table>	Kind	Value	Annotation	enumeration	0398001	documentation kardiovaskuläre Ursache	enumeration	0398002	documentation nicht-kardiovaskuläre Ursache	enumeration	0398099	documentation Todesursache unbekannt
Kind	Value	Annotation											
enumeration	0398001	documentation kardiovaskuläre Ursache											
enumeration	0398002	documentation nicht-kardiovaskuläre Ursache											
enumeration	0398099	documentation Todesursache unbekannt											
annotation	documentation Kat_AK_Todesursache												
source	<pre> <simpleType name="enum_0398"> <annotation> <documentation>Kat_AK_Todesursache</documentation> </annotation> <restriction base="xs:string"> <enumeration value="0398001"> <annotation> <documentation>kardiovaskuläre Ursache</documentation> </annotation> </enumeration> <enumeration value="0398002"> <annotation> <documentation>nicht-kardiovaskuläre Ursache</documentation> </annotation> </enumeration> <enumeration value="0398099"> </pre>												

	<pre> <annotation> <documentation>Todesursache unbekannt</documentation> </annotation> </enumeration> </restriction> </simpleType> </pre>
--	---

simpleType enum_0399

namespace	http://xml.ir-d.de/stn		
type	restriction of string		
properties	base xs:string		
facets	Kind	Value	Annotation
	enumeration	0399001	documentation Patient lebt
	enumeration	0399002	documentation Patient im Krankenhaus verstorben
annotation	documentation Kat_AK_Vitalstatus		
source	<pre> <simpleType name="enum_0399"> <annotation> <documentation>Kat_AK_Vitalstatus</documentation> </annotation> <restriction base="xs:string"> <enumeration value="0399001"> <annotation> <documentation>Patient lebt</documentation> </annotation> </enumeration> <enumeration value="0399002"> <annotation> <documentation>Patient im Krankenhaus verstorben</documentation> </annotation> </enumeration> </restriction> </simpleType> </pre>		

simpleType enum_0044

namespace	http://xml.ir-d.de/irdma		
type	restriction of string		
properties	base xs:string		
facets	Kind	Value	Annotation
	enumeration	0044001	documentation 1= normaler, sonst gesunder Patient
	enumeration	0044002	documentation 2= Patient mit leichter Allgemeinerkrankung
	enumeration	0044003	documentation 3= Patient mit schwerer Allgemeinerkrankung
	enumeration	0044004	documentation 4= Patient mit schwerer Allgemeinerkrankung, die eine ständige Lebensbedrohung darstellt
	enumeration	0044005	documentation 5= moribunder Patient, der ohne die Operation voraussichtlich nicht überleben wird

annotation	documentation Kat_ASA
source	<pre> <simpleType name="enum_0044"> <annotation> <documentation>Kat_ASA</documentation> </annotation> <restriction base="xs:string"> <enumeration value="0044001"> <annotation> <documentation>1= normaler, sonst gesunder Patient</documentation> </annotation> </enumeration> <enumeration value="0044002"> <annotation> <documentation>2= Patient mit leichter Allgemeinerkrankung</documentation> </annotation> </enumeration> <enumeration value="0044003"> <annotation> <documentation>3= Patient mit schwerer Allgemeinerkrankung</documentation> </annotation> </enumeration> <enumeration value="0044004"> <annotation> <documentation>4= Patient mit schwerer Allgemeinerkrankung, die eine ständige Lebensbedrohung darstellt</documentation> </annotation> </enumeration> <enumeration value="0044005"> <annotation> <documentation>5= moribunder Patient, der ohne die Operation voraussichtlich nicht überleben wird</documentation> </annotation> </enumeration> </restriction> </simpleType> </pre>

simpleType enum_0050

namespace	http://xml.ir-d.de/irdma		
type	restriction of string		
properties	base xs:string		
facets	Kind	Value	Annotation
	enumeration	0050001	documentation rechts
	enumeration	0050002	documentation links
annotation	documentation Kat_RechtsLinks		
source	<pre> <simpleType name="enum_0050"> <annotation> <documentation>Kat_RechtsLinks</documentation> </annotation> <restriction base="xs:string"> </pre>		

	<pre> <enumeration value="0050001"> <annotation> <documentation>rechts</documentation> </annotation> </enumeration> <enumeration value="0050002"> <annotation> <documentation>links</documentation> </annotation> </enumeration> </restriction> </simpleType> </pre>
--	--

simpleType enum_0060

namespace	http://xml.ir-d.de/irdma		
type	restriction of string		
properties	base xs:string		
facets	Kind	Value	Annotation
	enumeration	0060001	documentation ja
	enumeration	0060002	documentation nein
annotation	documentation Kat_JaNein		
source	<pre> <simpleType name="enum_0060"> <annotation> <documentation>Kat_JaNein</documentation> </annotation> <restriction base="xs:string"> <enumeration value="0060001"> <annotation> <documentation>ja</documentation> </annotation> </enumeration> <enumeration value="0060002"> <annotation> <documentation>nein</documentation> </annotation> </enumeration> </restriction> </simpleType> </pre>		

simpleType enum_0061

namespace	http://xml.ir-d.de/irdma		
type	restriction of string		
properties	base xs:string		
facets	Kind	Value	Annotation
	enumeration	0061001	documentation ja
	enumeration	0061002	documentation nein
	enumeration	0061099	documentation

	unbekannt
annotation	documentation Kat JaNeinUnbekannt
source	<pre> <simpleType name="enum_0061"> <annotation> <documentation>Kat_JaNeinUnbekannt</documentation> </annotation> <restriction base="xs:string"> <enumeration value="0061001"> <annotation> <documentation>ja</documentation> </annotation> </enumeration> <enumeration value="0061002"> <annotation> <documentation>nein</documentation> </annotation> </enumeration> <enumeration value="0061099"> <annotation> <documentation>unbekannt</documentation> </annotation> </enumeration> </restriction> </simpleType> </pre>

simpleType enum_0062

namespace	http://xml.ir-d.de/irdma		
type	restriction of string		
properties	base	xs:string	
facets	Kind	Value	Annotation
	enumeration	0062001	documentation Stück
	enumeration	0062002	documentation g
	enumeration	0062003	documentation mg
	enumeration	0062004	documentation l
	enumeration	0062005	documentation ml
	enumeration	0062006	documentation cm ³
	enumeration	0062007	documentation mm
	enumeration	0062008	documentation cm
	enumeration	0062009	documentation dm
	enumeration	0062010	documentation m
	enumeration	0062042	documentation andere
annotation	documentation Kat_Einheit		
source	<pre> <simpleType name="enum_0062"> <annotation> </pre>		

```
<documentation>Kat_Einheit</documentation>
</annotation>
<restriction base="xs:string">
  <enumeration value="0062001">
    <annotation>
      <documentation>Stück</documentation>
    </annotation>
  </enumeration>
  <enumeration value="0062002">
    <annotation>
      <documentation>g</documentation>
    </annotation>
  </enumeration>
  <enumeration value="0062003">
    <annotation>
      <documentation>mg</documentation>
    </annotation>
  </enumeration>
  <enumeration value="0062004">
    <annotation>
      <documentation>l</documentation>
    </annotation>
  </enumeration>
  <enumeration value="0062005">
    <annotation>
      <documentation>ml</documentation>
    </annotation>
  </enumeration>
  <enumeration value="0062006">
    <annotation>
      <documentation>cm3</documentation>
    </annotation>
  </enumeration>
  <enumeration value="0062007">
    <annotation>
      <documentation>mm</documentation>
    </annotation>
  </enumeration>
  <enumeration value="0062008">
    <annotation>
      <documentation>cm</documentation>
    </annotation>
  </enumeration>
  <enumeration value="0062009">
    <annotation>
      <documentation>dm</documentation>
    </annotation>
  </enumeration>
  <enumeration value="0062010">
    <annotation>
      <documentation>m</documentation>
    </annotation>
  </enumeration>
  <enumeration value="0062042">
    <annotation>
      <documentation>andere</documentation>
    </annotation>
  </enumeration>
</restriction>
```

	<code></simpleType></code>
--	----------------------------------

simpleType enum_0065

namespace	http://xml.ir-d.de/irdma		
type	restriction of string		
properties	base xs:string		
facets	Kind	Value	Annotation
	enumeration	0065001	documentation stationär
	enumeration	0065002	documentation teilstationär
	enumeration	0065003	documentation ambulant
annotation	documentation Kat_ArtAufenthalt		
source	<pre> <simpleType name="enum_0065"> <annotation> <documentation>Kat_ArtAufenthalt</documentation> </annotation> <restriction base="xs:string"> <enumeration value="0065001"> <annotation> <documentation>stationär</documentation> </annotation> </enumeration> <enumeration value="0065002"> <annotation> <documentation>teilstationär</documentation> </annotation> </enumeration> <enumeration value="0065003"> <annotation> <documentation>ambulant</documentation> </annotation> </enumeration> </restriction> </simpleType> </pre>		

simpleType enum_0067

namespace	http://xml.ir-d.de/irdma		
type	restriction of string		
properties	base xs:string		
facets	Kind	Value	Annotation
	enumeration	0067001	documentation Implantat
	enumeration	0067002	documentation Explantat
annotation	documentation Kat_ArtArtikel		
source	<pre> <simpleType name="enum_0067"> <annotation> <documentation>Kat_ArtArtikel</documentation> </annotation> </pre>		

	<pre> </annotation> <restriction base="xs:string"> <enumeration value="0067001"> <annotation> <documentation>Implantat</documentation> </annotation> </enumeration> <enumeration value="0067002"> <annotation> <documentation>Explantat</documentation> </annotation> </enumeration> </restriction> </simpleType> </pre>
--	--

simpleType enum_0068

namespace	http://xml.ir-d.de/irdma		
type	restriction of string		
properties	base xs:string		
facets	Kind	Value	Annotation
	enumeration	0068001	documentation UDI
	enumeration	0068002	documentation Referenz (REF)
annotation	documentation Kat_KennzeichenTyp		
source	<pre> <simpleType name="enum_0068"> <annotation> <documentation>Kat_KennzeichenTyp</documentation> </annotation> <restriction base="xs:string"> <enumeration value="0068001"> <annotation> <documentation>UDI</documentation> </annotation> </enumeration> <enumeration value="0068002"> <annotation> <documentation>Referenz (REF)</documentation> </annotation> </enumeration> </restriction> </simpleType> </pre>		

simpleType enum_0069

namespace	http://xml.ir-d.de/irdma		
type	restriction of string		
properties	base xs:string		
facets	Kind	Value	Annotation
	enumeration	0069001	documentation Implantat
	enumeration	0069002	documentation

	Explantat
annotation	documentation Kat ArtZubehoer
source	<pre> <simpleType name="enum_0069"> <annotation> <documentation>Kat_ArtZubehoer</documentation> </annotation> <restriction base="xs:string"> <enumeration value="0069001"> <annotation> <documentation>Implantat</documentation> </annotation> </enumeration> <enumeration value="0069002"> <annotation> <documentation>Explantat</documentation> </annotation> </enumeration> </restriction> </simpleType> </pre>

simpleType enum_0070

namespace	http://xml.ir-d.de/irdma		
type	restriction of string		
properties	base xs:string		
facets	Kind	Value	Annotation
	enumeration	0070001	documentation weiblich
	enumeration	0070002	documentation männlich
	enumeration	0070003	documentation divers
	enumeration	0070042	documentation unbestimmt
annotation	documentation Kat Geschlecht		
source	<pre> <simpleType name="enum_0070"> <annotation> <documentation>Kat_Geschlecht</documentation> </annotation> <restriction base="xs:string"> <enumeration value="0070001"> <annotation> <documentation>weiblich</documentation> </annotation> </enumeration> <enumeration value="0070002"> <annotation> <documentation>männlich</documentation> </annotation> </enumeration> <enumeration value="0070003"> <annotation> <documentation>divers</documentation> </annotation> </enumeration> </restriction> </simpleType> </pre>		

	<pre> <enumeration value="0070042"> <annotation> <documentation>unbestimmt</documentation> </annotation> </enumeration> </restriction> </simpleType> </pre>
--	---

simpleType enum_0071

namespace	http://xml.ir-d.de/irdma		
type	restriction of string		
properties	base xs:string		
facets	Kind	Value	Annotation
	enumeration	0071001	documentation Implantat
	enumeration	0071002	documentation Explantat
	enumeration	0071003	documentation Degeneriertes/defektes Produkt, das funktionslos im Körper verbleibt
annotation	documentation Kat_ArtikelArtFunktion		
source	<pre> <simpleType name="enum_0071"> <annotation> <documentation>Kat_ArtikelArtFunktion</documentation> </annotation> <restriction base="xs:string"> <enumeration value="0071001"> <annotation> <documentation>Implantat</documentation> </annotation> </enumeration> <enumeration value="0071002"> <annotation> <documentation>Explantat</documentation> </annotation> </enumeration> <enumeration value="0071003"> <annotation> <documentation>Degeneriertes/defektes Produkt, das funktionslos im Körper verbleibt</documentation> </annotation> </enumeration> </restriction> </simpleType> </pre>		

simpleType enum_0075

namespace	http://xml.ir-d.de/irdma		
type	restriction of string		
properties	base xs:string		
facets	Kind	Value	Annotation
	enumeration	0075001	documentation elektiv

	enumeration 0075002 documentation dringlich enumeration 0075003 documentation Notfall
annotation	documentation Kat_Dringlichkeit
source	<pre> <simpleType name="enum_0075"> <annotation> <documentation>Kat_Dringlichkeit</documentation> </annotation> <restriction base="xs:string"> <enumeration value="0075001"> <annotation> <documentation>elektiv</documentation> </annotation> </enumeration> <enumeration value="0075002"> <annotation> <documentation>dringlich</documentation> </annotation> </enumeration> <enumeration value="0075003"> <annotation> <documentation>Notfall</documentation> </annotation> </enumeration> </restriction> </simpleType> </pre>

simpleType enum 0076

namespace	http://xml.ir-d.de/irdma		
type	restriction of string		
properties	base xs:string		
facets	Kind	Value	Annotation
	enumeration	0076001	documentation elektiv
	enumeration	0076002	documentation dringlich
	enumeration	0076003	documentation Notfall
	enumeration	0076004	documentation Notfall (Reanimation / ultima ratio)
annotation	documentation Kat_Dringlichkeit_Reanimation		
source	<pre> <simpleType name="enum_0076"> <annotation> <documentation>Kat_Dringlichkeit_Reanimation</documentation> </annotation> <restriction base="xs:string"> <enumeration value="0076001"> <annotation> <documentation>elektiv</documentation> </annotation> </enumeration> <enumeration value="0076002"> <annotation> </pre>		

	<pre> <documentation>dringlich</documentation> </annotation> </enumeration> <enumeration value="0076003"> <annotation> <documentation>Notfall</documentation> </annotation> </enumeration> <enumeration value="0076004"> <annotation> <documentation>Notfall (Reanimation / ultima ratio)</documentation> </annotation> </enumeration> </restriction> </simpleType> </pre>
--	--

simpleType enum 0080

namespace	http://xml.ir-d.de/irdma		
type	restriction of string		
properties	base xs:string		
facets	Kind	Value	Annotation
	enumeration	0080001	documentation Endoprothese Hüfte/Knie
	enumeration	0080002	documentation Brustimplantat
	enumeration	0080003	documentation Aortenklappenprothese
annotation	documentation Kat_Implantattyp		
source	<pre> <simpleType name="enum_0080"> <annotation> <documentation>Kat_Implantattyp</documentation> </annotation> <restriction base="xs:string"> <enumeration value="0080001"> <annotation> <documentation>Endoprothese Hüfte/Knie</documentation> </annotation> </enumeration> <enumeration value="0080002"> <annotation> <documentation>Brustimplantat</documentation> </annotation> </enumeration> <enumeration value="0080003"> <annotation> <documentation>Aortenklappenprothese</documentation> </annotation> </enumeration> </restriction> </simpleType> </pre>		

simpleType enum_0100

namespace	http://xml.ir-d.de/irdma		
type	restriction of string		
properties	base xs:string		
facets	Kind	Value	Annotation
	enumeration	0100002	documentation Austausch Expander gegen dauerhaftes Brustimplantat
	enumeration	0100003	documentation Wechsel
	enumeration	0100004	documentation Nur Explantation
	enumeration	0100005	documentation Ersteingriff
	enumeration	0100006	documentation Zweizeitige Implantation
annotation	documentation Kat_BI_ArtEingriff		
source	<pre> <simpleType name="enum_0100"> <annotation> <documentation>Kat_BI_ArtEingriff</documentation> </annotation> <restriction base="xs:string"> <enumeration value="0100002"> <annotation> <documentation>Austausch Expander gegen dauerhaftes Brustimplantat</documentation> </annotation> </enumeration> <enumeration value="0100003"> <annotation> <documentation>Wechsel</documentation> </annotation> </enumeration> <enumeration value="0100004"> <annotation> <documentation>Nur Explantation</documentation> </annotation> </enumeration> <enumeration value="0100005"> <annotation> <documentation>Ersteingriff</documentation> </annotation> </enumeration> <enumeration value="0100006"> <annotation> <documentation>Zweizeitige Implantation</documentation> </annotation> </enumeration> </restriction> </simpleType> </pre>		

simpleType enum_0102

namespace	http://xml.ir-d.de/irdma
type	restriction of string

properties	base xs:string															
facets	<table border="1"> <thead> <tr> <th>Kind</th> <th>Value</th> <th>Annotation</th> </tr> </thead> <tbody> <tr> <td>enumeration</td> <td>0102001</td> <td>documentation kosmetische Augmentation</td> </tr> <tr> <td>enumeration</td> <td>0102002</td> <td>documentation Rekonstruktion, benigne</td> </tr> <tr> <td>enumeration</td> <td>0102003</td> <td>documentation Rekonstruktion nach Mastektomie aufgrund eines Karzinoms</td> </tr> <tr> <td>enumeration</td> <td>0102004</td> <td>documentation Rekonstruktion nach risikoreduzierender Mastektomie</td> </tr> </tbody> </table>	Kind	Value	Annotation	enumeration	0102001	documentation kosmetische Augmentation	enumeration	0102002	documentation Rekonstruktion, benigne	enumeration	0102003	documentation Rekonstruktion nach Mastektomie aufgrund eines Karzinoms	enumeration	0102004	documentation Rekonstruktion nach risikoreduzierender Mastektomie
Kind	Value	Annotation														
enumeration	0102001	documentation kosmetische Augmentation														
enumeration	0102002	documentation Rekonstruktion, benigne														
enumeration	0102003	documentation Rekonstruktion nach Mastektomie aufgrund eines Karzinoms														
enumeration	0102004	documentation Rekonstruktion nach risikoreduzierender Mastektomie														
annotation	documentation Kat_BI_GrundPrimaereingriff															
source	<pre> <simpleType name="enum_0102"> <annotation> <documentation>Kat_BI_GrundPrimaereingriff</documentation> </annotation> <restriction base="xs:string"> <enumeration value="0102001"> <annotation> <documentation>kosmetische Augmentation</documentation> </annotation> </enumeration> <enumeration value="0102002"> <annotation> <documentation>Rekonstruktion, benigne</documentation> </annotation> </enumeration> <enumeration value="0102003"> <annotation> <documentation>Rekonstruktion nach Mastektomie aufgrund eines Karzinoms</documentation> </annotation> </enumeration> <enumeration value="0102004"> <annotation> <documentation>Rekonstruktion nach risikoreduzierender Mastektomie</documentation> </annotation> </enumeration> </restriction> </simpleType> </pre>															

simpleType enum_0103

namespace	http://xml.ir-d.de/irdma																		
type	restriction of string																		
properties	base xs:string																		
facets	<table border="1"> <thead> <tr> <th>Kind</th> <th>Value</th> <th>Annotation</th> </tr> </thead> <tbody> <tr> <td>enumeration</td> <td>0103001</td> <td>documentation simultane Lappendeckung</td> </tr> <tr> <td>enumeration</td> <td>0103002</td> <td>documentation simultane Eigenfettransplantation</td> </tr> <tr> <td>enumeration</td> <td>0103003</td> <td>documentation simultane Mastopexie</td> </tr> <tr> <td>enumeration</td> <td>0103005</td> <td>documentation simultane Mastektomie, Ablatio / hautsparend</td> </tr> <tr> <td>enumeration</td> <td>0103006</td> <td>documentation</td> </tr> </tbody> </table>	Kind	Value	Annotation	enumeration	0103001	documentation simultane Lappendeckung	enumeration	0103002	documentation simultane Eigenfettransplantation	enumeration	0103003	documentation simultane Mastopexie	enumeration	0103005	documentation simultane Mastektomie, Ablatio / hautsparend	enumeration	0103006	documentation
Kind	Value	Annotation																	
enumeration	0103001	documentation simultane Lappendeckung																	
enumeration	0103002	documentation simultane Eigenfettransplantation																	
enumeration	0103003	documentation simultane Mastopexie																	
enumeration	0103005	documentation simultane Mastektomie, Ablatio / hautsparend																	
enumeration	0103006	documentation																	

	enumeration 0103007 simultane Mastektomie, nippelerhaltend documentation Axilla-Dissektion
	enumeration 0103008 documentation Drainage
annotation	documentation Kat_BI_OperationsdetailPrimaereingriff
source	<pre> <simpleType name="enum_0103"> <annotation> <documentation>Kat_BI_OperationsdetailPrimaereingriff</documentation> </annotation> <restriction base="xs:string"> <enumeration value="0103001"> <annotation> <documentation>simultane Lappendeckung</documentation> </annotation> </enumeration> <enumeration value="0103002"> <annotation> <documentation>simultane Eigenfetttransplantation</documentation> </annotation> </enumeration> <enumeration value="0103003"> <annotation> <documentation>simultane Mastopexie</documentation> </annotation> </enumeration> <enumeration value="0103005"> <annotation> <documentation>simultane Mastektomie, Ablatio / hautsparend</documentation> </annotation> </enumeration> <enumeration value="0103006"> <annotation> <documentation>simultane Mastektomie, nippelerhaltend</documentation> </annotation> </enumeration> <enumeration value="0103007"> <annotation> <documentation>Axilla-Dissektion</documentation> </annotation> </enumeration> <enumeration value="0103008"> <annotation> <documentation>Drainage</documentation> </annotation> </enumeration> </restriction> </simpleType> </pre>

simpleType enum_0104

namespace	http://xml.ir-d.de/irdma
type	restriction of string
properties	base xs:string

facets	Kind enumeration	Value 0104001	Annotation documentation Austausch Expander gegen dauerhaftes Brustimplantat
annotation	documentation Kat_BI_GrundAustausch		
source	<pre><simpleType name="enum_0104"> <annotation> <documentation>Kat_BI_GrundAustausch</documentation> </annotation> <restriction base="xs:string"> <enumeration value="0104001"> <annotation> <documentation>Austausch Expander gegen dauerhaftes Brustimplantat</documentation> </annotation> </enumeration> </restriction> </simpleType></pre>		

simpleType enum_0105

namespace	http://xml.ir-d.de/irdma		
type	restriction of string		
properties	base xs:string		
facets	Kind	Value	Annotation
	enumeration	0105001	documentation simultane Lappendeckung
	enumeration	0105002	documentation simultane Eigenfetttransplantation
	enumeration	0105003	documentation simultane Mastopexie
	enumeration	0105008	documentation Drainage
	enumeration	0105009	documentation Kapsulektomie, komplett
	enumeration	0105010	documentation Kapsulektomie, partiell
	enumeration	0105011	documentation Neopocket
annotation	documentation Kat_BI_OperationsdetailAustausch		
source	<pre><simpleType name="enum_0105"> <annotation> <documentation>Kat_BI_OperationsdetailAustausch</documentation> </annotation> <restriction base="xs:string"> <enumeration value="0105001"> <annotation> <documentation>simultane Lappendeckung</documentation> </annotation> </enumeration> <enumeration value="0105002"> <annotation> <documentation>simultane Eigenfetttransplantation</documentation> </annotation> </enumeration> <enumeration value="0105003"> <annotation></pre>		

	<pre> <documentation>simultane Mastopexie</documentation> </annotation> </enumeration> <enumeration value="0105008"> <annotation> <documentation>Drainage</documentation> </annotation> </enumeration> <enumeration value="0105009"> <annotation> <documentation>Kapsulektomie, komplett</documentation> </annotation> </enumeration> <enumeration value="0105010"> <annotation> <documentation>Kapsulektomie, partiell</documentation> </annotation> </enumeration> <enumeration value="0105011"> <annotation> <documentation>Neopocket</documentation> </annotation> </enumeration> </restriction> </simpleType> </pre>
--	---

simpleType enum_0106

namespace	http://xml.ir-d.de/irdma		
type	restriction of string		
properties	base xs:string		
facets	Kind	Value	Annotation
	enumeration	0106001	documentation Patientenwunsch
	enumeration	0106002	documentation asymptomatisch
	enumeration	0106003	documentation Komplikation
annotation	documentation Kat_BI_GrundRevisionExplantation		
source	<pre> <simpleType name="enum_0106"> <annotation> <documentation>Kat_BI_GrundRevisionExplantation</documentation> </annotation> <restriction base="xs:string"> <enumeration value="0106001"> <annotation> <documentation>Patientenwunsch</documentation> </annotation> </enumeration> <enumeration value="0106002"> <annotation> <documentation>asymptomatisch</documentation> </annotation> </enumeration> <enumeration value="0106003"> <annotation> </pre>		

	<pre> <documentation>Komplikation</documentation> </annotation> </enumeration> </restriction> </simpleType> </pre>
--	--

simpleType enum_0107

namespace	http://xml.ir-d.de/irdma		
type	restriction of string		
properties	base xs:string		
facets	Kind	Value	Annotation
	enumeration	0107001	documentation simultane Lappendeckung
	enumeration	0107002	documentation simultane Eigenfetttransplantation
	enumeration	0107003	documentation simultane Mastopexie
	enumeration	0107005	documentation simultane Mastektomie, Ablatio / hautsparend
	enumeration	0107006	documentation simultane Mastektomie, nippelerhaltend
	enumeration	0107007	documentation Axilla-Dissektion
	enumeration	0107008	documentation Drainage
	enumeration	0107009	documentation Kapsulektomie, komplett
	enumeration	0107010	documentation Kapsulektomie, partiell
	enumeration	0107011	documentation Neopocket
annotation	documentation Kat_BI_OperationsdetailRevision		
source	<pre> <simpleType name="enum_0107"> <annotation> <documentation>Kat_BI_OperationsdetailRevision</documentation> </annotation> <restriction base="xs:string"> <enumeration value="0107001"> <annotation> <documentation>simultane Lappendeckung</documentation> </annotation> </enumeration> <enumeration value="0107002"> <annotation> <documentation>simultane Eigenfetttransplantation</documentation> </annotation> </enumeration> <enumeration value="0107003"> <annotation> <documentation>simultane Mastopexie</documentation> </annotation> </enumeration> <enumeration value="0107005"> <annotation> <documentation>simultane Mastektomie, Ablatio / hautsparend</documentation> </pre>		

	<pre> </annotation> </enumeration> <enumeration value="0107006"> <annotation> <documentation>simultane Mastektomie, nippelerhaltend</documentation> </annotation> </enumeration> <enumeration value="0107007"> <annotation> <documentation>Axilla-Dissektion</documentation> </annotation> </enumeration> <enumeration value="0107008"> <annotation> <documentation>Drainage</documentation> </annotation> </enumeration> <enumeration value="0107009"> <annotation> <documentation>Kapsulektomie, komplett</documentation> </annotation> </enumeration> <enumeration value="0107010"> <annotation> <documentation>Kapsulektomie, partiell</documentation> </annotation> </enumeration> <enumeration value="0107011"> <annotation> <documentation>Neopocket</documentation> </annotation> </enumeration> </restriction> </simpleType> </pre>
--	--

simpleType enum_0110

namespace	http://xml.lir-d.de/irdma		
type	restriction of string		
properties	base xs:string		
facets	Kind	Value	Annotation
	enumeration	0110001	documentation Bestrahlung
annotation	documentation Kat_BI_VorbehandlungLokal		
source	<pre> <simpleType name="enum_0110"> <annotation> <documentation>Kat_BI_VorbehandlungLokal</documentation> </annotation> <restriction base="xs:string"> <enumeration value="0110001"> <annotation> <documentation>Bestrahlung</documentation> </annotation> </enumeration> </restriction> </pre>		

	<code></simpleType></code>
--	----------------------------------

simpleType enum_0111

namespace	http://xml.ir-d.de/irdma		
type	restriction of string		
properties	base xs:string		
facets	Kind	Value	Annotation
	enumeration	0111001	documentation nein
	enumeration	0111002	documentation Lipofilling
	enumeration	0111003	documentation Eigengewebstrekonstruktion
annotation	documentation Kat_BI_Verfahrenswechsel		
source	<pre> <simpleType name="enum_0111"> <annotation> <documentation>Kat_BI_Verfahrenswechsel</documentation> </annotation> <restriction base="xs:string"> <enumeration value="0111001"> <annotation> <documentation>nein</documentation> </annotation> </enumeration> <enumeration value="0111002"> <annotation> <documentation>Lipofilling</documentation> </annotation> </enumeration> <enumeration value="0111003"> <annotation> <documentation>Eigengewebstrekonstruktion</documentation> </annotation> </enumeration> </restriction> </simpleType> </pre>		

simpleType enum_0112

namespace	http://xml.ir-d.de/irdma		
type	restriction of string		
properties	base xs:string		
facets	Kind	Value	Annotation
	enumeration	0112001	documentation subglandulär / epipektoral
	enumeration	0112002	documentation subpektoral
	enumeration	0112003	documentation subfaszial
	enumeration	0112004	documentation sub-flap
	enumeration	0112005	documentation subkutan

	enumeration 0112006 documentation dual plane enumeration 0112042 documentation andere
annotation	documentation Kat_BI_LageImplantat
source	<pre> <simpleType name="enum_0112"> <annotation> <documentation>Kat_BI_LageImplantat</documentation> </annotation> <restriction base="xs:string"> <enumeration value="0112001"> <annotation> <documentation>subglandulär / epipektoral</documentation> </annotation> </enumeration> <enumeration value="0112002"> <annotation> <documentation>subpektoral</documentation> </annotation> </enumeration> <enumeration value="0112003"> <annotation> <documentation>subfaszial</documentation> </annotation> </enumeration> <enumeration value="0112004"> <annotation> <documentation>sub-flap</documentation> </annotation> </enumeration> <enumeration value="0112005"> <annotation> <documentation>subkutan</documentation> </annotation> </enumeration> <enumeration value="0112006"> <annotation> <documentation>dual plane</documentation> </annotation> </enumeration> <enumeration value="0112042"> <annotation> <documentation>andere</documentation> </annotation> </enumeration> </restriction> </simpleType> </pre>

simpleType enum_0113

namespace	http://xml.ir-d.de/irdma		
type	restriction of string		
properties	base xs:string		
facets	Kind enumeration	Value 0113001	Annotation documentation Chemotherapie innerhalb der letzten drei Monate

annotation	documentation Kat_BI_VorbehandlungSystemisch
source	<pre> <simpleType name="enum_0113"> <annotation> <documentation>Kat_BI_VorbehandlungSystemisch</documentation> </annotation> <restriction base="xs:string"> <enumeration value="0113001"> <annotation> <documentation>Chemotherapie innerhalb der letzten drei Monate</documentation> </annotation> </enumeration> </restriction> </simpleType> </pre>

simpleType enum_0114

namespace	http://xml.ir-d.de/irdma		
type	restriction of string		
properties	base xs:string		
facets	Kind	Value	Annotation
	enumeration	0114001	documentation vollständig
	enumeration	0114002	documentation nein
	enumeration	0114003	documentation teilweise
	enumeration	0114004	documentation nicht vorhanden
annotation	documentation Kat_BI_EntfernungADMNetz		
source	<pre> <simpleType name="enum_0114"> <annotation> <documentation>Kat_BI_EntfernungADMNetz</documentation> </annotation> <restriction base="xs:string"> <enumeration value="0114001"> <annotation> <documentation>vollständig</documentation> </annotation> </enumeration> <enumeration value="0114002"> <annotation> <documentation>nein</documentation> </annotation> </enumeration> <enumeration value="0114003"> <annotation> <documentation>teilweise</documentation> </annotation> </enumeration> <enumeration value="0114004"> <annotation> <documentation>nicht vorhanden</documentation> </annotation> </enumeration> </restriction> </simpleType> </pre>		

```

</restriction>
</simpleType>

```

simpleType enum_0116

namespace	http://xml.ir-d.de/irdma		
type	restriction of string		
properties	base xs:string		
facets	Kind	Value	Annotation
	enumeration	0116001	documentation Spülung, antibiotisch
	enumeration	0116002	documentation Spülung, antiseptisch
	enumeration	0116003	documentation Spülung, wirkstofffrei
	enumeration	0116004	documentation Spülung, andere
	enumeration	0116005	documentation prä-/perioperative Antibiotika
	enumeration	0116006	documentation postoperative Antibiotika
	enumeration	0116007	documentation Handschuhwechsel vor Implantation
	enumeration	0116008	documentation Implantationshilfe
annotation	documentation Kat_BI_Operationsmassnahme		
source	<pre> <simpleType name="enum_0116"> <annotation> <documentation>Kat_BI_Operationsmassnahme</documentation> </annotation> <restriction base="xs:string"> <enumeration value="0116001"> <annotation> <documentation>Spülung, antibiotisch</documentation> </annotation> </enumeration> <enumeration value="0116002"> <annotation> <documentation>Spülung, antiseptisch</documentation> </annotation> </enumeration> <enumeration value="0116003"> <annotation> <documentation>Spülung, wirkstofffrei</documentation> </annotation> </enumeration> <enumeration value="0116004"> <annotation> <documentation>Spülung, andere</documentation> </annotation> </enumeration> <enumeration value="0116005"> <annotation> <documentation>prä-/perioperative Antibiotika</documentation> </annotation> </enumeration> <enumeration value="0116006"> </pre>		

	<pre> <annotation> <documentation>postoperative Antibiotika</documentation> </annotation> </enumeration> <enumeration value="0116007"> <annotation> <documentation>Handschuhwechsel vor Implantation</documentation> </annotation> </enumeration> <enumeration value="0116008"> <annotation> <documentation>Implantationshilfe</documentation> </annotation> </enumeration> </restriction> </simpleType> </pre>
--	---

simpleType enum_0118

namespace	http://xml.ir-d.de/irdma		
type	restriction of string		
properties	base xs:string		
facets	Kind	Value	Annotation
	enumeration	0118001	documentation axillär
	enumeration	0118002	documentation periareolär
	enumeration	0118003	documentation inframammär
	enumeration	0118004	documentation Mastektomienarbe
	enumeration	0118042	documentation anderer
annotation	documentation Kat_BI_Operationszugang		
source	<pre> <simpleType name="enum_0118"> <annotation> <documentation>Kat_BI_Operationszugang</documentation> </annotation> <restriction base="xs:string"> <enumeration value="0118001"> <annotation> <documentation>axillär</documentation> </annotation> </enumeration> <enumeration value="0118002"> <annotation> <documentation>periareolär</documentation> </annotation> </enumeration> <enumeration value="0118003"> <annotation> <documentation>inframammär</documentation> </annotation> </enumeration> <enumeration value="0118004"> <annotation> </pre>		

	<pre> <documentation>Mastektomienarbe</documentation> </annotation> </enumeration> <enumeration value="0118042"> <annotation> <documentation>anderer</documentation> </annotation> </enumeration> </restriction> </simpleType> </pre>
--	---

simpleType enum_0120

namespace	http://xml.ir-d.de/irdma		
type	restriction of string		
properties	base xs:string		
facets	Kind	Value	Annotation
	enumeration	0120001	documentation Expander defekt
annotation	documentation Kat_BI_BefundAustausch		
source	<pre> <simpleType name="enum_0120"> <annotation> <documentation>Kat_BI_BefundAustausch</documentation> </annotation> <restriction base="xs:string"> <enumeration value="0120001"> <annotation> <documentation>Expander defekt</documentation> </annotation> </enumeration> </restriction> </simpleType> </pre>		

simpleType enum_0121

namespace	http://xml.ir-d.de/irdma		
type	restriction of string		
properties	base xs:string		
facets	Kind	Value	Annotation
	enumeration	0121001	documentation Infektion
	enumeration	0121002	documentation Serom
	enumeration	0121004	documentation Kapsel fibrose
	enumeration	0121005	documentation Implantatruptur
	enumeration	0121006	documentation Fehlpositionierung/Rotation
	enumeration	0121007	documentation BIA-ALCL/-BCL/-SCC, Verdacht
	enumeration	0121008	documentation BIA-ALCL/-BCL/-SCC, pathologisch bestätigt
	enumeration	0121009	documentation

	<p>enumeration 0121010 Brustschmerzen documentation Doppelkapsel</p> <p>enumeration 0121011 documentation Netz-/ADM-bedingte Komplikation, Non-Integration</p> <p>enumeration 0121012 documentation Netz-/ADM-bedingte Komplikation, andere</p> <p>enumeration 0121013 documentation Hautnekrose/exponiertes Implantat</p> <p>enumeration 0121014 documentation BII/ASIA (Brustimplantat assoziierte Symptome), Verdacht</p> <p>enumeration 0121015 documentation Lymphadenopathie</p> <p>enumeration 0121016 documentation Brustkrebs, neu aufgetreten/Rezidiv</p> <p>enumeration 0121042 documentation sonstiger</p>
annotation	documentation Kat BI BefundKomplett
source	<pre> <simpleType name="enum_0121"> <annotation> <documentation>Kat_BI_BefundKomplett</documentation> </annotation> <restriction base="xs:string"> <enumeration value="0121001"> <annotation> <documentation>Infektion</documentation> </annotation> </enumeration> <enumeration value="0121002"> <annotation> <documentation>Serom</documentation> </annotation> </enumeration> <enumeration value="0121004"> <annotation> <documentation>Kapsel fibrose</documentation> </annotation> </enumeration> <enumeration value="0121005"> <annotation> <documentation>Implantatruptur</documentation> </annotation> </enumeration> <enumeration value="0121006"> <annotation> <documentation>Fehlpositionierung/Rotation</documentation> </annotation> </enumeration> <enumeration value="0121007"> <annotation> <documentation>BIA-ALCL/-BCL/-SCC, Verdacht</documentation> </annotation> </enumeration> <enumeration value="0121008"> <annotation> <documentation>BIA-ALCL/-BCL/-SCC, pathologisch bestätigt</documentation> </annotation> </enumeration> </restriction> </simpleType> </pre>

```

<enumeration value="0121009">
  <annotation>
    <documentation>Brustschmerzen</documentation>
  </annotation>
</enumeration>
<enumeration value="0121010">
  <annotation>
    <documentation>Doppelkapsel</documentation>
  </annotation>
</enumeration>
<enumeration value="0121011">
  <annotation>
    <documentation>Netz-/ADM-bedingte Komplikation, Non-
Integration</documentation>
  </annotation>
</enumeration>
<enumeration value="0121012">
  <annotation>
    <documentation>Netz-/ADM-bedingte Komplikation,
andere</documentation>
  </annotation>
</enumeration>
<enumeration value="0121013">
  <annotation>
    <documentation>Hautnekrose/exponiertes Implantat</documentation>
  </annotation>
</enumeration>
<enumeration value="0121014">
  <annotation>
    <documentation>BII/ASIA (Brustimplantat assoziierte Symptome),
Verdacht</documentation>
  </annotation>
</enumeration>
<enumeration value="0121015">
  <annotation>
    <documentation>Lymphadenopathie</documentation>
  </annotation>
</enumeration>
<enumeration value="0121016">
  <annotation>
    <documentation>Brustkrebs, neu aufgetreten/Rezidiv</documentation>
  </annotation>
</enumeration>
<enumeration value="0121042">
  <annotation>
    <documentation>sonstiger</documentation>
  </annotation>
</enumeration>
</restriction>
</simpleType>

```

simpleType enum_0122

namespace	http://xml.ir-d.de/irdma
type	restriction of string
properties	base xs:string

facets	<table border="1"> <thead> <tr> <th>Kind</th> <th>Value</th> <th>Annotation</th> </tr> </thead> <tbody> <tr> <td>enumeration</td> <td>0122001</td> <td>documentation ja, ärztlich nachgewiesen</td> </tr> <tr> <td>enumeration</td> <td>0122002</td> <td>documentation nein</td> </tr> <tr> <td>enumeration</td> <td>0122042</td> <td>documentation unbekannt</td> </tr> </tbody> </table>	Kind	Value	Annotation	enumeration	0122001	documentation ja, ärztlich nachgewiesen	enumeration	0122002	documentation nein	enumeration	0122042	documentation unbekannt
Kind	Value	Annotation											
enumeration	0122001	documentation ja, ärztlich nachgewiesen											
enumeration	0122002	documentation nein											
enumeration	0122042	documentation unbekannt											
annotation	documentation Kat_BI_Autoimmunerkrankung												
source	<pre> <simpleType name="enum_0122"> <annotation> <documentation>Kat_BI_Autoimmunerkrankung</documentation> </annotation> <restriction base="xs:string"> <enumeration value="0122001"> <annotation> <documentation>ja, ärztlich nachgewiesen</documentation> </annotation> </enumeration> <enumeration value="0122002"> <annotation> <documentation>nein</documentation> </annotation> </enumeration> <enumeration value="0122042"> <annotation> <documentation>unbekannt</documentation> </annotation> </enumeration> </restriction> </simpleType> </pre>												

simpleType enum_0123

namespace	http://xml.ir-d.de/irdma																		
type	restriction of string																		
properties	base xs:string																		
facets	<table border="1"> <thead> <tr> <th>Kind</th> <th>Value</th> <th>Annotation</th> </tr> </thead> <tbody> <tr> <td>enumeration</td> <td>0123001</td> <td>documentation neu aufgetreten</td> </tr> <tr> <td>enumeration</td> <td>0123002</td> <td>documentation verschlechtert</td> </tr> <tr> <td>enumeration</td> <td>0123003</td> <td>documentation keine Veränderung</td> </tr> <tr> <td>enumeration</td> <td>0123004</td> <td>documentation nicht relevant, da Primäreingriff</td> </tr> <tr> <td>enumeration</td> <td>0123042</td> <td>documentation unbekannt</td> </tr> </tbody> </table>	Kind	Value	Annotation	enumeration	0123001	documentation neu aufgetreten	enumeration	0123002	documentation verschlechtert	enumeration	0123003	documentation keine Veränderung	enumeration	0123004	documentation nicht relevant, da Primäreingriff	enumeration	0123042	documentation unbekannt
Kind	Value	Annotation																	
enumeration	0123001	documentation neu aufgetreten																	
enumeration	0123002	documentation verschlechtert																	
enumeration	0123003	documentation keine Veränderung																	
enumeration	0123004	documentation nicht relevant, da Primäreingriff																	
enumeration	0123042	documentation unbekannt																	
annotation	documentation Kat_BI_VerlaufAutoimmunerkrankung																		
source	<pre> <simpleType name="enum_0123"> <annotation> <documentation>Kat_BI_VerlaufAutoimmunerkrankung</documentation> </annotation> <restriction base="xs:string"> <enumeration value="0123001"> <annotation> <documentation>neu aufgetreten</documentation> </annotation> </enumeration> </restriction> </simpleType> </pre>																		

	<pre> </annotation> </enumeration> <enumeration value="0123002"> <annotation> <documentation>verschlechtert</documentation> </annotation> </enumeration> <enumeration value="0123003"> <annotation> <documentation>keine Veränderung</documentation> </annotation> </enumeration> <enumeration value="0123004"> <annotation> <documentation>nicht relevant, da Primäreingriff</documentation> </annotation> </enumeration> <enumeration value="0123042"> <annotation> <documentation>unbekannt</documentation> </annotation> </enumeration> </restriction> </simpleType> </pre>
--	---

simpleType enum_0124

namespace	http://xml.ir-d.de/irdma		
type	restriction of string		
properties	base xs:string		
facets	Kind	Value	Annotation
	enumeration	0124001	documentation Salzlösung
	enumeration	0124002	documentation Silikongel
	enumeration	0124003	documentation Kombination Silikongel und Salzlösung
	enumeration	0124042	documentation sonstige
annotation	documentation Kat_BI_Fuellung		
source	<pre> <simpleType name="enum_0124"> <annotation> <documentation>Kat_BI_Fuellung</documentation> </annotation> <restriction base="xs:string"> <enumeration value="0124001"> <annotation> <documentation>Salzlösung</documentation> </annotation> </enumeration> <enumeration value="0124002"> <annotation> <documentation>Silikongel</documentation> </annotation> </enumeration> <enumeration value="0124003"> </pre>		

	<pre> <annotation> <documentation>Kombination Silikongel und Salzlösung</documentation> </annotation> </enumeration> <enumeration value="0124042"> <annotation> <documentation>sonstige</documentation> </annotation> </enumeration> </restriction> </simpleType> </pre>
--	--

simpleType enum_0126

namespace	http://xml.ir-d.de/irdma		
type	restriction of string		
properties	base xs:string		
facets	Kind	Value	Annotation
	enumeration	0126001	documentation anatomisch (tropfenförmig)
	enumeration	0126002	documentation rund (punktsymmetrisch)
	enumeration	0126042	documentation sonstige
annotation	documentation Kat_BI_Form		
source	<pre> <simpleType name="enum_0126"> <annotation> <documentation>Kat_BI_Form</documentation> </annotation> <restriction base="xs:string"> <enumeration value="0126001"> <annotation> <documentation>anatomisch (tropfenförmig)</documentation> </annotation> </enumeration> <enumeration value="0126002"> <annotation> <documentation>rund (punktsymmetrisch)</documentation> </annotation> </enumeration> <enumeration value="0126042"> <annotation> <documentation>sonstige</documentation> </annotation> </enumeration> </restriction> </simpleType> </pre>		

simpleType enum_0128

namespace	http://xml.ir-d.de/irdma		
type	restriction of string		
properties	base xs:string		

facets	<table border="1"> <thead> <tr> <th>Kind</th> <th>Value</th> <th>Annotation</th> </tr> </thead> <tbody> <tr> <td>enumeration</td> <td>0128001</td> <td>documentation glattwandig</td> </tr> <tr> <td>enumeration</td> <td>0128002</td> <td>documentation beschichtet</td> </tr> <tr> <td>enumeration</td> <td>0128003</td> <td>documentation texturiert</td> </tr> </tbody> </table>	Kind	Value	Annotation	enumeration	0128001	documentation glattwandig	enumeration	0128002	documentation beschichtet	enumeration	0128003	documentation texturiert
Kind	Value	Annotation											
enumeration	0128001	documentation glattwandig											
enumeration	0128002	documentation beschichtet											
enumeration	0128003	documentation texturiert											
annotation	documentation Kat_BI_Oberflaeche												
source	<pre> <simpleType name="enum_0128"> <annotation> <documentation>Kat_BI_Oberflaeche</documentation> </annotation> <restriction base="xs:string"> <enumeration value="0128001"> <annotation> <documentation>glattwandig</documentation> </annotation> </enumeration> <enumeration value="0128002"> <annotation> <documentation>beschichtet</documentation> </annotation> </enumeration> <enumeration value="0128003"> <annotation> <documentation>texturiert</documentation> </annotation> </enumeration> </restriction> </simpleType> </pre>												

simpleType enum_0131

namespace	http://xml.ir-d.de/irdma																																				
type	restriction of string																																				
properties	base xs:string																																				
facets	<table border="1"> <thead> <tr> <th>Kind</th> <th>Value</th> <th>Annotation</th> </tr> </thead> <tbody> <tr> <td>enumeration</td> <td>0131001</td> <td>documentation Allergan</td> </tr> <tr> <td>enumeration</td> <td>0131002</td> <td>documentation Establishment Labs</td> </tr> <tr> <td>enumeration</td> <td>0131003</td> <td>documentation Eurosilicone</td> </tr> <tr> <td>enumeration</td> <td>0131004</td> <td>documentation Galatea</td> </tr> <tr> <td>enumeration</td> <td>0131005</td> <td>documentation Integra</td> </tr> <tr> <td>enumeration</td> <td>0131006</td> <td>documentation Lifecell</td> </tr> <tr> <td>enumeration</td> <td>0131007</td> <td>documentation MBP (Medical Biomaterial Products)</td> </tr> <tr> <td>enumeration</td> <td>0131008</td> <td>documentation Mentor</td> </tr> <tr> <td>enumeration</td> <td>0131009</td> <td>documentation Novus Scientific</td> </tr> <tr> <td>enumeration</td> <td>0131010</td> <td>documentation pfmMedical</td> </tr> <tr> <td>enumeration</td> <td>0131011</td> <td>documentation</td> </tr> </tbody> </table>	Kind	Value	Annotation	enumeration	0131001	documentation Allergan	enumeration	0131002	documentation Establishment Labs	enumeration	0131003	documentation Eurosilicone	enumeration	0131004	documentation Galatea	enumeration	0131005	documentation Integra	enumeration	0131006	documentation Lifecell	enumeration	0131007	documentation MBP (Medical Biomaterial Products)	enumeration	0131008	documentation Mentor	enumeration	0131009	documentation Novus Scientific	enumeration	0131010	documentation pfmMedical	enumeration	0131011	documentation
Kind	Value	Annotation																																			
enumeration	0131001	documentation Allergan																																			
enumeration	0131002	documentation Establishment Labs																																			
enumeration	0131003	documentation Eurosilicone																																			
enumeration	0131004	documentation Galatea																																			
enumeration	0131005	documentation Integra																																			
enumeration	0131006	documentation Lifecell																																			
enumeration	0131007	documentation MBP (Medical Biomaterial Products)																																			
enumeration	0131008	documentation Mentor																																			
enumeration	0131009	documentation Novus Scientific																																			
enumeration	0131010	documentation pfmMedical																																			
enumeration	0131011	documentation																																			

	<p>enumeration 0131012 Serag Wiessner documentation nicht belegter Wert</p> <p>enumeration 0131013 documentation nicht belegter Wert</p> <p>enumeration 0131014 documentation nicht belegter Wert</p> <p>enumeration 0131015 documentation nicht belegter Wert</p> <p>enumeration 0131042 documentation sonstiger</p>
annotation	<p>documentation Kat BI_ZubehoerHersteller</p>
source	<pre> <simpleType name="enum_0131"> <annotation> <documentation>Kat_BI_ZubehoerHersteller</documentation> </annotation> <restriction base="xs:string"> <enumeration value="0131001"> <annotation> <documentation>Allergan</documentation> </annotation> </enumeration> <enumeration value="0131002"> <annotation> <documentation>Establishment Labs</documentation> </annotation> </enumeration> <enumeration value="0131003"> <annotation> <documentation>Eurosilicone</documentation> </annotation> </enumeration> <enumeration value="0131004"> <annotation> <documentation>Galatea</documentation> </annotation> </enumeration> <enumeration value="0131005"> <annotation> <documentation>Integra</documentation> </annotation> </enumeration> <enumeration value="0131006"> <annotation> <documentation>Lifecell</documentation> </annotation> </enumeration> <enumeration value="0131007"> <annotation> <documentation>MBP (Medical Biomaterial Products)</documentation> </annotation> </enumeration> <enumeration value="0131008"> <annotation> <documentation>Mentor</documentation> </annotation> </enumeration> <enumeration value="0131009"> <annotation> </pre>

```

    <documentation>Novus Scientific</documentation>
  </annotation>
</enumeration>
<enumeration value="0131010">
  <annotation>
    <documentation>pfmMedical</documentation>
  </annotation>
</enumeration>
<enumeration value="0131011">
  <annotation>
    <documentation>Serag Wiessner</documentation>
  </annotation>
</enumeration>
<enumeration value="0131012">
  <annotation>
    <documentation>nicht belegter Wert</documentation>
  </annotation>
</enumeration>
<enumeration value="0131013">
  <annotation>
    <documentation>nicht belegter Wert</documentation>
  </annotation>
</enumeration>
<enumeration value="0131014">
  <annotation>
    <documentation>nicht belegter Wert</documentation>
  </annotation>
</enumeration>
<enumeration value="0131015">
  <annotation>
    <documentation>nicht belegter Wert</documentation>
  </annotation>
</enumeration>
<enumeration value="0131042">
  <annotation>
    <documentation>sonstiger</documentation>
  </annotation>
</enumeration>
</restriction>
</simpleType>

```

simpleType enum_0170

namespace	http://xml.ir-d.de/irdma		
type	restriction of string		
properties	base xs:string		
facets	Kind	Value	Annotation
	enumeration	0170001	documentation weiblich
	enumeration	0170002	documentation männlich
	enumeration	0170003	documentation intersexuell
annotation	documentation Kat_Bl_GeschlechtGeburt		
source	<simpleType name="enum_0170"> <annotation>		

	<pre> <documentation>Kat_BI_GeschlechtGeburt</documentation> </annotation> <restriction base="xs:string"> <enumeration value="0170001"> <annotation> <documentation>weiblich</documentation> </annotation> </enumeration> <enumeration value="0170002"> <annotation> <documentation>männlich</documentation> </annotation> </enumeration> <enumeration value="0170003"> <annotation> <documentation>intersexuell</documentation> </annotation> </enumeration> </restriction> </simpleType> </pre>
--	---

simpleType enum_0190

namespace	http://xml.ir-d.de/irdma		
type	restriction of string		
properties	base xs:string		
facets	Kind	Value	Annotation
	enumeration	0190001	documentation Brustimplantat
	enumeration	0190003	documentation Brustexpander
annotation	documentation Kat_BI_Artikeltyp		
source	<pre> <simpleType name="enum_0190"> <annotation> <documentation>Kat_BI_Artikeltyp</documentation> </annotation> <restriction base="xs:string"> <enumeration value="0190001"> <annotation> <documentation>Brustimplantat</documentation> </annotation> </enumeration> <enumeration value="0190003"> <annotation> <documentation>Brustexpander</documentation> </annotation> </enumeration> </restriction> </simpleType> </pre>		

simpleType enum_0191

namespace	http://xml.ir-d.de/irdma
-----------	--------------------------

type	restriction of string									
properties	base xs:string									
facets	<table border="1"> <thead> <tr> <th>Kind</th> <th>Value</th> <th>Annotation</th> </tr> </thead> <tbody> <tr> <td>enumeration</td> <td>0191001</td> <td>documentation Netz</td> </tr> <tr> <td>enumeration</td> <td>0191002</td> <td>documentation ADM</td> </tr> </tbody> </table>	Kind	Value	Annotation	enumeration	0191001	documentation Netz	enumeration	0191002	documentation ADM
Kind	Value	Annotation								
enumeration	0191001	documentation Netz								
enumeration	0191002	documentation ADM								
annotation	documentation Kat_BI_ZubehoerTyp									
source	<pre><simpleType name="enum_0191"> <annotation> <documentation>Kat_BI_ZubehoerTyp</documentation> </annotation> <restriction base="xs:string"> <enumeration value="0191001"> <annotation> <documentation>Netz</documentation> </annotation> </enumeration> <enumeration value="0191002"> <annotation> <documentation>ADM</documentation> </annotation> </enumeration> </restriction> </simpleType></pre>									

simpleType **enum_0200**

namespace	http://xml.ir-d.de/irdma									
type	restriction of string									
properties	base xs:string									
facets	<table border="1"> <thead> <tr> <th>Kind</th> <th>Value</th> <th>Annotation</th> </tr> </thead> <tbody> <tr> <td>enumeration</td> <td>0200001</td> <td>documentation Erst-OP</td> </tr> <tr> <td>enumeration</td> <td>0200002</td> <td>documentation Folgeingriff</td> </tr> </tbody> </table>	Kind	Value	Annotation	enumeration	0200001	documentation Erst-OP	enumeration	0200002	documentation Folgeingriff
Kind	Value	Annotation								
enumeration	0200001	documentation Erst-OP								
enumeration	0200002	documentation Folgeingriff								
annotation	documentation Kat_EP_ArtEingriff									
source	<pre><simpleType name="enum_0200"> <annotation> <documentation>Kat_EP_ArtEingriff</documentation> </annotation> <restriction base="xs:string"> <enumeration value="0200001"> <annotation> <documentation>Erst-OP</documentation> </annotation> </enumeration> <enumeration value="0200002"> <annotation> <documentation>Folgeingriff</documentation> </annotation> </enumeration> </restriction> </simpleType></pre>									

</simpleType>

simpleType enum_0202

namespace	http://xml.ir-d.de/irdma		
type	restriction of string		
properties	base xs:string		
facets	Kind	Value	Annotation
	enumeration	0202001	documentation Lockerung
	enumeration	0202002	documentation Infektion, Verdacht auf
	enumeration	0202003	documentation Infektion, gesichert
	enumeration	0202004	documentation Luxation, Inlay aus der Pfanne
	enumeration	0202005	documentation Luxation, Kopf aus Pfanne/Inlay
	enumeration	0202006	documentation Periprothetische Fraktur
	enumeration	0202007	documentation Verschleiß des PE-Inlays
	enumeration	0202008	documentation Implantatbruch
	enumeration	0202009	documentation Implantatfehlage/Malalignent
	enumeration	0202010	documentation Osteolysen bei festem Implantat
	enumeration	0202011	documentation Progression der Grunderkrankung
	enumeration	0202012	documentation ARMD
	enumeration	0202013	documentation Verdacht auf allergische Reaktion
	enumeration	0202042	documentation andere Gründe
annotation	documentation Kat_EP_GrundWechselHuefte		
source	<pre><simpleType name="enum_0202"> <annotation> <documentation>Kat_EP_GrundWechselHuefte</documentation> </annotation> <restriction base="xs:string"> <enumeration value="0202001"> <annotation> <documentation>Lockerung</documentation> </annotation> </enumeration> <enumeration value="0202002"> <annotation> <documentation>Infektion, Verdacht auf</documentation> </annotation> </enumeration> <enumeration value="0202003"> <annotation> <documentation>Infektion, gesichert</documentation> </annotation> </enumeration> <enumeration value="0202004"></pre>		

```

    <annotation>
      <documentation>Luxation, Inlay aus der Pfanne</documentation>
    </annotation>
  </enumeration>
  <enumeration value="0202005">
    <annotation>
      <documentation>Luxation, Kopf aus Pfanne/Inlay</documentation>
    </annotation>
  </enumeration>
  <enumeration value="0202006">
    <annotation>
      <documentation>Periprothetische Fraktur</documentation>
    </annotation>
  </enumeration>
  <enumeration value="0202007">
    <annotation>
      <documentation>Verschleiß des PE-Inlays</documentation>
    </annotation>
  </enumeration>
  <enumeration value="0202008">
    <annotation>
      <documentation>Implantatbruch</documentation>
    </annotation>
  </enumeration>
  <enumeration value="0202009">
    <annotation>
      <documentation>Implantatfehlage/Malalignent</documentation>
    </annotation>
  </enumeration>
  <enumeration value="0202010">
    <annotation>
      <documentation>Osteolysen bei festem Implantat</documentation>
    </annotation>
  </enumeration>
  <enumeration value="0202011">
    <annotation>
      <documentation>Progression der Grunderkrankung</documentation>
    </annotation>
  </enumeration>
  <enumeration value="0202012">
    <annotation>
      <documentation>ARMD</documentation>
    </annotation>
  </enumeration>
  <enumeration value="0202013">
    <annotation>
      <documentation>Verdacht auf allergische Reaktion</documentation>
    </annotation>
  </enumeration>
  <enumeration value="0202042">
    <annotation>
      <documentation>andere Gründe</documentation>
    </annotation>
  </enumeration>
</restriction>
</simpleType>

```

simpleType enum_0204

namespace	http://xml.ir-d.de/irdma		
type	restriction of string		
properties	base xs:string		
facets	Kind	Value	Annotation
	enumeration	0204001	documentation Lockerung
	enumeration	0204002	documentation Infektion, Verdacht auf
	enumeration	0204003	documentation Infektion, gesichert
	enumeration	0204006	documentation Periprothetische Fraktur
	enumeration	0204007	documentation Verschleiß
	enumeration	0204008	documentation Implantatbruch
	enumeration	0204009	documentation Implantatfehlage/Malalignent
	enumeration	0204010	documentation Osteolysen bei festem Implantat
	enumeration	0204011	documentation Progression der Grunderkrankung
	enumeration	0204012	documentation ARM-D
	enumeration	0204013	documentation Verdacht auf allergische Reaktion
	enumeration	0204014	documentation Dislokation/Migration von Komponenten
	enumeration	0204015	documentation Bandinstabilität
	enumeration	0204016	documentation Bewegungseinschränkung
	enumeration	0204042	documentation andere Gründe
annotation	documentation Kat_EP_GrundWechselKnie		
source	<pre> <simpleType name="enum_0204"> <annotation> <documentation>Kat_EP_GrundWechselKnie</documentation> </annotation> <restriction base="xs:string"> <enumeration value="0204001"> <annotation> <documentation>Lockerung</documentation> </annotation> </enumeration> <enumeration value="0204002"> <annotation> <documentation>Infektion, Verdacht auf</documentation> </annotation> </enumeration> <enumeration value="0204003"> <annotation> <documentation>Infektion, gesichert</documentation> </annotation> </enumeration> <enumeration value="0204006"> <annotation> <documentation>Periprothetische Fraktur</documentation> </annotation> </enumeration> <enumeration value="0204007"> <annotation> <documentation>Verschleiß</documentation> </annotation> </enumeration> <enumeration value="0204008"> <annotation> <documentation>Implantatbruch</documentation> </annotation> </enumeration> <enumeration value="0204009"> <annotation> <documentation>Implantatfehlage/Malalignent</documentation> </annotation> </enumeration> <enumeration value="0204010"> <annotation> <documentation>Osteolysen bei festem Implantat</documentation> </annotation> </enumeration> <enumeration value="0204011"> <annotation> <documentation>Progression der Grunderkrankung</documentation> </annotation> </enumeration> <enumeration value="0204012"> <annotation> <documentation>ARM-D</documentation> </annotation> </enumeration> <enumeration value="0204013"> <annotation> <documentation>Verdacht auf allergische Reaktion</documentation> </annotation> </enumeration> <enumeration value="0204014"> <annotation> <documentation>Dislokation/Migration von Komponenten</documentation> </annotation> </enumeration> <enumeration value="0204015"> <annotation> <documentation>Bandinstabilität</documentation> </annotation> </enumeration> <enumeration value="0204016"> <annotation> <documentation>Bewegungseinschränkung</documentation> </annotation> </enumeration> <enumeration value="0204042"> <annotation> <documentation>andere Gründe</documentation> </annotation> </enumeration> </restriction> </simpleType> </pre>		

```
</annotation>
</enumeration>
<enumeration value="0204007">
  <annotation>
    <documentation>Verschleiß</documentation>
  </annotation>
</enumeration>
<enumeration value="0204008">
  <annotation>
    <documentation>Implantatbruch</documentation>
  </annotation>
</enumeration>
<enumeration value="0204009">
  <annotation>
    <documentation>Implantatfehlage/Malalignement</documentation>
  </annotation>
</enumeration>
<enumeration value="0204010">
  <annotation>
    <documentation>Osteolysen bei festem Implantat</documentation>
  </annotation>
</enumeration>
<enumeration value="0204011">
  <annotation>
    <documentation>Progression der Grunderkrankung</documentation>
  </annotation>
</enumeration>
<enumeration value="0204012">
  <annotation>
    <documentation>ARMD</documentation>
  </annotation>
</enumeration>
<enumeration value="0204013">
  <annotation>
    <documentation>Verdacht auf allergische Reaktion</documentation>
  </annotation>
</enumeration>
<enumeration value="0204014">
  <annotation>
    <documentation>Dislokation/Migration von Komponenten</documentation>
  </annotation>
</enumeration>
<enumeration value="0204015">
  <annotation>
    <documentation>Bandinstabilität</documentation>
  </annotation>
</enumeration>
<enumeration value="0204016">
  <annotation>
    <documentation>Bewegungseinschränkung</documentation>
  </annotation>
</enumeration>
<enumeration value="0204042">
  <annotation>
    <documentation>andere Gründe</documentation>
  </annotation>
</enumeration>
</restriction>
</simpleType>
```

simpleType enum 0206

namespace	http://xml.ir-d.de/irdma		
type	restriction of string		
properties	base xs:string		
facets	Kind	Value	Annotation
	enumeration	0206001	documentation Lockerung
	enumeration	0206002	documentation Infektion, Verdacht auf
	enumeration	0206003	documentation Infektion, gesichert
	enumeration	0206004	documentation Luxation, Inlay aus der Pfanne
	enumeration	0206005	documentation Luxation, Kopf aus Pfanne/Inlay
	enumeration	0206006	documentation Periprothetische Fraktur
	enumeration	0206007	documentation Verschleiß
	enumeration	0206008	documentation Implantatbruch
	enumeration	0206009	documentation Implantatfehlage/Malalignent
	enumeration	0206010	documentation Osteolysen bei festem Implantat
	enumeration	0206011	documentation Progression der Grunderkrankung
	enumeration	0206012	documentation ARMD
	enumeration	0206013	documentation Verdacht auf allergische Reaktion
	enumeration	0206014	documentation Dislokation/Migration von Komponenten
	enumeration	0206015	documentation Bandinstabilität
	enumeration	0206016	documentation Bewegungseinschränkung
	enumeration	0206042	documentation andere Gründe
annotation	documentation Kat_EP_GrundWechselTFE		
source	<pre> <simpleType name="enum_0206"> <annotation> <documentation>Kat_EP_GrundWechselTFE</documentation> </annotation> <restriction base="xs:string"> <enumeration value="0206001"> <annotation> <documentation>Lockerung</documentation> </annotation> </enumeration> <enumeration value="0206002"> <annotation> <documentation>Infektion, Verdacht auf</documentation> </annotation> </enumeration> <enumeration value="0206003"> <annotation> </pre>		

```
<documentation>Infektion, gesichert</documentation>
</annotation>
</enumeration>
<enumeration value="0206004">
  <annotation>
    <documentation>Luxation, Inlay aus der Pfanne</documentation>
  </annotation>
</enumeration>
<enumeration value="0206005">
  <annotation>
    <documentation>Luxation, Kopf aus Pfanne/Inlay</documentation>
  </annotation>
</enumeration>
<enumeration value="0206006">
  <annotation>
    <documentation>Periprothetische Fraktur</documentation>
  </annotation>
</enumeration>
<enumeration value="0206007">
  <annotation>
    <documentation>Verschleiß</documentation>
  </annotation>
</enumeration>
<enumeration value="0206008">
  <annotation>
    <documentation>Implantatbruch</documentation>
  </annotation>
</enumeration>
<enumeration value="0206009">
  <annotation>
    <documentation>Implantatfehllage/Malalignent</documentation>
  </annotation>
</enumeration>
<enumeration value="0206010">
  <annotation>
    <documentation>Osteolysen bei festem Implantat</documentation>
  </annotation>
</enumeration>
<enumeration value="0206011">
  <annotation>
    <documentation>Progression der Grunderkrankung</documentation>
  </annotation>
</enumeration>
<enumeration value="0206012">
  <annotation>
    <documentation>ARMD</documentation>
  </annotation>
</enumeration>
<enumeration value="0206013">
  <annotation>
    <documentation>Verdacht auf allergische Reaktion</documentation>
  </annotation>
</enumeration>
<enumeration value="0206014">
  <annotation>
    <documentation>Dislokation/Migration von Komponenten</documentation>
  </annotation>
</enumeration>
<enumeration value="0206015">
```

	<pre> <annotation> <documentation>Bandinstabilität</documentation> </annotation> </enumeration> <enumeration value="0206016"> <annotation> <documentation>Bewegungseinschränkung</documentation> </annotation> </enumeration> <enumeration value="0206042"> <annotation> <documentation>andere Gründe</documentation> </annotation> </enumeration> </restriction> </simpleType> </pre>
--	--

simpleType enum_0210

namespace	http://xml.ir-d.de/irdma		
type	restriction of string		
properties	base xs:string		
facets	Kind	Value	Annotation
	enumeration	0210001	documentation keine relevante Voroperation
	enumeration	0210002	documentation Osteosynthese/Osteotomie (Becken)
	enumeration	0210003	documentation Osteosynthese/Osteotomie (Femur)
	enumeration	0210004	documentation Osteosynthese/Osteotomie (beides)
	enumeration	0210005	documentation Operation bei Hüftkopfnekrose
	enumeration	0210006	documentation Arthrodese
	enumeration	0210042	documentation andere
annotation	documentation Kat_EP_VoroperationHuefte		
source	<pre> <simpleType name="enum_0210"> <annotation> <documentation>Kat_EP_VoroperationHuefte</documentation> </annotation> <restriction base="xs:string"> <enumeration value="0210001"> <annotation> <documentation>keine relevante Voroperation</documentation> </annotation> </enumeration> <enumeration value="0210002"> <annotation> <documentation>Osteosynthese/Osteotomie (Becken)</documentation> </annotation> </enumeration> <enumeration value="0210003"> <annotation> <documentation>Osteosynthese/Osteotomie (Femur)</documentation> </annotation> </enumeration> </restriction> </simpleType> </pre>		

	<pre> </annotation> </enumeration> <enumeration value="0210004"> <annotation> <documentation>Osteosynthese/Osteotomie (beides)</documentation> </annotation> </enumeration> <enumeration value="0210005"> <annotation> <documentation>Operation bei Hüftkopfnnekrose</documentation> </annotation> </enumeration> <enumeration value="0210006"> <annotation> <documentation>Arthrodese</documentation> </annotation> </enumeration> <enumeration value="0210042"> <annotation> <documentation>andere</documentation> </annotation> </enumeration> </restriction> </simpleType> </pre>
--	---

simpleType enum_0211

namespace	http://xml.ir-d.de/irdma		
type	restriction of string		
properties	base xs:string		
facets	Kind	Value	Annotation
	enumeration	0211001	documentation keine relevante Voroperation
	enumeration	0211002	documentation Osteosynthese/Osteotomie (Femur)
	enumeration	0211003	documentation Osteosynthese/Osteotomie (Tibia)
	enumeration	0211004	documentation Osteosynthese/Osteotomie (Patella)
	enumeration	0211005	documentation Osteosynthese/Osteotomie (mehrere)
	enumeration	0211006	documentation Kapsel-/Bandapparat
	enumeration	0211007	documentation Arthrodese
	enumeration	0211042	documentation andere
annotation	documentation Kat_EP_VoroperationKnie		
source	<pre> <simpleType name="enum_0211"> <annotation> <documentation>Kat_EP_VoroperationKnie</documentation> </annotation> <restriction base="xs:string"> <enumeration value="0211001"> <annotation> <documentation>keine relevante Voroperation</documentation> </annotation> </pre>		

```

</enumeration>
<enumeration value="0211002">
  <annotation>
    <documentation>Osteosynthese/Osteotomie (Femur)</documentation>
  </annotation>
</enumeration>
<enumeration value="0211003">
  <annotation>
    <documentation>Osteosynthese/Osteotomie (Tibia)</documentation>
  </annotation>
</enumeration>
<enumeration value="0211004">
  <annotation>
    <documentation>Osteosynthese/Osteotomie (Patella)</documentation>
  </annotation>
</enumeration>
<enumeration value="0211005">
  <annotation>
    <documentation>Osteosynthese/Osteotomie (mehrere)</documentation>
  </annotation>
</enumeration>
<enumeration value="0211006">
  <annotation>
    <documentation>Kapsel-/Bandapparat</documentation>
  </annotation>
</enumeration>
<enumeration value="0211007">
  <annotation>
    <documentation>Arthrodesse</documentation>
  </annotation>
</enumeration>
<enumeration value="0211042">
  <annotation>
    <documentation>andere</documentation>
  </annotation>
</enumeration>
</restriction>
</simpleType>

```

simpleType **enum_0212**

namespace	http://xml.ir-d.de/irdma		
type	restriction of string		
properties	base xs:string		
facets	Kind	Value	Annotation
	enumeration	0212001	documentation Hüfte
	enumeration	0212002	documentation Knie
	enumeration	0212003	documentation Totaler Femurersatz inkl. Durchsteck-Prothese
annotation	documentation Kat_EP_Gelenk		
source	<simpleType name="enum_0212"> <annotation> <documentation>Kat_EP_Gelenk</documentation> </annotation>		

	<pre> <restriction base="xs:string"> <enumeration value="0212001"> <annotation> <documentation>Hüfte</documentation> </annotation> </enumeration> <enumeration value="0212002"> <annotation> <documentation>Knie</documentation> </annotation> </enumeration> <enumeration value="0212003"> <annotation> <documentation>Totaler Femurersatz inkl. Durchsteck- Prothese</documentation> </annotation> </enumeration> </restriction> </simpleType> </pre>
--	---

simpleType enum 0220

namespace	http://xml.ir-d.de/irdma		
type	restriction of string		
properties	base xs:string		
facets	Kind	Value	Annotation
	enumeration	0220001	documentation anterior
	enumeration	0220002	documentation anterolateral
	enumeration	0220003	documentation lateral
	enumeration	0220004	documentation posterior
	enumeration	0220005	documentation posterolateral
	enumeration	0220006	documentation 2-Inzisionen-Zugang
	enumeration	0220042	documentation sonstiger
annotation	documentation Kat_EP_Operationszugang		
source	<pre> <simpleType name="enum_0220"> <annotation> <documentation>Kat_EP_Operationszugang</documentation> </annotation> <restriction base="xs:string"> <enumeration value="0220001"> <annotation> <documentation>anterior</documentation> </annotation> </enumeration> <enumeration value="0220002"> <annotation> <documentation>anterolateral</documentation> </annotation> </enumeration> </restriction> </pre>		

	<pre> <enumeration value="0220003"> <annotation> <documentation>lateral</documentation> </annotation> </enumeration> <enumeration value="0220004"> <annotation> <documentation>posterior</documentation> </annotation> </enumeration> <enumeration value="0220005"> <annotation> <documentation>posterolateral</documentation> </annotation> </enumeration> <enumeration value="0220006"> <annotation> <documentation>2-Inzisionen-Zugang</documentation> </annotation> </enumeration> <enumeration value="0220042"> <annotation> <documentation>sonstiger</documentation> </annotation> </enumeration> </restriction> </simpleType> </pre>
--	---

simpleType enum_0222

namespace	http://xml.ir-d.de/irdma		
type	restriction of string		
properties	base xs:string		
facets	Kind	Value	Annotation
	enumeration	0222001	documentation nein
	enumeration	0222002	documentation ja- Ausbau
	enumeration	0222003	documentation ja- Einbau
annotation	documentation Kat_EP_Zweizeitwechsel		
source	<pre> <simpleType name="enum_0222"> <annotation> <documentation>Kat_EP_Zweizeitwechsel</documentation> </annotation> <restriction base="xs:string"> <enumeration value="0222001"> <annotation> <documentation>nein</documentation> </annotation> </enumeration> <enumeration value="0222002"> <annotation> <documentation>ja- Ausbau</documentation> </annotation> </enumeration> </restriction> </simpleType> </pre>		

	<pre> <enumeration value="0222003"> <annotation> <documentation>ja- Einbau</documentation> </annotation> </enumeration> </restriction> </simpleType> </pre>
--	---

simpleType enum_0252

namespace	http://xml.ir-d.de/irdma		
type	restriction of string		
properties	base xs:string		
facets	Kind	Value	Annotation
	enumeration	0252001	documentation Pfanne
	enumeration	0252002	documentation Schaft
	enumeration	0252003	documentation beides
annotation	documentation Kat_EP_KomponenteHuefte		
source	<pre> <simpleType name="enum_0252"> <annotation> <documentation>Kat_EP_KomponenteHuefte</documentation> </annotation> <restriction base="xs:string"> <enumeration value="0252001"> <annotation> <documentation>Pfanne</documentation> </annotation> </enumeration> <enumeration value="0252002"> <annotation> <documentation>Schaft</documentation> </annotation> </enumeration> <enumeration value="0252003"> <annotation> <documentation>beides</documentation> </annotation> </enumeration> </restriction> </simpleType> </pre>		

simpleType enum_0254

namespace	http://xml.ir-d.de/irdma		
type	restriction of string		
properties	base xs:string		
facets	Kind	Value	Annotation
	enumeration	0254001	documentation Femur
	enumeration	0254002	documentation

	enumeration 0254003 Tibia documentation Patella enumeration 0254004 Tibia documentation mehrere
annotation	documentation Kat_EP_KomponenteKnie
source	<pre> <simpleType name="enum_0254"> <annotation> <documentation>Kat_EP_KomponenteKnie</documentation> </annotation> <restriction base="xs:string"> <enumeration value="0254001"> <annotation> <documentation>Femur</documentation> </annotation> </enumeration> <enumeration value="0254002"> <annotation> <documentation>Tibia</documentation> </annotation> </enumeration> <enumeration value="0254003"> <annotation> <documentation>Patella</documentation> </annotation> </enumeration> <enumeration value="0254004"> <annotation> <documentation>mehrere</documentation> </annotation> </enumeration> </restriction> </simpleType> </pre>

simpleType enum_0256

namespace	http://xml.ir-d.de/irdma		
type	restriction of string		
properties	base xs:string		
facets	Kind	Value	Annotation
	enumeration	0256001	documentation Pfanne
	enumeration	0256002	documentation Schaft
	enumeration	0256003	documentation Pfanne und Schaft
	enumeration	0256004	documentation Femur
	enumeration	0256005	documentation Tibia
	enumeration	0256006	documentation Patella
	enumeration	0256007	documentation mehrere
annotation	documentation Kat_EP_KomponenteTFE		

source	<pre> <simpleType name="enum_0256"> <annotation> <documentation>Kat_EP_KomponenteTFE</documentation> </annotation> <restriction base="xs:string"> <enumeration value="0256001"> <annotation> <documentation>Pfanne</documentation> </annotation> </enumeration> <enumeration value="0256002"> <annotation> <documentation>Schaft</documentation> </annotation> </enumeration> <enumeration value="0256003"> <annotation> <documentation>Pfanne und Schaft</documentation> </annotation> </enumeration> <enumeration value="0256004"> <annotation> <documentation>Femur</documentation> </annotation> </enumeration> <enumeration value="0256005"> <annotation> <documentation>Tibia</documentation> </annotation> </enumeration> <enumeration value="0256006"> <annotation> <documentation>Patella</documentation> </annotation> </enumeration> <enumeration value="0256007"> <annotation> <documentation>mehrere</documentation> </annotation> </enumeration> </restriction> </simpleType> </pre>
--------	--

simpleType enum_0262

namespace	http://xml.ir-d.de/irdma		
type	restriction of string		
properties	base xs:string		
facets	Kind	Value	Annotation
	enumeration	0262001	documentation Pfanne
	enumeration	0262002	documentation Schaft
	enumeration	0262003	documentation Kopf
	enumeration	0262004	documentation Inlay

	enumeration 0262005 documentation Adapter
	enumeration 0262006 documentation mehrere
annotation	documentation Kat_EP_ImplantatbruchHuefte
source	<pre> <simpleType name="enum_0262"> <annotation> <documentation>Kat_EP_ImplantatbruchHuefte</documentation> </annotation> <restriction base="xs:string"> <enumeration value="0262001"> <annotation> <documentation>Pfanne</documentation> </annotation> </enumeration> <enumeration value="0262002"> <annotation> <documentation>Schaft</documentation> </annotation> </enumeration> <enumeration value="0262003"> <annotation> <documentation>Kopf</documentation> </annotation> </enumeration> <enumeration value="0262004"> <annotation> <documentation>Inlay</documentation> </annotation> </enumeration> <enumeration value="0262005"> <annotation> <documentation>Adapter</documentation> </annotation> </enumeration> <enumeration value="0262006"> <annotation> <documentation>mehrere</documentation> </annotation> </enumeration> </restriction> </simpleType> </pre>

simpleType enum_0264

namespace	http://xml.ir-d.de/irdma		
type	restriction of string		
properties	base xs:string		
facets	Kind	Value	Annotation
	enumeration	0264001	documentation Femur
	enumeration	0264002	documentation Tibia
	enumeration	0264003	documentation Inlay
	enumeration	0264004	documentation

	<p>enumeration 0264005 Adapter documentation Verlängerung</p> <p>enumeration 0264006 documentation Schrauben</p> <p>enumeration 0264007 documentation mehrere</p> <p>enumeration 0264042 documentation andere</p>
annotation	documentation Kat_EP_ImplantatbruchKnie
source	<pre> <simpleType name="enum_0264"> <annotation> <documentation>Kat_EP_ImplantatbruchKnie</documentation> </annotation> <restriction base="xs:string"> <enumeration value="0264001"> <annotation> <documentation>Femur</documentation> </annotation> </enumeration> <enumeration value="0264002"> <annotation> <documentation>Tibia</documentation> </annotation> </enumeration> <enumeration value="0264003"> <annotation> <documentation>Inlay</documentation> </annotation> </enumeration> <enumeration value="0264004"> <annotation> <documentation>Adapter</documentation> </annotation> </enumeration> <enumeration value="0264005"> <annotation> <documentation>Verlängerung</documentation> </annotation> </enumeration> <enumeration value="0264006"> <annotation> <documentation>Schrauben</documentation> </annotation> </enumeration> <enumeration value="0264007"> <annotation> <documentation>mehrere</documentation> </annotation> </enumeration> <enumeration value="0264042"> <annotation> <documentation>andere</documentation> </annotation> </enumeration> </restriction> </simpleType> </pre>

simpleType enum_0266

namespace	http://xml.ir-d.de/irdma		
type	restriction of string		
properties	base xs:string		
facets	Kind	Value	Annotation
	enumeration	0266001	documentation Pfanne
	enumeration	0266002	documentation Schaft
	enumeration	0266003	documentation Kopf
	enumeration	0266004	documentation Inlay
	enumeration	0266005	documentation Adapter
	enumeration	0266006	documentation Femur
	enumeration	0266007	documentation Tibia
	enumeration	0266008	documentation Verlängerung
	enumeration	0266009	documentation Schrauben
	enumeration	0266010	documentation mehrere
	enumeration	0266042	documentation andere
annotation	documentation Kat_EP_ImplantatbruchTFE		
source	<pre> <simpleType name="enum_0266"> <annotation> <documentation>Kat_EP_ImplantatbruchTFE</documentation> </annotation> <restriction base="xs:string"> <enumeration value="0266001"> <annotation> <documentation>Pfanne</documentation> </annotation> </enumeration> <enumeration value="0266002"> <annotation> <documentation>Schaft</documentation> </annotation> </enumeration> <enumeration value="0266003"> <annotation> <documentation>Kopf</documentation> </annotation> </enumeration> <enumeration value="0266004"> <annotation> <documentation>Inlay</documentation> </annotation> </enumeration> <enumeration value="0266005"> <annotation> <documentation>Adapter</documentation> </annotation> </enumeration> </restriction> </simpleType> </pre>		

	<pre> </enumeration> <enumeration value="0266006"> <annotation> <documentation>Femur</documentation> </annotation> </enumeration> <enumeration value="0266007"> <annotation> <documentation>Tibia</documentation> </annotation> </enumeration> <enumeration value="0266008"> <annotation> <documentation>Verlängerung</documentation> </annotation> </enumeration> <enumeration value="0266009"> <annotation> <documentation>Schrauben</documentation> </annotation> </enumeration> <enumeration value="0266010"> <annotation> <documentation>mehrere</documentation> </annotation> </enumeration> <enumeration value="0266042"> <annotation> <documentation>andere</documentation> </annotation> </enumeration> </restriction> </simpleType> </pre>
--	--

simpleType enum_0270

namespace	http://xml.lir-d.de/irdma		
type	restriction of string		
properties	base xs:string		
facets	Kind	Value	Annotation
	enumeration	0270001	documentation PE-Inlay
	enumeration	0270002	documentation patellare Komponente
	enumeration	0270003	documentation beides
annotation	documentation Kat_EP_VerschleissKnie		
source	<pre> <simpleType name="enum_0270"> <annotation> <documentation>Kat_EP_VerschleissKnie</documentation> </annotation> <restriction base="xs:string"> <enumeration value="0270001"> <annotation> <documentation>PE-Inlay</documentation> </annotation> </pre>		

	<pre> </enumeration> <enumeration value="0270002"> <annotation> <documentation>patellare Komponente</documentation> </annotation> </enumeration> <enumeration value="0270003"> <annotation> <documentation>beides</documentation> </annotation> </enumeration> </restriction> </simpleType> </pre>
--	--

simpleType enum_0271

namespace	http://xml.ir-d.de/irdma		
type	restriction of string		
properties	base xs:string		
facets	Kind	Value	Annotation
	enumeration	0271001	documentation Schraube
	enumeration	0271002	documentation Inlay
	enumeration	0271003	documentation patellare Komponente
	enumeration	0271004	documentation Kopplung
	enumeration	0271005	documentation mehrere
	enumeration	0271042	documentation andere
annotation	documentation Kat_EP_MigrationKnie		
source	<pre> <simpleType name="enum_0271"> <annotation> <documentation>Kat_EP_MigrationKnie</documentation> </annotation> <restriction base="xs:string"> <enumeration value="0271001"> <annotation> <documentation>Schraube</documentation> </annotation> </enumeration> <enumeration value="0271002"> <annotation> <documentation>Inlay</documentation> </annotation> </enumeration> <enumeration value="0271003"> <annotation> <documentation>patellare Komponente</documentation> </annotation> </enumeration> <enumeration value="0271004"> <annotation> <documentation>Kopplung</documentation> </pre>		

	<pre> </annotation> </enumeration> <enumeration value="0271005"> <annotation> <documentation>mehrere</documentation> </annotation> </enumeration> <enumeration value="0271042"> <annotation> <documentation>andere</documentation> </annotation> </enumeration> </restriction> </simpleType> </pre>
--	---

simpleType enum_0280

namespace	http://xml.lir-d.de/irdma		
type	restriction of string		
properties	base xs:string		
facets	Kind	Value	Annotation
	enumeration	0280001	documentation Ohne
	enumeration	0280002	documentation PSI
	enumeration	0280003	documentation Navigation
	enumeration	0280004	documentation Robotik
	enumeration	0280042	documentation Unbekannt
annotation	documentation Kat_EP_AssistiveTechnologie		
source	<pre> <simpleType name="enum_0280"> <annotation> <documentation>Kat_EP_AssistiveTechnologie</documentation> </annotation> <restriction base="xs:string"> <enumeration value="0280001"> <annotation> <documentation>Ohne</documentation> </annotation> </enumeration> <enumeration value="0280002"> <annotation> <documentation>PSI</documentation> </annotation> </enumeration> <enumeration value="0280003"> <annotation> <documentation>Navigation</documentation> </annotation> </enumeration> <enumeration value="0280004"> <annotation> <documentation>Robotik</documentation> </annotation> </enumeration> </restriction> </simpleType> </pre>		

	<pre> </enumeration> <enumeration value="0280042"> <annotation> <documentation>Unbekannt</documentation> </annotation> </enumeration> </restriction> </simpleType> </pre>
--	---

simpleType enum_0281

namespace	http://xml.ir-d.de/irdma		
type	restriction of string		
properties	base xs:string		
facets	Kind	Value	Annotation
	enumeration	0281001	documentation Aesculap - OrthoPilot
	enumeration	0281002	documentation Amplitude - Amplivision
	enumeration	0281003	documentation Johnson & Johnson - VELYS
	enumeration	0281004	documentation Orthokey - Orthokey Miro
	enumeration	0281005	documentation Orthokey - BLU-IGS
	enumeration	0281006	documentation Smith & Nephew - Brainlab Plattformen (TBD)
	enumeration	0281007	documentation Stryker - Stryker NAV3i
	enumeration	0281008	documentation Stryker - Stryker Ortho Q Guidance System
	enumeration	0281009	documentation ThinkSurgical - TMINI
	enumeration	0281010	documentation Zimmer Biomet - Sesamoid Navigation
	enumeration	0281011	documentation Zimmer Biomet - iAssist Navigation
	enumeration	0281012	documentation nicht belegter Wert
	enumeration	0281013	documentation nicht belegter Wert
	enumeration	0281014	documentation nicht belegter Wert
	enumeration	0281015	documentation nicht belegter Wert
	enumeration	0281016	documentation nicht belegter Wert
	enumeration	0281042	documentation sonstige
annotation	documentation Kat_EP_Navigation		
source	<pre> <simpleType name="enum_0281"> <annotation> <documentation>Kat_EP_Navigation</documentation> </annotation> <restriction base="xs:string"> <enumeration value="0281001"> <annotation> <documentation>Aesculap - OrthoPilot</documentation> </pre>		

```
</annotation>
</enumeration>
<enumeration value="0281002">
  <annotation>
    <documentation>Amplitude - Amplivision</documentation>
  </annotation>
</enumeration>
<enumeration value="0281003">
  <annotation>
    <documentation>Johnson & Johnson - VELYS</documentation>
  </annotation>
</enumeration>
<enumeration value="0281004">
  <annotation>
    <documentation>Orthokey - Orthokey Miro</documentation>
  </annotation>
</enumeration>
<enumeration value="0281005">
  <annotation>
    <documentation>Orthokey - BLU-IGS</documentation>
  </annotation>
</enumeration>
<enumeration value="0281006">
  <annotation>
    <documentation>Smith & Nephew - Brainlab Plattformen
(TBD)</documentation>
  </annotation>
</enumeration>
<enumeration value="0281007">
  <annotation>
    <documentation>Stryker - Stryker NAV3i</documentation>
  </annotation>
</enumeration>
<enumeration value="0281008">
  <annotation>
    <documentation>Stryker - Stryker Ortho Q Guidance
System</documentation>
  </annotation>
</enumeration>
<enumeration value="0281009">
  <annotation>
    <documentation>ThinkSurgical - TMINI</documentation>
  </annotation>
</enumeration>
<enumeration value="0281010">
  <annotation>
    <documentation>Zimmer Biomet - Sesamoid Navigation</documentation>
  </annotation>
</enumeration>
<enumeration value="0281011">
  <annotation>
    <documentation>Zimmer Biomet - iAssist Navigation</documentation>
  </annotation>
</enumeration>
<enumeration value="0281012">
  <annotation>
    <documentation>nicht belegter Wert</documentation>
  </annotation>
</enumeration>
```

```

<enumeration value="0281013">
  <annotation>
    <documentation>nicht belegter Wert</documentation>
  </annotation>
</enumeration>
<enumeration value="0281014">
  <annotation>
    <documentation>nicht belegter Wert</documentation>
  </annotation>
</enumeration>
<enumeration value="0281015">
  <annotation>
    <documentation>nicht belegter Wert</documentation>
  </annotation>
</enumeration>
<enumeration value="0281016">
  <annotation>
    <documentation>nicht belegter Wert</documentation>
  </annotation>
</enumeration>
<enumeration value="0281042">
  <annotation>
    <documentation>sonstige</documentation>
  </annotation>
</enumeration>
</restriction>
</simpleType>

```

simpleType enum_0282

namespace	http://xml.ir-d.de/irdma		
type	restriction of string		
properties	base xs:string		
facets	Kind	Value	Annotation
	enumeration	0282001	documentation Amplitude - Andy
	enumeration	0282002	documentation Corin - ApolloKnee
	enumeration	0282003	documentation Corin - OMNIBotics
	enumeration	0282004	documentation Microport - Skywalker
	enumeration	0282005	documentation Orthokey - Orthokey Robin
	enumeration	0282006	documentation Smith & Nephew - CORI
	enumeration	0282007	documentation Smith & Nephew - NAVIO
	enumeration	0282008	documentation Stryker - Mako SmartRobotics
	enumeration	0282009	documentation Zimmer Biomet - ROSA
	enumeration	0282010	documentation Johnson & Johnson - VELYS Robotic Assisted Solution
	enumeration	0282011	documentation nicht belegter Wert
	enumeration	0282012	documentation nicht belegter Wert
	enumeration	0282013	documentation

	<p>enumeration 0282014 nicht belegter Wert documentation</p> <p>enumeration 0282015 nicht belegter Wert documentation</p> <p>enumeration 0282042 nicht belegter Wert documentation sonstige</p>
annotation	documentation Kat_EP_Robotik
source	<pre> <simpleType name="enum_0282"> <annotation> <documentation>Kat_EP_Robotik</documentation> </annotation> <restriction base="xs:string"> <enumeration value="0282001"> <annotation> <documentation>Amplitude - Andy</documentation> </annotation> </enumeration> <enumeration value="0282002"> <annotation> <documentation>Corin - ApolloKnee</documentation> </annotation> </enumeration> <enumeration value="0282003"> <annotation> <documentation>Corin - OMNIBotics</documentation> </annotation> </enumeration> <enumeration value="0282004"> <annotation> <documentation>Microport - Skywalker</documentation> </annotation> </enumeration> <enumeration value="0282005"> <annotation> <documentation>Orthokey - Orthokey Robin</documentation> </annotation> </enumeration> <enumeration value="0282006"> <annotation> <documentation>Smith & Nephew - CORI</documentation> </annotation> </enumeration> <enumeration value="0282007"> <annotation> <documentation>Smith & Nephew - NAVIO</documentation> </annotation> </enumeration> <enumeration value="0282008"> <annotation> <documentation>Stryker - Mako SmartRobotics</documentation> </annotation> </enumeration> <enumeration value="0282009"> <annotation> <documentation>Zimmer Biomet - ROSA</documentation> </annotation> </enumeration> </restriction> </simpleType> </pre>

```

<enumeration value="0282010">
  <annotation>
    <documentation>Johnson & Johnson - VELYS Robotic Assisted
Solution</documentation>
  </annotation>
</enumeration>
<enumeration value="0282011">
  <annotation>
    <documentation>nicht belegter Wert</documentation>
  </annotation>
</enumeration>
<enumeration value="0282012">
  <annotation>
    <documentation>nicht belegter Wert</documentation>
  </annotation>
</enumeration>
<enumeration value="0282013">
  <annotation>
    <documentation>nicht belegter Wert</documentation>
  </annotation>
</enumeration>
<enumeration value="0282014">
  <annotation>
    <documentation>nicht belegter Wert</documentation>
  </annotation>
</enumeration>
<enumeration value="0282015">
  <annotation>
    <documentation>nicht belegter Wert</documentation>
  </annotation>
</enumeration>
<enumeration value="0282042">
  <annotation>
    <documentation>sonstige</documentation>
  </annotation>
</enumeration>
</restriction>
</simpleType>

```

simpleType enum 0290

namespace	http://xml.ir-d.de/irdma		
type	restriction of string		
properties	base xs:string		
facets	Kind	Value	Annotation
	enumeration	0290001	documentation Hüft-Komponente
	enumeration	0290002	documentation Knie-Komponente
	enumeration	0290003	documentation Modulare Komponente (Hüfte/Knie)
	enumeration	0290004	documentation Knochenzement
	enumeration	0290042	documentation sonstiger
annotation	documentation Kat_EP_Artikeltyp		

source	<pre> <simpleType name="enum_0290"> <annotation> <documentation>Kat_EP_Artikeltyp</documentation> </annotation> <restriction base="xs:string"> <enumeration value="0290001"> <annotation> <documentation>Hüft-Komponente</documentation> </annotation> </enumeration> <enumeration value="0290002"> <annotation> <documentation>Knie-Komponente</documentation> </annotation> </enumeration> <enumeration value="0290003"> <annotation> <documentation>Modulare Komponente (Hüfte/Knie)</documentation> </annotation> </enumeration> <enumeration value="0290004"> <annotation> <documentation>Knochenzement</documentation> </annotation> </enumeration> <enumeration value="0290042"> <annotation> <documentation>sonstiger</documentation> </annotation> </enumeration> </restriction> </simpleType> </pre>
--------	--

simpleType enum_0292

namespace	http://xml.ir-d.de/irdma		
type	restriction of string		
properties	base xs:string		
facets	Kind	Value	Annotation
	enumeration	0292001	documentation Pfanne
	enumeration	0292002	documentation Inlay
	enumeration	0292003	documentation Kopf
	enumeration	0292004	documentation Schaft
	enumeration	0292005	documentation Vormontierte Acetabularkomponente (Pfanne mit Inlay)
	enumeration	0292006	documentation Einteilige Femoralkomponente (Schaft mit Kopf)
	enumeration	0292042	documentation sonstiger
annotation	documentation Kat_EP_ArtikeltypHuefte		
source	<pre> <simpleType name="enum_0292"> <annotation> </pre>		

```

<documentation>Kat_EP_ArtikeltypHuefte</documentation>
</annotation>
<restriction base="xs:string">
  <enumeration value="0292001">
    <annotation>
      <documentation>Pfanne</documentation>
    </annotation>
  </enumeration>
  <enumeration value="0292002">
    <annotation>
      <documentation>Inlay</documentation>
    </annotation>
  </enumeration>
  <enumeration value="0292003">
    <annotation>
      <documentation>Kopf</documentation>
    </annotation>
  </enumeration>
  <enumeration value="0292004">
    <annotation>
      <documentation>Schaft</documentation>
    </annotation>
  </enumeration>
  <enumeration value="0292005">
    <annotation>
      <documentation>Vormontierte Acetabularkomponente (Pfanne mit
Inlay)</documentation>
    </annotation>
  </enumeration>
  <enumeration value="0292006">
    <annotation>
      <documentation>Einteilige Femoralkomponente (Schaft mit
Kopf)</documentation>
    </annotation>
  </enumeration>
  <enumeration value="0292042">
    <annotation>
      <documentation>sonstiger</documentation>
    </annotation>
  </enumeration>
</restriction>
</simpleType>

```

simpleType enum_0293

namespace	http://xml.ir-d.de/irdma		
type	restriction of string		
properties	base xs:string		
facets	Kind	Value	Annotation
	enumeration	0293001	documentation Tibiakomponente
	enumeration	0293002	documentation Femurkomponente
	enumeration	0293003	documentation Patella
	enumeration	0293004	documentation Insert

	enumeration 0293005 documentation Vormontierte Tibiakomponente mit Insert enumeration 0293042 documentation sonstiger
annotation	documentation Kat_EP_ArtikeltypKnie
source	<pre> <simpleType name="enum_0293"> <annotation> <documentation>Kat_EP_ArtikeltypKnie</documentation> </annotation> <restriction base="xs:string"> <enumeration value="0293001"> <annotation> <documentation>Tibiakomponente</documentation> </annotation> </enumeration> <enumeration value="0293002"> <annotation> <documentation>Femurkomponente</documentation> </annotation> </enumeration> <enumeration value="0293003"> <annotation> <documentation>Patella</documentation> </annotation> </enumeration> <enumeration value="0293004"> <annotation> <documentation>Insert</documentation> </annotation> </enumeration> <enumeration value="0293005"> <annotation> <documentation>Vormontierte Tibiakomponente mit Insert</documentation> </annotation> </enumeration> <enumeration value="0293042"> <annotation> <documentation>sonstiger</documentation> </annotation> </enumeration> </restriction> </simpleType> </pre>

simpleType enum_0300

namespace	http://xml.ir-d.de/irdma		
type	restriction of string		
properties	base xs:string		
facets	Kind	Value	Annotation
	enumeration	0300001	documentation konventioneller Aortenklappenersatz
	enumeration	0300002	documentation kathetergestützte Aortenklappenimplantation (TAVI)
annotation	documentation Kat_AK_ArtEingriff		

source	<pre> <simpleType name="enum_0300"> <annotation> <documentation>Kat_AK_ArtEingriff</documentation> </annotation> <restriction base="xs:string"> <enumeration value="0300001"> <annotation> <documentation>konventioneller Aortenklappenersatz</documentation> </annotation> </enumeration> <enumeration value="0300002"> <annotation> <documentation>kathetergestützte Aortenklappenimplantation (TAVI)</documentation> </annotation> </enumeration> </restriction> </simpleType> </pre>
--------	--

simpleType enum_0301

namespace	http://xml.ir-d.de/irdma		
type	restriction of string		
properties	base xs:string		
facets	Kind	Value	Annotation
	enumeration	0301001	documentation produktbezogen
	enumeration	0301002	documentation nicht-produktbezogen
annotation	documentation Kat_AK_GrundAbbruch		
source	<pre> <simpleType name="enum_0301"> <annotation> <documentation>Kat_AK_GrundAbbruch</documentation> </annotation> <restriction base="xs:string"> <enumeration value="0301001"> <annotation> <documentation>produktbezogen</documentation> </annotation> </enumeration> <enumeration value="0301002"> <annotation> <documentation>nicht-produktbezogen</documentation> </annotation> </enumeration> </restriction> </simpleType> </pre>		

simpleType enum_0302

namespace	http://xml.ir-d.de/irdma		
type	restriction of string		
properties	base xs:string		

facets	<table border="1"> <thead> <tr> <th>Kind</th> <th>Value</th> <th>Annotation</th> </tr> </thead> <tbody> <tr> <td>enumeration</td> <td>0302001</td> <td>documentation Stenose</td> </tr> <tr> <td>enumeration</td> <td>0302002</td> <td>documentation Insuffizienz</td> </tr> <tr> <td>enumeration</td> <td>0302003</td> <td>documentation Stenose und Insuffizienz</td> </tr> <tr> <td>enumeration</td> <td>0302042</td> <td>documentation sonstiger</td> </tr> </tbody> </table>	Kind	Value	Annotation	enumeration	0302001	documentation Stenose	enumeration	0302002	documentation Insuffizienz	enumeration	0302003	documentation Stenose und Insuffizienz	enumeration	0302042	documentation sonstiger
Kind	Value	Annotation														
enumeration	0302001	documentation Stenose														
enumeration	0302002	documentation Insuffizienz														
enumeration	0302003	documentation Stenose und Insuffizienz														
enumeration	0302042	documentation sonstiger														
annotation	documentation Kat_AK_GrundEingriff															
source	<pre> <simpleType name="enum_0302"> <annotation> <documentation>Kat_AK_GrundEingriff</documentation> </annotation> <restriction base="xs:string"> <enumeration value="0302001"> <annotation> <documentation>Stenose</documentation> </annotation> </enumeration> <enumeration value="0302002"> <annotation> <documentation>Insuffizienz</documentation> </annotation> </enumeration> <enumeration value="0302003"> <annotation> <documentation>Stenose und Insuffizienz</documentation> </annotation> </enumeration> <enumeration value="0302042"> <annotation> <documentation>sonstiger</documentation> </annotation> </enumeration> </restriction> </simpleType> </pre>															

simpleType enum_0318

namespace	http://xml.ir-d.de/irdma																		
type	restriction of string																		
properties	base xs:string																		
facets	<table border="1"> <thead> <tr> <th>Kind</th> <th>Value</th> <th>Annotation</th> </tr> </thead> <tbody> <tr> <td>enumeration</td> <td>0318001</td> <td>documentation transapikal</td> </tr> <tr> <td>enumeration</td> <td>0318002</td> <td>documentation transaortal</td> </tr> <tr> <td>enumeration</td> <td>0318003</td> <td>documentation transfemoral</td> </tr> <tr> <td>enumeration</td> <td>0318004</td> <td>documentation transaxillär</td> </tr> <tr> <td>enumeration</td> <td>0318042</td> <td>documentation anderer Zugangsweg</td> </tr> </tbody> </table>	Kind	Value	Annotation	enumeration	0318001	documentation transapikal	enumeration	0318002	documentation transaortal	enumeration	0318003	documentation transfemoral	enumeration	0318004	documentation transaxillär	enumeration	0318042	documentation anderer Zugangsweg
Kind	Value	Annotation																	
enumeration	0318001	documentation transapikal																	
enumeration	0318002	documentation transaortal																	
enumeration	0318003	documentation transfemoral																	
enumeration	0318004	documentation transaxillär																	
enumeration	0318042	documentation anderer Zugangsweg																	
annotation	documentation Kat_AK_ZugangKatheter																		

source	<pre> <simpleType name="enum_0318"> <annotation> <documentation>Kat_AK_ZugangKatheter</documentation> </annotation> <restriction base="xs:string"> <enumeration value="0318001"> <annotation> <documentation>transapikal</documentation> </annotation> </enumeration> <enumeration value="0318002"> <annotation> <documentation>transaortal</documentation> </annotation> </enumeration> <enumeration value="0318003"> <annotation> <documentation>transfemorale</documentation> </annotation> </enumeration> <enumeration value="0318004"> <annotation> <documentation>transaxillär</documentation> </annotation> </enumeration> <enumeration value="0318042"> <annotation> <documentation>anderer Zugangsweg</documentation> </annotation> </enumeration> </restriction> </simpleType> </pre>
--------	---

simpleType enum_0320

namespace	http://xml.ir-d.de/irdma		
type	restriction of string		
properties	base xs:string		
facets	Kind	Value	Annotation
	enumeration	0320001	documentation konventionelle Sternotomie
	enumeration	0320002	documentation partielle Sternotomie
	enumeration	0320003	documentation parasternaler Zugang
	enumeration	0320042	documentation anderer Zugangsweg
annotation	documentation Kat_AK_ZugangKonventionell		
source	<pre> <simpleType name="enum_0320"> <annotation> <documentation>Kat_AK_ZugangKonventionell</documentation> </annotation> <restriction base="xs:string"> <enumeration value="0320001"> <annotation> <documentation>konventionelle Sternotomie</documentation> </pre>		

	<pre> </annotation> </enumeration> <enumeration value="0320002"> <annotation> <documentation>partielle Sternotomie</documentation> </annotation> </enumeration> <enumeration value="0320003"> <annotation> <documentation>parasternaler Zugang</documentation> </annotation> </enumeration> <enumeration value="0320042"> <annotation> <documentation>anderer Zugangsweg</documentation> </annotation> </enumeration> </restriction> </simpleType> </pre>
--	---

simpleType enum 0322

namespace	http://xml.ir-d.de/irdma		
type	restriction of string		
properties	base xs:string		
facets	Kind	Value	Annotation
	enumeration	0322001	documentation nein
	enumeration	0322002	documentation ja, diätetisch behandelt
	enumeration	0322003	documentation ja, orale Medikation
	enumeration	0322004	documentation ja, mit Insulin behandelt
	enumeration	0322005	documentation ja, unbehandelt
	enumeration	0322099	documentation unbekannt
annotation	documentation Kat_AK_Diabetes		
source	<pre> <simpleType name="enum_0322"> <annotation> <documentation>Kat_AK_Diabetes</documentation> </annotation> <restriction base="xs:string"> <enumeration value="0322001"> <annotation> <documentation>nein</documentation> </annotation> </enumeration> <enumeration value="0322002"> <annotation> <documentation>ja, diätetisch behandelt</documentation> </annotation> </enumeration> <enumeration value="0322003"> <annotation> </pre>		

	<pre> <documentation>ja, orale Medikation</documentation> </annotation> </enumeration> <enumeration value="0322004"> <annotation> <documentation>ja, mit Insulin behandelt</documentation> </annotation> </enumeration> <enumeration value="0322005"> <annotation> <documentation>ja, unbehandelt</documentation> </annotation> </enumeration> <enumeration value="0322099"> <annotation> <documentation>unbekannt</documentation> </annotation> </enumeration> </restriction> </simpleType> </pre>
--	---

simpleType enum_0324

namespace	http://xml.ir-d.de/irdma		
type	restriction of string		
properties	base xs:string		
facets	Kind	Value	Annotation
	enumeration	0324001	documentation (I): Beschwerdefreiheit, normale körperliche Belastbarkeit
	enumeration	0324002	documentation (II): Beschwerden bei stärkerer körperlicher Belastung
	enumeration	0324003	documentation (III): Beschwerden bei leichter körperlicher Belastung
	enumeration	0324004	documentation (IV): Beschwerden in Ruhe
annotation	documentation Kat_AK_NYHA		
source	<pre> <simpleType name="enum_0324"> <annotation> <documentation>Kat_AK_NYHA</documentation> </annotation> <restriction base="xs:string"> <enumeration value="0324001"> <annotation> <documentation>(I): Beschwerdefreiheit, normale körperliche Belastbarkeit</documentation> </annotation> </enumeration> <enumeration value="0324002"> <annotation> <documentation>(II): Beschwerden bei stärkerer körperlicher Belastung</documentation> </annotation> </enumeration> <enumeration value="0324003"> <annotation> <documentation>(III): Beschwerden bei leichter körperlicher </pre>		

	<pre> Belastung</documentation> </annotation> </enumeration> <enumeration value="0324004"> <annotation> <documentation>(IV): Beschwerden in Ruhe</documentation> </annotation> </enumeration> </restriction> </simpleType> </pre>
--	---

simpleType enum_0338

namespace	http://xml.ir-d.de/irdma		
type	restriction of string		
properties	base xs:string		
facets	Kind	Value	Annotation
	enumeration	0338001	documentation LAD
	enumeration	0338002	documentation RCA
	enumeration	0338003	documentation RCX
	enumeration	0338004	documentation Hauptstamm
annotation	documentation Kat_AK_PCIArterien		
source	<pre> <simpleType name="enum_0338"> <annotation> <documentation>Kat_AK_PCIArterien</documentation> </annotation> <restriction base="xs:string"> <enumeration value="0338001"> <annotation> <documentation>LAD</documentation> </annotation> </enumeration> <enumeration value="0338002"> <annotation> <documentation>RCA</documentation> </annotation> </enumeration> <enumeration value="0338003"> <annotation> <documentation>RCX</documentation> </annotation> </enumeration> <enumeration value="0338004"> <annotation> <documentation>Hauptstamm</documentation> </annotation> </enumeration> </restriction> </simpleType> </pre>		

simpleType enum_0339

namespace	http://xml.ir-d.de/irdma		
type	restriction of string		
properties	base xs:string		
facets	Kind	Value	Annotation
	enumeration	0339001	documentation TEE
	enumeration	0339002	documentation CT
	enumeration	0339042	documentation andere
annotation	documentation Kat_AK_AnnulusMessmethode		
source	<pre> <simpleType name="enum_0339"> <annotation> <documentation>Kat_AK_AnnulusMessmethode</documentation> </annotation> <restriction base="xs:string"> <enumeration value="0339001"> <annotation> <documentation>TEE</documentation> </annotation> </enumeration> <enumeration value="0339002"> <annotation> <documentation>CT</documentation> </annotation> </enumeration> <enumeration value="0339042"> <annotation> <documentation>andere</documentation> </annotation> </enumeration> </restriction> </simpleType> </pre>		

simpleType enum_0341

namespace	http://xml.ir-d.de/irdma		
type	restriction of string		
properties	base xs:string		
facets	Kind	Value	Annotation
	enumeration	0341001	documentation intraprozedural verstorben
	enumeration	0341002	documentation Implantation von mehr als einer Prothese
	enumeration	0341003	documentation gravierende Gefäß- oder Zugangskomplikation (gemäß VARC-3)
	enumeration	0341004	documentation erforderlicher chirurgischer oder interventioneller Eingriff wegen einer Klappenfehlfunktion (gemäß VARC-3)
	enumeration	0341005	documentation >= große strukturelle kardiale Komplikation (gemäß VARC-3)
annotation	documentation Kat_AK_FailureGrund		

source	<pre> <simpleType name="enum_0341"> <annotation> <documentation>Kat_AK_FailureGrund</documentation> </annotation> <restriction base="xs:string"> <enumeration value="0341001"> <annotation> <documentation>intraprozedural verstorben</documentation> </annotation> </enumeration> <enumeration value="0341002"> <annotation> <documentation>Implantation von mehr als einer Prothese</documentation> </annotation> </enumeration> <enumeration value="0341003"> <annotation> <documentation>gravierende Gefäß- oder Zugangskomplikation (gemäß VARC-3)</documentation> </annotation> </enumeration> <enumeration value="0341004"> <annotation> <documentation>erforderlicher chirurgischer oder interventioneller Eingriff wegen einer Klappenfehlfunktion (gemäß VARC-3)</documentation> </annotation> </enumeration> <enumeration value="0341005"> <annotation> <documentation>&gt;= große strukturelle kardiale Komplikation (gemäß VARC-3)</documentation> </annotation> </enumeration> </restriction> </simpleType> </pre>
--------	--

simpleType enum_0342

namespace	http://xml.ir-d.de/irdma		
type	restriction of string		
properties	base xs:string		
facets	Kind	Value	Annotation
	enumeration	0342001	documentation Alter
	enumeration	0342002	documentation Frailty
	enumeration	0342003	documentation Hochrisiko
	enumeration	0342004	documentation Prognose-limitierende Zweiterkrankung
	enumeration	0342005	documentation Porzellan-Aorta
	enumeration	0342042	documentation sonstiger
annotation	documentation Kat_AK_Tavi		

source	<pre> <simpleType name="enum_0342"> <annotation> <documentation>Kat_AK_Tavi</documentation> </annotation> <restriction base="xs:string"> <enumeration value="0342001"> <annotation> <documentation>Alter</documentation> </annotation> </enumeration> <enumeration value="0342002"> <annotation> <documentation>Frailty</documentation> </annotation> </enumeration> <enumeration value="0342003"> <annotation> <documentation>Hochrisiko</documentation> </annotation> </enumeration> <enumeration value="0342004"> <annotation> <documentation>Prognose-limitierende Zweiterkrankung</documentation> </annotation> </enumeration> <enumeration value="0342005"> <annotation> <documentation>Porzellan-Aorta</documentation> </annotation> </enumeration> <enumeration value="0342042"> <annotation> <documentation>sonstiger</documentation> </annotation> </enumeration> </restriction> </simpleType> </pre>
--------	---

simpleType enum_0343

namespace	http://xml.ir-d.de/irdma		
type	restriction of string		
properties	base xs:string		
facets	Kind	Value	Annotation
	enumeration	0343001	documentation Device-Fehlpositionierung
	enumeration	0343002	documentation Koronarostienverschluss
	enumeration	0343003	documentation Aortendissektion
	enumeration	0343004	documentation Aortenregurgitation > = 2. Grades
	enumeration	0343005	documentation Annulus-Ruptur
	enumeration	0343006	documentation Ruptur-/Perforation einer Herzhöhle ohne Therapiebedarf
	enumeration	0343007	documentation

	<p>enumeration 0343008 Ruptur-/Perforation einer Herzhöhle mit Therapiebedarf documentation Perikardtamponade</p> <p>enumeration 0343009 documentation kardiale Dekompensation</p> <p>enumeration 0343010 documentation Hirnembolie</p> <p>enumeration 0343011 documentation Rhythmusstörungen</p> <p>enumeration 0343012 documentation Device-Embolisation</p> <p>enumeration 0343013 documentation vaskuläre Komplikation</p> <p>enumeration 0343014 documentation Low Cardiac Output</p> <p>enumeration 0343015 documentation schwerwiegende Blutungen (intraprozedural)</p> <p>enumeration 0343016 documentation lebensbedrohliche Blutungen (intraprozedural)</p> <p>enumeration 0343017 documentation Patient verstarb im OP/Katheterlabor</p> <p>enumeration 0343042 documentation sonstiger</p>
annotation	documentation Kat_AK_KomplikationTyp
source	<pre> <simpleType name="enum_0343"> <annotation> <documentation>Kat_AK_KomplikationTyp</documentation> </annotation> <restriction base="xs:string"> <enumeration value="0343001"> <annotation> <documentation>Device-Fehlpositionierung</documentation> </annotation> </enumeration> <enumeration value="0343002"> <annotation> <documentation>Koronarostienverschluss</documentation> </annotation> </enumeration> <enumeration value="0343003"> <annotation> <documentation>Aortendissektion</documentation> </annotation> </enumeration> <enumeration value="0343004"> <annotation> <documentation>Aortenregurgitation &gt; = 2. Grades</documentation> </annotation> </enumeration> <enumeration value="0343005"> <annotation> <documentation>Annulus-Ruptur</documentation> </annotation> </enumeration> <enumeration value="0343006"> <annotation> <documentation>Ruptur-/Perforation einer Herzhöhle ohne Therapiebedarf</documentation> </annotation> </enumeration> </restriction> </simpleType> </pre>

```

<enumeration value="0343007">
  <annotation>
    <documentation>Ruptur-/Perforation einer Herzhöhle mit
Therapiebedarf</documentation>
  </annotation>
</enumeration>
<enumeration value="0343008">
  <annotation>
    <documentation>Perikardtamponade</documentation>
  </annotation>
</enumeration>
<enumeration value="0343009">
  <annotation>
    <documentation>kardiale Dekompensation</documentation>
  </annotation>
</enumeration>
<enumeration value="0343010">
  <annotation>
    <documentation>Hirnembolie</documentation>
  </annotation>
</enumeration>
<enumeration value="0343011">
  <annotation>
    <documentation>Rhythmusstörungen</documentation>
  </annotation>
</enumeration>
<enumeration value="0343012">
  <annotation>
    <documentation>Device-Embolisation</documentation>
  </annotation>
</enumeration>
<enumeration value="0343013">
  <annotation>
    <documentation>vaskuläre Komplikation</documentation>
  </annotation>
</enumeration>
<enumeration value="0343014">
  <annotation>
    <documentation>Low Cardiac Output</documentation>
  </annotation>
</enumeration>
<enumeration value="0343015">
  <annotation>
    <documentation>schwerwiegende Blutungen
(intraprozedural)</documentation>
  </annotation>
</enumeration>
<enumeration value="0343016">
  <annotation>
    <documentation>lebensbedrohliche Blutungen
(intraprozedural)</documentation>
  </annotation>
</enumeration>
<enumeration value="0343017">
  <annotation>
    <documentation>Patient verstarb im OP/Katheterlabor</documentation>
  </annotation>
</enumeration>
<enumeration value="0343042">

```

	<pre> <annotation> <documentation>sonstiger</documentation> </annotation> </enumeration> </restriction> </simpleType> </pre>
--	--

simpleType enum_0346

namespace	http://xml.ir-d.de/irdma		
type	restriction of string		
properties	base xs:string		
facets	Kind	Value	Annotation
	enumeration	0346001	documentation keine Therapie erforderlich
	enumeration	0346002	documentation medikamentös
	enumeration	0346003	documentation IABP
	enumeration	0346004	documentation VAD
	enumeration	0346005	documentation ECMO
	enumeration	0346042	documentation sonstige
annotation	documentation Kat AK TherapieLCO		
source	<pre> <simpleType name="enum_0346"> <annotation> <documentation>Kat_AK_TherapieLCO</documentation> </annotation> <restriction base="xs:string"> <enumeration value="0346001"> <annotation> <documentation>keine Therapie erforderlich</documentation> </annotation> </enumeration> <enumeration value="0346002"> <annotation> <documentation>medikamentös</documentation> </annotation> </enumeration> <enumeration value="0346003"> <annotation> <documentation>IABP</documentation> </annotation> </enumeration> <enumeration value="0346004"> <annotation> <documentation>VAD</documentation> </annotation> </enumeration> <enumeration value="0346005"> <annotation> <documentation>ECMO</documentation> </annotation> </enumeration> </restriction> </simpleType> </pre>		

	<pre> <enumeration value="0346042"> <annotation> <documentation>sonstige</documentation> </annotation> </enumeration> </restriction> </simpleType> </pre>
--	---

simpleType enum_0347

namespace	http://xml.ir-d.de/irdma		
type	restriction of string		
properties	base xs:string		
facets	Kind	Value	Annotation
	enumeration	0347001	documentation Einzeleingriff
	enumeration	0347002	documentation Kombinationseingriff mit mehreren Prozeduren
annotation	documentation Kat_AK_Eingriffsumfang		
source	<pre> <simpleType name="enum_0347"> <annotation> <documentation>Kat_AK_Eingriffsumfang</documentation> </annotation> <restriction base="xs:string"> <enumeration value="0347001"> <annotation> <documentation>Einzeleingriff</documentation> </annotation> </enumeration> <enumeration value="0347002"> <annotation> <documentation>Kombinationseingriff mit mehreren Prozeduren</documentation> </annotation> </enumeration> </restriction> </simpleType> </pre>		

simpleType enum_0348

namespace	http://xml.ir-d.de/irdma		
type	restriction of string		
properties	base xs:string		
facets	Kind	Value	Annotation
	enumeration	0348001	documentation mit HLM
	enumeration	0348002	documentation ohne HLM
	enumeration	0348003	documentation Umstieg von OP ohne HLM auf OP mit HLM
annotation	documentation Kat_AK_OPVorgehen		
source	<pre> <simpleType name="enum_0348"> </pre>		

	<pre> <annotation> <documentation>Kat_AK_OPVorgehen</documentation> </annotation> <restriction base="xs:string"> <enumeration value="0348001"> <annotation> <documentation>mit HLM</documentation> </annotation> </enumeration> <enumeration value="0348002"> <annotation> <documentation>ohne HLM</documentation> </annotation> </enumeration> <enumeration value="0348003"> <annotation> <documentation>Umstieg von OP ohne HLM auf OP mit HLM</documentation> </annotation> </enumeration> </restriction> </simpleType> </pre>
--	---

simpleType enum 0350

namespace	http://xml.ir-d.de/irdma		
type	restriction of string		
properties	base xs:string		
facets	Kind	Value	Annotation
	enumeration	0350001	documentation IABP
	enumeration	0350002	documentation Impella
	enumeration	0350003	documentation vv ECMO
	enumeration	0350004	documentation va ECMO
	enumeration	0350042	documentation andere
annotation	documentation Kat_AK_Methode		
source	<pre> <simpleType name="enum_0350"> <annotation> <documentation>Kat_AK_Methode</documentation> </annotation> <restriction base="xs:string"> <enumeration value="0350001"> <annotation> <documentation>IABP</documentation> </annotation> </enumeration> <enumeration value="0350002"> <annotation> <documentation>Impella</documentation> </annotation> </enumeration> <enumeration value="0350003"> <annotation> </pre>		

	<pre> <documentation>vv ECMO</documentation> </annotation> </enumeration> <enumeration value="0350004"> <annotation> <documentation>va ECMO</documentation> </annotation> </enumeration> <enumeration value="0350042"> <annotation> <documentation>andere</documentation> </annotation> </enumeration> </restriction> </simpleType> </pre>
--	--

simpleType enum_0351

namespace	http://xml.ir-d.de/irdma		
type	restriction of string		
properties	base xs:string		
facets	Kind	Value	Annotation
	enumeration	0351001	documentation nein
	enumeration	0351002	documentation ja, zu Sternotomie
	enumeration	0351003	documentation ja, zu transapikal
	enumeration	0351004	documentation ja, zu transaortal
	enumeration	0351005	documentation ja, zu transfemoral
	enumeration	0351006	documentation ja, zu transaxillär
	enumeration	0351007	documentation ja, zu anderem endovaskulären Zugang
	enumeration	0351042	documentation ja, zu anderem Zugang
annotation	documentation Kat_AK_Konversion		
source	<pre> <simpleType name="enum_0351"> <annotation> <documentation>Kat_AK_Konversion</documentation> </annotation> <restriction base="xs:string"> <enumeration value="0351001"> <annotation> <documentation>nein</documentation> </annotation> </enumeration> <enumeration value="0351002"> <annotation> <documentation>ja, zu Sternotomie</documentation> </annotation> </enumeration> <enumeration value="0351003"> <annotation> <documentation>ja, zu transapikal</documentation> </pre>		

	<pre> </annotation> </enumeration> <enumeration value="0351004"> <annotation> <documentation>ja, zu transaortal</documentation> </annotation> </enumeration> <enumeration value="0351005"> <annotation> <documentation>ja, zu transfemoral</documentation> </annotation> </enumeration> <enumeration value="0351006"> <annotation> <documentation>ja, zu transaxillär</documentation> </annotation> </enumeration> <enumeration value="0351007"> <annotation> <documentation>ja, zu anderem endovaskulären Zugang</documentation> </annotation> </enumeration> <enumeration value="0351042"> <annotation> <documentation>ja, zu anderem Zugang</documentation> </annotation> </enumeration> </restriction> </simpleType> </pre>
--	---

simpleType enum_0352

namespace	http://xml.ir-d.de/irdma		
type	restriction of string		
properties	base xs:string		
facets	Kind	Value	Annotation
	enumeration	0352001	documentation nein
	enumeration	0352002	documentation ja, Intubationsnarkose
	enumeration	0352003	documentation ja, Maskenbeatmung, incl. LAMA
	enumeration	0352042	documentation ja, unbekannt welche
annotation	documentation Kat_AK_Anaesthesie		
source	<pre> <simpleType name="enum_0352"> <annotation> <documentation>Kat_AK_Anaesthesie</documentation> </annotation> <restriction base="xs:string"> <enumeration value="0352001"> <annotation> <documentation>nein</documentation> </annotation> </enumeration> <enumeration value="0352002"> </pre>		

	<pre> <annotation> <documentation>ja, Intubationsnarkose</documentation> </annotation> </enumeration> <enumeration value="0352003"> <annotation> <documentation>ja, Maskenbeatmung, incl. LAMA</documentation> </annotation> </enumeration> <enumeration value="0352042"> <annotation> <documentation>ja, unbekannt welche</documentation> </annotation> </enumeration> </restriction> </simpleType> </pre>
--	---

simpleType enum 0353

namespace	http://xml.ir-d.de/irdma		
type	restriction of string		
properties	base xs:string		
facets	Kind	Value	Annotation
	enumeration	0353001	documentation keine
	enumeration	0353002	documentation leichtgradig
	enumeration	0353003	documentation mittelgradig
	enumeration	0353004	documentation hochgradig
	enumeration	0353099	documentation nicht bestimmbar
annotation	documentation Kat_AK_ResidualeArteninsuffizienz		
source	<pre> <simpleType name="enum_0353"> <annotation> <documentation>Kat_AK_ResidualeArteninsuffizienz</documentation> </annotation> <restriction base="xs:string"> <enumeration value="0353001"> <annotation> <documentation>keine</documentation> </annotation> </enumeration> <enumeration value="0353002"> <annotation> <documentation>leichtgradig</documentation> </annotation> </enumeration> <enumeration value="0353003"> <annotation> <documentation>mittelgradig</documentation> </annotation> </enumeration> <enumeration value="0353004"> <annotation> </pre>		

	<pre> <documentation>hochgradig</documentation> </annotation> </enumeration> <enumeration value="0353099"> <annotation> <documentation>nicht bestimmbar</documentation> </annotation> </enumeration> </restriction> </simpleType> </pre>
--	--

simpleType enum_0354

namespace	http://xml.ir-d.de/irdma		
type	restriction of string		
properties	base xs:string		
facets	Kind	Value	Annotation
	enumeration	0354001	documentation chirurgisch-offen
	enumeration	0354002	documentation Verschluss-System
	enumeration	0354042	documentation sonstiger
annotation	documentation Kat_AK_Zugangswegverschluss		
source	<pre> <simpleType name="enum_0354"> <annotation> <documentation>Kat_AK_Zugangswegverschluss</documentation> </annotation> <restriction base="xs:string"> <enumeration value="0354001"> <annotation> <documentation>chirurgisch-offen</documentation> </annotation> </enumeration> <enumeration value="0354002"> <annotation> <documentation>Verschluss-System</documentation> </annotation> </enumeration> <enumeration value="0354042"> <annotation> <documentation>sonstiger</documentation> </annotation> </enumeration> </restriction> </simpleType> </pre>		

simpleType enum_0357

namespace	http://xml.ir-d.de/irdma		
type	restriction of string		
properties	base xs:string		

facets	<table border="1"> <thead> <tr> <th>Kind</th> <th>Value</th> <th>Annotation</th> </tr> </thead> <tbody> <tr> <td>enumeration</td> <td>0357001</td> <td>documentation keine KHK</td> </tr> <tr> <td>enumeration</td> <td>0357002</td> <td>documentation 1-Gefäßerkrankung</td> </tr> <tr> <td>enumeration</td> <td>0357003</td> <td>documentation 2-Gefäßerkrankung</td> </tr> <tr> <td>enumeration</td> <td>0357004</td> <td>documentation 3-Gefäßerkrankung</td> </tr> <tr> <td>enumeration</td> <td>0357005</td> <td>documentation keine koronare Bildgebung</td> </tr> </tbody> </table>	Kind	Value	Annotation	enumeration	0357001	documentation keine KHK	enumeration	0357002	documentation 1-Gefäßerkrankung	enumeration	0357003	documentation 2-Gefäßerkrankung	enumeration	0357004	documentation 3-Gefäßerkrankung	enumeration	0357005	documentation keine koronare Bildgebung
Kind	Value	Annotation																	
enumeration	0357001	documentation keine KHK																	
enumeration	0357002	documentation 1-Gefäßerkrankung																	
enumeration	0357003	documentation 2-Gefäßerkrankung																	
enumeration	0357004	documentation 3-Gefäßerkrankung																	
enumeration	0357005	documentation keine koronare Bildgebung																	
annotation	documentation Kat AK BefundBildgebung																		
source	<pre> <simpleType name="enum_0357"> <annotation> <documentation>Kat_AK_BefundBildgebung</documentation> </annotation> <restriction base="xs:string"> <enumeration value="0357001"> <annotation> <documentation>keine KHK</documentation> </annotation> </enumeration> <enumeration value="0357002"> <annotation> <documentation>1-Gefäßerkrankung</documentation> </annotation> </enumeration> <enumeration value="0357003"> <annotation> <documentation>2-Gefäßerkrankung</documentation> </annotation> </enumeration> <enumeration value="0357004"> <annotation> <documentation>3-Gefäßerkrankung</documentation> </annotation> </enumeration> <enumeration value="0357005"> <annotation> <documentation>keine koronare Bildgebung</documentation> </annotation> </enumeration> </restriction> </simpleType> </pre>																		

simpleType enum_0358

namespace	http://xml.ir-d.de/irdma												
type	restriction of string												
properties	base xs:string												
facets	<table border="1"> <thead> <tr> <th>Kind</th> <th>Value</th> <th>Annotation</th> </tr> </thead> <tbody> <tr> <td>enumeration</td> <td>0358001</td> <td>documentation 0</td> </tr> <tr> <td>enumeration</td> <td>0358002</td> <td>documentation 1</td> </tr> <tr> <td>enumeration</td> <td>0358003</td> <td>documentation 2</td> </tr> </tbody> </table>	Kind	Value	Annotation	enumeration	0358001	documentation 0	enumeration	0358002	documentation 1	enumeration	0358003	documentation 2
Kind	Value	Annotation											
enumeration	0358001	documentation 0											
enumeration	0358002	documentation 1											
enumeration	0358003	documentation 2											

	enumeration 0358004 documentation 3 enumeration 0358005 documentation 4 enumeration 0358006 documentation 5 oder mehr enumeration 0358098 documentation genaue Anzahl unbekannt (aber mind. 1) enumeration 0358099 documentation unbekannt
annotation	documentation Kat_AK_AnzahlVorOP
source	<pre> <simpleType name="enum_0358"> <annotation> <documentation>Kat_AK_AnzahlVorOP</documentation> </annotation> <restriction base="xs:string"> <enumeration value="0358001"> <annotation> <documentation>0</documentation> </annotation> </enumeration> <enumeration value="0358002"> <annotation> <documentation>1</documentation> </annotation> </enumeration> <enumeration value="0358003"> <annotation> <documentation>2</documentation> </annotation> </enumeration> <enumeration value="0358004"> <annotation> <documentation>3</documentation> </annotation> </enumeration> <enumeration value="0358005"> <annotation> <documentation>4</documentation> </annotation> </enumeration> <enumeration value="0358006"> <annotation> <documentation>5 oder mehr</documentation> </annotation> </enumeration> <enumeration value="0358098"> <annotation> <documentation>genaue Anzahl unbekannt (aber mind. 1)</documentation> </annotation> </enumeration> <enumeration value="0358099"> <annotation> <documentation>unbekannt</documentation> </annotation> </enumeration> </restriction> </simpleType> </pre>

simpleType enum 0359

namespace	http://xml.ir-d.de/irdma		
type	restriction of string		
properties	base xs:string		
facets	Kind	Value	Annotation
	enumeration	0359001	documentation nein
	enumeration	0359002	documentation ja - einseitig
	enumeration	0359003	documentation ja - beidseitig
	enumeration	0359042	documentation unbekannt
annotation	documentation Kat AK LVOT		
source	<pre> <simpleType name="enum_0359"> <annotation> <documentation>Kat_AK_LVOT</documentation> </annotation> <restriction base="xs:string"> <enumeration value="0359001"> <annotation> <documentation>nein</documentation> </annotation> </enumeration> <enumeration value="0359002"> <annotation> <documentation>ja - einseitig</documentation> </annotation> </enumeration> <enumeration value="0359003"> <annotation> <documentation>ja - beidseitig</documentation> </annotation> </enumeration> <enumeration value="0359042"> <annotation> <documentation>unbekannt</documentation> </annotation> </enumeration> </restriction> </simpleType> </pre>		

simpleType enum 0360

namespace	http://xml.ir-d.de/irdma		
type	restriction of string		
properties	base xs:string		
facets	Kind	Value	Annotation
	enumeration	0360001	documentation keine
	enumeration	0360002	documentation leichtgradig

	enumeration 0360003 documentation mittelgradig enumeration 0360004 documentation hochgradig enumeration 0360005 documentation massive enumeration 0360006 documentation torrential enumeration 0360099 documentation unbekannt
annotation	documentation Kat_AK_TriskupidallInsuffizienz
source	<pre> <simpleType name="enum_0360"> <annotation> <documentation>Kat_AK_TriskupidallInsuffizienz</documentation> </annotation> <restriction base="xs:string"> <enumeration value="0360001"> <annotation> <documentation>keine</documentation> </annotation> </enumeration> <enumeration value="0360002"> <annotation> <documentation>leichtgradig</documentation> </annotation> </enumeration> <enumeration value="0360003"> <annotation> <documentation>mittelgradig</documentation> </annotation> </enumeration> <enumeration value="0360004"> <annotation> <documentation>hochgradig</documentation> </annotation> </enumeration> <enumeration value="0360005"> <annotation> <documentation>massive</documentation> </annotation> </enumeration> <enumeration value="0360006"> <annotation> <documentation>torrential</documentation> </annotation> </enumeration> <enumeration value="0360099"> <annotation> <documentation>unbekannt</documentation> </annotation> </enumeration> </restriction> </simpleType> </pre>

simpleType enum_0361

namespace	http://xml.ir-d.de/irdma
-----------	--------------------------

type	restriction of string		
properties	base xs:string		
facets	Kind	Value	Annotation
	enumeration	0361001	documentation nein
	enumeration	0361002	documentation ja, letzte(r) innerhalb der letzten 48 Stunden
	enumeration	0361003	documentation ja, letzte(r) innerhalb der letzten 21 Tage
	enumeration	0361004	documentation ja, letzte(r) länger als 21 Tage
	enumeration	0361098	documentation ja, letzter Zeitpunkt unbekannt
	enumeration	0361099	documentation unbekannt
annotation	documentation Kat_AK_SchockReanimation		
source	<pre> <simpleType name="enum_0361"> <annotation> <documentation>Kat_AK_SchockReanimation</documentation> </annotation> <restriction base="xs:string"> <enumeration value="0361001"> <annotation> <documentation>nein</documentation> </annotation> </enumeration> <enumeration value="0361002"> <annotation> <documentation>ja, letzte(r) innerhalb der letzten 48 Stunden</documentation> </annotation> </enumeration> <enumeration value="0361003"> <annotation> <documentation>ja, letzte(r) innerhalb der letzten 21 Tage</documentation> </annotation> </enumeration> <enumeration value="0361004"> <annotation> <documentation>ja, letzte(r) länger als 21 Tage</documentation> </annotation> </enumeration> <enumeration value="0361098"> <annotation> <documentation>ja, letzter Zeitpunkt unbekannt</documentation> </annotation> </enumeration> <enumeration value="0361099"> <annotation> <documentation>unbekannt</documentation> </annotation> </enumeration> </restriction> </simpleType> </pre>		

simpleType enum_0362

namespace	http://xml.ir-d.de/irdma		
type	restriction of string		
properties	base xs:string		
facets	Kind	Value	Annotation
	enumeration	0362001	documentation Sinusrhythmus
	enumeration	0362002	documentation Vorhofflimmern
	enumeration	0362042	documentation anderer Herzrhythmus
annotation	documentation Kat_AK_Herzrhythmus		
source	<pre> <simpleType name="enum_0362"> <annotation> <documentation>Kat_AK_Herzrhythmus</documentation> </annotation> <restriction base="xs:string"> <enumeration value="0362001"> <annotation> <documentation>Sinusrhythmus</documentation> </annotation> </enumeration> <enumeration value="0362002"> <annotation> <documentation>Vorhofflimmern</documentation> </annotation> </enumeration> <enumeration value="0362042"> <annotation> <documentation>anderer Herzrhythmus</documentation> </annotation> </enumeration> </restriction> </simpleType> </pre>		

simpleType enum_0363

namespace	http://xml.ir-d.de/irdma		
type	restriction of string		
properties	base xs:string		
facets	Kind	Value	Annotation
	enumeration	0363001	documentation nein
	enumeration	0363002	documentation paroxysmal
	enumeration	0363003	documentation persistierend
	enumeration	0363004	documentation permanent
annotation	documentation Kat_AK_Vorhofflimmern		
source	<pre> <simpleType name="enum_0363"> <annotation> <documentation>Kat AK Vorhofflimmern</documentation> </annotation> </pre>		

	<pre> </annotation> <restriction base="xs:string"> <enumeration value="0363001"> <annotation> <documentation>nein</documentation> </annotation> </enumeration> <enumeration value="0363002"> <annotation> <documentation>paroxysmal</documentation> </annotation> </enumeration> <enumeration value="0363003"> <annotation> <documentation>persistierend</documentation> </annotation> </enumeration> <enumeration value="0363004"> <annotation> <documentation>permanent</documentation> </annotation> </enumeration> </restriction> </simpleType> </pre>
--	--

simpleType enum_0364

namespace	http://xml.ir-d.de/irdma		
type	restriction of string		
properties	base xs:string		
facets	Kind	Value	Annotation
	enumeration	0364001	documentation nein
	enumeration	0364002	documentation Schrittmacher ohne CRT-System
	enumeration	0364003	documentation Schrittmacher mit CRT-System
	enumeration	0364004	documentation Defibrillator ohne CRT-System
	enumeration	0364005	documentation Defibrillator mit CRT-System
annotation	documentation Kat_AK_SchrittmacherDefi		
source	<pre> <simpleType name="enum_0364"> <annotation> <documentation>Kat_AK_SchrittmacherDefi</documentation> </annotation> <restriction base="xs:string"> <enumeration value="0364001"> <annotation> <documentation>nein</documentation> </annotation> </enumeration> <enumeration value="0364002"> <annotation> <documentation>Schrittmacher ohne CRT-System</documentation> </annotation> </enumeration> </restriction> </simpleType> </pre>		

	<pre> </enumeration> <enumeration value="0364003"> <annotation> <documentation>Schrittmacher mit CRT-System</documentation> </annotation> </enumeration> <enumeration value="0364004"> <annotation> <documentation>Defibrillator ohne CRT-System</documentation> </annotation> </enumeration> <enumeration value="0364005"> <annotation> <documentation>Defibrillator mit CRT-System</documentation> </annotation> </enumeration> </restriction> </simpleType> </pre>
--	---

simpleType enum_0365

namespace	http://xml.ir-d.de/irdma		
type	restriction of string		
properties	base xs:string		
facets	Kind	Value	Annotation
	enumeration	0365001	documentation nein
	enumeration	0365002	documentation ja, operativ
	enumeration	0365003	documentation ja, interventionell
annotation	documentation Kat AK MyokardRevaskularisation		
source	<pre> <simpleType name="enum_0365"> <annotation> <documentation>Kat_AK_MyokardRevaskularisation</documentation> </annotation> <restriction base="xs:string"> <enumeration value="0365001"> <annotation> <documentation>nein</documentation> </annotation> </enumeration> <enumeration value="0365002"> <annotation> <documentation>ja, operativ</documentation> </annotation> </enumeration> <enumeration value="0365003"> <annotation> <documentation>ja, interventionell</documentation> </annotation> </enumeration> </restriction> </simpleType> </pre>		

simpleType enum_0366

namespace	http://xml.ir-d.de/irdma		
type	restriction of string		
properties	base xs:string		
facets	Kind	Value	Annotation
	enumeration	0366001	documentation nein
	enumeration	0366002	documentation ja, <= 6 Stunden
	enumeration	0366003	documentation ja, > 6 Stunden bis <= 3 Monate
	enumeration	0366004	documentation ja, > 3 Monate
	enumeration	0366099	documentation unbekannt
annotation	documentation Kat_AK_PCI		
source	<pre> <simpleType name="enum_0366"> <annotation> <documentation>Kat_AK_PCI</documentation> </annotation> <restriction base="xs:string"> <enumeration value="0366001"> <annotation> <documentation>nein</documentation> </annotation> </enumeration> <enumeration value="0366002"> <annotation> <documentation>ja, &lt;= 6 Stunden</documentation> </annotation> </enumeration> <enumeration value="0366003"> <annotation> <documentation>ja, &gt; 6 Stunden bis &lt;= 3 Monate</documentation> </annotation> </enumeration> <enumeration value="0366004"> <annotation> <documentation>ja, &gt; 3 Monate</documentation> </annotation> </enumeration> <enumeration value="0366099"> <annotation> <documentation>unbekannt</documentation> </annotation> </enumeration> </restriction> </simpleType> </pre>		

simpleType enum_0367

namespace	http://xml.ir-d.de/irdma
type	restriction of string

properties	base xs:string																																																			
facets	<table border="1"> <thead> <tr> <th>Kind</th> <th>Value</th> <th>Annotation</th> </tr> </thead> <tbody> <tr> <td>enumeration</td> <td>0367001</td> <td>documentation keine</td> </tr> <tr> <td>enumeration</td> <td>0367002</td> <td>documentation Mediastinitis</td> </tr> <tr> <td>enumeration</td> <td>0367003</td> <td>documentation Sepsis</td> </tr> <tr> <td>enumeration</td> <td>0367004</td> <td>documentation broncho-pulmonale Infektion</td> </tr> <tr> <td>enumeration</td> <td>0367005</td> <td>documentation oto-laryngologische Infektion</td> </tr> <tr> <td>enumeration</td> <td>0367006</td> <td>documentation floride Endokarditis</td> </tr> <tr> <td>enumeration</td> <td>0367007</td> <td>documentation Peritonitis</td> </tr> <tr> <td>enumeration</td> <td>0367008</td> <td>documentation Wundinfektion Thorax</td> </tr> <tr> <td>enumeration</td> <td>0367009</td> <td>documentation Pleuraempyem</td> </tr> <tr> <td>enumeration</td> <td>0367010</td> <td>documentation Venenkatheterinfektion</td> </tr> <tr> <td>enumeration</td> <td>0367011</td> <td>documentation Harnwegsinfektion</td> </tr> <tr> <td>enumeration</td> <td>0367012</td> <td>documentation Wundinfektion untere Extremitäten</td> </tr> <tr> <td>enumeration</td> <td>0367013</td> <td>documentation HIV-Infektion</td> </tr> <tr> <td>enumeration</td> <td>0367014</td> <td>documentation Hepatitis B oder C</td> </tr> <tr> <td>enumeration</td> <td>0367015</td> <td>documentation andere Wundinfektion</td> </tr> <tr> <td>enumeration</td> <td>0367042</td> <td>documentation sonstige</td> </tr> </tbody> </table>	Kind	Value	Annotation	enumeration	0367001	documentation keine	enumeration	0367002	documentation Mediastinitis	enumeration	0367003	documentation Sepsis	enumeration	0367004	documentation broncho-pulmonale Infektion	enumeration	0367005	documentation oto-laryngologische Infektion	enumeration	0367006	documentation floride Endokarditis	enumeration	0367007	documentation Peritonitis	enumeration	0367008	documentation Wundinfektion Thorax	enumeration	0367009	documentation Pleuraempyem	enumeration	0367010	documentation Venenkatheterinfektion	enumeration	0367011	documentation Harnwegsinfektion	enumeration	0367012	documentation Wundinfektion untere Extremitäten	enumeration	0367013	documentation HIV-Infektion	enumeration	0367014	documentation Hepatitis B oder C	enumeration	0367015	documentation andere Wundinfektion	enumeration	0367042	documentation sonstige
Kind	Value	Annotation																																																		
enumeration	0367001	documentation keine																																																		
enumeration	0367002	documentation Mediastinitis																																																		
enumeration	0367003	documentation Sepsis																																																		
enumeration	0367004	documentation broncho-pulmonale Infektion																																																		
enumeration	0367005	documentation oto-laryngologische Infektion																																																		
enumeration	0367006	documentation floride Endokarditis																																																		
enumeration	0367007	documentation Peritonitis																																																		
enumeration	0367008	documentation Wundinfektion Thorax																																																		
enumeration	0367009	documentation Pleuraempyem																																																		
enumeration	0367010	documentation Venenkatheterinfektion																																																		
enumeration	0367011	documentation Harnwegsinfektion																																																		
enumeration	0367012	documentation Wundinfektion untere Extremitäten																																																		
enumeration	0367013	documentation HIV-Infektion																																																		
enumeration	0367014	documentation Hepatitis B oder C																																																		
enumeration	0367015	documentation andere Wundinfektion																																																		
enumeration	0367042	documentation sonstige																																																		
annotation	documentation Kat_AK_Infektion																																																			
source	<pre> <simpleType name="enum_0367"> <annotation> <documentation>Kat_AK_Infektion</documentation> </annotation> <restriction base="xs:string"> <enumeration value="0367001"> <annotation> <documentation>keine</documentation> </annotation> </enumeration> <enumeration value="0367002"> <annotation> <documentation>Mediastinitis</documentation> </annotation> </enumeration> <enumeration value="0367003"> <annotation> <documentation>Sepsis</documentation> </annotation> </enumeration> <enumeration value="0367004"> <annotation> <documentation>broncho-pulmonale Infektion</documentation> </annotation> </enumeration> </restriction> </simpleType> </pre>																																																			

```
<enumeration value="0367005">
  <annotation>
    <documentation>oto-laryngologische Infektion</documentation>
  </annotation>
</enumeration>
<enumeration value="0367006">
  <annotation>
    <documentation>floride Endokarditis</documentation>
  </annotation>
</enumeration>
<enumeration value="0367007">
  <annotation>
    <documentation>Peritonitis</documentation>
  </annotation>
</enumeration>
<enumeration value="0367008">
  <annotation>
    <documentation>Wundinfektion Thorax</documentation>
  </annotation>
</enumeration>
<enumeration value="0367009">
  <annotation>
    <documentation>Pleuraempyem</documentation>
  </annotation>
</enumeration>
<enumeration value="0367010">
  <annotation>
    <documentation>Venenkatheterinfektion</documentation>
  </annotation>
</enumeration>
<enumeration value="0367011">
  <annotation>
    <documentation>Harnwegsinfektion</documentation>
  </annotation>
</enumeration>
<enumeration value="0367012">
  <annotation>
    <documentation>Wundinfektion untere Extremitäten</documentation>
  </annotation>
</enumeration>
<enumeration value="0367013">
  <annotation>
    <documentation>HIV-Infektion</documentation>
  </annotation>
</enumeration>
<enumeration value="0367014">
  <annotation>
    <documentation>Hepatitis B oder C</documentation>
  </annotation>
</enumeration>
<enumeration value="0367015">
  <annotation>
    <documentation>andere Wundinfektion</documentation>
  </annotation>
</enumeration>
<enumeration value="0367042">
  <annotation>
    <documentation>sonstige</documentation>
  </annotation>
</enumeration>
```

```

</enumeration>
</restriction>
</simpleType>

```

simpleType enum_0368

namespace	http://xml.ir-d.de/irdma		
type	restriction of string		
properties	base xs:string		
facets	Kind	Value	Annotation
	enumeration	0368001	documentation nein
	enumeration	0368002	documentation ja, COPD mit Dauermedikation
	enumeration	0368003	documentation ja, COPD ohne Dauermedikation
	enumeration	0368004	documentation ja, andere Lungenerkrankungen
	enumeration	0368099	documentation unbekannt
annotation	documentation Kat_AK_Lungenerkrankung		
source	<pre> <simpleType name="enum_0368"> <annotation> <documentation>Kat_AK_Lungenerkrankung</documentation> </annotation> <restriction base="xs:string"> <enumeration value="0368001"> <annotation> <documentation>nein</documentation> </annotation> </enumeration> <enumeration value="0368002"> <annotation> <documentation>ja, COPD mit Dauermedikation</documentation> </annotation> </enumeration> <enumeration value="0368003"> <annotation> <documentation>ja, COPD ohne Dauermedikation</documentation> </annotation> </enumeration> <enumeration value="0368004"> <annotation> <documentation>ja, andere Lungenerkrankungen</documentation> </annotation> </enumeration> <enumeration value="0368099"> <annotation> <documentation>unbekannt</documentation> </annotation> </enumeration> </restriction> </simpleType> </pre>		

simpleType enum_0369

namespace	http://xml.ir-d.de/irdma		
type	restriction of string		
properties	base xs:string		
facets	Kind	Value	Annotation
	enumeration	0369001	documentation nein
	enumeration	0369002	documentation akut
	enumeration	0369003	documentation chronisch
annotation	documentation Kat_AK_Nierenersatztherapie		
source	<pre> <simpleType name="enum_0369"> <annotation> <documentation>Kat_AK_Nierenersatztherapie</documentation> </annotation> <restriction base="xs:string"> <enumeration value="0369001"> <annotation> <documentation>nein</documentation> </annotation> </enumeration> <enumeration value="0369002"> <annotation> <documentation>akut</documentation> </annotation> </enumeration> <enumeration value="0369003"> <annotation> <documentation>chronisch</documentation> </annotation> </enumeration> </restriction> </simpleType> </pre>		

simpleType enum_0370

namespace	http://xml.ir-d.de/irdma		
type	restriction of string		
properties	base xs:string		
facets	Kind	Value	Annotation
	enumeration	0370001	documentation Echokardiographie
	enumeration	0370002	documentation Herzkatheter
	enumeration	0370042	documentation andere
annotation	documentation Kat_AK_AKOEFMessmethode		
source	<pre> <simpleType name="enum_0370"> <annotation> <documentation>Kat_AK_AKOEFMessmethode</documentation> </annotation> <restriction base="xs:string"> </pre>		

	<pre> <enumeration value="0370001"> <annotation> <documentation>Echokardiographie</documentation> </annotation> </enumeration> <enumeration value="0370002"> <annotation> <documentation>Herzkatheter</documentation> </annotation> </enumeration> <enumeration value="0370042"> <annotation> <documentation>andere</documentation> </annotation> </enumeration> </restriction> </simpleType> </pre>
--	--

simpleType enum 0371

namespace	http://xml.ir-d.de/irdma		
type	restriction of string		
properties	base xs:string		
facets	Kind	Value	Annotation
	enumeration	0371001	documentation keine
	enumeration	0371002	documentation leicht
	enumeration	0371003	documentation mittel
	enumeration	0371004	documentation schwer
	enumeration	0371099	documentation unbekannt
annotation	documentation Kat_AK_Verkalkungsgrad		
source	<pre> <simpleType name="enum_0371"> <annotation> <documentation>Kat_AK_Verkalkungsgrad</documentation> </annotation> <restriction base="xs:string"> <enumeration value="0371001"> <annotation> <documentation>keine</documentation> </annotation> </enumeration> <enumeration value="0371002"> <annotation> <documentation>leicht</documentation> </annotation> </enumeration> <enumeration value="0371003"> <annotation> <documentation>mittel</documentation> </annotation> </enumeration> <enumeration value="0371004"> </pre>		

	<pre> <annotation> <documentation>schwer</documentation> </annotation> </enumeration> <enumeration value="0371099"> <annotation> <documentation>unbekannt</documentation> </annotation> </enumeration> </restriction> </simpleType> </pre>
--	--

simpleType enum_0372

namespace	http://xml.ir-d.de/irdma		
type	restriction of string		
properties	base xs:string		
facets	Kind	Value	Annotation
	enumeration	0372001	documentation nein
	enumeration	0372002	documentation ja, bicuspide
	enumeration	0372003	documentation ja, unicuspide
	enumeration	0372099	documentation unbekannt
annotation	documentation Kat_AK_BiUnicuspideKlappe		
source	<pre> <simpleType name="enum_0372"> <annotation> <documentation>Kat_AK_BiUnicuspideKlappe</documentation> </annotation> <restriction base="xs:string"> <enumeration value="0372001"> <annotation> <documentation>nein</documentation> </annotation> </enumeration> <enumeration value="0372002"> <annotation> <documentation>ja, bicuspide</documentation> </annotation> </enumeration> <enumeration value="0372003"> <annotation> <documentation>ja, unicuspide</documentation> </annotation> </enumeration> <enumeration value="0372099"> <annotation> <documentation>unbekannt</documentation> </annotation> </enumeration> </restriction> </simpleType> </pre>		

simpleType enum_0373

namespace	http://xml.ir-d.de/irdma		
type	restriction of string		
properties	base xs:string		
facets	Kind	Value	Annotation
	enumeration	0373001	documentation keine
	enumeration	0373002	documentation leichtgradig
	enumeration	0373003	documentation mittelgradig
	enumeration	0373004	documentation hochgradig
	enumeration	0373099	documentation unbekannt
annotation	documentation Kat_AK_Grad		
source	<pre> <simpleType name="enum_0373"> <annotation> <documentation>Kat_AK_Grad</documentation> </annotation> <restriction base="xs:string"> <enumeration value="0373001"> <annotation> <documentation>keine</documentation> </annotation> </enumeration> <enumeration value="0373002"> <annotation> <documentation>leichtgradig</documentation> </annotation> </enumeration> <enumeration value="0373003"> <annotation> <documentation>mittelgradig</documentation> </annotation> </enumeration> <enumeration value="0373004"> <annotation> <documentation>hochgradig</documentation> </annotation> </enumeration> <enumeration value="0373099"> <annotation> <documentation>unbekannt</documentation> </annotation> </enumeration> </restriction> </simpleType> </pre>		

simpleType enum_0374

namespace	http://xml.ir-d.de/irdma
type	restriction of string

properties	base xs:string																								
facets	<table border="1"> <thead> <tr> <th>Kind</th> <th>Value</th> <th>Annotation</th> </tr> </thead> <tbody> <tr> <td>enumeration</td> <td>0374001</td> <td>documentation nein</td> </tr> <tr> <td>enumeration</td> <td>0374002</td> <td>documentation ja, &lt;= 6 Stunden</td> </tr> <tr> <td>enumeration</td> <td>0374003</td> <td>documentation ja, &gt; 6 Stunden bis &lt;= 24 Stunden</td> </tr> <tr> <td>enumeration</td> <td>0374004</td> <td>documentation ja, &gt; 1 bis 7 Tage</td> </tr> <tr> <td>enumeration</td> <td>0374005</td> <td>documentation ja, &gt; 7 bis 21 Tage</td> </tr> <tr> <td>enumeration</td> <td>0374006</td> <td>documentation ja, &gt; 21 Tage</td> </tr> <tr> <td>enumeration</td> <td>0374099</td> <td>documentation unbekannt</td> </tr> </tbody> </table>	Kind	Value	Annotation	enumeration	0374001	documentation nein	enumeration	0374002	documentation ja, <= 6 Stunden	enumeration	0374003	documentation ja, > 6 Stunden bis <= 24 Stunden	enumeration	0374004	documentation ja, > 1 bis 7 Tage	enumeration	0374005	documentation ja, > 7 bis 21 Tage	enumeration	0374006	documentation ja, > 21 Tage	enumeration	0374099	documentation unbekannt
Kind	Value	Annotation																							
enumeration	0374001	documentation nein																							
enumeration	0374002	documentation ja, <= 6 Stunden																							
enumeration	0374003	documentation ja, > 6 Stunden bis <= 24 Stunden																							
enumeration	0374004	documentation ja, > 1 bis 7 Tage																							
enumeration	0374005	documentation ja, > 7 bis 21 Tage																							
enumeration	0374006	documentation ja, > 21 Tage																							
enumeration	0374099	documentation unbekannt																							
annotation	documentation Kat_AK_InfarktAnamnese																								
source	<pre> <simpleType name="enum_0374"> <annotation> <documentation>Kat_AK_InfarktAnamnese</documentation> </annotation> <restriction base="xs:string"> <enumeration value="0374001"> <annotation> <documentation>nein</documentation> </annotation> </enumeration> <enumeration value="0374002"> <annotation> <documentation>ja, &lt;= 6 Stunden</documentation> </annotation> </enumeration> <enumeration value="0374003"> <annotation> <documentation>ja, &gt; 6 Stunden bis &lt;= 24 Stunden</documentation> </annotation> </enumeration> <enumeration value="0374004"> <annotation> <documentation>ja, &gt; 1 bis 7 Tage</documentation> </annotation> </enumeration> <enumeration value="0374005"> <annotation> <documentation>ja, &gt; 7 bis 21 Tage</documentation> </annotation> </enumeration> <enumeration value="0374006"> <annotation> <documentation>ja, &gt; 21 Tage</documentation> </annotation> </enumeration> <enumeration value="0374099"> <annotation> <documentation>unbekannt</documentation> </annotation> </enumeration> </restriction> </pre>																								

</simpleType>

simpleType enum_0375

namespace	http://xml.ir-d.de/irdma		
type	restriction of string		
properties	base xs:string		
facets	Kind	Value	Annotation
	enumeration	0375001	documentation keine Symptome oder Angina
	enumeration	0375002	documentation Symptome, aber keine Ischämiezeichen
	enumeration	0375003	documentation stabile Angina
	enumeration	0375004	documentation instabile Angina
	enumeration	0375005	documentation Infarkt ohne ST-Hebung (Non-STEMI)
	enumeration	0375006	documentation Infarkt mit ST-Hebung (STEMI)
	enumeration	0375042	documentation unbekannt
annotation	documentation Kat_AK_KardialeSymptome		
source	<pre><simpleType name="enum_0375"> <annotation> <documentation>Kat_AK_KardialeSymptome</documentation> </annotation> <restriction base="xs:string"> <enumeration value="0375001"> <annotation> <documentation>keine Symptome oder Angina</documentation> </annotation> </enumeration> <enumeration value="0375002"> <annotation> <documentation>Symptome, aber keine Ischämiezeichen</documentation> </annotation> </enumeration> <enumeration value="0375003"> <annotation> <documentation>stabile Angina</documentation> </annotation> </enumeration> <enumeration value="0375004"> <annotation> <documentation>instabile Angina</documentation> </annotation> </enumeration> <enumeration value="0375005"> <annotation> <documentation>Infarkt ohne ST-Hebung (Non-STEMI)</documentation> </annotation> </enumeration> <enumeration value="0375006"> <annotation> <documentation>Infarkt mit ST-Hebung (STEMI)</documentation> </annotation> </enumeration> </restriction> </simpleType></pre>		

	<pre> </annotation> </enumeration> <enumeration value="0375042"> <annotation> <documentation>unbekannt</documentation> </annotation> </enumeration> </restriction> </simpleType> </pre>
--	---

simpleType enum_0376

namespace	http://xml.ir-d.de/irdma		
type	restriction of string		
properties	base xs:string		
facets	Kind	Value	Annotation
	enumeration	0376001	documentation nein
	enumeration	0376002	documentation ja, ZNS, zerebrovaskuläre Blutung
	enumeration	0376003	documentation ja, ZNS, zerebrovaskuläre Ischämie
	enumeration	0376042	documentation ja, ZNS, andere
annotation	documentation Kat_AK_Schlaganfall		
source	<pre> <simpleType name="enum_0376"> <annotation> <documentation>Kat_AK_Schlaganfall</documentation> </annotation> <restriction base="xs:string"> <enumeration value="0376001"> <annotation> <documentation>nein</documentation> </annotation> </enumeration> <enumeration value="0376002"> <annotation> <documentation>ja, ZNS, zerebrovaskuläre Blutung</documentation> </annotation> </enumeration> <enumeration value="0376003"> <annotation> <documentation>ja, ZNS, zerebrovaskuläre Ischämie</documentation> </annotation> </enumeration> <enumeration value="0376042"> <annotation> <documentation>ja, ZNS, andere</documentation> </annotation> </enumeration> </restriction> </simpleType> </pre>		

simpleType enum_0377

namespace	http://xml.ir-d.de/irdma		
type	restriction of string		
properties	base xs:string		
facets	Kind	Value	Annotation
	enumeration	0377001	documentation ja, mild neurological dysfunction: NIHSS 0-5
	enumeration	0377002	documentation ja, moderate neurological dysfunction: NIHSS 6-14
	enumeration	0377003	documentation ja, severe neurological dysfunction: NIHSS >=15
annotation	documentation Kat_AK_Nihss		
source	<pre> <simpleType name="enum_0377"> <annotation> <documentation>Kat_AK_Nihss</documentation> </annotation> <restriction base="xs:string"> <enumeration value="0377001"> <annotation> <documentation>ja, mild neurological dysfunction: NIHSS 0- 5</documentation> </annotation> </enumeration> <enumeration value="0377002"> <annotation> <documentation>ja, moderate neurological dysfunction: NIHSS 6- 14</documentation> </annotation> </enumeration> <enumeration value="0377003"> <annotation> <documentation>ja, severe neurological dysfunction: NIHSS &gt;=15</documentation> </annotation> </enumeration> </restriction> </simpleType> </pre>		

simpleType enum_0378

namespace	http://xml.ir-d.de/irdma		
type	restriction of string		
properties	base xs:string		
facets	Kind	Value	Annotation
	enumeration	0378001	documentation nein
	enumeration	0378002	documentation ja, < 48h gemäss VARC-3-Definition
	enumeration	0378003	documentation ja, >= 48h - <= 72h gemäß VARC-3-Definition
	enumeration	0378004	documentation ja, > 72 h gemäß VARC-3 Definition
annotation	documentation Kat_AK_Myokardinfarkt		

source	<pre> <simpleType name="enum_0378"> <annotation> <documentation>Kat_AK_Myokardinfarkt</documentation> </annotation> <restriction base="xs:string"> <enumeration value="0378001"> <annotation> <documentation>nein</documentation> </annotation> </enumeration> <enumeration value="0378002"> <annotation> <documentation>ja, &lt; 48h gemäss VARC-3-Definition</documentation> </annotation> </enumeration> <enumeration value="0378003"> <annotation> <documentation>ja, &gt;= 48h - &lt;= 72h gemäß VARC-3- Definition</documentation> </annotation> </enumeration> <enumeration value="0378004"> <annotation> <documentation>ja, &gt; 72 h gemäß VARC-3 Definition</documentation> </annotation> </enumeration> </restriction> </simpleType> </pre>
--------	--

simpleType enum_0379

namespace	http://xml.ir-d.de/irdma		
type	restriction of string		
properties	base xs:string		
facets	Kind	Value	Annotation
	enumeration	0379001	documentation Keine gefäss- oder zugangsassozierte Komplikationen
	enumeration	0379002	documentation Versagen des perkutanen Verschlusssystems
	enumeration	0379003	documentation Geringfügige Gefäßkomplikationen
	enumeration	0379004	documentation Erhebliche Gefäßkomplikationen
annotation	documentation Kat_AK_ZugangKomplikationen		
source	<pre> <simpleType name="enum_0379"> <annotation> <documentation>Kat_AK_ZugangKomplikationen</documentation> </annotation> <restriction base="xs:string"> <enumeration value="0379001"> <annotation> <documentation>Keine gefäss- oder zugangsassozierte Komplikationen</documentation> </annotation> </enumeration> <enumeration value="0379002"> </pre>		

	<pre> <annotation> <documentation>Versagen des perkutanen Verschlussystems</documentation> </annotation> </enumeration> <enumeration value="0379003"> <annotation> <documentation>Geringfügige Gefäßkomplikationen</documentation> </annotation> </enumeration> <enumeration value="0379004"> <annotation> <documentation>Erhebliche Gefäßkomplikationen</documentation> </annotation> </enumeration> </restriction> </simpleType> </pre>
--	---

simpleType enum 0380

namespace	http://xml.ir-d.de/irdma		
type	restriction of string		
properties	base xs:string		
facets	Kind	Value	Annotation
	enumeration	0380001	documentation nein
	enumeration	0380002	documentation ja, intraprozedural
	enumeration	0380003	documentation ja, postprozedural
	enumeration	0380004	documentation ja, Zeitpunkt nicht bekannt
annotation	documentation Kat_AK_Reanimation		
source	<pre> <simpleType name="enum_0380"> <annotation> <documentation>Kat_AK_Reanimation</documentation> </annotation> <restriction base="xs:string"> <enumeration value="0380001"> <annotation> <documentation>nein</documentation> </annotation> </enumeration> <enumeration value="0380002"> <annotation> <documentation>ja, intraprozedural</documentation> </annotation> </enumeration> <enumeration value="0380003"> <annotation> <documentation>ja, postprozedural</documentation> </annotation> </enumeration> <enumeration value="0380004"> <annotation> <documentation>ja, Zeitpunkt nicht bekannt</documentation> </annotation> </enumeration> </restriction> </simpleType> </pre>		

```

    </annotation>
  </enumeration>
</restriction>
</simpleType>

```

simpleType enum_0381

namespace	http://xml.ir-d.de/irdma		
type	restriction of string		
properties	base xs:string		
facets	Kind	Value	Annotation
	enumeration	0381001	documentation nein
	enumeration	0381002	documentation Thorakotomie/Rethorakotomie
	enumeration	0381003	documentation kathetergestützte Reintervention
	enumeration	0381004	documentation lokale Reinterventionen
	enumeration	0381005	documentation andere Reintervention
annotation	documentation Kat_AK_Massnahmen		
source	<pre> <simpleType name="enum_0381"> <annotation> <documentation>Kat_AK_Massnahmen</documentation> </annotation> <restriction base="xs:string"> <enumeration value="0381001"> <annotation> <documentation>nein</documentation> </annotation> </enumeration> <enumeration value="0381002"> <annotation> <documentation>Thorakotomie/Rethorakotomie</documentation> </annotation> </enumeration> <enumeration value="0381003"> <annotation> <documentation>kathetergestützte Reintervention</documentation> </annotation> </enumeration> <enumeration value="0381004"> <annotation> <documentation>lokale Reinterventionen</documentation> </annotation> </enumeration> <enumeration value="0381005"> <annotation> <documentation>andere Reintervention</documentation> </annotation> </enumeration> </restriction> </simpleType> </pre>		

simpleType enum_0382

namespace	http://xml.ir-d.de/irdma		
type	restriction of string		
properties	base xs:string		
facets	Kind	Value	Annotation
	enumeration	0382001	documentation keine Rethorakotomie / kein weiterer Grund
	enumeration	0382002	documentation Blutung/Hämatom
	enumeration	0382003	documentation Low Cardiac Output
	enumeration	0382004	documentation Tamponade
	enumeration	0382005	documentation Graftprobleme, Ischämie
	enumeration	0382006	documentation Wundinfektion, Mediastinitis
	enumeration	0382007	documentation Dissektion
	enumeration	0382008	documentation Prothesendysfunktion
	enumeration	0382009	documentation instabiles Sternum
	enumeration	0382010	documentation Chylothorax
	enumeration	0382011	documentation lokale Revision im Bereich des Zugangsweges
	enumeration	0382042	documentation anderer Grund
annotation	documentation Kat_AK_Komplikation		
source	<pre> <simpleType name="enum_0382"> <annotation> <documentation>Kat_AK_Komplikation</documentation> </annotation> <restriction base="xs:string"> <enumeration value="0382001"> <annotation> <documentation>keine Rethorakotomie / kein weiterer Grund</documentation> </annotation> </enumeration> <enumeration value="0382002"> <annotation> <documentation>Blutung/Hämatom</documentation> </annotation> </enumeration> <enumeration value="0382003"> <annotation> <documentation>Low Cardiac Output</documentation> </annotation> </enumeration> <enumeration value="0382004"> <annotation> <documentation>Tamponade</documentation> </annotation> </enumeration> <enumeration value="0382005"> </pre>		

```

    <annotation>
      <documentation>Graftprobleme, Ischämie</documentation>
    </annotation>
  </enumeration>
  <enumeration value="0382006">
    <annotation>
      <documentation>Wundinfektion, Mediastinitis</documentation>
    </annotation>
  </enumeration>
  <enumeration value="0382007">
    <annotation>
      <documentation>Dissektion</documentation>
    </annotation>
  </enumeration>
  <enumeration value="0382008">
    <annotation>
      <documentation>Prothesendysfunktion</documentation>
    </annotation>
  </enumeration>
  <enumeration value="0382009">
    <annotation>
      <documentation>instabiles Sternum</documentation>
    </annotation>
  </enumeration>
  <enumeration value="0382010">
    <annotation>
      <documentation>Chylothorax</documentation>
    </annotation>
  </enumeration>
  <enumeration value="0382011">
    <annotation>
      <documentation>lokale Revision im Bereich des
Zugangsweges</documentation>
    </annotation>
  </enumeration>
  <enumeration value="0382042">
    <annotation>
      <documentation>anderer Grund</documentation>
    </annotation>
  </enumeration>
</restriction>
</simpleType>

```

simpleType enum_0383

namespace	http://xml.ir-d.de/irdma		
type	restriction of string		
properties	base xs:string		
facets	Kind	Value	Annotation
	enumeration	0383001	documentation nein
	enumeration	0383002	documentation ja, mit forcierter Atemtherapie
	enumeration	0383003	documentation ja, Reintubation oder längerfristige Beatmung
	enumeration	0383004	documentation ja, Tracheotomie

annotation	documentation Kat_AK_RespiratorischeInsuffizienz
source	<pre> <simpleType name="enum_0383"> <annotation> <documentation>Kat_AK_RespiratorischeInsuffizienz</documentation> </annotation> <restriction base="xs:string"> <enumeration value="0383001"> <annotation> <documentation>nein</documentation> </annotation> </enumeration> <enumeration value="0383002"> <annotation> <documentation>ja, mit forcierter Atemtherapie</documentation> </annotation> </enumeration> <enumeration value="0383003"> <annotation> <documentation>ja, Reintubation oder längerfristige Beatmung</documentation> </annotation> </enumeration> <enumeration value="0383004"> <annotation> <documentation>ja, Tracheotomie</documentation> </annotation> </enumeration> </restriction> </simpleType> </pre>

simpleType enum_0384

namespace	http://xml.ir-d.de/irdma		
type	restriction of string		
properties	base xs:string		
facets	Kind	Value	Annotation
	enumeration	0384001	documentation keine Blutungskomplikationen
	enumeration	0384002	documentation Geringfügige Blutung (Minor Bleeding - BARC type 2 or 3a)
	enumeration	0384003	documentation Starke Blutung (Major Bleeding - BARC type 3a)
	enumeration	0384004	documentation Lebensbedrohliche Blutung (Life-threatening or disabling bleeding - BARC type 3b or 3c or type 5)
annotation	documentation Kat_AK_Blutungskomplikation		
source	<pre> <simpleType name="enum_0384"> <annotation> <documentation>Kat_AK_Blutungskomplikation</documentation> </annotation> <restriction base="xs:string"> <enumeration value="0384001"> <annotation> <documentation>keine Blutungskomplikationen</documentation> </annotation> </pre>		

	<pre> </enumeration> <enumeration value="0384002"> <annotation> <documentation>Geringfügige Blutung (Minor Bleeding - BARC type 2 or 3a)</documentation> </annotation> </enumeration> <enumeration value="0384003"> <annotation> <documentation>Starke Blutung (Major Bleeding - BARC type 3a)</documentation> </annotation> </enumeration> <enumeration value="0384004"> <annotation> <documentation>Lebensbedrohliche Blutung (Life-threatening or disabling bleeding - BARC type 3b or 3c or type 5)</documentation> </annotation> </enumeration> </restriction> </simpleType> </pre>
--	--

simpleType enum 0385

namespace	http://xml.ir-d.de/irdma		
type	restriction of string		
properties	base xs:string		
facets	Kind	Value	Annotation
	enumeration	0385001	documentation Sinusrhythmus
	enumeration	0385002	documentation Vorhofflimmern
	enumeration	0385003	documentation Patient verstorben (kein Herzrhythmus)
	enumeration	0385042	documentation anderer Rhythmus
annotation	documentation Kat_AK_HerzrhythmusEntlassung		
source	<pre> <simpleType name="enum_0385"> <annotation> <documentation>Kat_AK_HerzrhythmusEntlassung</documentation> </annotation> <restriction base="xs:string"> <enumeration value="0385001"> <annotation> <documentation>Sinusrhythmus</documentation> </annotation> </enumeration> <enumeration value="0385002"> <annotation> <documentation>Vorhofflimmern</documentation> </annotation> </enumeration> <enumeration value="0385003"> <annotation> <documentation>Patient verstorben (kein Herzrhythmus)</documentation> </annotation> </enumeration> </restriction> </simpleType> </pre>		

	<pre> </enumeration> <enumeration value="0385042"> <annotation> <documentation>anderer Rhythmus</documentation> </annotation> </enumeration> </restriction> </simpleType> </pre>
--	--

simpleType **enum_0388**

namespace	http://xml.ir-d.de/irdma		
type	restriction of string		
properties	base xs:string		
facets	Kind	Value	Annotation
	enumeration	0388001	documentation nein
	enumeration	0388002	documentation ASS
	enumeration	0388003	documentation ADP-Rezeptor-Antagonist
	enumeration	0388004	documentation Kombination ASS und ADP-Rezeptor-Antagonist
	enumeration	0388042	documentation ja, andere
	enumeration	0388099	documentation unbekannt
annotation	documentation Kat_AK_Plaettchenaggregationshemmer		
source	<pre> <simpleType name="enum_0388"> <annotation> <documentation>Kat_AK_Plaettchenaggregationshemmer</documentation> </annotation> <restriction base="xs:string"> <enumeration value="0388001"> <annotation> <documentation>nein</documentation> </annotation> </enumeration> <enumeration value="0388002"> <annotation> <documentation>ASS</documentation> </annotation> </enumeration> <enumeration value="0388003"> <annotation> <documentation>ADP-Rezeptor-Antagonist</documentation> </annotation> </enumeration> <enumeration value="0388004"> <annotation> <documentation>Kombination ASS und ADP-Rezeptor- Antagonist</documentation> </annotation> </enumeration> <enumeration value="0388042"> <annotation> </pre>		

	<pre> <documentation>ja, andere</documentation> </annotation> </enumeration> <enumeration value="0388099"> <annotation> <documentation>unbekannt</documentation> </annotation> </enumeration> </restriction> </simpleType> </pre>
--	---

simpleType enum_0389

namespace	http://xml.ir-d.de/irdma		
type	restriction of string		
properties	base xs:string		
facets	Kind	Value	Annotation
	enumeration	0389001	documentation nein
	enumeration	0389002	documentation Cumarin-Derivate
	enumeration	0389003	documentation Heparinoide
	enumeration	0389004	documentation orale Thrombinantagonisten
	enumeration	0389006	documentation Direkte orale Antikoagulantien (DOAK / NOAK)
	enumeration	0389042	documentation ja, andere
	enumeration	0389099	documentation unbekannt
annotation	documentation Kat_AK_Antikoagulantien		
source	<pre> <simpleType name="enum_0389"> <annotation> <documentation>Kat_AK_Antikoagulantien</documentation> </annotation> <restriction base="xs:string"> <enumeration value="0389001"> <annotation> <documentation>nein</documentation> </annotation> </enumeration> <enumeration value="0389002"> <annotation> <documentation>Cumarin-Derivate</documentation> </annotation> </enumeration> <enumeration value="0389003"> <annotation> <documentation>Heparinoide</documentation> </annotation> </enumeration> <enumeration value="0389004"> <annotation> <documentation>orale Thrombinantagonisten</documentation> </annotation> </pre>		

	<pre> </enumeration> <enumeration value="0389006"> <annotation> <documentation>Direkte orale Antikoagulantien (DOAK / NOAK)</documentation> </annotation> </enumeration> <enumeration value="0389042"> <annotation> <documentation>ja, andere</documentation> </annotation> </enumeration> <enumeration value="0389099"> <annotation> <documentation>unbekannt</documentation> </annotation> </enumeration> </restriction> </simpleType> </pre>
--	---

simpleType enum_0390

namespace	http://xml.ir-d.de/irdma		
type	restriction of string		
properties	base xs:string		
facets	Kind	Value	Annotation
	enumeration	0390001	documentation biologisches Klappenmodell
	enumeration	0390002	documentation mechanisches Klappenmodell
annotation	documentation Kat_AK_Artikeltyp		
source	<pre> <simpleType name="enum_0390"> <annotation> <documentation>Kat_AK_Artikeltyp</documentation> </annotation> <restriction base="xs:string"> <enumeration value="0390001"> <annotation> <documentation>biologisches Klappenmodell</documentation> </annotation> </enumeration> <enumeration value="0390002"> <annotation> <documentation>mechanisches Klappenmodell</documentation> </annotation> </enumeration> </restriction> </simpleType> </pre>		

simpleType enum_0391

namespace	http://xml.ir-d.de/irdma
type	restriction of string

properties	base xs:string									
facets	<table border="1"> <thead> <tr> <th>Kind</th> <th>Value</th> <th>Annotation</th> </tr> </thead> <tbody> <tr> <td>enumeration</td> <td>0391001</td> <td>documentation chirurgische Klappe</td> </tr> <tr> <td>enumeration</td> <td>0391002</td> <td>documentation TAVI-Klappe</td> </tr> </tbody> </table>	Kind	Value	Annotation	enumeration	0391001	documentation chirurgische Klappe	enumeration	0391002	documentation TAVI-Klappe
Kind	Value	Annotation								
enumeration	0391001	documentation chirurgische Klappe								
enumeration	0391002	documentation TAVI-Klappe								
annotation	documentation Kat_AK_Klappentyp									
source	<pre><simpleType name="enum_0391"> <annotation> <documentation>Kat_AK_Klappentyp</documentation> </annotation> <restriction base="xs:string"> <enumeration value="0391001"> <annotation> <documentation>chirurgische Klappe</documentation> </annotation> </enumeration> <enumeration value="0391002"> <annotation> <documentation>TAVI-Klappe</documentation> </annotation> </enumeration> </restriction> </simpleType></pre>									

simpleType enum_0398

namespace	http://xml.ir-d.de/irdma												
type	restriction of string												
properties	base xs:string												
facets	<table border="1"> <thead> <tr> <th>Kind</th> <th>Value</th> <th>Annotation</th> </tr> </thead> <tbody> <tr> <td>enumeration</td> <td>0398001</td> <td>documentation kardiovaskuläre Ursache</td> </tr> <tr> <td>enumeration</td> <td>0398002</td> <td>documentation nicht-kardiovaskuläre Ursache</td> </tr> <tr> <td>enumeration</td> <td>0398099</td> <td>documentation Todesursache unbekannt</td> </tr> </tbody> </table>	Kind	Value	Annotation	enumeration	0398001	documentation kardiovaskuläre Ursache	enumeration	0398002	documentation nicht-kardiovaskuläre Ursache	enumeration	0398099	documentation Todesursache unbekannt
Kind	Value	Annotation											
enumeration	0398001	documentation kardiovaskuläre Ursache											
enumeration	0398002	documentation nicht-kardiovaskuläre Ursache											
enumeration	0398099	documentation Todesursache unbekannt											
annotation	documentation Kat_AK_Todesursache												
source	<pre><simpleType name="enum_0398"> <annotation> <documentation>Kat_AK_Todesursache</documentation> </annotation> <restriction base="xs:string"> <enumeration value="0398001"> <annotation> <documentation>kardiovaskuläre Ursache</documentation> </annotation> </enumeration> <enumeration value="0398002"> <annotation> <documentation>nicht-kardiovaskuläre Ursache</documentation> </annotation> </enumeration> <enumeration value="0398099"> </pre>												

	<pre> <annotation> <documentation>Todesursache unbekannt</documentation> </annotation> </enumeration> </restriction> </simpleType> </pre>
--	---

simpleType enum_0399

namespace	http://xml.ir-d.de/irdma		
type	restriction of string		
properties	base xs:string		
facets	Kind	Value	Annotation
	enumeration	0399001	documentation Patient lebt
	enumeration	0399002	documentation Patient im Krankenhaus verstorben
annotation	documentation Kat_AK_Vitalstatus		
source	<pre> <simpleType name="enum_0399"> <annotation> <documentation>Kat_AK_Vitalstatus</documentation> </annotation> <restriction base="xs:string"> <enumeration value="0399001"> <annotation> <documentation>Patient lebt</documentation> </annotation> </enumeration> <enumeration value="0399002"> <annotation> <documentation>Patient im Krankenhaus verstorben</documentation> </annotation> </enumeration> </restriction> </simpleType> </pre>		

simpleType enum_0044

namespace	http://xml.ir-d.de/irdsa		
type	restriction of string		
properties	base xs:string		
facets	Kind	Value	Annotation
	enumeration	0044001	documentation 1= normaler, sonst gesunder Patient
	enumeration	0044002	documentation 2= Patient mit leichter Allgemeinerkrankung
	enumeration	0044003	documentation 3= Patient mit schwerer Allgemeinerkrankung
	enumeration	0044004	documentation 4= Patient mit schwerer Allgemeinerkrankung, die eine ständige Lebensbedrohung darstellt
	enumeration	0044005	documentation 5= moribunder Patient, der ohne die Operation voraussichtlich nicht überleben wird

annotation	documentation Kat_ASA
source	<pre> <simpleType name="enum_0044"> <annotation> <documentation>Kat_ASA</documentation> </annotation> <restriction base="xs:string"> <enumeration value="0044001"> <annotation> <documentation>1= normaler, sonst gesunder Patient</documentation> </annotation> </enumeration> <enumeration value="0044002"> <annotation> <documentation>2= Patient mit leichter Allgemeinerkrankung</documentation> </annotation> </enumeration> <enumeration value="0044003"> <annotation> <documentation>3= Patient mit schwerer Allgemeinerkrankung</documentation> </annotation> </enumeration> <enumeration value="0044004"> <annotation> <documentation>4= Patient mit schwerer Allgemeinerkrankung, die eine ständige Lebensbedrohung darstellt</documentation> </annotation> </enumeration> <enumeration value="0044005"> <annotation> <documentation>5= moribunder Patient, der ohne die Operation voraussichtlich nicht überleben wird</documentation> </annotation> </enumeration> </restriction> </simpleType> </pre>

simpleType enum_0050

namespace	http://xml.ir-d.de/irdsa		
type	restriction of string		
properties	base xs:string		
facets	Kind	Value	Annotation
	enumeration	0050001	documentation rechts
	enumeration	0050002	documentation links
annotation	documentation Kat_RechtsLinks		
source	<pre> <simpleType name="enum_0050"> <annotation> <documentation>Kat_RechtsLinks</documentation> </annotation> <restriction base="xs:string"> </pre>		

	<pre> <enumeration value="0050001"> <annotation> <documentation>rechts</documentation> </annotation> </enumeration> <enumeration value="0050002"> <annotation> <documentation>links</documentation> </annotation> </enumeration> </restriction> </simpleType> </pre>
--	--

simpleType enum_0060

namespace	http://xml.ir-d.de/irdsa		
type	restriction of string		
properties	base xs:string		
facets	Kind	Value	Annotation
	enumeration	0060001	documentation ja
	enumeration	0060002	documentation nein
annotation	documentation Kat_JaNein		
source	<pre> <simpleType name="enum_0060"> <annotation> <documentation>Kat_JaNein</documentation> </annotation> <restriction base="xs:string"> <enumeration value="0060001"> <annotation> <documentation>ja</documentation> </annotation> </enumeration> <enumeration value="0060002"> <annotation> <documentation>nein</documentation> </annotation> </enumeration> </restriction> </simpleType> </pre>		

simpleType enum_0061

namespace	http://xml.ir-d.de/irdsa		
type	restriction of string		
properties	base xs:string		
facets	Kind	Value	Annotation
	enumeration	0061001	documentation ja
	enumeration	0061002	documentation nein
	enumeration	0061099	documentation

	unbekannt
annotation	documentation Kat JaNeinUnbekannt
source	<pre> <simpleType name="enum_0061"> <annotation> <documentation>Kat_JaNeinUnbekannt</documentation> </annotation> <restriction base="xs:string"> <enumeration value="0061001"> <annotation> <documentation>ja</documentation> </annotation> </enumeration> <enumeration value="0061002"> <annotation> <documentation>nein</documentation> </annotation> </enumeration> <enumeration value="0061099"> <annotation> <documentation>unbekannt</documentation> </annotation> </enumeration> </restriction> </simpleType> </pre>

simpleType enum_0062

namespace	http://xml.ir-d.de/irdsa		
type	restriction of string		
properties	base	xs:string	
facets	Kind	Value	Annotation
	enumeration	0062001	documentation Stück
	enumeration	0062002	documentation g
	enumeration	0062003	documentation mg
	enumeration	0062004	documentation l
	enumeration	0062005	documentation ml
	enumeration	0062006	documentation cm ³
	enumeration	0062007	documentation mm
	enumeration	0062008	documentation cm
	enumeration	0062009	documentation dm
	enumeration	0062010	documentation m
	enumeration	0062042	documentation andere
annotation	documentation Kat_Einheit		
source	<pre> <simpleType name="enum_0062"> <annotation> </pre>		

```
<documentation>Kat_Einheit</documentation>
</annotation>
<restriction base="xs:string">
  <enumeration value="0062001">
    <annotation>
      <documentation>Stück</documentation>
    </annotation>
  </enumeration>
  <enumeration value="0062002">
    <annotation>
      <documentation>g</documentation>
    </annotation>
  </enumeration>
  <enumeration value="0062003">
    <annotation>
      <documentation>mg</documentation>
    </annotation>
  </enumeration>
  <enumeration value="0062004">
    <annotation>
      <documentation>l</documentation>
    </annotation>
  </enumeration>
  <enumeration value="0062005">
    <annotation>
      <documentation>ml</documentation>
    </annotation>
  </enumeration>
  <enumeration value="0062006">
    <annotation>
      <documentation>cm3</documentation>
    </annotation>
  </enumeration>
  <enumeration value="0062007">
    <annotation>
      <documentation>mm</documentation>
    </annotation>
  </enumeration>
  <enumeration value="0062008">
    <annotation>
      <documentation>cm</documentation>
    </annotation>
  </enumeration>
  <enumeration value="0062009">
    <annotation>
      <documentation>dm</documentation>
    </annotation>
  </enumeration>
  <enumeration value="0062010">
    <annotation>
      <documentation>m</documentation>
    </annotation>
  </enumeration>
  <enumeration value="0062042">
    <annotation>
      <documentation>andere</documentation>
    </annotation>
  </enumeration>
</restriction>
```

	<code></simpleType></code>
--	----------------------------------

simpleType enum_0065

namespace	http://xml.ir-d.de/irdsa												
type	restriction of string												
properties	base xs:string												
facets	<table border="1"><thead><tr><th>Kind</th><th>Value</th><th>Annotation</th></tr></thead><tbody><tr><td>enumeration</td><td>0065001</td><td>documentation stationär</td></tr><tr><td>enumeration</td><td>0065002</td><td>documentation teilstationär</td></tr><tr><td>enumeration</td><td>0065003</td><td>documentation ambulant</td></tr></tbody></table>	Kind	Value	Annotation	enumeration	0065001	documentation stationär	enumeration	0065002	documentation teilstationär	enumeration	0065003	documentation ambulant
Kind	Value	Annotation											
enumeration	0065001	documentation stationär											
enumeration	0065002	documentation teilstationär											
enumeration	0065003	documentation ambulant											
annotation	documentation Kat_ArtAufenthalt												
source	<pre><simpleType name="enum_0065"> <annotation> <documentation>Kat_ArtAufenthalt</documentation> </annotation> <restriction base="xs:string"> <enumeration value="0065001"> <annotation> <documentation>stationär</documentation> </annotation> </enumeration> <enumeration value="0065002"> <annotation> <documentation>teilstationär</documentation> </annotation> </enumeration> <enumeration value="0065003"> <annotation> <documentation>ambulant</documentation> </annotation> </enumeration> </restriction> </simpleType></pre>												

simpleType enum_0067

namespace	http://xml.ir-d.de/irdsa									
type	restriction of string									
properties	base xs:string									
facets	<table border="1"><thead><tr><th>Kind</th><th>Value</th><th>Annotation</th></tr></thead><tbody><tr><td>enumeration</td><td>0067001</td><td>documentation Implantat</td></tr><tr><td>enumeration</td><td>0067002</td><td>documentation Explantat</td></tr></tbody></table>	Kind	Value	Annotation	enumeration	0067001	documentation Implantat	enumeration	0067002	documentation Explantat
Kind	Value	Annotation								
enumeration	0067001	documentation Implantat								
enumeration	0067002	documentation Explantat								
annotation	documentation Kat_ArtArtikel									
source	<pre><simpleType name="enum_0067"> <annotation> <documentation>Kat_ArtArtikel</documentation> </annotation> </simpleType></pre>									

	<pre> </annotation> <restriction base="xs:string"> <enumeration value="0067001"> <annotation> <documentation>Implantat</documentation> </annotation> </enumeration> <enumeration value="0067002"> <annotation> <documentation>Explantat</documentation> </annotation> </enumeration> </restriction> </simpleType> </pre>
--	--

simpleType enum_0068

namespace	http://xml.ir-d.de/irdsa		
type	restriction of string		
properties	base xs:string		
facets	Kind	Value	Annotation
	enumeration	0068001	documentation UDI
	enumeration	0068002	documentation Referenz (REF)
annotation	documentation Kat_KennzeichenTyp		
source	<pre> <simpleType name="enum_0068"> <annotation> <documentation>Kat_KennzeichenTyp</documentation> </annotation> <restriction base="xs:string"> <enumeration value="0068001"> <annotation> <documentation>UDI</documentation> </annotation> </enumeration> <enumeration value="0068002"> <annotation> <documentation>Referenz (REF)</documentation> </annotation> </enumeration> </restriction> </simpleType> </pre>		

simpleType enum_0069

namespace	http://xml.ir-d.de/irdsa		
type	restriction of string		
properties	base xs:string		
facets	Kind	Value	Annotation
	enumeration	0069001	documentation Implantat
	enumeration	0069002	documentation

	Explantat
annotation	documentation Kat ArtZubehoer
source	<pre> <simpleType name="enum_0069"> <annotation> <documentation>Kat_ArtZubehoer</documentation> </annotation> <restriction base="xs:string"> <enumeration value="0069001"> <annotation> <documentation>Implantat</documentation> </annotation> </enumeration> <enumeration value="0069002"> <annotation> <documentation>Explantat</documentation> </annotation> </enumeration> </restriction> </simpleType> </pre>

simpleType enum_0070

namespace	http://xml.ir-d.de/irdsa		
type	restriction of string		
properties	base xs:string		
facets	Kind	Value	Annotation
	enumeration	0070001	documentation weiblich
	enumeration	0070002	documentation männlich
	enumeration	0070003	documentation divers
	enumeration	0070042	documentation unbestimmt
annotation	documentation Kat Geschlecht		
source	<pre> <simpleType name="enum_0070"> <annotation> <documentation>Kat_Geschlecht</documentation> </annotation> <restriction base="xs:string"> <enumeration value="0070001"> <annotation> <documentation>weiblich</documentation> </annotation> </enumeration> <enumeration value="0070002"> <annotation> <documentation>männlich</documentation> </annotation> </enumeration> <enumeration value="0070003"> <annotation> <documentation>divers</documentation> </annotation> </enumeration> </restriction> </simpleType> </pre>		

	<pre> <enumeration value="0070042"> <annotation> <documentation>unbestimmt</documentation> </annotation> </enumeration> </restriction> </simpleType> </pre>
--	---

simpleType enum_0071

namespace	http://xml.ir-d.de/irdsa		
type	restriction of string		
properties	base xs:string		
facets	Kind	Value	Annotation
	enumeration	0071001	documentation Implantat
	enumeration	0071002	documentation Explantat
	enumeration	0071003	documentation Degeneriertes/defektes Produkt, das funktionslos im Körper verbleibt
annotation	documentation Kat_ArtikelArtFunktion		
source	<pre> <simpleType name="enum_0071"> <annotation> <documentation>Kat_ArtikelArtFunktion</documentation> </annotation> <restriction base="xs:string"> <enumeration value="0071001"> <annotation> <documentation>Implantat</documentation> </annotation> </enumeration> <enumeration value="0071002"> <annotation> <documentation>Explantat</documentation> </annotation> </enumeration> <enumeration value="0071003"> <annotation> <documentation>Degeneriertes/defektes Produkt, das funktionslos im Körper verbleibt</documentation> </annotation> </enumeration> </restriction> </simpleType> </pre>		

simpleType enum_0075

namespace	http://xml.ir-d.de/irdsa		
type	restriction of string		
properties	base xs:string		
facets	Kind	Value	Annotation
	enumeration	0075001	documentation elektiv

	enumeration 0075002 documentation dringlich enumeration 0075003 documentation Notfall
annotation	documentation Kat_Dringlichkeit
source	<pre> <simpleType name="enum_0075"> <annotation> <documentation>Kat_Dringlichkeit</documentation> </annotation> <restriction base="xs:string"> <enumeration value="0075001"> <annotation> <documentation>elektiv</documentation> </annotation> </enumeration> <enumeration value="0075002"> <annotation> <documentation>dringlich</documentation> </annotation> </enumeration> <enumeration value="0075003"> <annotation> <documentation>Notfall</documentation> </annotation> </enumeration> </restriction> </simpleType> </pre>

simpleType enum 0076

namespace	http://xml.ir-d.de/irdsa		
type	restriction of string		
properties	base xs:string		
facets	Kind	Value	Annotation
	enumeration	0076001	documentation elektiv
	enumeration	0076002	documentation dringlich
	enumeration	0076003	documentation Notfall
	enumeration	0076004	documentation Notfall (Reanimation / ultima ratio)
annotation	documentation Kat_Dringlichkeit_Reanimation		
source	<pre> <simpleType name="enum_0076"> <annotation> <documentation>Kat_Dringlichkeit_Reanimation</documentation> </annotation> <restriction base="xs:string"> <enumeration value="0076001"> <annotation> <documentation>elektiv</documentation> </annotation> </enumeration> <enumeration value="0076002"> <annotation> </pre>		

	<pre> <documentation>dringlich</documentation> </annotation> </enumeration> <enumeration value="0076003"> <annotation> <documentation>Notfall</documentation> </annotation> </enumeration> <enumeration value="0076004"> <annotation> <documentation>Notfall (Reanimation / ultima ratio)</documentation> </annotation> </enumeration> </restriction> </simpleType> </pre>
--	--

simpleType enum 0080

namespace	http://xml.ir-d.de/irdsa		
type	restriction of string		
properties	base xs:string		
facets	Kind	Value	Annotation
	enumeration	0080001	documentation Endoprothese Hüfte/Knie
	enumeration	0080002	documentation Brustimplantat
	enumeration	0080003	documentation Aortenklappenprothese
annotation	documentation Kat_Implantattyp		
source	<pre> <simpleType name="enum_0080"> <annotation> <documentation>Kat_Implantattyp</documentation> </annotation> <restriction base="xs:string"> <enumeration value="0080001"> <annotation> <documentation>Endoprothese Hüfte/Knie</documentation> </annotation> </enumeration> <enumeration value="0080002"> <annotation> <documentation>Brustimplantat</documentation> </annotation> </enumeration> <enumeration value="0080003"> <annotation> <documentation>Aortenklappenprothese</documentation> </annotation> </enumeration> </restriction> </simpleType> </pre>		

simpleType enum_0100

namespace	http://xml.ir-d.de/irdsa		
type	restriction of string		
properties	base xs:string		
facets	Kind	Value	Annotation
	enumeration	0100002	documentation Austausch Expander gegen dauerhaftes Brustimplantat
	enumeration	0100003	documentation Wechsel
	enumeration	0100004	documentation Nur Explantation
	enumeration	0100005	documentation Ersteingriff
	enumeration	0100006	documentation Zweizeitige Implantation
annotation	documentation Kat_BI_ArtEingriff		
source	<pre> <simpleType name="enum_0100"> <annotation> <documentation>Kat_BI_ArtEingriff</documentation> </annotation> <restriction base="xs:string"> <enumeration value="0100002"> <annotation> <documentation>Austausch Expander gegen dauerhaftes Brustimplantat</documentation> </annotation> </enumeration> <enumeration value="0100003"> <annotation> <documentation>Wechsel</documentation> </annotation> </enumeration> <enumeration value="0100004"> <annotation> <documentation>Nur Explantation</documentation> </annotation> </enumeration> <enumeration value="0100005"> <annotation> <documentation>Ersteingriff</documentation> </annotation> </enumeration> <enumeration value="0100006"> <annotation> <documentation>Zweizeitige Implantation</documentation> </annotation> </enumeration> </restriction> </simpleType> </pre>		

simpleType enum_0102

namespace	http://xml.ir-d.de/irdsa
type	restriction of string

properties	base xs:string															
facets	<table border="1"> <thead> <tr> <th>Kind</th> <th>Value</th> <th>Annotation</th> </tr> </thead> <tbody> <tr> <td>enumeration</td> <td>0102001</td> <td>documentation kosmetische Augmentation</td> </tr> <tr> <td>enumeration</td> <td>0102002</td> <td>documentation Rekonstruktion, benigne</td> </tr> <tr> <td>enumeration</td> <td>0102003</td> <td>documentation Rekonstruktion nach Mastektomie aufgrund eines Karzinoms</td> </tr> <tr> <td>enumeration</td> <td>0102004</td> <td>documentation Rekonstruktion nach risikoreduzierender Mastektomie</td> </tr> </tbody> </table>	Kind	Value	Annotation	enumeration	0102001	documentation kosmetische Augmentation	enumeration	0102002	documentation Rekonstruktion, benigne	enumeration	0102003	documentation Rekonstruktion nach Mastektomie aufgrund eines Karzinoms	enumeration	0102004	documentation Rekonstruktion nach risikoreduzierender Mastektomie
Kind	Value	Annotation														
enumeration	0102001	documentation kosmetische Augmentation														
enumeration	0102002	documentation Rekonstruktion, benigne														
enumeration	0102003	documentation Rekonstruktion nach Mastektomie aufgrund eines Karzinoms														
enumeration	0102004	documentation Rekonstruktion nach risikoreduzierender Mastektomie														
annotation	documentation Kat_BI_GrundPrimaereingriff															
source	<pre> <simpleType name="enum_0102"> <annotation> <documentation>Kat_BI_GrundPrimaereingriff</documentation> </annotation> <restriction base="xs:string"> <enumeration value="0102001"> <annotation> <documentation>kosmetische Augmentation</documentation> </annotation> </enumeration> <enumeration value="0102002"> <annotation> <documentation>Rekonstruktion, benigne</documentation> </annotation> </enumeration> <enumeration value="0102003"> <annotation> <documentation>Rekonstruktion nach Mastektomie aufgrund eines Karzinoms</documentation> </annotation> </enumeration> <enumeration value="0102004"> <annotation> <documentation>Rekonstruktion nach risikoreduzierender Mastektomie</documentation> </annotation> </enumeration> </restriction> </simpleType> </pre>															

simpleType enum_0103

namespace	http://xml.ir-d.de/irdsa																		
type	restriction of string																		
properties	base xs:string																		
facets	<table border="1"> <thead> <tr> <th>Kind</th> <th>Value</th> <th>Annotation</th> </tr> </thead> <tbody> <tr> <td>enumeration</td> <td>0103001</td> <td>documentation simultane Lappendeckung</td> </tr> <tr> <td>enumeration</td> <td>0103002</td> <td>documentation simultane Eigenfettransplantation</td> </tr> <tr> <td>enumeration</td> <td>0103003</td> <td>documentation simultane Mastopexie</td> </tr> <tr> <td>enumeration</td> <td>0103005</td> <td>documentation simultane Mastektomie, Ablatio / hautsparend</td> </tr> <tr> <td>enumeration</td> <td>0103006</td> <td>documentation</td> </tr> </tbody> </table>	Kind	Value	Annotation	enumeration	0103001	documentation simultane Lappendeckung	enumeration	0103002	documentation simultane Eigenfettransplantation	enumeration	0103003	documentation simultane Mastopexie	enumeration	0103005	documentation simultane Mastektomie, Ablatio / hautsparend	enumeration	0103006	documentation
Kind	Value	Annotation																	
enumeration	0103001	documentation simultane Lappendeckung																	
enumeration	0103002	documentation simultane Eigenfettransplantation																	
enumeration	0103003	documentation simultane Mastopexie																	
enumeration	0103005	documentation simultane Mastektomie, Ablatio / hautsparend																	
enumeration	0103006	documentation																	

	enumeration 0103007 simultane Mastektomie, nippelerhaltend documentation Axilla-Dissektion
	enumeration 0103008 documentation Drainage
annotation	documentation Kat_BI_OperationsdetailPrimaereingriff
source	<pre> <simpleType name="enum_0103"> <annotation> <documentation>Kat_BI_OperationsdetailPrimaereingriff</documentation> </annotation> <restriction base="xs:string"> <enumeration value="0103001"> <annotation> <documentation>simultane Lappendeckung</documentation> </annotation> </enumeration> <enumeration value="0103002"> <annotation> <documentation>simultane Eigenfetttransplantation</documentation> </annotation> </enumeration> <enumeration value="0103003"> <annotation> <documentation>simultane Mastopexie</documentation> </annotation> </enumeration> <enumeration value="0103005"> <annotation> <documentation>simultane Mastektomie, Ablatio / hautsparend</documentation> </annotation> </enumeration> <enumeration value="0103006"> <annotation> <documentation>simultane Mastektomie, nippelerhaltend</documentation> </annotation> </enumeration> <enumeration value="0103007"> <annotation> <documentation>Axilla-Dissektion</documentation> </annotation> </enumeration> <enumeration value="0103008"> <annotation> <documentation>Drainage</documentation> </annotation> </enumeration> </restriction> </simpleType> </pre>

simpleType enum_0104

namespace	http://xml.ir-d.de/irdsa
type	restriction of string
properties	base xs:string

facets	Kind enumeration	Value 0104001	Annotation documentation Austausch Expander gegen dauerhaftes Brustimplantat
annotation	documentation Kat_BI_GrundAustausch		
source	<pre><simpleType name="enum_0104"> <annotation> <documentation>Kat_BI_GrundAustausch</documentation> </annotation> <restriction base="xs:string"> <enumeration value="0104001"> <annotation> <documentation>Austausch Expander gegen dauerhaftes Brustimplantat</documentation> </annotation> </enumeration> </restriction> </simpleType></pre>		

simpleType enum_0105

namespace	http://xml.ir-d.de/irdsa		
type	restriction of string		
properties	base xs:string		
facets	Kind	Value	Annotation
	enumeration	0105001	documentation simultane Lappendeckung
	enumeration	0105002	documentation simultane Eigenfetttransplantation
	enumeration	0105003	documentation simultane Mastopexie
	enumeration	0105008	documentation Drainage
	enumeration	0105009	documentation Kapsulektomie, komplett
	enumeration	0105010	documentation Kapsulektomie, partiell
	enumeration	0105011	documentation Neopocket
annotation	documentation Kat_BI_OperationsdetailAustausch		
source	<pre><simpleType name="enum_0105"> <annotation> <documentation>Kat_BI_OperationsdetailAustausch</documentation> </annotation> <restriction base="xs:string"> <enumeration value="0105001"> <annotation> <documentation>simultane Lappendeckung</documentation> </annotation> </enumeration> <enumeration value="0105002"> <annotation> <documentation>simultane Eigenfetttransplantation</documentation> </annotation> </enumeration> <enumeration value="0105003"> <annotation></pre>		

	<pre> <documentation>simultane Mastopexie</documentation> </annotation> </enumeration> <enumeration value="0105008"> <annotation> <documentation>Drainage</documentation> </annotation> </enumeration> <enumeration value="0105009"> <annotation> <documentation>Kapsulektomie, komplett</documentation> </annotation> </enumeration> <enumeration value="0105010"> <annotation> <documentation>Kapsulektomie, partiell</documentation> </annotation> </enumeration> <enumeration value="0105011"> <annotation> <documentation>Neopocket</documentation> </annotation> </enumeration> </restriction> </simpleType> </pre>
--	---

simpleType enum_0106

namespace	http://xml.ir-d.de/irdsa		
type	restriction of string		
properties	base xs:string		
facets	Kind	Value	Annotation
	enumeration	0106001	documentation Patientenwunsch
	enumeration	0106002	documentation asymptomatisch
	enumeration	0106003	documentation Komplikation
annotation	documentation Kat_BI_GrundRevisionExplantation		
source	<pre> <simpleType name="enum_0106"> <annotation> <documentation>Kat_BI_GrundRevisionExplantation</documentation> </annotation> <restriction base="xs:string"> <enumeration value="0106001"> <annotation> <documentation>Patientenwunsch</documentation> </annotation> </enumeration> <enumeration value="0106002"> <annotation> <documentation>asymptomatisch</documentation> </annotation> </enumeration> <enumeration value="0106003"> <annotation> </pre>		

	<pre> <documentation>Komplikation</documentation> </annotation> </enumeration> </restriction> </simpleType> </pre>
--	--

simpleType enum_0107

namespace	http://xml.ir-d.de/irdsa		
type	restriction of string		
properties	base xs:string		
facets	Kind	Value	Annotation
	enumeration	0107001	documentation simultane Lappendeckung
	enumeration	0107002	documentation simultane Eigenfetttransplantation
	enumeration	0107003	documentation simultane Mastopexie
	enumeration	0107005	documentation simultane Mastektomie, Ablatio / hautsparend
	enumeration	0107006	documentation simultane Mastektomie, nippelerhaltend
	enumeration	0107007	documentation Axilla-Dissektion
	enumeration	0107008	documentation Drainage
	enumeration	0107009	documentation Kapsulektomie, komplett
	enumeration	0107010	documentation Kapsulektomie, partiell
	enumeration	0107011	documentation Neopocket
annotation	documentation Kat_BI_OperationsdetailRevision		
source	<pre> <simpleType name="enum_0107"> <annotation> <documentation>Kat_BI_OperationsdetailRevision</documentation> </annotation> <restriction base="xs:string"> <enumeration value="0107001"> <annotation> <documentation>simultane Lappendeckung</documentation> </annotation> </enumeration> <enumeration value="0107002"> <annotation> <documentation>simultane Eigenfetttransplantation</documentation> </annotation> </enumeration> <enumeration value="0107003"> <annotation> <documentation>simultane Mastopexie</documentation> </annotation> </enumeration> <enumeration value="0107005"> <annotation> <documentation>simultane Mastektomie, Ablatio / hautsparend</documentation> </pre>		

	<pre> </annotation> </enumeration> <enumeration value="0107006"> <annotation> <documentation>simultane Mastektomie, nippelerhaltend</documentation> </annotation> </enumeration> <enumeration value="0107007"> <annotation> <documentation>Axilla-Dissektion</documentation> </annotation> </enumeration> <enumeration value="0107008"> <annotation> <documentation>Drainage</documentation> </annotation> </enumeration> <enumeration value="0107009"> <annotation> <documentation>Kapsulektomie, komplett</documentation> </annotation> </enumeration> <enumeration value="0107010"> <annotation> <documentation>Kapsulektomie, partiell</documentation> </annotation> </enumeration> <enumeration value="0107011"> <annotation> <documentation>Neopocket</documentation> </annotation> </enumeration> </restriction> </simpleType> </pre>
--	--

simpleType enum_0110

namespace	http://xml.lir-d.de/irdsa						
type	restriction of string						
properties	base xs:string						
facets	<table border="1"> <thead> <tr> <th>Kind</th> <th>Value</th> <th>Annotation</th> </tr> </thead> <tbody> <tr> <td>enumeration</td> <td>0110001</td> <td>documentation Bestrahlung</td> </tr> </tbody> </table>	Kind	Value	Annotation	enumeration	0110001	documentation Bestrahlung
Kind	Value	Annotation					
enumeration	0110001	documentation Bestrahlung					
annotation	documentation Kat_BI_VorbehandlungLokal						
source	<pre> <simpleType name="enum_0110"> <annotation> <documentation>Kat_BI_VorbehandlungLokal</documentation> </annotation> <restriction base="xs:string"> <enumeration value="0110001"> <annotation> <documentation>Bestrahlung</documentation> </annotation> </enumeration> </restriction> </pre>						

	<code></simpleType></code>
--	----------------------------------

simpleType enum_0111

namespace	http://xml.ir-d.de/irdsa		
type	restriction of string		
properties	base xs:string		
facets	Kind	Value	Annotation
	enumeration	0111001	documentation nein
	enumeration	0111002	documentation Lipofilling
	enumeration	0111003	documentation Eigengewebstrekonstruktion
annotation	documentation Kat_BI_Verfahrenswechsel		
source	<pre> <simpleType name="enum_0111"> <annotation> <documentation>Kat_BI_Verfahrenswechsel</documentation> </annotation> <restriction base="xs:string"> <enumeration value="0111001"> <annotation> <documentation>nein</documentation> </annotation> </enumeration> <enumeration value="0111002"> <annotation> <documentation>Lipofilling</documentation> </annotation> </enumeration> <enumeration value="0111003"> <annotation> <documentation>Eigengewebstrekonstruktion</documentation> </annotation> </enumeration> </restriction> </simpleType> </pre>		

simpleType enum_0112

namespace	http://xml.ir-d.de/irdsa		
type	restriction of string		
properties	base xs:string		
facets	Kind	Value	Annotation
	enumeration	0112001	documentation subglandulär / epipektoral
	enumeration	0112002	documentation subpektoral
	enumeration	0112003	documentation subfaszial
	enumeration	0112004	documentation sub-flap
	enumeration	0112005	documentation subkutan

	enumeration 0112006 documentation dual plane enumeration 0112042 documentation andere
annotation	documentation Kat_BI_LageImplantat
source	<pre> <simpleType name="enum_0112"> <annotation> <documentation>Kat_BI_LageImplantat</documentation> </annotation> <restriction base="xs:string"> <enumeration value="0112001"> <annotation> <documentation>subglandulär / epipektoral</documentation> </annotation> </enumeration> <enumeration value="0112002"> <annotation> <documentation>subpektoral</documentation> </annotation> </enumeration> <enumeration value="0112003"> <annotation> <documentation>subfaszial</documentation> </annotation> </enumeration> <enumeration value="0112004"> <annotation> <documentation>sub-flap</documentation> </annotation> </enumeration> <enumeration value="0112005"> <annotation> <documentation>subkutan</documentation> </annotation> </enumeration> <enumeration value="0112006"> <annotation> <documentation>dual plane</documentation> </annotation> </enumeration> <enumeration value="0112042"> <annotation> <documentation>andere</documentation> </annotation> </enumeration> </restriction> </simpleType> </pre>

simpleType enum_0113

namespace	http://xml.ir-d.de/irdsa		
type	restriction of string		
properties	base xs:string		
facets	Kind enumeration	Value 0113001	Annotation documentation Chemotherapie innerhalb der letzten drei Monate

annotation	documentation Kat_BI_VorbehandlungSystemisch
source	<pre> <simpleType name="enum_0113"> <annotation> <documentation>Kat_BI_VorbehandlungSystemisch</documentation> </annotation> <restriction base="xs:string"> <enumeration value="0113001"> <annotation> <documentation>Chemotherapie innerhalb der letzten drei Monate</documentation> </annotation> </enumeration> </restriction> </simpleType> </pre>

simpleType enum_0114

namespace	http://xml.ir-d.de/irdsa		
type	restriction of string		
properties	base xs:string		
facets	Kind	Value	Annotation
	enumeration	0114001	documentation vollständig
	enumeration	0114002	documentation nein
	enumeration	0114003	documentation teilweise
	enumeration	0114004	documentation nicht vorhanden
annotation	documentation Kat_BI_EntfernungADMNetz		
source	<pre> <simpleType name="enum_0114"> <annotation> <documentation>Kat_BI_EntfernungADMNetz</documentation> </annotation> <restriction base="xs:string"> <enumeration value="0114001"> <annotation> <documentation>vollständig</documentation> </annotation> </enumeration> <enumeration value="0114002"> <annotation> <documentation>nein</documentation> </annotation> </enumeration> <enumeration value="0114003"> <annotation> <documentation>teilweise</documentation> </annotation> </enumeration> <enumeration value="0114004"> <annotation> <documentation>nicht vorhanden</documentation> </annotation> </enumeration> </restriction> </simpleType> </pre>		

```

</restriction>
</simpleType>

```

simpleType enum_0116

namespace	http://xml.ir-d.de/irdsa		
type	restriction of string		
properties	base xs:string		
facets	Kind	Value	Annotation
	enumeration	0116001	documentation Spülung, antibiotisch
	enumeration	0116002	documentation Spülung, antiseptisch
	enumeration	0116003	documentation Spülung, wirkstofffrei
	enumeration	0116004	documentation Spülung, andere
	enumeration	0116005	documentation prä-/perioperative Antibiotika
	enumeration	0116006	documentation postoperative Antibiotika
	enumeration	0116007	documentation Handschuhwechsel vor Implantation
	enumeration	0116008	documentation Implantationshilfe
annotation	documentation Kat_BI_Operationsmassnahme		
source	<pre> <simpleType name="enum_0116"> <annotation> <documentation>Kat_BI_Operationsmassnahme</documentation> </annotation> <restriction base="xs:string"> <enumeration value="0116001"> <annotation> <documentation>Spülung, antibiotisch</documentation> </annotation> </enumeration> <enumeration value="0116002"> <annotation> <documentation>Spülung, antiseptisch</documentation> </annotation> </enumeration> <enumeration value="0116003"> <annotation> <documentation>Spülung, wirkstofffrei</documentation> </annotation> </enumeration> <enumeration value="0116004"> <annotation> <documentation>Spülung, andere</documentation> </annotation> </enumeration> <enumeration value="0116005"> <annotation> <documentation>prä-/perioperative Antibiotika</documentation> </annotation> </enumeration> <enumeration value="0116006"> </pre>		

	<pre> <annotation> <documentation>postoperative Antibiotika</documentation> </annotation> </enumeration> <enumeration value="0116007"> <annotation> <documentation>Handschuhwechsel vor Implantation</documentation> </annotation> </enumeration> <enumeration value="0116008"> <annotation> <documentation>Implantationshilfe</documentation> </annotation> </enumeration> </restriction> </simpleType> </pre>
--	---

simpleType enum_0118

namespace	http://xml.ir-d.de/irdsa		
type	restriction of string		
properties	base xs:string		
facets	Kind	Value	Annotation
	enumeration	0118001	documentation axillär
	enumeration	0118002	documentation periareolär
	enumeration	0118003	documentation inframammär
	enumeration	0118004	documentation Mastektomienarbe
	enumeration	0118042	documentation anderer
annotation	documentation Kat_BI_Operationszugang		
source	<pre> <simpleType name="enum_0118"> <annotation> <documentation>Kat_BI_Operationszugang</documentation> </annotation> <restriction base="xs:string"> <enumeration value="0118001"> <annotation> <documentation>axillär</documentation> </annotation> </enumeration> <enumeration value="0118002"> <annotation> <documentation>periareolär</documentation> </annotation> </enumeration> <enumeration value="0118003"> <annotation> <documentation>inframammär</documentation> </annotation> </enumeration> <enumeration value="0118004"> <annotation> </pre>		

	<pre> <documentation>Mastektomienarbe</documentation> </annotation> </enumeration> <enumeration value="0118042"> <annotation> <documentation>anderer</documentation> </annotation> </enumeration> </restriction> </simpleType> </pre>
--	---

simpleType enum_0120

namespace	http://xml.ir-d.de/irdsa		
type	restriction of string		
properties	base xs:string		
facets	Kind	Value	Annotation
	enumeration	0120001	documentation Expander defekt
annotation	documentation Kat_BI_BefundAustausch		
source	<pre> <simpleType name="enum_0120"> <annotation> <documentation>Kat_BI_BefundAustausch</documentation> </annotation> <restriction base="xs:string"> <enumeration value="0120001"> <annotation> <documentation>Expander defekt</documentation> </annotation> </enumeration> </restriction> </simpleType> </pre>		

simpleType enum_0121

namespace	http://xml.ir-d.de/irdsa		
type	restriction of string		
properties	base xs:string		
facets	Kind	Value	Annotation
	enumeration	0121001	documentation Infektion
	enumeration	0121002	documentation Serom
	enumeration	0121004	documentation Kapsel fibrose
	enumeration	0121005	documentation Implantatruptur
	enumeration	0121006	documentation Fehlpositionierung/Rotation
	enumeration	0121007	documentation BIA-ALCL/-BCL/-SCC, Verdacht
	enumeration	0121008	documentation BIA-ALCL/-BCL/-SCC, pathologisch bestätigt
	enumeration	0121009	documentation

	<p>enumeration 0121010 Brustschmerzen documentation Doppelkapsel</p> <p>enumeration 0121011 documentation Netz-/ADM-bedingte Komplikation, Non-Integration</p> <p>enumeration 0121012 documentation Netz-/ADM-bedingte Komplikation, andere</p> <p>enumeration 0121013 documentation Hautnekrose/exponiertes Implantat</p> <p>enumeration 0121014 documentation BII/ASIA (Brustimplantat assoziierte Symptome), Verdacht</p> <p>enumeration 0121015 documentation Lymphadenopathie</p> <p>enumeration 0121016 documentation Brustkrebs, neu aufgetreten/Rezidiv</p> <p>enumeration 0121042 documentation sonstiger</p>
annotation	documentation Kat BI BefundKomplett
source	<pre> <simpleType name="enum_0121"> <annotation> <documentation>Kat_BI_BefundKomplett</documentation> </annotation> <restriction base="xs:string"> <enumeration value="0121001"> <annotation> <documentation>Infektion</documentation> </annotation> </enumeration> <enumeration value="0121002"> <annotation> <documentation>Serom</documentation> </annotation> </enumeration> <enumeration value="0121004"> <annotation> <documentation>Kapsel fibrose</documentation> </annotation> </enumeration> <enumeration value="0121005"> <annotation> <documentation>Implantatruptur</documentation> </annotation> </enumeration> <enumeration value="0121006"> <annotation> <documentation>Fehlpositionierung/Rotation</documentation> </annotation> </enumeration> <enumeration value="0121007"> <annotation> <documentation>BIA-ALCL/-BCL/-SCC, Verdacht</documentation> </annotation> </enumeration> <enumeration value="0121008"> <annotation> <documentation>BIA-ALCL/-BCL/-SCC, pathologisch bestätigt</documentation> </annotation> </enumeration> </restriction> </pre>

```

<enumeration value="0121009">
  <annotation>
    <documentation>Brustschmerzen</documentation>
  </annotation>
</enumeration>
<enumeration value="0121010">
  <annotation>
    <documentation>Doppelkapsel</documentation>
  </annotation>
</enumeration>
<enumeration value="0121011">
  <annotation>
    <documentation>Netz-/ADM-bedingte Komplikation, Non-
Integration</documentation>
  </annotation>
</enumeration>
<enumeration value="0121012">
  <annotation>
    <documentation>Netz-/ADM-bedingte Komplikation,
andere</documentation>
  </annotation>
</enumeration>
<enumeration value="0121013">
  <annotation>
    <documentation>Hautnekrose/exponiertes Implantat</documentation>
  </annotation>
</enumeration>
<enumeration value="0121014">
  <annotation>
    <documentation>BII/ASIA (Brustimplantat assoziierte Symptome),
Verdacht</documentation>
  </annotation>
</enumeration>
<enumeration value="0121015">
  <annotation>
    <documentation>Lymphadenopathie</documentation>
  </annotation>
</enumeration>
<enumeration value="0121016">
  <annotation>
    <documentation>Brustkrebs, neu aufgetreten/Rezidiv</documentation>
  </annotation>
</enumeration>
<enumeration value="0121042">
  <annotation>
    <documentation>sonstiger</documentation>
  </annotation>
</enumeration>
</restriction>
</simpleType>

```

simpleType enum_0122

namespace	http://xml.ir-d.de/irdsa
type	restriction of string
properties	base xs:string

facets	<table border="1"> <thead> <tr> <th>Kind</th> <th>Value</th> <th>Annotation</th> </tr> </thead> <tbody> <tr> <td>enumeration</td> <td>0122001</td> <td>documentation ja, ärztlich nachgewiesen</td> </tr> <tr> <td>enumeration</td> <td>0122002</td> <td>documentation nein</td> </tr> <tr> <td>enumeration</td> <td>0122042</td> <td>documentation unbekannt</td> </tr> </tbody> </table>	Kind	Value	Annotation	enumeration	0122001	documentation ja, ärztlich nachgewiesen	enumeration	0122002	documentation nein	enumeration	0122042	documentation unbekannt
Kind	Value	Annotation											
enumeration	0122001	documentation ja, ärztlich nachgewiesen											
enumeration	0122002	documentation nein											
enumeration	0122042	documentation unbekannt											
annotation	documentation Kat_BI_Autoimmunerkrankung												
source	<pre> <simpleType name="enum_0122"> <annotation> <documentation>Kat_BI_Autoimmunerkrankung</documentation> </annotation> <restriction base="xs:string"> <enumeration value="0122001"> <annotation> <documentation>ja, ärztlich nachgewiesen</documentation> </annotation> </enumeration> <enumeration value="0122002"> <annotation> <documentation>nein</documentation> </annotation> </enumeration> <enumeration value="0122042"> <annotation> <documentation>unbekannt</documentation> </annotation> </enumeration> </restriction> </simpleType> </pre>												

simpleType enum_0123

namespace	http://xml.ir-d.de/irdsa																		
type	restriction of string																		
properties	base xs:string																		
facets	<table border="1"> <thead> <tr> <th>Kind</th> <th>Value</th> <th>Annotation</th> </tr> </thead> <tbody> <tr> <td>enumeration</td> <td>0123001</td> <td>documentation neu aufgetreten</td> </tr> <tr> <td>enumeration</td> <td>0123002</td> <td>documentation verschlechtert</td> </tr> <tr> <td>enumeration</td> <td>0123003</td> <td>documentation keine Veränderung</td> </tr> <tr> <td>enumeration</td> <td>0123004</td> <td>documentation nicht relevant, da Primäreingriff</td> </tr> <tr> <td>enumeration</td> <td>0123042</td> <td>documentation unbekannt</td> </tr> </tbody> </table>	Kind	Value	Annotation	enumeration	0123001	documentation neu aufgetreten	enumeration	0123002	documentation verschlechtert	enumeration	0123003	documentation keine Veränderung	enumeration	0123004	documentation nicht relevant, da Primäreingriff	enumeration	0123042	documentation unbekannt
Kind	Value	Annotation																	
enumeration	0123001	documentation neu aufgetreten																	
enumeration	0123002	documentation verschlechtert																	
enumeration	0123003	documentation keine Veränderung																	
enumeration	0123004	documentation nicht relevant, da Primäreingriff																	
enumeration	0123042	documentation unbekannt																	
annotation	documentation Kat_BI_VerlaufAutoimmunerkrankung																		
source	<pre> <simpleType name="enum_0123"> <annotation> <documentation>Kat_BI_VerlaufAutoimmunerkrankung</documentation> </annotation> <restriction base="xs:string"> <enumeration value="0123001"> <annotation> <documentation>neu aufgetreten</documentation> </annotation> </enumeration> </restriction> </simpleType> </pre>																		

	<pre> </annotation> </enumeration> <enumeration value="0123002"> <annotation> <documentation>verschlechtert</documentation> </annotation> </enumeration> <enumeration value="0123003"> <annotation> <documentation>keine Veränderung</documentation> </annotation> </enumeration> <enumeration value="0123004"> <annotation> <documentation>nicht relevant, da Primäreingriff</documentation> </annotation> </enumeration> <enumeration value="0123042"> <annotation> <documentation>unbekannt</documentation> </annotation> </enumeration> </restriction> </simpleType> </pre>
--	---

simpleType enum_0124

namespace	http://xml.ir-d.de/irdsa		
type	restriction of string		
properties	base xs:string		
facets	Kind	Value	Annotation
	enumeration	0124001	documentation Salzlösung
	enumeration	0124002	documentation Silikongel
	enumeration	0124003	documentation Kombination Silikongel und Salzlösung
	enumeration	0124042	documentation sonstige
annotation	documentation Kat_BI_Fuellung		
source	<pre> <simpleType name="enum_0124"> <annotation> <documentation>Kat_BI_Fuellung</documentation> </annotation> <restriction base="xs:string"> <enumeration value="0124001"> <annotation> <documentation>Salzlösung</documentation> </annotation> </enumeration> <enumeration value="0124002"> <annotation> <documentation>Silikongel</documentation> </annotation> </enumeration> <enumeration value="0124003"> </pre>		

	<pre> <annotation> <documentation>Kombination Silikongel und Salzlösung</documentation> </annotation> </enumeration> <enumeration value="0124042"> <annotation> <documentation>sonstige</documentation> </annotation> </enumeration> </restriction> </simpleType> </pre>
--	--

simpleType enum_0126

namespace	http://xml.ir-d.de/irdsa		
type	restriction of string		
properties	base xs:string		
facets	Kind	Value	Annotation
	enumeration	0126001	documentation anatomisch (tropfenförmig)
	enumeration	0126002	documentation rund (punktsymmetrisch)
	enumeration	0126042	documentation sonstige
annotation	documentation Kat_BI_Form		
source	<pre> <simpleType name="enum_0126"> <annotation> <documentation>Kat_BI_Form</documentation> </annotation> <restriction base="xs:string"> <enumeration value="0126001"> <annotation> <documentation>anatomisch (tropfenförmig)</documentation> </annotation> </enumeration> <enumeration value="0126002"> <annotation> <documentation>rund (punktsymmetrisch)</documentation> </annotation> </enumeration> <enumeration value="0126042"> <annotation> <documentation>sonstige</documentation> </annotation> </enumeration> </restriction> </simpleType> </pre>		

simpleType enum_0128

namespace	http://xml.ir-d.de/irdsa		
type	restriction of string		
properties	base xs:string		

facets	<table border="1"> <thead> <tr> <th>Kind</th> <th>Value</th> <th>Annotation</th> </tr> </thead> <tbody> <tr> <td>enumeration</td> <td>0128001</td> <td>documentation glattwandig</td> </tr> <tr> <td>enumeration</td> <td>0128002</td> <td>documentation beschichtet</td> </tr> <tr> <td>enumeration</td> <td>0128003</td> <td>documentation texturiert</td> </tr> </tbody> </table>	Kind	Value	Annotation	enumeration	0128001	documentation glattwandig	enumeration	0128002	documentation beschichtet	enumeration	0128003	documentation texturiert
Kind	Value	Annotation											
enumeration	0128001	documentation glattwandig											
enumeration	0128002	documentation beschichtet											
enumeration	0128003	documentation texturiert											
annotation	documentation Kat_BI_Oberflaeche												
source	<pre> <simpleType name="enum_0128"> <annotation> <documentation>Kat_BI_Oberflaeche</documentation> </annotation> <restriction base="xs:string"> <enumeration value="0128001"> <annotation> <documentation>glattwandig</documentation> </annotation> </enumeration> <enumeration value="0128002"> <annotation> <documentation>beschichtet</documentation> </annotation> </enumeration> <enumeration value="0128003"> <annotation> <documentation>texturiert</documentation> </annotation> </enumeration> </restriction> </simpleType> </pre>												

simpleType enum_0131

namespace	http://xml.ir-d.de/irdsa																																				
type	restriction of string																																				
properties	base xs:string																																				
facets	<table border="1"> <thead> <tr> <th>Kind</th> <th>Value</th> <th>Annotation</th> </tr> </thead> <tbody> <tr> <td>enumeration</td> <td>0131001</td> <td>documentation Allergan</td> </tr> <tr> <td>enumeration</td> <td>0131002</td> <td>documentation Establishment Labs</td> </tr> <tr> <td>enumeration</td> <td>0131003</td> <td>documentation Eurosilicone</td> </tr> <tr> <td>enumeration</td> <td>0131004</td> <td>documentation Galatea</td> </tr> <tr> <td>enumeration</td> <td>0131005</td> <td>documentation Integra</td> </tr> <tr> <td>enumeration</td> <td>0131006</td> <td>documentation Lifecell</td> </tr> <tr> <td>enumeration</td> <td>0131007</td> <td>documentation MBP (Medical Biomaterial Products)</td> </tr> <tr> <td>enumeration</td> <td>0131008</td> <td>documentation Mentor</td> </tr> <tr> <td>enumeration</td> <td>0131009</td> <td>documentation Novus Scientific</td> </tr> <tr> <td>enumeration</td> <td>0131010</td> <td>documentation pfmMedical</td> </tr> <tr> <td>enumeration</td> <td>0131011</td> <td>documentation</td> </tr> </tbody> </table>	Kind	Value	Annotation	enumeration	0131001	documentation Allergan	enumeration	0131002	documentation Establishment Labs	enumeration	0131003	documentation Eurosilicone	enumeration	0131004	documentation Galatea	enumeration	0131005	documentation Integra	enumeration	0131006	documentation Lifecell	enumeration	0131007	documentation MBP (Medical Biomaterial Products)	enumeration	0131008	documentation Mentor	enumeration	0131009	documentation Novus Scientific	enumeration	0131010	documentation pfmMedical	enumeration	0131011	documentation
Kind	Value	Annotation																																			
enumeration	0131001	documentation Allergan																																			
enumeration	0131002	documentation Establishment Labs																																			
enumeration	0131003	documentation Eurosilicone																																			
enumeration	0131004	documentation Galatea																																			
enumeration	0131005	documentation Integra																																			
enumeration	0131006	documentation Lifecell																																			
enumeration	0131007	documentation MBP (Medical Biomaterial Products)																																			
enumeration	0131008	documentation Mentor																																			
enumeration	0131009	documentation Novus Scientific																																			
enumeration	0131010	documentation pfmMedical																																			
enumeration	0131011	documentation																																			

	<p>enumeration 0131012 Serag Wiessner documentation nicht belegter Wert</p> <p>enumeration 0131013 documentation nicht belegter Wert</p> <p>enumeration 0131014 documentation nicht belegter Wert</p> <p>enumeration 0131015 documentation nicht belegter Wert</p> <p>enumeration 0131042 documentation sonstiger</p>
annotation	documentation Kat BI_ZubehoerHersteller
source	<pre> <simpleType name="enum_0131"> <annotation> <documentation>Kat_BI_ZubehoerHersteller</documentation> </annotation> <restriction base="xs:string"> <enumeration value="0131001"> <annotation> <documentation>Allergan</documentation> </annotation> </enumeration> <enumeration value="0131002"> <annotation> <documentation>Establishment Labs</documentation> </annotation> </enumeration> <enumeration value="0131003"> <annotation> <documentation>Eurosilicone</documentation> </annotation> </enumeration> <enumeration value="0131004"> <annotation> <documentation>Galatea</documentation> </annotation> </enumeration> <enumeration value="0131005"> <annotation> <documentation>Integra</documentation> </annotation> </enumeration> <enumeration value="0131006"> <annotation> <documentation>Lifecell</documentation> </annotation> </enumeration> <enumeration value="0131007"> <annotation> <documentation>MBP (Medical Biomaterial Products)</documentation> </annotation> </enumeration> <enumeration value="0131008"> <annotation> <documentation>Mentor</documentation> </annotation> </enumeration> <enumeration value="0131009"> <annotation> </pre>

```

    <documentation>Novus Scientific</documentation>
  </annotation>
</enumeration>
<enumeration value="0131010">
  <annotation>
    <documentation>pfmMedical</documentation>
  </annotation>
</enumeration>
<enumeration value="0131011">
  <annotation>
    <documentation>Serag Wiessner</documentation>
  </annotation>
</enumeration>
<enumeration value="0131012">
  <annotation>
    <documentation>nicht belegter Wert</documentation>
  </annotation>
</enumeration>
<enumeration value="0131013">
  <annotation>
    <documentation>nicht belegter Wert</documentation>
  </annotation>
</enumeration>
<enumeration value="0131014">
  <annotation>
    <documentation>nicht belegter Wert</documentation>
  </annotation>
</enumeration>
<enumeration value="0131015">
  <annotation>
    <documentation>nicht belegter Wert</documentation>
  </annotation>
</enumeration>
<enumeration value="0131042">
  <annotation>
    <documentation>sonstiger</documentation>
  </annotation>
</enumeration>
</restriction>
</simpleType>

```

simpleType enum_0170

namespace	http://xml.ir-d.de/irdsa		
type	restriction of string		
properties	base xs:string		
facets	Kind	Value	Annotation
	enumeration	0170001	documentation weiblich
	enumeration	0170002	documentation männlich
	enumeration	0170003	documentation intersexuell
annotation	documentation Kat_Bl_GeschlechtGeburt		
source	<simpleType name="enum_0170"> <annotation>		

	<pre> <documentation>Kat_BI_GeschlechtGeburt</documentation> </annotation> <restriction base="xs:string"> <enumeration value="0170001"> <annotation> <documentation>weiblich</documentation> </annotation> </enumeration> <enumeration value="0170002"> <annotation> <documentation>männlich</documentation> </annotation> </enumeration> <enumeration value="0170003"> <annotation> <documentation>intersexuell</documentation> </annotation> </enumeration> </restriction> </simpleType> </pre>
--	---

simpleType enum_0190

namespace	http://xml.ir-d.de/irdsa		
type	restriction of string		
properties	base xs:string		
facets	Kind	Value	Annotation
	enumeration	0190001	documentation Brustimplantat
	enumeration	0190003	documentation Brustexpander
annotation	documentation Kat_BI_Artikeltyp		
source	<pre> <simpleType name="enum_0190"> <annotation> <documentation>Kat_BI_Artikeltyp</documentation> </annotation> <restriction base="xs:string"> <enumeration value="0190001"> <annotation> <documentation>Brustimplantat</documentation> </annotation> </enumeration> <enumeration value="0190003"> <annotation> <documentation>Brustexpander</documentation> </annotation> </enumeration> </restriction> </simpleType> </pre>		

simpleType enum_0191

namespace	http://xml.ir-d.de/irdsa
-----------	--------------------------

type	restriction of string									
properties	base xs:string									
facets	<table border="1"> <thead> <tr> <th>Kind</th> <th>Value</th> <th>Annotation</th> </tr> </thead> <tbody> <tr> <td>enumeration</td> <td>0191001</td> <td>documentation Netz</td> </tr> <tr> <td>enumeration</td> <td>0191002</td> <td>documentation ADM</td> </tr> </tbody> </table>	Kind	Value	Annotation	enumeration	0191001	documentation Netz	enumeration	0191002	documentation ADM
Kind	Value	Annotation								
enumeration	0191001	documentation Netz								
enumeration	0191002	documentation ADM								
annotation	documentation Kat_BI_ZubehoerTyp									
source	<pre><simpleType name="enum_0191"> <annotation> <documentation>Kat_BI_ZubehoerTyp</documentation> </annotation> <restriction base="xs:string"> <enumeration value="0191001"> <annotation> <documentation>Netz</documentation> </annotation> </enumeration> <enumeration value="0191002"> <annotation> <documentation>ADM</documentation> </annotation> </enumeration> </restriction> </simpleType></pre>									

simpleType **enum_0200**

namespace	http://xml.ir-d.de/irdsa									
type	restriction of string									
properties	base xs:string									
facets	<table border="1"> <thead> <tr> <th>Kind</th> <th>Value</th> <th>Annotation</th> </tr> </thead> <tbody> <tr> <td>enumeration</td> <td>0200001</td> <td>documentation Erst-OP</td> </tr> <tr> <td>enumeration</td> <td>0200002</td> <td>documentation Folgeingriff</td> </tr> </tbody> </table>	Kind	Value	Annotation	enumeration	0200001	documentation Erst-OP	enumeration	0200002	documentation Folgeingriff
Kind	Value	Annotation								
enumeration	0200001	documentation Erst-OP								
enumeration	0200002	documentation Folgeingriff								
annotation	documentation Kat_EP_ArtEingriff									
source	<pre><simpleType name="enum_0200"> <annotation> <documentation>Kat_EP_ArtEingriff</documentation> </annotation> <restriction base="xs:string"> <enumeration value="0200001"> <annotation> <documentation>Erst-OP</documentation> </annotation> </enumeration> <enumeration value="0200002"> <annotation> <documentation>Folgeingriff</documentation> </annotation> </enumeration> </restriction> </simpleType></pre>									

</simpleType>

simpleType enum_0202

namespace	http://xml.ir-d.de/irdsa		
type	restriction of string		
properties	base xs:string		
facets	Kind	Value	Annotation
	enumeration	0202001	documentation Lockerung
	enumeration	0202002	documentation Infektion, Verdacht auf
	enumeration	0202003	documentation Infektion, gesichert
	enumeration	0202004	documentation Luxation, Inlay aus der Pfanne
	enumeration	0202005	documentation Luxation, Kopf aus Pfanne/Inlay
	enumeration	0202006	documentation Periprothetische Fraktur
	enumeration	0202007	documentation Verschleiß des PE-Inlays
	enumeration	0202008	documentation Implantatbruch
	enumeration	0202009	documentation Implantatfehlage/Malalignement
	enumeration	0202010	documentation Osteolysen bei festem Implantat
	enumeration	0202011	documentation Progression der Grunderkrankung
	enumeration	0202012	documentation ARMD
	enumeration	0202013	documentation Verdacht auf allergische Reaktion
	enumeration	0202042	documentation andere Gründe
annotation	documentation Kat_EP_GrundWechselHuefte		
source	<pre><simpleType name="enum_0202"> <annotation> <documentation>Kat_EP_GrundWechselHuefte</documentation> </annotation> <restriction base="xs:string"> <enumeration value="0202001"> <annotation> <documentation>Lockerung</documentation> </annotation> </enumeration> <enumeration value="0202002"> <annotation> <documentation>Infektion, Verdacht auf</documentation> </annotation> </enumeration> <enumeration value="0202003"> <annotation> <documentation>Infektion, gesichert</documentation> </annotation> </enumeration> <enumeration value="0202004"></pre>		

```

    <annotation>
      <documentation>Luxation, Inlay aus der Pfanne</documentation>
    </annotation>
  </enumeration>
  <enumeration value="0202005">
    <annotation>
      <documentation>Luxation, Kopf aus Pfanne/Inlay</documentation>
    </annotation>
  </enumeration>
  <enumeration value="0202006">
    <annotation>
      <documentation>Periprothetische Fraktur</documentation>
    </annotation>
  </enumeration>
  <enumeration value="0202007">
    <annotation>
      <documentation>Verschleiß des PE-Inlays</documentation>
    </annotation>
  </enumeration>
  <enumeration value="0202008">
    <annotation>
      <documentation>Implantatbruch</documentation>
    </annotation>
  </enumeration>
  <enumeration value="0202009">
    <annotation>
      <documentation>Implantatfehlage/Malalignent</documentation>
    </annotation>
  </enumeration>
  <enumeration value="0202010">
    <annotation>
      <documentation>Osteolysen bei festem Implantat</documentation>
    </annotation>
  </enumeration>
  <enumeration value="0202011">
    <annotation>
      <documentation>Progression der Grunderkrankung</documentation>
    </annotation>
  </enumeration>
  <enumeration value="0202012">
    <annotation>
      <documentation>ARMD</documentation>
    </annotation>
  </enumeration>
  <enumeration value="0202013">
    <annotation>
      <documentation>Verdacht auf allergische Reaktion</documentation>
    </annotation>
  </enumeration>
  <enumeration value="0202042">
    <annotation>
      <documentation>andere Gründe</documentation>
    </annotation>
  </enumeration>
</restriction>
</simpleType>

```

simpleType enum_0204

namespace	http://xml.ir-d.de/irdsa		
type	restriction of string		
properties	base xs:string		
facets	Kind	Value	Annotation
	enumeration	0204001	documentation Lockerung
	enumeration	0204002	documentation Infektion, Verdacht auf
	enumeration	0204003	documentation Infektion, gesichert
	enumeration	0204006	documentation Periprothetische Fraktur
	enumeration	0204007	documentation Verschleiß
	enumeration	0204008	documentation Implantatbruch
	enumeration	0204009	documentation Implantatfehlage/Malalignent
	enumeration	0204010	documentation Osteolysen bei festem Implantat
	enumeration	0204011	documentation Progression der Grunderkrankung
	enumeration	0204012	documentation ARM-D
	enumeration	0204013	documentation Verdacht auf allergische Reaktion
	enumeration	0204014	documentation Dislokation/Migration von Komponenten
	enumeration	0204015	documentation Bandinstabilität
	enumeration	0204016	documentation Bewegungseinschränkung
	enumeration	0204042	documentation andere Gründe
annotation	documentation Kat_EP_GrundWechselKnie		
source	<pre> <simpleType name="enum_0204"> <annotation> <documentation>Kat_EP_GrundWechselKnie</documentation> </annotation> <restriction base="xs:string"> <enumeration value="0204001"> <annotation> <documentation>Lockerung</documentation> </annotation> </enumeration> <enumeration value="0204002"> <annotation> <documentation>Infektion, Verdacht auf</documentation> </annotation> </enumeration> <enumeration value="0204003"> <annotation> <documentation>Infektion, gesichert</documentation> </annotation> </enumeration> <enumeration value="0204006"> <annotation> <documentation>Periprothetische Fraktur</documentation> </annotation> </enumeration> <enumeration value="0204007"> <annotation> <documentation>Verschleiß</documentation> </annotation> </enumeration> <enumeration value="0204008"> <annotation> <documentation>Implantatbruch</documentation> </annotation> </enumeration> <enumeration value="0204009"> <annotation> <documentation>Implantatfehlage/Malalignent</documentation> </annotation> </enumeration> <enumeration value="0204010"> <annotation> <documentation>Osteolysen bei festem Implantat</documentation> </annotation> </enumeration> <enumeration value="0204011"> <annotation> <documentation>Progression der Grunderkrankung</documentation> </annotation> </enumeration> <enumeration value="0204012"> <annotation> <documentation>ARM-D</documentation> </annotation> </enumeration> <enumeration value="0204013"> <annotation> <documentation>Verdacht auf allergische Reaktion</documentation> </annotation> </enumeration> <enumeration value="0204014"> <annotation> <documentation>Dislokation/Migration von Komponenten</documentation> </annotation> </enumeration> <enumeration value="0204015"> <annotation> <documentation>Bandinstabilität</documentation> </annotation> </enumeration> <enumeration value="0204016"> <annotation> <documentation>Bewegungseinschränkung</documentation> </annotation> </enumeration> <enumeration value="0204042"> <annotation> <documentation>andere Gründe</documentation> </annotation> </enumeration> </restriction> </simpleType> </pre>		

```
</annotation>
</enumeration>
<enumeration value="0204007">
  <annotation>
    <documentation>Verschleiß</documentation>
  </annotation>
</enumeration>
<enumeration value="0204008">
  <annotation>
    <documentation>Implantatbruch</documentation>
  </annotation>
</enumeration>
<enumeration value="0204009">
  <annotation>
    <documentation>Implantatfehllage/Malalignent</documentation>
  </annotation>
</enumeration>
<enumeration value="0204010">
  <annotation>
    <documentation>Osteolysen bei festem Implantat</documentation>
  </annotation>
</enumeration>
<enumeration value="0204011">
  <annotation>
    <documentation>Progression der Grunderkrankung</documentation>
  </annotation>
</enumeration>
<enumeration value="0204012">
  <annotation>
    <documentation>ARMD</documentation>
  </annotation>
</enumeration>
<enumeration value="0204013">
  <annotation>
    <documentation>Verdacht auf allergische Reaktion</documentation>
  </annotation>
</enumeration>
<enumeration value="0204014">
  <annotation>
    <documentation>Dislokation/Migration von Komponenten</documentation>
  </annotation>
</enumeration>
<enumeration value="0204015">
  <annotation>
    <documentation>Bandinstabilität</documentation>
  </annotation>
</enumeration>
<enumeration value="0204016">
  <annotation>
    <documentation>Bewegungseinschränkung</documentation>
  </annotation>
</enumeration>
<enumeration value="0204042">
  <annotation>
    <documentation>andere Gründe</documentation>
  </annotation>
</enumeration>
</restriction>
</simpleType>
```

simpleType enum 0206

namespace	http://xml.ir-d.de/irdsa		
type	restriction of string		
properties	base xs:string		
facets	Kind	Value	Annotation
	enumeration	0206001	documentation Lockerung
	enumeration	0206002	documentation Infektion, Verdacht auf
	enumeration	0206003	documentation Infektion, gesichert
	enumeration	0206004	documentation Luxation, Inlay aus der Pfanne
	enumeration	0206005	documentation Luxation, Kopf aus Pfanne/Inlay
	enumeration	0206006	documentation Periprothetische Fraktur
	enumeration	0206007	documentation Verschleiß
	enumeration	0206008	documentation Implantatbruch
	enumeration	0206009	documentation Implantatfehlage/Malalignent
	enumeration	0206010	documentation Osteolysen bei festem Implantat
	enumeration	0206011	documentation Progression der Grunderkrankung
	enumeration	0206012	documentation ARMD
	enumeration	0206013	documentation Verdacht auf allergische Reaktion
	enumeration	0206014	documentation Dislokation/Migration von Komponenten
	enumeration	0206015	documentation Bandinstabilität
	enumeration	0206016	documentation Bewegungseinschränkung
	enumeration	0206042	documentation andere Gründe
annotation	documentation Kat_EP_GrundWechselTFE		
source	<pre> <simpleType name="enum_0206"> <annotation> <documentation>Kat_EP_GrundWechselTFE</documentation> </annotation> <restriction base="xs:string"> <enumeration value="0206001"> <annotation> <documentation>Lockerung</documentation> </annotation> </enumeration> <enumeration value="0206002"> <annotation> <documentation>Infektion, Verdacht auf</documentation> </annotation> </enumeration> <enumeration value="0206003"> <annotation> <documentation>Infektion, gesichert</documentation> </annotation> </enumeration> <enumeration value="0206004"> <annotation> <documentation>Luxation, Inlay aus der Pfanne</documentation> </annotation> </enumeration> <enumeration value="0206005"> <annotation> <documentation>Luxation, Kopf aus Pfanne/Inlay</documentation> </annotation> </enumeration> <enumeration value="0206006"> <annotation> <documentation>Periprothetische Fraktur</documentation> </annotation> </enumeration> <enumeration value="0206007"> <annotation> <documentation>Verschleiß</documentation> </annotation> </enumeration> <enumeration value="0206008"> <annotation> <documentation>Implantatbruch</documentation> </annotation> </enumeration> <enumeration value="0206009"> <annotation> <documentation>Implantatfehlage/Malalignent</documentation> </annotation> </enumeration> <enumeration value="0206010"> <annotation> <documentation>Osteolysen bei festem Implantat</documentation> </annotation> </enumeration> <enumeration value="0206011"> <annotation> <documentation>Progression der Grunderkrankung</documentation> </annotation> </enumeration> <enumeration value="0206012"> <annotation> <documentation>ARMD</documentation> </annotation> </enumeration> <enumeration value="0206013"> <annotation> <documentation>Verdacht auf allergische Reaktion</documentation> </annotation> </enumeration> <enumeration value="0206014"> <annotation> <documentation>Dislokation/Migration von Komponenten</documentation> </annotation> </enumeration> <enumeration value="0206015"> <annotation> <documentation>Bandinstabilität</documentation> </annotation> </enumeration> <enumeration value="0206016"> <annotation> <documentation>Bewegungseinschränkung</documentation> </annotation> </enumeration> <enumeration value="0206042"> <annotation> <documentation>andere Gründe</documentation> </annotation> </enumeration> </restriction> </simpleType> </pre>		

```
<documentation>Infektion, gesichert</documentation>
</annotation>
</enumeration>
<enumeration value="0206004">
  <annotation>
    <documentation>Luxation, Inlay aus der Pfanne</documentation>
  </annotation>
</enumeration>
<enumeration value="0206005">
  <annotation>
    <documentation>Luxation, Kopf aus Pfanne/Inlay</documentation>
  </annotation>
</enumeration>
<enumeration value="0206006">
  <annotation>
    <documentation>Periprothetische Fraktur</documentation>
  </annotation>
</enumeration>
<enumeration value="0206007">
  <annotation>
    <documentation>Verschleiß</documentation>
  </annotation>
</enumeration>
<enumeration value="0206008">
  <annotation>
    <documentation>Implantatbruch</documentation>
  </annotation>
</enumeration>
<enumeration value="0206009">
  <annotation>
    <documentation>Implantatfehllage/Malalignent</documentation>
  </annotation>
</enumeration>
<enumeration value="0206010">
  <annotation>
    <documentation>Osteolysen bei festem Implantat</documentation>
  </annotation>
</enumeration>
<enumeration value="0206011">
  <annotation>
    <documentation>Progression der Grunderkrankung</documentation>
  </annotation>
</enumeration>
<enumeration value="0206012">
  <annotation>
    <documentation>ARMD</documentation>
  </annotation>
</enumeration>
<enumeration value="0206013">
  <annotation>
    <documentation>Verdacht auf allergische Reaktion</documentation>
  </annotation>
</enumeration>
<enumeration value="0206014">
  <annotation>
    <documentation>Dislokation/Migration von Komponenten</documentation>
  </annotation>
</enumeration>
<enumeration value="0206015">
```

	<pre> <annotation> <documentation>Bandinstabilität</documentation> </annotation> </enumeration> <enumeration value="0206016"> <annotation> <documentation>Bewegungseinschränkung</documentation> </annotation> </enumeration> <enumeration value="0206042"> <annotation> <documentation>andere Gründe</documentation> </annotation> </enumeration> </restriction> </simpleType> </pre>
--	--

simpleType enum_0210

namespace	http://xml.ir-d.de/irdsa		
type	restriction of string		
properties	base xs:string		
facets	Kind	Value	Annotation
	enumeration	0210001	documentation keine relevante Voroperation
	enumeration	0210002	documentation Osteosynthese/Osteotomie (Becken)
	enumeration	0210003	documentation Osteosynthese/Osteotomie (Femur)
	enumeration	0210004	documentation Osteosynthese/Osteotomie (beides)
	enumeration	0210005	documentation Operation bei Hüftkopfnekrose
	enumeration	0210006	documentation Arthrodese
	enumeration	0210042	documentation andere
annotation	documentation Kat_EP_VoroperationHuefte		
source	<pre> <simpleType name="enum_0210"> <annotation> <documentation>Kat_EP_VoroperationHuefte</documentation> </annotation> <restriction base="xs:string"> <enumeration value="0210001"> <annotation> <documentation>keine relevante Voroperation</documentation> </annotation> </enumeration> <enumeration value="0210002"> <annotation> <documentation>Osteosynthese/Osteotomie (Becken)</documentation> </annotation> </enumeration> <enumeration value="0210003"> <annotation> <documentation>Osteosynthese/Osteotomie (Femur)</documentation> </annotation> </enumeration> </restriction> </simpleType> </pre>		

	<pre> </annotation> </enumeration> <enumeration value="0210004"> <annotation> <documentation>Osteosynthese/Osteotomie (beides)</documentation> </annotation> </enumeration> <enumeration value="0210005"> <annotation> <documentation>Operation bei Hüftkopfnnekrose</documentation> </annotation> </enumeration> <enumeration value="0210006"> <annotation> <documentation>Arthrodese</documentation> </annotation> </enumeration> <enumeration value="0210042"> <annotation> <documentation>andere</documentation> </annotation> </enumeration> </restriction> </simpleType> </pre>
--	---

simpleType enum_0211

namespace	http://xml.ir-d.de/irdsa		
type	restriction of string		
properties	base xs:string		
facets	Kind	Value	Annotation
	enumeration	0211001	documentation keine relevante Voroperation
	enumeration	0211002	documentation Osteosynthese/Osteotomie (Femur)
	enumeration	0211003	documentation Osteosynthese/Osteotomie (Tibia)
	enumeration	0211004	documentation Osteosynthese/Osteotomie (Patella)
	enumeration	0211005	documentation Osteosynthese/Osteotomie (mehrere)
	enumeration	0211006	documentation Kapsel-/Bandapparat
	enumeration	0211007	documentation Arthrodese
	enumeration	0211042	documentation andere
annotation	documentation Kat_EP_VoroperationKnie		
source	<pre> <simpleType name="enum_0211"> <annotation> <documentation>Kat_EP_VoroperationKnie</documentation> </annotation> <restriction base="xs:string"> <enumeration value="0211001"> <annotation> <documentation>keine relevante Voroperation</documentation> </annotation> </pre>		

```

</enumeration>
<enumeration value="0211002">
  <annotation>
    <documentation>Osteosynthese/Osteotomie (Femur)</documentation>
  </annotation>
</enumeration>
<enumeration value="0211003">
  <annotation>
    <documentation>Osteosynthese/Osteotomie (Tibia)</documentation>
  </annotation>
</enumeration>
<enumeration value="0211004">
  <annotation>
    <documentation>Osteosynthese/Osteotomie (Patella)</documentation>
  </annotation>
</enumeration>
<enumeration value="0211005">
  <annotation>
    <documentation>Osteosynthese/Osteotomie (mehrere)</documentation>
  </annotation>
</enumeration>
<enumeration value="0211006">
  <annotation>
    <documentation>Kapsel-/Bandapparat</documentation>
  </annotation>
</enumeration>
<enumeration value="0211007">
  <annotation>
    <documentation>Arthrodesse</documentation>
  </annotation>
</enumeration>
<enumeration value="0211042">
  <annotation>
    <documentation>andere</documentation>
  </annotation>
</enumeration>
</restriction>
</simpleType>

```

simpleType **enum_0212**

namespace	http://xml.ir-d.de/irdsa		
type	restriction of string		
properties	base xs:string		
facets	Kind	Value	Annotation
	enumeration	0212001	documentation Hüfte
	enumeration	0212002	documentation Knie
	enumeration	0212003	documentation Totaler Femurersatz inkl. Durchsteck-Prothese
annotation	documentation Kat_EP_Gelenk		
source	<simpleType name="enum_0212"> <annotation> <documentation>Kat_EP_Gelenk</documentation> </annotation>		

	<pre> <restriction base="xs:string"> <enumeration value="0212001"> <annotation> <documentation>Hüfte</documentation> </annotation> </enumeration> <enumeration value="0212002"> <annotation> <documentation>Knie</documentation> </annotation> </enumeration> <enumeration value="0212003"> <annotation> <documentation>Totaler Femurersatz inkl. Durchsteck- Prothese</documentation> </annotation> </enumeration> </restriction> </simpleType> </pre>
--	---

simpleType enum 0220

namespace	http://xml.ir-d.de/irdsa		
type	restriction of string		
properties	base xs:string		
facets	Kind	Value	Annotation
	enumeration	0220001	documentation anterior
	enumeration	0220002	documentation anterolateral
	enumeration	0220003	documentation lateral
	enumeration	0220004	documentation posterior
	enumeration	0220005	documentation posterolateral
	enumeration	0220006	documentation 2-Inzisionen-Zugang
	enumeration	0220042	documentation sonstiger
annotation	documentation Kat_EP_Operationszugang		
source	<pre> <simpleType name="enum_0220"> <annotation> <documentation>Kat_EP_Operationszugang</documentation> </annotation> <restriction base="xs:string"> <enumeration value="0220001"> <annotation> <documentation>anterior</documentation> </annotation> </enumeration> <enumeration value="0220002"> <annotation> <documentation>anterolateral</documentation> </annotation> </enumeration> </restriction> </pre>		

	<pre> <enumeration value="0220003"> <annotation> <documentation>lateral</documentation> </annotation> </enumeration> <enumeration value="0220004"> <annotation> <documentation>posterior</documentation> </annotation> </enumeration> <enumeration value="0220005"> <annotation> <documentation>posterolateral</documentation> </annotation> </enumeration> <enumeration value="0220006"> <annotation> <documentation>2-Inzisionen-Zugang</documentation> </annotation> </enumeration> <enumeration value="0220042"> <annotation> <documentation>sonstiger</documentation> </annotation> </enumeration> </restriction> </simpleType> </pre>
--	---

simpleType enum_0222

namespace	http://xml.ir-d.de/irdsa		
type	restriction of string		
properties	base xs:string		
facets	Kind	Value	Annotation
	enumeration	0222001	documentation nein
	enumeration	0222002	documentation ja- Ausbau
	enumeration	0222003	documentation ja- Einbau
annotation	documentation Kat_EP_Zweizeitwechsel		
source	<pre> <simpleType name="enum_0222"> <annotation> <documentation>Kat_EP_Zweizeitwechsel</documentation> </annotation> <restriction base="xs:string"> <enumeration value="0222001"> <annotation> <documentation>nein</documentation> </annotation> </enumeration> <enumeration value="0222002"> <annotation> <documentation>ja- Ausbau</documentation> </annotation> </enumeration> </restriction> </simpleType> </pre>		

	<pre> <enumeration value="0222003"> <annotation> <documentation>ja- Einbau</documentation> </annotation> </enumeration> </restriction> </simpleType> </pre>
--	---

simpleType enum_0252

namespace	http://xml.ir-d.de/irdsa		
type	restriction of string		
properties	base xs:string		
facets	Kind	Value	Annotation
	enumeration	0252001	documentation Pfanne
	enumeration	0252002	documentation Schaft
	enumeration	0252003	documentation beides
annotation	documentation Kat_EP_KomponenteHuefte		
source	<pre> <simpleType name="enum_0252"> <annotation> <documentation>Kat_EP_KomponenteHuefte</documentation> </annotation> <restriction base="xs:string"> <enumeration value="0252001"> <annotation> <documentation>Pfanne</documentation> </annotation> </enumeration> <enumeration value="0252002"> <annotation> <documentation>Schaft</documentation> </annotation> </enumeration> <enumeration value="0252003"> <annotation> <documentation>beides</documentation> </annotation> </enumeration> </restriction> </simpleType> </pre>		

simpleType enum_0254

namespace	http://xml.ir-d.de/irdsa		
type	restriction of string		
properties	base xs:string		
facets	Kind	Value	Annotation
	enumeration	0254001	documentation Femur
	enumeration	0254002	documentation

	enumeration 0254003 Tibia documentation Patella enumeration 0254004 Tibia documentation mehrere
annotation	documentation Kat_EP_KomponenteKnie
source	<pre> <simpleType name="enum_0254"> <annotation> <documentation>Kat_EP_KomponenteKnie</documentation> </annotation> <restriction base="xs:string"> <enumeration value="0254001"> <annotation> <documentation>Femur</documentation> </annotation> </enumeration> <enumeration value="0254002"> <annotation> <documentation>Tibia</documentation> </annotation> </enumeration> <enumeration value="0254003"> <annotation> <documentation>Patella</documentation> </annotation> </enumeration> <enumeration value="0254004"> <annotation> <documentation>mehrere</documentation> </annotation> </enumeration> </restriction> </simpleType> </pre>

simpleType enum_0256

namespace	http://xml.ir-d.de/irdsa		
type	restriction of string		
properties	base xs:string		
facets	Kind	Value	Annotation
	enumeration	0256001	documentation Pfanne
	enumeration	0256002	documentation Schaft
	enumeration	0256003	documentation Pfanne und Schaft
	enumeration	0256004	documentation Femur
	enumeration	0256005	documentation Tibia
	enumeration	0256006	documentation Patella
	enumeration	0256007	documentation mehrere
annotation	documentation Kat_EP_KomponenteTFE		

source	<pre> <simpleType name="enum_0256"> <annotation> <documentation>Kat_EP_KomponenteTFE</documentation> </annotation> <restriction base="xs:string"> <enumeration value="0256001"> <annotation> <documentation>Pfanne</documentation> </annotation> </enumeration> <enumeration value="0256002"> <annotation> <documentation>Schaft</documentation> </annotation> </enumeration> <enumeration value="0256003"> <annotation> <documentation>Pfanne und Schaft</documentation> </annotation> </enumeration> <enumeration value="0256004"> <annotation> <documentation>Femur</documentation> </annotation> </enumeration> <enumeration value="0256005"> <annotation> <documentation>Tibia</documentation> </annotation> </enumeration> <enumeration value="0256006"> <annotation> <documentation>Patella</documentation> </annotation> </enumeration> <enumeration value="0256007"> <annotation> <documentation>mehrere</documentation> </annotation> </enumeration> </restriction> </simpleType> </pre>
--------	--

simpleType enum_0262

namespace	http://xml.ir-d.de/irdsa		
type	restriction of string		
properties	base xs:string		
facets	Kind	Value	Annotation
	enumeration	0262001	documentation Pfanne
	enumeration	0262002	documentation Schaft
	enumeration	0262003	documentation Kopf
	enumeration	0262004	documentation Inlay

	enumeration 0262005 documentation Adapter
	enumeration 0262006 documentation mehrere
annotation	documentation Kat_EP_ImplantatbruchHuefte
source	<pre> <simpleType name="enum_0262"> <annotation> <documentation>Kat_EP_ImplantatbruchHuefte</documentation> </annotation> <restriction base="xs:string"> <enumeration value="0262001"> <annotation> <documentation>Pfanne</documentation> </annotation> </enumeration> <enumeration value="0262002"> <annotation> <documentation>Schaft</documentation> </annotation> </enumeration> <enumeration value="0262003"> <annotation> <documentation>Kopf</documentation> </annotation> </enumeration> <enumeration value="0262004"> <annotation> <documentation>Inlay</documentation> </annotation> </enumeration> <enumeration value="0262005"> <annotation> <documentation>Adapter</documentation> </annotation> </enumeration> <enumeration value="0262006"> <annotation> <documentation>mehrere</documentation> </annotation> </enumeration> </restriction> </simpleType> </pre>

simpleType enum_0264

namespace	http://xml.ir-d.de/irdsa		
type	restriction of string		
properties	base xs:string		
facets	Kind	Value	Annotation
	enumeration	0264001	documentation Femur
	enumeration	0264002	documentation Tibia
	enumeration	0264003	documentation Inlay
	enumeration	0264004	documentation

	<p>enumeration 0264005 Adapter documentation Verlängerung</p> <p>enumeration 0264006 documentation Schrauben</p> <p>enumeration 0264007 documentation mehrere</p> <p>enumeration 0264042 documentation andere</p>
annotation	documentation Kat_EP_ImplantatbruchKnie
source	<pre> <simpleType name="enum_0264"> <annotation> <documentation>Kat_EP_ImplantatbruchKnie</documentation> </annotation> <restriction base="xs:string"> <enumeration value="0264001"> <annotation> <documentation>Femur</documentation> </annotation> </enumeration> <enumeration value="0264002"> <annotation> <documentation>Tibia</documentation> </annotation> </enumeration> <enumeration value="0264003"> <annotation> <documentation>Inlay</documentation> </annotation> </enumeration> <enumeration value="0264004"> <annotation> <documentation>Adapter</documentation> </annotation> </enumeration> <enumeration value="0264005"> <annotation> <documentation>Verlängerung</documentation> </annotation> </enumeration> <enumeration value="0264006"> <annotation> <documentation>Schrauben</documentation> </annotation> </enumeration> <enumeration value="0264007"> <annotation> <documentation>mehrere</documentation> </annotation> </enumeration> <enumeration value="0264042"> <annotation> <documentation>andere</documentation> </annotation> </enumeration> </restriction> </simpleType> </pre>

simpleType enum_0266

namespace	http://xml.ir-d.de/irdsa		
type	restriction of string		
properties	base xs:string		
facets	Kind	Value	Annotation
	enumeration	0266001	documentation Pfanne
	enumeration	0266002	documentation Schaft
	enumeration	0266003	documentation Kopf
	enumeration	0266004	documentation Inlay
	enumeration	0266005	documentation Adapter
	enumeration	0266006	documentation Femur
	enumeration	0266007	documentation Tibia
	enumeration	0266008	documentation Verlängerung
	enumeration	0266009	documentation Schrauben
	enumeration	0266010	documentation mehrere
	enumeration	0266042	documentation andere
annotation	documentation Kat_EP_ImplantatbruchTFE		
source	<pre> <simpleType name="enum_0266"> <annotation> <documentation>Kat_EP_ImplantatbruchTFE</documentation> </annotation> <restriction base="xs:string"> <enumeration value="0266001"> <annotation> <documentation>Pfanne</documentation> </annotation> </enumeration> <enumeration value="0266002"> <annotation> <documentation>Schaft</documentation> </annotation> </enumeration> <enumeration value="0266003"> <annotation> <documentation>Kopf</documentation> </annotation> </enumeration> <enumeration value="0266004"> <annotation> <documentation>Inlay</documentation> </annotation> </enumeration> <enumeration value="0266005"> <annotation> <documentation>Adapter</documentation> </annotation> </enumeration> </restriction> </simpleType> </pre>		

	<pre> </enumeration> <enumeration value="0266006"> <annotation> <documentation>Femur</documentation> </annotation> </enumeration> <enumeration value="0266007"> <annotation> <documentation>Tibia</documentation> </annotation> </enumeration> <enumeration value="0266008"> <annotation> <documentation>Verlängerung</documentation> </annotation> </enumeration> <enumeration value="0266009"> <annotation> <documentation>Schrauben</documentation> </annotation> </enumeration> <enumeration value="0266010"> <annotation> <documentation>mehrere</documentation> </annotation> </enumeration> <enumeration value="0266042"> <annotation> <documentation>andere</documentation> </annotation> </enumeration> </restriction> </simpleType> </pre>
--	--

simpleType enum_0270

namespace	http://xml.lir-d.de/irdsa		
type	restriction of string		
properties	base xs:string		
facets	Kind	Value	Annotation
	enumeration	0270001	documentation PE-Inlay
	enumeration	0270002	documentation patellare Komponente
	enumeration	0270003	documentation beides
annotation	documentation Kat_EP_VerschleissKnie		
source	<pre> <simpleType name="enum_0270"> <annotation> <documentation>Kat_EP_VerschleissKnie</documentation> </annotation> <restriction base="xs:string"> <enumeration value="0270001"> <annotation> <documentation>PE-Inlay</documentation> </annotation> </pre>		

	<pre> </enumeration> <enumeration value="0270002"> <annotation> <documentation>patellare Komponente</documentation> </annotation> </enumeration> <enumeration value="0270003"> <annotation> <documentation>beides</documentation> </annotation> </enumeration> </restriction> </simpleType> </pre>
--	--

simpleType enum_0271

namespace	http://xml.ir-d.de/irdsa																					
type	restriction of string																					
properties	base xs:string																					
facets	<table border="1"> <thead> <tr> <th>Kind</th> <th>Value</th> <th>Annotation</th> </tr> </thead> <tbody> <tr> <td>enumeration</td> <td>0271001</td> <td>documentation Schraube</td> </tr> <tr> <td>enumeration</td> <td>0271002</td> <td>documentation Inlay</td> </tr> <tr> <td>enumeration</td> <td>0271003</td> <td>documentation patellare Komponente</td> </tr> <tr> <td>enumeration</td> <td>0271004</td> <td>documentation Kopplung</td> </tr> <tr> <td>enumeration</td> <td>0271005</td> <td>documentation mehrere</td> </tr> <tr> <td>enumeration</td> <td>0271042</td> <td>documentation andere</td> </tr> </tbody> </table>	Kind	Value	Annotation	enumeration	0271001	documentation Schraube	enumeration	0271002	documentation Inlay	enumeration	0271003	documentation patellare Komponente	enumeration	0271004	documentation Kopplung	enumeration	0271005	documentation mehrere	enumeration	0271042	documentation andere
Kind	Value	Annotation																				
enumeration	0271001	documentation Schraube																				
enumeration	0271002	documentation Inlay																				
enumeration	0271003	documentation patellare Komponente																				
enumeration	0271004	documentation Kopplung																				
enumeration	0271005	documentation mehrere																				
enumeration	0271042	documentation andere																				
annotation	documentation Kat_EP_MigrationKnie																					
source	<pre> <simpleType name="enum_0271"> <annotation> <documentation>Kat_EP_MigrationKnie</documentation> </annotation> <restriction base="xs:string"> <enumeration value="0271001"> <annotation> <documentation>Schraube</documentation> </annotation> </enumeration> <enumeration value="0271002"> <annotation> <documentation>Inlay</documentation> </annotation> </enumeration> <enumeration value="0271003"> <annotation> <documentation>patellare Komponente</documentation> </annotation> </enumeration> <enumeration value="0271004"> <annotation> <documentation>Kopplung</documentation> </pre>																					

	<pre> </annotation> </enumeration> <enumeration value="0271005"> <annotation> <documentation>mehrere</documentation> </annotation> </enumeration> <enumeration value="0271042"> <annotation> <documentation>andere</documentation> </annotation> </enumeration> </restriction> </simpleType> </pre>
--	---

simpleType enum_0280

namespace	http://xml.lir-d.de/irdsa		
type	restriction of string		
properties	base xs:string		
facets	Kind	Value	Annotation
	enumeration	0280001	documentation Ohne
	enumeration	0280002	documentation PSI
	enumeration	0280003	documentation Navigation
	enumeration	0280004	documentation Robotik
	enumeration	0280042	documentation Unbekannt
annotation	documentation Kat_EP_AssistiveTechnologie		
source	<pre> <simpleType name="enum_0280"> <annotation> <documentation>Kat_EP_AssistiveTechnologie</documentation> </annotation> <restriction base="xs:string"> <enumeration value="0280001"> <annotation> <documentation>Ohne</documentation> </annotation> </enumeration> <enumeration value="0280002"> <annotation> <documentation>PSI</documentation> </annotation> </enumeration> <enumeration value="0280003"> <annotation> <documentation>Navigation</documentation> </annotation> </enumeration> <enumeration value="0280004"> <annotation> <documentation>Robotik</documentation> </annotation> </enumeration> </restriction> </simpleType> </pre>		

	<pre> </enumeration> <enumeration value="0280042"> <annotation> <documentation>Unbekannt</documentation> </annotation> </enumeration> </restriction> </simpleType> </pre>
--	---

simpleType enum_0281

namespace	http://xml.ir-d.de/irdsa		
type	restriction of string		
properties	base xs:string		
facets	Kind	Value	Annotation
	enumeration	0281001	documentation Aesculap - OrthoPilot
	enumeration	0281002	documentation Amplitude - Amplivision
	enumeration	0281003	documentation Johnson & Johnson - VELYS
	enumeration	0281004	documentation Orthokey - Orthokey Miro
	enumeration	0281005	documentation Orthokey - BLU-IGS
	enumeration	0281006	documentation Smith & Nephew - Brainlab Plattformen (TBD)
	enumeration	0281007	documentation Stryker - Stryker NAV3i
	enumeration	0281008	documentation Stryker - Stryker Ortho Q Guidance System
	enumeration	0281009	documentation ThinkSurgical - TMINI
	enumeration	0281010	documentation Zimmer Biomet - Sesamoid Navigation
	enumeration	0281011	documentation Zimmer Biomet - iAssist Navigation
	enumeration	0281012	documentation nicht belegter Wert
	enumeration	0281013	documentation nicht belegter Wert
	enumeration	0281014	documentation nicht belegter Wert
	enumeration	0281015	documentation nicht belegter Wert
	enumeration	0281016	documentation nicht belegter Wert
	enumeration	0281042	documentation sonstige
annotation	documentation Kat_EP_Navigation		
source	<pre> <simpleType name="enum_0281"> <annotation> <documentation>Kat_EP_Navigation</documentation> </annotation> <restriction base="xs:string"> <enumeration value="0281001"> <annotation> <documentation>Aesculap - OrthoPilot</documentation> </pre>		

```
</annotation>
</enumeration>
<enumeration value="0281002">
  <annotation>
    <documentation>Amplitude - Amplivision</documentation>
  </annotation>
</enumeration>
<enumeration value="0281003">
  <annotation>
    <documentation>Johnson & Johnson - VELYS</documentation>
  </annotation>
</enumeration>
<enumeration value="0281004">
  <annotation>
    <documentation>Orthokey - Orthokey Miro</documentation>
  </annotation>
</enumeration>
<enumeration value="0281005">
  <annotation>
    <documentation>Orthokey - BLU-IGS</documentation>
  </annotation>
</enumeration>
<enumeration value="0281006">
  <annotation>
    <documentation>Smith & Nephew - Brainlab Plattformen
(TBD)</documentation>
  </annotation>
</enumeration>
<enumeration value="0281007">
  <annotation>
    <documentation>Stryker - Stryker NAV3i</documentation>
  </annotation>
</enumeration>
<enumeration value="0281008">
  <annotation>
    <documentation>Stryker - Stryker Ortho Q Guidance
System</documentation>
  </annotation>
</enumeration>
<enumeration value="0281009">
  <annotation>
    <documentation>ThinkSurgical - TMINI</documentation>
  </annotation>
</enumeration>
<enumeration value="0281010">
  <annotation>
    <documentation>Zimmer Biomet - Sesamoid Navigation</documentation>
  </annotation>
</enumeration>
<enumeration value="0281011">
  <annotation>
    <documentation>Zimmer Biomet - iAssist Navigation</documentation>
  </annotation>
</enumeration>
<enumeration value="0281012">
  <annotation>
    <documentation>nicht belegter Wert</documentation>
  </annotation>
</enumeration>
```

```

<enumeration value="0281013">
  <annotation>
    <documentation>nicht belegter Wert</documentation>
  </annotation>
</enumeration>
<enumeration value="0281014">
  <annotation>
    <documentation>nicht belegter Wert</documentation>
  </annotation>
</enumeration>
<enumeration value="0281015">
  <annotation>
    <documentation>nicht belegter Wert</documentation>
  </annotation>
</enumeration>
<enumeration value="0281016">
  <annotation>
    <documentation>nicht belegter Wert</documentation>
  </annotation>
</enumeration>
<enumeration value="0281042">
  <annotation>
    <documentation>sonstige</documentation>
  </annotation>
</enumeration>
</restriction>
</simpleType>

```

simpleType enum_0282

namespace	http://xml.ir-d.de/irdsa		
type	restriction of string		
properties	base xs:string		
facets	Kind	Value	Annotation
	enumeration	0282001	documentation Amplitude - Andy
	enumeration	0282002	documentation Corin - ApolloKnee
	enumeration	0282003	documentation Corin - OMNIBotics
	enumeration	0282004	documentation Microport - Skywalker
	enumeration	0282005	documentation Orthokey - Orthokey Robin
	enumeration	0282006	documentation Smith & Nephew - CORI
	enumeration	0282007	documentation Smith & Nephew - NAVIO
	enumeration	0282008	documentation Stryker - Mako SmartRobotics
	enumeration	0282009	documentation Zimmer Biomet - ROSA
	enumeration	0282010	documentation Johnson & Johnson - VELYS Robotic Assisted Solution
	enumeration	0282011	documentation nicht belegter Wert
	enumeration	0282012	documentation nicht belegter Wert
	enumeration	0282013	documentation

	<p>enumeration 0282014 nicht belegter Wert documentation</p> <p>enumeration 0282015 nicht belegter Wert documentation</p> <p>enumeration 0282042 nicht belegter Wert documentation sonstige</p>
annotation	documentation Kat_EP_Robotik
source	<pre> <simpleType name="enum_0282"> <annotation> <documentation>Kat_EP_Robotik</documentation> </annotation> <restriction base="xs:string"> <enumeration value="0282001"> <annotation> <documentation>Amplitude - Andy</documentation> </annotation> </enumeration> <enumeration value="0282002"> <annotation> <documentation>Corin - ApolloKnee</documentation> </annotation> </enumeration> <enumeration value="0282003"> <annotation> <documentation>Corin - OMNIBotics</documentation> </annotation> </enumeration> <enumeration value="0282004"> <annotation> <documentation>Microport - Skywalker</documentation> </annotation> </enumeration> <enumeration value="0282005"> <annotation> <documentation>Orthokey - Orthokey Robin</documentation> </annotation> </enumeration> <enumeration value="0282006"> <annotation> <documentation>Smith & Nephew - CORI</documentation> </annotation> </enumeration> <enumeration value="0282007"> <annotation> <documentation>Smith & Nephew - NAVIO</documentation> </annotation> </enumeration> <enumeration value="0282008"> <annotation> <documentation>Stryker - Mako SmartRobotics</documentation> </annotation> </enumeration> <enumeration value="0282009"> <annotation> <documentation>Zimmer Biomet - ROSA</documentation> </annotation> </enumeration> </restriction> </simpleType> </pre>

```

<enumeration value="0282010">
  <annotation>
    <documentation>Johnson & Johnson - VELYS Robotic Assisted
Solution</documentation>
  </annotation>
</enumeration>
<enumeration value="0282011">
  <annotation>
    <documentation>nicht belegter Wert</documentation>
  </annotation>
</enumeration>
<enumeration value="0282012">
  <annotation>
    <documentation>nicht belegter Wert</documentation>
  </annotation>
</enumeration>
<enumeration value="0282013">
  <annotation>
    <documentation>nicht belegter Wert</documentation>
  </annotation>
</enumeration>
<enumeration value="0282014">
  <annotation>
    <documentation>nicht belegter Wert</documentation>
  </annotation>
</enumeration>
<enumeration value="0282015">
  <annotation>
    <documentation>nicht belegter Wert</documentation>
  </annotation>
</enumeration>
<enumeration value="0282042">
  <annotation>
    <documentation>sonstige</documentation>
  </annotation>
</enumeration>
</restriction>
</simpleType>

```

simpleType enum 0290

namespace	http://xml.ir-d.de/irdsa		
type	restriction of string		
properties	base xs:string		
facets	Kind	Value	Annotation
	enumeration	0290001	documentation Hüft-Komponente
	enumeration	0290002	documentation Knie-Komponente
	enumeration	0290003	documentation Modulare Komponente (Hüfte/Knie)
	enumeration	0290004	documentation Knochenzement
	enumeration	0290042	documentation sonstiger
annotation	documentation Kat_EP_Artikeltyp		

source	<pre> <simpleType name="enum_0290"> <annotation> <documentation>Kat_EP_Artikeltyp</documentation> </annotation> <restriction base="xs:string"> <enumeration value="0290001"> <annotation> <documentation>Hüft-Komponente</documentation> </annotation> </enumeration> <enumeration value="0290002"> <annotation> <documentation>Knie-Komponente</documentation> </annotation> </enumeration> <enumeration value="0290003"> <annotation> <documentation>Modulare Komponente (Hüfte/Knie)</documentation> </annotation> </enumeration> <enumeration value="0290004"> <annotation> <documentation>Knochenzement</documentation> </annotation> </enumeration> <enumeration value="0290042"> <annotation> <documentation>sonstiger</documentation> </annotation> </enumeration> </restriction> </simpleType> </pre>
--------	--

simpleType enum_0292

namespace	http://xml.ir-d.de/irdsa		
type	restriction of string		
properties	base xs:string		
facets	Kind	Value	Annotation
	enumeration	0292001	documentation Pfanne
	enumeration	0292002	documentation Inlay
	enumeration	0292003	documentation Kopf
	enumeration	0292004	documentation Schaft
	enumeration	0292005	documentation Vormontierte Acetabularkomponente (Pfanne mit Inlay)
	enumeration	0292006	documentation Einteilige Femoralkomponente (Schaft mit Kopf)
	enumeration	0292042	documentation sonstiger
annotation	documentation Kat_EP_ArtikeltypHuefte		
source	<pre> <simpleType name="enum_0292"> <annotation> </pre>		

```

<documentation>Kat_EP_ArtikeltypHuefte</documentation>
</annotation>
<restriction base="xs:string">
  <enumeration value="0292001">
    <annotation>
      <documentation>Pfanne</documentation>
    </annotation>
  </enumeration>
  <enumeration value="0292002">
    <annotation>
      <documentation>Inlay</documentation>
    </annotation>
  </enumeration>
  <enumeration value="0292003">
    <annotation>
      <documentation>Kopf</documentation>
    </annotation>
  </enumeration>
  <enumeration value="0292004">
    <annotation>
      <documentation>Schaft</documentation>
    </annotation>
  </enumeration>
  <enumeration value="0292005">
    <annotation>
      <documentation>Vormontierte Acetabularkomponente (Pfanne mit
Inlay)</documentation>
    </annotation>
  </enumeration>
  <enumeration value="0292006">
    <annotation>
      <documentation>Einteilige Femoralkomponente (Schaft mit
Kopf)</documentation>
    </annotation>
  </enumeration>
  <enumeration value="0292042">
    <annotation>
      <documentation>sonstiger</documentation>
    </annotation>
  </enumeration>
</restriction>
</simpleType>

```

simpleType enum_0293

namespace	http://xml.ir-d.de/irdsa		
type	restriction of string		
properties	base xs:string		
facets	Kind	Value	Annotation
	enumeration	0293001	documentation Tibiakomponente
	enumeration	0293002	documentation Femurkomponente
	enumeration	0293003	documentation Patella
	enumeration	0293004	documentation Insert

	enumeration 0293005 documentation Vormontierte Tibiakomponente mit Insert enumeration 0293042 documentation sonstiger
annotation	documentation Kat_EP_ArtikeltypKnie
source	<pre> <simpleType name="enum_0293"> <annotation> <documentation>Kat_EP_ArtikeltypKnie</documentation> </annotation> <restriction base="xs:string"> <enumeration value="0293001"> <annotation> <documentation>Tibiakomponente</documentation> </annotation> </enumeration> <enumeration value="0293002"> <annotation> <documentation>Femurkomponente</documentation> </annotation> </enumeration> <enumeration value="0293003"> <annotation> <documentation>Patella</documentation> </annotation> </enumeration> <enumeration value="0293004"> <annotation> <documentation>Insert</documentation> </annotation> </enumeration> <enumeration value="0293005"> <annotation> <documentation>Vormontierte Tibiakomponente mit Insert</documentation> </annotation> </enumeration> <enumeration value="0293042"> <annotation> <documentation>sonstiger</documentation> </annotation> </enumeration> </restriction> </simpleType> </pre>

simpleType enum_0300

namespace	http://xml.ir-d.de/irdsa		
type	restriction of string		
properties	base xs:string		
facets	Kind	Value	Annotation
	enumeration	0300001	documentation konventioneller Aortenklappenersatz
	enumeration	0300002	documentation kathetergestützte Aortenklappenimplantation (TAVI)
annotation	documentation Kat_AK_ArtEingriff		

source	<pre> <simpleType name="enum_0300"> <annotation> <documentation>Kat_AK_ArtEingriff</documentation> </annotation> <restriction base="xs:string"> <enumeration value="0300001"> <annotation> <documentation>konventioneller Aortenklappenersatz</documentation> </annotation> </enumeration> <enumeration value="0300002"> <annotation> <documentation>kathetergestützte Aortenklappenimplantation (TAVI)</documentation> </annotation> </enumeration> </restriction> </simpleType> </pre>
--------	--

simpleType enum_0301

namespace	http://xml.ir-d.de/irdsa		
type	restriction of string		
properties	base xs:string		
facets	Kind	Value	Annotation
	enumeration	0301001	documentation produktbezogen
	enumeration	0301002	documentation nicht-produktbezogen
annotation	documentation Kat_AK_GrundAbbruch		
source	<pre> <simpleType name="enum_0301"> <annotation> <documentation>Kat_AK_GrundAbbruch</documentation> </annotation> <restriction base="xs:string"> <enumeration value="0301001"> <annotation> <documentation>produktbezogen</documentation> </annotation> </enumeration> <enumeration value="0301002"> <annotation> <documentation>nicht-produktbezogen</documentation> </annotation> </enumeration> </restriction> </simpleType> </pre>		

simpleType enum_0302

namespace	http://xml.ir-d.de/irdsa		
type	restriction of string		
properties	base xs:string		

facets	<table border="1"> <thead> <tr> <th>Kind</th> <th>Value</th> <th>Annotation</th> </tr> </thead> <tbody> <tr> <td>enumeration</td> <td>0302001</td> <td>documentation Stenose</td> </tr> <tr> <td>enumeration</td> <td>0302002</td> <td>documentation Insuffizienz</td> </tr> <tr> <td>enumeration</td> <td>0302003</td> <td>documentation Stenose und Insuffizienz</td> </tr> <tr> <td>enumeration</td> <td>0302042</td> <td>documentation sonstiger</td> </tr> </tbody> </table>	Kind	Value	Annotation	enumeration	0302001	documentation Stenose	enumeration	0302002	documentation Insuffizienz	enumeration	0302003	documentation Stenose und Insuffizienz	enumeration	0302042	documentation sonstiger
Kind	Value	Annotation														
enumeration	0302001	documentation Stenose														
enumeration	0302002	documentation Insuffizienz														
enumeration	0302003	documentation Stenose und Insuffizienz														
enumeration	0302042	documentation sonstiger														
annotation	documentation Kat_AK_GrundEingriff															
source	<pre> <simpleType name="enum_0302"> <annotation> <documentation>Kat_AK_GrundEingriff</documentation> </annotation> <restriction base="xs:string"> <enumeration value="0302001"> <annotation> <documentation>Stenose</documentation> </annotation> </enumeration> <enumeration value="0302002"> <annotation> <documentation>Insuffizienz</documentation> </annotation> </enumeration> <enumeration value="0302003"> <annotation> <documentation>Stenose und Insuffizienz</documentation> </annotation> </enumeration> <enumeration value="0302042"> <annotation> <documentation>sonstiger</documentation> </annotation> </enumeration> </restriction> </simpleType> </pre>															

simpleType enum_0318

namespace	http://xml.ir-d.de/irdsa																		
type	restriction of string																		
properties	base xs:string																		
facets	<table border="1"> <thead> <tr> <th>Kind</th> <th>Value</th> <th>Annotation</th> </tr> </thead> <tbody> <tr> <td>enumeration</td> <td>0318001</td> <td>documentation transapikal</td> </tr> <tr> <td>enumeration</td> <td>0318002</td> <td>documentation transaortal</td> </tr> <tr> <td>enumeration</td> <td>0318003</td> <td>documentation transfemoral</td> </tr> <tr> <td>enumeration</td> <td>0318004</td> <td>documentation transaxillär</td> </tr> <tr> <td>enumeration</td> <td>0318042</td> <td>documentation anderer Zugangsweg</td> </tr> </tbody> </table>	Kind	Value	Annotation	enumeration	0318001	documentation transapikal	enumeration	0318002	documentation transaortal	enumeration	0318003	documentation transfemoral	enumeration	0318004	documentation transaxillär	enumeration	0318042	documentation anderer Zugangsweg
Kind	Value	Annotation																	
enumeration	0318001	documentation transapikal																	
enumeration	0318002	documentation transaortal																	
enumeration	0318003	documentation transfemoral																	
enumeration	0318004	documentation transaxillär																	
enumeration	0318042	documentation anderer Zugangsweg																	
annotation	documentation Kat_AK_ZugangKatheter																		

source	<pre> <simpleType name="enum_0318"> <annotation> <documentation>Kat_AK_ZugangKatheter</documentation> </annotation> <restriction base="xs:string"> <enumeration value="0318001"> <annotation> <documentation>transapikal</documentation> </annotation> </enumeration> <enumeration value="0318002"> <annotation> <documentation>transaortal</documentation> </annotation> </enumeration> <enumeration value="0318003"> <annotation> <documentation>transfemorale</documentation> </annotation> </enumeration> <enumeration value="0318004"> <annotation> <documentation>transaxillär</documentation> </annotation> </enumeration> <enumeration value="0318042"> <annotation> <documentation>anderer Zugangsweg</documentation> </annotation> </enumeration> </restriction> </simpleType> </pre>
--------	---

simpleType enum_0320

namespace	http://xml.ir-d.de/irdsa		
type	restriction of string		
properties	base xs:string		
facets	Kind	Value	Annotation
	enumeration	0320001	documentation konventionelle Sternotomie
	enumeration	0320002	documentation partielle Sternotomie
	enumeration	0320003	documentation parasternaler Zugang
	enumeration	0320042	documentation anderer Zugangsweg
annotation	documentation Kat_AK_ZugangKonventionell		
source	<pre> <simpleType name="enum_0320"> <annotation> <documentation>Kat_AK_ZugangKonventionell</documentation> </annotation> <restriction base="xs:string"> <enumeration value="0320001"> <annotation> <documentation>konventionelle Sternotomie</documentation> </pre>		

	<pre> </annotation> </enumeration> <enumeration value="0320002"> <annotation> <documentation>partielle Sternotomie</documentation> </annotation> </enumeration> <enumeration value="0320003"> <annotation> <documentation>parasternaler Zugang</documentation> </annotation> </enumeration> <enumeration value="0320042"> <annotation> <documentation>anderer Zugangsweg</documentation> </annotation> </enumeration> </restriction> </simpleType> </pre>
--	---

simpleType enum 0322

namespace	http://xml.ir-d.de/irdsa		
type	restriction of string		
properties	base xs:string		
facets	Kind	Value	Annotation
	enumeration	0322001	documentation nein
	enumeration	0322002	documentation ja, diätetisch behandelt
	enumeration	0322003	documentation ja, orale Medikation
	enumeration	0322004	documentation ja, mit Insulin behandelt
	enumeration	0322005	documentation ja, unbehandelt
	enumeration	0322099	documentation unbekannt
annotation	documentation Kat_AK_Diabetes		
source	<pre> <simpleType name="enum_0322"> <annotation> <documentation>Kat_AK_Diabetes</documentation> </annotation> <restriction base="xs:string"> <enumeration value="0322001"> <annotation> <documentation>nein</documentation> </annotation> </enumeration> <enumeration value="0322002"> <annotation> <documentation>ja, diätetisch behandelt</documentation> </annotation> </enumeration> <enumeration value="0322003"> <annotation> </pre>		

	<pre> <documentation>ja, orale Medikation</documentation> </annotation> </enumeration> <enumeration value="0322004"> <annotation> <documentation>ja, mit Insulin behandelt</documentation> </annotation> </enumeration> <enumeration value="0322005"> <annotation> <documentation>ja, unbehandelt</documentation> </annotation> </enumeration> <enumeration value="0322099"> <annotation> <documentation>unbekannt</documentation> </annotation> </enumeration> </restriction> </simpleType> </pre>
--	---

simpleType enum_0324

namespace	http://xml.ir-d.de/irdsa		
type	restriction of string		
properties	base xs:string		
facets	Kind	Value	Annotation
	enumeration	0324001	documentation (I): Beschwerdefreiheit, normale körperliche Belastbarkeit
	enumeration	0324002	documentation (II): Beschwerden bei stärkerer körperlicher Belastung
	enumeration	0324003	documentation (III): Beschwerden bei leichter körperlicher Belastung
	enumeration	0324004	documentation (IV): Beschwerden in Ruhe
annotation	documentation Kat_AK_NYHA		
source	<pre> <simpleType name="enum_0324"> <annotation> <documentation>Kat_AK_NYHA</documentation> </annotation> <restriction base="xs:string"> <enumeration value="0324001"> <annotation> <documentation>(I): Beschwerdefreiheit, normale körperliche Belastbarkeit</documentation> </annotation> </enumeration> <enumeration value="0324002"> <annotation> <documentation>(II): Beschwerden bei stärkerer körperlicher Belastung</documentation> </annotation> </enumeration> <enumeration value="0324003"> <annotation> <documentation>(III): Beschwerden bei leichter körperlicher </pre>		

	<pre> Belastung</documentation> </annotation> </enumeration> <enumeration value="0324004"> <annotation> <documentation>(IV): Beschwerden in Ruhe</documentation> </annotation> </enumeration> </restriction> </simpleType> </pre>
--	---

simpleType enum_0338

namespace	http://xml.ir-d.de/irdsa		
type	restriction of string		
properties	base xs:string		
facets	Kind	Value	Annotation
	enumeration	0338001	documentation LAD
	enumeration	0338002	documentation RCA
	enumeration	0338003	documentation RCX
	enumeration	0338004	documentation Hauptstamm
annotation	documentation Kat_AK_PCIArterien		
source	<pre> <simpleType name="enum_0338"> <annotation> <documentation>Kat_AK_PCIArterien</documentation> </annotation> <restriction base="xs:string"> <enumeration value="0338001"> <annotation> <documentation>LAD</documentation> </annotation> </enumeration> <enumeration value="0338002"> <annotation> <documentation>RCA</documentation> </annotation> </enumeration> <enumeration value="0338003"> <annotation> <documentation>RCX</documentation> </annotation> </enumeration> <enumeration value="0338004"> <annotation> <documentation>Hauptstamm</documentation> </annotation> </enumeration> </restriction> </simpleType> </pre>		

simpleType enum_0339

namespace	http://xml.ir-d.de/irdsa		
type	restriction of string		
properties	base xs:string		
facets	Kind	Value	Annotation
	enumeration	0339001	documentation TEE
	enumeration	0339002	documentation CT
	enumeration	0339042	documentation andere
annotation	documentation Kat_AK_AnnulusMessmethode		
source	<pre> <simpleType name="enum_0339"> <annotation> <documentation>Kat_AK_AnnulusMessmethode</documentation> </annotation> <restriction base="xs:string"> <enumeration value="0339001"> <annotation> <documentation>TEE</documentation> </annotation> </enumeration> <enumeration value="0339002"> <annotation> <documentation>CT</documentation> </annotation> </enumeration> <enumeration value="0339042"> <annotation> <documentation>andere</documentation> </annotation> </enumeration> </restriction> </simpleType> </pre>		

simpleType enum_0341

namespace	http://xml.ir-d.de/irdsa		
type	restriction of string		
properties	base xs:string		
facets	Kind	Value	Annotation
	enumeration	0341001	documentation intraprozedural verstorben
	enumeration	0341002	documentation Implantation von mehr als einer Prothese
	enumeration	0341003	documentation gravierende Gefäß- oder Zugangskomplikation (gemäß VARC-3)
	enumeration	0341004	documentation erforderlicher chirurgischer oder interventioneller Eingriff wegen einer Klappenfehlfunktion (gemäß VARC-3)
	enumeration	0341005	documentation >= große strukturelle kardiale Komplikation (gemäß VARC-3)
annotation	documentation Kat_AK_FailureGrund		

source	<pre> <simpleType name="enum_0341"> <annotation> <documentation>Kat_AK_FailureGrund</documentation> </annotation> <restriction base="xs:string"> <enumeration value="0341001"> <annotation> <documentation>intraprozedural verstorben</documentation> </annotation> </enumeration> <enumeration value="0341002"> <annotation> <documentation>Implantation von mehr als einer Prothese</documentation> </annotation> </enumeration> <enumeration value="0341003"> <annotation> <documentation>gravierende Gefäß- oder Zugangskomplikation (gemäß VARC-3)</documentation> </annotation> </enumeration> <enumeration value="0341004"> <annotation> <documentation>erforderlicher chirurgischer oder interventioneller Eingriff wegen einer Klappenfehlfunktion (gemäß VARC-3)</documentation> </annotation> </enumeration> <enumeration value="0341005"> <annotation> <documentation>&gt;= große strukturelle kardiale Komplikation (gemäß VARC-3)</documentation> </annotation> </enumeration> </restriction> </simpleType> </pre>
--------	--

simpleType enum_0342

namespace	http://xml.ir-d.de/irdsa		
type	restriction of string		
properties	base xs:string		
facets	Kind	Value	Annotation
	enumeration	0342001	documentation Alter
	enumeration	0342002	documentation Frailty
	enumeration	0342003	documentation Hochrisiko
	enumeration	0342004	documentation Prognose-limitierende Zweiterkrankung
	enumeration	0342005	documentation Porzellan-Aorta
	enumeration	0342042	documentation sonstiger
annotation	documentation Kat_AK_Tavi		

source	<pre> <simpleType name="enum_0342"> <annotation> <documentation>Kat_AK_Tavi</documentation> </annotation> <restriction base="xs:string"> <enumeration value="0342001"> <annotation> <documentation>Alter</documentation> </annotation> </enumeration> <enumeration value="0342002"> <annotation> <documentation>Frailty</documentation> </annotation> </enumeration> <enumeration value="0342003"> <annotation> <documentation>Hochrisiko</documentation> </annotation> </enumeration> <enumeration value="0342004"> <annotation> <documentation>Prognose-limitierende Zweiterkrankung</documentation> </annotation> </enumeration> <enumeration value="0342005"> <annotation> <documentation>Porzellan-Aorta</documentation> </annotation> </enumeration> <enumeration value="0342042"> <annotation> <documentation>sonstiger</documentation> </annotation> </enumeration> </restriction> </simpleType> </pre>
--------	---

simpleType enum_0343

namespace	http://xml.ir-d.de/irdsa		
type	restriction of string		
properties	base xs:string		
facets	Kind	Value	Annotation
	enumeration	0343001	documentation Device-Fehlpositionierung
	enumeration	0343002	documentation Koronarostienverschluss
	enumeration	0343003	documentation Aortendissektion
	enumeration	0343004	documentation Aortenregurgitation > = 2. Grades
	enumeration	0343005	documentation Annulus-Ruptur
	enumeration	0343006	documentation Ruptur-/Perforation einer Herzhöhle ohne Therapiebedarf
	enumeration	0343007	documentation

	<p>enumeration 0343008 Ruptur-/Perforation einer Herzhöhle mit Therapiebedarf documentation Perikardtamponade</p> <p>enumeration 0343009 documentation kardiale Dekompensation</p> <p>enumeration 0343010 documentation Hirnembolie</p> <p>enumeration 0343011 documentation Rhythmusstörungen</p> <p>enumeration 0343012 documentation Device-Embolisation</p> <p>enumeration 0343013 documentation vaskuläre Komplikation</p> <p>enumeration 0343014 documentation Low Cardiac Output</p> <p>enumeration 0343015 documentation schwerwiegende Blutungen (intraprozedural)</p> <p>enumeration 0343016 documentation lebensbedrohliche Blutungen (intraprozedural)</p> <p>enumeration 0343017 documentation Patient verstarb im OP/Katheterlabor</p> <p>enumeration 0343042 documentation sonstiger</p>
annotation	documentation Kat_AK_KomplikationTyp
source	<pre> <simpleType name="enum_0343"> <annotation> <documentation>Kat_AK_KomplikationTyp</documentation> </annotation> <restriction base="xs:string"> <enumeration value="0343001"> <annotation> <documentation>Device-Fehlpositionierung</documentation> </annotation> </enumeration> <enumeration value="0343002"> <annotation> <documentation>Koronarostienverschluss</documentation> </annotation> </enumeration> <enumeration value="0343003"> <annotation> <documentation>Aortendissektion</documentation> </annotation> </enumeration> <enumeration value="0343004"> <annotation> <documentation>Aortenregurgitation &gt; = 2. Grades</documentation> </annotation> </enumeration> <enumeration value="0343005"> <annotation> <documentation>Annulus-Ruptur</documentation> </annotation> </enumeration> <enumeration value="0343006"> <annotation> <documentation>Ruptur-/Perforation einer Herzhöhle ohne Therapiebedarf</documentation> </annotation> </enumeration> </restriction> </simpleType> </pre>

```

<enumeration value="0343007">
  <annotation>
    <documentation>Ruptur-/Perforation einer Herzhöhle mit
Therapiebedarf</documentation>
  </annotation>
</enumeration>
<enumeration value="0343008">
  <annotation>
    <documentation>Perikardtamponade</documentation>
  </annotation>
</enumeration>
<enumeration value="0343009">
  <annotation>
    <documentation>kardiale Dekompensation</documentation>
  </annotation>
</enumeration>
<enumeration value="0343010">
  <annotation>
    <documentation>Hirnembolie</documentation>
  </annotation>
</enumeration>
<enumeration value="0343011">
  <annotation>
    <documentation>Rhythmusstörungen</documentation>
  </annotation>
</enumeration>
<enumeration value="0343012">
  <annotation>
    <documentation>Device-Embolisation</documentation>
  </annotation>
</enumeration>
<enumeration value="0343013">
  <annotation>
    <documentation>vaskuläre Komplikation</documentation>
  </annotation>
</enumeration>
<enumeration value="0343014">
  <annotation>
    <documentation>Low Cardiac Output</documentation>
  </annotation>
</enumeration>
<enumeration value="0343015">
  <annotation>
    <documentation>schwerwiegende Blutungen
(intraprozedural)</documentation>
  </annotation>
</enumeration>
<enumeration value="0343016">
  <annotation>
    <documentation>lebensbedrohliche Blutungen
(intraprozedural)</documentation>
  </annotation>
</enumeration>
<enumeration value="0343017">
  <annotation>
    <documentation>Patient verstarb im OP/Katheterlabor</documentation>
  </annotation>
</enumeration>
<enumeration value="0343042">

```

	<pre> <annotation> <documentation>sonstiger</documentation> </annotation> </enumeration> </restriction> </simpleType> </pre>
--	--

simpleType enum_0346

namespace	http://xml.ir-d.de/irdsa		
type	restriction of string		
properties	base xs:string		
facets	Kind	Value	Annotation
	enumeration	0346001	documentation keine Therapie erforderlich
	enumeration	0346002	documentation medikamentös
	enumeration	0346003	documentation IABP
	enumeration	0346004	documentation VAD
	enumeration	0346005	documentation ECMO
	enumeration	0346042	documentation sonstige
annotation	documentation Kat AK TherapieLCO		
source	<pre> <simpleType name="enum_0346"> <annotation> <documentation>Kat_AK_TherapieLCO</documentation> </annotation> <restriction base="xs:string"> <enumeration value="0346001"> <annotation> <documentation>keine Therapie erforderlich</documentation> </annotation> </enumeration> <enumeration value="0346002"> <annotation> <documentation>medikamentös</documentation> </annotation> </enumeration> <enumeration value="0346003"> <annotation> <documentation>IABP</documentation> </annotation> </enumeration> <enumeration value="0346004"> <annotation> <documentation>VAD</documentation> </annotation> </enumeration> <enumeration value="0346005"> <annotation> <documentation>ECMO</documentation> </annotation> </enumeration> </restriction> </simpleType> </pre>		

	<pre> <enumeration value="0346042"> <annotation> <documentation>sonstige</documentation> </annotation> </enumeration> </restriction> </simpleType> </pre>
--	---

simpleType enum_0347

namespace	http://xml.ir-d.de/irdsa		
type	restriction of string		
properties	base xs:string		
facets	Kind	Value	Annotation
	enumeration	0347001	documentation Einzeleingriff
	enumeration	0347002	documentation Kombinationseingriff mit mehreren Prozeduren
annotation	documentation Kat_AK_Eingriffsumfang		
source	<pre> <simpleType name="enum_0347"> <annotation> <documentation>Kat_AK_Eingriffsumfang</documentation> </annotation> <restriction base="xs:string"> <enumeration value="0347001"> <annotation> <documentation>Einzeleingriff</documentation> </annotation> </enumeration> <enumeration value="0347002"> <annotation> <documentation>Kombinationseingriff mit mehreren Prozeduren</documentation> </annotation> </enumeration> </restriction> </simpleType> </pre>		

simpleType enum_0348

namespace	http://xml.ir-d.de/irdsa		
type	restriction of string		
properties	base xs:string		
facets	Kind	Value	Annotation
	enumeration	0348001	documentation mit HLM
	enumeration	0348002	documentation ohne HLM
	enumeration	0348003	documentation Umstieg von OP ohne HLM auf OP mit HLM
annotation	documentation Kat_AK_OPVorgehen		
source	<pre> <simpleType name="enum_0348"> </pre>		

	<pre> <annotation> <documentation>Kat_AK_OPVorgehen</documentation> </annotation> <restriction base="xs:string"> <enumeration value="0348001"> <annotation> <documentation>mit HLM</documentation> </annotation> </enumeration> <enumeration value="0348002"> <annotation> <documentation>ohne HLM</documentation> </annotation> </enumeration> <enumeration value="0348003"> <annotation> <documentation>Umstieg von OP ohne HLM auf OP mit HLM</documentation> </annotation> </enumeration> </restriction> </simpleType> </pre>
--	---

simpleType enum_0350

namespace	http://xml.ir-d.de/irdsa		
type	restriction of string		
properties	base xs:string		
facets	Kind	Value	Annotation
	enumeration	0350001	documentation IABP
	enumeration	0350002	documentation Impella
	enumeration	0350003	documentation vv ECMO
	enumeration	0350004	documentation va ECMO
	enumeration	0350042	documentation andere
annotation	documentation Kat_AK_Methode		
source	<pre> <simpleType name="enum_0350"> <annotation> <documentation>Kat_AK_Methode</documentation> </annotation> <restriction base="xs:string"> <enumeration value="0350001"> <annotation> <documentation>IABP</documentation> </annotation> </enumeration> <enumeration value="0350002"> <annotation> <documentation>Impella</documentation> </annotation> </enumeration> <enumeration value="0350003"> <annotation> </pre>		

	<pre> <documentation>vv ECMO</documentation> </annotation> </enumeration> <enumeration value="0350004"> <annotation> <documentation>va ECMO</documentation> </annotation> </enumeration> <enumeration value="0350042"> <annotation> <documentation>andere</documentation> </annotation> </enumeration> </restriction> </simpleType> </pre>
--	--

simpleType enum_0351

namespace	http://xml.ir-d.de/irdsa		
type	restriction of string		
properties	base xs:string		
facets	Kind	Value	Annotation
	enumeration	0351001	documentation nein
	enumeration	0351002	documentation ja, zu Sternotomie
	enumeration	0351003	documentation ja, zu transapikal
	enumeration	0351004	documentation ja, zu transaortal
	enumeration	0351005	documentation ja, zu transfemoral
	enumeration	0351006	documentation ja, zu transaxillär
	enumeration	0351007	documentation ja, zu anderem endovaskulären Zugang
	enumeration	0351042	documentation ja, zu anderem Zugang
annotation	documentation Kat_AK_Konversion		
source	<pre> <simpleType name="enum_0351"> <annotation> <documentation>Kat_AK_Konversion</documentation> </annotation> <restriction base="xs:string"> <enumeration value="0351001"> <annotation> <documentation>nein</documentation> </annotation> </enumeration> <enumeration value="0351002"> <annotation> <documentation>ja, zu Sternotomie</documentation> </annotation> </enumeration> <enumeration value="0351003"> <annotation> <documentation>ja, zu transapikal</documentation> </pre>		

	<pre> </annotation> </enumeration> <enumeration value="0351004"> <annotation> <documentation>ja, zu transaortal</documentation> </annotation> </enumeration> <enumeration value="0351005"> <annotation> <documentation>ja, zu transfemoral</documentation> </annotation> </enumeration> <enumeration value="0351006"> <annotation> <documentation>ja, zu transaxillär</documentation> </annotation> </enumeration> <enumeration value="0351007"> <annotation> <documentation>ja, zu anderem endovaskulären Zugang</documentation> </annotation> </enumeration> <enumeration value="0351042"> <annotation> <documentation>ja, zu anderem Zugang</documentation> </annotation> </enumeration> </restriction> </simpleType> </pre>
--	---

simpleType enum_0352

namespace	http://xml.ir-d.de/irdsa		
type	restriction of string		
properties	base xs:string		
facets	Kind	Value	Annotation
	enumeration	0352001	documentation nein
	enumeration	0352002	documentation ja, Intubationsnarkose
	enumeration	0352003	documentation ja, Maskenbeatmung, incl. LAMA
	enumeration	0352042	documentation ja, unbekannt welche
annotation	documentation Kat_AK_Anaesthesie		
source	<pre> <simpleType name="enum_0352"> <annotation> <documentation>Kat_AK_Anaesthesie</documentation> </annotation> <restriction base="xs:string"> <enumeration value="0352001"> <annotation> <documentation>nein</documentation> </annotation> </enumeration> <enumeration value="0352002"> </pre>		

	<pre> <annotation> <documentation>ja, Intubationsnarkose</documentation> </annotation> </enumeration> <enumeration value="0352003"> <annotation> <documentation>ja, Maskenbeatmung, incl. LAMA</documentation> </annotation> </enumeration> <enumeration value="0352042"> <annotation> <documentation>ja, unbekannt welche</documentation> </annotation> </enumeration> </restriction> </simpleType> </pre>
--	---

simpleType enum 0353

namespace	http://xml.ir-d.de/irdsa		
type	restriction of string		
properties	base xs:string		
facets	Kind	Value	Annotation
	enumeration	0353001	documentation keine
	enumeration	0353002	documentation leichtgradig
	enumeration	0353003	documentation mittelgradig
	enumeration	0353004	documentation hochgradig
	enumeration	0353099	documentation nicht bestimmbar
annotation	documentation Kat_AK_ResidualeArteninsuffizienz		
source	<pre> <simpleType name="enum_0353"> <annotation> <documentation>Kat_AK_ResidualeArteninsuffizienz</documentation> </annotation> <restriction base="xs:string"> <enumeration value="0353001"> <annotation> <documentation>keine</documentation> </annotation> </enumeration> <enumeration value="0353002"> <annotation> <documentation>leichtgradig</documentation> </annotation> </enumeration> <enumeration value="0353003"> <annotation> <documentation>mittelgradig</documentation> </annotation> </enumeration> <enumeration value="0353004"> <annotation> </pre>		

	<pre> <documentation>hochgradig</documentation> </annotation> </enumeration> <enumeration value="0353099"> <annotation> <documentation>nicht bestimmbar</documentation> </annotation> </enumeration> </restriction> </simpleType> </pre>
--	--

simpleType enum_0354

namespace	http://xml.ir-d.de/irdsa		
type	restriction of string		
properties	base xs:string		
facets	Kind	Value	Annotation
	enumeration	0354001	documentation chirurgisch-offen
	enumeration	0354002	documentation Verschluss-System
	enumeration	0354042	documentation sonstiger
annotation	documentation Kat_AK_Zugangswegverschluss		
source	<pre> <simpleType name="enum_0354"> <annotation> <documentation>Kat_AK_Zugangswegverschluss</documentation> </annotation> <restriction base="xs:string"> <enumeration value="0354001"> <annotation> <documentation>chirurgisch-offen</documentation> </annotation> </enumeration> <enumeration value="0354002"> <annotation> <documentation>Verschluss-System</documentation> </annotation> </enumeration> <enumeration value="0354042"> <annotation> <documentation>sonstiger</documentation> </annotation> </enumeration> </restriction> </simpleType> </pre>		

simpleType enum_0357

namespace	http://xml.ir-d.de/irdsa		
type	restriction of string		
properties	base xs:string		

facets	<table border="1"> <thead> <tr> <th>Kind</th> <th>Value</th> <th>Annotation</th> </tr> </thead> <tbody> <tr> <td>enumeration</td> <td>0357001</td> <td>documentation keine KHK</td> </tr> <tr> <td>enumeration</td> <td>0357002</td> <td>documentation 1-Gefäßerkrankung</td> </tr> <tr> <td>enumeration</td> <td>0357003</td> <td>documentation 2-Gefäßerkrankung</td> </tr> <tr> <td>enumeration</td> <td>0357004</td> <td>documentation 3-Gefäßerkrankung</td> </tr> <tr> <td>enumeration</td> <td>0357005</td> <td>documentation keine koronare Bildgebung</td> </tr> </tbody> </table>	Kind	Value	Annotation	enumeration	0357001	documentation keine KHK	enumeration	0357002	documentation 1-Gefäßerkrankung	enumeration	0357003	documentation 2-Gefäßerkrankung	enumeration	0357004	documentation 3-Gefäßerkrankung	enumeration	0357005	documentation keine koronare Bildgebung
Kind	Value	Annotation																	
enumeration	0357001	documentation keine KHK																	
enumeration	0357002	documentation 1-Gefäßerkrankung																	
enumeration	0357003	documentation 2-Gefäßerkrankung																	
enumeration	0357004	documentation 3-Gefäßerkrankung																	
enumeration	0357005	documentation keine koronare Bildgebung																	
annotation	documentation Kat AK BefundBildgebung																		
source	<pre> <simpleType name="enum_0357"> <annotation> <documentation>Kat_AK_BefundBildgebung</documentation> </annotation> <restriction base="xs:string"> <enumeration value="0357001"> <annotation> <documentation>keine KHK</documentation> </annotation> </enumeration> <enumeration value="0357002"> <annotation> <documentation>1-Gefäßerkrankung</documentation> </annotation> </enumeration> <enumeration value="0357003"> <annotation> <documentation>2-Gefäßerkrankung</documentation> </annotation> </enumeration> <enumeration value="0357004"> <annotation> <documentation>3-Gefäßerkrankung</documentation> </annotation> </enumeration> <enumeration value="0357005"> <annotation> <documentation>keine koronare Bildgebung</documentation> </annotation> </enumeration> </restriction> </simpleType> </pre>																		

simpleType enum_0358

namespace	http://xml.ir-d.de/irdsa												
type	restriction of string												
properties	base xs:string												
facets	<table border="1"> <thead> <tr> <th>Kind</th> <th>Value</th> <th>Annotation</th> </tr> </thead> <tbody> <tr> <td>enumeration</td> <td>0358001</td> <td>documentation 0</td> </tr> <tr> <td>enumeration</td> <td>0358002</td> <td>documentation 1</td> </tr> <tr> <td>enumeration</td> <td>0358003</td> <td>documentation 2</td> </tr> </tbody> </table>	Kind	Value	Annotation	enumeration	0358001	documentation 0	enumeration	0358002	documentation 1	enumeration	0358003	documentation 2
Kind	Value	Annotation											
enumeration	0358001	documentation 0											
enumeration	0358002	documentation 1											
enumeration	0358003	documentation 2											

	<p>enumeration 0358004 documentation 3</p> <p>enumeration 0358005 documentation 4</p> <p>enumeration 0358006 documentation 5 oder mehr</p> <p>enumeration 0358098 documentation genaue Anzahl unbekannt (aber mind. 1)</p> <p>enumeration 0358099 documentation unbekannt</p>
annotation	documentation Kat_AK_AnzahlVorOP
source	<pre> <simpleType name="enum_0358"> <annotation> <documentation>Kat_AK_AnzahlVorOP</documentation> </annotation> <restriction base="xs:string"> <enumeration value="0358001"> <annotation> <documentation>0</documentation> </annotation> </enumeration> <enumeration value="0358002"> <annotation> <documentation>1</documentation> </annotation> </enumeration> <enumeration value="0358003"> <annotation> <documentation>2</documentation> </annotation> </enumeration> <enumeration value="0358004"> <annotation> <documentation>3</documentation> </annotation> </enumeration> <enumeration value="0358005"> <annotation> <documentation>4</documentation> </annotation> </enumeration> <enumeration value="0358006"> <annotation> <documentation>5 oder mehr</documentation> </annotation> </enumeration> <enumeration value="0358098"> <annotation> <documentation>genaue Anzahl unbekannt (aber mind. 1)</documentation> </annotation> </enumeration> <enumeration value="0358099"> <annotation> <documentation>unbekannt</documentation> </annotation> </enumeration> </restriction> </simpleType> </pre>

simpleType enum 0359

namespace	http://xml.ir-d.de/irdsa		
type	restriction of string		
properties	base xs:string		
facets	Kind	Value	Annotation
	enumeration	0359001	documentation nein
	enumeration	0359002	documentation ja - einseitig
	enumeration	0359003	documentation ja - beidseitig
	enumeration	0359042	documentation unbekannt
annotation	documentation Kat AK LVOT		
source	<pre> <simpleType name="enum_0359"> <annotation> <documentation>Kat_AK_LVOT</documentation> </annotation> <restriction base="xs:string"> <enumeration value="0359001"> <annotation> <documentation>nein</documentation> </annotation> </enumeration> <enumeration value="0359002"> <annotation> <documentation>ja - einseitig</documentation> </annotation> </enumeration> <enumeration value="0359003"> <annotation> <documentation>ja - beidseitig</documentation> </annotation> </enumeration> <enumeration value="0359042"> <annotation> <documentation>unbekannt</documentation> </annotation> </enumeration> </restriction> </simpleType> </pre>		

simpleType enum 0360

namespace	http://xml.ir-d.de/irdsa		
type	restriction of string		
properties	base xs:string		
facets	Kind	Value	Annotation
	enumeration	0360001	documentation keine
	enumeration	0360002	documentation leichtgradig

	enumeration 0360003 documentation mittelgradig enumeration 0360004 documentation hochgradig enumeration 0360005 documentation massive enumeration 0360006 documentation torrential enumeration 0360099 documentation unbekannt
annotation	documentation Kat_AK_TriskupidallInsuffizienz
source	<pre> <simpleType name="enum_0360"> <annotation> <documentation>Kat_AK_TriskupidallInsuffizienz</documentation> </annotation> <restriction base="xs:string"> <enumeration value="0360001"> <annotation> <documentation>keine</documentation> </annotation> </enumeration> <enumeration value="0360002"> <annotation> <documentation>leichtgradig</documentation> </annotation> </enumeration> <enumeration value="0360003"> <annotation> <documentation>mittelgradig</documentation> </annotation> </enumeration> <enumeration value="0360004"> <annotation> <documentation>hochgradig</documentation> </annotation> </enumeration> <enumeration value="0360005"> <annotation> <documentation>massive</documentation> </annotation> </enumeration> <enumeration value="0360006"> <annotation> <documentation>torrential</documentation> </annotation> </enumeration> <enumeration value="0360099"> <annotation> <documentation>unbekannt</documentation> </annotation> </enumeration> </restriction> </simpleType> </pre>

simpleType enum_0361

namespace	http://xml.ir-d.de/irdsa
-----------	--------------------------

type	restriction of string		
properties	base xs:string		
facets	Kind	Value	Annotation
	enumeration	0361001	documentation nein
	enumeration	0361002	documentation ja, letzte(r) innerhalb der letzten 48 Stunden
	enumeration	0361003	documentation ja, letzte(r) innerhalb der letzten 21 Tage
	enumeration	0361004	documentation ja, letzte(r) länger als 21 Tage
	enumeration	0361098	documentation ja, letzter Zeitpunkt unbekannt
	enumeration	0361099	documentation unbekannt
annotation	documentation Kat_AK_SchockReanimation		
source	<pre> <simpleType name="enum_0361"> <annotation> <documentation>Kat_AK_SchockReanimation</documentation> </annotation> <restriction base="xs:string"> <enumeration value="0361001"> <annotation> <documentation>nein</documentation> </annotation> </enumeration> <enumeration value="0361002"> <annotation> <documentation>ja, letzte(r) innerhalb der letzten 48 Stunden</documentation> </annotation> </enumeration> <enumeration value="0361003"> <annotation> <documentation>ja, letzte(r) innerhalb der letzten 21 Tage</documentation> </annotation> </enumeration> <enumeration value="0361004"> <annotation> <documentation>ja, letzte(r) länger als 21 Tage</documentation> </annotation> </enumeration> <enumeration value="0361098"> <annotation> <documentation>ja, letzter Zeitpunkt unbekannt</documentation> </annotation> </enumeration> <enumeration value="0361099"> <annotation> <documentation>unbekannt</documentation> </annotation> </enumeration> </restriction> </simpleType> </pre>		

simpleType enum_0362

namespace	http://xml.ir-d.de/irdsa		
type	restriction of string		
properties	base xs:string		
facets	Kind	Value	Annotation
	enumeration	0362001	documentation Sinusrhythmus
	enumeration	0362002	documentation Vorhofflimmern
	enumeration	0362042	documentation anderer Herzrhythmus
annotation	documentation Kat_AK_Herzrhythmus		
source	<pre> <simpleType name="enum_0362"> <annotation> <documentation>Kat_AK_Herzrhythmus</documentation> </annotation> <restriction base="xs:string"> <enumeration value="0362001"> <annotation> <documentation>Sinusrhythmus</documentation> </annotation> </enumeration> <enumeration value="0362002"> <annotation> <documentation>Vorhofflimmern</documentation> </annotation> </enumeration> <enumeration value="0362042"> <annotation> <documentation>anderer Herzrhythmus</documentation> </annotation> </enumeration> </restriction> </simpleType> </pre>		

simpleType enum_0363

namespace	http://xml.ir-d.de/irdsa		
type	restriction of string		
properties	base xs:string		
facets	Kind	Value	Annotation
	enumeration	0363001	documentation nein
	enumeration	0363002	documentation paroxysmal
	enumeration	0363003	documentation persistierend
	enumeration	0363004	documentation permanent
annotation	documentation Kat_AK_Vorhofflimmern		
source	<pre> <simpleType name="enum_0363"> <annotation> <documentation>Kat AK Vorhofflimmern</documentation> </annotation> </pre>		

	<pre> </annotation> <restriction base="xs:string"> <enumeration value="0363001"> <annotation> <documentation>nein</documentation> </annotation> </enumeration> <enumeration value="0363002"> <annotation> <documentation>paroxysmal</documentation> </annotation> </enumeration> <enumeration value="0363003"> <annotation> <documentation>persistierend</documentation> </annotation> </enumeration> <enumeration value="0363004"> <annotation> <documentation>permanent</documentation> </annotation> </enumeration> </restriction> </simpleType> </pre>
--	--

simpleType enum_0364

namespace	http://xml.ir-d.de/irdsa		
type	restriction of string		
properties	base xs:string		
facets	Kind	Value	Annotation
	enumeration	0364001	documentation nein
	enumeration	0364002	documentation Schrittmacher ohne CRT-System
	enumeration	0364003	documentation Schrittmacher mit CRT-System
	enumeration	0364004	documentation Defibrillator ohne CRT-System
	enumeration	0364005	documentation Defibrillator mit CRT-System
annotation	documentation Kat_AK_SchrittmacherDefi		
source	<pre> <simpleType name="enum_0364"> <annotation> <documentation>Kat_AK_SchrittmacherDefi</documentation> </annotation> <restriction base="xs:string"> <enumeration value="0364001"> <annotation> <documentation>nein</documentation> </annotation> </enumeration> <enumeration value="0364002"> <annotation> <documentation>Schrittmacher ohne CRT-System</documentation> </annotation> </enumeration> </restriction> </simpleType> </pre>		

	<pre> </enumeration> <enumeration value="0364003"> <annotation> <documentation>Schrittmacher mit CRT-System</documentation> </annotation> </enumeration> <enumeration value="0364004"> <annotation> <documentation>Defibrillator ohne CRT-System</documentation> </annotation> </enumeration> <enumeration value="0364005"> <annotation> <documentation>Defibrillator mit CRT-System</documentation> </annotation> </enumeration> </restriction> </simpleType> </pre>
--	---

simpleType enum_0365

namespace	http://xml.ir-d.de/irdsa		
type	restriction of string		
properties	base xs:string		
facets	Kind	Value	Annotation
	enumeration	0365001	documentation nein
	enumeration	0365002	documentation ja, operativ
	enumeration	0365003	documentation ja, interventionell
annotation	documentation Kat AK MyokardRevaskularisation		
source	<pre> <simpleType name="enum_0365"> <annotation> <documentation>Kat_AK_MyokardRevaskularisation</documentation> </annotation> <restriction base="xs:string"> <enumeration value="0365001"> <annotation> <documentation>nein</documentation> </annotation> </enumeration> <enumeration value="0365002"> <annotation> <documentation>ja, operativ</documentation> </annotation> </enumeration> <enumeration value="0365003"> <annotation> <documentation>ja, interventionell</documentation> </annotation> </enumeration> </restriction> </simpleType> </pre>		

simpleType enum_0366

namespace	http://xml.ir-d.de/irdsa		
type	restriction of string		
properties	base xs:string		
facets	Kind	Value	Annotation
	enumeration	0366001	documentation nein
	enumeration	0366002	documentation ja, <= 6 Stunden
	enumeration	0366003	documentation ja, > 6 Stunden bis <= 3 Monate
	enumeration	0366004	documentation ja, > 3 Monate
	enumeration	0366099	documentation unbekannt
annotation	documentation Kat_AK_PCI		
source	<pre> <simpleType name="enum_0366"> <annotation> <documentation>Kat_AK_PCI</documentation> </annotation> <restriction base="xs:string"> <enumeration value="0366001"> <annotation> <documentation>nein</documentation> </annotation> </enumeration> <enumeration value="0366002"> <annotation> <documentation>ja, &lt;= 6 Stunden</documentation> </annotation> </enumeration> <enumeration value="0366003"> <annotation> <documentation>ja, &gt; 6 Stunden bis &lt;= 3 Monate</documentation> </annotation> </enumeration> <enumeration value="0366004"> <annotation> <documentation>ja, &gt; 3 Monate</documentation> </annotation> </enumeration> <enumeration value="0366099"> <annotation> <documentation>unbekannt</documentation> </annotation> </enumeration> </restriction> </simpleType> </pre>		

simpleType enum_0367

namespace	http://xml.ir-d.de/irdsa
type	restriction of string

properties	base xs:string																																																			
facets	<table border="1"> <thead> <tr> <th>Kind</th> <th>Value</th> <th>Annotation</th> </tr> </thead> <tbody> <tr> <td>enumeration</td> <td>0367001</td> <td>documentation keine</td> </tr> <tr> <td>enumeration</td> <td>0367002</td> <td>documentation Mediastinitis</td> </tr> <tr> <td>enumeration</td> <td>0367003</td> <td>documentation Sepsis</td> </tr> <tr> <td>enumeration</td> <td>0367004</td> <td>documentation broncho-pulmonale Infektion</td> </tr> <tr> <td>enumeration</td> <td>0367005</td> <td>documentation oto-laryngologische Infektion</td> </tr> <tr> <td>enumeration</td> <td>0367006</td> <td>documentation floride Endokarditis</td> </tr> <tr> <td>enumeration</td> <td>0367007</td> <td>documentation Peritonitis</td> </tr> <tr> <td>enumeration</td> <td>0367008</td> <td>documentation Wundinfektion Thorax</td> </tr> <tr> <td>enumeration</td> <td>0367009</td> <td>documentation Pleuraempyem</td> </tr> <tr> <td>enumeration</td> <td>0367010</td> <td>documentation Venenkatheterinfektion</td> </tr> <tr> <td>enumeration</td> <td>0367011</td> <td>documentation Harnwegsinfektion</td> </tr> <tr> <td>enumeration</td> <td>0367012</td> <td>documentation Wundinfektion untere Extremitäten</td> </tr> <tr> <td>enumeration</td> <td>0367013</td> <td>documentation HIV-Infektion</td> </tr> <tr> <td>enumeration</td> <td>0367014</td> <td>documentation Hepatitis B oder C</td> </tr> <tr> <td>enumeration</td> <td>0367015</td> <td>documentation andere Wundinfektion</td> </tr> <tr> <td>enumeration</td> <td>0367042</td> <td>documentation sonstige</td> </tr> </tbody> </table>	Kind	Value	Annotation	enumeration	0367001	documentation keine	enumeration	0367002	documentation Mediastinitis	enumeration	0367003	documentation Sepsis	enumeration	0367004	documentation broncho-pulmonale Infektion	enumeration	0367005	documentation oto-laryngologische Infektion	enumeration	0367006	documentation floride Endokarditis	enumeration	0367007	documentation Peritonitis	enumeration	0367008	documentation Wundinfektion Thorax	enumeration	0367009	documentation Pleuraempyem	enumeration	0367010	documentation Venenkatheterinfektion	enumeration	0367011	documentation Harnwegsinfektion	enumeration	0367012	documentation Wundinfektion untere Extremitäten	enumeration	0367013	documentation HIV-Infektion	enumeration	0367014	documentation Hepatitis B oder C	enumeration	0367015	documentation andere Wundinfektion	enumeration	0367042	documentation sonstige
Kind	Value	Annotation																																																		
enumeration	0367001	documentation keine																																																		
enumeration	0367002	documentation Mediastinitis																																																		
enumeration	0367003	documentation Sepsis																																																		
enumeration	0367004	documentation broncho-pulmonale Infektion																																																		
enumeration	0367005	documentation oto-laryngologische Infektion																																																		
enumeration	0367006	documentation floride Endokarditis																																																		
enumeration	0367007	documentation Peritonitis																																																		
enumeration	0367008	documentation Wundinfektion Thorax																																																		
enumeration	0367009	documentation Pleuraempyem																																																		
enumeration	0367010	documentation Venenkatheterinfektion																																																		
enumeration	0367011	documentation Harnwegsinfektion																																																		
enumeration	0367012	documentation Wundinfektion untere Extremitäten																																																		
enumeration	0367013	documentation HIV-Infektion																																																		
enumeration	0367014	documentation Hepatitis B oder C																																																		
enumeration	0367015	documentation andere Wundinfektion																																																		
enumeration	0367042	documentation sonstige																																																		
annotation	documentation Kat_AK_Infektion																																																			
source	<pre> <simpleType name="enum_0367"> <annotation> <documentation>Kat_AK_Infektion</documentation> </annotation> <restriction base="xs:string"> <enumeration value="0367001"> <annotation> <documentation>keine</documentation> </annotation> </enumeration> <enumeration value="0367002"> <annotation> <documentation>Mediastinitis</documentation> </annotation> </enumeration> <enumeration value="0367003"> <annotation> <documentation>Sepsis</documentation> </annotation> </enumeration> <enumeration value="0367004"> <annotation> <documentation>broncho-pulmonale Infektion</documentation> </annotation> </enumeration> </restriction> </simpleType> </pre>																																																			

```
<enumeration value="0367005">
  <annotation>
    <documentation>oto-laryngologische Infektion</documentation>
  </annotation>
</enumeration>
<enumeration value="0367006">
  <annotation>
    <documentation>floride Endokarditis</documentation>
  </annotation>
</enumeration>
<enumeration value="0367007">
  <annotation>
    <documentation>Peritonitis</documentation>
  </annotation>
</enumeration>
<enumeration value="0367008">
  <annotation>
    <documentation>Wundinfektion Thorax</documentation>
  </annotation>
</enumeration>
<enumeration value="0367009">
  <annotation>
    <documentation>Pleuraempyem</documentation>
  </annotation>
</enumeration>
<enumeration value="0367010">
  <annotation>
    <documentation>Venenkatheterinfektion</documentation>
  </annotation>
</enumeration>
<enumeration value="0367011">
  <annotation>
    <documentation>Harnwegsinfektion</documentation>
  </annotation>
</enumeration>
<enumeration value="0367012">
  <annotation>
    <documentation>Wundinfektion untere Extremitäten</documentation>
  </annotation>
</enumeration>
<enumeration value="0367013">
  <annotation>
    <documentation>HIV-Infektion</documentation>
  </annotation>
</enumeration>
<enumeration value="0367014">
  <annotation>
    <documentation>Hepatitis B oder C</documentation>
  </annotation>
</enumeration>
<enumeration value="0367015">
  <annotation>
    <documentation>andere Wundinfektion</documentation>
  </annotation>
</enumeration>
<enumeration value="0367042">
  <annotation>
    <documentation>sonstige</documentation>
  </annotation>
</enumeration>
```

```

</enumeration>
</restriction>
</simpleType>

```

simpleType enum_0368

namespace	http://xml.ir-d.de/irdsa		
type	restriction of string		
properties	base xs:string		
facets	Kind	Value	Annotation
	enumeration	0368001	documentation nein
	enumeration	0368002	documentation ja, COPD mit Dauermedikation
	enumeration	0368003	documentation ja, COPD ohne Dauermedikation
	enumeration	0368004	documentation ja, andere Lungenerkrankungen
	enumeration	0368099	documentation unbekannt
annotation	documentation Kat_AK_Lungenerkrankung		
source	<pre> <simpleType name="enum_0368"> <annotation> <documentation>Kat_AK_Lungenerkrankung</documentation> </annotation> <restriction base="xs:string"> <enumeration value="0368001"> <annotation> <documentation>nein</documentation> </annotation> </enumeration> <enumeration value="0368002"> <annotation> <documentation>ja, COPD mit Dauermedikation</documentation> </annotation> </enumeration> <enumeration value="0368003"> <annotation> <documentation>ja, COPD ohne Dauermedikation</documentation> </annotation> </enumeration> <enumeration value="0368004"> <annotation> <documentation>ja, andere Lungenerkrankungen</documentation> </annotation> </enumeration> <enumeration value="0368099"> <annotation> <documentation>unbekannt</documentation> </annotation> </enumeration> </restriction> </simpleType> </pre>		

simpleType enum_0369

namespace	http://xml.ir-d.de/irdsa		
type	restriction of string		
properties	base xs:string		
facets	Kind	Value	Annotation
	enumeration	0369001	documentation nein
	enumeration	0369002	documentation akut
	enumeration	0369003	documentation chronisch
annotation	documentation Kat_AK_Nierenersatztherapie		
source	<pre> <simpleType name="enum_0369"> <annotation> <documentation>Kat_AK_Nierenersatztherapie</documentation> </annotation> <restriction base="xs:string"> <enumeration value="0369001"> <annotation> <documentation>nein</documentation> </annotation> </enumeration> <enumeration value="0369002"> <annotation> <documentation>akut</documentation> </annotation> </enumeration> <enumeration value="0369003"> <annotation> <documentation>chronisch</documentation> </annotation> </enumeration> </restriction> </simpleType> </pre>		

simpleType enum_0370

namespace	http://xml.ir-d.de/irdsa		
type	restriction of string		
properties	base xs:string		
facets	Kind	Value	Annotation
	enumeration	0370001	documentation Echokardiographie
	enumeration	0370002	documentation Herzkatheter
	enumeration	0370042	documentation andere
annotation	documentation Kat_AK_AKOEFMessmethode		
source	<pre> <simpleType name="enum_0370"> <annotation> <documentation>Kat_AK_AKOEFMessmethode</documentation> </annotation> <restriction base="xs:string"> </pre>		

	<pre> <enumeration value="0370001"> <annotation> <documentation>Echokardiographie</documentation> </annotation> </enumeration> <enumeration value="0370002"> <annotation> <documentation>Herzkatheter</documentation> </annotation> </enumeration> <enumeration value="0370042"> <annotation> <documentation>andere</documentation> </annotation> </enumeration> </restriction> </simpleType> </pre>
--	--

simpleType enum 0371

namespace	http://xml.ir-d.de/irdsa		
type	restriction of string		
properties	base xs:string		
facets	Kind	Value	Annotation
	enumeration	0371001	documentation keine
	enumeration	0371002	documentation leicht
	enumeration	0371003	documentation mittel
	enumeration	0371004	documentation schwer
	enumeration	0371099	documentation unbekannt
annotation	documentation Kat_AK_Verkalkungsgrad		
source	<pre> <simpleType name="enum_0371"> <annotation> <documentation>Kat_AK_Verkalkungsgrad</documentation> </annotation> <restriction base="xs:string"> <enumeration value="0371001"> <annotation> <documentation>keine</documentation> </annotation> </enumeration> <enumeration value="0371002"> <annotation> <documentation>leicht</documentation> </annotation> </enumeration> <enumeration value="0371003"> <annotation> <documentation>mittel</documentation> </annotation> </enumeration> <enumeration value="0371004"> </pre>		

	<pre> <annotation> <documentation>schwer</documentation> </annotation> </enumeration> <enumeration value="0371099"> <annotation> <documentation>unbekannt</documentation> </annotation> </enumeration> </restriction> </simpleType> </pre>
--	--

simpleType enum_0372

namespace	http://xml.ir-d.de/irdsa		
type	restriction of string		
properties	base xs:string		
facets	Kind	Value	Annotation
	enumeration	0372001	documentation nein
	enumeration	0372002	documentation ja, bicuspide
	enumeration	0372003	documentation ja, unicuspide
	enumeration	0372099	documentation unbekannt
annotation	documentation Kat_AK_BiUnicuspideKlappe		
source	<pre> <simpleType name="enum_0372"> <annotation> <documentation>Kat_AK_BiUnicuspideKlappe</documentation> </annotation> <restriction base="xs:string"> <enumeration value="0372001"> <annotation> <documentation>nein</documentation> </annotation> </enumeration> <enumeration value="0372002"> <annotation> <documentation>ja, bicuspide</documentation> </annotation> </enumeration> <enumeration value="0372003"> <annotation> <documentation>ja, unicuspide</documentation> </annotation> </enumeration> <enumeration value="0372099"> <annotation> <documentation>unbekannt</documentation> </annotation> </enumeration> </restriction> </simpleType> </pre>		

simpleType enum_0373

namespace	http://xml.ir-d.de/irdsa		
type	restriction of string		
properties	base xs:string		
facets	Kind	Value	Annotation
	enumeration	0373001	documentation keine
	enumeration	0373002	documentation leichtgradig
	enumeration	0373003	documentation mittelgradig
	enumeration	0373004	documentation hochgradig
	enumeration	0373099	documentation unbekannt
annotation	documentation Kat_AK_Grad		
source	<pre> <simpleType name="enum_0373"> <annotation> <documentation>Kat_AK_Grad</documentation> </annotation> <restriction base="xs:string"> <enumeration value="0373001"> <annotation> <documentation>keine</documentation> </annotation> </enumeration> <enumeration value="0373002"> <annotation> <documentation>leichtgradig</documentation> </annotation> </enumeration> <enumeration value="0373003"> <annotation> <documentation>mittelgradig</documentation> </annotation> </enumeration> <enumeration value="0373004"> <annotation> <documentation>hochgradig</documentation> </annotation> </enumeration> <enumeration value="0373099"> <annotation> <documentation>unbekannt</documentation> </annotation> </enumeration> </restriction> </simpleType> </pre>		

simpleType enum_0374

namespace	http://xml.ir-d.de/irdsa
type	restriction of string

properties	base xs:string																								
facets	<table border="1"> <thead> <tr> <th>Kind</th> <th>Value</th> <th>Annotation</th> </tr> </thead> <tbody> <tr> <td>enumeration</td> <td>0374001</td> <td>documentation nein</td> </tr> <tr> <td>enumeration</td> <td>0374002</td> <td>documentation ja, &lt;= 6 Stunden</td> </tr> <tr> <td>enumeration</td> <td>0374003</td> <td>documentation ja, &gt; 6 Stunden bis &lt;= 24 Stunden</td> </tr> <tr> <td>enumeration</td> <td>0374004</td> <td>documentation ja, &gt; 1 bis 7 Tage</td> </tr> <tr> <td>enumeration</td> <td>0374005</td> <td>documentation ja, &gt; 7 bis 21 Tage</td> </tr> <tr> <td>enumeration</td> <td>0374006</td> <td>documentation ja, &gt; 21 Tage</td> </tr> <tr> <td>enumeration</td> <td>0374099</td> <td>documentation unbekannt</td> </tr> </tbody> </table>	Kind	Value	Annotation	enumeration	0374001	documentation nein	enumeration	0374002	documentation ja, <= 6 Stunden	enumeration	0374003	documentation ja, > 6 Stunden bis <= 24 Stunden	enumeration	0374004	documentation ja, > 1 bis 7 Tage	enumeration	0374005	documentation ja, > 7 bis 21 Tage	enumeration	0374006	documentation ja, > 21 Tage	enumeration	0374099	documentation unbekannt
Kind	Value	Annotation																							
enumeration	0374001	documentation nein																							
enumeration	0374002	documentation ja, <= 6 Stunden																							
enumeration	0374003	documentation ja, > 6 Stunden bis <= 24 Stunden																							
enumeration	0374004	documentation ja, > 1 bis 7 Tage																							
enumeration	0374005	documentation ja, > 7 bis 21 Tage																							
enumeration	0374006	documentation ja, > 21 Tage																							
enumeration	0374099	documentation unbekannt																							
annotation	documentation Kat_AK_InfarktAnamnese																								
source	<pre> <simpleType name="enum_0374"> <annotation> <documentation>Kat_AK_InfarktAnamnese</documentation> </annotation> <restriction base="xs:string"> <enumeration value="0374001"> <annotation> <documentation>nein</documentation> </annotation> </enumeration> <enumeration value="0374002"> <annotation> <documentation>ja, &lt;= 6 Stunden</documentation> </annotation> </enumeration> <enumeration value="0374003"> <annotation> <documentation>ja, &gt; 6 Stunden bis &lt;= 24 Stunden</documentation> </annotation> </enumeration> <enumeration value="0374004"> <annotation> <documentation>ja, &gt; 1 bis 7 Tage</documentation> </annotation> </enumeration> <enumeration value="0374005"> <annotation> <documentation>ja, &gt; 7 bis 21 Tage</documentation> </annotation> </enumeration> <enumeration value="0374006"> <annotation> <documentation>ja, &gt; 21 Tage</documentation> </annotation> </enumeration> <enumeration value="0374099"> <annotation> <documentation>unbekannt</documentation> </annotation> </enumeration> </restriction> </pre>																								

	<code></simpleType></code>
--	----------------------------------

simpleType enum_0375

namespace	http://xml.ir-d.de/irdsa																								
type	restriction of string																								
properties	base xs:string																								
facets	<table><thead><tr><th>Kind</th><th>Value</th><th>Annotation</th></tr></thead><tbody><tr><td>enumeration</td><td>0375001</td><td>documentation keine Symptome oder Angina</td></tr><tr><td>enumeration</td><td>0375002</td><td>documentation Symptome, aber keine Ischämiezeichen</td></tr><tr><td>enumeration</td><td>0375003</td><td>documentation stabile Angina</td></tr><tr><td>enumeration</td><td>0375004</td><td>documentation instabile Angina</td></tr><tr><td>enumeration</td><td>0375005</td><td>documentation Infarkt ohne ST-Hebung (Non-STEMI)</td></tr><tr><td>enumeration</td><td>0375006</td><td>documentation Infarkt mit ST-Hebung (STEMI)</td></tr><tr><td>enumeration</td><td>0375042</td><td>documentation unbekannt</td></tr></tbody></table>	Kind	Value	Annotation	enumeration	0375001	documentation keine Symptome oder Angina	enumeration	0375002	documentation Symptome, aber keine Ischämiezeichen	enumeration	0375003	documentation stabile Angina	enumeration	0375004	documentation instabile Angina	enumeration	0375005	documentation Infarkt ohne ST-Hebung (Non-STEMI)	enumeration	0375006	documentation Infarkt mit ST-Hebung (STEMI)	enumeration	0375042	documentation unbekannt
Kind	Value	Annotation																							
enumeration	0375001	documentation keine Symptome oder Angina																							
enumeration	0375002	documentation Symptome, aber keine Ischämiezeichen																							
enumeration	0375003	documentation stabile Angina																							
enumeration	0375004	documentation instabile Angina																							
enumeration	0375005	documentation Infarkt ohne ST-Hebung (Non-STEMI)																							
enumeration	0375006	documentation Infarkt mit ST-Hebung (STEMI)																							
enumeration	0375042	documentation unbekannt																							
annotation	documentation Kat_AK_KardialeSymptome																								
source	<pre><simpleType name="enum_0375"> <annotation> <documentation>Kat_AK_KardialeSymptome</documentation> </annotation> <restriction base="xs:string"> <enumeration value="0375001"> <annotation> <documentation>keine Symptome oder Angina</documentation> </annotation> </enumeration> <enumeration value="0375002"> <annotation> <documentation>Symptome, aber keine Ischämiezeichen</documentation> </annotation> </enumeration> <enumeration value="0375003"> <annotation> <documentation>stabile Angina</documentation> </annotation> </enumeration> <enumeration value="0375004"> <annotation> <documentation>instabile Angina</documentation> </annotation> </enumeration> <enumeration value="0375005"> <annotation> <documentation>Infarkt ohne ST-Hebung (Non-STEMI)</documentation> </annotation> </enumeration> <enumeration value="0375006"> <annotation> <documentation>Infarkt mit ST-Hebung (STEMI)</documentation> </annotation> </enumeration> </restriction> </simpleType></pre>																								

	<pre> </annotation> </enumeration> <enumeration value="0375042"> <annotation> <documentation>unbekannt</documentation> </annotation> </enumeration> </restriction> </simpleType> </pre>
--	---

simpleType enum_0376

namespace	http://xml.ir-d.de/irdsa		
type	restriction of string		
properties	base xs:string		
facets	Kind	Value	Annotation
	enumeration	0376001	documentation nein
	enumeration	0376002	documentation ja, ZNS, zerebrovaskuläre Blutung
	enumeration	0376003	documentation ja, ZNS, zerebrovaskuläre Ischämie
	enumeration	0376042	documentation ja, ZNS, andere
annotation	documentation Kat_AK_Schlaganfall		
source	<pre> <simpleType name="enum_0376"> <annotation> <documentation>Kat_AK_Schlaganfall</documentation> </annotation> <restriction base="xs:string"> <enumeration value="0376001"> <annotation> <documentation>nein</documentation> </annotation> </enumeration> <enumeration value="0376002"> <annotation> <documentation>ja, ZNS, zerebrovaskuläre Blutung</documentation> </annotation> </enumeration> <enumeration value="0376003"> <annotation> <documentation>ja, ZNS, zerebrovaskuläre Ischämie</documentation> </annotation> </enumeration> <enumeration value="0376042"> <annotation> <documentation>ja, ZNS, andere</documentation> </annotation> </enumeration> </restriction> </simpleType> </pre>		

simpleType enum_0377

namespace	http://xml.ir-d.de/irdsa		
type	restriction of string		
properties	base xs:string		
facets	Kind	Value	Annotation
	enumeration	0377001	documentation ja, mild neurological dysfunction: NIHSS 0-5
	enumeration	0377002	documentation ja, moderate neurological dysfunction: NIHSS 6-14
	enumeration	0377003	documentation ja, severe neurological dysfunction: NIHSS >=15
annotation	documentation Kat_AK_Nihss		
source	<pre> <simpleType name="enum_0377"> <annotation> <documentation>Kat_AK_Nihss</documentation> </annotation> <restriction base="xs:string"> <enumeration value="0377001"> <annotation> <documentation>ja, mild neurological dysfunction: NIHSS 0- 5</documentation> </annotation> </enumeration> <enumeration value="0377002"> <annotation> <documentation>ja, moderate neurological dysfunction: NIHSS 6- 14</documentation> </annotation> </enumeration> <enumeration value="0377003"> <annotation> <documentation>ja, severe neurological dysfunction: NIHSS &gt;=15</documentation> </annotation> </enumeration> </restriction> </simpleType> </pre>		

simpleType enum_0378

namespace	http://xml.ir-d.de/irdsa		
type	restriction of string		
properties	base xs:string		
facets	Kind	Value	Annotation
	enumeration	0378001	documentation nein
	enumeration	0378002	documentation ja, < 48h gemäss VARC-3-Definition
	enumeration	0378003	documentation ja, >= 48h - <= 72h gemäß VARC-3-Definition
	enumeration	0378004	documentation ja, > 72 h gemäß VARC-3 Definition
annotation	documentation Kat_AK_Myokardinfarkt		

source	<pre> <simpleType name="enum_0378"> <annotation> <documentation>Kat_AK_Myokardinfarkt</documentation> </annotation> <restriction base="xs:string"> <enumeration value="0378001"> <annotation> <documentation>nein</documentation> </annotation> </enumeration> <enumeration value="0378002"> <annotation> <documentation>ja, &lt; 48h gemäss VARC-3-Definition</documentation> </annotation> </enumeration> <enumeration value="0378003"> <annotation> <documentation>ja, &gt;= 48h - &lt;= 72h gemäß VARC-3- Definition</documentation> </annotation> </enumeration> <enumeration value="0378004"> <annotation> <documentation>ja, &gt; 72 h gemäß VARC-3 Definition</documentation> </annotation> </enumeration> </restriction> </simpleType> </pre>
--------	--

simpleType enum_0379

namespace	http://xml.ir-d.de/irdsa		
type	restriction of string		
properties	base xs:string		
facets	Kind	Value	Annotation
	enumeration	0379001	documentation Keine gefäss- oder zugangsassozierte Komplikationen
	enumeration	0379002	documentation Versagen des perkutanen Verschlusssystems
	enumeration	0379003	documentation Geringfügige Gefäßkomplikationen
	enumeration	0379004	documentation Erhebliche Gefäßkomplikationen
annotation	documentation Kat_AK_ZugangKomplikationen		
source	<pre> <simpleType name="enum_0379"> <annotation> <documentation>Kat_AK_ZugangKomplikationen</documentation> </annotation> <restriction base="xs:string"> <enumeration value="0379001"> <annotation> <documentation>Keine gefäss- oder zugangsassozierte Komplikationen</documentation> </annotation> </enumeration> <enumeration value="0379002"> </pre>		

	<pre> <annotation> <documentation>Versagen des perkutanen Verschlussystems</documentation> </annotation> </enumeration> <enumeration value="0379003"> <annotation> <documentation>Geringfügige Gefäßkomplikationen</documentation> </annotation> </enumeration> <enumeration value="0379004"> <annotation> <documentation>Erhebliche Gefäßkomplikationen</documentation> </annotation> </enumeration> </restriction> </simpleType> </pre>
--	---

simpleType enum_0380

namespace	http://xml.ir-d.de/irdsa		
type	restriction of string		
properties	base xs:string		
facets	Kind	Value	Annotation
	enumeration	0380001	documentation nein
	enumeration	0380002	documentation ja, intraprozedural
	enumeration	0380003	documentation ja, postprozedural
	enumeration	0380004	documentation ja, Zeitpunkt nicht bekannt
annotation	documentation Kat_AK_Reanimation		
source	<pre> <simpleType name="enum_0380"> <annotation> <documentation>Kat_AK_Reanimation</documentation> </annotation> <restriction base="xs:string"> <enumeration value="0380001"> <annotation> <documentation>nein</documentation> </annotation> </enumeration> <enumeration value="0380002"> <annotation> <documentation>ja, intraprozedural</documentation> </annotation> </enumeration> <enumeration value="0380003"> <annotation> <documentation>ja, postprozedural</documentation> </annotation> </enumeration> <enumeration value="0380004"> <annotation> <documentation>ja, Zeitpunkt nicht bekannt</documentation> </annotation> </enumeration> </restriction> </simpleType> </pre>		

```

</annotation>
</enumeration>
</restriction>
</simpleType>

```

simpleType enum_0381

namespace	http://xml.ir-d.de/irdsa		
type	restriction of string		
properties	base xs:string		
facets	Kind	Value	Annotation
	enumeration	0381001	documentation nein
	enumeration	0381002	documentation Thorakotomie/Rethorakotomie
	enumeration	0381003	documentation kathetergestützte Reintervention
	enumeration	0381004	documentation lokale Reinterventionen
	enumeration	0381005	documentation andere Reintervention
annotation	documentation Kat_AK_Massnahmen		
source	<pre> <simpleType name="enum_0381"> <annotation> <documentation>Kat_AK_Massnahmen</documentation> </annotation> <restriction base="xs:string"> <enumeration value="0381001"> <annotation> <documentation>nein</documentation> </annotation> </enumeration> <enumeration value="0381002"> <annotation> <documentation>Thorakotomie/Rethorakotomie</documentation> </annotation> </enumeration> <enumeration value="0381003"> <annotation> <documentation>kathetergestützte Reintervention</documentation> </annotation> </enumeration> <enumeration value="0381004"> <annotation> <documentation>lokale Reinterventionen</documentation> </annotation> </enumeration> <enumeration value="0381005"> <annotation> <documentation>andere Reintervention</documentation> </annotation> </enumeration> </restriction> </simpleType> </pre>		

simpleType enum_0382

namespace	http://xml.ir-d.de/irdsa		
type	restriction of string		
properties	base xs:string		
facets	Kind	Value	Annotation
	enumeration	0382001	documentation keine Rethorakotomie / kein weiterer Grund
	enumeration	0382002	documentation Blutung/Hämatom
	enumeration	0382003	documentation Low Cardiac Output
	enumeration	0382004	documentation Tamponade
	enumeration	0382005	documentation Graftprobleme, Ischämie
	enumeration	0382006	documentation Wundinfektion, Mediastinitis
	enumeration	0382007	documentation Dissektion
	enumeration	0382008	documentation Prothesendysfunktion
	enumeration	0382009	documentation instabiles Sternum
	enumeration	0382010	documentation Chylothorax
	enumeration	0382011	documentation lokale Revision im Bereich des Zugangsweges
	enumeration	0382042	documentation anderer Grund
annotation	documentation Kat_AK_Komplikation		
source	<pre> <simpleType name="enum_0382"> <annotation> <documentation>Kat_AK_Komplikation</documentation> </annotation> <restriction base="xs:string"> <enumeration value="0382001"> <annotation> <documentation>keine Rethorakotomie / kein weiterer Grund</documentation> </annotation> </enumeration> <enumeration value="0382002"> <annotation> <documentation>Blutung/Hämatom</documentation> </annotation> </enumeration> <enumeration value="0382003"> <annotation> <documentation>Low Cardiac Output</documentation> </annotation> </enumeration> <enumeration value="0382004"> <annotation> <documentation>Tamponade</documentation> </annotation> </enumeration> <enumeration value="0382005"> </pre>		

```

    <annotation>
      <documentation>Graftprobleme, Ischämie</documentation>
    </annotation>
  </enumeration>
  <enumeration value="0382006">
    <annotation>
      <documentation>Wundinfektion, Mediastinitis</documentation>
    </annotation>
  </enumeration>
  <enumeration value="0382007">
    <annotation>
      <documentation>Dissektion</documentation>
    </annotation>
  </enumeration>
  <enumeration value="0382008">
    <annotation>
      <documentation>Prothesendysfunktion</documentation>
    </annotation>
  </enumeration>
  <enumeration value="0382009">
    <annotation>
      <documentation>instabiles Sternum</documentation>
    </annotation>
  </enumeration>
  <enumeration value="0382010">
    <annotation>
      <documentation>Chylothorax</documentation>
    </annotation>
  </enumeration>
  <enumeration value="0382011">
    <annotation>
      <documentation>lokale Revision im Bereich des
Zugangsweges</documentation>
    </annotation>
  </enumeration>
  <enumeration value="0382042">
    <annotation>
      <documentation>anderer Grund</documentation>
    </annotation>
  </enumeration>
</restriction>
</simpleType>

```

simpleType enum_0383

namespace	http://xml.ir-d.de/irdsa		
type	restriction of string		
properties	base xs:string		
facets	Kind	Value	Annotation
	enumeration	0383001	documentation nein
	enumeration	0383002	documentation ja, mit forcierter Atemtherapie
	enumeration	0383003	documentation ja, Reintubation oder längerfristige Beatmung
	enumeration	0383004	documentation ja, Tracheotomie

annotation	documentation Kat_AK_RespiratorischeInsuffizienz
source	<pre> <simpleType name="enum_0383"> <annotation> <documentation>Kat_AK_RespiratorischeInsuffizienz</documentation> </annotation> <restriction base="xs:string"> <enumeration value="0383001"> <annotation> <documentation>nein</documentation> </annotation> </enumeration> <enumeration value="0383002"> <annotation> <documentation>ja, mit forcierter Atemtherapie</documentation> </annotation> </enumeration> <enumeration value="0383003"> <annotation> <documentation>ja, Reintubation oder längerfristige Beatmung</documentation> </annotation> </enumeration> <enumeration value="0383004"> <annotation> <documentation>ja, Tracheotomie</documentation> </annotation> </enumeration> </restriction> </simpleType> </pre>

simpleType enum_0384

namespace	http://xml.ir-d.de/irdsa		
type	restriction of string		
properties	base xs:string		
facets	Kind	Value	Annotation
	enumeration	0384001	documentation keine Blutungskomplikationen
	enumeration	0384002	documentation Geringfügige Blutung (Minor Bleeding - BARC type 2 or 3a)
	enumeration	0384003	documentation Starke Blutung (Major Bleeding - BARC type 3a)
	enumeration	0384004	documentation Lebensbedrohliche Blutung (Life-threatening or disabling bleeding - BARC type 3b or 3c or type 5)
annotation	documentation Kat_AK_Blutungskomplikation		
source	<pre> <simpleType name="enum_0384"> <annotation> <documentation>Kat_AK_Blutungskomplikation</documentation> </annotation> <restriction base="xs:string"> <enumeration value="0384001"> <annotation> <documentation>keine Blutungskomplikationen</documentation> </annotation> </pre>		

	<pre> </enumeration> <enumeration value="0384002"> <annotation> <documentation>Geringfügige Blutung (Minor Bleeding - BARC type 2 or 3a)</documentation> </annotation> </enumeration> <enumeration value="0384003"> <annotation> <documentation>Starke Blutung (Major Bleeding - BARC type 3a)</documentation> </annotation> </enumeration> <enumeration value="0384004"> <annotation> <documentation>Lebensbedrohliche Blutung (Life-threatening or disabling bleeding - BARC type 3b or 3c or type 5)</documentation> </annotation> </enumeration> </restriction> </simpleType> </pre>
--	--

simpleType enum_0385

namespace	http://xml.ir-d.de/irdsa		
type	restriction of string		
properties	base xs:string		
facets	Kind	Value	Annotation
	enumeration	0385001	documentation Sinusrhythmus
	enumeration	0385002	documentation Vorhofflimmern
	enumeration	0385003	documentation Patient verstorben (kein Herzrhythmus)
	enumeration	0385042	documentation anderer Rhythmus
annotation	documentation Kat_AK_HerzrhythmusEntlassung		
source	<pre> <simpleType name="enum_0385"> <annotation> <documentation>Kat_AK_HerzrhythmusEntlassung</documentation> </annotation> <restriction base="xs:string"> <enumeration value="0385001"> <annotation> <documentation>Sinusrhythmus</documentation> </annotation> </enumeration> <enumeration value="0385002"> <annotation> <documentation>Vorhofflimmern</documentation> </annotation> </enumeration> <enumeration value="0385003"> <annotation> <documentation>Patient verstorben (kein Herzrhythmus)</documentation> </annotation> </enumeration> </restriction> </simpleType> </pre>		

	<pre> </enumeration> <enumeration value="0385042"> <annotation> <documentation>anderer Rhythmus</documentation> </annotation> </enumeration> </restriction> </simpleType> </pre>
--	--

simpleType enum_0388

namespace	http://xml.ir-d.de/irdsa		
type	restriction of string		
properties	base xs:string		
facets	Kind	Value	Annotation
	enumeration	0388001	documentation nein
	enumeration	0388002	documentation ASS
	enumeration	0388003	documentation ADP-Rezeptor-Antagonist
	enumeration	0388004	documentation Kombination ASS und ADP-Rezeptor-Antagonist
	enumeration	0388042	documentation ja, andere
	enumeration	0388099	documentation unbekannt
annotation	documentation Kat_AK_Plaettchenaggregationshemmer		
source	<pre> <simpleType name="enum_0388"> <annotation> <documentation>Kat_AK_Plaettchenaggregationshemmer</documentation> </annotation> <restriction base="xs:string"> <enumeration value="0388001"> <annotation> <documentation>nein</documentation> </annotation> </enumeration> <enumeration value="0388002"> <annotation> <documentation>ASS</documentation> </annotation> </enumeration> <enumeration value="0388003"> <annotation> <documentation>ADP-Rezeptor-Antagonist</documentation> </annotation> </enumeration> <enumeration value="0388004"> <annotation> <documentation>Kombination ASS und ADP-Rezeptor- Antagonist</documentation> </annotation> </enumeration> <enumeration value="0388042"> <annotation> </pre>		

	<pre> <documentation>ja, andere</documentation> </annotation> </enumeration> <enumeration value="0388099"> <annotation> <documentation>unbekannt</documentation> </annotation> </enumeration> </restriction> </simpleType> </pre>
--	---

simpleType enum_0389

namespace	http://xml.ir-d.de/irdsa		
type	restriction of string		
properties	base xs:string		
facets	Kind	Value	Annotation
	enumeration	0389001	documentation nein
	enumeration	0389002	documentation Cumarin-Derivate
	enumeration	0389003	documentation Heparinoide
	enumeration	0389004	documentation orale Thrombinantagonisten
	enumeration	0389006	documentation Direkte orale Antikoagulantien (DOAK / NOAK)
	enumeration	0389042	documentation ja, andere
	enumeration	0389099	documentation unbekannt
annotation	documentation Kat_AK_Antikoagulantien		
source	<pre> <simpleType name="enum_0389"> <annotation> <documentation>Kat_AK_Antikoagulantien</documentation> </annotation> <restriction base="xs:string"> <enumeration value="0389001"> <annotation> <documentation>nein</documentation> </annotation> </enumeration> <enumeration value="0389002"> <annotation> <documentation>Cumarin-Derivate</documentation> </annotation> </enumeration> <enumeration value="0389003"> <annotation> <documentation>Heparinoide</documentation> </annotation> </enumeration> <enumeration value="0389004"> <annotation> <documentation>orale Thrombinantagonisten</documentation> </annotation> </pre>		

	<pre> </enumeration> <enumeration value="0389006"> <annotation> <documentation>Direkte orale Antikoagulantien (DOAK / NOAK)</documentation> </annotation> </enumeration> <enumeration value="0389042"> <annotation> <documentation>ja, andere</documentation> </annotation> </enumeration> <enumeration value="0389099"> <annotation> <documentation>unbekannt</documentation> </annotation> </enumeration> </restriction> </simpleType> </pre>
--	---

simpleType enum_0390

namespace	http://xml.ir-d.de/irdsa		
type	restriction of string		
properties	base xs:string		
facets	Kind	Value	Annotation
	enumeration	0390001	documentation biologisches Klappenmodell
	enumeration	0390002	documentation mechanisches Klappenmodell
annotation	documentation Kat_AK_Artikeltyp		
source	<pre> <simpleType name="enum_0390"> <annotation> <documentation>Kat_AK_Artikeltyp</documentation> </annotation> <restriction base="xs:string"> <enumeration value="0390001"> <annotation> <documentation>biologisches Klappenmodell</documentation> </annotation> </enumeration> <enumeration value="0390002"> <annotation> <documentation>mechanisches Klappenmodell</documentation> </annotation> </enumeration> </restriction> </simpleType> </pre>		

simpleType enum_0391

namespace	http://xml.ir-d.de/irdsa
type	restriction of string

properties	base xs:string									
facets	<table border="1"> <thead> <tr> <th>Kind</th> <th>Value</th> <th>Annotation</th> </tr> </thead> <tbody> <tr> <td>enumeration</td> <td>0391001</td> <td>documentation chirurgische Klappe</td> </tr> <tr> <td>enumeration</td> <td>0391002</td> <td>documentation TAVI-Klappe</td> </tr> </tbody> </table>	Kind	Value	Annotation	enumeration	0391001	documentation chirurgische Klappe	enumeration	0391002	documentation TAVI-Klappe
Kind	Value	Annotation								
enumeration	0391001	documentation chirurgische Klappe								
enumeration	0391002	documentation TAVI-Klappe								
annotation	documentation Kat_AK_Klappentyp									
source	<pre> <simpleType name="enum_0391"> <annotation> <documentation>Kat_AK_Klappentyp</documentation> </annotation> <restriction base="xs:string"> <enumeration value="0391001"> <annotation> <documentation>chirurgische Klappe</documentation> </annotation> </enumeration> <enumeration value="0391002"> <annotation> <documentation>TAVI-Klappe</documentation> </annotation> </enumeration> </restriction> </simpleType> </pre>									

simpleType enum_0398

namespace	http://xml.ir-d.de/irdsa												
type	restriction of string												
properties	base xs:string												
facets	<table border="1"> <thead> <tr> <th>Kind</th> <th>Value</th> <th>Annotation</th> </tr> </thead> <tbody> <tr> <td>enumeration</td> <td>0398001</td> <td>documentation kardiovaskuläre Ursache</td> </tr> <tr> <td>enumeration</td> <td>0398002</td> <td>documentation nicht-kardiovaskuläre Ursache</td> </tr> <tr> <td>enumeration</td> <td>0398099</td> <td>documentation Todesursache unbekannt</td> </tr> </tbody> </table>	Kind	Value	Annotation	enumeration	0398001	documentation kardiovaskuläre Ursache	enumeration	0398002	documentation nicht-kardiovaskuläre Ursache	enumeration	0398099	documentation Todesursache unbekannt
Kind	Value	Annotation											
enumeration	0398001	documentation kardiovaskuläre Ursache											
enumeration	0398002	documentation nicht-kardiovaskuläre Ursache											
enumeration	0398099	documentation Todesursache unbekannt											
annotation	documentation Kat_AK_Todesursache												
source	<pre> <simpleType name="enum_0398"> <annotation> <documentation>Kat_AK_Todesursache</documentation> </annotation> <restriction base="xs:string"> <enumeration value="0398001"> <annotation> <documentation>kardiovaskuläre Ursache</documentation> </annotation> </enumeration> <enumeration value="0398002"> <annotation> <documentation>nicht-kardiovaskuläre Ursache</documentation> </annotation> </enumeration> <enumeration value="0398099"> </pre>												

	<pre> <annotation> <documentation>Todesursache unbekannt</documentation> </annotation> </enumeration> </restriction> </simpleType> </pre>
--	---

simpleType enum_0399

namespace	http://xml.ir-d.de/irdsa		
type	restriction of string		
properties	base xs:string		
facets	Kind	Value	Annotation
	enumeration	0399001	documentation Patient lebt
	enumeration	0399002	documentation Patient im Krankenhaus verstorben
annotation	documentation Kat_AK_Vitalstatus		
source	<pre> <simpleType name="enum_0399"> <annotation> <documentation>Kat_AK_Vitalstatus</documentation> </annotation> <restriction base="xs:string"> <enumeration value="0399001"> <annotation> <documentation>Patient lebt</documentation> </annotation> </enumeration> <enumeration value="0399002"> <annotation> <documentation>Patient im Krankenhaus verstorben</documentation> </annotation> </enumeration> </restriction> </simpleType> </pre>		

simpleType enum_0044

namespace	http://xml.ir-d.de/sak		
type	restriction of string		
properties	base xs:string		
facets	Kind	Value	Annotation
	enumeration	0044001	documentation 1= normaler, sonst gesunder Patient
	enumeration	0044002	documentation 2= Patient mit leichter Allgemeinerkrankung
	enumeration	0044003	documentation 3= Patient mit schwerer Allgemeinerkrankung
	enumeration	0044004	documentation 4= Patient mit schwerer Allgemeinerkrankung, die eine ständige Lebensbedrohung darstellt
	enumeration	0044005	documentation 5= moribunder Patient, der ohne die Operation voraussichtlich nicht überleben wird

annotation	documentation Kat_ASA
source	<pre> <simpleType name="enum_0044"> <annotation> <documentation>Kat_ASA</documentation> </annotation> <restriction base="xs:string"> <enumeration value="0044001"> <annotation> <documentation>1= normaler, sonst gesunder Patient</documentation> </annotation> </enumeration> <enumeration value="0044002"> <annotation> <documentation>2= Patient mit leichter Allgemeinerkrankung</documentation> </annotation> </enumeration> <enumeration value="0044003"> <annotation> <documentation>3= Patient mit schwerer Allgemeinerkrankung</documentation> </annotation> </enumeration> <enumeration value="0044004"> <annotation> <documentation>4= Patient mit schwerer Allgemeinerkrankung, die eine ständige Lebensbedrohung darstellt</documentation> </annotation> </enumeration> <enumeration value="0044005"> <annotation> <documentation>5= moribunder Patient, der ohne die Operation voraussichtlich nicht überleben wird</documentation> </annotation> </enumeration> </restriction> </simpleType> </pre>

simpleType enum_0050

namespace	http://xml.ir-d.de/sak		
type	restriction of string		
properties	base xs:string		
facets	Kind	Value	Annotation
	enumeration	0050001	documentation rechts
	enumeration	0050002	documentation links
annotation	documentation Kat_RechtsLinks		
source	<pre> <simpleType name="enum_0050"> <annotation> <documentation>Kat_RechtsLinks</documentation> </annotation> <restriction base="xs:string"> </pre>		

	<pre> <enumeration value="0050001"> <annotation> <documentation>rechts</documentation> </annotation> </enumeration> <enumeration value="0050002"> <annotation> <documentation>links</documentation> </annotation> </enumeration> </restriction> </simpleType> </pre>
--	--

simpleType enum_0060

namespace	http://xml.ir-d.de/sak		
type	restriction of string		
properties	base xs:string		
facets	Kind	Value	Annotation
	enumeration	0060001	documentation ja
	enumeration	0060002	documentation nein
annotation	documentation Kat_JaNein		
source	<pre> <simpleType name="enum_0060"> <annotation> <documentation>Kat_JaNein</documentation> </annotation> <restriction base="xs:string"> <enumeration value="0060001"> <annotation> <documentation>ja</documentation> </annotation> </enumeration> <enumeration value="0060002"> <annotation> <documentation>nein</documentation> </annotation> </enumeration> </restriction> </simpleType> </pre>		

simpleType enum_0061

namespace	http://xml.ir-d.de/sak		
type	restriction of string		
properties	base xs:string		
facets	Kind	Value	Annotation
	enumeration	0061001	documentation ja
	enumeration	0061002	documentation nein
	enumeration	0061099	documentation

	unbekannt
annotation	documentation Kat JaNeinUnbekannt
source	<pre> <simpleType name="enum_0061"> <annotation> <documentation>Kat_JaNeinUnbekannt</documentation> </annotation> <restriction base="xs:string"> <enumeration value="0061001"> <annotation> <documentation>ja</documentation> </annotation> </enumeration> <enumeration value="0061002"> <annotation> <documentation>nein</documentation> </annotation> </enumeration> <enumeration value="0061099"> <annotation> <documentation>unbekannt</documentation> </annotation> </enumeration> </restriction> </simpleType> </pre>

simpleType enum_0062

namespace	http://xml.ir-d.de/sak		
type	restriction of string		
properties	base	xs:string	
facets	Kind	Value	Annotation
	enumeration	0062001	documentation Stück
	enumeration	0062002	documentation g
	enumeration	0062003	documentation mg
	enumeration	0062004	documentation l
	enumeration	0062005	documentation ml
	enumeration	0062006	documentation cm ³
	enumeration	0062007	documentation mm
	enumeration	0062008	documentation cm
	enumeration	0062009	documentation dm
	enumeration	0062010	documentation m
	enumeration	0062042	documentation andere
annotation	documentation Kat_Einheit		
source	<pre> <simpleType name="enum_0062"> <annotation> </pre>		

```
<documentation>Kat_Einheit</documentation>
</annotation>
<restriction base="xs:string">
  <enumeration value="0062001">
    <annotation>
      <documentation>Stück</documentation>
    </annotation>
  </enumeration>
  <enumeration value="0062002">
    <annotation>
      <documentation>g</documentation>
    </annotation>
  </enumeration>
  <enumeration value="0062003">
    <annotation>
      <documentation>mg</documentation>
    </annotation>
  </enumeration>
  <enumeration value="0062004">
    <annotation>
      <documentation>l</documentation>
    </annotation>
  </enumeration>
  <enumeration value="0062005">
    <annotation>
      <documentation>ml</documentation>
    </annotation>
  </enumeration>
  <enumeration value="0062006">
    <annotation>
      <documentation>cm3</documentation>
    </annotation>
  </enumeration>
  <enumeration value="0062007">
    <annotation>
      <documentation>mm</documentation>
    </annotation>
  </enumeration>
  <enumeration value="0062008">
    <annotation>
      <documentation>cm</documentation>
    </annotation>
  </enumeration>
  <enumeration value="0062009">
    <annotation>
      <documentation>dm</documentation>
    </annotation>
  </enumeration>
  <enumeration value="0062010">
    <annotation>
      <documentation>m</documentation>
    </annotation>
  </enumeration>
  <enumeration value="0062042">
    <annotation>
      <documentation>andere</documentation>
    </annotation>
  </enumeration>
</restriction>
```

	<code></simpleType></code>
--	----------------------------------

simpleType enum_0065

namespace	http://xml.ir-d.de/sak												
type	restriction of string												
properties	base xs:string												
facets	<table><thead><tr><th>Kind</th><th>Value</th><th>Annotation</th></tr></thead><tbody><tr><td>enumeration</td><td>0065001</td><td>documentation stationär</td></tr><tr><td>enumeration</td><td>0065002</td><td>documentation teilstationär</td></tr><tr><td>enumeration</td><td>0065003</td><td>documentation ambulant</td></tr></tbody></table>	Kind	Value	Annotation	enumeration	0065001	documentation stationär	enumeration	0065002	documentation teilstationär	enumeration	0065003	documentation ambulant
Kind	Value	Annotation											
enumeration	0065001	documentation stationär											
enumeration	0065002	documentation teilstationär											
enumeration	0065003	documentation ambulant											
annotation	documentation Kat_ArtAufenthalt												
source	<pre><simpleType name="enum_0065"> <annotation> <documentation>Kat_ArtAufenthalt</documentation> </annotation> <restriction base="xs:string"> <enumeration value="0065001"> <annotation> <documentation>stationär</documentation> </annotation> </enumeration> <enumeration value="0065002"> <annotation> <documentation>teilstationär</documentation> </annotation> </enumeration> <enumeration value="0065003"> <annotation> <documentation>ambulant</documentation> </annotation> </enumeration> </restriction> </simpleType></pre>												

simpleType enum_0067

namespace	http://xml.ir-d.de/sak									
type	restriction of string									
properties	base xs:string									
facets	<table><thead><tr><th>Kind</th><th>Value</th><th>Annotation</th></tr></thead><tbody><tr><td>enumeration</td><td>0067001</td><td>documentation Implantat</td></tr><tr><td>enumeration</td><td>0067002</td><td>documentation Explantat</td></tr></tbody></table>	Kind	Value	Annotation	enumeration	0067001	documentation Implantat	enumeration	0067002	documentation Explantat
Kind	Value	Annotation								
enumeration	0067001	documentation Implantat								
enumeration	0067002	documentation Explantat								
annotation	documentation Kat_ArtArtikel									
source	<pre><simpleType name="enum_0067"> <annotation> <documentation>Kat_ArtArtikel</documentation> </annotation> </simpleType></pre>									

	<pre> </annotation> <restriction base="xs:string"> <enumeration value="0067001"> <annotation> <documentation>Implantat</documentation> </annotation> </enumeration> <enumeration value="0067002"> <annotation> <documentation>Explantat</documentation> </annotation> </enumeration> </restriction> </simpleType> </pre>
--	--

simpleType enum_0068

namespace	http://xml.ir-d.de/sak		
type	restriction of string		
properties	base xs:string		
facets	Kind	Value	Annotation
	enumeration	0068001	documentation UDI
	enumeration	0068002	documentation Referenz (REF)
annotation	documentation Kat_KennzeichenTyp		
source	<pre> <simpleType name="enum_0068"> <annotation> <documentation>Kat_KennzeichenTyp</documentation> </annotation> <restriction base="xs:string"> <enumeration value="0068001"> <annotation> <documentation>UDI</documentation> </annotation> </enumeration> <enumeration value="0068002"> <annotation> <documentation>Referenz (REF)</documentation> </annotation> </enumeration> </restriction> </simpleType> </pre>		

simpleType enum_0069

namespace	http://xml.ir-d.de/sak		
type	restriction of string		
properties	base xs:string		
facets	Kind	Value	Annotation
	enumeration	0069001	documentation Implantat
	enumeration	0069002	documentation

	Explantat
annotation	documentation Kat ArtZubehoer
source	<pre> <simpleType name="enum_0069"> <annotation> <documentation>Kat_ArtZubehoer</documentation> </annotation> <restriction base="xs:string"> <enumeration value="0069001"> <annotation> <documentation>Implantat</documentation> </annotation> </enumeration> <enumeration value="0069002"> <annotation> <documentation>Explantat</documentation> </annotation> </enumeration> </restriction> </simpleType> </pre>

simpleType enum_0070

namespace	http://xml.ir-d.de/sak		
type	restriction of string		
properties	base xs:string		
facets	Kind	Value	Annotation
	enumeration	0070001	documentation weiblich
	enumeration	0070002	documentation männlich
	enumeration	0070003	documentation divers
	enumeration	0070042	documentation unbestimmt
annotation	documentation Kat Geschlecht		
source	<pre> <simpleType name="enum_0070"> <annotation> <documentation>Kat_Geschlecht</documentation> </annotation> <restriction base="xs:string"> <enumeration value="0070001"> <annotation> <documentation>weiblich</documentation> </annotation> </enumeration> <enumeration value="0070002"> <annotation> <documentation>männlich</documentation> </annotation> </enumeration> <enumeration value="0070003"> <annotation> <documentation>divers</documentation> </annotation> </enumeration> </restriction> </simpleType> </pre>		

	<pre> <enumeration value="0070042"> <annotation> <documentation>unbestimmt</documentation> </annotation> </enumeration> </restriction> </simpleType> </pre>
--	---

simpleType enum_0071

namespace	http://xml.ir-d.de/sak		
type	restriction of string		
properties	base xs:string		
facets	Kind	Value	Annotation
	enumeration	0071001	documentation Implantat
	enumeration	0071002	documentation Explantat
	enumeration	0071003	documentation Degeneriertes/defektes Produkt, das funktionslos im Körper verbleibt
annotation	documentation Kat_ArtikelArtFunktion		
source	<pre> <simpleType name="enum_0071"> <annotation> <documentation>Kat_ArtikelArtFunktion</documentation> </annotation> <restriction base="xs:string"> <enumeration value="0071001"> <annotation> <documentation>Implantat</documentation> </annotation> </enumeration> <enumeration value="0071002"> <annotation> <documentation>Explantat</documentation> </annotation> </enumeration> <enumeration value="0071003"> <annotation> <documentation>Degeneriertes/defektes Produkt, das funktionslos im Körper verbleibt</documentation> </annotation> </enumeration> </restriction> </simpleType> </pre>		

simpleType enum_0075

namespace	http://xml.ir-d.de/sak		
type	restriction of string		
properties	base xs:string		
facets	Kind	Value	Annotation
	enumeration	0075001	documentation elektiv

	enumeration 0075002 documentation dringlich enumeration 0075003 documentation Notfall
annotation	documentation Kat_Dringlichkeit
source	<pre> <simpleType name="enum_0075"> <annotation> <documentation>Kat_Dringlichkeit</documentation> </annotation> <restriction base="xs:string"> <enumeration value="0075001"> <annotation> <documentation>elektiv</documentation> </annotation> </enumeration> <enumeration value="0075002"> <annotation> <documentation>dringlich</documentation> </annotation> </enumeration> <enumeration value="0075003"> <annotation> <documentation>Notfall</documentation> </annotation> </enumeration> </restriction> </simpleType> </pre>

simpleType enum 0076

namespace	http://xml.ir-d.de/sak		
type	restriction of string		
properties	base xs:string		
facets	Kind	Value	Annotation
	enumeration	0076001	documentation elektiv
	enumeration	0076002	documentation dringlich
	enumeration	0076003	documentation Notfall
	enumeration	0076004	documentation Notfall (Reanimation / ultima ratio)
annotation	documentation Kat_Dringlichkeit_Reanimation		
source	<pre> <simpleType name="enum_0076"> <annotation> <documentation>Kat_Dringlichkeit_Reanimation</documentation> </annotation> <restriction base="xs:string"> <enumeration value="0076001"> <annotation> <documentation>elektiv</documentation> </annotation> </enumeration> <enumeration value="0076002"> <annotation> </pre>		

	<pre> <documentation>dringlich</documentation> </annotation> </enumeration> <enumeration value="0076003"> <annotation> <documentation>Notfall</documentation> </annotation> </enumeration> <enumeration value="0076004"> <annotation> <documentation>Notfall (Reanimation / ultima ratio)</documentation> </annotation> </enumeration> </restriction> </simpleType> </pre>
--	--

simpleType enum 0080

namespace	http://xml.ir-d.de/sak		
type	restriction of string		
properties	base xs:string		
facets	Kind	Value	Annotation
	enumeration	0080001	documentation Endoprothese Hüfte/Knie
	enumeration	0080002	documentation Brustimplantat
	enumeration	0080003	documentation Aortenklappenprothese
annotation	documentation Kat_Implantattyp		
source	<pre> <simpleType name="enum_0080"> <annotation> <documentation>Kat_Implantattyp</documentation> </annotation> <restriction base="xs:string"> <enumeration value="0080001"> <annotation> <documentation>Endoprothese Hüfte/Knie</documentation> </annotation> </enumeration> <enumeration value="0080002"> <annotation> <documentation>Brustimplantat</documentation> </annotation> </enumeration> <enumeration value="0080003"> <annotation> <documentation>Aortenklappenprothese</documentation> </annotation> </enumeration> </restriction> </simpleType> </pre>		

simpleType enum_0100

namespace	http://xml.ir-d.de/sak		
type	restriction of string		
properties	base xs:string		
facets	Kind	Value	Annotation
	enumeration	0100002	documentation Austausch Expander gegen dauerhaftes Brustimplantat
	enumeration	0100003	documentation Wechsel
	enumeration	0100004	documentation Nur Explantation
	enumeration	0100005	documentation Ersteingriff
	enumeration	0100006	documentation Zweizeitige Implantation
annotation	documentation Kat_BI_ArtEingriff		
source	<pre> <simpleType name="enum_0100"> <annotation> <documentation>Kat_BI_ArtEingriff</documentation> </annotation> <restriction base="xs:string"> <enumeration value="0100002"> <annotation> <documentation>Austausch Expander gegen dauerhaftes Brustimplantat</documentation> </annotation> </enumeration> <enumeration value="0100003"> <annotation> <documentation>Wechsel</documentation> </annotation> </enumeration> <enumeration value="0100004"> <annotation> <documentation>Nur Explantation</documentation> </annotation> </enumeration> <enumeration value="0100005"> <annotation> <documentation>Ersteingriff</documentation> </annotation> </enumeration> <enumeration value="0100006"> <annotation> <documentation>Zweizeitige Implantation</documentation> </annotation> </enumeration> </restriction> </simpleType> </pre>		

simpleType enum_0102

namespace	http://xml.ir-d.de/sak
type	restriction of string

properties	base xs:string															
facets	<table border="1"> <thead> <tr> <th>Kind</th> <th>Value</th> <th>Annotation</th> </tr> </thead> <tbody> <tr> <td>enumeration</td> <td>0102001</td> <td>documentation kosmetische Augmentation</td> </tr> <tr> <td>enumeration</td> <td>0102002</td> <td>documentation Rekonstruktion, benigne</td> </tr> <tr> <td>enumeration</td> <td>0102003</td> <td>documentation Rekonstruktion nach Mastektomie aufgrund eines Karzinoms</td> </tr> <tr> <td>enumeration</td> <td>0102004</td> <td>documentation Rekonstruktion nach risikoreduzierender Mastektomie</td> </tr> </tbody> </table>	Kind	Value	Annotation	enumeration	0102001	documentation kosmetische Augmentation	enumeration	0102002	documentation Rekonstruktion, benigne	enumeration	0102003	documentation Rekonstruktion nach Mastektomie aufgrund eines Karzinoms	enumeration	0102004	documentation Rekonstruktion nach risikoreduzierender Mastektomie
Kind	Value	Annotation														
enumeration	0102001	documentation kosmetische Augmentation														
enumeration	0102002	documentation Rekonstruktion, benigne														
enumeration	0102003	documentation Rekonstruktion nach Mastektomie aufgrund eines Karzinoms														
enumeration	0102004	documentation Rekonstruktion nach risikoreduzierender Mastektomie														
annotation	documentation Kat_BI_GrundPrimaereingriff															
source	<pre> <simpleType name="enum_0102"> <annotation> <documentation>Kat_BI_GrundPrimaereingriff</documentation> </annotation> <restriction base="xs:string"> <enumeration value="0102001"> <annotation> <documentation>kosmetische Augmentation</documentation> </annotation> </enumeration> <enumeration value="0102002"> <annotation> <documentation>Rekonstruktion, benigne</documentation> </annotation> </enumeration> <enumeration value="0102003"> <annotation> <documentation>Rekonstruktion nach Mastektomie aufgrund eines Karzinoms</documentation> </annotation> </enumeration> <enumeration value="0102004"> <annotation> <documentation>Rekonstruktion nach risikoreduzierender Mastektomie</documentation> </annotation> </enumeration> </restriction> </simpleType> </pre>															

simpleType enum_0103

namespace	http://xml.ir-d.de/sak																		
type	restriction of string																		
properties	base xs:string																		
facets	<table border="1"> <thead> <tr> <th>Kind</th> <th>Value</th> <th>Annotation</th> </tr> </thead> <tbody> <tr> <td>enumeration</td> <td>0103001</td> <td>documentation simultane Lappendeckung</td> </tr> <tr> <td>enumeration</td> <td>0103002</td> <td>documentation simultane Eigenfettransplantation</td> </tr> <tr> <td>enumeration</td> <td>0103003</td> <td>documentation simultane Mastopexie</td> </tr> <tr> <td>enumeration</td> <td>0103005</td> <td>documentation simultane Mastektomie, Ablatio / hautsparend</td> </tr> <tr> <td>enumeration</td> <td>0103006</td> <td>documentation</td> </tr> </tbody> </table>	Kind	Value	Annotation	enumeration	0103001	documentation simultane Lappendeckung	enumeration	0103002	documentation simultane Eigenfettransplantation	enumeration	0103003	documentation simultane Mastopexie	enumeration	0103005	documentation simultane Mastektomie, Ablatio / hautsparend	enumeration	0103006	documentation
Kind	Value	Annotation																	
enumeration	0103001	documentation simultane Lappendeckung																	
enumeration	0103002	documentation simultane Eigenfettransplantation																	
enumeration	0103003	documentation simultane Mastopexie																	
enumeration	0103005	documentation simultane Mastektomie, Ablatio / hautsparend																	
enumeration	0103006	documentation																	

	<p>enumeration 0103007 simultane Mastektomie, nippelerhaltend documentation Axilla-Dissektion</p> <p>enumeration 0103008 documentation Drainage</p>
annotation	documentation Kat_BI_OperationsdetailPrimaereingriff
source	<pre> <simpleType name="enum_0103"> <annotation> <documentation>Kat_BI_OperationsdetailPrimaereingriff</documentation> </annotation> <restriction base="xs:string"> <enumeration value="0103001"> <annotation> <documentation>simultane Lappendeckung</documentation> </annotation> </enumeration> <enumeration value="0103002"> <annotation> <documentation>simultane Eigenfetttransplantation</documentation> </annotation> </enumeration> <enumeration value="0103003"> <annotation> <documentation>simultane Mastopexie</documentation> </annotation> </enumeration> <enumeration value="0103005"> <annotation> <documentation>simultane Mastektomie, Ablatio / hautsparend</documentation> </annotation> </enumeration> <enumeration value="0103006"> <annotation> <documentation>simultane Mastektomie, nippelerhaltend</documentation> </annotation> </enumeration> <enumeration value="0103007"> <annotation> <documentation>Axilla-Dissektion</documentation> </annotation> </enumeration> <enumeration value="0103008"> <annotation> <documentation>Drainage</documentation> </annotation> </enumeration> </restriction> </simpleType> </pre>

simpleType enum_0104

namespace	http://xml.ir-d.de/sak
type	restriction of string
properties	base xs:string

facets	Kind enumeration	Value 0104001	Annotation documentation Austausch Expander gegen dauerhaftes Brustimplantat
annotation	documentation Kat_BI_GrundAustausch		
source	<pre> <simpleType name="enum_0104"> <annotation> <documentation>Kat_BI_GrundAustausch</documentation> </annotation> <restriction base="xs:string"> <enumeration value="0104001"> <annotation> <documentation>Austausch Expander gegen dauerhaftes Brustimplantat</documentation> </annotation> </enumeration> </restriction> </simpleType> </pre>		

simpleType enum_0105

namespace	http://xml.ir-d.de/sak		
type	restriction of string		
properties	base xs:string		
facets	Kind	Value	Annotation
	enumeration	0105001	documentation simultane Lappendeckung
	enumeration	0105002	documentation simultane Eigenfetttransplantation
	enumeration	0105003	documentation simultane Mastopexie
	enumeration	0105008	documentation Drainage
	enumeration	0105009	documentation Kapsulektomie, komplett
	enumeration	0105010	documentation Kapsulektomie, partiell
	enumeration	0105011	documentation Neopocket
annotation	documentation Kat_BI_OperationsdetailAustausch		
source	<pre> <simpleType name="enum_0105"> <annotation> <documentation>Kat_BI_OperationsdetailAustausch</documentation> </annotation> <restriction base="xs:string"> <enumeration value="0105001"> <annotation> <documentation>simultane Lappendeckung</documentation> </annotation> </enumeration> <enumeration value="0105002"> <annotation> <documentation>simultane Eigenfetttransplantation</documentation> </annotation> </enumeration> <enumeration value="0105003"> <annotation> </pre>		

	<pre> <documentation>simultane Mastopexie</documentation> </annotation> </enumeration> <enumeration value="0105008"> <annotation> <documentation>Drainage</documentation> </annotation> </enumeration> <enumeration value="0105009"> <annotation> <documentation>Kapsulektomie, komplett</documentation> </annotation> </enumeration> <enumeration value="0105010"> <annotation> <documentation>Kapsulektomie, partiell</documentation> </annotation> </enumeration> <enumeration value="0105011"> <annotation> <documentation>Neopocket</documentation> </annotation> </enumeration> </restriction> </simpleType> </pre>
--	---

simpleType enum_0106

namespace	http://xml.ir-d.de/sak		
type	restriction of string		
properties	base xs:string		
facets	Kind	Value	Annotation
	enumeration	0106001	documentation Patientenwunsch
	enumeration	0106002	documentation asymptomatisch
	enumeration	0106003	documentation Komplikation
annotation	documentation Kat_BI_GrundRevisionExplantation		
source	<pre> <simpleType name="enum_0106"> <annotation> <documentation>Kat_BI_GrundRevisionExplantation</documentation> </annotation> <restriction base="xs:string"> <enumeration value="0106001"> <annotation> <documentation>Patientenwunsch</documentation> </annotation> </enumeration> <enumeration value="0106002"> <annotation> <documentation>asymptomatisch</documentation> </annotation> </enumeration> <enumeration value="0106003"> <annotation> </pre>		

```

    <documentation>Komplikation</documentation>
  </annotation>
</enumeration>
</restriction>
</simpleType>

```

simpleType enum_0107

namespace	http://xml.ir-d.de/sak		
type	restriction of string		
properties	base xs:string		
facets	Kind	Value	Annotation
	enumeration	0107001	documentation simultane Lappendeckung
	enumeration	0107002	documentation simultane Eigenfetttransplantation
	enumeration	0107003	documentation simultane Mastopexie
	enumeration	0107005	documentation simultane Mastektomie, Ablatio / hautsparend
	enumeration	0107006	documentation simultane Mastektomie, nippelerhaltend
	enumeration	0107007	documentation Axilla-Dissektion
	enumeration	0107008	documentation Drainage
	enumeration	0107009	documentation Kapsulektomie, komplett
	enumeration	0107010	documentation Kapsulektomie, partiell
	enumeration	0107011	documentation Neopocket
annotation	documentation Kat_BI_OperationsdetailRevision		
source	<pre> <simpleType name="enum_0107"> <annotation> <documentation>Kat_BI_OperationsdetailRevision</documentation> </annotation> <restriction base="xs:string"> <enumeration value="0107001"> <annotation> <documentation>simultane Lappendeckung</documentation> </annotation> </enumeration> <enumeration value="0107002"> <annotation> <documentation>simultane Eigenfetttransplantation</documentation> </annotation> </enumeration> <enumeration value="0107003"> <annotation> <documentation>simultane Mastopexie</documentation> </annotation> </enumeration> <enumeration value="0107005"> <annotation> <documentation>simultane Mastektomie, Ablatio / hautsparend</documentation> </pre>		

```

    </annotation>
  </enumeration>
  <enumeration value="0107006">
    <annotation>
      <documentation>simultane Mastektomie, nippelerhaltend</documentation>
    </annotation>
  </enumeration>
  <enumeration value="0107007">
    <annotation>
      <documentation>Axilla-Dissektion</documentation>
    </annotation>
  </enumeration>
  <enumeration value="0107008">
    <annotation>
      <documentation>Drainage</documentation>
    </annotation>
  </enumeration>
  <enumeration value="0107009">
    <annotation>
      <documentation>Kapsulektomie, komplett</documentation>
    </annotation>
  </enumeration>
  <enumeration value="0107010">
    <annotation>
      <documentation>Kapsulektomie, partiell</documentation>
    </annotation>
  </enumeration>
  <enumeration value="0107011">
    <annotation>
      <documentation>Neopocket</documentation>
    </annotation>
  </enumeration>
</restriction>
</simpleType>

```

simpleType enum_0110

namespace	http://xml.lir-d.de/sak		
type	restriction of string		
properties	base xs:string		
facets	Kind	Value	Annotation
	enumeration	0110001	documentation Bestrahlung
annotation	documentation Kat_BI_VorbehandlungLokal		
source	<pre> <simpleType name="enum_0110"> <annotation> <documentation>Kat_BI_VorbehandlungLokal</documentation> </annotation> <restriction base="xs:string"> <enumeration value="0110001"> <annotation> <documentation>Bestrahlung</documentation> </annotation> </enumeration> </restriction> </pre>		

	<code></simpleType></code>
--	----------------------------------

simpleType enum_0111

namespace	http://xml.ir-d.de/sak		
type	restriction of string		
properties	base xs:string		
facets	Kind	Value	Annotation
	enumeration	0111001	documentation nein
	enumeration	0111002	documentation Lipofilling
	enumeration	0111003	documentation Eigengewebstrekonstruktion
annotation	documentation Kat_BI_Verfahrenswechsel		
source	<pre> <simpleType name="enum_0111"> <annotation> <documentation>Kat_BI_Verfahrenswechsel</documentation> </annotation> <restriction base="xs:string"> <enumeration value="0111001"> <annotation> <documentation>nein</documentation> </annotation> </enumeration> <enumeration value="0111002"> <annotation> <documentation>Lipofilling</documentation> </annotation> </enumeration> <enumeration value="0111003"> <annotation> <documentation>Eigengewebstrekonstruktion</documentation> </annotation> </enumeration> </restriction> </simpleType> </pre>		

simpleType enum_0112

namespace	http://xml.ir-d.de/sak		
type	restriction of string		
properties	base xs:string		
facets	Kind	Value	Annotation
	enumeration	0112001	documentation subglandulär / epipektoral
	enumeration	0112002	documentation subpektoral
	enumeration	0112003	documentation subfaszial
	enumeration	0112004	documentation sub-flap
	enumeration	0112005	documentation subkutan

	enumeration 0112006 documentation dual plane enumeration 0112042 documentation andere
annotation	documentation Kat_BI_LageImplantat
source	<pre> <simpleType name="enum_0112"> <annotation> <documentation>Kat_BI_LageImplantat</documentation> </annotation> <restriction base="xs:string"> <enumeration value="0112001"> <annotation> <documentation>subglandulär / epipektoral</documentation> </annotation> </enumeration> <enumeration value="0112002"> <annotation> <documentation>subpektoral</documentation> </annotation> </enumeration> <enumeration value="0112003"> <annotation> <documentation>subfaszial</documentation> </annotation> </enumeration> <enumeration value="0112004"> <annotation> <documentation>sub-flap</documentation> </annotation> </enumeration> <enumeration value="0112005"> <annotation> <documentation>subkutan</documentation> </annotation> </enumeration> <enumeration value="0112006"> <annotation> <documentation>dual plane</documentation> </annotation> </enumeration> <enumeration value="0112042"> <annotation> <documentation>andere</documentation> </annotation> </enumeration> </restriction> </simpleType> </pre>

simpleType enum_0113

namespace	http://xml.ir-d.de/sak		
type	restriction of string		
properties	base xs:string		
facets	Kind enumeration	Value 0113001	Annotation documentation Chemotherapie innerhalb der letzten drei Monate

annotation	documentation Kat_BI_VorbehandlungSystemisch
source	<pre> <simpleType name="enum_0113"> <annotation> <documentation>Kat_BI_VorbehandlungSystemisch</documentation> </annotation> <restriction base="xs:string"> <enumeration value="0113001"> <annotation> <documentation>Chemotherapie innerhalb der letzten drei Monate</documentation> </annotation> </enumeration> </restriction> </simpleType> </pre>

simpleType enum_0114

namespace	http://xml.ir-d.de/sak		
type	restriction of string		
properties	base xs:string		
facets	Kind	Value	Annotation
	enumeration	0114001	documentation vollständig
	enumeration	0114002	documentation nein
	enumeration	0114003	documentation teilweise
	enumeration	0114004	documentation nicht vorhanden
annotation	documentation Kat_BI_EntfernungADMNetz		
source	<pre> <simpleType name="enum_0114"> <annotation> <documentation>Kat_BI_EntfernungADMNetz</documentation> </annotation> <restriction base="xs:string"> <enumeration value="0114001"> <annotation> <documentation>vollständig</documentation> </annotation> </enumeration> <enumeration value="0114002"> <annotation> <documentation>nein</documentation> </annotation> </enumeration> <enumeration value="0114003"> <annotation> <documentation>teilweise</documentation> </annotation> </enumeration> <enumeration value="0114004"> <annotation> <documentation>nicht vorhanden</documentation> </annotation> </enumeration> </restriction> </simpleType> </pre>		

```

</restriction>
</simpleType>

```

simpleType enum_0116

namespace	http://xml.ir-d.de/sak		
type	restriction of string		
properties	base xs:string		
facets	Kind	Value	Annotation
	enumeration	0116001	documentation Spülung, antibiotisch
	enumeration	0116002	documentation Spülung, antiseptisch
	enumeration	0116003	documentation Spülung, wirkstofffrei
	enumeration	0116004	documentation Spülung, andere
	enumeration	0116005	documentation prä-/perioperative Antibiotika
	enumeration	0116006	documentation postoperative Antibiotika
	enumeration	0116007	documentation Handschuhwechsel vor Implantation
	enumeration	0116008	documentation Implantationshilfe
annotation	documentation Kat_BI_Operationsmassnahme		
source	<pre> <simpleType name="enum_0116"> <annotation> <documentation>Kat_BI_Operationsmassnahme</documentation> </annotation> <restriction base="xs:string"> <enumeration value="0116001"> <annotation> <documentation>Spülung, antibiotisch</documentation> </annotation> </enumeration> <enumeration value="0116002"> <annotation> <documentation>Spülung, antiseptisch</documentation> </annotation> </enumeration> <enumeration value="0116003"> <annotation> <documentation>Spülung, wirkstofffrei</documentation> </annotation> </enumeration> <enumeration value="0116004"> <annotation> <documentation>Spülung, andere</documentation> </annotation> </enumeration> <enumeration value="0116005"> <annotation> <documentation>prä-/perioperative Antibiotika</documentation> </annotation> </enumeration> <enumeration value="0116006"> </pre>		

	<pre> <annotation> <documentation>postoperative Antibiotika</documentation> </annotation> </enumeration> <enumeration value="0116007"> <annotation> <documentation>Handschuhwechsel vor Implantation</documentation> </annotation> </enumeration> <enumeration value="0116008"> <annotation> <documentation>Implantationshilfe</documentation> </annotation> </enumeration> </restriction> </simpleType> </pre>
--	---

simpleType enum_0118

namespace	http://xml.ir-d.de/sak		
type	restriction of string		
properties	base xs:string		
facets	Kind	Value	Annotation
	enumeration	0118001	documentation axillär
	enumeration	0118002	documentation periareolär
	enumeration	0118003	documentation inframammär
	enumeration	0118004	documentation Mastektomienarbe
	enumeration	0118042	documentation anderer
annotation	documentation Kat_BI_Operationszugang		
source	<pre> <simpleType name="enum_0118"> <annotation> <documentation>Kat_BI_Operationszugang</documentation> </annotation> <restriction base="xs:string"> <enumeration value="0118001"> <annotation> <documentation>axillär</documentation> </annotation> </enumeration> <enumeration value="0118002"> <annotation> <documentation>periareolär</documentation> </annotation> </enumeration> <enumeration value="0118003"> <annotation> <documentation>inframammär</documentation> </annotation> </enumeration> <enumeration value="0118004"> <annotation> </pre>		

	<pre> <documentation>Mastektomienarbe</documentation> </annotation> </enumeration> <enumeration value="0118042"> <annotation> <documentation>anderer</documentation> </annotation> </enumeration> </restriction> </simpleType> </pre>
--	---

simpleType enum_0120

namespace	http://xml.ir-d.de/sak		
type	restriction of string		
properties	base xs:string		
facets	Kind	Value	Annotation
	enumeration	0120001	documentation Expander defekt
annotation	documentation Kat_BI_BefundAustausch		
source	<pre> <simpleType name="enum_0120"> <annotation> <documentation>Kat_BI_BefundAustausch</documentation> </annotation> <restriction base="xs:string"> <enumeration value="0120001"> <annotation> <documentation>Expander defekt</documentation> </annotation> </enumeration> </restriction> </simpleType> </pre>		

simpleType enum_0121

namespace	http://xml.ir-d.de/sak		
type	restriction of string		
properties	base xs:string		
facets	Kind	Value	Annotation
	enumeration	0121001	documentation Infektion
	enumeration	0121002	documentation Serom
	enumeration	0121004	documentation Kapsel fibrose
	enumeration	0121005	documentation Implantatruptur
	enumeration	0121006	documentation Fehlpositionierung/Rotation
	enumeration	0121007	documentation BIA-ALCL/-BCL/-SCC, Verdacht
	enumeration	0121008	documentation BIA-ALCL/-BCL/-SCC, pathologisch bestätigt
	enumeration	0121009	documentation

	<p>enumeration 0121010 Brustschmerzen documentation Doppelkapsel</p> <p>enumeration 0121011 documentation Netz-/ADM-bedingte Komplikation, Non-Integration</p> <p>enumeration 0121012 documentation Netz-/ADM-bedingte Komplikation, andere</p> <p>enumeration 0121013 documentation Hautnekrose/exponiertes Implantat</p> <p>enumeration 0121014 documentation BII/ASIA (Brustimplantat assoziierte Symptome), Verdacht</p> <p>enumeration 0121015 documentation Lymphadenopathie</p> <p>enumeration 0121016 documentation Brustkrebs, neu aufgetreten/Rezidiv</p> <p>enumeration 0121042 documentation sonstiger</p>
annotation	documentation Kat BI BefundKomplett
source	<pre> <simpleType name="enum_0121"> <annotation> <documentation>Kat_BI_BefundKomplett</documentation> </annotation> <restriction base="xs:string"> <enumeration value="0121001"> <annotation> <documentation>Infektion</documentation> </annotation> </enumeration> <enumeration value="0121002"> <annotation> <documentation>Serom</documentation> </annotation> </enumeration> <enumeration value="0121004"> <annotation> <documentation>Kapsel fibrose</documentation> </annotation> </enumeration> <enumeration value="0121005"> <annotation> <documentation>Implantatruptur</documentation> </annotation> </enumeration> <enumeration value="0121006"> <annotation> <documentation>Fehlpositionierung/Rotation</documentation> </annotation> </enumeration> <enumeration value="0121007"> <annotation> <documentation>BIA-ALCL/-BCL/-SCC, Verdacht</documentation> </annotation> </enumeration> <enumeration value="0121008"> <annotation> <documentation>BIA-ALCL/-BCL/-SCC, pathologisch bestätigt</documentation> </annotation> </enumeration> </restriction> </simpleType> </pre>

```

<enumeration value="0121009">
  <annotation>
    <documentation>Brustschmerzen</documentation>
  </annotation>
</enumeration>
<enumeration value="0121010">
  <annotation>
    <documentation>Doppelkapsel</documentation>
  </annotation>
</enumeration>
<enumeration value="0121011">
  <annotation>
    <documentation>Netz-/ADM-bedingte Komplikation, Non-
Integration</documentation>
  </annotation>
</enumeration>
<enumeration value="0121012">
  <annotation>
    <documentation>Netz-/ADM-bedingte Komplikation,
andere</documentation>
  </annotation>
</enumeration>
<enumeration value="0121013">
  <annotation>
    <documentation>Hautnekrose/exponiertes Implantat</documentation>
  </annotation>
</enumeration>
<enumeration value="0121014">
  <annotation>
    <documentation>BII/ASIA (Brustimplantat assoziierte Symptome),
Verdacht</documentation>
  </annotation>
</enumeration>
<enumeration value="0121015">
  <annotation>
    <documentation>Lymphadenopathie</documentation>
  </annotation>
</enumeration>
<enumeration value="0121016">
  <annotation>
    <documentation>Brustkrebs, neu aufgetreten/Rezidiv</documentation>
  </annotation>
</enumeration>
<enumeration value="0121042">
  <annotation>
    <documentation>sonstiger</documentation>
  </annotation>
</enumeration>
</restriction>
</simpleType>

```

simpleType enum_0122

namespace	http://xml.ir-d.de/sak
type	restriction of string
properties	base xs:string

facets	<table border="1"> <thead> <tr> <th>Kind</th> <th>Value</th> <th>Annotation</th> </tr> </thead> <tbody> <tr> <td>enumeration</td> <td>0122001</td> <td>documentation ja, ärztlich nachgewiesen</td> </tr> <tr> <td>enumeration</td> <td>0122002</td> <td>documentation nein</td> </tr> <tr> <td>enumeration</td> <td>0122042</td> <td>documentation unbekannt</td> </tr> </tbody> </table>	Kind	Value	Annotation	enumeration	0122001	documentation ja, ärztlich nachgewiesen	enumeration	0122002	documentation nein	enumeration	0122042	documentation unbekannt
Kind	Value	Annotation											
enumeration	0122001	documentation ja, ärztlich nachgewiesen											
enumeration	0122002	documentation nein											
enumeration	0122042	documentation unbekannt											
annotation	documentation Kat_BI_Autoimmunerkrankung												
source	<pre> <simpleType name="enum_0122"> <annotation> <documentation>Kat_BI_Autoimmunerkrankung</documentation> </annotation> <restriction base="xs:string"> <enumeration value="0122001"> <annotation> <documentation>ja, ärztlich nachgewiesen</documentation> </annotation> </enumeration> <enumeration value="0122002"> <annotation> <documentation>nein</documentation> </annotation> </enumeration> <enumeration value="0122042"> <annotation> <documentation>unbekannt</documentation> </annotation> </enumeration> </restriction> </simpleType> </pre>												

simpleType enum_0123

namespace	http://xml.ir-d.de/sak																		
type	restriction of string																		
properties	base xs:string																		
facets	<table border="1"> <thead> <tr> <th>Kind</th> <th>Value</th> <th>Annotation</th> </tr> </thead> <tbody> <tr> <td>enumeration</td> <td>0123001</td> <td>documentation neu aufgetreten</td> </tr> <tr> <td>enumeration</td> <td>0123002</td> <td>documentation verschlechtert</td> </tr> <tr> <td>enumeration</td> <td>0123003</td> <td>documentation keine Veränderung</td> </tr> <tr> <td>enumeration</td> <td>0123004</td> <td>documentation nicht relevant, da Primäreingriff</td> </tr> <tr> <td>enumeration</td> <td>0123042</td> <td>documentation unbekannt</td> </tr> </tbody> </table>	Kind	Value	Annotation	enumeration	0123001	documentation neu aufgetreten	enumeration	0123002	documentation verschlechtert	enumeration	0123003	documentation keine Veränderung	enumeration	0123004	documentation nicht relevant, da Primäreingriff	enumeration	0123042	documentation unbekannt
Kind	Value	Annotation																	
enumeration	0123001	documentation neu aufgetreten																	
enumeration	0123002	documentation verschlechtert																	
enumeration	0123003	documentation keine Veränderung																	
enumeration	0123004	documentation nicht relevant, da Primäreingriff																	
enumeration	0123042	documentation unbekannt																	
annotation	documentation Kat_BI_VerlaufAutoimmunerkrankung																		
source	<pre> <simpleType name="enum_0123"> <annotation> <documentation>Kat_BI_VerlaufAutoimmunerkrankung</documentation> </annotation> <restriction base="xs:string"> <enumeration value="0123001"> <annotation> <documentation>neu aufgetreten</documentation> </annotation> </enumeration> </restriction> </simpleType> </pre>																		

	<pre> </annotation> </enumeration> <enumeration value="0123002"> <annotation> <documentation>verschlechtert</documentation> </annotation> </enumeration> <enumeration value="0123003"> <annotation> <documentation>keine Veränderung</documentation> </annotation> </enumeration> <enumeration value="0123004"> <annotation> <documentation>nicht relevant, da Primäreingriff</documentation> </annotation> </enumeration> <enumeration value="0123042"> <annotation> <documentation>unbekannt</documentation> </annotation> </enumeration> </restriction> </simpleType> </pre>
--	---

simpleType enum_0124

namespace	http://xml.ir-d.de/sak		
type	restriction of string		
properties	base xs:string		
facets	Kind	Value	Annotation
	enumeration	0124001	documentation Salzlösung
	enumeration	0124002	documentation Silikongel
	enumeration	0124003	documentation Kombination Silikongel und Salzlösung
	enumeration	0124042	documentation sonstige
annotation	documentation Kat_BI_Fuellung		
source	<pre> <simpleType name="enum_0124"> <annotation> <documentation>Kat_BI_Fuellung</documentation> </annotation> <restriction base="xs:string"> <enumeration value="0124001"> <annotation> <documentation>Salzlösung</documentation> </annotation> </enumeration> <enumeration value="0124002"> <annotation> <documentation>Silikongel</documentation> </annotation> </enumeration> <enumeration value="0124003"> </pre>		

	<pre> <annotation> <documentation>Kombination Silikongel und Salzlösung</documentation> </annotation> </enumeration> <enumeration value="0124042"> <annotation> <documentation>sonstige</documentation> </annotation> </enumeration> </restriction> </simpleType> </pre>
--	--

simpleType enum_0126

namespace	http://xml.ir-d.de/sak		
type	restriction of string		
properties	base xs:string		
facets	Kind	Value	Annotation
	enumeration	0126001	documentation anatomisch (tropfenförmig)
	enumeration	0126002	documentation rund (punktsymmetrisch)
	enumeration	0126042	documentation sonstige
annotation	documentation Kat_BI_Form		
source	<pre> <simpleType name="enum_0126"> <annotation> <documentation>Kat_BI_Form</documentation> </annotation> <restriction base="xs:string"> <enumeration value="0126001"> <annotation> <documentation>anatomisch (tropfenförmig)</documentation> </annotation> </enumeration> <enumeration value="0126002"> <annotation> <documentation>rund (punktsymmetrisch)</documentation> </annotation> </enumeration> <enumeration value="0126042"> <annotation> <documentation>sonstige</documentation> </annotation> </enumeration> </restriction> </simpleType> </pre>		

simpleType enum_0128

namespace	http://xml.ir-d.de/sak		
type	restriction of string		
properties	base xs:string		

facets	<table border="1"> <thead> <tr> <th>Kind</th> <th>Value</th> <th>Annotation</th> </tr> </thead> <tbody> <tr> <td>enumeration</td> <td>0128001</td> <td>documentation glattwandig</td> </tr> <tr> <td>enumeration</td> <td>0128002</td> <td>documentation beschichtet</td> </tr> <tr> <td>enumeration</td> <td>0128003</td> <td>documentation texturiert</td> </tr> </tbody> </table>	Kind	Value	Annotation	enumeration	0128001	documentation glattwandig	enumeration	0128002	documentation beschichtet	enumeration	0128003	documentation texturiert
Kind	Value	Annotation											
enumeration	0128001	documentation glattwandig											
enumeration	0128002	documentation beschichtet											
enumeration	0128003	documentation texturiert											
annotation	documentation Kat_BI_Oberflaeche												
source	<pre><simpleType name="enum_0128"> <annotation> <documentation>Kat_BI_Oberflaeche</documentation> </annotation> <restriction base="xs:string"> <enumeration value="0128001"> <annotation> <documentation>glattwandig</documentation> </annotation> </enumeration> <enumeration value="0128002"> <annotation> <documentation>beschichtet</documentation> </annotation> </enumeration> <enumeration value="0128003"> <annotation> <documentation>texturiert</documentation> </annotation> </enumeration> </restriction> </simpleType></pre>												

simpleType enum_0131

namespace	http://xml.ir-d.de/sak																																				
type	restriction of string																																				
properties	base xs:string																																				
facets	<table border="1"> <thead> <tr> <th>Kind</th> <th>Value</th> <th>Annotation</th> </tr> </thead> <tbody> <tr> <td>enumeration</td> <td>0131001</td> <td>documentation Allergan</td> </tr> <tr> <td>enumeration</td> <td>0131002</td> <td>documentation Establishment Labs</td> </tr> <tr> <td>enumeration</td> <td>0131003</td> <td>documentation Eurosilicone</td> </tr> <tr> <td>enumeration</td> <td>0131004</td> <td>documentation Galatea</td> </tr> <tr> <td>enumeration</td> <td>0131005</td> <td>documentation Integra</td> </tr> <tr> <td>enumeration</td> <td>0131006</td> <td>documentation Lifecell</td> </tr> <tr> <td>enumeration</td> <td>0131007</td> <td>documentation MBP (Medical Biomaterial Products)</td> </tr> <tr> <td>enumeration</td> <td>0131008</td> <td>documentation Mentor</td> </tr> <tr> <td>enumeration</td> <td>0131009</td> <td>documentation Novus Scientific</td> </tr> <tr> <td>enumeration</td> <td>0131010</td> <td>documentation pfmMedical</td> </tr> <tr> <td>enumeration</td> <td>0131011</td> <td>documentation</td> </tr> </tbody> </table>	Kind	Value	Annotation	enumeration	0131001	documentation Allergan	enumeration	0131002	documentation Establishment Labs	enumeration	0131003	documentation Eurosilicone	enumeration	0131004	documentation Galatea	enumeration	0131005	documentation Integra	enumeration	0131006	documentation Lifecell	enumeration	0131007	documentation MBP (Medical Biomaterial Products)	enumeration	0131008	documentation Mentor	enumeration	0131009	documentation Novus Scientific	enumeration	0131010	documentation pfmMedical	enumeration	0131011	documentation
Kind	Value	Annotation																																			
enumeration	0131001	documentation Allergan																																			
enumeration	0131002	documentation Establishment Labs																																			
enumeration	0131003	documentation Eurosilicone																																			
enumeration	0131004	documentation Galatea																																			
enumeration	0131005	documentation Integra																																			
enumeration	0131006	documentation Lifecell																																			
enumeration	0131007	documentation MBP (Medical Biomaterial Products)																																			
enumeration	0131008	documentation Mentor																																			
enumeration	0131009	documentation Novus Scientific																																			
enumeration	0131010	documentation pfmMedical																																			
enumeration	0131011	documentation																																			

	<p>enumeration 0131012 Serag Wiessner documentation nicht belegter Wert</p> <p>enumeration 0131013 documentation nicht belegter Wert</p> <p>enumeration 0131014 documentation nicht belegter Wert</p> <p>enumeration 0131015 documentation nicht belegter Wert</p> <p>enumeration 0131042 documentation sonstiger</p>
annotation	documentation Kat BI_ZubehoerHersteller
source	<pre> <simpleType name="enum_0131"> <annotation> <documentation>Kat_BI_ZubehoerHersteller</documentation> </annotation> <restriction base="xs:string"> <enumeration value="0131001"> <annotation> <documentation>Allergan</documentation> </annotation> </enumeration> <enumeration value="0131002"> <annotation> <documentation>Establishment Labs</documentation> </annotation> </enumeration> <enumeration value="0131003"> <annotation> <documentation>Eurosilicone</documentation> </annotation> </enumeration> <enumeration value="0131004"> <annotation> <documentation>Galatea</documentation> </annotation> </enumeration> <enumeration value="0131005"> <annotation> <documentation>Integra</documentation> </annotation> </enumeration> <enumeration value="0131006"> <annotation> <documentation>Lifecell</documentation> </annotation> </enumeration> <enumeration value="0131007"> <annotation> <documentation>MBP (Medical Biomaterial Products)</documentation> </annotation> </enumeration> <enumeration value="0131008"> <annotation> <documentation>Mentor</documentation> </annotation> </enumeration> <enumeration value="0131009"> <annotation> </pre>

```

        <documentation>Novus Scientific</documentation>
    </annotation>
</enumeration>
<enumeration value="0131010">
    <annotation>
        <documentation>pfmMedical</documentation>
    </annotation>
</enumeration>
<enumeration value="0131011">
    <annotation>
        <documentation>Serag Wiessner</documentation>
    </annotation>
</enumeration>
<enumeration value="0131012">
    <annotation>
        <documentation>nicht belegter Wert</documentation>
    </annotation>
</enumeration>
<enumeration value="0131013">
    <annotation>
        <documentation>nicht belegter Wert</documentation>
    </annotation>
</enumeration>
<enumeration value="0131014">
    <annotation>
        <documentation>nicht belegter Wert</documentation>
    </annotation>
</enumeration>
<enumeration value="0131015">
    <annotation>
        <documentation>nicht belegter Wert</documentation>
    </annotation>
</enumeration>
<enumeration value="0131042">
    <annotation>
        <documentation>sonstiger</documentation>
    </annotation>
</enumeration>
</restriction>
</simpleType>

```

simpleType **enum_0170**

namespace	http://xml.ir-d.de/sak		
type	restriction of string		
properties	base xs:string		
facets	Kind	Value	Annotation
	enumeration	0170001	documentation weiblich
	enumeration	0170002	documentation männlich
	enumeration	0170003	documentation intersexuell
annotation	documentation Kat_Bl_GeschlechtGeburt		
source	<simpleType name="enum_0170"> <annotation>		

	<pre> <documentation>Kat_BI_GeschlechtGeburt</documentation> </annotation> <restriction base="xs:string"> <enumeration value="0170001"> <annotation> <documentation>weiblich</documentation> </annotation> </enumeration> <enumeration value="0170002"> <annotation> <documentation>männlich</documentation> </annotation> </enumeration> <enumeration value="0170003"> <annotation> <documentation>intersexuell</documentation> </annotation> </enumeration> </restriction> </simpleType> </pre>
--	---

simpleType enum_0190

namespace	http://xml.ir-d.de/sak		
type	restriction of string		
properties	base xs:string		
facets	Kind	Value	Annotation
	enumeration	0190001	documentation Brustimplantat
	enumeration	0190003	documentation Brustexpander
annotation	documentation Kat_BI_Artikeltyp		
source	<pre> <simpleType name="enum_0190"> <annotation> <documentation>Kat_BI_Artikeltyp</documentation> </annotation> <restriction base="xs:string"> <enumeration value="0190001"> <annotation> <documentation>Brustimplantat</documentation> </annotation> </enumeration> <enumeration value="0190003"> <annotation> <documentation>Brustexpander</documentation> </annotation> </enumeration> </restriction> </simpleType> </pre>		

simpleType enum_0191

namespace	http://xml.ir-d.de/sak
-----------	------------------------

type	restriction of string									
properties	base xs:string									
facets	<table border="1"> <thead> <tr> <th>Kind</th> <th>Value</th> <th>Annotation</th> </tr> </thead> <tbody> <tr> <td>enumeration</td> <td>0191001</td> <td>documentation Netz</td> </tr> <tr> <td>enumeration</td> <td>0191002</td> <td>documentation ADM</td> </tr> </tbody> </table>	Kind	Value	Annotation	enumeration	0191001	documentation Netz	enumeration	0191002	documentation ADM
Kind	Value	Annotation								
enumeration	0191001	documentation Netz								
enumeration	0191002	documentation ADM								
annotation	documentation Kat_BI_ZubehoerTyp									
source	<pre><simpleType name="enum_0191"> <annotation> <documentation>Kat_BI_ZubehoerTyp</documentation> </annotation> <restriction base="xs:string"> <enumeration value="0191001"> <annotation> <documentation>Netz</documentation> </annotation> </enumeration> <enumeration value="0191002"> <annotation> <documentation>ADM</documentation> </annotation> </enumeration> </restriction> </simpleType></pre>									

simpleType **enum_0200**

namespace	http://xml.ir-d.de/sak									
type	restriction of string									
properties	base xs:string									
facets	<table border="1"> <thead> <tr> <th>Kind</th> <th>Value</th> <th>Annotation</th> </tr> </thead> <tbody> <tr> <td>enumeration</td> <td>0200001</td> <td>documentation Erst-OP</td> </tr> <tr> <td>enumeration</td> <td>0200002</td> <td>documentation Folgeeingriff</td> </tr> </tbody> </table>	Kind	Value	Annotation	enumeration	0200001	documentation Erst-OP	enumeration	0200002	documentation Folgeeingriff
Kind	Value	Annotation								
enumeration	0200001	documentation Erst-OP								
enumeration	0200002	documentation Folgeeingriff								
annotation	documentation Kat_EP_ArtEingriff									
source	<pre><simpleType name="enum_0200"> <annotation> <documentation>Kat_EP_ArtEingriff</documentation> </annotation> <restriction base="xs:string"> <enumeration value="0200001"> <annotation> <documentation>Erst-OP</documentation> </annotation> </enumeration> <enumeration value="0200002"> <annotation> <documentation>Folgeeingriff</documentation> </annotation> </enumeration> </restriction> </simpleType></pre>									

</simpleType>

simpleType enum_0202

namespace	http://xml.ir-d.de/sak		
type	restriction of string		
properties	base xs:string		
facets	Kind	Value	Annotation
	enumeration	0202001	documentation Lockerung
	enumeration	0202002	documentation Infektion, Verdacht auf
	enumeration	0202003	documentation Infektion, gesichert
	enumeration	0202004	documentation Luxation, Inlay aus der Pfanne
	enumeration	0202005	documentation Luxation, Kopf aus Pfanne/Inlay
	enumeration	0202006	documentation Periprothetische Fraktur
	enumeration	0202007	documentation Verschleiß des PE-Inlays
	enumeration	0202008	documentation Implantatbruch
	enumeration	0202009	documentation Implantatfehlage/Malalignement
	enumeration	0202010	documentation Osteolysen bei festem Implantat
	enumeration	0202011	documentation Progression der Grunderkrankung
	enumeration	0202012	documentation ARMD
	enumeration	0202013	documentation Verdacht auf allergische Reaktion
	enumeration	0202042	documentation andere Gründe
annotation	documentation Kat_EP_GrundWechselHuefte		
source	<pre><simpleType name="enum_0202"> <annotation> <documentation>Kat_EP_GrundWechselHuefte</documentation> </annotation> <restriction base="xs:string"> <enumeration value="0202001"> <annotation> <documentation>Lockerung</documentation> </annotation> </enumeration> <enumeration value="0202002"> <annotation> <documentation>Infektion, Verdacht auf</documentation> </annotation> </enumeration> <enumeration value="0202003"> <annotation> <documentation>Infektion, gesichert</documentation> </annotation> </enumeration> <enumeration value="0202004"></pre>		

```

    <annotation>
      <documentation>Luxation, Inlay aus der Pfanne</documentation>
    </annotation>
  </enumeration>
  <enumeration value="0202005">
    <annotation>
      <documentation>Luxation, Kopf aus Pfanne/Inlay</documentation>
    </annotation>
  </enumeration>
  <enumeration value="0202006">
    <annotation>
      <documentation>Periprothetische Fraktur</documentation>
    </annotation>
  </enumeration>
  <enumeration value="0202007">
    <annotation>
      <documentation>Verschleiß des PE-Inlays</documentation>
    </annotation>
  </enumeration>
  <enumeration value="0202008">
    <annotation>
      <documentation>Implantatbruch</documentation>
    </annotation>
  </enumeration>
  <enumeration value="0202009">
    <annotation>
      <documentation>Implantatfehlage/Malalignent</documentation>
    </annotation>
  </enumeration>
  <enumeration value="0202010">
    <annotation>
      <documentation>Osteolysen bei festem Implantat</documentation>
    </annotation>
  </enumeration>
  <enumeration value="0202011">
    <annotation>
      <documentation>Progression der Grunderkrankung</documentation>
    </annotation>
  </enumeration>
  <enumeration value="0202012">
    <annotation>
      <documentation>ARMD</documentation>
    </annotation>
  </enumeration>
  <enumeration value="0202013">
    <annotation>
      <documentation>Verdacht auf allergische Reaktion</documentation>
    </annotation>
  </enumeration>
  <enumeration value="0202042">
    <annotation>
      <documentation>andere Gründe</documentation>
    </annotation>
  </enumeration>
</restriction>
</simpleType>

```

simpleType enum_0204

namespace	http://xml.ir-d.de/sak		
type	restriction of string		
properties	base xs:string		
facets	Kind	Value	Annotation
	enumeration	0204001	documentation Lockerung
	enumeration	0204002	documentation Infektion, Verdacht auf
	enumeration	0204003	documentation Infektion, gesichert
	enumeration	0204006	documentation Periprothetische Fraktur
	enumeration	0204007	documentation Verschleiß
	enumeration	0204008	documentation Implantatbruch
	enumeration	0204009	documentation Implantatfehlage/Malalignent
	enumeration	0204010	documentation Osteolysen bei festem Implantat
	enumeration	0204011	documentation Progression der Grunderkrankung
	enumeration	0204012	documentation ARM-D
	enumeration	0204013	documentation Verdacht auf allergische Reaktion
	enumeration	0204014	documentation Dislokation/Migration von Komponenten
	enumeration	0204015	documentation Bandinstabilität
	enumeration	0204016	documentation Bewegungseinschränkung
	enumeration	0204042	documentation andere Gründe
annotation	documentation Kat_EP_GrundWechselKnie		
source	<pre> <simpleType name="enum_0204"> <annotation> <documentation>Kat_EP_GrundWechselKnie</documentation> </annotation> <restriction base="xs:string"> <enumeration value="0204001"> <annotation> <documentation>Lockerung</documentation> </annotation> </enumeration> <enumeration value="0204002"> <annotation> <documentation>Infektion, Verdacht auf</documentation> </annotation> </enumeration> <enumeration value="0204003"> <annotation> <documentation>Infektion, gesichert</documentation> </annotation> </enumeration> <enumeration value="0204006"> <annotation> <documentation>Periprothetische Fraktur</documentation> </annotation> </enumeration> </restriction> </simpleType> </pre>		

```

    </annotation>
  </enumeration>
  <enumeration value="0204007">
    <annotation>
      <documentation>Verschleiß</documentation>
    </annotation>
  </enumeration>
  <enumeration value="0204008">
    <annotation>
      <documentation>Implantatbruch</documentation>
    </annotation>
  </enumeration>
  <enumeration value="0204009">
    <annotation>
      <documentation>Implantatfehlage/Malalignement</documentation>
    </annotation>
  </enumeration>
  <enumeration value="0204010">
    <annotation>
      <documentation>Osteolysen bei festem Implantat</documentation>
    </annotation>
  </enumeration>
  <enumeration value="0204011">
    <annotation>
      <documentation>Progression der Grunderkrankung</documentation>
    </annotation>
  </enumeration>
  <enumeration value="0204012">
    <annotation>
      <documentation>ARMD</documentation>
    </annotation>
  </enumeration>
  <enumeration value="0204013">
    <annotation>
      <documentation>Verdacht auf allergische Reaktion</documentation>
    </annotation>
  </enumeration>
  <enumeration value="0204014">
    <annotation>
      <documentation>Dislokation/Migration von Komponenten</documentation>
    </annotation>
  </enumeration>
  <enumeration value="0204015">
    <annotation>
      <documentation>Bandinstabilität</documentation>
    </annotation>
  </enumeration>
  <enumeration value="0204016">
    <annotation>
      <documentation>Bewegungseinschränkung</documentation>
    </annotation>
  </enumeration>
  <enumeration value="0204042">
    <annotation>
      <documentation>andere Gründe</documentation>
    </annotation>
  </enumeration>
</restriction>
</simpleType>

```

simpleType enum 0206

namespace	http://xml.ir-d.de/sak		
type	restriction of string		
properties	base xs:string		
facets	Kind	Value	Annotation
	enumeration	0206001	documentation Lockerung
	enumeration	0206002	documentation Infektion, Verdacht auf
	enumeration	0206003	documentation Infektion, gesichert
	enumeration	0206004	documentation Luxation, Inlay aus der Pfanne
	enumeration	0206005	documentation Luxation, Kopf aus Pfanne/Inlay
	enumeration	0206006	documentation Periprothetische Fraktur
	enumeration	0206007	documentation Verschleiß
	enumeration	0206008	documentation Implantatbruch
	enumeration	0206009	documentation Implantatfehlage/Malalignent
	enumeration	0206010	documentation Osteolysen bei festem Implantat
	enumeration	0206011	documentation Progression der Grunderkrankung
	enumeration	0206012	documentation ARMD
	enumeration	0206013	documentation Verdacht auf allergische Reaktion
	enumeration	0206014	documentation Dislokation/Migration von Komponenten
	enumeration	0206015	documentation Bandinstabilität
	enumeration	0206016	documentation Bewegungseinschränkung
	enumeration	0206042	documentation andere Gründe
annotation	documentation Kat_EP_GrundWechselTFE		
source	<pre> <simpleType name="enum_0206"> <annotation> <documentation>Kat_EP_GrundWechselTFE</documentation> </annotation> <restriction base="xs:string"> <enumeration value="0206001"> <annotation> <documentation>Lockerung</documentation> </annotation> </enumeration> <enumeration value="0206002"> <annotation> <documentation>Infektion, Verdacht auf</documentation> </annotation> </enumeration> <enumeration value="0206003"> <annotation> </pre>		

```
<documentation>Infektion, gesichert</documentation>
</annotation>
</enumeration>
<enumeration value="0206004">
  <annotation>
    <documentation>Luxation, Inlay aus der Pfanne</documentation>
  </annotation>
</enumeration>
<enumeration value="0206005">
  <annotation>
    <documentation>Luxation, Kopf aus Pfanne/Inlay</documentation>
  </annotation>
</enumeration>
<enumeration value="0206006">
  <annotation>
    <documentation>Periprothetische Fraktur</documentation>
  </annotation>
</enumeration>
<enumeration value="0206007">
  <annotation>
    <documentation>Verschleiß</documentation>
  </annotation>
</enumeration>
<enumeration value="0206008">
  <annotation>
    <documentation>Implantatbruch</documentation>
  </annotation>
</enumeration>
<enumeration value="0206009">
  <annotation>
    <documentation>Implantatfehllage/Malalignement</documentation>
  </annotation>
</enumeration>
<enumeration value="0206010">
  <annotation>
    <documentation>Osteolysen bei festem Implantat</documentation>
  </annotation>
</enumeration>
<enumeration value="0206011">
  <annotation>
    <documentation>Progression der Grunderkrankung</documentation>
  </annotation>
</enumeration>
<enumeration value="0206012">
  <annotation>
    <documentation>ARMD</documentation>
  </annotation>
</enumeration>
<enumeration value="0206013">
  <annotation>
    <documentation>Verdacht auf allergische Reaktion</documentation>
  </annotation>
</enumeration>
<enumeration value="0206014">
  <annotation>
    <documentation>Dislokation/Migration von Komponenten</documentation>
  </annotation>
</enumeration>
<enumeration value="0206015">
```

	<pre> <annotation> <documentation>Bandinstabilität</documentation> </annotation> </enumeration> <enumeration value="0206016"> <annotation> <documentation>Bewegungseinschränkung</documentation> </annotation> </enumeration> <enumeration value="0206042"> <annotation> <documentation>andere Gründe</documentation> </annotation> </enumeration> </restriction> </simpleType> </pre>
--	--

simpleType enum_0210

namespace	http://xml.ir-d.de/sak		
type	restriction of string		
properties	base xs:string		
facets	Kind	Value	Annotation
	enumeration	0210001	documentation keine relevante Voroperation
	enumeration	0210002	documentation Osteosynthese/Osteotomie (Becken)
	enumeration	0210003	documentation Osteosynthese/Osteotomie (Femur)
	enumeration	0210004	documentation Osteosynthese/Osteotomie (beides)
	enumeration	0210005	documentation Operation bei Hüftkopfnekrose
	enumeration	0210006	documentation Arthrodese
	enumeration	0210042	documentation andere
annotation	documentation Kat_EP_VoroperationHuefte		
source	<pre> <simpleType name="enum_0210"> <annotation> <documentation>Kat_EP_VoroperationHuefte</documentation> </annotation> <restriction base="xs:string"> <enumeration value="0210001"> <annotation> <documentation>keine relevante Voroperation</documentation> </annotation> </enumeration> <enumeration value="0210002"> <annotation> <documentation>Osteosynthese/Osteotomie (Becken)</documentation> </annotation> </enumeration> <enumeration value="0210003"> <annotation> <documentation>Osteosynthese/Osteotomie (Femur)</documentation> </annotation> </enumeration> </restriction> </simpleType> </pre>		

	<pre> </annotation> </enumeration> <enumeration value="0210004"> <annotation> <documentation>Osteosynthese/Osteotomie (beides)</documentation> </annotation> </enumeration> <enumeration value="0210005"> <annotation> <documentation>Operation bei Hüftkopfnnekrose</documentation> </annotation> </enumeration> <enumeration value="0210006"> <annotation> <documentation>Arthrodese</documentation> </annotation> </enumeration> <enumeration value="0210042"> <annotation> <documentation>andere</documentation> </annotation> </enumeration> </restriction> </simpleType> </pre>
--	---

simpleType enum_0211

namespace	http://xml.ir-d.de/sak		
type	restriction of string		
properties	base xs:string		
facets	Kind	Value	Annotation
	enumeration	0211001	documentation keine relevante Voroperation
	enumeration	0211002	documentation Osteosynthese/Osteotomie (Femur)
	enumeration	0211003	documentation Osteosynthese/Osteotomie (Tibia)
	enumeration	0211004	documentation Osteosynthese/Osteotomie (Patella)
	enumeration	0211005	documentation Osteosynthese/Osteotomie (mehrere)
	enumeration	0211006	documentation Kapsel-/Bandapparat
	enumeration	0211007	documentation Arthrodese
	enumeration	0211042	documentation andere
annotation	documentation Kat_EP_VoroperationKnie		
source	<pre> <simpleType name="enum_0211"> <annotation> <documentation>Kat_EP_VoroperationKnie</documentation> </annotation> <restriction base="xs:string"> <enumeration value="0211001"> <annotation> <documentation>keine relevante Voroperation</documentation> </annotation> </pre>		

```

</enumeration>
<enumeration value="0211002">
  <annotation>
    <documentation>Osteosynthese/Osteotomie (Femur)</documentation>
  </annotation>
</enumeration>
<enumeration value="0211003">
  <annotation>
    <documentation>Osteosynthese/Osteotomie (Tibia)</documentation>
  </annotation>
</enumeration>
<enumeration value="0211004">
  <annotation>
    <documentation>Osteosynthese/Osteotomie (Patella)</documentation>
  </annotation>
</enumeration>
<enumeration value="0211005">
  <annotation>
    <documentation>Osteosynthese/Osteotomie (mehrere)</documentation>
  </annotation>
</enumeration>
<enumeration value="0211006">
  <annotation>
    <documentation>Kapsel-/Bandapparat</documentation>
  </annotation>
</enumeration>
<enumeration value="0211007">
  <annotation>
    <documentation>Arthrodesse</documentation>
  </annotation>
</enumeration>
<enumeration value="0211042">
  <annotation>
    <documentation>andere</documentation>
  </annotation>
</enumeration>
</restriction>
</simpleType>

```

simpleType **enum_0212**

namespace	http://xml.ir-d.de/sak		
type	restriction of string		
properties	base xs:string		
facets	Kind	Value	Annotation
	enumeration	0212001	documentation Hüfte
	enumeration	0212002	documentation Knie
	enumeration	0212003	documentation Totaler Femurersatz inkl. Durchsteck-Prothese
annotation	documentation Kat_EP_Gelenk		
source	<simpleType name="enum_0212"> <annotation> <documentation>Kat_EP_Gelenk</documentation> </annotation>		

	<pre> <restriction base="xs:string"> <enumeration value="0212001"> <annotation> <documentation>Hüfte</documentation> </annotation> </enumeration> <enumeration value="0212002"> <annotation> <documentation>Knie</documentation> </annotation> </enumeration> <enumeration value="0212003"> <annotation> <documentation>Totaler Femurersatz inkl. Durchsteck- Prothese</documentation> </annotation> </enumeration> </restriction> </simpleType> </pre>
--	---

simpleType enum 0220

namespace	http://xml.ir-d.de/sak		
type	restriction of string		
properties	base xs:string		
facets	Kind	Value	Annotation
	enumeration	0220001	documentation anterior
	enumeration	0220002	documentation anterolateral
	enumeration	0220003	documentation lateral
	enumeration	0220004	documentation posterior
	enumeration	0220005	documentation posterolateral
	enumeration	0220006	documentation 2-Inzisionen-Zugang
	enumeration	0220042	documentation sonstiger
annotation	documentation Kat_EP_Operationszugang		
source	<pre> <simpleType name="enum_0220"> <annotation> <documentation>Kat_EP_Operationszugang</documentation> </annotation> <restriction base="xs:string"> <enumeration value="0220001"> <annotation> <documentation>anterior</documentation> </annotation> </enumeration> <enumeration value="0220002"> <annotation> <documentation>anterolateral</documentation> </annotation> </enumeration> </restriction> </pre>		

	<pre> <enumeration value="0220003"> <annotation> <documentation>lateral</documentation> </annotation> </enumeration> <enumeration value="0220004"> <annotation> <documentation>posterior</documentation> </annotation> </enumeration> <enumeration value="0220005"> <annotation> <documentation>posterolateral</documentation> </annotation> </enumeration> <enumeration value="0220006"> <annotation> <documentation>2-Inzisionen-Zugang</documentation> </annotation> </enumeration> <enumeration value="0220042"> <annotation> <documentation>sonstiger</documentation> </annotation> </enumeration> </restriction> </simpleType> </pre>
--	---

simpleType enum_0222

namespace	http://xml.ir-d.de/sak		
type	restriction of string		
properties	base xs:string		
facets	Kind	Value	Annotation
	enumeration	0222001	documentation nein
	enumeration	0222002	documentation ja- Ausbau
	enumeration	0222003	documentation ja- Einbau
annotation	documentation Kat_EP_Zweizeitwechsel		
source	<pre> <simpleType name="enum_0222"> <annotation> <documentation>Kat_EP_Zweizeitwechsel</documentation> </annotation> <restriction base="xs:string"> <enumeration value="0222001"> <annotation> <documentation>nein</documentation> </annotation> </enumeration> <enumeration value="0222002"> <annotation> <documentation>ja- Ausbau</documentation> </annotation> </enumeration> </restriction> </simpleType> </pre>		

	<pre> <enumeration value="0222003"> <annotation> <documentation>ja- Einbau</documentation> </annotation> </enumeration> </restriction> </simpleType> </pre>
--	---

simpleType enum_0252

namespace	http://xml.ir-d.de/sak		
type	restriction of string		
properties	base xs:string		
facets	Kind	Value	Annotation
	enumeration	0252001	documentation Pfanne
	enumeration	0252002	documentation Schaft
	enumeration	0252003	documentation beides
annotation	documentation Kat_EP_KomponenteHuefte		
source	<pre> <simpleType name="enum_0252"> <annotation> <documentation>Kat_EP_KomponenteHuefte</documentation> </annotation> <restriction base="xs:string"> <enumeration value="0252001"> <annotation> <documentation>Pfanne</documentation> </annotation> </enumeration> <enumeration value="0252002"> <annotation> <documentation>Schaft</documentation> </annotation> </enumeration> <enumeration value="0252003"> <annotation> <documentation>beides</documentation> </annotation> </enumeration> </restriction> </simpleType> </pre>		

simpleType enum_0254

namespace	http://xml.ir-d.de/sak		
type	restriction of string		
properties	base xs:string		
facets	Kind	Value	Annotation
	enumeration	0254001	documentation Femur
	enumeration	0254002	documentation

	enumeration 0254003 Tibia documentation Patella enumeration 0254004 Tibia documentation mehrere
annotation	documentation Kat_EP_KomponenteKnie
source	<pre> <simpleType name="enum_0254"> <annotation> <documentation>Kat_EP_KomponenteKnie</documentation> </annotation> <restriction base="xs:string"> <enumeration value="0254001"> <annotation> <documentation>Femur</documentation> </annotation> </enumeration> <enumeration value="0254002"> <annotation> <documentation>Tibia</documentation> </annotation> </enumeration> <enumeration value="0254003"> <annotation> <documentation>Patella</documentation> </annotation> </enumeration> <enumeration value="0254004"> <annotation> <documentation>mehrere</documentation> </annotation> </enumeration> </restriction> </simpleType> </pre>

simpleType enum_0256

namespace	http://xml.ir-d.de/sak		
type	restriction of string		
properties	base xs:string		
facets	Kind	Value	Annotation
	enumeration	0256001	documentation Pfanne
	enumeration	0256002	documentation Schaft
	enumeration	0256003	documentation Pfanne und Schaft
	enumeration	0256004	documentation Femur
	enumeration	0256005	documentation Tibia
	enumeration	0256006	documentation Patella
	enumeration	0256007	documentation mehrere
annotation	documentation Kat_EP_KomponenteTFE		

source	<pre> <simpleType name="enum_0256"> <annotation> <documentation>Kat_EP_KomponenteTFE</documentation> </annotation> <restriction base="xs:string"> <enumeration value="0256001"> <annotation> <documentation>Pfanne</documentation> </annotation> </enumeration> <enumeration value="0256002"> <annotation> <documentation>Schaft</documentation> </annotation> </enumeration> <enumeration value="0256003"> <annotation> <documentation>Pfanne und Schaft</documentation> </annotation> </enumeration> <enumeration value="0256004"> <annotation> <documentation>Femur</documentation> </annotation> </enumeration> <enumeration value="0256005"> <annotation> <documentation>Tibia</documentation> </annotation> </enumeration> <enumeration value="0256006"> <annotation> <documentation>Patella</documentation> </annotation> </enumeration> <enumeration value="0256007"> <annotation> <documentation>mehrere</documentation> </annotation> </enumeration> </restriction> </simpleType> </pre>
--------	--

simpleType enum_0262

namespace	http://xml.ir-d.de/sak		
type	restriction of string		
properties	base xs:string		
facets	Kind	Value	Annotation
	enumeration	0262001	documentation Pfanne
	enumeration	0262002	documentation Schaft
	enumeration	0262003	documentation Kopf
	enumeration	0262004	documentation Inlay

	enumeration 0262005 documentation Adapter
	enumeration 0262006 documentation mehrere
annotation	documentation Kat_EP_ImplantatbruchHuefte
source	<pre> <simpleType name="enum_0262"> <annotation> <documentation>Kat_EP_ImplantatbruchHuefte</documentation> </annotation> <restriction base="xs:string"> <enumeration value="0262001"> <annotation> <documentation>Pfanne</documentation> </annotation> </enumeration> <enumeration value="0262002"> <annotation> <documentation>Schaft</documentation> </annotation> </enumeration> <enumeration value="0262003"> <annotation> <documentation>Kopf</documentation> </annotation> </enumeration> <enumeration value="0262004"> <annotation> <documentation>Inlay</documentation> </annotation> </enumeration> <enumeration value="0262005"> <annotation> <documentation>Adapter</documentation> </annotation> </enumeration> <enumeration value="0262006"> <annotation> <documentation>mehrere</documentation> </annotation> </enumeration> </restriction> </simpleType> </pre>

simpleType enum_0264

namespace	http://xml.ir-d.de/sak		
type	restriction of string		
properties	base xs:string		
facets	Kind	Value	Annotation
	enumeration	0264001	documentation Femur
	enumeration	0264002	documentation Tibia
	enumeration	0264003	documentation Inlay
	enumeration	0264004	documentation

	<p>enumeration 0264005 Adapter documentation Verlängerung</p> <p>enumeration 0264006 documentation Schrauben</p> <p>enumeration 0264007 documentation mehrere</p> <p>enumeration 0264042 documentation andere</p>
annotation	documentation Kat_EP_ImplantatbruchKnie
source	<pre> <simpleType name="enum_0264"> <annotation> <documentation>Kat_EP_ImplantatbruchKnie</documentation> </annotation> <restriction base="xs:string"> <enumeration value="0264001"> <annotation> <documentation>Femur</documentation> </annotation> </enumeration> <enumeration value="0264002"> <annotation> <documentation>Tibia</documentation> </annotation> </enumeration> <enumeration value="0264003"> <annotation> <documentation>Inlay</documentation> </annotation> </enumeration> <enumeration value="0264004"> <annotation> <documentation>Adapter</documentation> </annotation> </enumeration> <enumeration value="0264005"> <annotation> <documentation>Verlängerung</documentation> </annotation> </enumeration> <enumeration value="0264006"> <annotation> <documentation>Schrauben</documentation> </annotation> </enumeration> <enumeration value="0264007"> <annotation> <documentation>mehrere</documentation> </annotation> </enumeration> <enumeration value="0264042"> <annotation> <documentation>andere</documentation> </annotation> </enumeration> </restriction> </simpleType> </pre>

simpleType enum_0266

namespace	http://xml.ir-d.de/sak		
type	restriction of string		
properties	base xs:string		
facets	Kind	Value	Annotation
	enumeration	0266001	documentation Pfanne
	enumeration	0266002	documentation Schaft
	enumeration	0266003	documentation Kopf
	enumeration	0266004	documentation Inlay
	enumeration	0266005	documentation Adapter
	enumeration	0266006	documentation Femur
	enumeration	0266007	documentation Tibia
	enumeration	0266008	documentation Verlängerung
	enumeration	0266009	documentation Schrauben
	enumeration	0266010	documentation mehrere
	enumeration	0266042	documentation andere
annotation	documentation Kat_EP_ImplantatbruchTFE		
source	<pre> <simpleType name="enum_0266"> <annotation> <documentation>Kat_EP_ImplantatbruchTFE</documentation> </annotation> <restriction base="xs:string"> <enumeration value="0266001"> <annotation> <documentation>Pfanne</documentation> </annotation> </enumeration> <enumeration value="0266002"> <annotation> <documentation>Schaft</documentation> </annotation> </enumeration> <enumeration value="0266003"> <annotation> <documentation>Kopf</documentation> </annotation> </enumeration> <enumeration value="0266004"> <annotation> <documentation>Inlay</documentation> </annotation> </enumeration> <enumeration value="0266005"> <annotation> <documentation>Adapter</documentation> </annotation> </enumeration> </restriction> </simpleType> </pre>		

	<pre> </enumeration> <enumeration value="0266006"> <annotation> <documentation>Femur</documentation> </annotation> </enumeration> <enumeration value="0266007"> <annotation> <documentation>Tibia</documentation> </annotation> </enumeration> <enumeration value="0266008"> <annotation> <documentation>Verlängerung</documentation> </annotation> </enumeration> <enumeration value="0266009"> <annotation> <documentation>Schrauben</documentation> </annotation> </enumeration> <enumeration value="0266010"> <annotation> <documentation>mehrere</documentation> </annotation> </enumeration> <enumeration value="0266042"> <annotation> <documentation>andere</documentation> </annotation> </enumeration> </restriction> </simpleType> </pre>
--	--

simpleType enum_0270

namespace	http://xml.lir-d.de/sak		
type	restriction of string		
properties	base xs:string		
facets	Kind	Value	Annotation
	enumeration	0270001	documentation PE-Inlay
	enumeration	0270002	documentation patellare Komponente
	enumeration	0270003	documentation beides
annotation	documentation Kat_EP_VerschleissKnie		
source	<pre> <simpleType name="enum_0270"> <annotation> <documentation>Kat_EP_VerschleissKnie</documentation> </annotation> <restriction base="xs:string"> <enumeration value="0270001"> <annotation> <documentation>PE-Inlay</documentation> </annotation> </pre>		

	<pre> </enumeration> <enumeration value="0270002"> <annotation> <documentation>patellare Komponente</documentation> </annotation> </enumeration> <enumeration value="0270003"> <annotation> <documentation>beides</documentation> </annotation> </enumeration> </restriction> </simpleType> </pre>
--	--

simpleType enum_0271

namespace	http://xml.ir-d.de/sak																					
type	restriction of string																					
properties	base xs:string																					
facets	<table border="1"> <thead> <tr> <th>Kind</th> <th>Value</th> <th>Annotation</th> </tr> </thead> <tbody> <tr> <td>enumeration</td> <td>0271001</td> <td>documentation Schraube</td> </tr> <tr> <td>enumeration</td> <td>0271002</td> <td>documentation Inlay</td> </tr> <tr> <td>enumeration</td> <td>0271003</td> <td>documentation patellare Komponente</td> </tr> <tr> <td>enumeration</td> <td>0271004</td> <td>documentation Kopplung</td> </tr> <tr> <td>enumeration</td> <td>0271005</td> <td>documentation mehrere</td> </tr> <tr> <td>enumeration</td> <td>0271042</td> <td>documentation andere</td> </tr> </tbody> </table>	Kind	Value	Annotation	enumeration	0271001	documentation Schraube	enumeration	0271002	documentation Inlay	enumeration	0271003	documentation patellare Komponente	enumeration	0271004	documentation Kopplung	enumeration	0271005	documentation mehrere	enumeration	0271042	documentation andere
Kind	Value	Annotation																				
enumeration	0271001	documentation Schraube																				
enumeration	0271002	documentation Inlay																				
enumeration	0271003	documentation patellare Komponente																				
enumeration	0271004	documentation Kopplung																				
enumeration	0271005	documentation mehrere																				
enumeration	0271042	documentation andere																				
annotation	documentation Kat_EP_MigrationKnie																					
source	<pre> <simpleType name="enum_0271"> <annotation> <documentation>Kat_EP_MigrationKnie</documentation> </annotation> <restriction base="xs:string"> <enumeration value="0271001"> <annotation> <documentation>Schraube</documentation> </annotation> </enumeration> <enumeration value="0271002"> <annotation> <documentation>Inlay</documentation> </annotation> </enumeration> <enumeration value="0271003"> <annotation> <documentation>patellare Komponente</documentation> </annotation> </enumeration> <enumeration value="0271004"> <annotation> <documentation>Kopplung</documentation> </annotation> </enumeration> </restriction> </simpleType> </pre>																					

	<pre> </annotation> </enumeration> <enumeration value="0271005"> <annotation> <documentation>mehrere</documentation> </annotation> </enumeration> <enumeration value="0271042"> <annotation> <documentation>andere</documentation> </annotation> </enumeration> </restriction> </simpleType> </pre>
--	---

simpleType enum_0280

namespace	http://xml.ir-d.de/sak		
type	restriction of string		
properties	base xs:string		
facets	Kind	Value	Annotation
	enumeration	0280001	documentation Ohne
	enumeration	0280002	documentation PSI
	enumeration	0280003	documentation Navigation
	enumeration	0280004	documentation Robotik
	enumeration	0280042	documentation Unbekannt
annotation	documentation Kat_EP_AssistiveTechnologie		
source	<pre> <simpleType name="enum_0280"> <annotation> <documentation>Kat_EP_AssistiveTechnologie</documentation> </annotation> <restriction base="xs:string"> <enumeration value="0280001"> <annotation> <documentation>Ohne</documentation> </annotation> </enumeration> <enumeration value="0280002"> <annotation> <documentation>PSI</documentation> </annotation> </enumeration> <enumeration value="0280003"> <annotation> <documentation>Navigation</documentation> </annotation> </enumeration> <enumeration value="0280004"> <annotation> <documentation>Robotik</documentation> </annotation> </enumeration> </restriction> </simpleType> </pre>		

```

</enumeration>
<enumeration value="0280042">
  <annotation>
    <documentation>Unbekannt</documentation>
  </annotation>
</enumeration>
</restriction>
</simpleType>

```

simpleType enum_0281

namespace	http://xml.ir-d.de/sak		
type	restriction of string		
properties	base xs:string		
facets	Kind	Value	Annotation
	enumeration	0281001	documentation Aesculap - OrthoPilot
	enumeration	0281002	documentation Amplitude - Amplivision
	enumeration	0281003	documentation Johnson & Johnson - VELYS
	enumeration	0281004	documentation Orthokey - Orthokey Miro
	enumeration	0281005	documentation Orthokey - BLU-IGS
	enumeration	0281006	documentation Smith & Nephew - Brainlab Plattformen (TBD)
	enumeration	0281007	documentation Stryker - Stryker NAV3i
	enumeration	0281008	documentation Stryker - Stryker Ortho Q Guidance System
	enumeration	0281009	documentation ThinkSurgical - TMINI
	enumeration	0281010	documentation Zimmer Biomet - Sesamoid Navigation
	enumeration	0281011	documentation Zimmer Biomet - iAssist Navigation
	enumeration	0281012	documentation nicht belegter Wert
	enumeration	0281013	documentation nicht belegter Wert
	enumeration	0281014	documentation nicht belegter Wert
	enumeration	0281015	documentation nicht belegter Wert
	enumeration	0281016	documentation nicht belegter Wert
	enumeration	0281042	documentation sonstige
annotation	documentation Kat_EP_Navigation		
source	<pre> <simpleType name="enum_0281"> <annotation> <documentation>Kat_EP_Navigation</documentation> </annotation> <restriction base="xs:string"> <enumeration value="0281001"> <annotation> <documentation>Aesculap - OrthoPilot</documentation> </pre>		

```

</annotation>
</enumeration>
<enumeration value="0281002">
  <annotation>
    <documentation>Amplitude - Amplivision</documentation>
  </annotation>
</enumeration>
<enumeration value="0281003">
  <annotation>
    <documentation>Johnson & Johnson - VELYS</documentation>
  </annotation>
</enumeration>
<enumeration value="0281004">
  <annotation>
    <documentation>Orthokey - Orthokey Miro</documentation>
  </annotation>
</enumeration>
<enumeration value="0281005">
  <annotation>
    <documentation>Orthokey - BLU-IGS</documentation>
  </annotation>
</enumeration>
<enumeration value="0281006">
  <annotation>
    <documentation>Smith & Nephew - Brainlab Plattformen
(TBD)</documentation>
  </annotation>
</enumeration>
<enumeration value="0281007">
  <annotation>
    <documentation>Stryker - Stryker NAV3i</documentation>
  </annotation>
</enumeration>
<enumeration value="0281008">
  <annotation>
    <documentation>Stryker - Stryker Ortho Q Guidance
System</documentation>
  </annotation>
</enumeration>
<enumeration value="0281009">
  <annotation>
    <documentation>ThinkSurgical - TMINI</documentation>
  </annotation>
</enumeration>
<enumeration value="0281010">
  <annotation>
    <documentation>Zimmer Biomet - Sesamoid Navigation</documentation>
  </annotation>
</enumeration>
<enumeration value="0281011">
  <annotation>
    <documentation>Zimmer Biomet - iAssist Navigation</documentation>
  </annotation>
</enumeration>
<enumeration value="0281012">
  <annotation>
    <documentation>nicht belegter Wert</documentation>
  </annotation>
</enumeration>

```

```

<enumeration value="0281013">
  <annotation>
    <documentation>nicht belegter Wert</documentation>
  </annotation>
</enumeration>
<enumeration value="0281014">
  <annotation>
    <documentation>nicht belegter Wert</documentation>
  </annotation>
</enumeration>
<enumeration value="0281015">
  <annotation>
    <documentation>nicht belegter Wert</documentation>
  </annotation>
</enumeration>
<enumeration value="0281016">
  <annotation>
    <documentation>nicht belegter Wert</documentation>
  </annotation>
</enumeration>
<enumeration value="0281042">
  <annotation>
    <documentation>sonstige</documentation>
  </annotation>
</enumeration>
</restriction>
</simpleType>

```

simpleType enum_0282

namespace	http://xml.ir-d.de/sak		
type	restriction of string		
properties	base xs:string		
facets	Kind	Value	Annotation
	enumeration	0282001	documentation Amplitude - Andy
	enumeration	0282002	documentation Corin - ApolloKnee
	enumeration	0282003	documentation Corin - OMNIBotics
	enumeration	0282004	documentation Microport - Skywalker
	enumeration	0282005	documentation Orthokey - Orthokey Robin
	enumeration	0282006	documentation Smith & Nephew - CORI
	enumeration	0282007	documentation Smith & Nephew - NAVIO
	enumeration	0282008	documentation Stryker - Mako SmartRobotics
	enumeration	0282009	documentation Zimmer Biomet - ROSA
	enumeration	0282010	documentation Johnson & Johnson - VELYS Robotic Assisted Solution
	enumeration	0282011	documentation nicht belegter Wert
	enumeration	0282012	documentation nicht belegter Wert
	enumeration	0282013	documentation

	<p>enumeration 0282014 nicht belegter Wert documentation</p> <p>enumeration 0282015 nicht belegter Wert documentation</p> <p>enumeration 0282042 nicht belegter Wert documentation sonstige</p>
annotation	documentation Kat_EP_Robotik
source	<pre> <simpleType name="enum_0282"> <annotation> <documentation>Kat_EP_Robotik</documentation> </annotation> <restriction base="xs:string"> <enumeration value="0282001"> <annotation> <documentation>Amplitude - Andy</documentation> </annotation> </enumeration> <enumeration value="0282002"> <annotation> <documentation>Corin - ApolloKnee</documentation> </annotation> </enumeration> <enumeration value="0282003"> <annotation> <documentation>Corin - OMNIBotics</documentation> </annotation> </enumeration> <enumeration value="0282004"> <annotation> <documentation>Microport - Skywalker</documentation> </annotation> </enumeration> <enumeration value="0282005"> <annotation> <documentation>Orthokey - Orthokey Robin</documentation> </annotation> </enumeration> <enumeration value="0282006"> <annotation> <documentation>Smith & Nephew - CORI</documentation> </annotation> </enumeration> <enumeration value="0282007"> <annotation> <documentation>Smith & Nephew - NAVIO</documentation> </annotation> </enumeration> <enumeration value="0282008"> <annotation> <documentation>Stryker - Mako SmartRobotics</documentation> </annotation> </enumeration> <enumeration value="0282009"> <annotation> <documentation>Zimmer Biomet - ROSA</documentation> </annotation> </enumeration> </restriction> </simpleType> </pre>

```

<enumeration value="0282010">
  <annotation>
    <documentation>Johnson & Johnson - VELYS Robotic Assisted
Solution</documentation>
  </annotation>
</enumeration>
<enumeration value="0282011">
  <annotation>
    <documentation>nicht belegter Wert</documentation>
  </annotation>
</enumeration>
<enumeration value="0282012">
  <annotation>
    <documentation>nicht belegter Wert</documentation>
  </annotation>
</enumeration>
<enumeration value="0282013">
  <annotation>
    <documentation>nicht belegter Wert</documentation>
  </annotation>
</enumeration>
<enumeration value="0282014">
  <annotation>
    <documentation>nicht belegter Wert</documentation>
  </annotation>
</enumeration>
<enumeration value="0282015">
  <annotation>
    <documentation>nicht belegter Wert</documentation>
  </annotation>
</enumeration>
<enumeration value="0282042">
  <annotation>
    <documentation>sonstige</documentation>
  </annotation>
</enumeration>
</restriction>
</simpleType>

```

simpleType enum 0290

namespace	http://xml.ir-d.de/sak		
type	restriction of string		
properties	base xs:string		
facets	Kind	Value	Annotation
	enumeration	0290001	documentation Hüft-Komponente
	enumeration	0290002	documentation Knie-Komponente
	enumeration	0290003	documentation Modulare Komponente (Hüfte/Knie)
	enumeration	0290004	documentation Knochenzement
	enumeration	0290042	documentation sonstiger
annotation	documentation Kat_EP_Artikeltyp		

source	<pre> <simpleType name="enum_0290"> <annotation> <documentation>Kat_EP_Artikeltyp</documentation> </annotation> <restriction base="xs:string"> <enumeration value="0290001"> <annotation> <documentation>Hüft-Komponente</documentation> </annotation> </enumeration> <enumeration value="0290002"> <annotation> <documentation>Knie-Komponente</documentation> </annotation> </enumeration> <enumeration value="0290003"> <annotation> <documentation>Modulare Komponente (Hüfte/Knie)</documentation> </annotation> </enumeration> <enumeration value="0290004"> <annotation> <documentation>Knochenzement</documentation> </annotation> </enumeration> <enumeration value="0290042"> <annotation> <documentation>sonstiger</documentation> </annotation> </enumeration> </restriction> </simpleType> </pre>
--------	--

simpleType enum_0292

namespace	http://xml.ir-d.de/sak		
type	restriction of string		
properties	base xs:string		
facets	Kind	Value	Annotation
	enumeration	0292001	documentation Pfanne
	enumeration	0292002	documentation Inlay
	enumeration	0292003	documentation Kopf
	enumeration	0292004	documentation Schaft
	enumeration	0292005	documentation Vormontierte Acetabularkomponente (Pfanne mit Inlay)
	enumeration	0292006	documentation Einteilige Femoralkomponente (Schaft mit Kopf)
	enumeration	0292042	documentation sonstiger
annotation	documentation Kat_EP_ArtikeltypHuefte		
source	<pre> <simpleType name="enum_0292"> <annotation> </pre>		

```

<documentation>Kat_EP_ArtikeltypHuefte</documentation>
</annotation>
<restriction base="xs:string">
  <enumeration value="0292001">
    <annotation>
      <documentation>Pfanne</documentation>
    </annotation>
  </enumeration>
  <enumeration value="0292002">
    <annotation>
      <documentation>Inlay</documentation>
    </annotation>
  </enumeration>
  <enumeration value="0292003">
    <annotation>
      <documentation>Kopf</documentation>
    </annotation>
  </enumeration>
  <enumeration value="0292004">
    <annotation>
      <documentation>Schaft</documentation>
    </annotation>
  </enumeration>
  <enumeration value="0292005">
    <annotation>
      <documentation>Vormontierte Acetabularkomponente (Pfanne mit
Inlay)</documentation>
    </annotation>
  </enumeration>
  <enumeration value="0292006">
    <annotation>
      <documentation>Einteilige Femoralkomponente (Schaft mit
Kopf)</documentation>
    </annotation>
  </enumeration>
  <enumeration value="0292042">
    <annotation>
      <documentation>sonstiger</documentation>
    </annotation>
  </enumeration>
</restriction>
</simpleType>

```

simpleType enum_0293

namespace	http://xml.ir-d.de/sak		
type	restriction of string		
properties	base xs:string		
facets	Kind	Value	Annotation
	enumeration	0293001	documentation Tibiakomponente
	enumeration	0293002	documentation Femurkomponente
	enumeration	0293003	documentation Patella
	enumeration	0293004	documentation Insert

	enumeration 0293005 documentation Vormontierte Tibiakomponente mit Insert enumeration 0293042 documentation sonstiger
annotation	documentation Kat_EP_ArtikeltypKnie
source	<pre> <simpleType name="enum_0293"> <annotation> <documentation>Kat_EP_ArtikeltypKnie</documentation> </annotation> <restriction base="xs:string"> <enumeration value="0293001"> <annotation> <documentation>Tibiakomponente</documentation> </annotation> </enumeration> <enumeration value="0293002"> <annotation> <documentation>Femurkomponente</documentation> </annotation> </enumeration> <enumeration value="0293003"> <annotation> <documentation>Patella</documentation> </annotation> </enumeration> <enumeration value="0293004"> <annotation> <documentation>Insert</documentation> </annotation> </enumeration> <enumeration value="0293005"> <annotation> <documentation>Vormontierte Tibiakomponente mit Insert</documentation> </annotation> </enumeration> <enumeration value="0293042"> <annotation> <documentation>sonstiger</documentation> </annotation> </enumeration> </restriction> </simpleType> </pre>

simpleType enum_0300

namespace	http://xml.ir-d.de/sak		
type	restriction of string		
properties	base xs:string		
facets	Kind	Value	Annotation
	enumeration	0300001	documentation konventioneller Aortenklappenersatz
	enumeration	0300002	documentation kathetergestützte Aortenklappenimplantation (TAVI)
annotation	documentation Kat_AK_ArtEingriff		

source	<pre> <simpleType name="enum_0300"> <annotation> <documentation>Kat_AK_ArtEingriff</documentation> </annotation> <restriction base="xs:string"> <enumeration value="0300001"> <annotation> <documentation>konventioneller Aortenklappenersatz</documentation> </annotation> </enumeration> <enumeration value="0300002"> <annotation> <documentation>kathetergestützte Aortenklappenimplantation (TAVI)</documentation> </annotation> </enumeration> </restriction> </simpleType> </pre>
--------	--

simpleType enum_0301

namespace	http://xml.ir-d.de/sak		
type	restriction of string		
properties	base xs:string		
facets	Kind	Value	Annotation
	enumeration	0301001	documentation produktbezogen
	enumeration	0301002	documentation nicht-produktbezogen
annotation	documentation Kat_AK_GrundAbbruch		
source	<pre> <simpleType name="enum_0301"> <annotation> <documentation>Kat_AK_GrundAbbruch</documentation> </annotation> <restriction base="xs:string"> <enumeration value="0301001"> <annotation> <documentation>produktbezogen</documentation> </annotation> </enumeration> <enumeration value="0301002"> <annotation> <documentation>nicht-produktbezogen</documentation> </annotation> </enumeration> </restriction> </simpleType> </pre>		

simpleType enum_0302

namespace	http://xml.ir-d.de/sak		
type	restriction of string		
properties	base xs:string		

facets	<table border="1"> <thead> <tr> <th>Kind</th> <th>Value</th> <th>Annotation</th> </tr> </thead> <tbody> <tr> <td>enumeration</td> <td>0302001</td> <td>documentation Stenose</td> </tr> <tr> <td>enumeration</td> <td>0302002</td> <td>documentation Insuffizienz</td> </tr> <tr> <td>enumeration</td> <td>0302003</td> <td>documentation Stenose und Insuffizienz</td> </tr> <tr> <td>enumeration</td> <td>0302042</td> <td>documentation sonstiger</td> </tr> </tbody> </table>	Kind	Value	Annotation	enumeration	0302001	documentation Stenose	enumeration	0302002	documentation Insuffizienz	enumeration	0302003	documentation Stenose und Insuffizienz	enumeration	0302042	documentation sonstiger
Kind	Value	Annotation														
enumeration	0302001	documentation Stenose														
enumeration	0302002	documentation Insuffizienz														
enumeration	0302003	documentation Stenose und Insuffizienz														
enumeration	0302042	documentation sonstiger														
annotation	documentation Kat_AK_GrundEingriff															
source	<pre> <simpleType name="enum_0302"> <annotation> <documentation>Kat_AK_GrundEingriff</documentation> </annotation> <restriction base="xs:string"> <enumeration value="0302001"> <annotation> <documentation>Stenose</documentation> </annotation> </enumeration> <enumeration value="0302002"> <annotation> <documentation>Insuffizienz</documentation> </annotation> </enumeration> <enumeration value="0302003"> <annotation> <documentation>Stenose und Insuffizienz</documentation> </annotation> </enumeration> <enumeration value="0302042"> <annotation> <documentation>sonstiger</documentation> </annotation> </enumeration> </restriction> </simpleType> </pre>															

simpleType enum_0318

namespace	http://xml.ir-d.de/sak																		
type	restriction of string																		
properties	base xs:string																		
facets	<table border="1"> <thead> <tr> <th>Kind</th> <th>Value</th> <th>Annotation</th> </tr> </thead> <tbody> <tr> <td>enumeration</td> <td>0318001</td> <td>documentation transapikal</td> </tr> <tr> <td>enumeration</td> <td>0318002</td> <td>documentation transaortal</td> </tr> <tr> <td>enumeration</td> <td>0318003</td> <td>documentation transfemoral</td> </tr> <tr> <td>enumeration</td> <td>0318004</td> <td>documentation transaxillär</td> </tr> <tr> <td>enumeration</td> <td>0318042</td> <td>documentation anderer Zugangsweg</td> </tr> </tbody> </table>	Kind	Value	Annotation	enumeration	0318001	documentation transapikal	enumeration	0318002	documentation transaortal	enumeration	0318003	documentation transfemoral	enumeration	0318004	documentation transaxillär	enumeration	0318042	documentation anderer Zugangsweg
Kind	Value	Annotation																	
enumeration	0318001	documentation transapikal																	
enumeration	0318002	documentation transaortal																	
enumeration	0318003	documentation transfemoral																	
enumeration	0318004	documentation transaxillär																	
enumeration	0318042	documentation anderer Zugangsweg																	
annotation	documentation Kat_AK_ZugangKatheter																		

source	<pre> <simpleType name="enum_0318"> <annotation> <documentation>Kat_AK_ZugangKatheter</documentation> </annotation> <restriction base="xs:string"> <enumeration value="0318001"> <annotation> <documentation>transapikal</documentation> </annotation> </enumeration> <enumeration value="0318002"> <annotation> <documentation>transaortal</documentation> </annotation> </enumeration> <enumeration value="0318003"> <annotation> <documentation>transfemorale</documentation> </annotation> </enumeration> <enumeration value="0318004"> <annotation> <documentation>transaxillär</documentation> </annotation> </enumeration> <enumeration value="0318042"> <annotation> <documentation>anderer Zugangsweg</documentation> </annotation> </enumeration> </restriction> </simpleType> </pre>
--------	---

simpleType enum_0320

namespace	http://xml.ir-d.de/sak		
type	restriction of string		
properties	base xs:string		
facets	Kind	Value	Annotation
	enumeration	0320001	documentation konventionelle Sternotomie
	enumeration	0320002	documentation partielle Sternotomie
	enumeration	0320003	documentation parasternaler Zugang
	enumeration	0320042	documentation anderer Zugangsweg
annotation	documentation Kat_AK_ZugangKonventionell		
source	<pre> <simpleType name="enum_0320"> <annotation> <documentation>Kat_AK_ZugangKonventionell</documentation> </annotation> <restriction base="xs:string"> <enumeration value="0320001"> <annotation> <documentation>konventionelle Sternotomie</documentation> </pre>		

	<pre> </annotation> </enumeration> <enumeration value="0320002"> <annotation> <documentation>partielle Sternotomie</documentation> </annotation> </enumeration> <enumeration value="0320003"> <annotation> <documentation>parasternaler Zugang</documentation> </annotation> </enumeration> <enumeration value="0320042"> <annotation> <documentation>anderer Zugangsweg</documentation> </annotation> </enumeration> </restriction> </simpleType> </pre>
--	---

simpleType enum 0322

namespace	http://xml.ir-d.de/sak		
type	restriction of string		
properties	base xs:string		
facets	Kind	Value	Annotation
	enumeration	0322001	documentation nein
	enumeration	0322002	documentation ja, diätetisch behandelt
	enumeration	0322003	documentation ja, orale Medikation
	enumeration	0322004	documentation ja, mit Insulin behandelt
	enumeration	0322005	documentation ja, unbehandelt
	enumeration	0322099	documentation unbekannt
annotation	documentation Kat_AK_Diabetes		
source	<pre> <simpleType name="enum_0322"> <annotation> <documentation>Kat_AK_Diabetes</documentation> </annotation> <restriction base="xs:string"> <enumeration value="0322001"> <annotation> <documentation>nein</documentation> </annotation> </enumeration> <enumeration value="0322002"> <annotation> <documentation>ja, diätetisch behandelt</documentation> </annotation> </enumeration> <enumeration value="0322003"> <annotation> </pre>		

	<pre> <documentation>ja, orale Medikation</documentation> </annotation> </enumeration> <enumeration value="0322004"> <annotation> <documentation>ja, mit Insulin behandelt</documentation> </annotation> </enumeration> <enumeration value="0322005"> <annotation> <documentation>ja, unbehandelt</documentation> </annotation> </enumeration> <enumeration value="0322099"> <annotation> <documentation>unbekannt</documentation> </annotation> </enumeration> </restriction> </simpleType> </pre>
--	---

simpleType enum_0324

namespace	http://xml.ir-d.de/sak		
type	restriction of string		
properties	base xs:string		
facets	Kind	Value	Annotation
	enumeration	0324001	documentation (I): Beschwerdefreiheit, normale körperliche Belastbarkeit
	enumeration	0324002	documentation (II): Beschwerden bei stärkerer körperlicher Belastung
	enumeration	0324003	documentation (III): Beschwerden bei leichter körperlicher Belastung
	enumeration	0324004	documentation (IV): Beschwerden in Ruhe
annotation	documentation Kat_AK_NYHA		
source	<pre> <simpleType name="enum_0324"> <annotation> <documentation>Kat_AK_NYHA</documentation> </annotation> <restriction base="xs:string"> <enumeration value="0324001"> <annotation> <documentation>(I): Beschwerdefreiheit, normale körperliche Belastbarkeit</documentation> </annotation> </enumeration> <enumeration value="0324002"> <annotation> <documentation>(II): Beschwerden bei stärkerer körperlicher Belastung</documentation> </annotation> </enumeration> <enumeration value="0324003"> <annotation> <documentation>(III): Beschwerden bei leichter körperlicher </pre>		

	<pre> Belastung</documentation> </annotation> </enumeration> <enumeration value="0324004"> <annotation> <documentation>(IV): Beschwerden in Ruhe</documentation> </annotation> </enumeration> </restriction> </simpleType> </pre>
--	---

simpleType enum_0338

namespace	http://xml.ir-d.de/sak		
type	restriction of string		
properties	base xs:string		
facets	Kind	Value	Annotation
	enumeration	0338001	documentation LAD
	enumeration	0338002	documentation RCA
	enumeration	0338003	documentation RCX
	enumeration	0338004	documentation Hauptstamm
annotation	documentation Kat_AK_PCIArterien		
source	<pre> <simpleType name="enum_0338"> <annotation> <documentation>Kat_AK_PCIArterien</documentation> </annotation> <restriction base="xs:string"> <enumeration value="0338001"> <annotation> <documentation>LAD</documentation> </annotation> </enumeration> <enumeration value="0338002"> <annotation> <documentation>RCA</documentation> </annotation> </enumeration> <enumeration value="0338003"> <annotation> <documentation>RCX</documentation> </annotation> </enumeration> <enumeration value="0338004"> <annotation> <documentation>Hauptstamm</documentation> </annotation> </enumeration> </restriction> </simpleType> </pre>		

simpleType enum_0339

namespace	http://xml.ir-d.de/sak		
type	restriction of string		
properties	base xs:string		
facets	Kind	Value	Annotation
	enumeration	0339001	documentation TEE
	enumeration	0339002	documentation CT
	enumeration	0339042	documentation andere
annotation	documentation Kat_AK_AnnulusMessmethode		
source	<pre> <simpleType name="enum_0339"> <annotation> <documentation>Kat_AK_AnnulusMessmethode</documentation> </annotation> <restriction base="xs:string"> <enumeration value="0339001"> <annotation> <documentation>TEE</documentation> </annotation> </enumeration> <enumeration value="0339002"> <annotation> <documentation>CT</documentation> </annotation> </enumeration> <enumeration value="0339042"> <annotation> <documentation>andere</documentation> </annotation> </enumeration> </restriction> </simpleType> </pre>		

simpleType enum_0341

namespace	http://xml.ir-d.de/sak		
type	restriction of string		
properties	base xs:string		
facets	Kind	Value	Annotation
	enumeration	0341001	documentation intraprozedural verstorben
	enumeration	0341002	documentation Implantation von mehr als einer Prothese
	enumeration	0341003	documentation gravierende Gefäß- oder Zugangskomplikation (gemäß VARC-3)
	enumeration	0341004	documentation erforderlicher chirurgischer oder interventioneller Eingriff wegen einer Klappenfehlfunktion (gemäß VARC-3)
	enumeration	0341005	documentation >= große strukturelle kardiale Komplikation (gemäß VARC-3)
annotation	documentation Kat_AK_FailureGrund		

source	<pre> <simpleType name="enum_0341"> <annotation> <documentation>Kat_AK_FailureGrund</documentation> </annotation> <restriction base="xs:string"> <enumeration value="0341001"> <annotation> <documentation>intraprozedural verstorben</documentation> </annotation> </enumeration> <enumeration value="0341002"> <annotation> <documentation>Implantation von mehr als einer Prothese</documentation> </annotation> </enumeration> <enumeration value="0341003"> <annotation> <documentation>gravierende Gefäß- oder Zugangskomplikation (gemäß VARC-3)</documentation> </annotation> </enumeration> <enumeration value="0341004"> <annotation> <documentation>erforderlicher chirurgischer oder interventioneller Eingriff wegen einer Klappenfehlfunktion (gemäß VARC-3)</documentation> </annotation> </enumeration> <enumeration value="0341005"> <annotation> <documentation>&gt;= große strukturelle kardiale Komplikation (gemäß VARC-3)</documentation> </annotation> </enumeration> </restriction> </simpleType> </pre>
--------	--

simpleType enum_0342

namespace	http://xml.ir-d.de/sak		
type	restriction of string		
properties	base xs:string		
facets	Kind	Value	Annotation
	enumeration	0342001	documentation Alter
	enumeration	0342002	documentation Frailty
	enumeration	0342003	documentation Hochrisiko
	enumeration	0342004	documentation Prognose-limitierende Zweiterkrankung
	enumeration	0342005	documentation Porzellan-Aorta
	enumeration	0342042	documentation sonstiger
annotation	documentation Kat_AK_Tavi		

source	<pre> <simpleType name="enum_0342"> <annotation> <documentation>Kat_AK_Tavi</documentation> </annotation> <restriction base="xs:string"> <enumeration value="0342001"> <annotation> <documentation>Alter</documentation> </annotation> </enumeration> <enumeration value="0342002"> <annotation> <documentation>Frailty</documentation> </annotation> </enumeration> <enumeration value="0342003"> <annotation> <documentation>Hochrisiko</documentation> </annotation> </enumeration> <enumeration value="0342004"> <annotation> <documentation>Prognose-limitierende Zweiterkrankung</documentation> </annotation> </enumeration> <enumeration value="0342005"> <annotation> <documentation>Porzellan-Aorta</documentation> </annotation> </enumeration> <enumeration value="0342042"> <annotation> <documentation>sonstiger</documentation> </annotation> </enumeration> </restriction> </simpleType> </pre>
--------	---

simpleType enum_0343

namespace	http://xml.ir-d.de/sak		
type	restriction of string		
properties	base xs:string		
facets	Kind	Value	Annotation
	enumeration	0343001	documentation Device-Fehlpositionierung
	enumeration	0343002	documentation Koronarostienverschluss
	enumeration	0343003	documentation Aortendissektion
	enumeration	0343004	documentation Aortenregurgitation > = 2. Grades
	enumeration	0343005	documentation Annulus-Ruptur
	enumeration	0343006	documentation Ruptur-/Perforation einer Herzhöhle ohne Therapiebedarf
	enumeration	0343007	documentation

	<p>enumeration 0343008 Ruptur-/Perforation einer Herzhöhle mit Therapiebedarf documentation Perikardtamponade</p> <p>enumeration 0343009 documentation kardiale Dekompensation</p> <p>enumeration 0343010 documentation Hirnembolie</p> <p>enumeration 0343011 documentation Rhythmusstörungen</p> <p>enumeration 0343012 documentation Device-Embolisation</p> <p>enumeration 0343013 documentation vaskuläre Komplikation</p> <p>enumeration 0343014 documentation Low Cardiac Output</p> <p>enumeration 0343015 documentation schwerwiegende Blutungen (intraprozedural)</p> <p>enumeration 0343016 documentation lebensbedrohliche Blutungen (intraprozedural)</p> <p>enumeration 0343017 documentation Patient verstarb im OP/Katheterlabor</p> <p>enumeration 0343042 documentation sonstiger</p>
annotation	documentation Kat_AK_KomplikationTyp
source	<pre> <simpleType name="enum_0343"> <annotation> <documentation>Kat_AK_KomplikationTyp</documentation> </annotation> <restriction base="xs:string"> <enumeration value="0343001"> <annotation> <documentation>Device-Fehlpositionierung</documentation> </annotation> </enumeration> <enumeration value="0343002"> <annotation> <documentation>Koronarostienverschluss</documentation> </annotation> </enumeration> <enumeration value="0343003"> <annotation> <documentation>Aortendissektion</documentation> </annotation> </enumeration> <enumeration value="0343004"> <annotation> <documentation>Aortenregurgitation &gt; = 2. Grades</documentation> </annotation> </enumeration> <enumeration value="0343005"> <annotation> <documentation>Annulus-Ruptur</documentation> </annotation> </enumeration> <enumeration value="0343006"> <annotation> <documentation>Ruptur-/Perforation einer Herzhöhle ohne Therapiebedarf</documentation> </annotation> </enumeration> </restriction> </simpleType> </pre>

```

<enumeration value="0343007">
  <annotation>
    <documentation>Ruptur-/Perforation einer Herzhöhle mit
Therapiebedarf</documentation>
  </annotation>
</enumeration>
<enumeration value="0343008">
  <annotation>
    <documentation>Perikardtamponade</documentation>
  </annotation>
</enumeration>
<enumeration value="0343009">
  <annotation>
    <documentation>kardiale Dekompensation</documentation>
  </annotation>
</enumeration>
<enumeration value="0343010">
  <annotation>
    <documentation>Hirnembolie</documentation>
  </annotation>
</enumeration>
<enumeration value="0343011">
  <annotation>
    <documentation>Rhythmusstörungen</documentation>
  </annotation>
</enumeration>
<enumeration value="0343012">
  <annotation>
    <documentation>Device-Embolisation</documentation>
  </annotation>
</enumeration>
<enumeration value="0343013">
  <annotation>
    <documentation>vaskuläre Komplikation</documentation>
  </annotation>
</enumeration>
<enumeration value="0343014">
  <annotation>
    <documentation>Low Cardiac Output</documentation>
  </annotation>
</enumeration>
<enumeration value="0343015">
  <annotation>
    <documentation>schwerwiegende Blutungen
(intraprozedural)</documentation>
  </annotation>
</enumeration>
<enumeration value="0343016">
  <annotation>
    <documentation>lebensbedrohliche Blutungen
(intraprozedural)</documentation>
  </annotation>
</enumeration>
<enumeration value="0343017">
  <annotation>
    <documentation>Patient verstarb im OP/Katheterlabor</documentation>
  </annotation>
</enumeration>
<enumeration value="0343042">

```

	<pre> <annotation> <documentation>sonstiger</documentation> </annotation> </enumeration> </restriction> </simpleType> </pre>
--	--

simpleType enum_0346

namespace	http://xml.ir-d.de/sak		
type	restriction of string		
properties	base xs:string		
facets	Kind	Value	Annotation
	enumeration	0346001	documentation keine Therapie erforderlich
	enumeration	0346002	documentation medikamentös
	enumeration	0346003	documentation IABP
	enumeration	0346004	documentation VAD
	enumeration	0346005	documentation ECMO
	enumeration	0346042	documentation sonstige
annotation	documentation Kat AK TherapieLCO		
source	<pre> <simpleType name="enum_0346"> <annotation> <documentation>Kat_AK_TherapieLCO</documentation> </annotation> <restriction base="xs:string"> <enumeration value="0346001"> <annotation> <documentation>keine Therapie erforderlich</documentation> </annotation> </enumeration> <enumeration value="0346002"> <annotation> <documentation>medikamentös</documentation> </annotation> </enumeration> <enumeration value="0346003"> <annotation> <documentation>IABP</documentation> </annotation> </enumeration> <enumeration value="0346004"> <annotation> <documentation>VAD</documentation> </annotation> </enumeration> <enumeration value="0346005"> <annotation> <documentation>ECMO</documentation> </annotation> </enumeration> </restriction> </simpleType> </pre>		

	<pre> <enumeration value="0346042"> <annotation> <documentation>sonstige</documentation> </annotation> </enumeration> </restriction> </simpleType> </pre>
--	---

simpleType enum_0347

namespace	http://xml.ir-d.de/sak		
type	restriction of string		
properties	base xs:string		
facets	Kind	Value	Annotation
	enumeration	0347001	documentation Einzeleingriff
	enumeration	0347002	documentation Kombinationseingriff mit mehreren Prozeduren
annotation	documentation Kat_AK_Eingriffsumfang		
source	<pre> <simpleType name="enum_0347"> <annotation> <documentation>Kat_AK_Eingriffsumfang</documentation> </annotation> <restriction base="xs:string"> <enumeration value="0347001"> <annotation> <documentation>Einzeleingriff</documentation> </annotation> </enumeration> <enumeration value="0347002"> <annotation> <documentation>Kombinationseingriff mit mehreren Prozeduren</documentation> </annotation> </enumeration> </restriction> </simpleType> </pre>		

simpleType enum_0348

namespace	http://xml.ir-d.de/sak		
type	restriction of string		
properties	base xs:string		
facets	Kind	Value	Annotation
	enumeration	0348001	documentation mit HLM
	enumeration	0348002	documentation ohne HLM
	enumeration	0348003	documentation Umstieg von OP ohne HLM auf OP mit HLM
annotation	documentation Kat_AK_OPVorgehen		
source	<pre> <simpleType name="enum_0348"> </pre>		

	<pre> <annotation> <documentation>Kat_AK_OPVorgehen</documentation> </annotation> <restriction base="xs:string"> <enumeration value="0348001"> <annotation> <documentation>mit HLM</documentation> </annotation> </enumeration> <enumeration value="0348002"> <annotation> <documentation>ohne HLM</documentation> </annotation> </enumeration> <enumeration value="0348003"> <annotation> <documentation>Umstieg von OP ohne HLM auf OP mit HLM</documentation> </annotation> </enumeration> </restriction> </simpleType> </pre>
--	---

simpleType enum 0350

namespace	http://xml.ir-d.de/sak		
type	restriction of string		
properties	base xs:string		
facets	Kind	Value	Annotation
	enumeration	0350001	documentation IABP
	enumeration	0350002	documentation Impella
	enumeration	0350003	documentation vv ECMO
	enumeration	0350004	documentation va ECMO
	enumeration	0350042	documentation andere
annotation	documentation Kat_AK_Methode		
source	<pre> <simpleType name="enum_0350"> <annotation> <documentation>Kat_AK_Methode</documentation> </annotation> <restriction base="xs:string"> <enumeration value="0350001"> <annotation> <documentation>IABP</documentation> </annotation> </enumeration> <enumeration value="0350002"> <annotation> <documentation>Impella</documentation> </annotation> </enumeration> <enumeration value="0350003"> <annotation> </pre>		

	<pre> <documentation>vv ECMO</documentation> </annotation> </enumeration> <enumeration value="0350004"> <annotation> <documentation>va ECMO</documentation> </annotation> </enumeration> <enumeration value="0350042"> <annotation> <documentation>andere</documentation> </annotation> </enumeration> </restriction> </simpleType> </pre>
--	--

simpleType enum_0351

namespace	http://xml.ir-d.de/sak		
type	restriction of string		
properties	base xs:string		
facets	Kind	Value	Annotation
	enumeration	0351001	documentation nein
	enumeration	0351002	documentation ja, zu Sternotomie
	enumeration	0351003	documentation ja, zu transapikal
	enumeration	0351004	documentation ja, zu transaortal
	enumeration	0351005	documentation ja, zu transfemoral
	enumeration	0351006	documentation ja, zu transaxillär
	enumeration	0351007	documentation ja, zu anderem endovaskulären Zugang
	enumeration	0351042	documentation ja, zu anderem Zugang
annotation	documentation Kat_AK_Konversion		
source	<pre> <simpleType name="enum_0351"> <annotation> <documentation>Kat_AK_Konversion</documentation> </annotation> <restriction base="xs:string"> <enumeration value="0351001"> <annotation> <documentation>nein</documentation> </annotation> </enumeration> <enumeration value="0351002"> <annotation> <documentation>ja, zu Sternotomie</documentation> </annotation> </enumeration> <enumeration value="0351003"> <annotation> <documentation>ja, zu transapikal</documentation> </pre>		

	<pre> </annotation> </enumeration> <enumeration value="0351004"> <annotation> <documentation>ja, zu transaortal</documentation> </annotation> </enumeration> <enumeration value="0351005"> <annotation> <documentation>ja, zu transfemoral</documentation> </annotation> </enumeration> <enumeration value="0351006"> <annotation> <documentation>ja, zu transaxillär</documentation> </annotation> </enumeration> <enumeration value="0351007"> <annotation> <documentation>ja, zu anderem endovaskulären Zugang</documentation> </annotation> </enumeration> <enumeration value="0351042"> <annotation> <documentation>ja, zu anderem Zugang</documentation> </annotation> </enumeration> </restriction> </simpleType> </pre>
--	---

simpleType enum_0352

namespace	http://xml.ir-d.de/sak		
type	restriction of string		
properties	base xs:string		
facets	Kind	Value	Annotation
	enumeration	0352001	documentation nein
	enumeration	0352002	documentation ja, Intubationsnarkose
	enumeration	0352003	documentation ja, Maskenbeatmung, incl. LAMA
	enumeration	0352042	documentation ja, unbekannt welche
annotation	documentation Kat_AK_Anaesthesie		
source	<pre> <simpleType name="enum_0352"> <annotation> <documentation>Kat_AK_Anaesthesie</documentation> </annotation> <restriction base="xs:string"> <enumeration value="0352001"> <annotation> <documentation>nein</documentation> </annotation> </enumeration> <enumeration value="0352002"> </pre>		

	<pre> <annotation> <documentation>ja, Intubationsnarkose</documentation> </annotation> </enumeration> <enumeration value="0352003"> <annotation> <documentation>ja, Maskenbeatmung, incl. LAMA</documentation> </annotation> </enumeration> <enumeration value="0352042"> <annotation> <documentation>ja, unbekannt welche</documentation> </annotation> </enumeration> </restriction> </simpleType> </pre>
--	---

simpleType enum 0353

namespace	http://xml.ir-d.de/sak		
type	restriction of string		
properties	base xs:string		
facets	Kind	Value	Annotation
	enumeration	0353001	documentation keine
	enumeration	0353002	documentation leichtgradig
	enumeration	0353003	documentation mittelgradig
	enumeration	0353004	documentation hochgradig
	enumeration	0353099	documentation nicht bestimmbar
annotation	documentation Kat_AK_ResidualeArteninsuffizienz		
source	<pre> <simpleType name="enum_0353"> <annotation> <documentation>Kat_AK_ResidualeArteninsuffizienz</documentation> </annotation> <restriction base="xs:string"> <enumeration value="0353001"> <annotation> <documentation>keine</documentation> </annotation> </enumeration> <enumeration value="0353002"> <annotation> <documentation>leichtgradig</documentation> </annotation> </enumeration> <enumeration value="0353003"> <annotation> <documentation>mittelgradig</documentation> </annotation> </enumeration> <enumeration value="0353004"> <annotation> </pre>		

	<pre> <documentation>hochgradig</documentation> </annotation> </enumeration> <enumeration value="0353099"> <annotation> <documentation>nicht bestimmbar</documentation> </annotation> </enumeration> </restriction> </simpleType> </pre>
--	--

simpleType enum_0354

namespace	http://xml.ir-d.de/sak		
type	restriction of string		
properties	base xs:string		
facets	Kind	Value	Annotation
	enumeration	0354001	documentation chirurgisch-offen
	enumeration	0354002	documentation Verschluss-System
	enumeration	0354042	documentation sonstiger
annotation	documentation Kat_AK_Zugangswegverschluss		
source	<pre> <simpleType name="enum_0354"> <annotation> <documentation>Kat_AK_Zugangswegverschluss</documentation> </annotation> <restriction base="xs:string"> <enumeration value="0354001"> <annotation> <documentation>chirurgisch-offen</documentation> </annotation> </enumeration> <enumeration value="0354002"> <annotation> <documentation>Verschluss-System</documentation> </annotation> </enumeration> <enumeration value="0354042"> <annotation> <documentation>sonstiger</documentation> </annotation> </enumeration> </restriction> </simpleType> </pre>		

simpleType enum_0357

namespace	http://xml.ir-d.de/sak		
type	restriction of string		
properties	base xs:string		

facets	<table border="1"> <thead> <tr> <th>Kind</th> <th>Value</th> <th>Annotation</th> </tr> </thead> <tbody> <tr> <td>enumeration</td> <td>0357001</td> <td>documentation keine KHK</td> </tr> <tr> <td>enumeration</td> <td>0357002</td> <td>documentation 1-Gefäßerkrankung</td> </tr> <tr> <td>enumeration</td> <td>0357003</td> <td>documentation 2-Gefäßerkrankung</td> </tr> <tr> <td>enumeration</td> <td>0357004</td> <td>documentation 3-Gefäßerkrankung</td> </tr> <tr> <td>enumeration</td> <td>0357005</td> <td>documentation keine koronare Bildgebung</td> </tr> </tbody> </table>	Kind	Value	Annotation	enumeration	0357001	documentation keine KHK	enumeration	0357002	documentation 1-Gefäßerkrankung	enumeration	0357003	documentation 2-Gefäßerkrankung	enumeration	0357004	documentation 3-Gefäßerkrankung	enumeration	0357005	documentation keine koronare Bildgebung
Kind	Value	Annotation																	
enumeration	0357001	documentation keine KHK																	
enumeration	0357002	documentation 1-Gefäßerkrankung																	
enumeration	0357003	documentation 2-Gefäßerkrankung																	
enumeration	0357004	documentation 3-Gefäßerkrankung																	
enumeration	0357005	documentation keine koronare Bildgebung																	
annotation	documentation Kat AK BefundBildgebung																		
source	<pre> <simpleType name="enum_0357"> <annotation> <documentation>Kat_AK_BefundBildgebung</documentation> </annotation> <restriction base="xs:string"> <enumeration value="0357001"> <annotation> <documentation>keine KHK</documentation> </annotation> </enumeration> <enumeration value="0357002"> <annotation> <documentation>1-Gefäßerkrankung</documentation> </annotation> </enumeration> <enumeration value="0357003"> <annotation> <documentation>2-Gefäßerkrankung</documentation> </annotation> </enumeration> <enumeration value="0357004"> <annotation> <documentation>3-Gefäßerkrankung</documentation> </annotation> </enumeration> <enumeration value="0357005"> <annotation> <documentation>keine koronare Bildgebung</documentation> </annotation> </enumeration> </restriction> </simpleType> </pre>																		

simpleType enum_0358

namespace	http://xml.ir-d.de/sak												
type	restriction of string												
properties	base xs:string												
facets	<table border="1"> <thead> <tr> <th>Kind</th> <th>Value</th> <th>Annotation</th> </tr> </thead> <tbody> <tr> <td>enumeration</td> <td>0358001</td> <td>documentation 0</td> </tr> <tr> <td>enumeration</td> <td>0358002</td> <td>documentation 1</td> </tr> <tr> <td>enumeration</td> <td>0358003</td> <td>documentation 2</td> </tr> </tbody> </table>	Kind	Value	Annotation	enumeration	0358001	documentation 0	enumeration	0358002	documentation 1	enumeration	0358003	documentation 2
Kind	Value	Annotation											
enumeration	0358001	documentation 0											
enumeration	0358002	documentation 1											
enumeration	0358003	documentation 2											

	enumeration 0358004 documentation 3 enumeration 0358005 documentation 4 enumeration 0358006 documentation 5 oder mehr enumeration 0358098 documentation genaue Anzahl unbekannt (aber mind. 1) enumeration 0358099 documentation unbekannt
annotation	documentation Kat_AK_AnzahlVorOP
source	<pre> <simpleType name="enum_0358"> <annotation> <documentation>Kat_AK_AnzahlVorOP</documentation> </annotation> <restriction base="xs:string"> <enumeration value="0358001"> <annotation> <documentation>0</documentation> </annotation> </enumeration> <enumeration value="0358002"> <annotation> <documentation>1</documentation> </annotation> </enumeration> <enumeration value="0358003"> <annotation> <documentation>2</documentation> </annotation> </enumeration> <enumeration value="0358004"> <annotation> <documentation>3</documentation> </annotation> </enumeration> <enumeration value="0358005"> <annotation> <documentation>4</documentation> </annotation> </enumeration> <enumeration value="0358006"> <annotation> <documentation>5 oder mehr</documentation> </annotation> </enumeration> <enumeration value="0358098"> <annotation> <documentation>genaue Anzahl unbekannt (aber mind. 1)</documentation> </annotation> </enumeration> <enumeration value="0358099"> <annotation> <documentation>unbekannt</documentation> </annotation> </enumeration> </restriction> </simpleType> </pre>

simpleType enum 0359

namespace	http://xml.ir-d.de/sak		
type	restriction of string		
properties	base xs:string		
facets	Kind	Value	Annotation
	enumeration	0359001	documentation nein
	enumeration	0359002	documentation ja - einseitig
	enumeration	0359003	documentation ja - beidseitig
	enumeration	0359042	documentation unbekannt
annotation	documentation Kat AK LVOT		
source	<pre> <simpleType name="enum_0359"> <annotation> <documentation>Kat_AK_LVOT</documentation> </annotation> <restriction base="xs:string"> <enumeration value="0359001"> <annotation> <documentation>nein</documentation> </annotation> </enumeration> <enumeration value="0359002"> <annotation> <documentation>ja - einseitig</documentation> </annotation> </enumeration> <enumeration value="0359003"> <annotation> <documentation>ja - beidseitig</documentation> </annotation> </enumeration> <enumeration value="0359042"> <annotation> <documentation>unbekannt</documentation> </annotation> </enumeration> </restriction> </simpleType> </pre>		

simpleType enum 0360

namespace	http://xml.ir-d.de/sak		
type	restriction of string		
properties	base xs:string		
facets	Kind	Value	Annotation
	enumeration	0360001	documentation keine
	enumeration	0360002	documentation leichtgradig

	enumeration 0360003 documentation mittelgradig enumeration 0360004 documentation hochgradig enumeration 0360005 documentation massive enumeration 0360006 documentation torrential enumeration 0360099 documentation unbekannt
annotation	documentation Kat_AK_TriskupidalInsuffizienz
source	<pre> <simpleType name="enum_0360"> <annotation> <documentation>Kat_AK_TriskupidalInsuffizienz</documentation> </annotation> <restriction base="xs:string"> <enumeration value="0360001"> <annotation> <documentation>keine</documentation> </annotation> </enumeration> <enumeration value="0360002"> <annotation> <documentation>leichtgradig</documentation> </annotation> </enumeration> <enumeration value="0360003"> <annotation> <documentation>mittelgradig</documentation> </annotation> </enumeration> <enumeration value="0360004"> <annotation> <documentation>hochgradig</documentation> </annotation> </enumeration> <enumeration value="0360005"> <annotation> <documentation>massive</documentation> </annotation> </enumeration> <enumeration value="0360006"> <annotation> <documentation>torrential</documentation> </annotation> </enumeration> <enumeration value="0360099"> <annotation> <documentation>unbekannt</documentation> </annotation> </enumeration> </restriction> </simpleType> </pre>

simpleType enum_0361

namespace	http://xml.ir-d.de/sak
-----------	------------------------

type	restriction of string																					
properties	base xs:string																					
facets	<table border="1"> <thead> <tr> <th>Kind</th> <th>Value</th> <th>Annotation</th> </tr> </thead> <tbody> <tr> <td>enumeration</td> <td>0361001</td> <td>documentation nein</td> </tr> <tr> <td>enumeration</td> <td>0361002</td> <td>documentation ja, letzte(r) innerhalb der letzten 48 Stunden</td> </tr> <tr> <td>enumeration</td> <td>0361003</td> <td>documentation ja, letzte(r) innerhalb der letzten 21 Tage</td> </tr> <tr> <td>enumeration</td> <td>0361004</td> <td>documentation ja, letzte(r) länger als 21 Tage</td> </tr> <tr> <td>enumeration</td> <td>0361098</td> <td>documentation ja, letzter Zeitpunkt unbekannt</td> </tr> <tr> <td>enumeration</td> <td>0361099</td> <td>documentation unbekannt</td> </tr> </tbody> </table>	Kind	Value	Annotation	enumeration	0361001	documentation nein	enumeration	0361002	documentation ja, letzte(r) innerhalb der letzten 48 Stunden	enumeration	0361003	documentation ja, letzte(r) innerhalb der letzten 21 Tage	enumeration	0361004	documentation ja, letzte(r) länger als 21 Tage	enumeration	0361098	documentation ja, letzter Zeitpunkt unbekannt	enumeration	0361099	documentation unbekannt
Kind	Value	Annotation																				
enumeration	0361001	documentation nein																				
enumeration	0361002	documentation ja, letzte(r) innerhalb der letzten 48 Stunden																				
enumeration	0361003	documentation ja, letzte(r) innerhalb der letzten 21 Tage																				
enumeration	0361004	documentation ja, letzte(r) länger als 21 Tage																				
enumeration	0361098	documentation ja, letzter Zeitpunkt unbekannt																				
enumeration	0361099	documentation unbekannt																				
annotation	documentation Kat AK SchockReanimation																					
source	<pre> <simpleType name="enum_0361"> <annotation> <documentation>Kat_AK_SchockReanimation</documentation> </annotation> <restriction base="xs:string"> <enumeration value="0361001"> <annotation> <documentation>nein</documentation> </annotation> </enumeration> <enumeration value="0361002"> <annotation> <documentation>ja, letzte(r) innerhalb der letzten 48 Stunden</documentation> </annotation> </enumeration> <enumeration value="0361003"> <annotation> <documentation>ja, letzte(r) innerhalb der letzten 21 Tage</documentation> </annotation> </enumeration> <enumeration value="0361004"> <annotation> <documentation>ja, letzte(r) länger als 21 Tage</documentation> </annotation> </enumeration> <enumeration value="0361098"> <annotation> <documentation>ja, letzter Zeitpunkt unbekannt</documentation> </annotation> </enumeration> <enumeration value="0361099"> <annotation> <documentation>unbekannt</documentation> </annotation> </enumeration> </restriction> </simpleType> </pre>																					

simpleType enum_0362

namespace	http://xml.ir-d.de/sak		
type	restriction of string		
properties	base xs:string		
facets	Kind	Value	Annotation
	enumeration	0362001	documentation Sinusrhythmus
	enumeration	0362002	documentation Vorhofflimmern
	enumeration	0362042	documentation anderer Herzrhythmus
annotation	documentation Kat_AK_Herzrhythmus		
source	<pre> <simpleType name="enum_0362"> <annotation> <documentation>Kat_AK_Herzrhythmus</documentation> </annotation> <restriction base="xs:string"> <enumeration value="0362001"> <annotation> <documentation>Sinusrhythmus</documentation> </annotation> </enumeration> <enumeration value="0362002"> <annotation> <documentation>Vorhofflimmern</documentation> </annotation> </enumeration> <enumeration value="0362042"> <annotation> <documentation>anderer Herzrhythmus</documentation> </annotation> </enumeration> </restriction> </simpleType> </pre>		

simpleType enum_0363

namespace	http://xml.ir-d.de/sak		
type	restriction of string		
properties	base xs:string		
facets	Kind	Value	Annotation
	enumeration	0363001	documentation nein
	enumeration	0363002	documentation paroxysmal
	enumeration	0363003	documentation persistierend
	enumeration	0363004	documentation permanent
annotation	documentation Kat_AK_Vorhofflimmern		
source	<pre> <simpleType name="enum_0363"> <annotation> <documentation>Kat AK Vorhofflimmern</documentation> </annotation> </pre>		

	<pre> </annotation> <restriction base="xs:string"> <enumeration value="0363001"> <annotation> <documentation>nein</documentation> </annotation> </enumeration> <enumeration value="0363002"> <annotation> <documentation>paroxysmal</documentation> </annotation> </enumeration> <enumeration value="0363003"> <annotation> <documentation>persistierend</documentation> </annotation> </enumeration> <enumeration value="0363004"> <annotation> <documentation>permanent</documentation> </annotation> </enumeration> </restriction> </simpleType> </pre>
--	--

simpleType enum_0364

namespace	http://xml.ir-d.de/sak		
type	restriction of string		
properties	base xs:string		
facets	Kind	Value	Annotation
	enumeration	0364001	documentation nein
	enumeration	0364002	documentation Schrittmacher ohne CRT-System
	enumeration	0364003	documentation Schrittmacher mit CRT-System
	enumeration	0364004	documentation Defibrillator ohne CRT-System
	enumeration	0364005	documentation Defibrillator mit CRT-System
annotation	documentation Kat_AK_SchrittmacherDefi		
source	<pre> <simpleType name="enum_0364"> <annotation> <documentation>Kat_AK_SchrittmacherDefi</documentation> </annotation> <restriction base="xs:string"> <enumeration value="0364001"> <annotation> <documentation>nein</documentation> </annotation> </enumeration> <enumeration value="0364002"> <annotation> <documentation>Schrittmacher ohne CRT-System</documentation> </annotation> </enumeration> </restriction> </simpleType> </pre>		

	<pre> </enumeration> <enumeration value="0364003"> <annotation> <documentation>Schrittmacher mit CRT-System</documentation> </annotation> </enumeration> <enumeration value="0364004"> <annotation> <documentation>Defibrillator ohne CRT-System</documentation> </annotation> </enumeration> <enumeration value="0364005"> <annotation> <documentation>Defibrillator mit CRT-System</documentation> </annotation> </enumeration> </restriction> </simpleType> </pre>
--	---

simpleType enum_0365

namespace	http://xml.ir-d.de/sak		
type	restriction of string		
properties	base xs:string		
facets	Kind	Value	Annotation
	enumeration	0365001	documentation nein
	enumeration	0365002	documentation ja, operativ
	enumeration	0365003	documentation ja, interventionell
annotation	documentation Kat AK MyokardRevaskularisation		
source	<pre> <simpleType name="enum_0365"> <annotation> <documentation>Kat_AK_MyokardRevaskularisation</documentation> </annotation> <restriction base="xs:string"> <enumeration value="0365001"> <annotation> <documentation>nein</documentation> </annotation> </enumeration> <enumeration value="0365002"> <annotation> <documentation>ja, operativ</documentation> </annotation> </enumeration> <enumeration value="0365003"> <annotation> <documentation>ja, interventionell</documentation> </annotation> </enumeration> </restriction> </simpleType> </pre>		

simpleType enum_0366

namespace	http://xml.ir-d.de/sak		
type	restriction of string		
properties	base xs:string		
facets	Kind	Value	Annotation
	enumeration	0366001	documentation nein
	enumeration	0366002	documentation ja, <= 6 Stunden
	enumeration	0366003	documentation ja, > 6 Stunden bis <= 3 Monate
	enumeration	0366004	documentation ja, > 3 Monate
	enumeration	0366099	documentation unbekannt
annotation	documentation Kat_AK_PCI		
source	<pre> <simpleType name="enum_0366"> <annotation> <documentation>Kat_AK_PCI</documentation> </annotation> <restriction base="xs:string"> <enumeration value="0366001"> <annotation> <documentation>nein</documentation> </annotation> </enumeration> <enumeration value="0366002"> <annotation> <documentation>ja, &lt;= 6 Stunden</documentation> </annotation> </enumeration> <enumeration value="0366003"> <annotation> <documentation>ja, &gt; 6 Stunden bis &lt;= 3 Monate</documentation> </annotation> </enumeration> <enumeration value="0366004"> <annotation> <documentation>ja, &gt; 3 Monate</documentation> </annotation> </enumeration> <enumeration value="0366099"> <annotation> <documentation>unbekannt</documentation> </annotation> </enumeration> </restriction> </simpleType> </pre>		

simpleType enum_0367

namespace	http://xml.ir-d.de/sak
type	restriction of string

properties	base xs:string																																																			
facets	<table border="1"> <thead> <tr> <th>Kind</th> <th>Value</th> <th>Annotation</th> </tr> </thead> <tbody> <tr> <td>enumeration</td> <td>0367001</td> <td>documentation keine</td> </tr> <tr> <td>enumeration</td> <td>0367002</td> <td>documentation Mediastinitis</td> </tr> <tr> <td>enumeration</td> <td>0367003</td> <td>documentation Sepsis</td> </tr> <tr> <td>enumeration</td> <td>0367004</td> <td>documentation broncho-pulmonale Infektion</td> </tr> <tr> <td>enumeration</td> <td>0367005</td> <td>documentation oto-laryngologische Infektion</td> </tr> <tr> <td>enumeration</td> <td>0367006</td> <td>documentation floride Endokarditis</td> </tr> <tr> <td>enumeration</td> <td>0367007</td> <td>documentation Peritonitis</td> </tr> <tr> <td>enumeration</td> <td>0367008</td> <td>documentation Wundinfektion Thorax</td> </tr> <tr> <td>enumeration</td> <td>0367009</td> <td>documentation Pleuraempyem</td> </tr> <tr> <td>enumeration</td> <td>0367010</td> <td>documentation Venenkatheterinfektion</td> </tr> <tr> <td>enumeration</td> <td>0367011</td> <td>documentation Harnwegsinfektion</td> </tr> <tr> <td>enumeration</td> <td>0367012</td> <td>documentation Wundinfektion untere Extremitäten</td> </tr> <tr> <td>enumeration</td> <td>0367013</td> <td>documentation HIV-Infektion</td> </tr> <tr> <td>enumeration</td> <td>0367014</td> <td>documentation Hepatitis B oder C</td> </tr> <tr> <td>enumeration</td> <td>0367015</td> <td>documentation andere Wundinfektion</td> </tr> <tr> <td>enumeration</td> <td>0367042</td> <td>documentation sonstige</td> </tr> </tbody> </table>	Kind	Value	Annotation	enumeration	0367001	documentation keine	enumeration	0367002	documentation Mediastinitis	enumeration	0367003	documentation Sepsis	enumeration	0367004	documentation broncho-pulmonale Infektion	enumeration	0367005	documentation oto-laryngologische Infektion	enumeration	0367006	documentation floride Endokarditis	enumeration	0367007	documentation Peritonitis	enumeration	0367008	documentation Wundinfektion Thorax	enumeration	0367009	documentation Pleuraempyem	enumeration	0367010	documentation Venenkatheterinfektion	enumeration	0367011	documentation Harnwegsinfektion	enumeration	0367012	documentation Wundinfektion untere Extremitäten	enumeration	0367013	documentation HIV-Infektion	enumeration	0367014	documentation Hepatitis B oder C	enumeration	0367015	documentation andere Wundinfektion	enumeration	0367042	documentation sonstige
Kind	Value	Annotation																																																		
enumeration	0367001	documentation keine																																																		
enumeration	0367002	documentation Mediastinitis																																																		
enumeration	0367003	documentation Sepsis																																																		
enumeration	0367004	documentation broncho-pulmonale Infektion																																																		
enumeration	0367005	documentation oto-laryngologische Infektion																																																		
enumeration	0367006	documentation floride Endokarditis																																																		
enumeration	0367007	documentation Peritonitis																																																		
enumeration	0367008	documentation Wundinfektion Thorax																																																		
enumeration	0367009	documentation Pleuraempyem																																																		
enumeration	0367010	documentation Venenkatheterinfektion																																																		
enumeration	0367011	documentation Harnwegsinfektion																																																		
enumeration	0367012	documentation Wundinfektion untere Extremitäten																																																		
enumeration	0367013	documentation HIV-Infektion																																																		
enumeration	0367014	documentation Hepatitis B oder C																																																		
enumeration	0367015	documentation andere Wundinfektion																																																		
enumeration	0367042	documentation sonstige																																																		
annotation	documentation Kat_AK_Infektion																																																			
source	<pre> <simpleType name="enum_0367"> <annotation> <documentation>Kat_AK_Infektion</documentation> </annotation> <restriction base="xs:string"> <enumeration value="0367001"> <annotation> <documentation>keine</documentation> </annotation> </enumeration> <enumeration value="0367002"> <annotation> <documentation>Mediastinitis</documentation> </annotation> </enumeration> <enumeration value="0367003"> <annotation> <documentation>Sepsis</documentation> </annotation> </enumeration> <enumeration value="0367004"> <annotation> <documentation>broncho-pulmonale Infektion</documentation> </annotation> </enumeration> </restriction> </simpleType> </pre>																																																			

```
<enumeration value="0367005">
  <annotation>
    <documentation>oto-laryngologische Infektion</documentation>
  </annotation>
</enumeration>
<enumeration value="0367006">
  <annotation>
    <documentation>floride Endokarditis</documentation>
  </annotation>
</enumeration>
<enumeration value="0367007">
  <annotation>
    <documentation>Peritonitis</documentation>
  </annotation>
</enumeration>
<enumeration value="0367008">
  <annotation>
    <documentation>Wundinfektion Thorax</documentation>
  </annotation>
</enumeration>
<enumeration value="0367009">
  <annotation>
    <documentation>Pleuraempyem</documentation>
  </annotation>
</enumeration>
<enumeration value="0367010">
  <annotation>
    <documentation>Venenkatheterinfektion</documentation>
  </annotation>
</enumeration>
<enumeration value="0367011">
  <annotation>
    <documentation>Harnwegsinfektion</documentation>
  </annotation>
</enumeration>
<enumeration value="0367012">
  <annotation>
    <documentation>Wundinfektion untere Extremitäten</documentation>
  </annotation>
</enumeration>
<enumeration value="0367013">
  <annotation>
    <documentation>HIV-Infektion</documentation>
  </annotation>
</enumeration>
<enumeration value="0367014">
  <annotation>
    <documentation>Hepatitis B oder C</documentation>
  </annotation>
</enumeration>
<enumeration value="0367015">
  <annotation>
    <documentation>andere Wundinfektion</documentation>
  </annotation>
</enumeration>
<enumeration value="0367042">
  <annotation>
    <documentation>sonstige</documentation>
  </annotation>
</enumeration>
```

```

</enumeration>
</restriction>
</simpleType>

```

simpleType enum_0368

namespace	http://xml.ir-d.de/sak		
type	restriction of string		
properties	base xs:string		
facets	Kind	Value	Annotation
	enumeration	0368001	documentation nein
	enumeration	0368002	documentation ja, COPD mit Dauermedikation
	enumeration	0368003	documentation ja, COPD ohne Dauermedikation
	enumeration	0368004	documentation ja, andere Lungenerkrankungen
	enumeration	0368099	documentation unbekannt
annotation	documentation Kat_AK_Lungenerkrankung		
source	<pre> <simpleType name="enum_0368"> <annotation> <documentation>Kat_AK_Lungenerkrankung</documentation> </annotation> <restriction base="xs:string"> <enumeration value="0368001"> <annotation> <documentation>nein</documentation> </annotation> </enumeration> <enumeration value="0368002"> <annotation> <documentation>ja, COPD mit Dauermedikation</documentation> </annotation> </enumeration> <enumeration value="0368003"> <annotation> <documentation>ja, COPD ohne Dauermedikation</documentation> </annotation> </enumeration> <enumeration value="0368004"> <annotation> <documentation>ja, andere Lungenerkrankungen</documentation> </annotation> </enumeration> <enumeration value="0368099"> <annotation> <documentation>unbekannt</documentation> </annotation> </enumeration> </restriction> </simpleType> </pre>		

simpleType enum_0369

namespace	http://xml.ir-d.de/sak		
type	restriction of string		
properties	base xs:string		
facets	Kind	Value	Annotation
	enumeration	0369001	documentation nein
	enumeration	0369002	documentation akut
	enumeration	0369003	documentation chronisch
annotation	documentation Kat_AK_Nierenersatztherapie		
source	<pre> <simpleType name="enum_0369"> <annotation> <documentation>Kat_AK_Nierenersatztherapie</documentation> </annotation> <restriction base="xs:string"> <enumeration value="0369001"> <annotation> <documentation>nein</documentation> </annotation> </enumeration> <enumeration value="0369002"> <annotation> <documentation>akut</documentation> </annotation> </enumeration> <enumeration value="0369003"> <annotation> <documentation>chronisch</documentation> </annotation> </enumeration> </restriction> </simpleType> </pre>		

simpleType enum_0370

namespace	http://xml.ir-d.de/sak		
type	restriction of string		
properties	base xs:string		
facets	Kind	Value	Annotation
	enumeration	0370001	documentation Echokardiographie
	enumeration	0370002	documentation Herzkatheter
	enumeration	0370042	documentation andere
annotation	documentation Kat_AK_AKOEFMessmethode		
source	<pre> <simpleType name="enum_0370"> <annotation> <documentation>Kat_AK_AKOEFMessmethode</documentation> </annotation> <restriction base="xs:string"> </pre>		

	<pre> <enumeration value="0370001"> <annotation> <documentation>Echokardiographie</documentation> </annotation> </enumeration> <enumeration value="0370002"> <annotation> <documentation>Herzkatheter</documentation> </annotation> </enumeration> <enumeration value="0370042"> <annotation> <documentation>andere</documentation> </annotation> </enumeration> </restriction> </simpleType> </pre>
--	--

simpleType enum 0371

namespace	http://xml.ir-d.de/sak		
type	restriction of string		
properties	base xs:string		
facets	Kind	Value	Annotation
	enumeration	0371001	documentation keine
	enumeration	0371002	documentation leicht
	enumeration	0371003	documentation mittel
	enumeration	0371004	documentation schwer
	enumeration	0371099	documentation unbekannt
annotation	documentation Kat_AK_Verkalkungsgrad		
source	<pre> <simpleType name="enum_0371"> <annotation> <documentation>Kat_AK_Verkalkungsgrad</documentation> </annotation> <restriction base="xs:string"> <enumeration value="0371001"> <annotation> <documentation>keine</documentation> </annotation> </enumeration> <enumeration value="0371002"> <annotation> <documentation>leicht</documentation> </annotation> </enumeration> <enumeration value="0371003"> <annotation> <documentation>mittel</documentation> </annotation> </enumeration> <enumeration value="0371004"> </pre>		

	<pre> <annotation> <documentation>schwer</documentation> </annotation> </enumeration> <enumeration value="0371099"> <annotation> <documentation>unbekannt</documentation> </annotation> </enumeration> </restriction> </simpleType> </pre>
--	--

simpleType enum_0372

namespace	http://xml.ir-d.de/sak		
type	restriction of string		
properties	base xs:string		
facets	Kind	Value	Annotation
	enumeration	0372001	documentation nein
	enumeration	0372002	documentation ja, bicuspide
	enumeration	0372003	documentation ja, unicuspide
	enumeration	0372099	documentation unbekannt
annotation	documentation Kat_AK_BiUnicuspideKlappe		
source	<pre> <simpleType name="enum_0372"> <annotation> <documentation>Kat_AK_BiUnicuspideKlappe</documentation> </annotation> <restriction base="xs:string"> <enumeration value="0372001"> <annotation> <documentation>nein</documentation> </annotation> </enumeration> <enumeration value="0372002"> <annotation> <documentation>ja, bicuspide</documentation> </annotation> </enumeration> <enumeration value="0372003"> <annotation> <documentation>ja, unicuspide</documentation> </annotation> </enumeration> <enumeration value="0372099"> <annotation> <documentation>unbekannt</documentation> </annotation> </enumeration> </restriction> </simpleType> </pre>		

simpleType enum_0373

namespace	http://xml.ir-d.de/sak		
type	restriction of string		
properties	base xs:string		
facets	Kind	Value	Annotation
	enumeration	0373001	documentation keine
	enumeration	0373002	documentation leichtgradig
	enumeration	0373003	documentation mittelgradig
	enumeration	0373004	documentation hochgradig
	enumeration	0373099	documentation unbekannt
annotation	documentation Kat_AK_Grad		
source	<pre> <simpleType name="enum_0373"> <annotation> <documentation>Kat_AK_Grad</documentation> </annotation> <restriction base="xs:string"> <enumeration value="0373001"> <annotation> <documentation>keine</documentation> </annotation> </enumeration> <enumeration value="0373002"> <annotation> <documentation>leichtgradig</documentation> </annotation> </enumeration> <enumeration value="0373003"> <annotation> <documentation>mittelgradig</documentation> </annotation> </enumeration> <enumeration value="0373004"> <annotation> <documentation>hochgradig</documentation> </annotation> </enumeration> <enumeration value="0373099"> <annotation> <documentation>unbekannt</documentation> </annotation> </enumeration> </restriction> </simpleType> </pre>		

simpleType enum_0374

namespace	http://xml.ir-d.de/sak
type	restriction of string

properties	base xs:string																								
facets	<table border="1"> <thead> <tr> <th>Kind</th> <th>Value</th> <th>Annotation</th> </tr> </thead> <tbody> <tr> <td>enumeration</td> <td>0374001</td> <td>documentation nein</td> </tr> <tr> <td>enumeration</td> <td>0374002</td> <td>documentation ja, &lt;= 6 Stunden</td> </tr> <tr> <td>enumeration</td> <td>0374003</td> <td>documentation ja, &gt; 6 Stunden bis &lt;= 24 Stunden</td> </tr> <tr> <td>enumeration</td> <td>0374004</td> <td>documentation ja, &gt; 1 bis 7 Tage</td> </tr> <tr> <td>enumeration</td> <td>0374005</td> <td>documentation ja, &gt; 7 bis 21 Tage</td> </tr> <tr> <td>enumeration</td> <td>0374006</td> <td>documentation ja, &gt; 21 Tage</td> </tr> <tr> <td>enumeration</td> <td>0374099</td> <td>documentation unbekannt</td> </tr> </tbody> </table>	Kind	Value	Annotation	enumeration	0374001	documentation nein	enumeration	0374002	documentation ja, <= 6 Stunden	enumeration	0374003	documentation ja, > 6 Stunden bis <= 24 Stunden	enumeration	0374004	documentation ja, > 1 bis 7 Tage	enumeration	0374005	documentation ja, > 7 bis 21 Tage	enumeration	0374006	documentation ja, > 21 Tage	enumeration	0374099	documentation unbekannt
Kind	Value	Annotation																							
enumeration	0374001	documentation nein																							
enumeration	0374002	documentation ja, <= 6 Stunden																							
enumeration	0374003	documentation ja, > 6 Stunden bis <= 24 Stunden																							
enumeration	0374004	documentation ja, > 1 bis 7 Tage																							
enumeration	0374005	documentation ja, > 7 bis 21 Tage																							
enumeration	0374006	documentation ja, > 21 Tage																							
enumeration	0374099	documentation unbekannt																							
annotation	documentation Kat_AK_InfarktAnamnese																								
source	<pre> <simpleType name="enum_0374"> <annotation> <documentation>Kat_AK_InfarktAnamnese</documentation> </annotation> <restriction base="xs:string"> <enumeration value="0374001"> <annotation> <documentation>nein</documentation> </annotation> </enumeration> <enumeration value="0374002"> <annotation> <documentation>ja, &lt;= 6 Stunden</documentation> </annotation> </enumeration> <enumeration value="0374003"> <annotation> <documentation>ja, &gt; 6 Stunden bis &lt;= 24 Stunden</documentation> </annotation> </enumeration> <enumeration value="0374004"> <annotation> <documentation>ja, &gt; 1 bis 7 Tage</documentation> </annotation> </enumeration> <enumeration value="0374005"> <annotation> <documentation>ja, &gt; 7 bis 21 Tage</documentation> </annotation> </enumeration> <enumeration value="0374006"> <annotation> <documentation>ja, &gt; 21 Tage</documentation> </annotation> </enumeration> <enumeration value="0374099"> <annotation> <documentation>unbekannt</documentation> </annotation> </enumeration> </restriction> </pre>																								

	<code></simpleType></code>
--	----------------------------------

simpleType enum_0375

namespace	http://xml.ir-d.de/sak																								
type	restriction of string																								
properties	base xs:string																								
facets	<table><thead><tr><th>Kind</th><th>Value</th><th>Annotation</th></tr></thead><tbody><tr><td>enumeration</td><td>0375001</td><td>documentation keine Symptome oder Angina</td></tr><tr><td>enumeration</td><td>0375002</td><td>documentation Symptome, aber keine Ischämiezeichen</td></tr><tr><td>enumeration</td><td>0375003</td><td>documentation stabile Angina</td></tr><tr><td>enumeration</td><td>0375004</td><td>documentation instabile Angina</td></tr><tr><td>enumeration</td><td>0375005</td><td>documentation Infarkt ohne ST-Hebung (Non-STEMI)</td></tr><tr><td>enumeration</td><td>0375006</td><td>documentation Infarkt mit ST-Hebung (STEMI)</td></tr><tr><td>enumeration</td><td>0375042</td><td>documentation unbekannt</td></tr></tbody></table>	Kind	Value	Annotation	enumeration	0375001	documentation keine Symptome oder Angina	enumeration	0375002	documentation Symptome, aber keine Ischämiezeichen	enumeration	0375003	documentation stabile Angina	enumeration	0375004	documentation instabile Angina	enumeration	0375005	documentation Infarkt ohne ST-Hebung (Non-STEMI)	enumeration	0375006	documentation Infarkt mit ST-Hebung (STEMI)	enumeration	0375042	documentation unbekannt
Kind	Value	Annotation																							
enumeration	0375001	documentation keine Symptome oder Angina																							
enumeration	0375002	documentation Symptome, aber keine Ischämiezeichen																							
enumeration	0375003	documentation stabile Angina																							
enumeration	0375004	documentation instabile Angina																							
enumeration	0375005	documentation Infarkt ohne ST-Hebung (Non-STEMI)																							
enumeration	0375006	documentation Infarkt mit ST-Hebung (STEMI)																							
enumeration	0375042	documentation unbekannt																							
annotation	documentation Kat_AK_KardialeSymptome																								
source	<pre><simpleType name="enum_0375"> <annotation> <documentation>Kat_AK_KardialeSymptome</documentation> </annotation> <restriction base="xs:string"> <enumeration value="0375001"> <annotation> <documentation>keine Symptome oder Angina</documentation> </annotation> </enumeration> <enumeration value="0375002"> <annotation> <documentation>Symptome, aber keine Ischämiezeichen</documentation> </annotation> </enumeration> <enumeration value="0375003"> <annotation> <documentation>stabile Angina</documentation> </annotation> </enumeration> <enumeration value="0375004"> <annotation> <documentation>instabile Angina</documentation> </annotation> </enumeration> <enumeration value="0375005"> <annotation> <documentation>Infarkt ohne ST-Hebung (Non-STEMI)</documentation> </annotation> </enumeration> <enumeration value="0375006"> <annotation> <documentation>Infarkt mit ST-Hebung (STEMI)</documentation> </annotation> </enumeration> </restriction> </simpleType></pre>																								

	<pre> </annotation> </enumeration> <enumeration value="0375042"> <annotation> <documentation>unbekannt</documentation> </annotation> </enumeration> </restriction> </simpleType> </pre>
--	---

simpleType enum_0376

namespace	http://xml.ir-d.de/sak		
type	restriction of string		
properties	base xs:string		
facets	Kind	Value	Annotation
	enumeration	0376001	documentation nein
	enumeration	0376002	documentation ja, ZNS, zerebrovaskuläre Blutung
	enumeration	0376003	documentation ja, ZNS, zerebrovaskuläre Ischämie
	enumeration	0376042	documentation ja, ZNS, andere
annotation	documentation Kat_AK_Schlaganfall		
source	<pre> <simpleType name="enum_0376"> <annotation> <documentation>Kat_AK_Schlaganfall</documentation> </annotation> <restriction base="xs:string"> <enumeration value="0376001"> <annotation> <documentation>nein</documentation> </annotation> </enumeration> <enumeration value="0376002"> <annotation> <documentation>ja, ZNS, zerebrovaskuläre Blutung</documentation> </annotation> </enumeration> <enumeration value="0376003"> <annotation> <documentation>ja, ZNS, zerebrovaskuläre Ischämie</documentation> </annotation> </enumeration> <enumeration value="0376042"> <annotation> <documentation>ja, ZNS, andere</documentation> </annotation> </enumeration> </restriction> </simpleType> </pre>		

simpleType enum_0377

namespace	http://xml.ir-d.de/sak		
type	restriction of string		
properties	base xs:string		
facets	Kind	Value	Annotation
	enumeration	0377001	documentation ja, mild neurological dysfunction: NIHSS 0-5
	enumeration	0377002	documentation ja, moderate neurological dysfunction: NIHSS 6-14
	enumeration	0377003	documentation ja, severe neurological dysfunction: NIHSS >=15
annotation	documentation Kat_AK_Nihss		
source	<pre> <simpleType name="enum_0377"> <annotation> <documentation>Kat_AK_Nihss</documentation> </annotation> <restriction base="xs:string"> <enumeration value="0377001"> <annotation> <documentation>ja, mild neurological dysfunction: NIHSS 0- 5</documentation> </annotation> </enumeration> <enumeration value="0377002"> <annotation> <documentation>ja, moderate neurological dysfunction: NIHSS 6- 14</documentation> </annotation> </enumeration> <enumeration value="0377003"> <annotation> <documentation>ja, severe neurological dysfunction: NIHSS &gt;=15</documentation> </annotation> </enumeration> </restriction> </simpleType> </pre>		

simpleType enum_0378

namespace	http://xml.ir-d.de/sak		
type	restriction of string		
properties	base xs:string		
facets	Kind	Value	Annotation
	enumeration	0378001	documentation nein
	enumeration	0378002	documentation ja, < 48h gemäss VARC-3-Definition
	enumeration	0378003	documentation ja, >= 48h - <= 72h gemäß VARC-3-Definition
	enumeration	0378004	documentation ja, > 72 h gemäß VARC-3 Definition
annotation	documentation Kat_AK_Myokardinfarkt		

source	<pre> <simpleType name="enum_0378"> <annotation> <documentation>Kat_AK_Myokardinfarkt</documentation> </annotation> <restriction base="xs:string"> <enumeration value="0378001"> <annotation> <documentation>nein</documentation> </annotation> </enumeration> <enumeration value="0378002"> <annotation> <documentation>ja, &lt; 48h gemäss VARC-3-Definition</documentation> </annotation> </enumeration> <enumeration value="0378003"> <annotation> <documentation>ja, &gt;= 48h - &lt;= 72h gemäß VARC-3- Definition</documentation> </annotation> </enumeration> <enumeration value="0378004"> <annotation> <documentation>ja, &gt; 72 h gemäß VARC-3 Definition</documentation> </annotation> </enumeration> </restriction> </simpleType> </pre>
--------	--

simpleType enum_0379

namespace	http://xml.ir-d.de/sak		
type	restriction of string		
properties	base xs:string		
facets	Kind	Value	Annotation
	enumeration	0379001	documentation Keine gefäss- oder zugangsassozierte Komplikationen
	enumeration	0379002	documentation Versagen des perkutanen Verschlusssystems
	enumeration	0379003	documentation Geringfügige Gefäßkomplikationen
	enumeration	0379004	documentation Erhebliche Gefäßkomplikationen
annotation	documentation Kat_AK_ZugangKomplikationen		
source	<pre> <simpleType name="enum_0379"> <annotation> <documentation>Kat_AK_ZugangKomplikationen</documentation> </annotation> <restriction base="xs:string"> <enumeration value="0379001"> <annotation> <documentation>Keine gefäss- oder zugangsassozierte Komplikationen</documentation> </annotation> </enumeration> <enumeration value="0379002"> </pre>		

	<pre> <annotation> <documentation>Versagen des perkutanen Verschlussystems</documentation> </annotation> </enumeration> <enumeration value="0379003"> <annotation> <documentation>Geringfügige Gefäßkomplikationen</documentation> </annotation> </enumeration> <enumeration value="0379004"> <annotation> <documentation>Erhebliche Gefäßkomplikationen</documentation> </annotation> </enumeration> </restriction> </simpleType> </pre>
--	---

simpleType enum_0380

namespace	http://xml.ir-d.de/sak		
type	restriction of string		
properties	base xs:string		
facets	Kind	Value	Annotation
	enumeration	0380001	documentation nein
	enumeration	0380002	documentation ja, intraprozedural
	enumeration	0380003	documentation ja, postprozedural
	enumeration	0380004	documentation ja, Zeitpunkt nicht bekannt
annotation	documentation Kat_AK_Reanimation		
source	<pre> <simpleType name="enum_0380"> <annotation> <documentation>Kat_AK_Reanimation</documentation> </annotation> <restriction base="xs:string"> <enumeration value="0380001"> <annotation> <documentation>nein</documentation> </annotation> </enumeration> <enumeration value="0380002"> <annotation> <documentation>ja, intraprozedural</documentation> </annotation> </enumeration> <enumeration value="0380003"> <annotation> <documentation>ja, postprozedural</documentation> </annotation> </enumeration> <enumeration value="0380004"> <annotation> <documentation>ja, Zeitpunkt nicht bekannt</documentation> </annotation> </enumeration> </restriction> </simpleType> </pre>		

```

    </annotation>
  </enumeration>
</restriction>
</simpleType>

```

simpleType enum_0381

namespace	http://xml.ir-d.de/sak		
type	restriction of string		
properties	base xs:string		
facets	Kind	Value	Annotation
	enumeration	0381001	documentation nein
	enumeration	0381002	documentation Thorakotomie/Rethorakotomie
	enumeration	0381003	documentation kathetergestützte Reintervention
	enumeration	0381004	documentation lokale Reinterventionen
	enumeration	0381005	documentation andere Reintervention
annotation	documentation Kat_AK_Massnahmen		
source	<pre> <simpleType name="enum_0381"> <annotation> <documentation>Kat_AK_Massnahmen</documentation> </annotation> <restriction base="xs:string"> <enumeration value="0381001"> <annotation> <documentation>nein</documentation> </annotation> </enumeration> <enumeration value="0381002"> <annotation> <documentation>Thorakotomie/Rethorakotomie</documentation> </annotation> </enumeration> <enumeration value="0381003"> <annotation> <documentation>kathetergestützte Reintervention</documentation> </annotation> </enumeration> <enumeration value="0381004"> <annotation> <documentation>lokale Reinterventionen</documentation> </annotation> </enumeration> <enumeration value="0381005"> <annotation> <documentation>andere Reintervention</documentation> </annotation> </enumeration> </restriction> </simpleType> </pre>		

simpleType enum_0382

namespace	http://xml.ir-d.de/sak		
type	restriction of string		
properties	base xs:string		
facets	Kind	Value	Annotation
	enumeration	0382001	documentation keine Rethorakotomie / kein weiterer Grund
	enumeration	0382002	documentation Blutung/Hämatom
	enumeration	0382003	documentation Low Cardiac Output
	enumeration	0382004	documentation Tamponade
	enumeration	0382005	documentation Graftprobleme, Ischämie
	enumeration	0382006	documentation Wundinfektion, Mediastinitis
	enumeration	0382007	documentation Dissektion
	enumeration	0382008	documentation Prothesendysfunktion
	enumeration	0382009	documentation instabiles Sternum
	enumeration	0382010	documentation Chylothorax
	enumeration	0382011	documentation lokale Revision im Bereich des Zugangsweges
	enumeration	0382042	documentation anderer Grund
annotation	documentation Kat_AK_Komplikation		
source	<pre> <simpleType name="enum_0382"> <annotation> <documentation>Kat_AK_Komplikation</documentation> </annotation> <restriction base="xs:string"> <enumeration value="0382001"> <annotation> <documentation>keine Rethorakotomie / kein weiterer Grund</documentation> </annotation> </enumeration> <enumeration value="0382002"> <annotation> <documentation>Blutung/Hämatom</documentation> </annotation> </enumeration> <enumeration value="0382003"> <annotation> <documentation>Low Cardiac Output</documentation> </annotation> </enumeration> <enumeration value="0382004"> <annotation> <documentation>Tamponade</documentation> </annotation> </enumeration> <enumeration value="0382005"> </pre>		

```

    <annotation>
      <documentation>Graftprobleme, Ischämie</documentation>
    </annotation>
  </enumeration>
  <enumeration value="0382006">
    <annotation>
      <documentation>Wundinfektion, Mediastinitis</documentation>
    </annotation>
  </enumeration>
  <enumeration value="0382007">
    <annotation>
      <documentation>Dissektion</documentation>
    </annotation>
  </enumeration>
  <enumeration value="0382008">
    <annotation>
      <documentation>Prothesendysfunktion</documentation>
    </annotation>
  </enumeration>
  <enumeration value="0382009">
    <annotation>
      <documentation>instabiles Sternum</documentation>
    </annotation>
  </enumeration>
  <enumeration value="0382010">
    <annotation>
      <documentation>Chylothorax</documentation>
    </annotation>
  </enumeration>
  <enumeration value="0382011">
    <annotation>
      <documentation>lokale Revision im Bereich des
Zugangsweges</documentation>
    </annotation>
  </enumeration>
  <enumeration value="0382042">
    <annotation>
      <documentation>anderer Grund</documentation>
    </annotation>
  </enumeration>
</restriction>
</simpleType>

```

simpleType enum_0383

namespace	http://xml.ir-d.de/sak		
type	restriction of string		
properties	base xs:string		
facets	Kind	Value	Annotation
	enumeration	0383001	documentation nein
	enumeration	0383002	documentation ja, mit forcierter Atemtherapie
	enumeration	0383003	documentation ja, Reintubation oder längerfristige Beatmung
	enumeration	0383004	documentation ja, Tracheotomie

annotation	documentation Kat_AK_RespiratorischeInsuffizienz
source	<pre> <simpleType name="enum_0383"> <annotation> <documentation>Kat_AK_RespiratorischeInsuffizienz</documentation> </annotation> <restriction base="xs:string"> <enumeration value="0383001"> <annotation> <documentation>nein</documentation> </annotation> </enumeration> <enumeration value="0383002"> <annotation> <documentation>ja, mit forcierter Atemtherapie</documentation> </annotation> </enumeration> <enumeration value="0383003"> <annotation> <documentation>ja, Reintubation oder längerfristige Beatmung</documentation> </annotation> </enumeration> <enumeration value="0383004"> <annotation> <documentation>ja, Tracheotomie</documentation> </annotation> </enumeration> </restriction> </simpleType> </pre>

simpleType enum_0384

namespace	http://xml.ir-d.de/sak		
type	restriction of string		
properties	base xs:string		
facets	Kind	Value	Annotation
	enumeration	0384001	documentation keine Blutungskomplikationen
	enumeration	0384002	documentation Geringfügige Blutung (Minor Bleeding - BARC type 2 or 3a)
	enumeration	0384003	documentation Starke Blutung (Major Bleeding - BARC type 3a)
	enumeration	0384004	documentation Lebensbedrohliche Blutung (Life-threatening or disabling bleeding - BARC type 3b or 3c or type 5)
annotation	documentation Kat_AK_Blutungskomplikation		
source	<pre> <simpleType name="enum_0384"> <annotation> <documentation>Kat_AK_Blutungskomplikation</documentation> </annotation> <restriction base="xs:string"> <enumeration value="0384001"> <annotation> <documentation>keine Blutungskomplikationen</documentation> </annotation> </pre>		

	<pre> </enumeration> <enumeration value="0384002"> <annotation> <documentation>Geringfügige Blutung (Minor Bleeding - BARC type 2 or 3a)</documentation> </annotation> </enumeration> <enumeration value="0384003"> <annotation> <documentation>Starke Blutung (Major Bleeding - BARC type 3a)</documentation> </annotation> </enumeration> <enumeration value="0384004"> <annotation> <documentation>Lebensbedrohliche Blutung (Life-threatening or disabling bleeding - BARC type 3b or 3c or type 5)</documentation> </annotation> </enumeration> </restriction> </simpleType> </pre>
--	--

simpleType enum_0385

namespace	http://xml.ir-d.de/sak		
type	restriction of string		
properties	base xs:string		
facets	Kind	Value	Annotation
	enumeration	0385001	documentation Sinusrhythmus
	enumeration	0385002	documentation Vorhofflimmern
	enumeration	0385003	documentation Patient verstorben (kein Herzrhythmus)
	enumeration	0385042	documentation anderer Rhythmus
annotation	documentation Kat_AK_HerzrhythmusEntlassung		
source	<pre> <simpleType name="enum_0385"> <annotation> <documentation>Kat_AK_HerzrhythmusEntlassung</documentation> </annotation> <restriction base="xs:string"> <enumeration value="0385001"> <annotation> <documentation>Sinusrhythmus</documentation> </annotation> </enumeration> <enumeration value="0385002"> <annotation> <documentation>Vorhofflimmern</documentation> </annotation> </enumeration> <enumeration value="0385003"> <annotation> <documentation>Patient verstorben (kein Herzrhythmus)</documentation> </annotation> </enumeration> </restriction> </simpleType> </pre>		

	<pre> </enumeration> <enumeration value="0385042"> <annotation> <documentation>anderer Rhythmus</documentation> </annotation> </enumeration> </restriction> </simpleType> </pre>
--	--

simpleType **enum_0388**

namespace	http://xml.ir-d.de/sak		
type	restriction of string		
properties	base xs:string		
facets	Kind	Value	Annotation
	enumeration	0388001	documentation nein
	enumeration	0388002	documentation ASS
	enumeration	0388003	documentation ADP-Rezeptor-Antagonist
	enumeration	0388004	documentation Kombination ASS und ADP-Rezeptor-Antagonist
	enumeration	0388042	documentation ja, andere
	enumeration	0388099	documentation unbekannt
annotation	documentation Kat_AK_Plaettchenaggregationshemmer		
source	<pre> <simpleType name="enum_0388"> <annotation> <documentation>Kat_AK_Plaettchenaggregationshemmer</documentation> </annotation> <restriction base="xs:string"> <enumeration value="0388001"> <annotation> <documentation>nein</documentation> </annotation> </enumeration> <enumeration value="0388002"> <annotation> <documentation>ASS</documentation> </annotation> </enumeration> <enumeration value="0388003"> <annotation> <documentation>ADP-Rezeptor-Antagonist</documentation> </annotation> </enumeration> <enumeration value="0388004"> <annotation> <documentation>Kombination ASS und ADP-Rezeptor- Antagonist</documentation> </annotation> </enumeration> <enumeration value="0388042"> <annotation> </pre>		

	<pre> <documentation>ja, andere</documentation> </annotation> </enumeration> <enumeration value="0388099"> <annotation> <documentation>unbekannt</documentation> </annotation> </enumeration> </restriction> </simpleType> </pre>
--	---

simpleType enum_0389

namespace	http://xml.ir-d.de/sak		
type	restriction of string		
properties	base xs:string		
facets	Kind	Value	Annotation
	enumeration	0389001	documentation nein
	enumeration	0389002	documentation Cumarin-Derivate
	enumeration	0389003	documentation Heparinoide
	enumeration	0389004	documentation orale Thrombinantagonisten
	enumeration	0389006	documentation Direkte orale Antikoagulantien (DOAK / NOAK)
	enumeration	0389042	documentation ja, andere
	enumeration	0389099	documentation unbekannt
annotation	documentation Kat_AK_Antikoagulantien		
source	<pre> <simpleType name="enum_0389"> <annotation> <documentation>Kat_AK_Antikoagulantien</documentation> </annotation> <restriction base="xs:string"> <enumeration value="0389001"> <annotation> <documentation>nein</documentation> </annotation> </enumeration> <enumeration value="0389002"> <annotation> <documentation>Cumarin-Derivate</documentation> </annotation> </enumeration> <enumeration value="0389003"> <annotation> <documentation>Heparinoide</documentation> </annotation> </enumeration> <enumeration value="0389004"> <annotation> <documentation>orale Thrombinantagonisten</documentation> </annotation> </pre>		

	<pre> </enumeration> <enumeration value="0389006"> <annotation> <documentation>Direkte orale Antikoagulantien (DOAK / NOAK)</documentation> </annotation> </enumeration> <enumeration value="0389042"> <annotation> <documentation>ja, andere</documentation> </annotation> </enumeration> <enumeration value="0389099"> <annotation> <documentation>unbekannt</documentation> </annotation> </enumeration> </restriction> </simpleType> </pre>
--	---

simpleType enum_0390

namespace	http://xml.ir-d.de/sak		
type	restriction of string		
properties	base xs:string		
facets	Kind	Value	Annotation
	enumeration	0390001	documentation biologisches Klappenmodell
	enumeration	0390002	documentation mechanisches Klappenmodell
annotation	documentation Kat_AK_Artikeltyp		
source	<pre> <simpleType name="enum_0390"> <annotation> <documentation>Kat_AK_Artikeltyp</documentation> </annotation> <restriction base="xs:string"> <enumeration value="0390001"> <annotation> <documentation>biologisches Klappenmodell</documentation> </annotation> </enumeration> <enumeration value="0390002"> <annotation> <documentation>mechanisches Klappenmodell</documentation> </annotation> </enumeration> </restriction> </simpleType> </pre>		

simpleType enum_0391

namespace	http://xml.ir-d.de/sak
type	restriction of string

properties	base xs:string									
facets	<table border="1"> <thead> <tr> <th>Kind</th> <th>Value</th> <th>Annotation</th> </tr> </thead> <tbody> <tr> <td>enumeration</td> <td>0391001</td> <td>documentation chirurgische Klappe</td> </tr> <tr> <td>enumeration</td> <td>0391002</td> <td>documentation TAVI-Klappe</td> </tr> </tbody> </table>	Kind	Value	Annotation	enumeration	0391001	documentation chirurgische Klappe	enumeration	0391002	documentation TAVI-Klappe
Kind	Value	Annotation								
enumeration	0391001	documentation chirurgische Klappe								
enumeration	0391002	documentation TAVI-Klappe								
annotation	documentation Kat_AK_Klappentyp									
source	<pre><simpleType name="enum_0391"> <annotation> <documentation>Kat_AK_Klappentyp</documentation> </annotation> <restriction base="xs:string"> <enumeration value="0391001"> <annotation> <documentation>chirurgische Klappe</documentation> </annotation> </enumeration> <enumeration value="0391002"> <annotation> <documentation>TAVI-Klappe</documentation> </annotation> </enumeration> </restriction> </simpleType></pre>									

simpleType enum_0398

namespace	http://xml.lir-d.de/sak												
type	restriction of string												
properties	base xs:string												
facets	<table border="1"> <thead> <tr> <th>Kind</th> <th>Value</th> <th>Annotation</th> </tr> </thead> <tbody> <tr> <td>enumeration</td> <td>0398001</td> <td>documentation kardiovaskuläre Ursache</td> </tr> <tr> <td>enumeration</td> <td>0398002</td> <td>documentation nicht-kardiovaskuläre Ursache</td> </tr> <tr> <td>enumeration</td> <td>0398099</td> <td>documentation Todesursache unbekannt</td> </tr> </tbody> </table>	Kind	Value	Annotation	enumeration	0398001	documentation kardiovaskuläre Ursache	enumeration	0398002	documentation nicht-kardiovaskuläre Ursache	enumeration	0398099	documentation Todesursache unbekannt
Kind	Value	Annotation											
enumeration	0398001	documentation kardiovaskuläre Ursache											
enumeration	0398002	documentation nicht-kardiovaskuläre Ursache											
enumeration	0398099	documentation Todesursache unbekannt											
annotation	documentation Kat_AK_Todesursache												
source	<pre><simpleType name="enum_0398"> <annotation> <documentation>Kat_AK_Todesursache</documentation> </annotation> <restriction base="xs:string"> <enumeration value="0398001"> <annotation> <documentation>kardiovaskuläre Ursache</documentation> </annotation> </enumeration> <enumeration value="0398002"> <annotation> <documentation>nicht-kardiovaskuläre Ursache</documentation> </annotation> </enumeration> <enumeration value="0398099"> </pre>												

	<pre> <annotation> <documentation>Todesursache unbekannt</documentation> </annotation> </enumeration> </restriction> </simpleType> </pre>
--	---

simpleType enum_0399

namespace	http://xml.ir-d.de/sak		
type	restriction of string		
properties	base xs:string		
facets	Kind	Value	Annotation
	enumeration	0399001	documentation Patient lebt
	enumeration	0399002	documentation Patient im Krankenhaus verstorben
annotation	documentation Kat_AK_Vitalstatus		
source	<pre> <simpleType name="enum_0399"> <annotation> <documentation>Kat_AK_Vitalstatus</documentation> </annotation> <restriction base="xs:string"> <enumeration value="0399001"> <annotation> <documentation>Patient lebt</documentation> </annotation> </enumeration> <enumeration value="0399002"> <annotation> <documentation>Patient im Krankenhaus verstorben</documentation> </annotation> </enumeration> </restriction> </simpleType> </pre>		

simpleType enum_0044

namespace	http://xml.ir-d.de/irdsaa		
type	restriction of string		
properties	base xs:string		
facets	Kind	Value	Annotation
	enumeration	0044001	documentation 1= normaler, sonst gesunder Patient
	enumeration	0044002	documentation 2= Patient mit leichter Allgemeinerkrankung
	enumeration	0044003	documentation 3= Patient mit schwerer Allgemeinerkrankung
	enumeration	0044004	documentation 4= Patient mit schwerer Allgemeinerkrankung, die eine ständige Lebensbedrohung darstellt
	enumeration	0044005	documentation 5= moribunder Patient, der ohne die Operation voraussichtlich nicht überleben wird

annotation	documentation Kat_ASA
source	<pre> <simpleType name="enum_0044"> <annotation> <documentation>Kat_ASA</documentation> </annotation> <restriction base="xs:string"> <enumeration value="0044001"> <annotation> <documentation>1= normaler, sonst gesunder Patient</documentation> </annotation> </enumeration> <enumeration value="0044002"> <annotation> <documentation>2= Patient mit leichter Allgemeinerkrankung</documentation> </annotation> </enumeration> <enumeration value="0044003"> <annotation> <documentation>3= Patient mit schwerer Allgemeinerkrankung</documentation> </annotation> </enumeration> <enumeration value="0044004"> <annotation> <documentation>4= Patient mit schwerer Allgemeinerkrankung, die eine ständige Lebensbedrohung darstellt</documentation> </annotation> </enumeration> <enumeration value="0044005"> <annotation> <documentation>5= moribunder Patient, der ohne die Operation voraussichtlich nicht überleben wird</documentation> </annotation> </enumeration> </restriction> </simpleType> </pre>

simpleType enum_0050

namespace	http://xml.ir-d.de/irdsaa		
type	restriction of string		
properties	base xs:string		
facets	Kind	Value	Annotation
	enumeration	0050001	documentation rechts
	enumeration	0050002	documentation links
annotation	documentation Kat_RechtsLinks		
source	<pre> <simpleType name="enum_0050"> <annotation> <documentation>Kat_RechtsLinks</documentation> </annotation> <restriction base="xs:string"> </pre>		

	<pre> <enumeration value="0050001"> <annotation> <documentation>rechts</documentation> </annotation> </enumeration> <enumeration value="0050002"> <annotation> <documentation>links</documentation> </annotation> </enumeration> </restriction> </simpleType> </pre>
--	--

simpleType enum_0060

namespace	http://xml.ir-d.de/irdsaa		
type	restriction of string		
properties	base xs:string		
facets	Kind	Value	Annotation
	enumeration	0060001	documentation ja
	enumeration	0060002	documentation nein
annotation	documentation Kat_JaNein		
source	<pre> <simpleType name="enum_0060"> <annotation> <documentation>Kat_JaNein</documentation> </annotation> <restriction base="xs:string"> <enumeration value="0060001"> <annotation> <documentation>ja</documentation> </annotation> </enumeration> <enumeration value="0060002"> <annotation> <documentation>nein</documentation> </annotation> </enumeration> </restriction> </simpleType> </pre>		

simpleType enum_0061

namespace	http://xml.ir-d.de/irdsaa		
type	restriction of string		
properties	base xs:string		
facets	Kind	Value	Annotation
	enumeration	0061001	documentation ja
	enumeration	0061002	documentation nein
	enumeration	0061099	documentation

	unbekannt
annotation	documentation Kat JaNeinUnbekannt
source	<pre> <simpleType name="enum_0061"> <annotation> <documentation>Kat_JaNeinUnbekannt</documentation> </annotation> <restriction base="xs:string"> <enumeration value="0061001"> <annotation> <documentation>ja</documentation> </annotation> </enumeration> <enumeration value="0061002"> <annotation> <documentation>nein</documentation> </annotation> </enumeration> <enumeration value="0061099"> <annotation> <documentation>unbekannt</documentation> </annotation> </enumeration> </restriction> </simpleType> </pre>

simpleType enum_0062

namespace	http://xml.ir-d.de/irdsaa		
type	restriction of string		
properties	base	xs:string	
facets	Kind	Value	Annotation
	enumeration	0062001	documentation Stück
	enumeration	0062002	documentation g
	enumeration	0062003	documentation mg
	enumeration	0062004	documentation l
	enumeration	0062005	documentation ml
	enumeration	0062006	documentation cm ³
	enumeration	0062007	documentation mm
	enumeration	0062008	documentation cm
	enumeration	0062009	documentation dm
	enumeration	0062010	documentation m
	enumeration	0062042	documentation andere
annotation	documentation Kat_Einheit		
source	<pre> <simpleType name="enum_0062"> <annotation> </pre>		

```
<documentation>Kat_Einheit</documentation>
</annotation>
<restriction base="xs:string">
  <enumeration value="0062001">
    <annotation>
      <documentation>Stück</documentation>
    </annotation>
  </enumeration>
  <enumeration value="0062002">
    <annotation>
      <documentation>g</documentation>
    </annotation>
  </enumeration>
  <enumeration value="0062003">
    <annotation>
      <documentation>mg</documentation>
    </annotation>
  </enumeration>
  <enumeration value="0062004">
    <annotation>
      <documentation>l</documentation>
    </annotation>
  </enumeration>
  <enumeration value="0062005">
    <annotation>
      <documentation>ml</documentation>
    </annotation>
  </enumeration>
  <enumeration value="0062006">
    <annotation>
      <documentation>cm3</documentation>
    </annotation>
  </enumeration>
  <enumeration value="0062007">
    <annotation>
      <documentation>mm</documentation>
    </annotation>
  </enumeration>
  <enumeration value="0062008">
    <annotation>
      <documentation>cm</documentation>
    </annotation>
  </enumeration>
  <enumeration value="0062009">
    <annotation>
      <documentation>dm</documentation>
    </annotation>
  </enumeration>
  <enumeration value="0062010">
    <annotation>
      <documentation>m</documentation>
    </annotation>
  </enumeration>
  <enumeration value="0062042">
    <annotation>
      <documentation>andere</documentation>
    </annotation>
  </enumeration>
</restriction>
```

	<code></simpleType></code>
--	----------------------------------

simpleType enum_0065

namespace	http://xml.ir-d.de/irdsaa												
type	restriction of string												
properties	base xs:string												
facets	<table><thead><tr><th>Kind</th><th>Value</th><th>Annotation</th></tr></thead><tbody><tr><td>enumeration</td><td>0065001</td><td>documentation stationär</td></tr><tr><td>enumeration</td><td>0065002</td><td>documentation teilstationär</td></tr><tr><td>enumeration</td><td>0065003</td><td>documentation ambulant</td></tr></tbody></table>	Kind	Value	Annotation	enumeration	0065001	documentation stationär	enumeration	0065002	documentation teilstationär	enumeration	0065003	documentation ambulant
Kind	Value	Annotation											
enumeration	0065001	documentation stationär											
enumeration	0065002	documentation teilstationär											
enumeration	0065003	documentation ambulant											
annotation	documentation Kat_ArtAufenthalt												
source	<pre><simpleType name="enum_0065"> <annotation> <documentation>Kat_ArtAufenthalt</documentation> </annotation> <restriction base="xs:string"> <enumeration value="0065001"> <annotation> <documentation>stationär</documentation> </annotation> </enumeration> <enumeration value="0065002"> <annotation> <documentation>teilstationär</documentation> </annotation> </enumeration> <enumeration value="0065003"> <annotation> <documentation>ambulant</documentation> </annotation> </enumeration> </restriction> </simpleType></pre>												

simpleType enum_0067

namespace	http://xml.ir-d.de/irdsaa									
type	restriction of string									
properties	base xs:string									
facets	<table><thead><tr><th>Kind</th><th>Value</th><th>Annotation</th></tr></thead><tbody><tr><td>enumeration</td><td>0067001</td><td>documentation Implantat</td></tr><tr><td>enumeration</td><td>0067002</td><td>documentation Explantat</td></tr></tbody></table>	Kind	Value	Annotation	enumeration	0067001	documentation Implantat	enumeration	0067002	documentation Explantat
Kind	Value	Annotation								
enumeration	0067001	documentation Implantat								
enumeration	0067002	documentation Explantat								
annotation	documentation Kat_ArtArtikel									
source	<pre><simpleType name="enum_0067"> <annotation> <documentation>Kat_ArtArtikel</documentation> </annotation> </simpleType></pre>									

	<pre> </annotation> <restriction base="xs:string"> <enumeration value="0067001"> <annotation> <documentation>Implantat</documentation> </annotation> </enumeration> <enumeration value="0067002"> <annotation> <documentation>Explantat</documentation> </annotation> </enumeration> </restriction> </simpleType> </pre>
--	--

simpleType enum_0068

namespace	http://xml.ir-d.de/irdsaa		
type	restriction of string		
properties	base xs:string		
facets	Kind	Value	Annotation
	enumeration	0068001	documentation UDI
	enumeration	0068002	documentation Referenz (REF)
annotation	documentation Kat_KennzeichenTyp		
source	<pre> <simpleType name="enum_0068"> <annotation> <documentation>Kat_KennzeichenTyp</documentation> </annotation> <restriction base="xs:string"> <enumeration value="0068001"> <annotation> <documentation>UDI</documentation> </annotation> </enumeration> <enumeration value="0068002"> <annotation> <documentation>Referenz (REF)</documentation> </annotation> </enumeration> </restriction> </simpleType> </pre>		

simpleType enum_0069

namespace	http://xml.ir-d.de/irdsaa		
type	restriction of string		
properties	base xs:string		
facets	Kind	Value	Annotation
	enumeration	0069001	documentation Implantat
	enumeration	0069002	documentation

	Explantat
annotation	documentation Kat ArtZubehoer
source	<pre> <simpleType name="enum_0069"> <annotation> <documentation>Kat_ArtZubehoer</documentation> </annotation> <restriction base="xs:string"> <enumeration value="0069001"> <annotation> <documentation>Implantat</documentation> </annotation> </enumeration> <enumeration value="0069002"> <annotation> <documentation>Explantat</documentation> </annotation> </enumeration> </restriction> </simpleType> </pre>

simpleType enum_0070

namespace	http://xml.ir-d.de/irdsaa		
type	restriction of string		
properties	base xs:string		
facets	Kind	Value	Annotation
	enumeration	0070001	documentation weiblich
	enumeration	0070002	documentation männlich
	enumeration	0070003	documentation divers
	enumeration	0070042	documentation unbestimmt
annotation	documentation Kat Geschlecht		
source	<pre> <simpleType name="enum_0070"> <annotation> <documentation>Kat_Geschlecht</documentation> </annotation> <restriction base="xs:string"> <enumeration value="0070001"> <annotation> <documentation>weiblich</documentation> </annotation> </enumeration> <enumeration value="0070002"> <annotation> <documentation>männlich</documentation> </annotation> </enumeration> <enumeration value="0070003"> <annotation> <documentation>divers</documentation> </annotation> </enumeration> </restriction> </simpleType> </pre>		

	<pre> <enumeration value="0070042"> <annotation> <documentation>unbestimmt</documentation> </annotation> </enumeration> </restriction> </simpleType> </pre>
--	---

simpleType enum_0071

namespace	http://xml.ir-d.de/irdsaa		
type	restriction of string		
properties	base xs:string		
facets	Kind	Value	Annotation
	enumeration	0071001	documentation Implantat
	enumeration	0071002	documentation Explantat
	enumeration	0071003	documentation Degeneriertes/defektes Produkt, das funktionslos im Körper verbleibt
annotation	documentation Kat_ArtikelArtFunktion		
source	<pre> <simpleType name="enum_0071"> <annotation> <documentation>Kat_ArtikelArtFunktion</documentation> </annotation> <restriction base="xs:string"> <enumeration value="0071001"> <annotation> <documentation>Implantat</documentation> </annotation> </enumeration> <enumeration value="0071002"> <annotation> <documentation>Explantat</documentation> </annotation> </enumeration> <enumeration value="0071003"> <annotation> <documentation>Degeneriertes/defektes Produkt, das funktionslos im Körper verbleibt</documentation> </annotation> </enumeration> </restriction> </simpleType> </pre>		

simpleType enum_0075

namespace	http://xml.ir-d.de/irdsaa		
type	restriction of string		
properties	base xs:string		
facets	Kind	Value	Annotation
	enumeration	0075001	documentation elektiv

	enumeration 0075002 documentation dringlich enumeration 0075003 documentation Notfall
annotation	documentation Kat_Dringlichkeit
source	<pre> <simpleType name="enum_0075"> <annotation> <documentation>Kat_Dringlichkeit</documentation> </annotation> <restriction base="xs:string"> <enumeration value="0075001"> <annotation> <documentation>elektiv</documentation> </annotation> </enumeration> <enumeration value="0075002"> <annotation> <documentation>dringlich</documentation> </annotation> </enumeration> <enumeration value="0075003"> <annotation> <documentation>Notfall</documentation> </annotation> </enumeration> </restriction> </simpleType> </pre>

simpleType enum 0076

namespace	http://xml.ir-d.de/irdsaa		
type	restriction of string		
properties	base xs:string		
facets	Kind	Value	Annotation
	enumeration	0076001	documentation elektiv
	enumeration	0076002	documentation dringlich
	enumeration	0076003	documentation Notfall
	enumeration	0076004	documentation Notfall (Reanimation / ultima ratio)
annotation	documentation Kat_Dringlichkeit_Reanimation		
source	<pre> <simpleType name="enum_0076"> <annotation> <documentation>Kat_Dringlichkeit_Reanimation</documentation> </annotation> <restriction base="xs:string"> <enumeration value="0076001"> <annotation> <documentation>elektiv</documentation> </annotation> </enumeration> <enumeration value="0076002"> <annotation> </pre>		

	<pre> <documentation>dringlich</documentation> </annotation> </enumeration> <enumeration value="0076003"> <annotation> <documentation>Notfall</documentation> </annotation> </enumeration> <enumeration value="0076004"> <annotation> <documentation>Notfall (Reanimation / ultima ratio)</documentation> </annotation> </enumeration> </restriction> </simpleType> </pre>
--	--

simpleType enum 0080

namespace	http://xml.ir-d.de/irdsaa		
type	restriction of string		
properties	base xs:string		
facets	Kind	Value	Annotation
	enumeration	0080001	documentation Endoprothese Hüfte/Knie
	enumeration	0080002	documentation Brustimplantat
	enumeration	0080003	documentation Aortenklappenprothese
annotation	documentation Kat_Implantattyp		
source	<pre> <simpleType name="enum_0080"> <annotation> <documentation>Kat_Implantattyp</documentation> </annotation> <restriction base="xs:string"> <enumeration value="0080001"> <annotation> <documentation>Endoprothese Hüfte/Knie</documentation> </annotation> </enumeration> <enumeration value="0080002"> <annotation> <documentation>Brustimplantat</documentation> </annotation> </enumeration> <enumeration value="0080003"> <annotation> <documentation>Aortenklappenprothese</documentation> </annotation> </enumeration> </restriction> </simpleType> </pre>		

simpleType enum_0100

namespace	http://xml.ir-d.de/irdsaa		
type	restriction of string		
properties	base xs:string		
facets	Kind	Value	Annotation
	enumeration	0100002	documentation Austausch Expander gegen dauerhaftes Brustimplantat
	enumeration	0100003	documentation Wechsel
	enumeration	0100004	documentation Nur Explantation
	enumeration	0100005	documentation Ersteingriff
	enumeration	0100006	documentation Zweizeitige Implantation
annotation	documentation Kat_BI_ArtEingriff		
source	<pre> <simpleType name="enum_0100"> <annotation> <documentation>Kat_BI_ArtEingriff</documentation> </annotation> <restriction base="xs:string"> <enumeration value="0100002"> <annotation> <documentation>Austausch Expander gegen dauerhaftes Brustimplantat</documentation> </annotation> </enumeration> <enumeration value="0100003"> <annotation> <documentation>Wechsel</documentation> </annotation> </enumeration> <enumeration value="0100004"> <annotation> <documentation>Nur Explantation</documentation> </annotation> </enumeration> <enumeration value="0100005"> <annotation> <documentation>Ersteingriff</documentation> </annotation> </enumeration> <enumeration value="0100006"> <annotation> <documentation>Zweizeitige Implantation</documentation> </annotation> </enumeration> </restriction> </simpleType> </pre>		

simpleType enum_0102

namespace	http://xml.ir-d.de/irdsaa
type	restriction of string

properties	base xs:string															
facets	<table border="1"> <thead> <tr> <th>Kind</th> <th>Value</th> <th>Annotation</th> </tr> </thead> <tbody> <tr> <td>enumeration</td> <td>0102001</td> <td>documentation kosmetische Augmentation</td> </tr> <tr> <td>enumeration</td> <td>0102002</td> <td>documentation Rekonstruktion, benigne</td> </tr> <tr> <td>enumeration</td> <td>0102003</td> <td>documentation Rekonstruktion nach Mastektomie aufgrund eines Karzinoms</td> </tr> <tr> <td>enumeration</td> <td>0102004</td> <td>documentation Rekonstruktion nach risikoreduzierender Mastektomie</td> </tr> </tbody> </table>	Kind	Value	Annotation	enumeration	0102001	documentation kosmetische Augmentation	enumeration	0102002	documentation Rekonstruktion, benigne	enumeration	0102003	documentation Rekonstruktion nach Mastektomie aufgrund eines Karzinoms	enumeration	0102004	documentation Rekonstruktion nach risikoreduzierender Mastektomie
Kind	Value	Annotation														
enumeration	0102001	documentation kosmetische Augmentation														
enumeration	0102002	documentation Rekonstruktion, benigne														
enumeration	0102003	documentation Rekonstruktion nach Mastektomie aufgrund eines Karzinoms														
enumeration	0102004	documentation Rekonstruktion nach risikoreduzierender Mastektomie														
annotation	documentation Kat_BI_GrundPrimaereingriff															
source	<pre> <simpleType name="enum_0102"> <annotation> <documentation>Kat_BI_GrundPrimaereingriff</documentation> </annotation> <restriction base="xs:string"> <enumeration value="0102001"> <annotation> <documentation>kosmetische Augmentation</documentation> </annotation> </enumeration> <enumeration value="0102002"> <annotation> <documentation>Rekonstruktion, benigne</documentation> </annotation> </enumeration> <enumeration value="0102003"> <annotation> <documentation>Rekonstruktion nach Mastektomie aufgrund eines Karzinoms</documentation> </annotation> </enumeration> <enumeration value="0102004"> <annotation> <documentation>Rekonstruktion nach risikoreduzierender Mastektomie</documentation> </annotation> </enumeration> </restriction> </simpleType> </pre>															

simpleType enum_0103

namespace	http://xml.ir-d.de/irdsaa																		
type	restriction of string																		
properties	base xs:string																		
facets	<table border="1"> <thead> <tr> <th>Kind</th> <th>Value</th> <th>Annotation</th> </tr> </thead> <tbody> <tr> <td>enumeration</td> <td>0103001</td> <td>documentation simultane Lappendeckung</td> </tr> <tr> <td>enumeration</td> <td>0103002</td> <td>documentation simultane Eigenfettransplantation</td> </tr> <tr> <td>enumeration</td> <td>0103003</td> <td>documentation simultane Mastopexie</td> </tr> <tr> <td>enumeration</td> <td>0103005</td> <td>documentation simultane Mastektomie, Ablatio / hautsparend</td> </tr> <tr> <td>enumeration</td> <td>0103006</td> <td>documentation</td> </tr> </tbody> </table>	Kind	Value	Annotation	enumeration	0103001	documentation simultane Lappendeckung	enumeration	0103002	documentation simultane Eigenfettransplantation	enumeration	0103003	documentation simultane Mastopexie	enumeration	0103005	documentation simultane Mastektomie, Ablatio / hautsparend	enumeration	0103006	documentation
Kind	Value	Annotation																	
enumeration	0103001	documentation simultane Lappendeckung																	
enumeration	0103002	documentation simultane Eigenfettransplantation																	
enumeration	0103003	documentation simultane Mastopexie																	
enumeration	0103005	documentation simultane Mastektomie, Ablatio / hautsparend																	
enumeration	0103006	documentation																	

	<p>enumeration 0103007 simultane Mastektomie, nippelerhaltend documentation Axilla-Dissektion</p> <p>enumeration 0103008 simultane Mastektomie, nippelerhaltend documentation Drainage</p>
annotation	documentation Kat_BI_OperationsdetailPrimaereingriff
source	<pre> <simpleType name="enum_0103"> <annotation> <documentation>Kat_BI_OperationsdetailPrimaereingriff</documentation> </annotation> <restriction base="xs:string"> <enumeration value="0103001"> <annotation> <documentation>simultane Lappendeckung</documentation> </annotation> </enumeration> <enumeration value="0103002"> <annotation> <documentation>simultane Eigenfetttransplantation</documentation> </annotation> </enumeration> <enumeration value="0103003"> <annotation> <documentation>simultane Mastopexie</documentation> </annotation> </enumeration> <enumeration value="0103005"> <annotation> <documentation>simultane Mastektomie, Ablatio / hautsparend</documentation> </annotation> </enumeration> <enumeration value="0103006"> <annotation> <documentation>simultane Mastektomie, nippelerhaltend</documentation> </annotation> </enumeration> <enumeration value="0103007"> <annotation> <documentation>Axilla-Dissektion</documentation> </annotation> </enumeration> <enumeration value="0103008"> <annotation> <documentation>Drainage</documentation> </annotation> </enumeration> </restriction> </simpleType> </pre>

simpleType enum_0104

namespace	http://xml.ir-d.de/irdsaa
type	restriction of string
properties	base xs:string

facets	Kind enumeration	Value 0104001	Annotation documentation Austausch Expander gegen dauerhaftes Brustimplantat
annotation	documentation Kat_BI_GrundAustausch		
source	<pre><simpleType name="enum_0104"> <annotation> <documentation>Kat_BI_GrundAustausch</documentation> </annotation> <restriction base="xs:string"> <enumeration value="0104001"> <annotation> <documentation>Austausch Expander gegen dauerhaftes Brustimplantat</documentation> </annotation> </enumeration> </restriction> </simpleType></pre>		

simpleType enum_0105

namespace	http://xml.ir-d.de/irdsaa		
type	restriction of string		
properties	base xs:string		
facets	Kind	Value	Annotation
	enumeration	0105001	documentation simultane Lappendeckung
	enumeration	0105002	documentation simultane Eigenfetttransplantation
	enumeration	0105003	documentation simultane Mastopexie
	enumeration	0105008	documentation Drainage
	enumeration	0105009	documentation Kapsulektomie, komplett
	enumeration	0105010	documentation Kapsulektomie, partiell
	enumeration	0105011	documentation Neopocket
annotation	documentation Kat_BI_OperationsdetailAustausch		
source	<pre><simpleType name="enum_0105"> <annotation> <documentation>Kat_BI_OperationsdetailAustausch</documentation> </annotation> <restriction base="xs:string"> <enumeration value="0105001"> <annotation> <documentation>simultane Lappendeckung</documentation> </annotation> </enumeration> <enumeration value="0105002"> <annotation> <documentation>simultane Eigenfetttransplantation</documentation> </annotation> </enumeration> <enumeration value="0105003"> <annotation></pre>		

	<pre> <documentation>simultane Mastopexie</documentation> </annotation> </enumeration> <enumeration value="0105008"> <annotation> <documentation>Drainage</documentation> </annotation> </enumeration> <enumeration value="0105009"> <annotation> <documentation>Kapsulektomie, komplett</documentation> </annotation> </enumeration> <enumeration value="0105010"> <annotation> <documentation>Kapsulektomie, partiell</documentation> </annotation> </enumeration> <enumeration value="0105011"> <annotation> <documentation>Neopocket</documentation> </annotation> </enumeration> </restriction> </simpleType> </pre>
--	---

simpleType enum_0106

namespace	http://xml.ir-d.de/irdsaa		
type	restriction of string		
properties	base xs:string		
facets	Kind	Value	Annotation
	enumeration	0106001	documentation Patientenwunsch
	enumeration	0106002	documentation asymptomatisch
	enumeration	0106003	documentation Komplikation
annotation	documentation Kat_BI_GrundRevisionExplantation		
source	<pre> <simpleType name="enum_0106"> <annotation> <documentation>Kat_BI_GrundRevisionExplantation</documentation> </annotation> <restriction base="xs:string"> <enumeration value="0106001"> <annotation> <documentation>Patientenwunsch</documentation> </annotation> </enumeration> <enumeration value="0106002"> <annotation> <documentation>asymptomatisch</documentation> </annotation> </enumeration> <enumeration value="0106003"> <annotation> </pre>		

```

    <documentation>Komplikation</documentation>
  </annotation>
</enumeration>
</restriction>
</simpleType>

```

simpleType enum_0107

namespace	http://xml.ir-d.de/irdsaa		
type	restriction of string		
properties	base xs:string		
facets	Kind	Value	Annotation
	enumeration	0107001	documentation simultane Lappendeckung
	enumeration	0107002	documentation simultane Eigenfetttransplantation
	enumeration	0107003	documentation simultane Mastopexie
	enumeration	0107005	documentation simultane Mastektomie, Ablatio / hautsparend
	enumeration	0107006	documentation simultane Mastektomie, nippelerhaltend
	enumeration	0107007	documentation Axilla-Dissektion
	enumeration	0107008	documentation Drainage
	enumeration	0107009	documentation Kapsulektomie, komplett
	enumeration	0107010	documentation Kapsulektomie, partiell
	enumeration	0107011	documentation Neopocket
annotation	documentation Kat_BI_OperationsdetailRevision		
source	<pre> <simpleType name="enum_0107"> <annotation> <documentation>Kat_BI_OperationsdetailRevision</documentation> </annotation> <restriction base="xs:string"> <enumeration value="0107001"> <annotation> <documentation>simultane Lappendeckung</documentation> </annotation> </enumeration> <enumeration value="0107002"> <annotation> <documentation>simultane Eigenfetttransplantation</documentation> </annotation> </enumeration> <enumeration value="0107003"> <annotation> <documentation>simultane Mastopexie</documentation> </annotation> </enumeration> <enumeration value="0107005"> <annotation> <documentation>simultane Mastektomie, Ablatio / hautsparend</documentation> </pre>		

	<pre> </annotation> </enumeration> <enumeration value="0107006"> <annotation> <documentation>simultane Mastektomie, nippelerhaltend</documentation> </annotation> </enumeration> <enumeration value="0107007"> <annotation> <documentation>Axilla-Dissektion</documentation> </annotation> </enumeration> <enumeration value="0107008"> <annotation> <documentation>Drainage</documentation> </annotation> </enumeration> <enumeration value="0107009"> <annotation> <documentation>Kapsulektomie, komplett</documentation> </annotation> </enumeration> <enumeration value="0107010"> <annotation> <documentation>Kapsulektomie, partiell</documentation> </annotation> </enumeration> <enumeration value="0107011"> <annotation> <documentation>Neopocket</documentation> </annotation> </enumeration> </restriction> </simpleType> </pre>
--	--

simpleType enum_0110

namespace	http://xml.lir-d.de/irdsaa						
type	restriction of string						
properties	base xs:string						
facets	<table border="1"> <thead> <tr> <th>Kind</th> <th>Value</th> <th>Annotation</th> </tr> </thead> <tbody> <tr> <td>enumeration</td> <td>0110001</td> <td>documentation Bestrahlung</td> </tr> </tbody> </table>	Kind	Value	Annotation	enumeration	0110001	documentation Bestrahlung
Kind	Value	Annotation					
enumeration	0110001	documentation Bestrahlung					
annotation	documentation Kat_BI_VorbehandlungLokal						
source	<pre> <simpleType name="enum_0110"> <annotation> <documentation>Kat_BI_VorbehandlungLokal</documentation> </annotation> <restriction base="xs:string"> <enumeration value="0110001"> <annotation> <documentation>Bestrahlung</documentation> </annotation> </enumeration> </restriction> </pre>						

	<code></simpleType></code>
--	----------------------------------

simpleType enum_0111

namespace	http://xml.ir-d.de/irdsaa		
type	restriction of string		
properties	base xs:string		
facets	Kind	Value	Annotation
	enumeration	0111001	documentation nein
	enumeration	0111002	documentation Lipofilling
	enumeration	0111003	documentation Eigengewebstrekonstruktion
annotation	documentation Kat_BI_Verfahrenswechsel		
source	<pre> <simpleType name="enum_0111"> <annotation> <documentation>Kat_BI_Verfahrenswechsel</documentation> </annotation> <restriction base="xs:string"> <enumeration value="0111001"> <annotation> <documentation>nein</documentation> </annotation> </enumeration> <enumeration value="0111002"> <annotation> <documentation>Lipofilling</documentation> </annotation> </enumeration> <enumeration value="0111003"> <annotation> <documentation>Eigengewebstrekonstruktion</documentation> </annotation> </enumeration> </restriction> </simpleType> </pre>		

simpleType enum_0112

namespace	http://xml.ir-d.de/irdsaa		
type	restriction of string		
properties	base xs:string		
facets	Kind	Value	Annotation
	enumeration	0112001	documentation subglandulär / epipektoral
	enumeration	0112002	documentation subpektoral
	enumeration	0112003	documentation subfaszial
	enumeration	0112004	documentation sub-flap
	enumeration	0112005	documentation subkutan

	enumeration 0112006 documentation dual plane enumeration 0112042 documentation andere
annotation	documentation Kat_BI_LageImplantat
source	<pre> <simpleType name="enum_0112"> <annotation> <documentation>Kat_BI_LageImplantat</documentation> </annotation> <restriction base="xs:string"> <enumeration value="0112001"> <annotation> <documentation>subglandulär / epipektoral</documentation> </annotation> </enumeration> <enumeration value="0112002"> <annotation> <documentation>subpektoral</documentation> </annotation> </enumeration> <enumeration value="0112003"> <annotation> <documentation>subfaszial</documentation> </annotation> </enumeration> <enumeration value="0112004"> <annotation> <documentation>sub-flap</documentation> </annotation> </enumeration> <enumeration value="0112005"> <annotation> <documentation>subkutan</documentation> </annotation> </enumeration> <enumeration value="0112006"> <annotation> <documentation>dual plane</documentation> </annotation> </enumeration> <enumeration value="0112042"> <annotation> <documentation>andere</documentation> </annotation> </enumeration> </restriction> </simpleType> </pre>

simpleType enum_0113

namespace	http://xml.ir-d.de/irdsaa		
type	restriction of string		
properties	base xs:string		
facets	Kind enumeration	Value 0113001	Annotation documentation Chemotherapie innerhalb der letzten drei Monate

annotation	documentation Kat_BI_VorbehandlungSystemisch
source	<pre> <simpleType name="enum_0113"> <annotation> <documentation>Kat_BI_VorbehandlungSystemisch</documentation> </annotation> <restriction base="xs:string"> <enumeration value="0113001"> <annotation> <documentation>Chemotherapie innerhalb der letzten drei Monate</documentation> </annotation> </enumeration> </restriction> </simpleType> </pre>

simpleType enum_0114

namespace	http://xml.ir-d.de/irdsaa		
type	restriction of string		
properties	base xs:string		
facets	Kind	Value	Annotation
	enumeration	0114001	documentation vollständig
	enumeration	0114002	documentation nein
	enumeration	0114003	documentation teilweise
	enumeration	0114004	documentation nicht vorhanden
annotation	documentation Kat_BI_EntfernungADMNetz		
source	<pre> <simpleType name="enum_0114"> <annotation> <documentation>Kat_BI_EntfernungADMNetz</documentation> </annotation> <restriction base="xs:string"> <enumeration value="0114001"> <annotation> <documentation>vollständig</documentation> </annotation> </enumeration> <enumeration value="0114002"> <annotation> <documentation>nein</documentation> </annotation> </enumeration> <enumeration value="0114003"> <annotation> <documentation>teilweise</documentation> </annotation> </enumeration> <enumeration value="0114004"> <annotation> <documentation>nicht vorhanden</documentation> </annotation> </enumeration> </restriction> </simpleType> </pre>		

```

</restriction>
</simpleType>

```

simpleType enum_0116

namespace	http://xml.ir-d.de/irdsaa		
type	restriction of string		
properties	base xs:string		
facets	Kind	Value	Annotation
	enumeration	0116001	documentation Spülung, antibiotisch
	enumeration	0116002	documentation Spülung, antiseptisch
	enumeration	0116003	documentation Spülung, wirkstofffrei
	enumeration	0116004	documentation Spülung, andere
	enumeration	0116005	documentation prä-/perioperative Antibiotika
	enumeration	0116006	documentation postoperative Antibiotika
	enumeration	0116007	documentation Handschuhwechsel vor Implantation
	enumeration	0116008	documentation Implantationshilfe
annotation	documentation Kat_BI_Operationsmassnahme		
source	<pre> <simpleType name="enum_0116"> <annotation> <documentation>Kat_BI_Operationsmassnahme</documentation> </annotation> <restriction base="xs:string"> <enumeration value="0116001"> <annotation> <documentation>Spülung, antibiotisch</documentation> </annotation> </enumeration> <enumeration value="0116002"> <annotation> <documentation>Spülung, antiseptisch</documentation> </annotation> </enumeration> <enumeration value="0116003"> <annotation> <documentation>Spülung, wirkstofffrei</documentation> </annotation> </enumeration> <enumeration value="0116004"> <annotation> <documentation>Spülung, andere</documentation> </annotation> </enumeration> <enumeration value="0116005"> <annotation> <documentation>prä-/perioperative Antibiotika</documentation> </annotation> </enumeration> <enumeration value="0116006"> </pre>		

	<pre> <annotation> <documentation>postoperative Antibiotika</documentation> </annotation> </enumeration> <enumeration value="0116007"> <annotation> <documentation>Handschuhwechsel vor Implantation</documentation> </annotation> </enumeration> <enumeration value="0116008"> <annotation> <documentation>Implantationshilfe</documentation> </annotation> </enumeration> </restriction> </simpleType> </pre>
--	---

simpleType enum_0118

namespace	http://xml.ir-d.de/irdsaa		
type	restriction of string		
properties	base xs:string		
facets	Kind	Value	Annotation
	enumeration	0118001	documentation axillär
	enumeration	0118002	documentation periareolär
	enumeration	0118003	documentation inframammär
	enumeration	0118004	documentation Mastektomienarbe
	enumeration	0118042	documentation anderer
annotation	documentation Kat_BI_Operationszugang		
source	<pre> <simpleType name="enum_0118"> <annotation> <documentation>Kat_BI_Operationszugang</documentation> </annotation> <restriction base="xs:string"> <enumeration value="0118001"> <annotation> <documentation>axillär</documentation> </annotation> </enumeration> <enumeration value="0118002"> <annotation> <documentation>periareolär</documentation> </annotation> </enumeration> <enumeration value="0118003"> <annotation> <documentation>inframammär</documentation> </annotation> </enumeration> <enumeration value="0118004"> <annotation> </pre>		

	<pre> <documentation>Mastektomienarbe</documentation> </annotation> </enumeration> <enumeration value="0118042"> <annotation> <documentation>anderer</documentation> </annotation> </enumeration> </restriction> </simpleType> </pre>
--	---

simpleType enum_0120

namespace	http://xml.ir-d.de/irdsaa		
type	restriction of string		
properties	base xs:string		
facets	Kind	Value	Annotation
	enumeration	0120001	documentation Expander defekt
annotation	documentation Kat_BI_BefundAustausch		
source	<pre> <simpleType name="enum_0120"> <annotation> <documentation>Kat_BI_BefundAustausch</documentation> </annotation> <restriction base="xs:string"> <enumeration value="0120001"> <annotation> <documentation>Expander defekt</documentation> </annotation> </enumeration> </restriction> </simpleType> </pre>		

simpleType enum_0121

namespace	http://xml.ir-d.de/irdsaa		
type	restriction of string		
properties	base xs:string		
facets	Kind	Value	Annotation
	enumeration	0121001	documentation Infektion
	enumeration	0121002	documentation Serom
	enumeration	0121004	documentation Kapsel fibrose
	enumeration	0121005	documentation Implantatruptur
	enumeration	0121006	documentation Fehlpositionierung/Rotation
	enumeration	0121007	documentation BIA-ALCL/-BCL/-SCC, Verdacht
	enumeration	0121008	documentation BIA-ALCL/-BCL/-SCC, pathologisch bestätigt
	enumeration	0121009	documentation

	<p>enumeration 0121010 Brustschmerzen documentation Doppelkapsel</p> <p>enumeration 0121011 documentation Netz-/ADM-bedingte Komplikation, Non-Integration</p> <p>enumeration 0121012 documentation Netz-/ADM-bedingte Komplikation, andere</p> <p>enumeration 0121013 documentation Hautnekrose/exponiertes Implantat</p> <p>enumeration 0121014 documentation BII/ASIA (Brustimplantat assoziierte Symptome), Verdacht</p> <p>enumeration 0121015 documentation Lymphadenopathie</p> <p>enumeration 0121016 documentation Brustkrebs, neu aufgetreten/Rezidiv</p> <p>enumeration 0121042 documentation sonstiger</p>
annotation	documentation Kat BI BefundKomplett
source	<pre> <simpleType name="enum_0121"> <annotation> <documentation>Kat_BI_BefundKomplett</documentation> </annotation> <restriction base="xs:string"> <enumeration value="0121001"> <annotation> <documentation>Infektion</documentation> </annotation> </enumeration> <enumeration value="0121002"> <annotation> <documentation>Serom</documentation> </annotation> </enumeration> <enumeration value="0121004"> <annotation> <documentation>Kapsel fibrose</documentation> </annotation> </enumeration> <enumeration value="0121005"> <annotation> <documentation>Implantatruptur</documentation> </annotation> </enumeration> <enumeration value="0121006"> <annotation> <documentation>Fehlpositionierung/Rotation</documentation> </annotation> </enumeration> <enumeration value="0121007"> <annotation> <documentation>BIA-ALCL/-BCL/-SCC, Verdacht</documentation> </annotation> </enumeration> <enumeration value="0121008"> <annotation> <documentation>BIA-ALCL/-BCL/-SCC, pathologisch bestätigt</documentation> </annotation> </enumeration> </restriction> </simpleType> </pre>

```

<enumeration value="0121009">
  <annotation>
    <documentation>Brustschmerzen</documentation>
  </annotation>
</enumeration>
<enumeration value="0121010">
  <annotation>
    <documentation>Doppelkapsel</documentation>
  </annotation>
</enumeration>
<enumeration value="0121011">
  <annotation>
    <documentation>Netz-/ADM-bedingte Komplikation, Non-
Integration</documentation>
  </annotation>
</enumeration>
<enumeration value="0121012">
  <annotation>
    <documentation>Netz-/ADM-bedingte Komplikation,
andere</documentation>
  </annotation>
</enumeration>
<enumeration value="0121013">
  <annotation>
    <documentation>Hautnekrose/exponiertes Implantat</documentation>
  </annotation>
</enumeration>
<enumeration value="0121014">
  <annotation>
    <documentation>BII/ASIA (Brustimplantat assoziierte Symptome),
Verdacht</documentation>
  </annotation>
</enumeration>
<enumeration value="0121015">
  <annotation>
    <documentation>Lymphadenopathie</documentation>
  </annotation>
</enumeration>
<enumeration value="0121016">
  <annotation>
    <documentation>Brustkrebs, neu aufgetreten/Rezidiv</documentation>
  </annotation>
</enumeration>
<enumeration value="0121042">
  <annotation>
    <documentation>sonstiger</documentation>
  </annotation>
</enumeration>
</restriction>
</simpleType>

```

simpleType enum_0122

namespace	http://xml.ir-d.de/irdsaa
type	restriction of string
properties	base xs:string

facets	<table border="1"> <thead> <tr> <th>Kind</th> <th>Value</th> <th>Annotation</th> </tr> </thead> <tbody> <tr> <td>enumeration</td> <td>0122001</td> <td>documentation ja, ärztlich nachgewiesen</td> </tr> <tr> <td>enumeration</td> <td>0122002</td> <td>documentation nein</td> </tr> <tr> <td>enumeration</td> <td>0122042</td> <td>documentation unbekannt</td> </tr> </tbody> </table>	Kind	Value	Annotation	enumeration	0122001	documentation ja, ärztlich nachgewiesen	enumeration	0122002	documentation nein	enumeration	0122042	documentation unbekannt
Kind	Value	Annotation											
enumeration	0122001	documentation ja, ärztlich nachgewiesen											
enumeration	0122002	documentation nein											
enumeration	0122042	documentation unbekannt											
annotation	documentation Kat_BI_Autoimmunerkrankung												
source	<pre> <simpleType name="enum_0122"> <annotation> <documentation>Kat_BI_Autoimmunerkrankung</documentation> </annotation> <restriction base="xs:string"> <enumeration value="0122001"> <annotation> <documentation>ja, ärztlich nachgewiesen</documentation> </annotation> </enumeration> <enumeration value="0122002"> <annotation> <documentation>nein</documentation> </annotation> </enumeration> <enumeration value="0122042"> <annotation> <documentation>unbekannt</documentation> </annotation> </enumeration> </restriction> </simpleType> </pre>												

simpleType enum_0123

namespace	http://xml.ir-d.de/irdsaa																		
type	restriction of string																		
properties	base xs:string																		
facets	<table border="1"> <thead> <tr> <th>Kind</th> <th>Value</th> <th>Annotation</th> </tr> </thead> <tbody> <tr> <td>enumeration</td> <td>0123001</td> <td>documentation neu aufgetreten</td> </tr> <tr> <td>enumeration</td> <td>0123002</td> <td>documentation verschlechtert</td> </tr> <tr> <td>enumeration</td> <td>0123003</td> <td>documentation keine Veränderung</td> </tr> <tr> <td>enumeration</td> <td>0123004</td> <td>documentation nicht relevant, da Primäreingriff</td> </tr> <tr> <td>enumeration</td> <td>0123042</td> <td>documentation unbekannt</td> </tr> </tbody> </table>	Kind	Value	Annotation	enumeration	0123001	documentation neu aufgetreten	enumeration	0123002	documentation verschlechtert	enumeration	0123003	documentation keine Veränderung	enumeration	0123004	documentation nicht relevant, da Primäreingriff	enumeration	0123042	documentation unbekannt
Kind	Value	Annotation																	
enumeration	0123001	documentation neu aufgetreten																	
enumeration	0123002	documentation verschlechtert																	
enumeration	0123003	documentation keine Veränderung																	
enumeration	0123004	documentation nicht relevant, da Primäreingriff																	
enumeration	0123042	documentation unbekannt																	
annotation	documentation Kat_BI_VerlaufAutoimmunerkrankung																		
source	<pre> <simpleType name="enum_0123"> <annotation> <documentation>Kat_BI_VerlaufAutoimmunerkrankung</documentation> </annotation> <restriction base="xs:string"> <enumeration value="0123001"> <annotation> <documentation>neu aufgetreten</documentation> </annotation> </enumeration> </restriction> </simpleType> </pre>																		

	<pre> </annotation> </enumeration> <enumeration value="0123002"> <annotation> <documentation>verschlechtert</documentation> </annotation> </enumeration> <enumeration value="0123003"> <annotation> <documentation>keine Veränderung</documentation> </annotation> </enumeration> <enumeration value="0123004"> <annotation> <documentation>nicht relevant, da Primäreingriff</documentation> </annotation> </enumeration> <enumeration value="0123042"> <annotation> <documentation>unbekannt</documentation> </annotation> </enumeration> </restriction> </simpleType> </pre>
--	---

simpleType enum_0124

namespace	http://xml.ir-d.de/irdsaa		
type	restriction of string		
properties	base xs:string		
facets	Kind	Value	Annotation
	enumeration	0124001	documentation Salzlösung
	enumeration	0124002	documentation Silikongel
	enumeration	0124003	documentation Kombination Silikongel und Salzlösung
	enumeration	0124042	documentation sonstige
annotation	documentation Kat_BI_Fuellung		
source	<pre> <simpleType name="enum_0124"> <annotation> <documentation>Kat_BI_Fuellung</documentation> </annotation> <restriction base="xs:string"> <enumeration value="0124001"> <annotation> <documentation>Salzlösung</documentation> </annotation> </enumeration> <enumeration value="0124002"> <annotation> <documentation>Silikongel</documentation> </annotation> </enumeration> <enumeration value="0124003"> </pre>		

	<pre> <annotation> <documentation>Kombination Silikongel und Salzlösung</documentation> </annotation> </enumeration> <enumeration value="0124042"> <annotation> <documentation>sonstige</documentation> </annotation> </enumeration> </restriction> </simpleType> </pre>
--	--

simpleType enum_0126

namespace	http://xml.ir-d.de/irdsaa		
type	restriction of string		
properties	base xs:string		
facets	Kind	Value	Annotation
	enumeration	0126001	documentation anatomisch (tropfenförmig)
	enumeration	0126002	documentation rund (punktsymmetrisch)
	enumeration	0126042	documentation sonstige
annotation	documentation Kat_BI_Form		
source	<pre> <simpleType name="enum_0126"> <annotation> <documentation>Kat_BI_Form</documentation> </annotation> <restriction base="xs:string"> <enumeration value="0126001"> <annotation> <documentation>anatomisch (tropfenförmig)</documentation> </annotation> </enumeration> <enumeration value="0126002"> <annotation> <documentation>rund (punktsymmetrisch)</documentation> </annotation> </enumeration> <enumeration value="0126042"> <annotation> <documentation>sonstige</documentation> </annotation> </enumeration> </restriction> </simpleType> </pre>		

simpleType enum_0128

namespace	http://xml.ir-d.de/irdsaa		
type	restriction of string		
properties	base xs:string		

facets	<table border="1"> <thead> <tr> <th>Kind</th> <th>Value</th> <th>Annotation</th> </tr> </thead> <tbody> <tr> <td>enumeration</td> <td>0128001</td> <td>documentation glattwandig</td> </tr> <tr> <td>enumeration</td> <td>0128002</td> <td>documentation beschichtet</td> </tr> <tr> <td>enumeration</td> <td>0128003</td> <td>documentation texturiert</td> </tr> </tbody> </table>	Kind	Value	Annotation	enumeration	0128001	documentation glattwandig	enumeration	0128002	documentation beschichtet	enumeration	0128003	documentation texturiert
Kind	Value	Annotation											
enumeration	0128001	documentation glattwandig											
enumeration	0128002	documentation beschichtet											
enumeration	0128003	documentation texturiert											
annotation	documentation Kat_BI_Oberflaeche												
source	<pre> <simpleType name="enum_0128"> <annotation> <documentation>Kat_BI_Oberflaeche</documentation> </annotation> <restriction base="xs:string"> <enumeration value="0128001"> <annotation> <documentation>glattwandig</documentation> </annotation> </enumeration> <enumeration value="0128002"> <annotation> <documentation>beschichtet</documentation> </annotation> </enumeration> <enumeration value="0128003"> <annotation> <documentation>texturiert</documentation> </annotation> </enumeration> </restriction> </simpleType> </pre>												

simpleType enum_0131

namespace	http://xml.ir-d.de/irdsaa																																				
type	restriction of string																																				
properties	base xs:string																																				
facets	<table border="1"> <thead> <tr> <th>Kind</th> <th>Value</th> <th>Annotation</th> </tr> </thead> <tbody> <tr> <td>enumeration</td> <td>0131001</td> <td>documentation Allergan</td> </tr> <tr> <td>enumeration</td> <td>0131002</td> <td>documentation Establishment Labs</td> </tr> <tr> <td>enumeration</td> <td>0131003</td> <td>documentation Eurosilicone</td> </tr> <tr> <td>enumeration</td> <td>0131004</td> <td>documentation Galatea</td> </tr> <tr> <td>enumeration</td> <td>0131005</td> <td>documentation Integra</td> </tr> <tr> <td>enumeration</td> <td>0131006</td> <td>documentation Lifecell</td> </tr> <tr> <td>enumeration</td> <td>0131007</td> <td>documentation MBP (Medical Biomaterial Products)</td> </tr> <tr> <td>enumeration</td> <td>0131008</td> <td>documentation Mentor</td> </tr> <tr> <td>enumeration</td> <td>0131009</td> <td>documentation Novus Scientific</td> </tr> <tr> <td>enumeration</td> <td>0131010</td> <td>documentation pfmMedical</td> </tr> <tr> <td>enumeration</td> <td>0131011</td> <td>documentation</td> </tr> </tbody> </table>	Kind	Value	Annotation	enumeration	0131001	documentation Allergan	enumeration	0131002	documentation Establishment Labs	enumeration	0131003	documentation Eurosilicone	enumeration	0131004	documentation Galatea	enumeration	0131005	documentation Integra	enumeration	0131006	documentation Lifecell	enumeration	0131007	documentation MBP (Medical Biomaterial Products)	enumeration	0131008	documentation Mentor	enumeration	0131009	documentation Novus Scientific	enumeration	0131010	documentation pfmMedical	enumeration	0131011	documentation
Kind	Value	Annotation																																			
enumeration	0131001	documentation Allergan																																			
enumeration	0131002	documentation Establishment Labs																																			
enumeration	0131003	documentation Eurosilicone																																			
enumeration	0131004	documentation Galatea																																			
enumeration	0131005	documentation Integra																																			
enumeration	0131006	documentation Lifecell																																			
enumeration	0131007	documentation MBP (Medical Biomaterial Products)																																			
enumeration	0131008	documentation Mentor																																			
enumeration	0131009	documentation Novus Scientific																																			
enumeration	0131010	documentation pfmMedical																																			
enumeration	0131011	documentation																																			

	<p>enumeration 0131012 Serag Wiessner documentation nicht belegter Wert</p> <p>enumeration 0131013 documentation nicht belegter Wert</p> <p>enumeration 0131014 documentation nicht belegter Wert</p> <p>enumeration 0131015 documentation nicht belegter Wert</p> <p>enumeration 0131042 documentation sonstiger</p>
annotation	documentation Kat BI_ZubehoerHersteller
source	<pre> <simpleType name="enum_0131"> <annotation> <documentation>Kat_BI_ZubehoerHersteller</documentation> </annotation> <restriction base="xs:string"> <enumeration value="0131001"> <annotation> <documentation>Allergan</documentation> </annotation> </enumeration> <enumeration value="0131002"> <annotation> <documentation>Establishment Labs</documentation> </annotation> </enumeration> <enumeration value="0131003"> <annotation> <documentation>Eurosilicone</documentation> </annotation> </enumeration> <enumeration value="0131004"> <annotation> <documentation>Galatea</documentation> </annotation> </enumeration> <enumeration value="0131005"> <annotation> <documentation>Integra</documentation> </annotation> </enumeration> <enumeration value="0131006"> <annotation> <documentation>Lifecell</documentation> </annotation> </enumeration> <enumeration value="0131007"> <annotation> <documentation>MBP (Medical Biomaterial Products)</documentation> </annotation> </enumeration> <enumeration value="0131008"> <annotation> <documentation>Mentor</documentation> </annotation> </enumeration> <enumeration value="0131009"> <annotation> </pre>

```

    <documentation>Novus Scientific</documentation>
  </annotation>
</enumeration>
<enumeration value="0131010">
  <annotation>
    <documentation>pfmMedical</documentation>
  </annotation>
</enumeration>
<enumeration value="0131011">
  <annotation>
    <documentation>Serag Wiessner</documentation>
  </annotation>
</enumeration>
<enumeration value="0131012">
  <annotation>
    <documentation>nicht belegter Wert</documentation>
  </annotation>
</enumeration>
<enumeration value="0131013">
  <annotation>
    <documentation>nicht belegter Wert</documentation>
  </annotation>
</enumeration>
<enumeration value="0131014">
  <annotation>
    <documentation>nicht belegter Wert</documentation>
  </annotation>
</enumeration>
<enumeration value="0131015">
  <annotation>
    <documentation>nicht belegter Wert</documentation>
  </annotation>
</enumeration>
<enumeration value="0131042">
  <annotation>
    <documentation>sonstiger</documentation>
  </annotation>
</enumeration>
</restriction>
</simpleType>

```

simpleType enum_0170

namespace	http://xml.ir-d.de/irdsaa		
type	restriction of string		
properties	base xs:string		
facets	Kind	Value	Annotation
	enumeration	0170001	documentation weiblich
	enumeration	0170002	documentation männlich
	enumeration	0170003	documentation intersexuell
annotation	documentation Kat_BI_GeschlechtGeburt		
source	<simpleType name="enum_0170"> <annotation>		

	<pre> <documentation>Kat_BI_GeschlechtGeburt</documentation> </annotation> <restriction base="xs:string"> <enumeration value="0170001"> <annotation> <documentation>weiblich</documentation> </annotation> </enumeration> <enumeration value="0170002"> <annotation> <documentation>männlich</documentation> </annotation> </enumeration> <enumeration value="0170003"> <annotation> <documentation>intersexuell</documentation> </annotation> </enumeration> </restriction> </simpleType> </pre>
--	---

simpleType enum_0190

namespace	http://xml.ir-d.de/irdsaa		
type	restriction of string		
properties	base xs:string		
facets	Kind	Value	Annotation
	enumeration	0190001	documentation Brustimplantat
	enumeration	0190003	documentation Brustexpander
annotation	documentation Kat_BI_Artikeltyp		
source	<pre> <simpleType name="enum_0190"> <annotation> <documentation>Kat_BI_Artikeltyp</documentation> </annotation> <restriction base="xs:string"> <enumeration value="0190001"> <annotation> <documentation>Brustimplantat</documentation> </annotation> </enumeration> <enumeration value="0190003"> <annotation> <documentation>Brustexpander</documentation> </annotation> </enumeration> </restriction> </simpleType> </pre>		

simpleType enum_0191

namespace	http://xml.ir-d.de/irdsaa
-----------	---------------------------

type	restriction of string									
properties	base xs:string									
facets	<table border="1"> <thead> <tr> <th>Kind</th> <th>Value</th> <th>Annotation</th> </tr> </thead> <tbody> <tr> <td>enumeration</td> <td>0191001</td> <td>documentation Netz</td> </tr> <tr> <td>enumeration</td> <td>0191002</td> <td>documentation ADM</td> </tr> </tbody> </table>	Kind	Value	Annotation	enumeration	0191001	documentation Netz	enumeration	0191002	documentation ADM
Kind	Value	Annotation								
enumeration	0191001	documentation Netz								
enumeration	0191002	documentation ADM								
annotation	documentation Kat_BI_ZubehoerTyp									
source	<pre><simpleType name="enum_0191"> <annotation> <documentation>Kat_BI_ZubehoerTyp</documentation> </annotation> <restriction base="xs:string"> <enumeration value="0191001"> <annotation> <documentation>Netz</documentation> </annotation> </enumeration> <enumeration value="0191002"> <annotation> <documentation>ADM</documentation> </annotation> </enumeration> </restriction> </simpleType></pre>									

simpleType **enum_0200**

namespace	http://xml.ir-d.de/irdsaa									
type	restriction of string									
properties	base xs:string									
facets	<table border="1"> <thead> <tr> <th>Kind</th> <th>Value</th> <th>Annotation</th> </tr> </thead> <tbody> <tr> <td>enumeration</td> <td>0200001</td> <td>documentation Erst-OP</td> </tr> <tr> <td>enumeration</td> <td>0200002</td> <td>documentation Folgeingriff</td> </tr> </tbody> </table>	Kind	Value	Annotation	enumeration	0200001	documentation Erst-OP	enumeration	0200002	documentation Folgeingriff
Kind	Value	Annotation								
enumeration	0200001	documentation Erst-OP								
enumeration	0200002	documentation Folgeingriff								
annotation	documentation Kat_EP_ArtEingriff									
source	<pre><simpleType name="enum_0200"> <annotation> <documentation>Kat_EP_ArtEingriff</documentation> </annotation> <restriction base="xs:string"> <enumeration value="0200001"> <annotation> <documentation>Erst-OP</documentation> </annotation> </enumeration> <enumeration value="0200002"> <annotation> <documentation>Folgeingriff</documentation> </annotation> </enumeration> </restriction> </simpleType></pre>									

</simpleType>

simpleType enum_0202

namespace	http://xml.ir-d.de/irdsaa		
type	restriction of string		
properties	base xs:string		
facets	Kind	Value	Annotation
	enumeration	0202001	documentation Lockerung
	enumeration	0202002	documentation Infektion, Verdacht auf
	enumeration	0202003	documentation Infektion, gesichert
	enumeration	0202004	documentation Luxation, Inlay aus der Pfanne
	enumeration	0202005	documentation Luxation, Kopf aus Pfanne/Inlay
	enumeration	0202006	documentation Periprothetische Fraktur
	enumeration	0202007	documentation Verschleiß des PE-Inlays
	enumeration	0202008	documentation Implantatbruch
	enumeration	0202009	documentation Implantatfehlage/Malalignent
	enumeration	0202010	documentation Osteolysen bei festem Implantat
	enumeration	0202011	documentation Progression der Grunderkrankung
	enumeration	0202012	documentation ARMD
	enumeration	0202013	documentation Verdacht auf allergische Reaktion
	enumeration	0202042	documentation andere Gründe
annotation	documentation Kat_EP_GrundWechselHuefte		
source	<pre><simpleType name="enum_0202"> <annotation> <documentation>Kat_EP_GrundWechselHuefte</documentation> </annotation> <restriction base="xs:string"> <enumeration value="0202001"> <annotation> <documentation>Lockerung</documentation> </annotation> </enumeration> <enumeration value="0202002"> <annotation> <documentation>Infektion, Verdacht auf</documentation> </annotation> </enumeration> <enumeration value="0202003"> <annotation> <documentation>Infektion, gesichert</documentation> </annotation> </enumeration> <enumeration value="0202004"></pre>		

```

    <annotation>
      <documentation>Luxation, Inlay aus der Pfanne</documentation>
    </annotation>
  </enumeration>
  <enumeration value="0202005">
    <annotation>
      <documentation>Luxation, Kopf aus Pfanne/Inlay</documentation>
    </annotation>
  </enumeration>
  <enumeration value="0202006">
    <annotation>
      <documentation>Periprothetische Fraktur</documentation>
    </annotation>
  </enumeration>
  <enumeration value="0202007">
    <annotation>
      <documentation>Verschleiß des PE-Inlays</documentation>
    </annotation>
  </enumeration>
  <enumeration value="0202008">
    <annotation>
      <documentation>Implantatbruch</documentation>
    </annotation>
  </enumeration>
  <enumeration value="0202009">
    <annotation>
      <documentation>Implantatfehlage/Malalignent</documentation>
    </annotation>
  </enumeration>
  <enumeration value="0202010">
    <annotation>
      <documentation>Osteolysen bei festem Implantat</documentation>
    </annotation>
  </enumeration>
  <enumeration value="0202011">
    <annotation>
      <documentation>Progression der Grunderkrankung</documentation>
    </annotation>
  </enumeration>
  <enumeration value="0202012">
    <annotation>
      <documentation>ARMD</documentation>
    </annotation>
  </enumeration>
  <enumeration value="0202013">
    <annotation>
      <documentation>Verdacht auf allergische Reaktion</documentation>
    </annotation>
  </enumeration>
  <enumeration value="0202042">
    <annotation>
      <documentation>andere Gründe</documentation>
    </annotation>
  </enumeration>
</restriction>
</simpleType>

```

simpleType enum_0204

namespace	http://xml.ir-d.de/irdsaa		
type	restriction of string		
properties	base xs:string		
facets	Kind	Value	Annotation
	enumeration	0204001	documentation Lockerung
	enumeration	0204002	documentation Infektion, Verdacht auf
	enumeration	0204003	documentation Infektion, gesichert
	enumeration	0204006	documentation Periprothetische Fraktur
	enumeration	0204007	documentation Verschleiß
	enumeration	0204008	documentation Implantatbruch
	enumeration	0204009	documentation Implantatfehlage/Malalignent
	enumeration	0204010	documentation Osteolysen bei festem Implantat
	enumeration	0204011	documentation Progression der Grunderkrankung
	enumeration	0204012	documentation ARM-D
	enumeration	0204013	documentation Verdacht auf allergische Reaktion
	enumeration	0204014	documentation Dislokation/Migration von Komponenten
	enumeration	0204015	documentation Bandinstabilität
	enumeration	0204016	documentation Bewegungseinschränkung
	enumeration	0204042	documentation andere Gründe
annotation	documentation Kat_EP_GrundWechselKnie		
source	<pre> <simpleType name="enum_0204"> <annotation> <documentation>Kat_EP_GrundWechselKnie</documentation> </annotation> <restriction base="xs:string"> <enumeration value="0204001"> <annotation> <documentation>Lockerung</documentation> </annotation> </enumeration> <enumeration value="0204002"> <annotation> <documentation>Infektion, Verdacht auf</documentation> </annotation> </enumeration> <enumeration value="0204003"> <annotation> <documentation>Infektion, gesichert</documentation> </annotation> </enumeration> <enumeration value="0204006"> <annotation> <documentation>Periprothetische Fraktur</documentation> </annotation> </enumeration> </restriction> </simpleType> </pre>		

```
</annotation>
</enumeration>
<enumeration value="0204007">
  <annotation>
    <documentation>Verschleiß</documentation>
  </annotation>
</enumeration>
<enumeration value="0204008">
  <annotation>
    <documentation>Implantatbruch</documentation>
  </annotation>
</enumeration>
<enumeration value="0204009">
  <annotation>
    <documentation>Implantatfehllage/Malalignement</documentation>
  </annotation>
</enumeration>
<enumeration value="0204010">
  <annotation>
    <documentation>Osteolysen bei festem Implantat</documentation>
  </annotation>
</enumeration>
<enumeration value="0204011">
  <annotation>
    <documentation>Progression der Grunderkrankung</documentation>
  </annotation>
</enumeration>
<enumeration value="0204012">
  <annotation>
    <documentation>ARMD</documentation>
  </annotation>
</enumeration>
<enumeration value="0204013">
  <annotation>
    <documentation>Verdacht auf allergische Reaktion</documentation>
  </annotation>
</enumeration>
<enumeration value="0204014">
  <annotation>
    <documentation>Dislokation/Migration von Komponenten</documentation>
  </annotation>
</enumeration>
<enumeration value="0204015">
  <annotation>
    <documentation>Bandinstabilität</documentation>
  </annotation>
</enumeration>
<enumeration value="0204016">
  <annotation>
    <documentation>Bewegungseinschränkung</documentation>
  </annotation>
</enumeration>
<enumeration value="0204042">
  <annotation>
    <documentation>andere Gründe</documentation>
  </annotation>
</enumeration>
</restriction>
</simpleType>
```

simpleType enum 0206

namespace	http://xml.ir-d.de/irdsaa		
type	restriction of string		
properties	base xs:string		
facets	Kind	Value	Annotation
	enumeration	0206001	documentation Lockerung
	enumeration	0206002	documentation Infektion, Verdacht auf
	enumeration	0206003	documentation Infektion, gesichert
	enumeration	0206004	documentation Luxation, Inlay aus der Pfanne
	enumeration	0206005	documentation Luxation, Kopf aus Pfanne/Inlay
	enumeration	0206006	documentation Periprothetische Fraktur
	enumeration	0206007	documentation Verschleiß
	enumeration	0206008	documentation Implantatbruch
	enumeration	0206009	documentation Implantatfehlage/Malalignent
	enumeration	0206010	documentation Osteolysen bei festem Implantat
	enumeration	0206011	documentation Progression der Grunderkrankung
	enumeration	0206012	documentation ARMD
	enumeration	0206013	documentation Verdacht auf allergische Reaktion
	enumeration	0206014	documentation Dislokation/Migration von Komponenten
	enumeration	0206015	documentation Bandinstabilität
	enumeration	0206016	documentation Bewegungseinschränkung
	enumeration	0206042	documentation andere Gründe
annotation	documentation Kat_EP_GrundWechselTFE		
source	<pre> <simpleType name="enum_0206"> <annotation> <documentation>Kat_EP_GrundWechselTFE</documentation> </annotation> <restriction base="xs:string"> <enumeration value="0206001"> <annotation> <documentation>Lockerung</documentation> </annotation> </enumeration> <enumeration value="0206002"> <annotation> <documentation>Infektion, Verdacht auf</documentation> </annotation> </enumeration> <enumeration value="0206003"> <annotation> </pre>		

```
<documentation>Infektion, gesichert</documentation>
</annotation>
</enumeration>
<enumeration value="0206004">
  <annotation>
    <documentation>Luxation, Inlay aus der Pfanne</documentation>
  </annotation>
</enumeration>
<enumeration value="0206005">
  <annotation>
    <documentation>Luxation, Kopf aus Pfanne/Inlay</documentation>
  </annotation>
</enumeration>
<enumeration value="0206006">
  <annotation>
    <documentation>Periprothetische Fraktur</documentation>
  </annotation>
</enumeration>
<enumeration value="0206007">
  <annotation>
    <documentation>Verschleiß</documentation>
  </annotation>
</enumeration>
<enumeration value="0206008">
  <annotation>
    <documentation>Implantatbruch</documentation>
  </annotation>
</enumeration>
<enumeration value="0206009">
  <annotation>
    <documentation>Implantatfehllage/Malalignent</documentation>
  </annotation>
</enumeration>
<enumeration value="0206010">
  <annotation>
    <documentation>Osteolysen bei festem Implantat</documentation>
  </annotation>
</enumeration>
<enumeration value="0206011">
  <annotation>
    <documentation>Progression der Grunderkrankung</documentation>
  </annotation>
</enumeration>
<enumeration value="0206012">
  <annotation>
    <documentation>ARMD</documentation>
  </annotation>
</enumeration>
<enumeration value="0206013">
  <annotation>
    <documentation>Verdacht auf allergische Reaktion</documentation>
  </annotation>
</enumeration>
<enumeration value="0206014">
  <annotation>
    <documentation>Dislokation/Migration von Komponenten</documentation>
  </annotation>
</enumeration>
<enumeration value="0206015">
```

	<pre> <annotation> <documentation>Bandinstabilität</documentation> </annotation> </enumeration> <enumeration value="0206016"> <annotation> <documentation>Bewegungseinschränkung</documentation> </annotation> </enumeration> <enumeration value="0206042"> <annotation> <documentation>andere Gründe</documentation> </annotation> </enumeration> </restriction> </simpleType> </pre>
--	--

simpleType enum_0210

namespace	http://xml.ir-d.de/irdsaa		
type	restriction of string		
properties	base xs:string		
facets	Kind	Value	Annotation
	enumeration	0210001	documentation keine relevante Voroperation
	enumeration	0210002	documentation Osteosynthese/Osteotomie (Becken)
	enumeration	0210003	documentation Osteosynthese/Osteotomie (Femur)
	enumeration	0210004	documentation Osteosynthese/Osteotomie (beides)
	enumeration	0210005	documentation Operation bei Hüftkopfnekrose
	enumeration	0210006	documentation Arthrodese
	enumeration	0210042	documentation andere
annotation	documentation Kat_EP_VoroperationHuefte		
source	<pre> <simpleType name="enum_0210"> <annotation> <documentation>Kat_EP_VoroperationHuefte</documentation> </annotation> <restriction base="xs:string"> <enumeration value="0210001"> <annotation> <documentation>keine relevante Voroperation</documentation> </annotation> </enumeration> <enumeration value="0210002"> <annotation> <documentation>Osteosynthese/Osteotomie (Becken)</documentation> </annotation> </enumeration> <enumeration value="0210003"> <annotation> <documentation>Osteosynthese/Osteotomie (Femur)</documentation> </annotation> </enumeration> </restriction> </simpleType> </pre>		

	<pre> </annotation> </enumeration> <enumeration value="0210004"> <annotation> <documentation>Osteosynthese/Osteotomie (beides)</documentation> </annotation> </enumeration> <enumeration value="0210005"> <annotation> <documentation>Operation bei Hüftkopfnnekrose</documentation> </annotation> </enumeration> <enumeration value="0210006"> <annotation> <documentation>Arthrodese</documentation> </annotation> </enumeration> <enumeration value="0210042"> <annotation> <documentation>andere</documentation> </annotation> </enumeration> </restriction> </simpleType> </pre>
--	---

simpleType enum_0211

namespace	http://xml.ir-d.de/irdsaa		
type	restriction of string		
properties	base xs:string		
facets	Kind	Value	Annotation
	enumeration	0211001	documentation keine relevante Voroperation
	enumeration	0211002	documentation Osteosynthese/Osteotomie (Femur)
	enumeration	0211003	documentation Osteosynthese/Osteotomie (Tibia)
	enumeration	0211004	documentation Osteosynthese/Osteotomie (Patella)
	enumeration	0211005	documentation Osteosynthese/Osteotomie (mehrere)
	enumeration	0211006	documentation Kapsel-/Bandapparat
	enumeration	0211007	documentation Arthrodese
	enumeration	0211042	documentation andere
annotation	documentation Kat_EP_VoroperationKnie		
source	<pre> <simpleType name="enum_0211"> <annotation> <documentation>Kat_EP_VoroperationKnie</documentation> </annotation> <restriction base="xs:string"> <enumeration value="0211001"> <annotation> <documentation>keine relevante Voroperation</documentation> </annotation> </pre>		

```

</enumeration>
<enumeration value="0211002">
  <annotation>
    <documentation>Osteosynthese/Osteotomie (Femur)</documentation>
  </annotation>
</enumeration>
<enumeration value="0211003">
  <annotation>
    <documentation>Osteosynthese/Osteotomie (Tibia)</documentation>
  </annotation>
</enumeration>
<enumeration value="0211004">
  <annotation>
    <documentation>Osteosynthese/Osteotomie (Patella)</documentation>
  </annotation>
</enumeration>
<enumeration value="0211005">
  <annotation>
    <documentation>Osteosynthese/Osteotomie (mehrere)</documentation>
  </annotation>
</enumeration>
<enumeration value="0211006">
  <annotation>
    <documentation>Kapsel-/Bandapparat</documentation>
  </annotation>
</enumeration>
<enumeration value="0211007">
  <annotation>
    <documentation>Arthrodesse</documentation>
  </annotation>
</enumeration>
<enumeration value="0211042">
  <annotation>
    <documentation>andere</documentation>
  </annotation>
</enumeration>
</restriction>
</simpleType>

```

simpleType **enum_0212**

namespace	http://xml.ir-d.de/irdsaa		
type	restriction of string		
properties	base xs:string		
facets	Kind	Value	Annotation
	enumeration	0212001	documentation Hüfte
	enumeration	0212002	documentation Knie
	enumeration	0212003	documentation Totaler Femurersatz inkl. Durchsteck-Prothese
annotation	documentation Kat_EP_Gelenk		
source	<simpleType name="enum_0212"> <annotation> <documentation>Kat_EP_Gelenk</documentation> </annotation>		

	<pre> <restriction base="xs:string"> <enumeration value="0212001"> <annotation> <documentation>Hüfte</documentation> </annotation> </enumeration> <enumeration value="0212002"> <annotation> <documentation>Knie</documentation> </annotation> </enumeration> <enumeration value="0212003"> <annotation> <documentation>Totaler Femurersatz inkl. Durchsteck- Prothese</documentation> </annotation> </enumeration> </restriction> </simpleType> </pre>
--	---

simpleType enum 0220

namespace	http://xml.ir-d.de/irdsaa		
type	restriction of string		
properties	base xs:string		
facets	Kind	Value	Annotation
	enumeration	0220001	documentation anterior
	enumeration	0220002	documentation anterolateral
	enumeration	0220003	documentation lateral
	enumeration	0220004	documentation posterior
	enumeration	0220005	documentation posterolateral
	enumeration	0220006	documentation 2-Inzisionen-Zugang
	enumeration	0220042	documentation sonstiger
annotation	documentation Kat_EP_Operationszugang		
source	<pre> <simpleType name="enum_0220"> <annotation> <documentation>Kat_EP_Operationszugang</documentation> </annotation> <restriction base="xs:string"> <enumeration value="0220001"> <annotation> <documentation>anterior</documentation> </annotation> </enumeration> <enumeration value="0220002"> <annotation> <documentation>anterolateral</documentation> </annotation> </enumeration> </restriction> </pre>		

	<pre> <enumeration value="0220003"> <annotation> <documentation>lateral</documentation> </annotation> </enumeration> <enumeration value="0220004"> <annotation> <documentation>posterior</documentation> </annotation> </enumeration> <enumeration value="0220005"> <annotation> <documentation>posterolateral</documentation> </annotation> </enumeration> <enumeration value="0220006"> <annotation> <documentation>2-Inzisionen-Zugang</documentation> </annotation> </enumeration> <enumeration value="0220042"> <annotation> <documentation>sonstiger</documentation> </annotation> </enumeration> </restriction> </simpleType> </pre>
--	---

simpleType enum_0222

namespace	http://xml.ir-d.de/irdsaa		
type	restriction of string		
properties	base xs:string		
facets	Kind	Value	Annotation
	enumeration	0222001	documentation nein
	enumeration	0222002	documentation ja- Ausbau
	enumeration	0222003	documentation ja- Einbau
annotation	documentation Kat_EP_Zweizeitwechsel		
source	<pre> <simpleType name="enum_0222"> <annotation> <documentation>Kat_EP_Zweizeitwechsel</documentation> </annotation> <restriction base="xs:string"> <enumeration value="0222001"> <annotation> <documentation>nein</documentation> </annotation> </enumeration> <enumeration value="0222002"> <annotation> <documentation>ja- Ausbau</documentation> </annotation> </enumeration> </restriction> </simpleType> </pre>		

	<pre> <enumeration value="0222003"> <annotation> <documentation>ja- Einbau</documentation> </annotation> </enumeration> </restriction> </simpleType> </pre>
--	---

simpleType enum_0252

namespace	http://xml.ir-d.de/irdsaa		
type	restriction of string		
properties	base xs:string		
facets	Kind	Value	Annotation
	enumeration	0252001	documentation Pfanne
	enumeration	0252002	documentation Schaft
	enumeration	0252003	documentation beides
annotation	documentation Kat_EP_KomponenteHuefte		
source	<pre> <simpleType name="enum_0252"> <annotation> <documentation>Kat_EP_KomponenteHuefte</documentation> </annotation> <restriction base="xs:string"> <enumeration value="0252001"> <annotation> <documentation>Pfanne</documentation> </annotation> </enumeration> <enumeration value="0252002"> <annotation> <documentation>Schaft</documentation> </annotation> </enumeration> <enumeration value="0252003"> <annotation> <documentation>beides</documentation> </annotation> </enumeration> </restriction> </simpleType> </pre>		

simpleType enum_0254

namespace	http://xml.ir-d.de/irdsaa		
type	restriction of string		
properties	base xs:string		
facets	Kind	Value	Annotation
	enumeration	0254001	documentation Femur
	enumeration	0254002	documentation

	enumeration 0254003 Tibia documentation Patella enumeration 0254004 Tibia documentation mehrere
annotation	documentation Kat_EP_KomponenteKnie
source	<pre> <simpleType name="enum_0254"> <annotation> <documentation>Kat_EP_KomponenteKnie</documentation> </annotation> <restriction base="xs:string"> <enumeration value="0254001"> <annotation> <documentation>Femur</documentation> </annotation> </enumeration> <enumeration value="0254002"> <annotation> <documentation>Tibia</documentation> </annotation> </enumeration> <enumeration value="0254003"> <annotation> <documentation>Patella</documentation> </annotation> </enumeration> <enumeration value="0254004"> <annotation> <documentation>mehrere</documentation> </annotation> </enumeration> </restriction> </simpleType> </pre>

simpleType enum_0256

namespace	http://xml.ir-d.de/irdsaa		
type	restriction of string		
properties	base xs:string		
facets	Kind	Value	Annotation
	enumeration	0256001	documentation Pfanne
	enumeration	0256002	documentation Schaft
	enumeration	0256003	documentation Pfanne und Schaft
	enumeration	0256004	documentation Femur
	enumeration	0256005	documentation Tibia
	enumeration	0256006	documentation Patella
	enumeration	0256007	documentation mehrere
annotation	documentation Kat_EP_KomponenteTFE		

source	<pre> <simpleType name="enum_0256"> <annotation> <documentation>Kat_EP_KomponenteTFE</documentation> </annotation> <restriction base="xs:string"> <enumeration value="0256001"> <annotation> <documentation>Pfanne</documentation> </annotation> </enumeration> <enumeration value="0256002"> <annotation> <documentation>Schaft</documentation> </annotation> </enumeration> <enumeration value="0256003"> <annotation> <documentation>Pfanne und Schaft</documentation> </annotation> </enumeration> <enumeration value="0256004"> <annotation> <documentation>Femur</documentation> </annotation> </enumeration> <enumeration value="0256005"> <annotation> <documentation>Tibia</documentation> </annotation> </enumeration> <enumeration value="0256006"> <annotation> <documentation>Patella</documentation> </annotation> </enumeration> <enumeration value="0256007"> <annotation> <documentation>mehrere</documentation> </annotation> </enumeration> </restriction> </simpleType> </pre>
--------	--

simpleType enum_0262

namespace	http://xml.ir-d.de/irdsaa		
type	restriction of string		
properties	base xs:string		
facets	Kind	Value	Annotation
	enumeration	0262001	documentation Pfanne
	enumeration	0262002	documentation Schaft
	enumeration	0262003	documentation Kopf
	enumeration	0262004	documentation Inlay

	enumeration 0262005 documentation Adapter
	enumeration 0262006 documentation mehrere
annotation	documentation Kat_EP_ImplantatbruchHuefte
source	<pre> <simpleType name="enum_0262"> <annotation> <documentation>Kat_EP_ImplantatbruchHuefte</documentation> </annotation> <restriction base="xs:string"> <enumeration value="0262001"> <annotation> <documentation>Pfanne</documentation> </annotation> </enumeration> <enumeration value="0262002"> <annotation> <documentation>Schaft</documentation> </annotation> </enumeration> <enumeration value="0262003"> <annotation> <documentation>Kopf</documentation> </annotation> </enumeration> <enumeration value="0262004"> <annotation> <documentation>Inlay</documentation> </annotation> </enumeration> <enumeration value="0262005"> <annotation> <documentation>Adapter</documentation> </annotation> </enumeration> <enumeration value="0262006"> <annotation> <documentation>mehrere</documentation> </annotation> </enumeration> </restriction> </simpleType> </pre>

simpleType enum_0264

namespace	http://xml.ir-d.de/irdsaa		
type	restriction of string		
properties	base xs:string		
facets	Kind	Value	Annotation
	enumeration	0264001	documentation Femur
	enumeration	0264002	documentation Tibia
	enumeration	0264003	documentation Inlay
	enumeration	0264004	documentation

	<p>enumeration 0264005 Adapter documentation Verlängerung</p> <p>enumeration 0264006 documentation Schrauben</p> <p>enumeration 0264007 documentation mehrere</p> <p>enumeration 0264042 documentation andere</p>
annotation	documentation Kat_EP_ImplantatbruchKnie
source	<pre> <simpleType name="enum_0264"> <annotation> <documentation>Kat_EP_ImplantatbruchKnie</documentation> </annotation> <restriction base="xs:string"> <enumeration value="0264001"> <annotation> <documentation>Femur</documentation> </annotation> </enumeration> <enumeration value="0264002"> <annotation> <documentation>Tibia</documentation> </annotation> </enumeration> <enumeration value="0264003"> <annotation> <documentation>Inlay</documentation> </annotation> </enumeration> <enumeration value="0264004"> <annotation> <documentation>Adapter</documentation> </annotation> </enumeration> <enumeration value="0264005"> <annotation> <documentation>Verlängerung</documentation> </annotation> </enumeration> <enumeration value="0264006"> <annotation> <documentation>Schrauben</documentation> </annotation> </enumeration> <enumeration value="0264007"> <annotation> <documentation>mehrere</documentation> </annotation> </enumeration> <enumeration value="0264042"> <annotation> <documentation>andere</documentation> </annotation> </enumeration> </restriction> </simpleType> </pre>

simpleType enum_0266

namespace	http://xml.ir-d.de/irdsaa		
type	restriction of string		
properties	base xs:string		
facets	Kind	Value	Annotation
	enumeration	0266001	documentation Pfanne
	enumeration	0266002	documentation Schaft
	enumeration	0266003	documentation Kopf
	enumeration	0266004	documentation Inlay
	enumeration	0266005	documentation Adapter
	enumeration	0266006	documentation Femur
	enumeration	0266007	documentation Tibia
	enumeration	0266008	documentation Verlängerung
	enumeration	0266009	documentation Schrauben
	enumeration	0266010	documentation mehrere
	enumeration	0266042	documentation andere
annotation	documentation Kat_EP_ImplantatbruchTFE		
source	<pre> <simpleType name="enum_0266"> <annotation> <documentation>Kat_EP_ImplantatbruchTFE</documentation> </annotation> <restriction base="xs:string"> <enumeration value="0266001"> <annotation> <documentation>Pfanne</documentation> </annotation> </enumeration> <enumeration value="0266002"> <annotation> <documentation>Schaft</documentation> </annotation> </enumeration> <enumeration value="0266003"> <annotation> <documentation>Kopf</documentation> </annotation> </enumeration> <enumeration value="0266004"> <annotation> <documentation>Inlay</documentation> </annotation> </enumeration> <enumeration value="0266005"> <annotation> <documentation>Adapter</documentation> </annotation> </enumeration> </restriction> </simpleType> </pre>		

	<pre> </enumeration> <enumeration value="0266006"> <annotation> <documentation>Femur</documentation> </annotation> </enumeration> <enumeration value="0266007"> <annotation> <documentation>Tibia</documentation> </annotation> </enumeration> <enumeration value="0266008"> <annotation> <documentation>Verlängerung</documentation> </annotation> </enumeration> <enumeration value="0266009"> <annotation> <documentation>Schrauben</documentation> </annotation> </enumeration> <enumeration value="0266010"> <annotation> <documentation>mehrere</documentation> </annotation> </enumeration> <enumeration value="0266042"> <annotation> <documentation>andere</documentation> </annotation> </enumeration> </restriction> </simpleType> </pre>
--	--

simpleType enum_0270

namespace	http://xml.lir-d.de/irdsaa		
type	restriction of string		
properties	base xs:string		
facets	Kind	Value	Annotation
	enumeration	0270001	documentation PE-Inlay
	enumeration	0270002	documentation patellare Komponente
	enumeration	0270003	documentation beides
annotation	documentation Kat_EP_VerschleissKnie		
source	<pre> <simpleType name="enum_0270"> <annotation> <documentation>Kat_EP_VerschleissKnie</documentation> </annotation> <restriction base="xs:string"> <enumeration value="0270001"> <annotation> <documentation>PE-Inlay</documentation> </annotation> </pre>		

	<pre> </enumeration> <enumeration value="0270002"> <annotation> <documentation>patellare Komponente</documentation> </annotation> </enumeration> <enumeration value="0270003"> <annotation> <documentation>beides</documentation> </annotation> </enumeration> </restriction> </simpleType> </pre>
--	--

simpleType enum_0271

namespace	http://xml.ir-d.de/irdsaa		
type	restriction of string		
properties	base xs:string		
facets	Kind	Value	Annotation
	enumeration	0271001	documentation Schraube
	enumeration	0271002	documentation Inlay
	enumeration	0271003	documentation patellare Komponente
	enumeration	0271004	documentation Kopplung
	enumeration	0271005	documentation mehrere
	enumeration	0271042	documentation andere
annotation	documentation Kat_EP_MigrationKnie		
source	<pre> <simpleType name="enum_0271"> <annotation> <documentation>Kat_EP_MigrationKnie</documentation> </annotation> <restriction base="xs:string"> <enumeration value="0271001"> <annotation> <documentation>Schraube</documentation> </annotation> </enumeration> <enumeration value="0271002"> <annotation> <documentation>Inlay</documentation> </annotation> </enumeration> <enumeration value="0271003"> <annotation> <documentation>patellare Komponente</documentation> </annotation> </enumeration> <enumeration value="0271004"> <annotation> <documentation>Kopplung</documentation> </pre>		

	<pre> </annotation> </enumeration> <enumeration value="0271005"> <annotation> <documentation>mehrere</documentation> </annotation> </enumeration> <enumeration value="0271042"> <annotation> <documentation>andere</documentation> </annotation> </enumeration> </restriction> </simpleType> </pre>
--	---

simpleType enum_0280

namespace	http://xml.lir-d.de/irdsaa		
type	restriction of string		
properties	base xs:string		
facets	Kind	Value	Annotation
	enumeration	0280001	documentation Ohne
	enumeration	0280002	documentation PSI
	enumeration	0280003	documentation Navigation
	enumeration	0280004	documentation Robotik
	enumeration	0280042	documentation Unbekannt
annotation	documentation Kat_EP_AssistiveTechnologie		
source	<pre> <simpleType name="enum_0280"> <annotation> <documentation>Kat_EP_AssistiveTechnologie</documentation> </annotation> <restriction base="xs:string"> <enumeration value="0280001"> <annotation> <documentation>Ohne</documentation> </annotation> </enumeration> <enumeration value="0280002"> <annotation> <documentation>PSI</documentation> </annotation> </enumeration> <enumeration value="0280003"> <annotation> <documentation>Navigation</documentation> </annotation> </enumeration> <enumeration value="0280004"> <annotation> <documentation>Robotik</documentation> </annotation> </enumeration> </restriction> </simpleType> </pre>		

```

</enumeration>
<enumeration value="0280042">
  <annotation>
    <documentation>Unbekannt</documentation>
  </annotation>
</enumeration>
</restriction>
</simpleType>

```

simpleType enum_0281

namespace	http://xml.ir-d.de/irdsaa		
type	restriction of string		
properties	base xs:string		
facets	Kind	Value	Annotation
	enumeration	0281001	documentation Aesculap - OrthoPilot
	enumeration	0281002	documentation Amplitude - Amplivision
	enumeration	0281003	documentation Johnson & Johnson - VELYS
	enumeration	0281004	documentation Orthokey - Orthokey Miro
	enumeration	0281005	documentation Orthokey - BLU-IGS
	enumeration	0281006	documentation Smith & Nephew - Brainlab Plattformen (TBD)
	enumeration	0281007	documentation Stryker - Stryker NAV3i
	enumeration	0281008	documentation Stryker - Stryker Ortho Q Guidance System
	enumeration	0281009	documentation ThinkSurgical - TMINI
	enumeration	0281010	documentation Zimmer Biomet - Sesamoid Navigation
	enumeration	0281011	documentation Zimmer Biomet - iAssist Navigation
	enumeration	0281012	documentation nicht belegter Wert
	enumeration	0281013	documentation nicht belegter Wert
	enumeration	0281014	documentation nicht belegter Wert
	enumeration	0281015	documentation nicht belegter Wert
	enumeration	0281016	documentation nicht belegter Wert
	enumeration	0281042	documentation sonstige
annotation	documentation Kat_EP_Navigation		
source	<pre> <simpleType name="enum_0281"> <annotation> <documentation>Kat_EP_Navigation</documentation> </annotation> <restriction base="xs:string"> <enumeration value="0281001"> <annotation> <documentation>Aesculap - OrthoPilot</documentation> </annotation> </enumeration> </restriction> </simpleType> </pre>		

```

</annotation>
</enumeration>
<enumeration value="0281002">
  <annotation>
    <documentation>Amplitude - Amplivision</documentation>
  </annotation>
</enumeration>
<enumeration value="0281003">
  <annotation>
    <documentation>Johnson & Johnson - VELYS</documentation>
  </annotation>
</enumeration>
<enumeration value="0281004">
  <annotation>
    <documentation>Orthokey - Orthokey Miro</documentation>
  </annotation>
</enumeration>
<enumeration value="0281005">
  <annotation>
    <documentation>Orthokey - BLU-IGS</documentation>
  </annotation>
</enumeration>
<enumeration value="0281006">
  <annotation>
    <documentation>Smith & Nephew - Brainlab Plattformen
(TBD)</documentation>
  </annotation>
</enumeration>
<enumeration value="0281007">
  <annotation>
    <documentation>Stryker - Stryker NAV3i</documentation>
  </annotation>
</enumeration>
<enumeration value="0281008">
  <annotation>
    <documentation>Stryker - Stryker Ortho Q Guidance
System</documentation>
  </annotation>
</enumeration>
<enumeration value="0281009">
  <annotation>
    <documentation>ThinkSurgical - TMINI</documentation>
  </annotation>
</enumeration>
<enumeration value="0281010">
  <annotation>
    <documentation>Zimmer Biomet - Sesamoid Navigation</documentation>
  </annotation>
</enumeration>
<enumeration value="0281011">
  <annotation>
    <documentation>Zimmer Biomet - iAssist Navigation</documentation>
  </annotation>
</enumeration>
<enumeration value="0281012">
  <annotation>
    <documentation>nicht belegter Wert</documentation>
  </annotation>
</enumeration>

```



```

<enumeration value="0281013">
  <annotation>
    <documentation>nicht belegter Wert</documentation>
  </annotation>
</enumeration>
<enumeration value="0281014">
  <annotation>
    <documentation>nicht belegter Wert</documentation>
  </annotation>
</enumeration>
<enumeration value="0281015">
  <annotation>
    <documentation>nicht belegter Wert</documentation>
  </annotation>
</enumeration>
<enumeration value="0281016">
  <annotation>
    <documentation>nicht belegter Wert</documentation>
  </annotation>
</enumeration>
<enumeration value="0281042">
  <annotation>
    <documentation>sonstige</documentation>
  </annotation>
</enumeration>
</restriction>
</simpleType>

```

simpleType enum_0282

namespace	http://xml.ir-d.de/irdsaa		
type	restriction of string		
properties	base xs:string		
facets	Kind	Value	Annotation
	enumeration	0282001	documentation Amplitude - Andy
	enumeration	0282002	documentation Corin - ApolloKnee
	enumeration	0282003	documentation Corin - OMNIBotics
	enumeration	0282004	documentation Microport - Skywalker
	enumeration	0282005	documentation Orthokey - Orthokey Robin
	enumeration	0282006	documentation Smith & Nephew - CORI
	enumeration	0282007	documentation Smith & Nephew - NAVIO
	enumeration	0282008	documentation Stryker - Mako SmartRobotics
	enumeration	0282009	documentation Zimmer Biomet - ROSA
	enumeration	0282010	documentation Johnson & Johnson - VELYS Robotic Assisted Solution
	enumeration	0282011	documentation nicht belegter Wert
	enumeration	0282012	documentation nicht belegter Wert
	enumeration	0282013	documentation

	<p>enumeration 0282014 nicht belegter Wert documentation</p> <p>enumeration 0282015 nicht belegter Wert documentation</p> <p>enumeration 0282042 nicht belegter Wert documentation sonstige</p>
annotation	documentation Kat_EP_Robotik
source	<pre> <simpleType name="enum_0282"> <annotation> <documentation>Kat_EP_Robotik</documentation> </annotation> <restriction base="xs:string"> <enumeration value="0282001"> <annotation> <documentation>Amplitude - Andy</documentation> </annotation> </enumeration> <enumeration value="0282002"> <annotation> <documentation>Corin - ApolloKnee</documentation> </annotation> </enumeration> <enumeration value="0282003"> <annotation> <documentation>Corin - OMNIBotics</documentation> </annotation> </enumeration> <enumeration value="0282004"> <annotation> <documentation>Microport - Skywalker</documentation> </annotation> </enumeration> <enumeration value="0282005"> <annotation> <documentation>Orthokey - Orthokey Robin</documentation> </annotation> </enumeration> <enumeration value="0282006"> <annotation> <documentation>Smith & Nephew - CORI</documentation> </annotation> </enumeration> <enumeration value="0282007"> <annotation> <documentation>Smith & Nephew - NAVIO</documentation> </annotation> </enumeration> <enumeration value="0282008"> <annotation> <documentation>Stryker - Mako SmartRobotics</documentation> </annotation> </enumeration> <enumeration value="0282009"> <annotation> <documentation>Zimmer Biomet - ROSA</documentation> </annotation> </enumeration> </restriction> </simpleType> </pre>

```

<enumeration value="0282010">
  <annotation>
    <documentation>Johnson & Johnson - VELYS Robotic Assisted
Solution</documentation>
  </annotation>
</enumeration>
<enumeration value="0282011">
  <annotation>
    <documentation>nicht belegter Wert</documentation>
  </annotation>
</enumeration>
<enumeration value="0282012">
  <annotation>
    <documentation>nicht belegter Wert</documentation>
  </annotation>
</enumeration>
<enumeration value="0282013">
  <annotation>
    <documentation>nicht belegter Wert</documentation>
  </annotation>
</enumeration>
<enumeration value="0282014">
  <annotation>
    <documentation>nicht belegter Wert</documentation>
  </annotation>
</enumeration>
<enumeration value="0282015">
  <annotation>
    <documentation>nicht belegter Wert</documentation>
  </annotation>
</enumeration>
<enumeration value="0282042">
  <annotation>
    <documentation>sonstige</documentation>
  </annotation>
</enumeration>
</restriction>
</simpleType>

```

simpleType enum 0290

namespace	http://xml.ir-d.de/irdsaa		
type	restriction of string		
properties	base xs:string		
facets	Kind	Value	Annotation
	enumeration	0290001	documentation Hüft-Komponente
	enumeration	0290002	documentation Knie-Komponente
	enumeration	0290003	documentation Modulare Komponente (Hüfte/Knie)
	enumeration	0290004	documentation Knochenzement
	enumeration	0290042	documentation sonstiger
annotation	documentation Kat_EP_Artikeltyp		

source	<pre> <simpleType name="enum_0290"> <annotation> <documentation>Kat_EP_Artikeltyp</documentation> </annotation> <restriction base="xs:string"> <enumeration value="0290001"> <annotation> <documentation>Hüft-Komponente</documentation> </annotation> </enumeration> <enumeration value="0290002"> <annotation> <documentation>Knie-Komponente</documentation> </annotation> </enumeration> <enumeration value="0290003"> <annotation> <documentation>Modulare Komponente (Hüfte/Knie)</documentation> </annotation> </enumeration> <enumeration value="0290004"> <annotation> <documentation>Knochenzement</documentation> </annotation> </enumeration> <enumeration value="0290042"> <annotation> <documentation>sonstiger</documentation> </annotation> </enumeration> </restriction> </simpleType> </pre>
--------	--

simpleType enum_0292

namespace	http://xml.ir-d.de/irdsaa		
type	restriction of string		
properties	base xs:string		
facets	Kind	Value	Annotation
	enumeration	0292001	documentation Pfanne
	enumeration	0292002	documentation Inlay
	enumeration	0292003	documentation Kopf
	enumeration	0292004	documentation Schaft
	enumeration	0292005	documentation Vormontierte Acetabularkomponente (Pfanne mit Inlay)
	enumeration	0292006	documentation Einteilige Femoralkomponente (Schaft mit Kopf)
	enumeration	0292042	documentation sonstiger
annotation	documentation Kat_EP_ArtikeltypHuefte		
source	<pre> <simpleType name="enum_0292"> <annotation> </pre>		

```

<documentation>Kat_EP_ArtikeltypHuefte</documentation>
</annotation>
<restriction base="xs:string">
  <enumeration value="0292001">
    <annotation>
      <documentation>Pfanne</documentation>
    </annotation>
  </enumeration>
  <enumeration value="0292002">
    <annotation>
      <documentation>Inlay</documentation>
    </annotation>
  </enumeration>
  <enumeration value="0292003">
    <annotation>
      <documentation>Kopf</documentation>
    </annotation>
  </enumeration>
  <enumeration value="0292004">
    <annotation>
      <documentation>Schaft</documentation>
    </annotation>
  </enumeration>
  <enumeration value="0292005">
    <annotation>
      <documentation>Vormontierte Acetabularkomponente (Pfanne mit
Inlay)</documentation>
    </annotation>
  </enumeration>
  <enumeration value="0292006">
    <annotation>
      <documentation>Einteilige Femoralkomponente (Schaft mit
Kopf)</documentation>
    </annotation>
  </enumeration>
  <enumeration value="0292042">
    <annotation>
      <documentation>sonstiger</documentation>
    </annotation>
  </enumeration>
</restriction>
</simpleType>

```

simpleType enum_0293

namespace	http://xml.ir-d.de/irdsaa		
type	restriction of string		
properties	base xs:string		
facets	Kind	Value	Annotation
	enumeration	0293001	documentation Tibiakomponente
	enumeration	0293002	documentation Femurkomponente
	enumeration	0293003	documentation Patella
	enumeration	0293004	documentation Insert

	enumeration 0293005 documentation Vormontierte Tibiakomponente mit Insert
	enumeration 0293042 documentation sonstiger
annotation	documentation Kat_EP_ArtikeltypKnie
source	<pre> <simpleType name="enum_0293"> <annotation> <documentation>Kat_EP_ArtikeltypKnie</documentation> </annotation> <restriction base="xs:string"> <enumeration value="0293001"> <annotation> <documentation>Tibiakomponente</documentation> </annotation> </enumeration> <enumeration value="0293002"> <annotation> <documentation>Femurkomponente</documentation> </annotation> </enumeration> <enumeration value="0293003"> <annotation> <documentation>Patella</documentation> </annotation> </enumeration> <enumeration value="0293004"> <annotation> <documentation>Insert</documentation> </annotation> </enumeration> <enumeration value="0293005"> <annotation> <documentation>Vormontierte Tibiakomponente mit Insert</documentation> </annotation> </enumeration> <enumeration value="0293042"> <annotation> <documentation>sonstiger</documentation> </annotation> </enumeration> </restriction> </simpleType> </pre>

simpleType enum_0300

namespace	http://xml.ir-d.de/irdsaa		
type	restriction of string		
properties	base xs:string		
facets	Kind	Value	Annotation
	enumeration	0300001	documentation konventioneller Aortenklappenersatz
	enumeration	0300002	documentation kathetergestützte Aortenklappenimplantation (TAVI)
annotation	documentation Kat_AK_ArtEingriff		

source	<pre> <simpleType name="enum_0300"> <annotation> <documentation>Kat_AK_ArtEingriff</documentation> </annotation> <restriction base="xs:string"> <enumeration value="0300001"> <annotation> <documentation>konventioneller Aortenklappenersatz</documentation> </annotation> </enumeration> <enumeration value="0300002"> <annotation> <documentation>kathetergestützte Aortenklappenimplantation (TAVI)</documentation> </annotation> </enumeration> </restriction> </simpleType> </pre>
--------	--

simpleType enum_0301

namespace	http://xml.ir-d.de/irdsaa		
type	restriction of string		
properties	base xs:string		
facets	Kind	Value	Annotation
	enumeration	0301001	documentation produktbezogen
	enumeration	0301002	documentation nicht-produktbezogen
annotation	documentation Kat_AK_GrundAbbruch		
source	<pre> <simpleType name="enum_0301"> <annotation> <documentation>Kat_AK_GrundAbbruch</documentation> </annotation> <restriction base="xs:string"> <enumeration value="0301001"> <annotation> <documentation>produktbezogen</documentation> </annotation> </enumeration> <enumeration value="0301002"> <annotation> <documentation>nicht-produktbezogen</documentation> </annotation> </enumeration> </restriction> </simpleType> </pre>		

simpleType enum_0302

namespace	http://xml.ir-d.de/irdsaa		
type	restriction of string		
properties	base xs:string		

facets	<table border="1"> <thead> <tr> <th>Kind</th> <th>Value</th> <th>Annotation</th> </tr> </thead> <tbody> <tr> <td>enumeration</td> <td>0302001</td> <td>documentation Stenose</td> </tr> <tr> <td>enumeration</td> <td>0302002</td> <td>documentation Insuffizienz</td> </tr> <tr> <td>enumeration</td> <td>0302003</td> <td>documentation Stenose und Insuffizienz</td> </tr> <tr> <td>enumeration</td> <td>0302042</td> <td>documentation sonstiger</td> </tr> </tbody> </table>	Kind	Value	Annotation	enumeration	0302001	documentation Stenose	enumeration	0302002	documentation Insuffizienz	enumeration	0302003	documentation Stenose und Insuffizienz	enumeration	0302042	documentation sonstiger
Kind	Value	Annotation														
enumeration	0302001	documentation Stenose														
enumeration	0302002	documentation Insuffizienz														
enumeration	0302003	documentation Stenose und Insuffizienz														
enumeration	0302042	documentation sonstiger														
annotation	documentation Kat_AK_GrundEingriff															
source	<pre> <simpleType name="enum_0302"> <annotation> <documentation>Kat_AK_GrundEingriff</documentation> </annotation> <restriction base="xs:string"> <enumeration value="0302001"> <annotation> <documentation>Stenose</documentation> </annotation> </enumeration> <enumeration value="0302002"> <annotation> <documentation>Insuffizienz</documentation> </annotation> </enumeration> <enumeration value="0302003"> <annotation> <documentation>Stenose und Insuffizienz</documentation> </annotation> </enumeration> <enumeration value="0302042"> <annotation> <documentation>sonstiger</documentation> </annotation> </enumeration> </restriction> </simpleType> </pre>															

simpleType enum_0318

namespace	http://xml.ir-d.de/irdsaa																		
type	restriction of string																		
properties	base xs:string																		
facets	<table border="1"> <thead> <tr> <th>Kind</th> <th>Value</th> <th>Annotation</th> </tr> </thead> <tbody> <tr> <td>enumeration</td> <td>0318001</td> <td>documentation transapikal</td> </tr> <tr> <td>enumeration</td> <td>0318002</td> <td>documentation transaortal</td> </tr> <tr> <td>enumeration</td> <td>0318003</td> <td>documentation transfemoral</td> </tr> <tr> <td>enumeration</td> <td>0318004</td> <td>documentation transaxillär</td> </tr> <tr> <td>enumeration</td> <td>0318042</td> <td>documentation anderer Zugangsweg</td> </tr> </tbody> </table>	Kind	Value	Annotation	enumeration	0318001	documentation transapikal	enumeration	0318002	documentation transaortal	enumeration	0318003	documentation transfemoral	enumeration	0318004	documentation transaxillär	enumeration	0318042	documentation anderer Zugangsweg
Kind	Value	Annotation																	
enumeration	0318001	documentation transapikal																	
enumeration	0318002	documentation transaortal																	
enumeration	0318003	documentation transfemoral																	
enumeration	0318004	documentation transaxillär																	
enumeration	0318042	documentation anderer Zugangsweg																	
annotation	documentation Kat_AK_ZugangKatheter																		

source	<pre> <simpleType name="enum_0318"> <annotation> <documentation>Kat_AK_ZugangKatheter</documentation> </annotation> <restriction base="xs:string"> <enumeration value="0318001"> <annotation> <documentation>transapikal</documentation> </annotation> </enumeration> <enumeration value="0318002"> <annotation> <documentation>transaortal</documentation> </annotation> </enumeration> <enumeration value="0318003"> <annotation> <documentation>transfemorale</documentation> </annotation> </enumeration> <enumeration value="0318004"> <annotation> <documentation>transaxillär</documentation> </annotation> </enumeration> <enumeration value="0318042"> <annotation> <documentation>anderer Zugangsweg</documentation> </annotation> </enumeration> </restriction> </simpleType> </pre>
--------	---

simpleType enum_0320

namespace	http://xml.ir-d.de/irdsaa		
type	restriction of string		
properties	base xs:string		
facets	Kind	Value	Annotation
	enumeration	0320001	documentation konventionelle Sternotomie
	enumeration	0320002	documentation partielle Sternotomie
	enumeration	0320003	documentation parasternaler Zugang
	enumeration	0320042	documentation anderer Zugangsweg
annotation	documentation Kat_AK_ZugangKonventionell		
source	<pre> <simpleType name="enum_0320"> <annotation> <documentation>Kat_AK_ZugangKonventionell</documentation> </annotation> <restriction base="xs:string"> <enumeration value="0320001"> <annotation> <documentation>konventionelle Sternotomie</documentation> </pre>		

	<pre> </annotation> </enumeration> <enumeration value="0320002"> <annotation> <documentation>partielle Sternotomie</documentation> </annotation> </enumeration> <enumeration value="0320003"> <annotation> <documentation>parasternaler Zugang</documentation> </annotation> </enumeration> <enumeration value="0320042"> <annotation> <documentation>anderer Zugangsweg</documentation> </annotation> </enumeration> </restriction> </simpleType> </pre>
--	---

simpleType enum 0322

namespace	http://xml.ir-d.de/irdsaa		
type	restriction of string		
properties	base xs:string		
facets	Kind	Value	Annotation
	enumeration	0322001	documentation nein
	enumeration	0322002	documentation ja, diätetisch behandelt
	enumeration	0322003	documentation ja, orale Medikation
	enumeration	0322004	documentation ja, mit Insulin behandelt
	enumeration	0322005	documentation ja, unbehandelt
	enumeration	0322099	documentation unbekannt
annotation	documentation Kat_AK_Diabetes		
source	<pre> <simpleType name="enum_0322"> <annotation> <documentation>Kat_AK_Diabetes</documentation> </annotation> <restriction base="xs:string"> <enumeration value="0322001"> <annotation> <documentation>nein</documentation> </annotation> </enumeration> <enumeration value="0322002"> <annotation> <documentation>ja, diätetisch behandelt</documentation> </annotation> </enumeration> <enumeration value="0322003"> <annotation> </pre>		

	<pre> <documentation>ja, orale Medikation</documentation> </annotation> </enumeration> <enumeration value="0322004"> <annotation> <documentation>ja, mit Insulin behandelt</documentation> </annotation> </enumeration> <enumeration value="0322005"> <annotation> <documentation>ja, unbehandelt</documentation> </annotation> </enumeration> <enumeration value="0322099"> <annotation> <documentation>unbekannt</documentation> </annotation> </enumeration> </restriction> </simpleType> </pre>
--	---

simpleType enum_0324

namespace	http://xml.ir-d.de/irdsaa		
type	restriction of string		
properties	base xs:string		
facets	Kind	Value	Annotation
	enumeration	0324001	documentation (I): Beschwerdefreiheit, normale körperliche Belastbarkeit
	enumeration	0324002	documentation (II): Beschwerden bei stärkerer körperlicher Belastung
	enumeration	0324003	documentation (III): Beschwerden bei leichter körperlicher Belastung
	enumeration	0324004	documentation (IV): Beschwerden in Ruhe
annotation	documentation Kat_AK_NYHA		
source	<pre> <simpleType name="enum_0324"> <annotation> <documentation>Kat_AK_NYHA</documentation> </annotation> <restriction base="xs:string"> <enumeration value="0324001"> <annotation> <documentation>(I): Beschwerdefreiheit, normale körperliche Belastbarkeit</documentation> </annotation> </enumeration> <enumeration value="0324002"> <annotation> <documentation>(II): Beschwerden bei stärkerer körperlicher Belastung</documentation> </annotation> </enumeration> <enumeration value="0324003"> <annotation> <documentation>(III): Beschwerden bei leichter körperlicher </pre>		

	<pre> Belastung</documentation> </annotation> </enumeration> <enumeration value="0324004"> <annotation> <documentation>(IV): Beschwerden in Ruhe</documentation> </annotation> </enumeration> </restriction> </simpleType> </pre>
--	---

simpleType enum_0338

namespace	http://xml.ir-d.de/irdsaa		
type	restriction of string		
properties	base xs:string		
facets	Kind	Value	Annotation
	enumeration	0338001	documentation LAD
	enumeration	0338002	documentation RCA
	enumeration	0338003	documentation RCX
	enumeration	0338004	documentation Hauptstamm
annotation	documentation Kat_AK_PCIArterien		
source	<pre> <simpleType name="enum_0338"> <annotation> <documentation>Kat_AK_PCIArterien</documentation> </annotation> <restriction base="xs:string"> <enumeration value="0338001"> <annotation> <documentation>LAD</documentation> </annotation> </enumeration> <enumeration value="0338002"> <annotation> <documentation>RCA</documentation> </annotation> </enumeration> <enumeration value="0338003"> <annotation> <documentation>RCX</documentation> </annotation> </enumeration> <enumeration value="0338004"> <annotation> <documentation>Hauptstamm</documentation> </annotation> </enumeration> </restriction> </simpleType> </pre>		

simpleType enum_0339

namespace	http://xml.ir-d.de/irdsaa		
type	restriction of string		
properties	base xs:string		
facets	Kind	Value	Annotation
	enumeration	0339001	documentation TEE
	enumeration	0339002	documentation CT
	enumeration	0339042	documentation andere
annotation	documentation Kat_AK_AnnulusMessmethode		
source	<pre> <simpleType name="enum_0339"> <annotation> <documentation>Kat_AK_AnnulusMessmethode</documentation> </annotation> <restriction base="xs:string"> <enumeration value="0339001"> <annotation> <documentation>TEE</documentation> </annotation> </enumeration> <enumeration value="0339002"> <annotation> <documentation>CT</documentation> </annotation> </enumeration> <enumeration value="0339042"> <annotation> <documentation>andere</documentation> </annotation> </enumeration> </restriction> </simpleType> </pre>		

simpleType enum_0341

namespace	http://xml.ir-d.de/irdsaa		
type	restriction of string		
properties	base xs:string		
facets	Kind	Value	Annotation
	enumeration	0341001	documentation intraprozedural verstorben
	enumeration	0341002	documentation Implantation von mehr als einer Prothese
	enumeration	0341003	documentation gravierende Gefäß- oder Zugangskomplikation (gemäß VARC-3)
	enumeration	0341004	documentation erforderlicher chirurgischer oder interventioneller Eingriff wegen einer Klappenfehlfunktion (gemäß VARC-3)
	enumeration	0341005	documentation >= große strukturelle kardiale Komplikation (gemäß VARC-3)
annotation	documentation Kat_AK_FailureGrund		

source	<pre> <simpleType name="enum_0341"> <annotation> <documentation>Kat_AK_FailureGrund</documentation> </annotation> <restriction base="xs:string"> <enumeration value="0341001"> <annotation> <documentation>intraprozedural verstorben</documentation> </annotation> </enumeration> <enumeration value="0341002"> <annotation> <documentation>Implantation von mehr als einer Prothese</documentation> </annotation> </enumeration> <enumeration value="0341003"> <annotation> <documentation>gravierende Gefäß- oder Zugangskomplikation (gemäß VARC-3)</documentation> </annotation> </enumeration> <enumeration value="0341004"> <annotation> <documentation>erforderlicher chirurgischer oder interventioneller Eingriff wegen einer Klappenfehlfunktion (gemäß VARC-3)</documentation> </annotation> </enumeration> <enumeration value="0341005"> <annotation> <documentation>&gt;= große strukturelle kardiale Komplikation (gemäß VARC-3)</documentation> </annotation> </enumeration> </restriction> </simpleType> </pre>
--------	--

simpleType enum_0342

namespace	http://xml.ir-d.de/irdsaa		
type	restriction of string		
properties	base xs:string		
facets	Kind	Value	Annotation
	enumeration	0342001	documentation Alter
	enumeration	0342002	documentation Frailty
	enumeration	0342003	documentation Hochrisiko
	enumeration	0342004	documentation Prognose-limitierende Zweiterkrankung
	enumeration	0342005	documentation Porzellan-Aorta
	enumeration	0342042	documentation sonstiger
annotation	documentation Kat_AK_Tavi		

source	<pre> <simpleType name="enum_0342"> <annotation> <documentation>Kat_AK_Tavi</documentation> </annotation> <restriction base="xs:string"> <enumeration value="0342001"> <annotation> <documentation>Alter</documentation> </annotation> </enumeration> <enumeration value="0342002"> <annotation> <documentation>Frailty</documentation> </annotation> </enumeration> <enumeration value="0342003"> <annotation> <documentation>Hochrisiko</documentation> </annotation> </enumeration> <enumeration value="0342004"> <annotation> <documentation>Prognose-limitierende Zweiterkrankung</documentation> </annotation> </enumeration> <enumeration value="0342005"> <annotation> <documentation>Porzellan-Aorta</documentation> </annotation> </enumeration> <enumeration value="0342042"> <annotation> <documentation>sonstiger</documentation> </annotation> </enumeration> </restriction> </simpleType> </pre>
--------	---

simpleType enum_0343

namespace	http://xml.ir-d.de/irdsaa		
type	restriction of string		
properties	base xs:string		
facets	Kind	Value	Annotation
	enumeration	0343001	documentation Device-Fehlpositionierung
	enumeration	0343002	documentation Koronarostienverschluss
	enumeration	0343003	documentation Aortendissektion
	enumeration	0343004	documentation Aortenregurgitation > = 2. Grades
	enumeration	0343005	documentation Annulus-Ruptur
	enumeration	0343006	documentation Ruptur-/Perforation einer Herzhöhle ohne Therapiebedarf
	enumeration	0343007	documentation

	<p>enumeration 0343008 Ruptur-/Perforation einer Herzhöhle mit Therapiebedarf documentation Perikardtamponade</p> <p>enumeration 0343009 documentation kardiale Dekompensation</p> <p>enumeration 0343010 documentation Hirnembolie</p> <p>enumeration 0343011 documentation Rhythmusstörungen</p> <p>enumeration 0343012 documentation Device-Embolisation</p> <p>enumeration 0343013 documentation vaskuläre Komplikation</p> <p>enumeration 0343014 documentation Low Cardiac Output</p> <p>enumeration 0343015 documentation schwerwiegende Blutungen (intraprozedural)</p> <p>enumeration 0343016 documentation lebensbedrohliche Blutungen (intraprozedural)</p> <p>enumeration 0343017 documentation Patient verstarb im OP/Katheterlabor</p> <p>enumeration 0343042 documentation sonstiger</p>
annotation	documentation Kat_AK_KomplikationTyp
source	<pre> <simpleType name="enum_0343"> <annotation> <documentation>Kat_AK_KomplikationTyp</documentation> </annotation> <restriction base="xs:string"> <enumeration value="0343001"> <annotation> <documentation>Device-Fehlpositionierung</documentation> </annotation> </enumeration> <enumeration value="0343002"> <annotation> <documentation>Koronarostienverschluss</documentation> </annotation> </enumeration> <enumeration value="0343003"> <annotation> <documentation>Aortendissektion</documentation> </annotation> </enumeration> <enumeration value="0343004"> <annotation> <documentation>Aortenregurgitation &gt; = 2. Grades</documentation> </annotation> </enumeration> <enumeration value="0343005"> <annotation> <documentation>Annulus-Ruptur</documentation> </annotation> </enumeration> <enumeration value="0343006"> <annotation> <documentation>Ruptur-/Perforation einer Herzhöhle ohne Therapiebedarf</documentation> </annotation> </enumeration> </restriction> </simpleType> </pre>

```

<enumeration value="0343007">
  <annotation>
    <documentation>Ruptur-/Perforation einer Herzhöhle mit
Therapiebedarf</documentation>
  </annotation>
</enumeration>
<enumeration value="0343008">
  <annotation>
    <documentation>Perikardtamponade</documentation>
  </annotation>
</enumeration>
<enumeration value="0343009">
  <annotation>
    <documentation>kardiale Dekompensation</documentation>
  </annotation>
</enumeration>
<enumeration value="0343010">
  <annotation>
    <documentation>Hirnembolie</documentation>
  </annotation>
</enumeration>
<enumeration value="0343011">
  <annotation>
    <documentation>Rhythmusstörungen</documentation>
  </annotation>
</enumeration>
<enumeration value="0343012">
  <annotation>
    <documentation>Device-Embolisation</documentation>
  </annotation>
</enumeration>
<enumeration value="0343013">
  <annotation>
    <documentation>vaskuläre Komplikation</documentation>
  </annotation>
</enumeration>
<enumeration value="0343014">
  <annotation>
    <documentation>Low Cardiac Output</documentation>
  </annotation>
</enumeration>
<enumeration value="0343015">
  <annotation>
    <documentation>schwerwiegende Blutungen
(intraprozedural)</documentation>
  </annotation>
</enumeration>
<enumeration value="0343016">
  <annotation>
    <documentation>lebensbedrohliche Blutungen
(intraprozedural)</documentation>
  </annotation>
</enumeration>
<enumeration value="0343017">
  <annotation>
    <documentation>Patient verstarb im OP/Katheterlabor</documentation>
  </annotation>
</enumeration>
<enumeration value="0343042">

```

	<pre> <annotation> <documentation>sonstiger</documentation> </annotation> </enumeration> </restriction> </simpleType> </pre>
--	--

simpleType enum_0346

namespace	http://xml.ir-d.de/irdsaa		
type	restriction of string		
properties	base xs:string		
facets	Kind	Value	Annotation
	enumeration	0346001	documentation keine Therapie erforderlich
	enumeration	0346002	documentation medikamentös
	enumeration	0346003	documentation IABP
	enumeration	0346004	documentation VAD
	enumeration	0346005	documentation ECMO
	enumeration	0346042	documentation sonstige
annotation	documentation Kat AK TherapieLCO		
source	<pre> <simpleType name="enum_0346"> <annotation> <documentation>Kat_AK_TherapieLCO</documentation> </annotation> <restriction base="xs:string"> <enumeration value="0346001"> <annotation> <documentation>keine Therapie erforderlich</documentation> </annotation> </enumeration> <enumeration value="0346002"> <annotation> <documentation>medikamentös</documentation> </annotation> </enumeration> <enumeration value="0346003"> <annotation> <documentation>IABP</documentation> </annotation> </enumeration> <enumeration value="0346004"> <annotation> <documentation>VAD</documentation> </annotation> </enumeration> <enumeration value="0346005"> <annotation> <documentation>ECMO</documentation> </annotation> </enumeration> </restriction> </simpleType> </pre>		

	<pre> <enumeration value="0346042"> <annotation> <documentation>sonstige</documentation> </annotation> </enumeration> </restriction> </simpleType> </pre>
--	---

simpleType enum_0347

namespace	http://xml.ir-d.de/irdsaa		
type	restriction of string		
properties	base xs:string		
facets	Kind	Value	Annotation
	enumeration	0347001	documentation Einzeleingriff
	enumeration	0347002	documentation Kombinationseingriff mit mehreren Prozeduren
annotation	documentation Kat_AK_Eingriffsumfang		
source	<pre> <simpleType name="enum_0347"> <annotation> <documentation>Kat_AK_Eingriffsumfang</documentation> </annotation> <restriction base="xs:string"> <enumeration value="0347001"> <annotation> <documentation>Einzeleingriff</documentation> </annotation> </enumeration> <enumeration value="0347002"> <annotation> <documentation>Kombinationseingriff mit mehreren Prozeduren</documentation> </annotation> </enumeration> </restriction> </simpleType> </pre>		

simpleType enum_0348

namespace	http://xml.ir-d.de/irdsaa		
type	restriction of string		
properties	base xs:string		
facets	Kind	Value	Annotation
	enumeration	0348001	documentation mit HLM
	enumeration	0348002	documentation ohne HLM
	enumeration	0348003	documentation Umstieg von OP ohne HLM auf OP mit HLM
annotation	documentation Kat_AK_OPVorgehen		
source	<pre> <simpleType name="enum_0348"> </pre>		

	<pre> <annotation> <documentation>Kat_AK_OPVorgehen</documentation> </annotation> <restriction base="xs:string"> <enumeration value="0348001"> <annotation> <documentation>mit HLM</documentation> </annotation> </enumeration> <enumeration value="0348002"> <annotation> <documentation>ohne HLM</documentation> </annotation> </enumeration> <enumeration value="0348003"> <annotation> <documentation>Umstieg von OP ohne HLM auf OP mit HLM</documentation> </annotation> </enumeration> </restriction> </simpleType> </pre>
--	---

simpleType enum_0350

namespace	http://xml.ir-d.de/irdsaa		
type	restriction of string		
properties	base xs:string		
facets	Kind	Value	Annotation
	enumeration	0350001	documentation IABP
	enumeration	0350002	documentation Impella
	enumeration	0350003	documentation vv ECMO
	enumeration	0350004	documentation va ECMO
	enumeration	0350042	documentation andere
annotation	documentation Kat_AK_Methode		
source	<pre> <simpleType name="enum_0350"> <annotation> <documentation>Kat_AK_Methode</documentation> </annotation> <restriction base="xs:string"> <enumeration value="0350001"> <annotation> <documentation>IABP</documentation> </annotation> </enumeration> <enumeration value="0350002"> <annotation> <documentation>Impella</documentation> </annotation> </enumeration> <enumeration value="0350003"> <annotation> </pre>		

	<pre> <documentation>vv ECMO</documentation> </annotation> </enumeration> <enumeration value="0350004"> <annotation> <documentation>va ECMO</documentation> </annotation> </enumeration> <enumeration value="0350042"> <annotation> <documentation>andere</documentation> </annotation> </enumeration> </restriction> </simpleType> </pre>
--	--

simpleType enum_0351

namespace	http://xml.ir-d.de/irdsaa		
type	restriction of string		
properties	base xs:string		
facets	Kind	Value	Annotation
	enumeration	0351001	documentation nein
	enumeration	0351002	documentation ja, zu Sternotomie
	enumeration	0351003	documentation ja, zu transapikal
	enumeration	0351004	documentation ja, zu transaortal
	enumeration	0351005	documentation ja, zu transfemoral
	enumeration	0351006	documentation ja, zu transaxillär
	enumeration	0351007	documentation ja, zu anderem endovaskulären Zugang
	enumeration	0351042	documentation ja, zu anderem Zugang
annotation	documentation Kat_AK_Konversion		
source	<pre> <simpleType name="enum_0351"> <annotation> <documentation>Kat_AK_Konversion</documentation> </annotation> <restriction base="xs:string"> <enumeration value="0351001"> <annotation> <documentation>nein</documentation> </annotation> </enumeration> <enumeration value="0351002"> <annotation> <documentation>ja, zu Sternotomie</documentation> </annotation> </enumeration> <enumeration value="0351003"> <annotation> <documentation>ja, zu transapikal</documentation> </pre>		

	<pre> </annotation> </enumeration> <enumeration value="0351004"> <annotation> <documentation>ja, zu transaortal</documentation> </annotation> </enumeration> <enumeration value="0351005"> <annotation> <documentation>ja, zu transfemoral</documentation> </annotation> </enumeration> <enumeration value="0351006"> <annotation> <documentation>ja, zu transaxillär</documentation> </annotation> </enumeration> <enumeration value="0351007"> <annotation> <documentation>ja, zu anderem endovaskulären Zugang</documentation> </annotation> </enumeration> <enumeration value="0351042"> <annotation> <documentation>ja, zu anderem Zugang</documentation> </annotation> </enumeration> </restriction> </simpleType> </pre>
--	---

simpleType enum_0352

namespace	http://xml.ir-d.de/irdsaa		
type	restriction of string		
properties	base xs:string		
facets	Kind	Value	Annotation
	enumeration	0352001	documentation nein
	enumeration	0352002	documentation ja, Intubationsnarkose
	enumeration	0352003	documentation ja, Maskenbeatmung, incl. LAMA
	enumeration	0352042	documentation ja, unbekannt welche
annotation	documentation Kat_AK_Anaesthesie		
source	<pre> <simpleType name="enum_0352"> <annotation> <documentation>Kat_AK_Anaesthesie</documentation> </annotation> <restriction base="xs:string"> <enumeration value="0352001"> <annotation> <documentation>nein</documentation> </annotation> </enumeration> <enumeration value="0352002"> </pre>		

	<pre> <annotation> <documentation>ja, Intubationsnarkose</documentation> </annotation> </enumeration> <enumeration value="0352003"> <annotation> <documentation>ja, Maskenbeatmung, incl. LAMA</documentation> </annotation> </enumeration> <enumeration value="0352042"> <annotation> <documentation>ja, unbekannt welche</documentation> </annotation> </enumeration> </restriction> </simpleType> </pre>
--	---

simpleType enum 0353

namespace	http://xml.ir-d.de/irdsaa		
type	restriction of string		
properties	base xs:string		
facets	Kind	Value	Annotation
	enumeration	0353001	documentation keine
	enumeration	0353002	documentation leichtgradig
	enumeration	0353003	documentation mittelgradig
	enumeration	0353004	documentation hochgradig
	enumeration	0353099	documentation nicht bestimmbar
annotation	documentation Kat_AK_ResidualeArteninsuffizienz		
source	<pre> <simpleType name="enum_0353"> <annotation> <documentation>Kat_AK_ResidualeArteninsuffizienz</documentation> </annotation> <restriction base="xs:string"> <enumeration value="0353001"> <annotation> <documentation>keine</documentation> </annotation> </enumeration> <enumeration value="0353002"> <annotation> <documentation>leichtgradig</documentation> </annotation> </enumeration> <enumeration value="0353003"> <annotation> <documentation>mittelgradig</documentation> </annotation> </enumeration> <enumeration value="0353004"> <annotation> </pre>		

	<pre> <documentation>hochgradig</documentation> </annotation> </enumeration> <enumeration value="0353099"> <annotation> <documentation>nicht bestimmbar</documentation> </annotation> </enumeration> </restriction> </simpleType> </pre>
--	--

simpleType enum_0354

namespace	http://xml.ir-d.de/irdsaa		
type	restriction of string		
properties	base xs:string		
facets	Kind	Value	Annotation
	enumeration	0354001	documentation chirurgisch-offen
	enumeration	0354002	documentation Verschluss-System
	enumeration	0354042	documentation sonstiger
annotation	documentation Kat_AK_Zugangswegverschluss		
source	<pre> <simpleType name="enum_0354"> <annotation> <documentation>Kat_AK_Zugangswegverschluss</documentation> </annotation> <restriction base="xs:string"> <enumeration value="0354001"> <annotation> <documentation>chirurgisch-offen</documentation> </annotation> </enumeration> <enumeration value="0354002"> <annotation> <documentation>Verschluss-System</documentation> </annotation> </enumeration> <enumeration value="0354042"> <annotation> <documentation>sonstiger</documentation> </annotation> </enumeration> </restriction> </simpleType> </pre>		

simpleType enum_0357

namespace	http://xml.ir-d.de/irdsaa		
type	restriction of string		
properties	base xs:string		

facets	<table border="1"> <thead> <tr> <th>Kind</th> <th>Value</th> <th>Annotation</th> </tr> </thead> <tbody> <tr> <td>enumeration</td> <td>0357001</td> <td>documentation keine KHK</td> </tr> <tr> <td>enumeration</td> <td>0357002</td> <td>documentation 1-Gefäßerkrankung</td> </tr> <tr> <td>enumeration</td> <td>0357003</td> <td>documentation 2-Gefäßerkrankung</td> </tr> <tr> <td>enumeration</td> <td>0357004</td> <td>documentation 3-Gefäßerkrankung</td> </tr> <tr> <td>enumeration</td> <td>0357005</td> <td>documentation keine koronare Bildgebung</td> </tr> </tbody> </table>	Kind	Value	Annotation	enumeration	0357001	documentation keine KHK	enumeration	0357002	documentation 1-Gefäßerkrankung	enumeration	0357003	documentation 2-Gefäßerkrankung	enumeration	0357004	documentation 3-Gefäßerkrankung	enumeration	0357005	documentation keine koronare Bildgebung
Kind	Value	Annotation																	
enumeration	0357001	documentation keine KHK																	
enumeration	0357002	documentation 1-Gefäßerkrankung																	
enumeration	0357003	documentation 2-Gefäßerkrankung																	
enumeration	0357004	documentation 3-Gefäßerkrankung																	
enumeration	0357005	documentation keine koronare Bildgebung																	
annotation	documentation Kat AK BefundBildgebung																		
source	<pre> <simpleType name="enum_0357"> <annotation> <documentation>Kat_AK_BefundBildgebung</documentation> </annotation> <restriction base="xs:string"> <enumeration value="0357001"> <annotation> <documentation>keine KHK</documentation> </annotation> </enumeration> <enumeration value="0357002"> <annotation> <documentation>1-Gefäßerkrankung</documentation> </annotation> </enumeration> <enumeration value="0357003"> <annotation> <documentation>2-Gefäßerkrankung</documentation> </annotation> </enumeration> <enumeration value="0357004"> <annotation> <documentation>3-Gefäßerkrankung</documentation> </annotation> </enumeration> <enumeration value="0357005"> <annotation> <documentation>keine koronare Bildgebung</documentation> </annotation> </enumeration> </restriction> </simpleType> </pre>																		

simpleType enum_0358

namespace	http://xml.ir-d.de/irdsaa												
type	restriction of string												
properties	base xs:string												
facets	<table border="1"> <thead> <tr> <th>Kind</th> <th>Value</th> <th>Annotation</th> </tr> </thead> <tbody> <tr> <td>enumeration</td> <td>0358001</td> <td>documentation 0</td> </tr> <tr> <td>enumeration</td> <td>0358002</td> <td>documentation 1</td> </tr> <tr> <td>enumeration</td> <td>0358003</td> <td>documentation 2</td> </tr> </tbody> </table>	Kind	Value	Annotation	enumeration	0358001	documentation 0	enumeration	0358002	documentation 1	enumeration	0358003	documentation 2
Kind	Value	Annotation											
enumeration	0358001	documentation 0											
enumeration	0358002	documentation 1											
enumeration	0358003	documentation 2											

	<p>enumeration 0358004 documentation 3</p> <p>enumeration 0358005 documentation 4</p> <p>enumeration 0358006 documentation 5 oder mehr</p> <p>enumeration 0358098 documentation genaue Anzahl unbekannt (aber mind. 1)</p> <p>enumeration 0358099 documentation unbekannt</p>
annotation	documentation Kat_AK_AnzahlVorOP
source	<pre> <simpleType name="enum_0358"> <annotation> <documentation>Kat_AK_AnzahlVorOP</documentation> </annotation> <restriction base="xs:string"> <enumeration value="0358001"> <annotation> <documentation>0</documentation> </annotation> </enumeration> <enumeration value="0358002"> <annotation> <documentation>1</documentation> </annotation> </enumeration> <enumeration value="0358003"> <annotation> <documentation>2</documentation> </annotation> </enumeration> <enumeration value="0358004"> <annotation> <documentation>3</documentation> </annotation> </enumeration> <enumeration value="0358005"> <annotation> <documentation>4</documentation> </annotation> </enumeration> <enumeration value="0358006"> <annotation> <documentation>5 oder mehr</documentation> </annotation> </enumeration> <enumeration value="0358098"> <annotation> <documentation>genaue Anzahl unbekannt (aber mind. 1)</documentation> </annotation> </enumeration> <enumeration value="0358099"> <annotation> <documentation>unbekannt</documentation> </annotation> </enumeration> </restriction> </simpleType> </pre>

simpleType enum 0359

namespace	http://xml.ir-d.de/irdsaa		
type	restriction of string		
properties	base xs:string		
facets	Kind	Value	Annotation
	enumeration	0359001	documentation nein
	enumeration	0359002	documentation ja - einseitig
	enumeration	0359003	documentation ja - beidseitig
	enumeration	0359042	documentation unbekannt
annotation	documentation Kat AK LVOT		
source	<pre> <simpleType name="enum_0359"> <annotation> <documentation>Kat_AK_LVOT</documentation> </annotation> <restriction base="xs:string"> <enumeration value="0359001"> <annotation> <documentation>nein</documentation> </annotation> </enumeration> <enumeration value="0359002"> <annotation> <documentation>ja - einseitig</documentation> </annotation> </enumeration> <enumeration value="0359003"> <annotation> <documentation>ja - beidseitig</documentation> </annotation> </enumeration> <enumeration value="0359042"> <annotation> <documentation>unbekannt</documentation> </annotation> </enumeration> </restriction> </simpleType> </pre>		

simpleType enum 0360

namespace	http://xml.ir-d.de/irdsaa		
type	restriction of string		
properties	base xs:string		
facets	Kind	Value	Annotation
	enumeration	0360001	documentation keine
	enumeration	0360002	documentation leichtgradig

	enumeration 0360003 documentation mittelgradig enumeration 0360004 documentation hochgradig enumeration 0360005 documentation massive enumeration 0360006 documentation torrential enumeration 0360099 documentation unbekannt
annotation	documentation Kat_AK_TriskupidalInsuffizienz
source	<pre> <simpleType name="enum_0360"> <annotation> <documentation>Kat_AK_TriskupidalInsuffizienz</documentation> </annotation> <restriction base="xs:string"> <enumeration value="0360001"> <annotation> <documentation>keine</documentation> </annotation> </enumeration> <enumeration value="0360002"> <annotation> <documentation>leichtgradig</documentation> </annotation> </enumeration> <enumeration value="0360003"> <annotation> <documentation>mittelgradig</documentation> </annotation> </enumeration> <enumeration value="0360004"> <annotation> <documentation>hochgradig</documentation> </annotation> </enumeration> <enumeration value="0360005"> <annotation> <documentation>massive</documentation> </annotation> </enumeration> <enumeration value="0360006"> <annotation> <documentation>torrential</documentation> </annotation> </enumeration> <enumeration value="0360099"> <annotation> <documentation>unbekannt</documentation> </annotation> </enumeration> </restriction> </simpleType> </pre>

simpleType enum_0361

namespace	http://xml.ir-d.de/irdsaa
-----------	---------------------------

type	restriction of string		
properties	base xs:string		
facets	Kind	Value	Annotation
	enumeration	0361001	documentation nein
	enumeration	0361002	documentation ja, letzte(r) innerhalb der letzten 48 Stunden
	enumeration	0361003	documentation ja, letzte(r) innerhalb der letzten 21 Tage
	enumeration	0361004	documentation ja, letzte(r) länger als 21 Tage
	enumeration	0361098	documentation ja, letzter Zeitpunkt unbekannt
	enumeration	0361099	documentation unbekannt
annotation	documentation Kat AK SchockReanimation		
source	<pre> <simpleType name="enum_0361"> <annotation> <documentation>Kat_AK_SchockReanimation</documentation> </annotation> <restriction base="xs:string"> <enumeration value="0361001"> <annotation> <documentation>nein</documentation> </annotation> </enumeration> <enumeration value="0361002"> <annotation> <documentation>ja, letzte(r) innerhalb der letzten 48 Stunden</documentation> </annotation> </enumeration> <enumeration value="0361003"> <annotation> <documentation>ja, letzte(r) innerhalb der letzten 21 Tage</documentation> </annotation> </enumeration> <enumeration value="0361004"> <annotation> <documentation>ja, letzte(r) länger als 21 Tage</documentation> </annotation> </enumeration> <enumeration value="0361098"> <annotation> <documentation>ja, letzter Zeitpunkt unbekannt</documentation> </annotation> </enumeration> <enumeration value="0361099"> <annotation> <documentation>unbekannt</documentation> </annotation> </enumeration> </restriction> </simpleType> </pre>		

simpleType enum_0362

namespace	http://xml.ir-d.de/irdsaa		
type	restriction of string		
properties	base xs:string		
facets	Kind	Value	Annotation
	enumeration	0362001	documentation Sinusrhythmus
	enumeration	0362002	documentation Vorhofflimmern
	enumeration	0362042	documentation anderer Herzrhythmus
annotation	documentation Kat_AK_Herzrhythmus		
source	<pre> <simpleType name="enum_0362"> <annotation> <documentation>Kat_AK_Herzrhythmus</documentation> </annotation> <restriction base="xs:string"> <enumeration value="0362001"> <annotation> <documentation>Sinusrhythmus</documentation> </annotation> </enumeration> <enumeration value="0362002"> <annotation> <documentation>Vorhofflimmern</documentation> </annotation> </enumeration> <enumeration value="0362042"> <annotation> <documentation>anderer Herzrhythmus</documentation> </annotation> </enumeration> </restriction> </simpleType> </pre>		

simpleType enum_0363

namespace	http://xml.ir-d.de/irdsaa		
type	restriction of string		
properties	base xs:string		
facets	Kind	Value	Annotation
	enumeration	0363001	documentation nein
	enumeration	0363002	documentation paroxysmal
	enumeration	0363003	documentation persistierend
	enumeration	0363004	documentation permanent
annotation	documentation Kat_AK_Vorhofflimmern		
source	<pre> <simpleType name="enum_0363"> <annotation> <documentation>Kat AK Vorhofflimmern</documentation> </annotation> </pre>		

	<pre> </annotation> <restriction base="xs:string"> <enumeration value="0363001"> <annotation> <documentation>nein</documentation> </annotation> </enumeration> <enumeration value="0363002"> <annotation> <documentation>paroxysmal</documentation> </annotation> </enumeration> <enumeration value="0363003"> <annotation> <documentation>persistierend</documentation> </annotation> </enumeration> <enumeration value="0363004"> <annotation> <documentation>permanent</documentation> </annotation> </enumeration> </restriction> </simpleType> </pre>
--	--

simpleType enum_0364

namespace	http://xml.ir-d.de/irdsaa		
type	restriction of string		
properties	base xs:string		
facets	Kind	Value	Annotation
	enumeration	0364001	documentation nein
	enumeration	0364002	documentation Schrittmacher ohne CRT-System
	enumeration	0364003	documentation Schrittmacher mit CRT-System
	enumeration	0364004	documentation Defibrillator ohne CRT-System
	enumeration	0364005	documentation Defibrillator mit CRT-System
annotation	documentation Kat_AK_SchrittmacherDefi		
source	<pre> <simpleType name="enum_0364"> <annotation> <documentation>Kat_AK_SchrittmacherDefi</documentation> </annotation> <restriction base="xs:string"> <enumeration value="0364001"> <annotation> <documentation>nein</documentation> </annotation> </enumeration> <enumeration value="0364002"> <annotation> <documentation>Schrittmacher ohne CRT-System</documentation> </annotation> </enumeration> </restriction> </simpleType> </pre>		

	<pre> </enumeration> <enumeration value="0364003"> <annotation> <documentation>Schrittmacher mit CRT-System</documentation> </annotation> </enumeration> <enumeration value="0364004"> <annotation> <documentation>Defibrillator ohne CRT-System</documentation> </annotation> </enumeration> <enumeration value="0364005"> <annotation> <documentation>Defibrillator mit CRT-System</documentation> </annotation> </enumeration> </restriction> </simpleType> </pre>
--	---

simpleType enum_0365

namespace	http://xml.ir-d.de/irdsaa		
type	restriction of string		
properties	base xs:string		
facets	Kind	Value	Annotation
	enumeration	0365001	documentation nein
	enumeration	0365002	documentation ja, operativ
	enumeration	0365003	documentation ja, interventionell
annotation	documentation Kat AK MyokardRevaskularisation		
source	<pre> <simpleType name="enum_0365"> <annotation> <documentation>Kat_AK_MyokardRevaskularisation</documentation> </annotation> <restriction base="xs:string"> <enumeration value="0365001"> <annotation> <documentation>nein</documentation> </annotation> </enumeration> <enumeration value="0365002"> <annotation> <documentation>ja, operativ</documentation> </annotation> </enumeration> <enumeration value="0365003"> <annotation> <documentation>ja, interventionell</documentation> </annotation> </enumeration> </restriction> </simpleType> </pre>		

simpleType enum_0366

namespace	http://xml.ir-d.de/irdsaa		
type	restriction of string		
properties	base xs:string		
facets	Kind	Value	Annotation
	enumeration	0366001	documentation nein
	enumeration	0366002	documentation ja, <= 6 Stunden
	enumeration	0366003	documentation ja, > 6 Stunden bis <= 3 Monate
	enumeration	0366004	documentation ja, > 3 Monate
	enumeration	0366099	documentation unbekannt
annotation	documentation Kat_AK_PCI		
source	<pre> <simpleType name="enum_0366"> <annotation> <documentation>Kat_AK_PCI</documentation> </annotation> <restriction base="xs:string"> <enumeration value="0366001"> <annotation> <documentation>nein</documentation> </annotation> </enumeration> <enumeration value="0366002"> <annotation> <documentation>ja, &lt;= 6 Stunden</documentation> </annotation> </enumeration> <enumeration value="0366003"> <annotation> <documentation>ja, &gt; 6 Stunden bis &lt;= 3 Monate</documentation> </annotation> </enumeration> <enumeration value="0366004"> <annotation> <documentation>ja, &gt; 3 Monate</documentation> </annotation> </enumeration> <enumeration value="0366099"> <annotation> <documentation>unbekannt</documentation> </annotation> </enumeration> </restriction> </simpleType> </pre>		

simpleType enum_0367

namespace	http://xml.ir-d.de/irdsaa
type	restriction of string

properties	base xs:string																																																			
facets	<table border="1"> <thead> <tr> <th>Kind</th> <th>Value</th> <th>Annotation</th> </tr> </thead> <tbody> <tr> <td>enumeration</td> <td>0367001</td> <td>documentation keine</td> </tr> <tr> <td>enumeration</td> <td>0367002</td> <td>documentation Mediastinitis</td> </tr> <tr> <td>enumeration</td> <td>0367003</td> <td>documentation Sepsis</td> </tr> <tr> <td>enumeration</td> <td>0367004</td> <td>documentation broncho-pulmonale Infektion</td> </tr> <tr> <td>enumeration</td> <td>0367005</td> <td>documentation oto-laryngologische Infektion</td> </tr> <tr> <td>enumeration</td> <td>0367006</td> <td>documentation floride Endokarditis</td> </tr> <tr> <td>enumeration</td> <td>0367007</td> <td>documentation Peritonitis</td> </tr> <tr> <td>enumeration</td> <td>0367008</td> <td>documentation Wundinfektion Thorax</td> </tr> <tr> <td>enumeration</td> <td>0367009</td> <td>documentation Pleuraempyem</td> </tr> <tr> <td>enumeration</td> <td>0367010</td> <td>documentation Venenkatheterinfektion</td> </tr> <tr> <td>enumeration</td> <td>0367011</td> <td>documentation Harnwegsinfektion</td> </tr> <tr> <td>enumeration</td> <td>0367012</td> <td>documentation Wundinfektion untere Extremitäten</td> </tr> <tr> <td>enumeration</td> <td>0367013</td> <td>documentation HIV-Infektion</td> </tr> <tr> <td>enumeration</td> <td>0367014</td> <td>documentation Hepatitis B oder C</td> </tr> <tr> <td>enumeration</td> <td>0367015</td> <td>documentation andere Wundinfektion</td> </tr> <tr> <td>enumeration</td> <td>0367042</td> <td>documentation sonstige</td> </tr> </tbody> </table>	Kind	Value	Annotation	enumeration	0367001	documentation keine	enumeration	0367002	documentation Mediastinitis	enumeration	0367003	documentation Sepsis	enumeration	0367004	documentation broncho-pulmonale Infektion	enumeration	0367005	documentation oto-laryngologische Infektion	enumeration	0367006	documentation floride Endokarditis	enumeration	0367007	documentation Peritonitis	enumeration	0367008	documentation Wundinfektion Thorax	enumeration	0367009	documentation Pleuraempyem	enumeration	0367010	documentation Venenkatheterinfektion	enumeration	0367011	documentation Harnwegsinfektion	enumeration	0367012	documentation Wundinfektion untere Extremitäten	enumeration	0367013	documentation HIV-Infektion	enumeration	0367014	documentation Hepatitis B oder C	enumeration	0367015	documentation andere Wundinfektion	enumeration	0367042	documentation sonstige
Kind	Value	Annotation																																																		
enumeration	0367001	documentation keine																																																		
enumeration	0367002	documentation Mediastinitis																																																		
enumeration	0367003	documentation Sepsis																																																		
enumeration	0367004	documentation broncho-pulmonale Infektion																																																		
enumeration	0367005	documentation oto-laryngologische Infektion																																																		
enumeration	0367006	documentation floride Endokarditis																																																		
enumeration	0367007	documentation Peritonitis																																																		
enumeration	0367008	documentation Wundinfektion Thorax																																																		
enumeration	0367009	documentation Pleuraempyem																																																		
enumeration	0367010	documentation Venenkatheterinfektion																																																		
enumeration	0367011	documentation Harnwegsinfektion																																																		
enumeration	0367012	documentation Wundinfektion untere Extremitäten																																																		
enumeration	0367013	documentation HIV-Infektion																																																		
enumeration	0367014	documentation Hepatitis B oder C																																																		
enumeration	0367015	documentation andere Wundinfektion																																																		
enumeration	0367042	documentation sonstige																																																		
annotation	documentation Kat_AK_Infektion																																																			
source	<pre> <simpleType name="enum_0367"> <annotation> <documentation>Kat_AK_Infektion</documentation> </annotation> <restriction base="xs:string"> <enumeration value="0367001"> <annotation> <documentation>keine</documentation> </annotation> </enumeration> <enumeration value="0367002"> <annotation> <documentation>Mediastinitis</documentation> </annotation> </enumeration> <enumeration value="0367003"> <annotation> <documentation>Sepsis</documentation> </annotation> </enumeration> <enumeration value="0367004"> <annotation> <documentation>broncho-pulmonale Infektion</documentation> </annotation> </enumeration> </restriction> </simpleType> </pre>																																																			

```
<enumeration value="0367005">
  <annotation>
    <documentation>oto-laryngologische Infektion</documentation>
  </annotation>
</enumeration>
<enumeration value="0367006">
  <annotation>
    <documentation>floride Endokarditis</documentation>
  </annotation>
</enumeration>
<enumeration value="0367007">
  <annotation>
    <documentation>Peritonitis</documentation>
  </annotation>
</enumeration>
<enumeration value="0367008">
  <annotation>
    <documentation>Wundinfektion Thorax</documentation>
  </annotation>
</enumeration>
<enumeration value="0367009">
  <annotation>
    <documentation>Pleuraempyem</documentation>
  </annotation>
</enumeration>
<enumeration value="0367010">
  <annotation>
    <documentation>Venenkatheterinfektion</documentation>
  </annotation>
</enumeration>
<enumeration value="0367011">
  <annotation>
    <documentation>Harnwegsinfektion</documentation>
  </annotation>
</enumeration>
<enumeration value="0367012">
  <annotation>
    <documentation>Wundinfektion untere Extremitäten</documentation>
  </annotation>
</enumeration>
<enumeration value="0367013">
  <annotation>
    <documentation>HIV-Infektion</documentation>
  </annotation>
</enumeration>
<enumeration value="0367014">
  <annotation>
    <documentation>Hepatitis B oder C</documentation>
  </annotation>
</enumeration>
<enumeration value="0367015">
  <annotation>
    <documentation>andere Wundinfektion</documentation>
  </annotation>
</enumeration>
<enumeration value="0367042">
  <annotation>
    <documentation>sonstige</documentation>
  </annotation>
</enumeration>
```

```

</enumeration>
</restriction>
</simpleType>

```

simpleType enum_0368

namespace	http://xml.ir-d.de/irdsaa		
type	restriction of string		
properties	base xs:string		
facets	Kind	Value	Annotation
	enumeration	0368001	documentation nein
	enumeration	0368002	documentation ja, COPD mit Dauermedikation
	enumeration	0368003	documentation ja, COPD ohne Dauermedikation
	enumeration	0368004	documentation ja, andere Lungenerkrankungen
	enumeration	0368099	documentation unbekannt
annotation	documentation Kat_AK_Lungenerkrankung		
source	<pre> <simpleType name="enum_0368"> <annotation> <documentation>Kat_AK_Lungenerkrankung</documentation> </annotation> <restriction base="xs:string"> <enumeration value="0368001"> <annotation> <documentation>nein</documentation> </annotation> </enumeration> <enumeration value="0368002"> <annotation> <documentation>ja, COPD mit Dauermedikation</documentation> </annotation> </enumeration> <enumeration value="0368003"> <annotation> <documentation>ja, COPD ohne Dauermedikation</documentation> </annotation> </enumeration> <enumeration value="0368004"> <annotation> <documentation>ja, andere Lungenerkrankungen</documentation> </annotation> </enumeration> <enumeration value="0368099"> <annotation> <documentation>unbekannt</documentation> </annotation> </enumeration> </restriction> </simpleType> </pre>		

simpleType enum_0369

namespace	http://xml.ir-d.de/irdsaa		
type	restriction of string		
properties	base xs:string		
facets	Kind	Value	Annotation
	enumeration	0369001	documentation nein
	enumeration	0369002	documentation akut
	enumeration	0369003	documentation chronisch
annotation	documentation Kat_AK_Nierenersatztherapie		
source	<pre> <simpleType name="enum_0369"> <annotation> <documentation>Kat_AK_Nierenersatztherapie</documentation> </annotation> <restriction base="xs:string"> <enumeration value="0369001"> <annotation> <documentation>nein</documentation> </annotation> </enumeration> <enumeration value="0369002"> <annotation> <documentation>akut</documentation> </annotation> </enumeration> <enumeration value="0369003"> <annotation> <documentation>chronisch</documentation> </annotation> </enumeration> </restriction> </simpleType> </pre>		

simpleType enum_0370

namespace	http://xml.ir-d.de/irdsaa		
type	restriction of string		
properties	base xs:string		
facets	Kind	Value	Annotation
	enumeration	0370001	documentation Echokardiographie
	enumeration	0370002	documentation Herzkatheter
	enumeration	0370042	documentation andere
annotation	documentation Kat_AK_AKOEFMessmethode		
source	<pre> <simpleType name="enum_0370"> <annotation> <documentation>Kat_AK_AKOEFMessmethode</documentation> </annotation> <restriction base="xs:string"> </pre>		

	<pre> <enumeration value="0370001"> <annotation> <documentation>Echokardiographie</documentation> </annotation> </enumeration> <enumeration value="0370002"> <annotation> <documentation>Herzkatheter</documentation> </annotation> </enumeration> <enumeration value="0370042"> <annotation> <documentation>andere</documentation> </annotation> </enumeration> </restriction> </simpleType> </pre>
--	--

simpleType enum 0371

namespace	http://xml.ir-d.de/irdsaa		
type	restriction of string		
properties	base xs:string		
facets	Kind	Value	Annotation
	enumeration	0371001	documentation keine
	enumeration	0371002	documentation leicht
	enumeration	0371003	documentation mittel
	enumeration	0371004	documentation schwer
	enumeration	0371099	documentation unbekannt
annotation	documentation Kat_AK_Verkalkungsgrad		
source	<pre> <simpleType name="enum_0371"> <annotation> <documentation>Kat_AK_Verkalkungsgrad</documentation> </annotation> <restriction base="xs:string"> <enumeration value="0371001"> <annotation> <documentation>keine</documentation> </annotation> </enumeration> <enumeration value="0371002"> <annotation> <documentation>leicht</documentation> </annotation> </enumeration> <enumeration value="0371003"> <annotation> <documentation>mittel</documentation> </annotation> </enumeration> <enumeration value="0371004"> </pre>		

	<pre> <annotation> <documentation>schwer</documentation> </annotation> </enumeration> <enumeration value="0371099"> <annotation> <documentation>unbekannt</documentation> </annotation> </enumeration> </restriction> </simpleType> </pre>
--	--

simpleType enum_0372

namespace	http://xml.ir-d.de/irdsaa		
type	restriction of string		
properties	base xs:string		
facets	Kind	Value	Annotation
	enumeration	0372001	documentation nein
	enumeration	0372002	documentation ja, bicuspide
	enumeration	0372003	documentation ja, unicuspide
	enumeration	0372099	documentation unbekannt
annotation	documentation Kat_AK_BiUnicuspideKlappe		
source	<pre> <simpleType name="enum_0372"> <annotation> <documentation>Kat_AK_BiUnicuspideKlappe</documentation> </annotation> <restriction base="xs:string"> <enumeration value="0372001"> <annotation> <documentation>nein</documentation> </annotation> </enumeration> <enumeration value="0372002"> <annotation> <documentation>ja, bicuspide</documentation> </annotation> </enumeration> <enumeration value="0372003"> <annotation> <documentation>ja, unicuspide</documentation> </annotation> </enumeration> <enumeration value="0372099"> <annotation> <documentation>unbekannt</documentation> </annotation> </enumeration> </restriction> </simpleType> </pre>		

simpleType enum_0373

namespace	http://xml.ir-d.de/irdsaa		
type	restriction of string		
properties	base xs:string		
facets	Kind	Value	Annotation
	enumeration	0373001	documentation keine
	enumeration	0373002	documentation leichtgradig
	enumeration	0373003	documentation mittelgradig
	enumeration	0373004	documentation hochgradig
	enumeration	0373099	documentation unbekannt
annotation	documentation Kat_AK_Grad		
source	<pre> <simpleType name="enum_0373"> <annotation> <documentation>Kat_AK_Grad</documentation> </annotation> <restriction base="xs:string"> <enumeration value="0373001"> <annotation> <documentation>keine</documentation> </annotation> </enumeration> <enumeration value="0373002"> <annotation> <documentation>leichtgradig</documentation> </annotation> </enumeration> <enumeration value="0373003"> <annotation> <documentation>mittelgradig</documentation> </annotation> </enumeration> <enumeration value="0373004"> <annotation> <documentation>hochgradig</documentation> </annotation> </enumeration> <enumeration value="0373099"> <annotation> <documentation>unbekannt</documentation> </annotation> </enumeration> </restriction> </simpleType> </pre>		

simpleType enum_0374

namespace	http://xml.ir-d.de/irdsaa
type	restriction of string

properties	base xs:string																								
facets	<table border="1"> <thead> <tr> <th>Kind</th> <th>Value</th> <th>Annotation</th> </tr> </thead> <tbody> <tr> <td>enumeration</td> <td>0374001</td> <td>documentation nein</td> </tr> <tr> <td>enumeration</td> <td>0374002</td> <td>documentation ja, &lt;= 6 Stunden</td> </tr> <tr> <td>enumeration</td> <td>0374003</td> <td>documentation ja, &gt; 6 Stunden bis &lt;= 24 Stunden</td> </tr> <tr> <td>enumeration</td> <td>0374004</td> <td>documentation ja, &gt; 1 bis 7 Tage</td> </tr> <tr> <td>enumeration</td> <td>0374005</td> <td>documentation ja, &gt; 7 bis 21 Tage</td> </tr> <tr> <td>enumeration</td> <td>0374006</td> <td>documentation ja, &gt; 21 Tage</td> </tr> <tr> <td>enumeration</td> <td>0374099</td> <td>documentation unbekannt</td> </tr> </tbody> </table>	Kind	Value	Annotation	enumeration	0374001	documentation nein	enumeration	0374002	documentation ja, <= 6 Stunden	enumeration	0374003	documentation ja, > 6 Stunden bis <= 24 Stunden	enumeration	0374004	documentation ja, > 1 bis 7 Tage	enumeration	0374005	documentation ja, > 7 bis 21 Tage	enumeration	0374006	documentation ja, > 21 Tage	enumeration	0374099	documentation unbekannt
Kind	Value	Annotation																							
enumeration	0374001	documentation nein																							
enumeration	0374002	documentation ja, <= 6 Stunden																							
enumeration	0374003	documentation ja, > 6 Stunden bis <= 24 Stunden																							
enumeration	0374004	documentation ja, > 1 bis 7 Tage																							
enumeration	0374005	documentation ja, > 7 bis 21 Tage																							
enumeration	0374006	documentation ja, > 21 Tage																							
enumeration	0374099	documentation unbekannt																							
annotation	documentation Kat_AK_InfarktAnamnese																								
source	<pre> <simpleType name="enum_0374"> <annotation> <documentation>Kat_AK_InfarktAnamnese</documentation> </annotation> <restriction base="xs:string"> <enumeration value="0374001"> <annotation> <documentation>nein</documentation> </annotation> </enumeration> <enumeration value="0374002"> <annotation> <documentation>ja, &lt;= 6 Stunden</documentation> </annotation> </enumeration> <enumeration value="0374003"> <annotation> <documentation>ja, &gt; 6 Stunden bis &lt;= 24 Stunden</documentation> </annotation> </enumeration> <enumeration value="0374004"> <annotation> <documentation>ja, &gt; 1 bis 7 Tage</documentation> </annotation> </enumeration> <enumeration value="0374005"> <annotation> <documentation>ja, &gt; 7 bis 21 Tage</documentation> </annotation> </enumeration> <enumeration value="0374006"> <annotation> <documentation>ja, &gt; 21 Tage</documentation> </annotation> </enumeration> <enumeration value="0374099"> <annotation> <documentation>unbekannt</documentation> </annotation> </enumeration> </restriction> </pre>																								

	<code></simpleType></code>
--	----------------------------------

simpleType enum_0375

namespace	http://xml.ir-d.de/irdsaa																								
type	restriction of string																								
properties	base xs:string																								
facets	<table><thead><tr><th>Kind</th><th>Value</th><th>Annotation</th></tr></thead><tbody><tr><td>enumeration</td><td>0375001</td><td>documentation keine Symptome oder Angina</td></tr><tr><td>enumeration</td><td>0375002</td><td>documentation Symptome, aber keine Ischämiezeichen</td></tr><tr><td>enumeration</td><td>0375003</td><td>documentation stabile Angina</td></tr><tr><td>enumeration</td><td>0375004</td><td>documentation instabile Angina</td></tr><tr><td>enumeration</td><td>0375005</td><td>documentation Infarkt ohne ST-Hebung (Non-STEMI)</td></tr><tr><td>enumeration</td><td>0375006</td><td>documentation Infarkt mit ST-Hebung (STEMI)</td></tr><tr><td>enumeration</td><td>0375042</td><td>documentation unbekannt</td></tr></tbody></table>	Kind	Value	Annotation	enumeration	0375001	documentation keine Symptome oder Angina	enumeration	0375002	documentation Symptome, aber keine Ischämiezeichen	enumeration	0375003	documentation stabile Angina	enumeration	0375004	documentation instabile Angina	enumeration	0375005	documentation Infarkt ohne ST-Hebung (Non-STEMI)	enumeration	0375006	documentation Infarkt mit ST-Hebung (STEMI)	enumeration	0375042	documentation unbekannt
Kind	Value	Annotation																							
enumeration	0375001	documentation keine Symptome oder Angina																							
enumeration	0375002	documentation Symptome, aber keine Ischämiezeichen																							
enumeration	0375003	documentation stabile Angina																							
enumeration	0375004	documentation instabile Angina																							
enumeration	0375005	documentation Infarkt ohne ST-Hebung (Non-STEMI)																							
enumeration	0375006	documentation Infarkt mit ST-Hebung (STEMI)																							
enumeration	0375042	documentation unbekannt																							
annotation	documentation Kat_AK_KardialeSymptome																								
source	<pre><simpleType name="enum_0375"> <annotation> <documentation>Kat_AK_KardialeSymptome</documentation> </annotation> <restriction base="xs:string"> <enumeration value="0375001"> <annotation> <documentation>keine Symptome oder Angina</documentation> </annotation> </enumeration> <enumeration value="0375002"> <annotation> <documentation>Symptome, aber keine Ischämiezeichen</documentation> </annotation> </enumeration> <enumeration value="0375003"> <annotation> <documentation>stabile Angina</documentation> </annotation> </enumeration> <enumeration value="0375004"> <annotation> <documentation>instabile Angina</documentation> </annotation> </enumeration> <enumeration value="0375005"> <annotation> <documentation>Infarkt ohne ST-Hebung (Non-STEMI)</documentation> </annotation> </enumeration> <enumeration value="0375006"> <annotation> <documentation>Infarkt mit ST-Hebung (STEMI)</documentation> </annotation> </enumeration> </restriction> </simpleType></pre>																								

	<pre> </annotation> </enumeration> <enumeration value="0375042"> <annotation> <documentation>unbekannt</documentation> </annotation> </enumeration> </restriction> </simpleType> </pre>
--	---

simpleType enum_0376

namespace	http://xml.ir-d.de/irdsaa		
type	restriction of string		
properties	base xs:string		
facets	Kind	Value	Annotation
	enumeration	0376001	documentation nein
	enumeration	0376002	documentation ja, ZNS, zerebrovaskuläre Blutung
	enumeration	0376003	documentation ja, ZNS, zerebrovaskuläre Ischämie
	enumeration	0376042	documentation ja, ZNS, andere
annotation	documentation Kat_AK_Schlaganfall		
source	<pre> <simpleType name="enum_0376"> <annotation> <documentation>Kat_AK_Schlaganfall</documentation> </annotation> <restriction base="xs:string"> <enumeration value="0376001"> <annotation> <documentation>nein</documentation> </annotation> </enumeration> <enumeration value="0376002"> <annotation> <documentation>ja, ZNS, zerebrovaskuläre Blutung</documentation> </annotation> </enumeration> <enumeration value="0376003"> <annotation> <documentation>ja, ZNS, zerebrovaskuläre Ischämie</documentation> </annotation> </enumeration> <enumeration value="0376042"> <annotation> <documentation>ja, ZNS, andere</documentation> </annotation> </enumeration> </restriction> </simpleType> </pre>		

simpleType enum_0377

namespace	http://xml.ir-d.de/irdsaa		
type	restriction of string		
properties	base xs:string		
facets	Kind	Value	Annotation
	enumeration	0377001	documentation ja, mild neurological dysfunction: NIHSS 0-5
	enumeration	0377002	documentation ja, moderate neurological dysfunction: NIHSS 6-14
	enumeration	0377003	documentation ja, severe neurological dysfunction: NIHSS >=15
annotation	documentation Kat_AK_Nihss		
source	<pre> <simpleType name="enum_0377"> <annotation> <documentation>Kat_AK_Nihss</documentation> </annotation> <restriction base="xs:string"> <enumeration value="0377001"> <annotation> <documentation>ja, mild neurological dysfunction: NIHSS 0- 5</documentation> </annotation> </enumeration> <enumeration value="0377002"> <annotation> <documentation>ja, moderate neurological dysfunction: NIHSS 6- 14</documentation> </annotation> </enumeration> <enumeration value="0377003"> <annotation> <documentation>ja, severe neurological dysfunction: NIHSS &gt;=15</documentation> </annotation> </enumeration> </restriction> </simpleType> </pre>		

simpleType enum_0378

namespace	http://xml.ir-d.de/irdsaa		
type	restriction of string		
properties	base xs:string		
facets	Kind	Value	Annotation
	enumeration	0378001	documentation nein
	enumeration	0378002	documentation ja, < 48h gemäss VARC-3-Definition
	enumeration	0378003	documentation ja, >= 48h - <= 72h gemäß VARC-3-Definition
	enumeration	0378004	documentation ja, > 72 h gemäß VARC-3 Definition
annotation	documentation Kat_AK_Myokardinfarkt		

source	<pre> <simpleType name="enum_0378"> <annotation> <documentation>Kat_AK_Myokardinfarkt</documentation> </annotation> <restriction base="xs:string"> <enumeration value="0378001"> <annotation> <documentation>nein</documentation> </annotation> </enumeration> <enumeration value="0378002"> <annotation> <documentation>ja, &lt; 48h gemäss VARC-3-Definition</documentation> </annotation> </enumeration> <enumeration value="0378003"> <annotation> <documentation>ja, &gt;= 48h - &lt;= 72h gemäß VARC-3- Definition</documentation> </annotation> </enumeration> <enumeration value="0378004"> <annotation> <documentation>ja, &gt; 72 h gemäß VARC-3 Definition</documentation> </annotation> </enumeration> </restriction> </simpleType> </pre>
--------	--

simpleType enum_0379

namespace	http://xml.ir-d.de/irdsaa		
type	restriction of string		
properties	base xs:string		
facets	Kind	Value	Annotation
	enumeration	0379001	documentation Keine gefäss- oder zugangsassozierte Komplikationen
	enumeration	0379002	documentation Versagen des perkutanen Verschlusssystems
	enumeration	0379003	documentation Geringfügige Gefäßkomplikationen
	enumeration	0379004	documentation Erhebliche Gefäßkomplikationen
annotation	documentation Kat_AK_ZugangKomplikationen		
source	<pre> <simpleType name="enum_0379"> <annotation> <documentation>Kat_AK_ZugangKomplikationen</documentation> </annotation> <restriction base="xs:string"> <enumeration value="0379001"> <annotation> <documentation>Keine gefäss- oder zugangsassozierte Komplikationen</documentation> </annotation> </enumeration> <enumeration value="0379002"> </pre>		

	<pre> <annotation> <documentation>Versagen des perkutanen Verschlussystems</documentation> </annotation> </enumeration> <enumeration value="0379003"> <annotation> <documentation>Geringfügige Gefäßkomplikationen</documentation> </annotation> </enumeration> <enumeration value="0379004"> <annotation> <documentation>Erhebliche Gefäßkomplikationen</documentation> </annotation> </enumeration> </restriction> </simpleType> </pre>
--	---

simpleType enum_0380

namespace	http://xml.ir-d.de/irdsaa		
type	restriction of string		
properties	base xs:string		
facets	Kind	Value	Annotation
	enumeration	0380001	documentation nein
	enumeration	0380002	documentation ja, intraprozedural
	enumeration	0380003	documentation ja, postprozedural
	enumeration	0380004	documentation ja, Zeitpunkt nicht bekannt
annotation	documentation Kat_AK_Reanimation		
source	<pre> <simpleType name="enum_0380"> <annotation> <documentation>Kat_AK_Reanimation</documentation> </annotation> <restriction base="xs:string"> <enumeration value="0380001"> <annotation> <documentation>nein</documentation> </annotation> </enumeration> <enumeration value="0380002"> <annotation> <documentation>ja, intraprozedural</documentation> </annotation> </enumeration> <enumeration value="0380003"> <annotation> <documentation>ja, postprozedural</documentation> </annotation> </enumeration> <enumeration value="0380004"> <annotation> <documentation>ja, Zeitpunkt nicht bekannt</documentation> </annotation> </enumeration> </restriction> </simpleType> </pre>		

```

</annotation>
</enumeration>
</restriction>
</simpleType>

```

simpleType enum_0381

namespace	http://xml.ir-d.de/irdsaa		
type	restriction of string		
properties	base xs:string		
facets	Kind	Value	Annotation
	enumeration	0381001	documentation nein
	enumeration	0381002	documentation Thorakotomie/Rethorakotomie
	enumeration	0381003	documentation kathetergestützte Reintervention
	enumeration	0381004	documentation lokale Reinterventionen
	enumeration	0381005	documentation andere Reintervention
annotation	documentation Kat_AK_Massnahmen		
source	<pre> <simpleType name="enum_0381"> <annotation> <documentation>Kat_AK_Massnahmen</documentation> </annotation> <restriction base="xs:string"> <enumeration value="0381001"> <annotation> <documentation>nein</documentation> </annotation> </enumeration> <enumeration value="0381002"> <annotation> <documentation>Thorakotomie/Rethorakotomie</documentation> </annotation> </enumeration> <enumeration value="0381003"> <annotation> <documentation>kathetergestützte Reintervention</documentation> </annotation> </enumeration> <enumeration value="0381004"> <annotation> <documentation>lokale Reinterventionen</documentation> </annotation> </enumeration> <enumeration value="0381005"> <annotation> <documentation>andere Reintervention</documentation> </annotation> </enumeration> </restriction> </simpleType> </pre>		

simpleType enum_0382

namespace	http://xml.ir-d.de/irdsaa		
type	restriction of string		
properties	base xs:string		
facets	Kind	Value	Annotation
	enumeration	0382001	documentation keine Rethorakotomie / kein weiterer Grund
	enumeration	0382002	documentation Blutung/Hämatom
	enumeration	0382003	documentation Low Cardiac Output
	enumeration	0382004	documentation Tamponade
	enumeration	0382005	documentation Graftprobleme, Ischämie
	enumeration	0382006	documentation Wundinfektion, Mediastinitis
	enumeration	0382007	documentation Dissektion
	enumeration	0382008	documentation Prothesendysfunktion
	enumeration	0382009	documentation instabiles Sternum
	enumeration	0382010	documentation Chylothorax
	enumeration	0382011	documentation lokale Revision im Bereich des Zugangsweges
	enumeration	0382042	documentation anderer Grund
annotation	documentation Kat_AK_Komplikation		
source	<pre> <simpleType name="enum_0382"> <annotation> <documentation>Kat_AK_Komplikation</documentation> </annotation> <restriction base="xs:string"> <enumeration value="0382001"> <annotation> <documentation>keine Rethorakotomie / kein weiterer Grund</documentation> </annotation> </enumeration> <enumeration value="0382002"> <annotation> <documentation>Blutung/Hämatom</documentation> </annotation> </enumeration> <enumeration value="0382003"> <annotation> <documentation>Low Cardiac Output</documentation> </annotation> </enumeration> <enumeration value="0382004"> <annotation> <documentation>Tamponade</documentation> </annotation> </enumeration> <enumeration value="0382005"> </pre>		

```

<annotation>
  <documentation>Graftprobleme, Ischämie</documentation>
</annotation>
</enumeration>
<enumeration value="0382006">
  <annotation>
    <documentation>Wundinfektion, Mediastinitis</documentation>
  </annotation>
</enumeration>
<enumeration value="0382007">
  <annotation>
    <documentation>Dissektion</documentation>
  </annotation>
</enumeration>
<enumeration value="0382008">
  <annotation>
    <documentation>Prothesendysfunktion</documentation>
  </annotation>
</enumeration>
<enumeration value="0382009">
  <annotation>
    <documentation>instabiles Sternum</documentation>
  </annotation>
</enumeration>
<enumeration value="0382010">
  <annotation>
    <documentation>Chylothorax</documentation>
  </annotation>
</enumeration>
<enumeration value="0382011">
  <annotation>
    <documentation>lokale Revision im Bereich des
Zugangsweges</documentation>
  </annotation>
</enumeration>
<enumeration value="0382042">
  <annotation>
    <documentation>anderer Grund</documentation>
  </annotation>
</enumeration>
</restriction>
</simpleType>

```

simpleType enum_0383

namespace	http://xml.ir-d.de/irdsaa		
type	restriction of string		
properties	base xs:string		
facets	Kind	Value	Annotation
	enumeration	0383001	documentation nein
	enumeration	0383002	documentation ja, mit forcierter Atemtherapie
	enumeration	0383003	documentation ja, Reintubation oder längerfristige Beatmung
	enumeration	0383004	documentation ja, Tracheotomie

annotation	documentation Kat_AK_RespiratorischeInsuffizienz
source	<pre> <simpleType name="enum_0383"> <annotation> <documentation>Kat_AK_RespiratorischeInsuffizienz</documentation> </annotation> <restriction base="xs:string"> <enumeration value="0383001"> <annotation> <documentation>nein</documentation> </annotation> </enumeration> <enumeration value="0383002"> <annotation> <documentation>ja, mit forcierter Atemtherapie</documentation> </annotation> </enumeration> <enumeration value="0383003"> <annotation> <documentation>ja, Reintubation oder längerfristige Beatmung</documentation> </annotation> </enumeration> <enumeration value="0383004"> <annotation> <documentation>ja, Tracheotomie</documentation> </annotation> </enumeration> </restriction> </simpleType> </pre>

simpleType enum_0384

namespace	http://xml.ir-d.de/irdsaa		
type	restriction of string		
properties	base xs:string		
facets	Kind	Value	Annotation
	enumeration	0384001	documentation keine Blutungskomplikationen
	enumeration	0384002	documentation Geringfügige Blutung (Minor Bleeding - BARC type 2 or 3a)
	enumeration	0384003	documentation Starke Blutung (Major Bleeding - BARC type 3a)
	enumeration	0384004	documentation Lebensbedrohliche Blutung (Life-threatening or disabling bleeding - BARC type 3b or 3c or type 5)
annotation	documentation Kat_AK_Blutungskomplikation		
source	<pre> <simpleType name="enum_0384"> <annotation> <documentation>Kat_AK_Blutungskomplikation</documentation> </annotation> <restriction base="xs:string"> <enumeration value="0384001"> <annotation> <documentation>keine Blutungskomplikationen</documentation> </annotation> </pre>		

	<pre> </enumeration> <enumeration value="0384002"> <annotation> <documentation>Geringfügige Blutung (Minor Bleeding - BARC type 2 or 3a)</documentation> </annotation> </enumeration> <enumeration value="0384003"> <annotation> <documentation>Starke Blutung (Major Bleeding - BARC type 3a)</documentation> </annotation> </enumeration> <enumeration value="0384004"> <annotation> <documentation>Lebensbedrohliche Blutung (Life-threatening or disabling bleeding - BARC type 3b or 3c or type 5)</documentation> </annotation> </enumeration> </restriction> </simpleType> </pre>
--	--

simpleType enum_0385

namespace	http://xml.ir-d.de/irdsaa		
type	restriction of string		
properties	base xs:string		
facets	Kind	Value	Annotation
	enumeration	0385001	documentation Sinusrhythmus
	enumeration	0385002	documentation Vorhofflimmern
	enumeration	0385003	documentation Patient verstorben (kein Herzrhythmus)
	enumeration	0385042	documentation anderer Rhythmus
annotation	documentation Kat_AK_HerzrhythmusEntlassung		
source	<pre> <simpleType name="enum_0385"> <annotation> <documentation>Kat_AK_HerzrhythmusEntlassung</documentation> </annotation> <restriction base="xs:string"> <enumeration value="0385001"> <annotation> <documentation>Sinusrhythmus</documentation> </annotation> </enumeration> <enumeration value="0385002"> <annotation> <documentation>Vorhofflimmern</documentation> </annotation> </enumeration> <enumeration value="0385003"> <annotation> <documentation>Patient verstorben (kein Herzrhythmus)</documentation> </annotation> </enumeration> </restriction> </simpleType> </pre>		

	<pre> </enumeration> <enumeration value="0385042"> <annotation> <documentation>anderer Rhythmus</documentation> </annotation> </enumeration> </restriction> </simpleType> </pre>
--	--

simpleType enum_0388

namespace	http://xml.ir-d.de/irdsaa		
type	restriction of string		
properties	base xs:string		
facets	Kind	Value	Annotation
	enumeration	0388001	documentation nein
	enumeration	0388002	documentation ASS
	enumeration	0388003	documentation ADP-Rezeptor-Antagonist
	enumeration	0388004	documentation Kombination ASS und ADP-Rezeptor-Antagonist
	enumeration	0388042	documentation ja, andere
	enumeration	0388099	documentation unbekannt
annotation	documentation Kat_AK_Plaettchenaggregationshemmer		
source	<pre> <simpleType name="enum_0388"> <annotation> <documentation>Kat_AK_Plaettchenaggregationshemmer</documentation> </annotation> <restriction base="xs:string"> <enumeration value="0388001"> <annotation> <documentation>nein</documentation> </annotation> </enumeration> <enumeration value="0388002"> <annotation> <documentation>ASS</documentation> </annotation> </enumeration> <enumeration value="0388003"> <annotation> <documentation>ADP-Rezeptor-Antagonist</documentation> </annotation> </enumeration> <enumeration value="0388004"> <annotation> <documentation>Kombination ASS und ADP-Rezeptor- Antagonist</documentation> </annotation> </enumeration> <enumeration value="0388042"> <annotation> </pre>		

	<pre> <documentation>ja, andere</documentation> </annotation> </enumeration> <enumeration value="0388099"> <annotation> <documentation>unbekannt</documentation> </annotation> </enumeration> </restriction> </simpleType> </pre>
--	---

simpleType enum_0389

namespace	http://xml.ir-d.de/irdsaa		
type	restriction of string		
properties	base xs:string		
facets	Kind	Value	Annotation
	enumeration	0389001	documentation nein
	enumeration	0389002	documentation Cumarin-Derivate
	enumeration	0389003	documentation Heparinoide
	enumeration	0389004	documentation orale Thrombinantagonisten
	enumeration	0389006	documentation Direkte orale Antikoagulantien (DOAK / NOAK)
	enumeration	0389042	documentation ja, andere
	enumeration	0389099	documentation unbekannt
annotation	documentation Kat_AK_Antikoagulantien		
source	<pre> <simpleType name="enum_0389"> <annotation> <documentation>Kat_AK_Antikoagulantien</documentation> </annotation> <restriction base="xs:string"> <enumeration value="0389001"> <annotation> <documentation>nein</documentation> </annotation> </enumeration> <enumeration value="0389002"> <annotation> <documentation>Cumarin-Derivate</documentation> </annotation> </enumeration> <enumeration value="0389003"> <annotation> <documentation>Heparinoide</documentation> </annotation> </enumeration> <enumeration value="0389004"> <annotation> <documentation>orale Thrombinantagonisten</documentation> </annotation> </pre>		

	<pre> </enumeration> <enumeration value="0389006"> <annotation> <documentation>Direkte orale Antikoagulantien (DOAK / NOAK)</documentation> </annotation> </enumeration> <enumeration value="0389042"> <annotation> <documentation>ja, andere</documentation> </annotation> </enumeration> <enumeration value="0389099"> <annotation> <documentation>unbekannt</documentation> </annotation> </enumeration> </restriction> </simpleType> </pre>
--	---

simpleType enum_0390

namespace	http://xml.ir-d.de/irdsaa		
type	restriction of string		
properties	base xs:string		
facets	Kind	Value	Annotation
	enumeration	0390001	documentation biologisches Klappenmodell
	enumeration	0390002	documentation mechanisches Klappenmodell
annotation	documentation Kat_AK_Artikeltyp		
source	<pre> <simpleType name="enum_0390"> <annotation> <documentation>Kat_AK_Artikeltyp</documentation> </annotation> <restriction base="xs:string"> <enumeration value="0390001"> <annotation> <documentation>biologisches Klappenmodell</documentation> </annotation> </enumeration> <enumeration value="0390002"> <annotation> <documentation>mechanisches Klappenmodell</documentation> </annotation> </enumeration> </restriction> </simpleType> </pre>		

simpleType enum_0391

namespace	http://xml.ir-d.de/irdsaa
type	restriction of string

properties	base xs:string									
facets	<table border="1"> <thead> <tr> <th>Kind</th> <th>Value</th> <th>Annotation</th> </tr> </thead> <tbody> <tr> <td>enumeration</td> <td>0391001</td> <td>documentation chirurgische Klappe</td> </tr> <tr> <td>enumeration</td> <td>0391002</td> <td>documentation TAVI-Klappe</td> </tr> </tbody> </table>	Kind	Value	Annotation	enumeration	0391001	documentation chirurgische Klappe	enumeration	0391002	documentation TAVI-Klappe
Kind	Value	Annotation								
enumeration	0391001	documentation chirurgische Klappe								
enumeration	0391002	documentation TAVI-Klappe								
annotation	documentation Kat_AK_Klappentyp									
source	<pre> <simpleType name="enum_0391"> <annotation> <documentation>Kat_AK_Klappentyp</documentation> </annotation> <restriction base="xs:string"> <enumeration value="0391001"> <annotation> <documentation>chirurgische Klappe</documentation> </annotation> </enumeration> <enumeration value="0391002"> <annotation> <documentation>TAVI-Klappe</documentation> </annotation> </enumeration> </restriction> </simpleType> </pre>									

simpleType enum_0398

namespace	http://xml.ir-d.de/irdsaa												
type	restriction of string												
properties	base xs:string												
facets	<table border="1"> <thead> <tr> <th>Kind</th> <th>Value</th> <th>Annotation</th> </tr> </thead> <tbody> <tr> <td>enumeration</td> <td>0398001</td> <td>documentation kardiovaskuläre Ursache</td> </tr> <tr> <td>enumeration</td> <td>0398002</td> <td>documentation nicht-kardiovaskuläre Ursache</td> </tr> <tr> <td>enumeration</td> <td>0398099</td> <td>documentation Todesursache unbekannt</td> </tr> </tbody> </table>	Kind	Value	Annotation	enumeration	0398001	documentation kardiovaskuläre Ursache	enumeration	0398002	documentation nicht-kardiovaskuläre Ursache	enumeration	0398099	documentation Todesursache unbekannt
Kind	Value	Annotation											
enumeration	0398001	documentation kardiovaskuläre Ursache											
enumeration	0398002	documentation nicht-kardiovaskuläre Ursache											
enumeration	0398099	documentation Todesursache unbekannt											
annotation	documentation Kat_AK_Todesursache												
source	<pre> <simpleType name="enum_0398"> <annotation> <documentation>Kat_AK_Todesursache</documentation> </annotation> <restriction base="xs:string"> <enumeration value="0398001"> <annotation> <documentation>kardiovaskuläre Ursache</documentation> </annotation> </enumeration> <enumeration value="0398002"> <annotation> <documentation>nicht-kardiovaskuläre Ursache</documentation> </annotation> </enumeration> <enumeration value="0398099"> </pre>												

	<pre> <annotation> <documentation>Todesursache unbekannt</documentation> </annotation> </enumeration> </restriction> </simpleType> </pre>
--	---

simpleType enum_0399

namespace	http://xml.ir-d.de/irdsaa		
type	restriction of string		
properties	base xs:string		
facets	Kind	Value	Annotation
	enumeration	0399001	documentation Patient lebt
	enumeration	0399002	documentation Patient im Krankenhaus verstorben
annotation	documentation Kat_AK_Vitalstatus		
source	<pre> <simpleType name="enum_0399"> <annotation> <documentation>Kat_AK_Vitalstatus</documentation> </annotation> <restriction base="xs:string"> <enumeration value="0399001"> <annotation> <documentation>Patient lebt</documentation> </annotation> </enumeration> <enumeration value="0399002"> <annotation> <documentation>Patient im Krankenhaus verstorben</documentation> </annotation> </enumeration> </restriction> </simpleType> </pre>		

simpleType enum_0044

namespace	http://xml.ir-d.de/emg		
type	restriction of string		
properties	base xs:string		
used by	element	OperationBasis/OPE_AsaSchluessel	
facets	Kind	Value	Annotation
	enumeration	0044001	documentation 1= normaler, sonst gesunder Patient
	enumeration	0044002	documentation 2= Patient mit leichter Allgemeinerkrankung
	enumeration	0044003	documentation 3= Patient mit schwerer Allgemeinerkrankung
	enumeration	0044004	documentation 4= Patient mit schwerer Allgemeinerkrankung, die eine ständige Lebensbedrohung darstellt
	enumeration	0044005	documentation

	5= moribunder Patient, der ohne die Operation voraussichtlich nicht überleben wird
annotation	documentation Kat ASA
source	<pre> <simpleType name="enum_0044"> <annotation> <documentation>Kat_ASA</documentation> </annotation> <restriction base="xs:string"> <enumeration value="0044001"> <annotation> <documentation>1= normaler, sonst gesunder Patient</documentation> </annotation> </enumeration> <enumeration value="0044002"> <annotation> <documentation>2= Patient mit leichter Allgemeinerkrankung</documentation> </annotation> </enumeration> <enumeration value="0044003"> <annotation> <documentation>3= Patient mit schwerer Allgemeinerkrankung</documentation> </annotation> </enumeration> <enumeration value="0044004"> <annotation> <documentation>4= Patient mit schwerer Allgemeinerkrankung, die eine ständige Lebensbedrohung darstellt</documentation> </annotation> </enumeration> <enumeration value="0044005"> <annotation> <documentation>5= moribunder Patient, der ohne die Operation voraussichtlich nicht überleben wird</documentation> </annotation> </enumeration> </restriction> </simpleType> </pre>

simpleType enum_0050

namespace	http://xml.lir-d.de/emg		
type	restriction of string		
properties	base xs:string		
used by	element OperationBasis/OPE SeitenLokalisationSchluessel		
facets	Kind	Value	Annotation
	enumeration	0050001	documentation rechts
	enumeration	0050002	documentation links
annotation	documentation Kat_RechtsLinks		
source	<pre> <simpleType name="enum_0050"> <annotation> <documentation>Kat_RechtsLinks</documentation> </pre>		

	<pre> </annotation> <restriction base="xs:string"> <enumeration value="0050001"> <annotation> <documentation>rechts</documentation> </annotation> </enumeration> <enumeration value="0050002"> <annotation> <documentation>links</documentation> </annotation> </enumeration> </restriction> </simpleType> </pre>
--	---

simpleType enum_0060

namespace	http://xml.lir-d.de/emg		
type	restriction of string		
properties	base xs:string		
used by	elements	ArtikelidentifikationBasis/ARI_SonderstatusJNSchluessel OperationAortenklappeBasis/OAK_AortaThorakalSchluessel OperationAortenklappeBasis/OAK_BeatmungSchluessel OperationAortenklappeBasis/OAK_ExplantationSchluessel OperationAortenklappeBasis/OAK_InotropeSchluessel OperationAortenklappeBasis/OAK_IntraOpUnterstuetzungSchluessel OperationAortenklappeBasis/OAK_IsoliertSchluessel OperationAortenklappeBasis/OAK_KomplikationenSchluessel OperationAortenklappeBasis/OAK_KreislaufunterstuetzungSchluessel OperationAortenklappeBasis/OAK_NeuroprotektionSchluessel OperationAortenklappeBasis/OAK_PciWegenKhkSchluessel OperationAortenklappeBasis/OAK_PciWegenKomplikationSchluessel OperationAortenklappeBasis/OAK_PraeOpUnterstuetzungSchluessel OperationAortenklappeBasis/OAK_PtcaNachSchluessel OperationAortenklappeBasis/OAK_PtcaVorSchluessel OperationAortenklappeBasis/OAK_RapidPacingIntraSchluessel OperationAortenklappeBasis/OAK_RapidPacingNachSchluessel OperationAortenklappeBasis/OAK_RapidPacingVorSchluessel OperationAortenklappeBasis/OAK_SuccessSchluessel OperationAortenklappeBasis/OAK_TroponinSchluessel OperationAortenklappeBasis/OAK_ValveInValveSchluessel OperationAortenklappeBasis/OAK_ZusaetzlichePciSchluessel OperationEndoprotheseBasis/OEP_EndocertJNSchluessel OperationEndoprotheseBasis/OEP_FrakturJNSchluessel PostoperationAortenklappeBasis/POA_AvBlockSchluessel PostoperationAortenklappeBasis/POA_EndokarditisSchluessel PostoperationAortenklappeBasis/POA_IntraOpVerstorbenSchluessel PostoperationAortenklappeBasis/POA_NierenersatzSchluessel PostoperationAortenklappeBasis/POA_SepsisSchluessel PostoperationAortenklappeBasis/POA_VorhofflimmernSchluessel	
facets	Kind	Value	Annotation
	enumeration	0060001	documentation ja
	enumeration	0060002	documentation nein
annotation	documentation Kat_JaNein		
source	<pre> <simpleType name="enum_0060"> <annotation> </pre>		

	<pre> <documentation>Kat_JaNein</documentation> </annotation> <restriction base="xs:string"> <enumeration value="0060001"> <annotation> <documentation>ja</documentation> </annotation> </enumeration> <enumeration value="0060002"> <annotation> <documentation>nein</documentation> </annotation> </enumeration> </restriction> </simpleType> </pre>
--	--

simpleType enum 0061

namespace	http://xml.ir-d.de/emg		
type	restriction of string		
properties	base xs:string		
used by	elements	OperationAortenklappeBasis/OAK ZugangVerkalkungSchluessel PatientenaufnahmeAortenklappeBasis/PAA AortenaneurysmaSchluessel PatientenaufnahmeAortenklappeBasis/PAA ArteriaCarotisSchluessel PatientenaufnahmeAortenklappeBasis/PAA AvkSchluessel PatientenaufnahmeAortenklappeBasis/PAA HypertonusSchluessel PatientenaufnahmeAortenklappeBasis/PAA PAVkSchluessel PatientenaufnahmeAortenklappeBasis/PAA SonstigeAvkSchluessel PatientenaufnahmeAortenklappeBasis/PAA ValvuloplastieSchluessel	
facets	Kind	Value	Annotation
	enumeration	0061001	documentation ja
	enumeration	0061002	documentation nein
	enumeration	0061099	documentation unbekannt
annotation	documentation Kat_JaNeinUnbekannt		
source	<pre> <simpleType name="enum_0061"> <annotation> <documentation>Kat_JaNeinUnbekannt</documentation> </annotation> <restriction base="xs:string"> <enumeration value="0061001"> <annotation> <documentation>ja</documentation> </annotation> </enumeration> <enumeration value="0061002"> <annotation> <documentation>nein</documentation> </annotation> </enumeration> <enumeration value="0061099"> <annotation> <documentation>unbekannt</documentation> </annotation> </enumeration> </restriction> </simpleType> </pre>		

	<pre> </enumeration> </restriction> </simpleType> </pre>
--	--

simpleType enum_0062

namespace	http://xml.ir-d.de/emg		
type	restriction of string		
properties	base xs:string		
used by	element ArtikelEndoprotheseBasis/AEP EinheitSchluessel		
facets	Kind	Value	Annotation
	enumeration	0062001	documentation Stück
	enumeration	0062002	documentation g
	enumeration	0062003	documentation mg
	enumeration	0062004	documentation l
	enumeration	0062005	documentation ml
	enumeration	0062006	documentation cm ³
	enumeration	0062007	documentation mm
	enumeration	0062008	documentation cm
	enumeration	0062009	documentation dm
	enumeration	0062010	documentation m
	enumeration	0062042	documentation andere
annotation	documentation Kat_Einheit		
source	<pre> <simpleType name="enum_0062"> <annotation> <documentation>Kat_Einheit</documentation> </annotation> <restriction base="xs:string"> <enumeration value="0062001"> <annotation> <documentation>Stück</documentation> </annotation> </enumeration> <enumeration value="0062002"> <annotation> <documentation>g</documentation> </annotation> </enumeration> <enumeration value="0062003"> <annotation> <documentation>mg</documentation> </annotation> </enumeration> <enumeration value="0062004"> <annotation> <documentation>l</documentation> </pre>		

```

</annotation>
</enumeration>
<enumeration value="0062005">
  <annotation>
    <documentation>ml</documentation>
  </annotation>
</enumeration>
<enumeration value="0062006">
  <annotation>
    <documentation>cm3</documentation>
  </annotation>
</enumeration>
<enumeration value="0062007">
  <annotation>
    <documentation>mm</documentation>
  </annotation>
</enumeration>
<enumeration value="0062008">
  <annotation>
    <documentation>cm</documentation>
  </annotation>
</enumeration>
<enumeration value="0062009">
  <annotation>
    <documentation>dm</documentation>
  </annotation>
</enumeration>
<enumeration value="0062010">
  <annotation>
    <documentation>m</documentation>
  </annotation>
</enumeration>
<enumeration value="0062042">
  <annotation>
    <documentation>andere</documentation>
  </annotation>
</enumeration>
</restriction>
</simpleType>

```

simpleType enum 0065

namespace	http://xml.ir-d.de/emg		
type	restriction of string		
properties	base xs:string		
used by	element FallBasis/FAL ArtAufenthaltSchluessel		
facets	Kind	Value	Annotation
	enumeration	0065001	documentation stationär
	enumeration	0065002	documentation teilstationär
	enumeration	0065003	documentation ambulant
annotation	documentation Kat_ArtAufenthalt		
source	<simpleType name="enum_0065">		

	<pre> <annotation> <documentation>Kat_ArtAufenthalt</documentation> </annotation> <restriction base="xs:string"> <enumeration value="0065001"> <annotation> <documentation>stationär</documentation> </annotation> </enumeration> <enumeration value="0065002"> <annotation> <documentation>teilstationär</documentation> </annotation> </enumeration> <enumeration value="0065003"> <annotation> <documentation>ambulant</documentation> </annotation> </enumeration> </restriction> </simpleType> </pre>
--	--

simpleType enum_0067

namespace	http://xml.ir-d.de/emg		
type	restriction of string		
properties	base xs:string		
used by	element ArtikelidentifikationBasis/ARI ArtikelArtSchluessel		
facets	Kind	Value	Annotation
	enumeration	0067001	documentation Implantat
	enumeration	0067002	documentation Explantat
annotation	documentation Kat_ArtArtikel		
source	<pre> <simpleType name="enum_0067"> <annotation> <documentation>Kat_ArtArtikel</documentation> </annotation> <restriction base="xs:string"> <enumeration value="0067001"> <annotation> <documentation>Implantat</documentation> </annotation> </enumeration> <enumeration value="0067002"> <annotation> <documentation>Explantat</documentation> </annotation> </enumeration> </restriction> </simpleType> </pre>		

simpleType enum_0068

namespace	http://xml.ir-d.de/emg		
type	restriction of string		
properties	base xs:string		
used by	element ArtikelidentifikationBasis/ARI KennzeichenTypSchluessel		
facets	Kind	Value	Annotation
	enumeration	0068001	documentation UDI
	enumeration	0068002	documentation Referenz (REF)
annotation	documentation Kat_KennzeichenTyp		
source	<pre> <simpleType name="enum_0068"> <annotation> <documentation>Kat_KennzeichenTyp</documentation> </annotation> <restriction base="xs:string"> <enumeration value="0068001"> <annotation> <documentation>UDI</documentation> </annotation> </enumeration> <enumeration value="0068002"> <annotation> <documentation>Referenz (REF)</documentation> </annotation> </enumeration> </restriction> </simpleType> </pre>		

simpleType enum_0069

namespace	http://xml.ir-d.de/emg		
type	restriction of string		
properties	base xs:string		
used by	element ZubehoerBasis/ZUB ZubehoerArtSchluessel		
facets	Kind	Value	Annotation
	enumeration	0069001	documentation Implantat
	enumeration	0069002	documentation Explantat
annotation	documentation Kat ArtZubehoer		
source	<pre> <simpleType name="enum_0069"> <annotation> <documentation>Kat_ArtZubehoer</documentation> </annotation> <restriction base="xs:string"> <enumeration value="0069001"> <annotation> <documentation>Implantat</documentation> </annotation> </enumeration> <enumeration value="0069002"> </pre>		

	<pre> <annotation> <documentation>Explantat</documentation> </annotation> </enumeration> </restriction> </simpleType> </pre>
--	--

simpleType enum_0070

namespace	http://xml.ir-d.de/emg		
type	restriction of string		
properties	base xs:string		
used by	element PatientenaufnahmeBasis/PAT GeschlechtSchlüssel		
facets	Kind	Value	Annotation
	enumeration	0070001	documentation weiblich
	enumeration	0070002	documentation männlich
	enumeration	0070003	documentation divers
	enumeration	0070042	documentation unbestimmt
annotation	documentation Kat_Geschlecht		
source	<pre> <simpleType name="enum_0070"> <annotation> <documentation>Kat_Geschlecht</documentation> </annotation> <restriction base="xs:string"> <enumeration value="0070001"> <annotation> <documentation>weiblich</documentation> </annotation> </enumeration> <enumeration value="0070002"> <annotation> <documentation>männlich</documentation> </annotation> </enumeration> <enumeration value="0070003"> <annotation> <documentation>divers</documentation> </annotation> </enumeration> <enumeration value="0070042"> <annotation> <documentation>unbestimmt</documentation> </annotation> </enumeration> </restriction> </simpleType> </pre>		

simpleType enum_0071

namespace	http://xml.ir-d.de/emg
-----------	------------------------

type	restriction of string												
properties	base xs:string												
used by	element ArtikelidentifikationBasis/ARI ArtikelArtFunktionSchluessel												
facets	<table border="1"> <thead> <tr> <th>Kind</th> <th>Value</th> <th>Annotation</th> </tr> </thead> <tbody> <tr> <td>enumeration</td> <td>0071001</td> <td>documentation Implantat</td> </tr> <tr> <td>enumeration</td> <td>0071002</td> <td>documentation Explantat</td> </tr> <tr> <td>enumeration</td> <td>0071003</td> <td>documentation Degeneriertes/defektes Produkt, das funktionslos im Körper verbleibt</td> </tr> </tbody> </table>	Kind	Value	Annotation	enumeration	0071001	documentation Implantat	enumeration	0071002	documentation Explantat	enumeration	0071003	documentation Degeneriertes/defektes Produkt, das funktionslos im Körper verbleibt
Kind	Value	Annotation											
enumeration	0071001	documentation Implantat											
enumeration	0071002	documentation Explantat											
enumeration	0071003	documentation Degeneriertes/defektes Produkt, das funktionslos im Körper verbleibt											
annotation	documentation Kat_ArtikelArtFunktion												
source	<pre> <simpleType name="enum_0071"> <annotation> <documentation>Kat_ArtikelArtFunktion</documentation> </annotation> <restriction base="xs:string"> <enumeration value="0071001"> <annotation> <documentation>Implantat</documentation> </annotation> </enumeration> <enumeration value="0071002"> <annotation> <documentation>Explantat</documentation> </annotation> </enumeration> <enumeration value="0071003"> <annotation> <documentation>Degeneriertes/defektes Produkt, das funktionslos im Körper verbleibt</documentation> </annotation> </enumeration> </restriction> </simpleType> </pre>												

simpleType **enum_0075**

namespace	http://xml.ir-d.de/emg												
type	restriction of string												
properties	base xs:string												
used by	element OperationEndoprotheseBasis/OEP DringlichkeitSchluessel												
facets	<table border="1"> <thead> <tr> <th>Kind</th> <th>Value</th> <th>Annotation</th> </tr> </thead> <tbody> <tr> <td>enumeration</td> <td>0075001</td> <td>documentation elektiv</td> </tr> <tr> <td>enumeration</td> <td>0075002</td> <td>documentation dringlich</td> </tr> <tr> <td>enumeration</td> <td>0075003</td> <td>documentation Notfall</td> </tr> </tbody> </table>	Kind	Value	Annotation	enumeration	0075001	documentation elektiv	enumeration	0075002	documentation dringlich	enumeration	0075003	documentation Notfall
Kind	Value	Annotation											
enumeration	0075001	documentation elektiv											
enumeration	0075002	documentation dringlich											
enumeration	0075003	documentation Notfall											
annotation	documentation Kat_Dringlichkeit												
source	<pre> <simpleType name="enum_0075"> <annotation> <documentation>Kat_Dringlichkeit</documentation> </annotation> </pre>												

	<pre> <restriction base="xs:string"> <enumeration value="0075001"> <annotation> <documentation>elektiv</documentation> </annotation> </enumeration> <enumeration value="0075002"> <annotation> <documentation>dringlich</documentation> </annotation> </enumeration> <enumeration value="0075003"> <annotation> <documentation>Notfall</documentation> </annotation> </enumeration> </restriction> </simpleType> </pre>
--	---

simpleType enum_0076

namespace	http://xml.ir-d.de/emg		
type	restriction of string		
properties	base xs:string		
used by	element OperationAortenklappeBasis/OAK DringlichkeitSchlüssel		
facets	Kind	Value	Annotation
	enumeration	0076001	documentation elektiv
	enumeration	0076002	documentation dringlich
	enumeration	0076003	documentation Notfall
	enumeration	0076004	documentation Notfall (Reanimation / ultima ratio)
annotation	documentation Kat_Dringlichkeit_Reanimation		
source	<pre> <simpleType name="enum_0076"> <annotation> <documentation>Kat_Dringlichkeit_Reanimation</documentation> </annotation> <restriction base="xs:string"> <enumeration value="0076001"> <annotation> <documentation>elektiv</documentation> </annotation> </enumeration> <enumeration value="0076002"> <annotation> <documentation>dringlich</documentation> </annotation> </enumeration> <enumeration value="0076003"> <annotation> <documentation>Notfall</documentation> </annotation> </enumeration> </restriction> </pre>		

	<pre> <enumeration value="0076004"> <annotation> <documentation>Notfall (Reanimation / ultima ratio)</documentation> </annotation> </enumeration> </restriction> </simpleType> </pre>
--	---

simpleType enum_0080

namespace	http://xml.ir-d.de/emg		
type	restriction of string		
properties	base xs:string		
used by	element OperationBasis/OPE ImplantattypSchluessel		
facets	Kind	Value	Annotation
	enumeration	0080001	documentation Endoprothese Hüfte/Knie
	enumeration	0080002	documentation Brustimplantat
	enumeration	0080003	documentation Aortenklappenprothese
annotation	documentation Kat_Implantattyp		
source	<pre> <simpleType name="enum_0080"> <annotation> <documentation>Kat_Implantattyp</documentation> </annotation> <restriction base="xs:string"> <enumeration value="0080001"> <annotation> <documentation>Endoprothese Hüfte/Knie</documentation> </annotation> </enumeration> <enumeration value="0080002"> <annotation> <documentation>Brustimplantat</documentation> </annotation> </enumeration> <enumeration value="0080003"> <annotation> <documentation>Aortenklappenprothese</documentation> </annotation> </enumeration> </restriction> </simpleType> </pre>		

simpleType enum_0100

namespace	http://xml.ir-d.de/emg		
type	restriction of string		
properties	base xs:string		
used by	element OperationBrustimplantatBasis/OBI ArtEingriffSchluessel		

facets	<table border="1"> <thead> <tr> <th>Kind</th> <th>Value</th> <th>Annotation</th> </tr> </thead> <tbody> <tr> <td>enumeration</td> <td>0100002</td> <td>documentation Austausch Expander gegen dauerhaftes Brustimplantat</td> </tr> <tr> <td>enumeration</td> <td>0100003</td> <td>documentation Wechsel</td> </tr> <tr> <td>enumeration</td> <td>0100004</td> <td>documentation Nur Explantation</td> </tr> <tr> <td>enumeration</td> <td>0100005</td> <td>documentation Ersteingriff</td> </tr> <tr> <td>enumeration</td> <td>0100006</td> <td>documentation Zweizeitige Implantation</td> </tr> </tbody> </table>	Kind	Value	Annotation	enumeration	0100002	documentation Austausch Expander gegen dauerhaftes Brustimplantat	enumeration	0100003	documentation Wechsel	enumeration	0100004	documentation Nur Explantation	enumeration	0100005	documentation Ersteingriff	enumeration	0100006	documentation Zweizeitige Implantation
Kind	Value	Annotation																	
enumeration	0100002	documentation Austausch Expander gegen dauerhaftes Brustimplantat																	
enumeration	0100003	documentation Wechsel																	
enumeration	0100004	documentation Nur Explantation																	
enumeration	0100005	documentation Ersteingriff																	
enumeration	0100006	documentation Zweizeitige Implantation																	
annotation	documentation Kat_BI_ArtEingriff																		
source	<pre> <simpleType name="enum_0100"> <annotation> <documentation>Kat_BI_ArtEingriff</documentation> </annotation> <restriction base="xs:string"> <enumeration value="0100002"> <annotation> <documentation>Austausch Expander gegen dauerhaftes Brustimplantat</documentation> </annotation> </enumeration> <enumeration value="0100003"> <annotation> <documentation>Wechsel</documentation> </annotation> </enumeration> <enumeration value="0100004"> <annotation> <documentation>Nur Explantation</documentation> </annotation> </enumeration> <enumeration value="0100005"> <annotation> <documentation>Ersteingriff</documentation> </annotation> </enumeration> <enumeration value="0100006"> <annotation> <documentation>Zweizeitige Implantation</documentation> </annotation> </enumeration> </restriction> </simpleType> </pre>																		

simpleType enum_0102

namespace	http://xml.ir-d.de/emg									
type	restriction of string									
properties	base xs:string									
used by	element OperationBrustimplantatBasis/OBI GrundPrimaerEingriffSchluessel									
facets	<table border="1"> <thead> <tr> <th>Kind</th> <th>Value</th> <th>Annotation</th> </tr> </thead> <tbody> <tr> <td>enumeration</td> <td>0102001</td> <td>documentation kosmetische Augmentation</td> </tr> <tr> <td>enumeration</td> <td>0102002</td> <td>documentation</td> </tr> </tbody> </table>	Kind	Value	Annotation	enumeration	0102001	documentation kosmetische Augmentation	enumeration	0102002	documentation
Kind	Value	Annotation								
enumeration	0102001	documentation kosmetische Augmentation								
enumeration	0102002	documentation								

	enumeration 0102003 enumeration 0102004	Rekonstruktion, benigne documentation Rekonstruktion nach Mastektomie aufgrund eines Karzinoms documentation Rekonstruktion nach risikoreduzierender Mastektomie
annotation	documentation Kat_BI_GrundPrimaereingriff	
source	<pre> <simpleType name="enum_0102"> <annotation> <documentation>Kat_BI_GrundPrimaereingriff</documentation> </annotation> <restriction base="xs:string"> <enumeration value="0102001"> <annotation> <documentation>kosmetische Augmentation</documentation> </annotation> </enumeration> <enumeration value="0102002"> <annotation> <documentation>Rekonstruktion, benigne</documentation> </annotation> </enumeration> <enumeration value="0102003"> <annotation> <documentation>Rekonstruktion nach Mastektomie aufgrund eines Karzinoms</documentation> </annotation> </enumeration> <enumeration value="0102004"> <annotation> <documentation>Rekonstruktion nach risikoreduzierender Mastektomie</documentation> </annotation> </enumeration> </restriction> </simpleType> </pre>	

simpleType enum_0103

namespace	http://xml.ir-d.de/emg		
type	restriction of string		
properties	base xs:string		
used by	element OperationsdetailBrustimplantatBasis/ODB OperationsdetailPrimaer EingriffSchluessel		
facets	Kind	Value	Annotation
	enumeration	0103001	documentation simultane Lappendeckung
	enumeration	0103002	documentation simultane Eigenfettransplantation
	enumeration	0103003	documentation simultane Mastopexie
	enumeration	0103005	documentation simultane Mastektomie, Ablatio / hautsparend
	enumeration	0103006	documentation simultane Mastektomie, nippelerhaltend
	enumeration	0103007	documentation Axilla-Dissektion
	enumeration	0103008	documentation

	Drainage
annotation	documentation Kat BI_OperationsdetailPrimaereingriff
source	<pre> <simpleType name="enum_0103"> <annotation> <documentation>Kat BI_OperationsdetailPrimaereingriff</documentation> </annotation> <restriction base="xs:string"> <enumeration value="0103001"> <annotation> <documentation>simultane Lappendeckung</documentation> </annotation> </enumeration> <enumeration value="0103002"> <annotation> <documentation>simultane Eigenfetttransplantation</documentation> </annotation> </enumeration> <enumeration value="0103003"> <annotation> <documentation>simultane Mastopexie</documentation> </annotation> </enumeration> <enumeration value="0103005"> <annotation> <documentation>simultane Mastektomie, Ablatio / hautsparend</documentation> </annotation> </enumeration> <enumeration value="0103006"> <annotation> <documentation>simultane Mastektomie, nippelerhaltend</documentation> </annotation> </enumeration> <enumeration value="0103007"> <annotation> <documentation>Axilla-Dissektion</documentation> </annotation> </enumeration> <enumeration value="0103008"> <annotation> <documentation>Drainage</documentation> </annotation> </enumeration> </restriction> </simpleType> </pre>

simpleType enum_0104

namespace	http://xml.ir-d.de/emg		
type	restriction of string		
properties	base xs:string		
used by	element	OperationBrustimplantatBasis/OBI GrundAustauschSchluessel	
facets	Kind	Value	Annotation
	enumeration	0104001	documentation Austausch Expander gegen dauerhaftes Brustimplantat

annotation	documentation Kat_BI_GrundAustausch
source	<pre> <simpleType name="enum_0104"> <annotation> <documentation>Kat_BI_GrundAustausch</documentation> </annotation> <restriction base="xs:string"> <enumeration value="0104001"> <annotation> <documentation>Austausch Expander gegen dauerhaftes Brustimplantat</documentation> </annotation> </enumeration> </restriction> </simpleType> </pre>

simpleType enum_0105

namespace	http://xml.ir-d.de/emg		
type	restriction of string		
properties	base xs:string		
used by	element OperationsdetailBrustimplantatBasis/ODB OperationsdetailAustauschSchluessel		
facets	Kind	Value	Annotation
	enumeration	0105001	documentation simultane Lappendeckung
	enumeration	0105002	documentation simultane Eigenfetttransplantation
	enumeration	0105003	documentation simultane Mastopexie
	enumeration	0105008	documentation Drainage
	enumeration	0105009	documentation Kapsulektomie, komplett
	enumeration	0105010	documentation Kapsulektomie, partiell
	enumeration	0105011	documentation Neopocket
annotation	documentation Kat_BI_OperationsdetailAustausch		
source	<pre> <simpleType name="enum_0105"> <annotation> <documentation>Kat_BI_OperationsdetailAustausch</documentation> </annotation> <restriction base="xs:string"> <enumeration value="0105001"> <annotation> <documentation>simultane Lappendeckung</documentation> </annotation> </enumeration> <enumeration value="0105002"> <annotation> <documentation>simultane Eigenfetttransplantation</documentation> </annotation> </enumeration> <enumeration value="0105003"> <annotation> <documentation>simultane Mastopexie</documentation> </annotation> </enumeration> </restriction> </simpleType> </pre>		

	<pre> </annotation> </enumeration> <enumeration value="0105008"> <annotation> <documentation>Drainage</documentation> </annotation> </enumeration> <enumeration value="0105009"> <annotation> <documentation>Kapsulektomie, komplett</documentation> </annotation> </enumeration> <enumeration value="0105010"> <annotation> <documentation>Kapsulektomie, partiell</documentation> </annotation> </enumeration> <enumeration value="0105011"> <annotation> <documentation>Neopocket</documentation> </annotation> </enumeration> </restriction> </simpleType> </pre>
--	---

simpleType enum_0106

namespace	http://xml.ir-d.de/emg		
type	restriction of string		
properties	base xs:string		
used by	element OperationBrustimplantatBasis/OBI GrundRevisionExplantationSchluessel		
facets	Kind	Value	Annotation
	enumeration	0106001	documentation Patientenwunsch
	enumeration	0106002	documentation asymptomatisch
	enumeration	0106003	documentation Komplikation
annotation	documentation Kat_BI_GrundRevisionExplantation		
source	<pre> <simpleType name="enum_0106"> <annotation> <documentation>Kat_BI_GrundRevisionExplantation</documentation> </annotation> <restriction base="xs:string"> <enumeration value="0106001"> <annotation> <documentation>Patientenwunsch</documentation> </annotation> </enumeration> <enumeration value="0106002"> <annotation> <documentation>asymptomatisch</documentation> </annotation> </enumeration> <enumeration value="0106003"> </pre>		

	<pre> <annotation> <documentation>Komplikation</documentation> </annotation> </enumeration> </restriction> </simpleType> </pre>
--	---

simpleType enum_0107

namespace	http://xml.ir-d.de/emg		
type	restriction of string		
properties	base xs:string		
used by	element OperationsdetailBrustimplantatBasis/ODB OperationsdetailRevisionSchluessel		
facets	Kind	Value	Annotation
	enumeration	0107001	documentation simultane Lappendeckung
	enumeration	0107002	documentation simultane Eigenfetttransplantation
	enumeration	0107003	documentation simultane Mastopexie
	enumeration	0107005	documentation simultane Mastektomie, Ablatio / hautsparend
	enumeration	0107006	documentation simultane Mastektomie, nippelerhaltend
	enumeration	0107007	documentation Axilla-Dissektion
	enumeration	0107008	documentation Drainage
	enumeration	0107009	documentation Kapsulektomie, komplett
	enumeration	0107010	documentation Kapsulektomie, partiell
	enumeration	0107011	documentation Neopocket
annotation	documentation Kat_BI_OperationsdetailRevision		
source	<pre> <simpleType name="enum_0107"> <annotation> <documentation>Kat_BI_OperationsdetailRevision</documentation> </annotation> <restriction base="xs:string"> <enumeration value="0107001"> <annotation> <documentation>simultane Lappendeckung</documentation> </annotation> </enumeration> <enumeration value="0107002"> <annotation> <documentation>simultane Eigenfetttransplantation</documentation> </annotation> </enumeration> <enumeration value="0107003"> <annotation> <documentation>simultane Mastopexie</documentation> </annotation> </enumeration> <enumeration value="0107005"> </pre>		

	<pre> <annotation> <documentation>simultane Mastektomie, Ablatio / hautsparend</documentation> </annotation> </enumeration> <enumeration value="0107006"> <annotation> <documentation>simultane Mastektomie, nippelerhaltend</documentation> </annotation> </enumeration> <enumeration value="0107007"> <annotation> <documentation>Axilla-Dissektion</documentation> </annotation> </enumeration> <enumeration value="0107008"> <annotation> <documentation>Drainage</documentation> </annotation> </enumeration> <enumeration value="0107009"> <annotation> <documentation>Kapsulektomie, komplett</documentation> </annotation> </enumeration> <enumeration value="0107010"> <annotation> <documentation>Kapsulektomie, partiell</documentation> </annotation> </enumeration> <enumeration value="0107011"> <annotation> <documentation>Neopocket</documentation> </annotation> </enumeration> </restriction> </simpleType> </pre>
--	---

simpleType enum 0110

namespace	http://xml.ir-d.de/emg		
type	restriction of string		
properties	base xs:string		
used by	element VorbereitungBrustimplantatBasis/VBI BehandlungLokalSchlüssel		
facets	Kind	Value	Annotation
	enumeration	0110001	documentation Bestrahlung
annotation	documentation Kat_BI_VorbereitungLokal		
source	<pre> <simpleType name="enum_0110"> <annotation> <documentation>Kat_BI_VorbereitungLokal</documentation> </annotation> <restriction base="xs:string"> <enumeration value="0110001"> <annotation> </pre>		

	<pre> <documentation>Bestrahlung</documentation> </annotation> </enumeration> </restriction> </simpleType> </pre>
--	---

simpleType enum_0111

namespace	http://xml.ir-d.de/emg		
type	restriction of string		
properties	base xs:string		
used by	element	OperationBrustimplantatBasis/OBI VerfahrenswechselSchluessel	
facets	Kind	Value	Annotation
	enumeration	0111001	documentation nein
	enumeration	0111002	documentation Lipofilling
	enumeration	0111003	documentation Eigengewebsrekonstruktion
annotation	documentation Kat_BI_Verfahrenswechsel		
source	<pre> <simpleType name="enum_0111"> <annotation> <documentation>Kat_BI_Verfahrenswechsel</documentation> </annotation> <restriction base="xs:string"> <enumeration value="0111001"> <annotation> <documentation>nein</documentation> </annotation> </enumeration> <enumeration value="0111002"> <annotation> <documentation>Lipofilling</documentation> </annotation> </enumeration> <enumeration value="0111003"> <annotation> <documentation>Eigengewebsrekonstruktion</documentation> </annotation> </enumeration> </restriction> </simpleType> </pre>		

simpleType enum_0112

namespace	http://xml.ir-d.de/emg		
type	restriction of string		
properties	base xs:string		
used by	element	OperationBrustimplantatBasis/OBI LageSchluessel	
facets	Kind	Value	Annotation
	enumeration	0112001	documentation subglandulär / epipektoral

	enumeration 0112002 documentation subpektoral enumeration 0112003 documentation subfaszial enumeration 0112004 documentation sub-flap enumeration 0112005 documentation subkutan enumeration 0112006 documentation dual plane enumeration 0112042 documentation andere
annotation	documentation Kat_BI_LageImplantat
source	<pre> <simpleType name="enum_0112"> <annotation> <documentation>Kat_BI_LageImplantat</documentation> </annotation> <restriction base="xs:string"> <enumeration value="0112001"> <annotation> <documentation>subglandulär / epipektoral</documentation> </annotation> </enumeration> <enumeration value="0112002"> <annotation> <documentation>subpektoral</documentation> </annotation> </enumeration> <enumeration value="0112003"> <annotation> <documentation>subfaszial</documentation> </annotation> </enumeration> <enumeration value="0112004"> <annotation> <documentation>sub-flap</documentation> </annotation> </enumeration> <enumeration value="0112005"> <annotation> <documentation>subkutan</documentation> </annotation> </enumeration> <enumeration value="0112006"> <annotation> <documentation>dual plane</documentation> </annotation> </enumeration> <enumeration value="0112042"> <annotation> <documentation>andere</documentation> </annotation> </enumeration> </restriction> </simpleType> </pre>

simpleType enum_0113

namespace	http://xml.ir-d.de/emg		
type	restriction of string		
properties	base xs:string		
used by	element VorbereitungBrustimplantatBasis/VBI BehandlungSystemischSchlüssel		
facets	Kind	Value	Annotation
	enumeration	0113001	documentation Chemotherapie innerhalb der letzten drei Monate
annotation	documentation Kat_BI_VorbereitungSystemisch		
source	<pre> <simpleType name="enum_0113"> <annotation> <documentation>Kat_BI_VorbereitungSystemisch</documentation> </annotation> <restriction base="xs:string"> <enumeration value="0113001"> <annotation> <documentation>Chemotherapie innerhalb der letzten drei Monate</documentation> </annotation> </enumeration> </restriction> </simpleType> </pre>		

simpleType enum_0114

namespace	http://xml.ir-d.de/emg		
type	restriction of string		
properties	base xs:string		
used by	element OperationBrustimplantatBasis/OBI EntfernungAdmNetzSchlüssel		
facets	Kind	Value	Annotation
	enumeration	0114001	documentation vollständig
	enumeration	0114002	documentation nein
	enumeration	0114003	documentation teilweise
	enumeration	0114004	documentation nicht vorhanden
annotation	documentation Kat_BI_EntfernungADMNetz		
source	<pre> <simpleType name="enum_0114"> <annotation> <documentation>Kat_BI_EntfernungADMNetz</documentation> </annotation> <restriction base="xs:string"> <enumeration value="0114001"> <annotation> <documentation>vollständig</documentation> </annotation> </enumeration> <enumeration value="0114002"> <annotation> <documentation>nein</documentation> </annotation> </enumeration> </restriction> </simpleType> </pre>		

	<pre> </annotation> </enumeration> <enumeration value="0114003"> <annotation> <documentation>teilweise</documentation> </annotation> </enumeration> <enumeration value="0114004"> <annotation> <documentation>nicht vorhanden</documentation> </annotation> </enumeration> </restriction> </simpleType> </pre>
--	--

simpleType enum_0116

namespace	http://xml.ir-d.de/emg		
type	restriction of string		
properties	base xs:string		
used by	element MassnahmeBrustimplantatBasis/MAB MassnahmeSchluessel		
facets	Kind	Value	Annotation
	enumeration	0116001	documentation Spülung, antibiotisch
	enumeration	0116002	documentation Spülung, antiseptisch
	enumeration	0116003	documentation Spülung, wirkstofffrei
	enumeration	0116004	documentation Spülung, andere
	enumeration	0116005	documentation prä-/perioperative Antibiotika
	enumeration	0116006	documentation postoperative Antibiotika
	enumeration	0116007	documentation Handschuhwechsel vor Implantation
	enumeration	0116008	documentation Implantationshilfe
annotation	documentation Kat_BI_Operationsmassnahme		
source	<pre> <simpleType name="enum_0116"> <annotation> <documentation>Kat_BI_Operationsmassnahme</documentation> </annotation> <restriction base="xs:string"> <enumeration value="0116001"> <annotation> <documentation>Spülung, antibiotisch</documentation> </annotation> </enumeration> <enumeration value="0116002"> <annotation> <documentation>Spülung, antiseptisch</documentation> </annotation> </enumeration> <enumeration value="0116003"> <annotation> </pre>		

	<pre> <documentation>Spülung, wirkstofffrei</documentation> </annotation> </enumeration> <enumeration value="0116004"> <annotation> <documentation>Spülung, andere</documentation> </annotation> </enumeration> <enumeration value="0116005"> <annotation> <documentation>prä-/perioperative Antibiotika</documentation> </annotation> </enumeration> <enumeration value="0116006"> <annotation> <documentation>postoperative Antibiotika</documentation> </annotation> </enumeration> <enumeration value="0116007"> <annotation> <documentation>Handschuhwechsel vor Implantation</documentation> </annotation> </enumeration> <enumeration value="0116008"> <annotation> <documentation>Implantationshilfe</documentation> </annotation> </enumeration> </restriction> </simpleType> </pre>
--	---

simpleType enum_0118

namespace	http://xml.ir-d.de/emg		
type	restriction of string		
properties	base xs:string		
used by	element OperationBrustimplantatBasis/OBI ZugangSchluessel		
facets	Kind	Value	Annotation
	enumeration	0118001	documentation axillär
	enumeration	0118002	documentation periareolär
	enumeration	0118003	documentation inframammär
	enumeration	0118004	documentation Mastektomienarbe
	enumeration	0118042	documentation anderer
annotation	documentation Kat_BI_Operationszugang		
source	<pre> <simpleType name="enum_0118"> <annotation> <documentation>Kat_BI_Operationszugang</documentation> </annotation> <restriction base="xs:string"> <enumeration value="0118001"> </pre>		

	<pre> <annotation> <documentation>axillär</documentation> </annotation> </enumeration> <enumeration value="0118002"> <annotation> <documentation>periareolär</documentation> </annotation> </enumeration> <enumeration value="0118003"> <annotation> <documentation>inframammär</documentation> </annotation> </enumeration> <enumeration value="0118004"> <annotation> <documentation>Mastektomienarbe</documentation> </annotation> </enumeration> <enumeration value="0118042"> <annotation> <documentation>anderer</documentation> </annotation> </enumeration> </restriction> </simpleType> </pre>
--	---

simpleType enum_0120

namespace	http://xml.ir-d.de/emg		
type	restriction of string		
properties	base xs:string		
used by	element BefundBrustimplantatBasis/BEB BefundAustauschSchluessel		
facets	Kind	Value	Annotation
	enumeration	0120001	documentation Expander defekt
annotation	documentation Kat_BI_BefundAustausch		
source	<pre> <simpleType name="enum_0120"> <annotation> <documentation>Kat_BI_BefundAustausch</documentation> </annotation> <restriction base="xs:string"> <enumeration value="0120001"> <annotation> <documentation>Expander defekt</documentation> </annotation> </enumeration> </restriction> </simpleType> </pre>		

simpleType enum_0121

namespace	http://xml.ir-d.de/emg
-----------	------------------------

type	restriction of string		
properties	base xs:string		
used by	element BefundBrustimplantatBasis/BEB BefundSchluessel		
facets	Kind	Value	Annotation
	enumeration	0121001	documentation Infektion
	enumeration	0121002	documentation Serom
	enumeration	0121004	documentation Kapselfibrose
	enumeration	0121005	documentation Implantatruptur
	enumeration	0121006	documentation Fehlpositionierung/Rotation
	enumeration	0121007	documentation BIA-ALCL/-BCL/-SCC, Verdacht
	enumeration	0121008	documentation BIA-ALCL/-BCL/-SCC, pathologisch bestätigt
	enumeration	0121009	documentation Brustschmerzen
	enumeration	0121010	documentation Doppelkapsel
	enumeration	0121011	documentation Netz-/ADM-bedingte Komplikation, Non-Integration
	enumeration	0121012	documentation Netz-/ADM-bedingte Komplikation, andere
	enumeration	0121013	documentation Hautnekrose/exponiertes Implantat
	enumeration	0121014	documentation BII/ASIA (Brustimplantat assoziierte Symptome), Verdacht
	enumeration	0121015	documentation Lymphadenopathie
	enumeration	0121016	documentation Brustkrebs, neu aufgetreten/Rezidiv
	enumeration	0121042	documentation sonstiger
annotation	documentation Kat_BI_BefundKomplett		
source	<pre> <simpleType name="enum_0121"> <annotation> <documentation>Kat_BI_BefundKomplett</documentation> </annotation> <restriction base="xs:string"> <enumeration value="0121001"> <annotation> <documentation>Infektion</documentation> </annotation> </enumeration> <enumeration value="0121002"> <annotation> <documentation>Serom</documentation> </annotation> </enumeration> <enumeration value="0121004"> <annotation> <documentation>Kapselfibrose</documentation> </annotation> </enumeration> <enumeration value="0121005"> <annotation> </pre>		

```
<documentation>Implantatruptur</documentation>
</annotation>
</enumeration>
<enumeration value="0121006">
  <annotation>
    <documentation>Fehlpositionierung/Rotation</documentation>
  </annotation>
</enumeration>
<enumeration value="0121007">
  <annotation>
    <documentation>BIA-ALCL/-BCL/-SCC, Verdacht</documentation>
  </annotation>
</enumeration>
<enumeration value="0121008">
  <annotation>
    <documentation>BIA-ALCL/-BCL/-SCC, pathologisch
bestätigt</documentation>
  </annotation>
</enumeration>
<enumeration value="0121009">
  <annotation>
    <documentation>Brustschmerzen</documentation>
  </annotation>
</enumeration>
<enumeration value="0121010">
  <annotation>
    <documentation>Doppelkapsel</documentation>
  </annotation>
</enumeration>
<enumeration value="0121011">
  <annotation>
    <documentation>Netz-/ADM-bedingte Komplikation, Non-
Integration</documentation>
  </annotation>
</enumeration>
<enumeration value="0121012">
  <annotation>
    <documentation>Netz-/ADM-bedingte Komplikation,
andere</documentation>
  </annotation>
</enumeration>
<enumeration value="0121013">
  <annotation>
    <documentation>Hautnekrose/exponiertes Implantat</documentation>
  </annotation>
</enumeration>
<enumeration value="0121014">
  <annotation>
    <documentation>BII/ASIA (Brustimplantat assoziierte Symptome),
Verdacht</documentation>
  </annotation>
</enumeration>
<enumeration value="0121015">
  <annotation>
    <documentation>Lymphadenopathie</documentation>
  </annotation>
</enumeration>
<enumeration value="0121016">
  <annotation>
```

	<pre> <documentation>Brustkrebs, neu aufgetreten/Rezidiv</documentation> </annotation> </enumeration> <enumeration value="0121042"> <annotation> <documentation>sonstiger</documentation> </annotation> </enumeration> </restriction> </simpleType> </pre>
--	--

simpleType enum_0122

namespace	http://xml.ir-d.de/emg		
type	restriction of string		
properties	base xs:string		
used by	element PatientenaufnahmeBrustimplantatBasis/PAB AutoimmunerkrankungSchluessel		
facets	Kind	Value	Annotation
	enumeration	0122001	documentation ja, ärztlich nachgewiesen
	enumeration	0122002	documentation nein
	enumeration	0122042	documentation unbekannt
annotation	documentation Kat_BI_Autoimmunerkrankung		
source	<pre> <simpleType name="enum_0122"> <annotation> <documentation>Kat_BI_Autoimmunerkrankung</documentation> </annotation> <restriction base="xs:string"> <enumeration value="0122001"> <annotation> <documentation>ja, ärztlich nachgewiesen</documentation> </annotation> </enumeration> <enumeration value="0122002"> <annotation> <documentation>nein</documentation> </annotation> </enumeration> <enumeration value="0122042"> <annotation> <documentation>unbekannt</documentation> </annotation> </enumeration> </restriction> </simpleType> </pre>		

simpleType enum_0123

namespace	http://xml.ir-d.de/emg
type	restriction of string

properties	base xs:string																		
used by	element PatientenaufnahmeBrustimplantatBasis/PAB_VerlaufAutoimmunerkrankungSchluessel																		
facets	<table border="1"> <thead> <tr> <th>Kind</th> <th>Value</th> <th>Annotation</th> </tr> </thead> <tbody> <tr> <td>enumeration</td> <td>0123001</td> <td>documentation neu aufgetreten</td> </tr> <tr> <td>enumeration</td> <td>0123002</td> <td>documentation verschlechtert</td> </tr> <tr> <td>enumeration</td> <td>0123003</td> <td>documentation keine Veränderung</td> </tr> <tr> <td>enumeration</td> <td>0123004</td> <td>documentation nicht relevant, da Primäreingriff</td> </tr> <tr> <td>enumeration</td> <td>0123042</td> <td>documentation unbekannt</td> </tr> </tbody> </table>	Kind	Value	Annotation	enumeration	0123001	documentation neu aufgetreten	enumeration	0123002	documentation verschlechtert	enumeration	0123003	documentation keine Veränderung	enumeration	0123004	documentation nicht relevant, da Primäreingriff	enumeration	0123042	documentation unbekannt
Kind	Value	Annotation																	
enumeration	0123001	documentation neu aufgetreten																	
enumeration	0123002	documentation verschlechtert																	
enumeration	0123003	documentation keine Veränderung																	
enumeration	0123004	documentation nicht relevant, da Primäreingriff																	
enumeration	0123042	documentation unbekannt																	
annotation	documentation Kat_BI_VerlaufAutoimmunerkrankung																		
source	<pre> <simpleType name="enum_0123"> <annotation> <documentation>Kat_BI_VerlaufAutoimmunerkrankung</documentation> </annotation> <restriction base="xs:string"> <enumeration value="0123001"> <annotation> <documentation>neu aufgetreten</documentation> </annotation> </enumeration> <enumeration value="0123002"> <annotation> <documentation>verschlechtert</documentation> </annotation> </enumeration> <enumeration value="0123003"> <annotation> <documentation>keine Veränderung</documentation> </annotation> </enumeration> <enumeration value="0123004"> <annotation> <documentation>nicht relevant, da Primäreingriff</documentation> </annotation> </enumeration> <enumeration value="0123042"> <annotation> <documentation>unbekannt</documentation> </annotation> </enumeration> </restriction> </simpleType> </pre>																		

simpleType enum_0124

namespace	http://xml.ir-d.de/emg			
type	restriction of string			
properties	base xs:string			
used by	element ArtikelBrustimplantatBasis/ABI_FuellungSchluessel			
facets	<table border="1"> <thead> <tr> <th>Kind</th> <th>Value</th> <th>Annotation</th> </tr> </thead> <tbody> </tbody> </table>	Kind	Value	Annotation
Kind	Value	Annotation		

	enumeration 0124001 documentation Salzlösung enumeration 0124002 documentation Silikongel enumeration 0124003 documentation Kombination Silikongel und Salzlösung enumeration 0124042 documentation sonstige
annotation	documentation Kat_BI_Fuellung
source	<pre> <simpleType name="enum_0124"> <annotation> <documentation>Kat_BI_Fuellung</documentation> </annotation> <restriction base="xs:string"> <enumeration value="0124001"> <annotation> <documentation>Salzlösung</documentation> </annotation> </enumeration> <enumeration value="0124002"> <annotation> <documentation>Silikongel</documentation> </annotation> </enumeration> <enumeration value="0124003"> <annotation> <documentation>Kombination Silikongel und Salzlösung</documentation> </annotation> </enumeration> <enumeration value="0124042"> <annotation> <documentation>sonstige</documentation> </annotation> </enumeration> </restriction> </simpleType> </pre>

simpleType enum_0126

namespace	http://xml.ir-d.de/emg		
type	restriction of string		
properties	base xs:string		
used by	element ArtikelBrustimplantatBasis/ABI_FormSchluessel		
facets	Kind	Value	Annotation
	enumeration	0126001	documentation anatomisch (tropfenförmig)
	enumeration	0126002	documentation rund (punktsymmetrisch)
	enumeration	0126042	documentation sonstige
annotation	documentation Kat_BI_Form		
source	<pre> <simpleType name="enum_0126"> <annotation> <documentation>Kat_BI_Form</documentation> </annotation> </pre>		

	<pre> <restriction base="xs:string"> <enumeration value="0126001"> <annotation> <documentation>anatomisch (tropfenförmig)</documentation> </annotation> </enumeration> <enumeration value="0126002"> <annotation> <documentation>rund (punktsymmetrisch)</documentation> </annotation> </enumeration> <enumeration value="0126042"> <annotation> <documentation>sonstige</documentation> </annotation> </enumeration> </restriction> </simpleType> </pre>
--	---

simpleType enum_0128

namespace	http://xml.ir-d.de/emg		
type	restriction of string		
properties	base xs:string		
used by	element ArtikelBrustimplantatBasis/ABI OberflaecheSchluesel		
facets	Kind	Value	Annotation
	enumeration	0128001	documentation glattwandig
	enumeration	0128002	documentation beschichtet
	enumeration	0128003	documentation texturiert
annotation	documentation Kat_BI_Oberflaeche		
source	<pre> <simpleType name="enum_0128"> <annotation> <documentation>Kat_BI_Oberflaeche</documentation> </annotation> <restriction base="xs:string"> <enumeration value="0128001"> <annotation> <documentation>glattwandig</documentation> </annotation> </enumeration> <enumeration value="0128002"> <annotation> <documentation>beschichtet</documentation> </annotation> </enumeration> <enumeration value="0128003"> <annotation> <documentation>texturiert</documentation> </annotation> </enumeration> </restriction> </simpleType> </pre>		

simpleType enum_0131

namespace	http://xml.ir-d.de/emg		
type	restriction of string		
properties	base xs:string		
used by	element ZubehoerBrustimplantatBasis/ZBI_HerstellerSchluessel		
facets	Kind	Value	Annotation
	enumeration	0131001	documentation Allergan
	enumeration	0131002	documentation Establishment Labs
	enumeration	0131003	documentation Eurosilicone
	enumeration	0131004	documentation Galatea
	enumeration	0131005	documentation Integra
	enumeration	0131006	documentation Lifecell
	enumeration	0131007	documentation MBP (Medical Biomaterial Products)
	enumeration	0131008	documentation Mentor
	enumeration	0131009	documentation Novus Scientific
	enumeration	0131010	documentation pfmMedical
	enumeration	0131011	documentation Serag Wiessner
	enumeration	0131012	documentation nicht belegter Wert
	enumeration	0131013	documentation nicht belegter Wert
	enumeration	0131014	documentation nicht belegter Wert
	enumeration	0131015	documentation nicht belegter Wert
	enumeration	0131042	documentation sonstiger
annotation	documentation Kat_BI_ZubehoerHersteller		
source	<pre> <simpleType name="enum_0131"> <annotation> <documentation>Kat_BI_ZubehoerHersteller</documentation> </annotation> <restriction base="xs:string"> <enumeration value="0131001"> <annotation> <documentation>Allergan</documentation> </annotation> </enumeration> <enumeration value="0131002"> <annotation> <documentation>Establishment Labs</documentation> </annotation> </enumeration> <enumeration value="0131003"> <annotation> </pre>		

```
<documentation>Eurosilicone</documentation>
</annotation>
</enumeration>
<enumeration value="0131004">
  <annotation>
    <documentation>Galatea</documentation>
  </annotation>
</enumeration>
<enumeration value="0131005">
  <annotation>
    <documentation>Integra</documentation>
  </annotation>
</enumeration>
<enumeration value="0131006">
  <annotation>
    <documentation>Lifecell</documentation>
  </annotation>
</enumeration>
<enumeration value="0131007">
  <annotation>
    <documentation>MBP (Medical Biomaterial Products)</documentation>
  </annotation>
</enumeration>
<enumeration value="0131008">
  <annotation>
    <documentation>Mentor</documentation>
  </annotation>
</enumeration>
<enumeration value="0131009">
  <annotation>
    <documentation>Novus Scientific</documentation>
  </annotation>
</enumeration>
<enumeration value="0131010">
  <annotation>
    <documentation>pfmMedical</documentation>
  </annotation>
</enumeration>
<enumeration value="0131011">
  <annotation>
    <documentation>Serag Wiessner</documentation>
  </annotation>
</enumeration>
<enumeration value="0131012">
  <annotation>
    <documentation>nicht belegter Wert</documentation>
  </annotation>
</enumeration>
<enumeration value="0131013">
  <annotation>
    <documentation>nicht belegter Wert</documentation>
  </annotation>
</enumeration>
<enumeration value="0131014">
  <annotation>
    <documentation>nicht belegter Wert</documentation>
  </annotation>
</enumeration>
<enumeration value="0131015">
```

	<pre> <annotation> <documentation>nicht belegter Wert</documentation> </annotation> </enumeration> <enumeration value="0131042"> <annotation> <documentation>sonstiger</documentation> </annotation> </enumeration> </restriction> </simpleType> </pre>
--	---

simpleType enum_0170

namespace	http://xml.ir-d.de/emg		
type	restriction of string		
properties	base xs:string		
used by	element PatientenaufnahmeBrustimplantatBasis/PAB GeschlechtGeburtSchluessel		
facets	Kind	Value	Annotation
	enumeration	0170001	documentation weiblich
	enumeration	0170002	documentation männlich
	enumeration	0170003	documentation intersexuell
annotation	documentation Kat_BI_GeschlechtGeburt		
source	<pre> <simpleType name="enum_0170"> <annotation> <documentation>Kat_BI_GeschlechtGeburt</documentation> </annotation> <restriction base="xs:string"> <enumeration value="0170001"> <annotation> <documentation>weiblich</documentation> </annotation> </enumeration> <enumeration value="0170002"> <annotation> <documentation>männlich</documentation> </annotation> </enumeration> <enumeration value="0170003"> <annotation> <documentation>intersexuell</documentation> </annotation> </enumeration> </restriction> </simpleType> </pre>		

simpleType enum_0190

namespace	http://xml.ir-d.de/emg
type	restriction of string

properties	base xs:string									
used by	element ArtikelBrustimplantatBasis/ABI ArtikelTypSchluessel									
facets	<table border="1"> <thead> <tr> <th>Kind</th> <th>Value</th> <th>Annotation</th> </tr> </thead> <tbody> <tr> <td>enumeration</td> <td>0190001</td> <td>documentation Brustimplantat</td> </tr> <tr> <td>enumeration</td> <td>0190003</td> <td>documentation Brustexpander</td> </tr> </tbody> </table>	Kind	Value	Annotation	enumeration	0190001	documentation Brustimplantat	enumeration	0190003	documentation Brustexpander
Kind	Value	Annotation								
enumeration	0190001	documentation Brustimplantat								
enumeration	0190003	documentation Brustexpander								
annotation	documentation Kat_BI_Artikeltyp									
source	<pre> <simpleType name="enum_0190"> <annotation> <documentation>Kat_BI_Artikeltyp</documentation> </annotation> <restriction base="xs:string"> <enumeration value="0190001"> <annotation> <documentation>Brustimplantat</documentation> </annotation> </enumeration> <enumeration value="0190003"> <annotation> <documentation>Brustexpander</documentation> </annotation> </enumeration> </restriction> </simpleType> </pre>									

simpleType enum_0191

namespace	http://xml.ir-d.de/emg									
type	restriction of string									
properties	base xs:string									
used by	element ZubehoerBrustimplantatBasis/ZBI Zu beho erTypSchluessel									
facets	<table border="1"> <thead> <tr> <th>Kind</th> <th>Value</th> <th>Annotation</th> </tr> </thead> <tbody> <tr> <td>enumeration</td> <td>0191001</td> <td>documentation Netz</td> </tr> <tr> <td>enumeration</td> <td>0191002</td> <td>documentation ADM</td> </tr> </tbody> </table>	Kind	Value	Annotation	enumeration	0191001	documentation Netz	enumeration	0191002	documentation ADM
Kind	Value	Annotation								
enumeration	0191001	documentation Netz								
enumeration	0191002	documentation ADM								
annotation	documentation Kat_BI_ZubehoerTyp									
source	<pre> <simpleType name="enum_0191"> <annotation> <documentation>Kat_BI_ZubehoerTyp</documentation> </annotation> <restriction base="xs:string"> <enumeration value="0191001"> <annotation> <documentation>Netz</documentation> </annotation> </enumeration> <enumeration value="0191002"> <annotation> <documentation>ADM</documentation> </annotation> </enumeration> </restriction> </simpleType> </pre>									

	<pre> </restriction> </simpleType> </pre>
--	---

simpleType enum_0200

namespace	http://xml.ir-d.de/emg		
type	restriction of string		
properties	base xs:string		
used by	element OperationEndoprotheseBasis/OEP ArtEingriffSchluessel		
facets	Kind	Value	Annotation
	enumeration	0200001	documentation Erst-OP
	enumeration	0200002	documentation Folgeeingriff
annotation	documentation Kat_EP_ArtEingriff		
source	<pre> <simpleType name="enum_0200"> <annotation> <documentation>Kat_EP_ArtEingriff</documentation> </annotation> <restriction base="xs:string"> <enumeration value="0200001"> <annotation> <documentation>Erst-OP</documentation> </annotation> </enumeration> <enumeration value="0200002"> <annotation> <documentation>Folgeeingriff</documentation> </annotation> </enumeration> </restriction> </simpleType> </pre>		

simpleType enum_0202

namespace	http://xml.ir-d.de/emg		
type	restriction of string		
properties	base xs:string		
used by	element OperationEndoprotheseBasis/OEP GrundWechselHuefteSchluessel		
facets	Kind	Value	Annotation
	enumeration	0202001	documentation Lockerung
	enumeration	0202002	documentation Infektion, Verdacht auf
	enumeration	0202003	documentation Infektion, gesichert
	enumeration	0202004	documentation Luxation, Inlay aus der Pfanne
	enumeration	0202005	documentation Luxation, Kopf aus Pfanne/Inlay
	enumeration	0202006	documentation Periprothetische Fraktur
	enumeration	0202007	documentation

	<p>enumeration 0202008 Verschleiß des PE-Inlays documentation Implantatbruch</p> <p>enumeration 0202009 documentation Implantatfehlage/Malalignent</p> <p>enumeration 0202010 documentation Osteolysen bei festem Implantat</p> <p>enumeration 0202011 documentation Progression der Grunderkrankung</p> <p>enumeration 0202012 documentation ARM D</p> <p>enumeration 0202013 documentation Verdacht auf allergische Reaktion</p> <p>enumeration 0202042 documentation andere Gründe</p>
annotation	documentation Kat_EP_GrundWechselHuefte
source	<pre> <simpleType name="enum_0202"> <annotation> <documentation>Kat_EP_GrundWechselHuefte</documentation> </annotation> <restriction base="xs:string"> <enumeration value="0202001"> <annotation> <documentation>Lockerung</documentation> </annotation> </enumeration> <enumeration value="0202002"> <annotation> <documentation>Infektion, Verdacht auf</documentation> </annotation> </enumeration> <enumeration value="0202003"> <annotation> <documentation>Infektion, gesichert</documentation> </annotation> </enumeration> <enumeration value="0202004"> <annotation> <documentation>Luxation, Inlay aus der Pfanne</documentation> </annotation> </enumeration> <enumeration value="0202005"> <annotation> <documentation>Luxation, Kopf aus Pfanne/Inlay</documentation> </annotation> </enumeration> <enumeration value="0202006"> <annotation> <documentation>Periprothetische Fraktur</documentation> </annotation> </enumeration> <enumeration value="0202007"> <annotation> <documentation>Verschleiß des PE-Inlays</documentation> </annotation> </enumeration> <enumeration value="0202008"> <annotation> <documentation>Implantatbruch</documentation> </annotation> </enumeration> </restriction> </simpleType> </pre>

```

</annotation>
</enumeration>
<enumeration value="0202009">
  <annotation>
    <documentation>Implantatfehllage/Malalignent</documentation>
  </annotation>
</enumeration>
<enumeration value="0202010">
  <annotation>
    <documentation>Osteolysen bei festem Implantat</documentation>
  </annotation>
</enumeration>
<enumeration value="0202011">
  <annotation>
    <documentation>Progression der Grunderkrankung</documentation>
  </annotation>
</enumeration>
<enumeration value="0202012">
  <annotation>
    <documentation>ARMD</documentation>
  </annotation>
</enumeration>
<enumeration value="0202013">
  <annotation>
    <documentation>Verdacht auf allergische Reaktion</documentation>
  </annotation>
</enumeration>
<enumeration value="0202042">
  <annotation>
    <documentation>andere Gründe</documentation>
  </annotation>
</enumeration>
</restriction>
</simpleType>

```

simpleType enum 0204

namespace	http://xml.ir-d.de/emg		
type	restriction of string		
properties	base xs:string		
used by	element OperationEndoprotheseBasis/OEP GrundWechselKnieSchluessel		
facets	Kind	Value	Annotation
	enumeration	0204001	documentation Lockerung
	enumeration	0204002	documentation Infektion, Verdacht auf
	enumeration	0204003	documentation Infektion, gesichert
	enumeration	0204006	documentation Periprothetische Fraktur
	enumeration	0204007	documentation Verschleiß
	enumeration	0204008	documentation Implantatbruch
	enumeration	0204009	documentation Implantatfehllage/Malalignent
	enumeration	0204010	documentation

	<p>enumeration 0204011 Osteolysen bei festem Implantat documentation Progression der Grunderkrankung</p> <p>enumeration 0204012 documentation ARMD</p> <p>enumeration 0204013 documentation Verdacht auf allergische Reaktion</p> <p>enumeration 0204014 documentation Dislokation/Migration von Komponenten</p> <p>enumeration 0204015 documentation Bandinstabilität</p> <p>enumeration 0204016 documentation Bewegungseinschränkung</p> <p>enumeration 0204042 documentation andere Gründe</p>
annotation	documentation Kat_EP_GrundWechselKnie
source	<pre> <simpleType name="enum_0204"> <annotation> <documentation>Kat_EP_GrundWechselKnie</documentation> </annotation> <restriction base="xs:string"> <enumeration value="0204001"> <annotation> <documentation>Lockerung</documentation> </annotation> </enumeration> <enumeration value="0204002"> <annotation> <documentation>Infektion, Verdacht auf</documentation> </annotation> </enumeration> <enumeration value="0204003"> <annotation> <documentation>Infektion, gesichert</documentation> </annotation> </enumeration> <enumeration value="0204006"> <annotation> <documentation>Periprothetische Fraktur</documentation> </annotation> </enumeration> <enumeration value="0204007"> <annotation> <documentation>Verschleiß</documentation> </annotation> </enumeration> <enumeration value="0204008"> <annotation> <documentation>Implantatbruch</documentation> </annotation> </enumeration> <enumeration value="0204009"> <annotation> <documentation>Implantatfehllage/Malalignent</documentation> </annotation> </enumeration> <enumeration value="0204010"> <annotation> <documentation>Osteolysen bei festem Implantat</documentation> </annotation> </enumeration> </restriction> </simpleType> </pre>

```

</annotation>
</enumeration>
<enumeration value="0204011">
  <annotation>
    <documentation>Progression der Grunderkrankung</documentation>
  </annotation>
</enumeration>
<enumeration value="0204012">
  <annotation>
    <documentation>ARMD</documentation>
  </annotation>
</enumeration>
<enumeration value="0204013">
  <annotation>
    <documentation>Verdacht auf allergische Reaktion</documentation>
  </annotation>
</enumeration>
<enumeration value="0204014">
  <annotation>
    <documentation>Dislokation/Migration von Komponenten</documentation>
  </annotation>
</enumeration>
<enumeration value="0204015">
  <annotation>
    <documentation>Bandinstabilität</documentation>
  </annotation>
</enumeration>
<enumeration value="0204016">
  <annotation>
    <documentation>Bewegungseinschränkung</documentation>
  </annotation>
</enumeration>
<enumeration value="0204042">
  <annotation>
    <documentation>andere Gründe</documentation>
  </annotation>
</enumeration>
</restriction>
</simpleType>

```

simpleType enum 0206

namespace	http://xml.ir-d.de/emg		
type	restriction of string		
properties	base xs:string		
used by	element OperationEndoprotheseBasis/OEP GrundWechselTfeSchluessel		
facets	Kind	Value	Annotation
	enumeration	0206001	documentation Lockerung
	enumeration	0206002	documentation Infektion, Verdacht auf
	enumeration	0206003	documentation Infektion, gesichert
	enumeration	0206004	documentation Luxation, Inlay aus der Pfanne
	enumeration	0206005	documentation Luxation, Kopf aus Pfanne/Inlay

	<p>enumeration 0206006 documentation Periprothetische Fraktur</p> <p>enumeration 0206007 documentation Verschleiß</p> <p>enumeration 0206008 documentation Implantatbruch</p> <p>enumeration 0206009 documentation Implantatfehlage/Malalignent</p> <p>enumeration 0206010 documentation Osteolysen bei festem Implantat</p> <p>enumeration 0206011 documentation Progression der Grunderkrankung</p> <p>enumeration 0206012 documentation ARMD</p> <p>enumeration 0206013 documentation Verdacht auf allergische Reaktion</p> <p>enumeration 0206014 documentation Dislokation/Migration von Komponenten</p> <p>enumeration 0206015 documentation Bandinstabilität</p> <p>enumeration 0206016 documentation Bewegungseinschränkung</p> <p>enumeration 0206042 documentation andere Gründe</p>
annotation	documentation Kat_EP_GrundWechselTFE
source	<pre> <simpleType name="enum_0206"> <annotation> <documentation>Kat_EP_GrundWechselTFE</documentation> </annotation> <restriction base="xs:string"> <enumeration value="0206001"> <annotation> <documentation>Lockerung</documentation> </annotation> </enumeration> <enumeration value="0206002"> <annotation> <documentation>Infektion, Verdacht auf</documentation> </annotation> </enumeration> <enumeration value="0206003"> <annotation> <documentation>Infektion, gesichert</documentation> </annotation> </enumeration> <enumeration value="0206004"> <annotation> <documentation>Luxation, Inlay aus der Pfanne</documentation> </annotation> </enumeration> <enumeration value="0206005"> <annotation> <documentation>Luxation, Kopf aus Pfanne/Inlay</documentation> </annotation> </enumeration> <enumeration value="0206006"> <annotation> <documentation>Periprothetische Fraktur</documentation> </annotation> </enumeration> </restriction> </simpleType> </pre>

```
<enumeration value="0206007">
  <annotation>
    <documentation>Verschleiß</documentation>
  </annotation>
</enumeration>
<enumeration value="0206008">
  <annotation>
    <documentation>Implantatbruch</documentation>
  </annotation>
</enumeration>
<enumeration value="0206009">
  <annotation>
    <documentation>Implantatfehllage/Malalignement</documentation>
  </annotation>
</enumeration>
<enumeration value="0206010">
  <annotation>
    <documentation>Osteolysen bei festem Implantat</documentation>
  </annotation>
</enumeration>
<enumeration value="0206011">
  <annotation>
    <documentation>Progression der Grunderkrankung</documentation>
  </annotation>
</enumeration>
<enumeration value="0206012">
  <annotation>
    <documentation>ARMD</documentation>
  </annotation>
</enumeration>
<enumeration value="0206013">
  <annotation>
    <documentation>Verdacht auf allergische Reaktion</documentation>
  </annotation>
</enumeration>
<enumeration value="0206014">
  <annotation>
    <documentation>Dislokation/Migration von Komponenten</documentation>
  </annotation>
</enumeration>
<enumeration value="0206015">
  <annotation>
    <documentation>Bandinstabilität</documentation>
  </annotation>
</enumeration>
<enumeration value="0206016">
  <annotation>
    <documentation>Bewegungseinschränkung</documentation>
  </annotation>
</enumeration>
<enumeration value="0206042">
  <annotation>
    <documentation>andere Gründe</documentation>
  </annotation>
</enumeration>
</restriction>
</simpleType>
```

simpleType enum_0210

namespace	http://xml.ir-d.de/emg		
type	restriction of string		
properties	base xs:string		
used by	element VorbereitungEndoprotheseBasis/VEP_VorOpHuefteSchluessel		
facets	Kind	Value	Annotation
	enumeration	0210001	documentation keine relevante Voroperation
	enumeration	0210002	documentation Osteosynthese/Osteotomie (Becken)
	enumeration	0210003	documentation Osteosynthese/Osteotomie (Femur)
	enumeration	0210004	documentation Osteosynthese/Osteotomie (beides)
	enumeration	0210005	documentation Operation bei Hüftkopfnekrose
	enumeration	0210006	documentation Arthrodese
	enumeration	0210042	documentation andere
annotation	documentation Kat_EP_VoroperationHuefte		
source	<pre> <simpleType name="enum_0210"> <annotation> <documentation>Kat_EP_VoroperationHuefte</documentation> </annotation> <restriction base="xs:string"> <enumeration value="0210001"> <annotation> <documentation>keine relevante Voroperation</documentation> </annotation> </enumeration> <enumeration value="0210002"> <annotation> <documentation>Osteosynthese/Osteotomie (Becken)</documentation> </annotation> </enumeration> <enumeration value="0210003"> <annotation> <documentation>Osteosynthese/Osteotomie (Femur)</documentation> </annotation> </enumeration> <enumeration value="0210004"> <annotation> <documentation>Osteosynthese/Osteotomie (beides)</documentation> </annotation> </enumeration> <enumeration value="0210005"> <annotation> <documentation>Operation bei Hüftkopfnekrose</documentation> </annotation> </enumeration> <enumeration value="0210006"> <annotation> <documentation>Arthrodese</documentation> </annotation> </enumeration> </restriction> </simpleType> </pre>		

	<pre> </enumeration> <enumeration value="0210042"> <annotation> <documentation>andere</documentation> </annotation> </enumeration> </restriction> </simpleType> </pre>
--	--

simpleType enum_0211

namespace	http://xml.ir-d.de/emg		
type	restriction of string		
properties	base xs:string		
used by	element VorbereitungEndoprotheseBasis/VEP_VorOpKnieSchlüssel		
facets	Kind	Value	Annotation
	enumeration	0211001	documentation keine relevante Voroperation
	enumeration	0211002	documentation Osteosynthese/Osteotomie (Femur)
	enumeration	0211003	documentation Osteosynthese/Osteotomie (Tibia)
	enumeration	0211004	documentation Osteosynthese/Osteotomie (Patella)
	enumeration	0211005	documentation Osteosynthese/Osteotomie (mehrere)
	enumeration	0211006	documentation Kapsel-/Bandapparat
	enumeration	0211007	documentation Arthrodese
	enumeration	0211042	documentation andere
annotation	documentation Kat_EP_VoroperationKnie		
source	<pre> <simpleType name="enum_0211"> <annotation> <documentation>Kat_EP_VoroperationKnie</documentation> </annotation> <restriction base="xs:string"> <enumeration value="0211001"> <annotation> <documentation>keine relevante Voroperation</documentation> </annotation> </enumeration> <enumeration value="0211002"> <annotation> <documentation>Osteosynthese/Osteotomie (Femur)</documentation> </annotation> </enumeration> <enumeration value="0211003"> <annotation> <documentation>Osteosynthese/Osteotomie (Tibia)</documentation> </annotation> </enumeration> <enumeration value="0211004"> <annotation> <documentation>Osteosynthese/Osteotomie (Patella)</documentation> </pre>		

	<pre> </annotation> </enumeration> <enumeration value="0211005"> <annotation> <documentation>Osteosynthese/Osteotomie (mehrere)</documentation> </annotation> </enumeration> <enumeration value="0211006"> <annotation> <documentation>Kapsel-/Bandapparat</documentation> </annotation> </enumeration> <enumeration value="0211007"> <annotation> <documentation>Arthrodese</documentation> </annotation> </enumeration> <enumeration value="0211042"> <annotation> <documentation>andere</documentation> </annotation> </enumeration> </restriction> </simpleType> </pre>
--	---

simpleType enum_0212

namespace	http://xml.ir-d.de/emg		
type	restriction of string		
properties	base xs:string		
used by	element OperationEndoprotheseBasis/OEP GelenkSchluessel		
facets	Kind	Value	Annotation
	enumeration	0212001	documentation Hüfte
	enumeration	0212002	documentation Knie
	enumeration	0212003	documentation Totaler Femurersatz inkl. Durchsteck-Prothese
annotation	documentation Kat_EP_Gelenk		
source	<pre> <simpleType name="enum_0212"> <annotation> <documentation>Kat_EP_Gelenk</documentation> </annotation> <restriction base="xs:string"> <enumeration value="0212001"> <annotation> <documentation>Hüfte</documentation> </annotation> </enumeration> <enumeration value="0212002"> <annotation> <documentation>Knie</documentation> </annotation> </enumeration> <enumeration value="0212003"> </pre>		

	<pre> <annotation> <documentation>Totaler Femurersatz inkl. Durchsteck- Prothese</documentation> </annotation> </enumeration> </restriction> </simpleType> </pre>
--	---

simpleType **enum_0220**

namespace	http://xml.ir-d.de/emg		
type	restriction of string		
properties	base xs:string		
used by	element OperationEndoprotheseBasis/OEP ZugangHuefteSchluessel		
facets	Kind	Value	Annotation
	enumeration	0220001	documentation anterior
	enumeration	0220002	documentation anterolateral
	enumeration	0220003	documentation lateral
	enumeration	0220004	documentation posterior
	enumeration	0220005	documentation posterolateral
	enumeration	0220006	documentation 2-Inzisionen-Zugang
	enumeration	0220042	documentation sonstiger
annotation	documentation Kat_EP_Operationszugang		
source	<pre> <simpleType name="enum_0220"> <annotation> <documentation>Kat_EP_Operationszugang</documentation> </annotation> <restriction base="xs:string"> <enumeration value="0220001"> <annotation> <documentation>anterior</documentation> </annotation> </enumeration> <enumeration value="0220002"> <annotation> <documentation>anterolateral</documentation> </annotation> </enumeration> <enumeration value="0220003"> <annotation> <documentation>lateral</documentation> </annotation> </enumeration> <enumeration value="0220004"> <annotation> <documentation>posterior</documentation> </annotation> </enumeration> <enumeration value="0220005"> </pre>		

	<pre> <annotation> <documentation>posterolateral</documentation> </annotation> </enumeration> <enumeration value="0220006"> <annotation> <documentation>2-Inzisionen-Zugang</documentation> </annotation> </enumeration> <enumeration value="0220042"> <annotation> <documentation>sonstiger</documentation> </annotation> </enumeration> </restriction> </simpleType> </pre>
--	---

simpleType enum_0222

namespace	http://xml.ir-d.de/emg		
type	restriction of string		
properties	base xs:string		
used by	element OperationEndoprotheseBasis/OEP ZweizeitwechselSchlüssel		
facets	Kind	Value	Annotation
	enumeration	0222001	documentation nein
	enumeration	0222002	documentation ja- Ausbau
	enumeration	0222003	documentation ja- Einbau
annotation	documentation Kat_EP_Zweizeitwechsel		
source	<pre> <simpleType name="enum_0222"> <annotation> <documentation>Kat_EP_Zweizeitwechsel</documentation> </annotation> <restriction base="xs:string"> <enumeration value="0222001"> <annotation> <documentation>nein</documentation> </annotation> </enumeration> <enumeration value="0222002"> <annotation> <documentation>ja- Ausbau</documentation> </annotation> </enumeration> <enumeration value="0222003"> <annotation> <documentation>ja- Einbau</documentation> </annotation> </enumeration> </restriction> </simpleType> </pre>		

simpleType enum_0252

namespace	http://xml.ir-d.de/emg		
type	restriction of string		
properties	base xs:string		
used by	element OperationEndoprotheseBasis/OEP KomponenteHuefteSchluessel		
facets	Kind	Value	Annotation
	enumeration	0252001	documentation Pfanne
	enumeration	0252002	documentation Schaft
	enumeration	0252003	documentation beides
annotation	documentation Kat_EP_KomponenteHuefte		
source	<pre> <simpleType name="enum_0252"> <annotation> <documentation>Kat_EP_KomponenteHuefte</documentation> </annotation> <restriction base="xs:string"> <enumeration value="0252001"> <annotation> <documentation>Pfanne</documentation> </annotation> </enumeration> <enumeration value="0252002"> <annotation> <documentation>Schaft</documentation> </annotation> </enumeration> <enumeration value="0252003"> <annotation> <documentation>beides</documentation> </annotation> </enumeration> </restriction> </simpleType> </pre>		

simpleType enum_0254

namespace	http://xml.ir-d.de/emg		
type	restriction of string		
properties	base xs:string		
used by	element OperationEndoprotheseBasis/OEP KomponenteKnieSchluessel		
facets	Kind	Value	Annotation
	enumeration	0254001	documentation Femur
	enumeration	0254002	documentation Tibia
	enumeration	0254003	documentation Patella
	enumeration	0254004	documentation mehrere
annotation	documentation		

	Kat_EP_KomponenteKnie
source	<pre> <simpleType name="enum_0254"> <annotation> <documentation>Kat_EP_KomponenteKnie</documentation> </annotation> <restriction base="xs:string"> <enumeration value="0254001"> <annotation> <documentation>Femur</documentation> </annotation> </enumeration> <enumeration value="0254002"> <annotation> <documentation>Tibia</documentation> </annotation> </enumeration> <enumeration value="0254003"> <annotation> <documentation>Patella</documentation> </annotation> </enumeration> <enumeration value="0254004"> <annotation> <documentation>mehrere</documentation> </annotation> </enumeration> </restriction> </simpleType> </pre>

simpleType enum_0256

namespace	http://xml.ir-d.de/emg		
type	restriction of string		
properties	base xs:string		
used by	element	OperationEndoprotheseBasis/OEP_KomponenteTfeSchluessel	
facets	Kind	Value	Annotation
	enumeration	0256001	documentation Pfanne
	enumeration	0256002	documentation Schaft
	enumeration	0256003	documentation Pfanne und Schaft
	enumeration	0256004	documentation Femur
	enumeration	0256005	documentation Tibia
	enumeration	0256006	documentation Patella
	enumeration	0256007	documentation mehrere
annotation	documentation Kat_EP_KomponenteTFE		
source	<pre> <simpleType name="enum_0256"> <annotation> <documentation>Kat_EP_KomponenteTFE</documentation> </annotation> <restriction base="xs:string"> </pre>		

```

<enumeration value="0256001">
  <annotation>
    <documentation>Pfanne</documentation>
  </annotation>
</enumeration>
<enumeration value="0256002">
  <annotation>
    <documentation>Schaft</documentation>
  </annotation>
</enumeration>
<enumeration value="0256003">
  <annotation>
    <documentation>Pfanne und Schaft</documentation>
  </annotation>
</enumeration>
<enumeration value="0256004">
  <annotation>
    <documentation>Femur</documentation>
  </annotation>
</enumeration>
<enumeration value="0256005">
  <annotation>
    <documentation>Tibia</documentation>
  </annotation>
</enumeration>
<enumeration value="0256006">
  <annotation>
    <documentation>Patella</documentation>
  </annotation>
</enumeration>
<enumeration value="0256007">
  <annotation>
    <documentation>mehrere</documentation>
  </annotation>
</enumeration>
</restriction>
</simpleType>

```

simpleType enum 0262

namespace	http://xml.ir-d.de/emg		
type	restriction of string		
properties	base xs:string		
used by	element OperationEndoprotheseBasis/OEP ImplantatbruchHuefteSchluessel		
facets	Kind	Value	Annotation
	enumeration	0262001	documentation Pfanne
	enumeration	0262002	documentation Schaft
	enumeration	0262003	documentation Kopf
	enumeration	0262004	documentation Inlay
	enumeration	0262005	documentation Adapter
	enumeration	0262006	documentation mehrere

annotation	documentation Kat_EP_ImplantatbruchHuefte
source	<pre> <simpleType name="enum_0262"> <annotation> <documentation>Kat_EP_ImplantatbruchHuefte</documentation> </annotation> <restriction base="xs:string"> <enumeration value="0262001"> <annotation> <documentation>Pfanne</documentation> </annotation> </enumeration> <enumeration value="0262002"> <annotation> <documentation>Schaft</documentation> </annotation> </enumeration> <enumeration value="0262003"> <annotation> <documentation>Kopf</documentation> </annotation> </enumeration> <enumeration value="0262004"> <annotation> <documentation>Inlay</documentation> </annotation> </enumeration> <enumeration value="0262005"> <annotation> <documentation>Adapter</documentation> </annotation> </enumeration> <enumeration value="0262006"> <annotation> <documentation>mehrere</documentation> </annotation> </enumeration> </restriction> </simpleType> </pre>

simpleType enum_0264

namespace	http://xml.ir-d.de/emg		
type	restriction of string		
properties	base xs:string		
used by	element	OperationEndoprotheseBasis/OEP ImplantatbruchKnieSchluessel	
facets	Kind	Value	Annotation
	enumeration	0264001	documentation Femur
	enumeration	0264002	documentation Tibia
	enumeration	0264003	documentation Inlay
	enumeration	0264004	documentation Adapter
	enumeration	0264005	documentation Verlängerung

	enumeration 0264006 documentation Schrauben enumeration 0264007 documentation mehrere enumeration 0264042 documentation andere
annotation	documentation Kat_EP_ImplantatbruchKnie
source	<pre> <simpleType name="enum_0264"> <annotation> <documentation>Kat_EP_ImplantatbruchKnie</documentation> </annotation> <restriction base="xs:string"> <enumeration value="0264001"> <annotation> <documentation>Femur</documentation> </annotation> </enumeration> <enumeration value="0264002"> <annotation> <documentation>Tibia</documentation> </annotation> </enumeration> <enumeration value="0264003"> <annotation> <documentation>Inlay</documentation> </annotation> </enumeration> <enumeration value="0264004"> <annotation> <documentation>Adapter</documentation> </annotation> </enumeration> <enumeration value="0264005"> <annotation> <documentation>Verlängerung</documentation> </annotation> </enumeration> <enumeration value="0264006"> <annotation> <documentation>Schrauben</documentation> </annotation> </enumeration> <enumeration value="0264007"> <annotation> <documentation>mehrere</documentation> </annotation> </enumeration> <enumeration value="0264042"> <annotation> <documentation>andere</documentation> </annotation> </enumeration> </restriction> </simpleType> </pre>

simpleType enum_0266

namespace	http://xml.ir-d.de/emg		
type	restriction of string		
properties	base xs:string		
used by	element OperationEndoprotheseBasis/OEP_ImplantatbruchTfeSchluessel		
facets	Kind	Value	Annotation
	enumeration	0266001	documentation Pfanne
	enumeration	0266002	documentation Schaft
	enumeration	0266003	documentation Kopf
	enumeration	0266004	documentation Inlay
	enumeration	0266005	documentation Adapter
	enumeration	0266006	documentation Femur
	enumeration	0266007	documentation Tibia
	enumeration	0266008	documentation Verlängerung
	enumeration	0266009	documentation Schrauben
	enumeration	0266010	documentation mehrere
	enumeration	0266042	documentation andere
annotation	documentation Kat_EP_ImplantatbruchTFE		
source	<pre> <simpleType name="enum_0266"> <annotation> <documentation>Kat_EP_ImplantatbruchTFE</documentation> </annotation> <restriction base="xs:string"> <enumeration value="0266001"> <annotation> <documentation>Pfanne</documentation> </annotation> </enumeration> <enumeration value="0266002"> <annotation> <documentation>Schaft</documentation> </annotation> </enumeration> <enumeration value="0266003"> <annotation> <documentation>Kopf</documentation> </annotation> </enumeration> <enumeration value="0266004"> <annotation> <documentation>Inlay</documentation> </annotation> </enumeration> <enumeration value="0266005"> <annotation> <documentation>Adapter</documentation> </pre>		

```

</annotation>
</enumeration>
<enumeration value="0266006">
  <annotation>
    <documentation>Femur</documentation>
  </annotation>
</enumeration>
<enumeration value="0266007">
  <annotation>
    <documentation>Tibia</documentation>
  </annotation>
</enumeration>
<enumeration value="0266008">
  <annotation>
    <documentation>Verlängerung</documentation>
  </annotation>
</enumeration>
<enumeration value="0266009">
  <annotation>
    <documentation>Schrauben</documentation>
  </annotation>
</enumeration>
<enumeration value="0266010">
  <annotation>
    <documentation>mehrere</documentation>
  </annotation>
</enumeration>
<enumeration value="0266042">
  <annotation>
    <documentation>andere</documentation>
  </annotation>
</enumeration>
</restriction>
</simpleType>

```

simpleType enum_0270

namespace	http://xml.lir-d.de/emg		
type	restriction of string		
properties	base xs:string		
used by	element OperationEndoprotheseBasis/OEP VerschleissKnieSchluessel		
facets	Kind	Value	Annotation
	enumeration	0270001	documentation PE-Inlay
	enumeration	0270002	documentation patellare Komponente
	enumeration	0270003	documentation beides
annotation	documentation Kat EP_VerschleissKnie		
source	<pre> <simpleType name="enum_0270"> <annotation> <documentation>Kat_EP_VerschleissKnie</documentation> </annotation> <restriction base="xs:string"> <enumeration value="0270001"> </pre>		

	<pre> <annotation> <documentation>PE-Inlay</documentation> </annotation> </enumeration> <enumeration value="0270002"> <annotation> <documentation>patellare Komponente</documentation> </annotation> </enumeration> <enumeration value="0270003"> <annotation> <documentation>beides</documentation> </annotation> </enumeration> </restriction> </simpleType> </pre>
--	---

simpleType enum_0271

namespace	http://xml.ir-d.de/emg		
type	restriction of string		
properties	base xs:string		
used by	element OperationEndoprotheseBasis/OEP MigrationKnieSchluessel		
facets	Kind	Value	Annotation
	enumeration	0271001	documentation Schraube
	enumeration	0271002	documentation Inlay
	enumeration	0271003	documentation patellare Komponente
	enumeration	0271004	documentation Kopplung
	enumeration	0271005	documentation mehrere
	enumeration	0271042	documentation andere
annotation	documentation Kat_EP_MigrationKnie		
source	<pre> <simpleType name="enum_0271"> <annotation> <documentation>Kat_EP_MigrationKnie</documentation> </annotation> <restriction base="xs:string"> <enumeration value="0271001"> <annotation> <documentation>Schraube</documentation> </annotation> </enumeration> <enumeration value="0271002"> <annotation> <documentation>Inlay</documentation> </annotation> </enumeration> <enumeration value="0271003"> <annotation> <documentation>patellare Komponente</documentation> </annotation> </enumeration> </restriction> </simpleType> </pre>		

	<pre> </enumeration> <enumeration value="0271004"> <annotation> <documentation>Kopplung</documentation> </annotation> </enumeration> <enumeration value="0271005"> <annotation> <documentation>mehrere</documentation> </annotation> </enumeration> <enumeration value="0271042"> <annotation> <documentation>andere</documentation> </annotation> </enumeration> </restriction> </simpleType> </pre>
--	---

simpleType enum_0280

namespace	http://xml.ir-d.de/emg		
type	restriction of string		
properties	base xs:string		
used by	element OperationEndprotheseBasis/OEP_AssistiveTechnologieSchluessel		
facets	Kind	Value	Annotation
	enumeration	0280001	documentation Ohne
	enumeration	0280002	documentation PSI
	enumeration	0280003	documentation Navigation
	enumeration	0280004	documentation Robotik
	enumeration	0280042	documentation Unbekannt
annotation	documentation Kat_EP_AssistiveTechnologie		
source	<pre> <simpleType name="enum_0280"> <annotation> <documentation>Kat_EP_AssistiveTechnologie</documentation> </annotation> <restriction base="xs:string"> <enumeration value="0280001"> <annotation> <documentation>Ohne</documentation> </annotation> </enumeration> <enumeration value="0280002"> <annotation> <documentation>PSI</documentation> </annotation> </enumeration> <enumeration value="0280003"> <annotation> <documentation>Navigation</documentation> </pre>		

```

</annotation>
</enumeration>
<enumeration value="0280004">
  <annotation>
    <documentation>Robotik</documentation>
  </annotation>
</enumeration>
<enumeration value="0280042">
  <annotation>
    <documentation>Unbekannt</documentation>
  </annotation>
</enumeration>
</restriction>
</simpleType>

```

simpleType enum_0281

namespace	http://xml.ir-d.de/emg		
type	restriction of string		
properties	base xs:string		
used by	element OperationEndoprotheseBasis/OEP_NavigationSchluesse!		
facets	Kind	Value	Annotation
	enumeration	0281001	documentation Aesculap - OrthoPilot
	enumeration	0281002	documentation Amplitude - Amplivision
	enumeration	0281003	documentation Johnson & Johnson - VELYS
	enumeration	0281004	documentation Orthokey - Orthokey Miro
	enumeration	0281005	documentation Orthokey - BLU-IGS
	enumeration	0281006	documentation Smith & Nephew - Brainlab Plattformen (TBD)
	enumeration	0281007	documentation Stryker - Stryker NAV3i
	enumeration	0281008	documentation Stryker - Stryker Ortho Q Guidance System
	enumeration	0281009	documentation ThinkSurgical - TMINI
	enumeration	0281010	documentation Zimmer Biomet - Sesamoid Navigation
	enumeration	0281011	documentation Zimmer Biomet - iAssist Navigation
	enumeration	0281012	documentation nicht belegter Wert
	enumeration	0281013	documentation nicht belegter Wert
	enumeration	0281014	documentation nicht belegter Wert
	enumeration	0281015	documentation nicht belegter Wert
	enumeration	0281016	documentation nicht belegter Wert
	enumeration	0281042	documentation sonstige
annotation	documentation Kat_EP_Navigation		

source

```
<simpleType name="enum_0281">
  <annotation>
    <documentation>Kat_EP_Navigation</documentation>
  </annotation>
  <restriction base="xs:string">
    <enumeration value="0281001">
      <annotation>
        <documentation>Aesculap - OrthoPilot</documentation>
      </annotation>
    </enumeration>
    <enumeration value="0281002">
      <annotation>
        <documentation>Amplitude - Amplivision</documentation>
      </annotation>
    </enumeration>
    <enumeration value="0281003">
      <annotation>
        <documentation>Johnson & Johnson - VELYS</documentation>
      </annotation>
    </enumeration>
    <enumeration value="0281004">
      <annotation>
        <documentation>Orthokey - Orthokey Miro</documentation>
      </annotation>
    </enumeration>
    <enumeration value="0281005">
      <annotation>
        <documentation>Orthokey - BLU-IGS</documentation>
      </annotation>
    </enumeration>
    <enumeration value="0281006">
      <annotation>
        <documentation>Smith & Nephew - Brainlab Plattformen
(TBD)</documentation>
      </annotation>
    </enumeration>
    <enumeration value="0281007">
      <annotation>
        <documentation>Stryker - Stryker NAV3i</documentation>
      </annotation>
    </enumeration>
    <enumeration value="0281008">
      <annotation>
        <documentation>Stryker - Stryker Ortho Q Guidance
System</documentation>
      </annotation>
    </enumeration>
    <enumeration value="0281009">
      <annotation>
        <documentation>ThinkSurgical - TMINI</documentation>
      </annotation>
    </enumeration>
    <enumeration value="0281010">
      <annotation>
        <documentation>Zimmer Biomet - Sesamoid Navigation</documentation>
      </annotation>
    </enumeration>
    <enumeration value="0281011">
      <annotation>
```

```

    <documentation>Zimmer Biomet - iAssist Navigation</documentation>
  </annotation>
</enumeration>
<enumeration value="0281012">
  <annotation>
    <documentation>nicht belegter Wert</documentation>
  </annotation>
</enumeration>
<enumeration value="0281013">
  <annotation>
    <documentation>nicht belegter Wert</documentation>
  </annotation>
</enumeration>
<enumeration value="0281014">
  <annotation>
    <documentation>nicht belegter Wert</documentation>
  </annotation>
</enumeration>
<enumeration value="0281015">
  <annotation>
    <documentation>nicht belegter Wert</documentation>
  </annotation>
</enumeration>
<enumeration value="0281016">
  <annotation>
    <documentation>nicht belegter Wert</documentation>
  </annotation>
</enumeration>
<enumeration value="0281042">
  <annotation>
    <documentation>sonstige</documentation>
  </annotation>
</enumeration>
</restriction>
</simpleType>

```

simpleType enum 0282

namespace	http://xml.ir-d.de/emg		
type	restriction of string		
properties	base xs:string		
used by	element OperationEndoprotheseBasis/OEP RobotikSchluessel		
facets	Kind	Value	Annotation
	enumeration	0282001	documentation Amplitude - Andy
	enumeration	0282002	documentation Corin - ApolloKnee
	enumeration	0282003	documentation Corin - OMNIBotics
	enumeration	0282004	documentation Microport - Skywalker
	enumeration	0282005	documentation Orthokey - Orthokey Robin
	enumeration	0282006	documentation Smith & Nephew - CORI
	enumeration	0282007	documentation Smith & Nephew - NAVIO

	<p>enumeration 0282008 documentation Stryker - Mako SmartRobotics</p> <p>enumeration 0282009 documentation Zimmer Biomet - ROSA</p> <p>enumeration 0282010 documentation Johnson & Johnson - VELYS Robotic Assisted Solution</p> <p>enumeration 0282011 documentation nicht belegter Wert</p> <p>enumeration 0282012 documentation nicht belegter Wert</p> <p>enumeration 0282013 documentation nicht belegter Wert</p> <p>enumeration 0282014 documentation nicht belegter Wert</p> <p>enumeration 0282015 documentation nicht belegter Wert</p> <p>enumeration 0282042 documentation sonstige</p>
annotation	documentation Kat_EP_Robotik
source	<pre> <simpleType name="enum_0282"> <annotation> <documentation>Kat_EP_Robotik</documentation> </annotation> <restriction base="xs:string"> <enumeration value="0282001"> <annotation> <documentation>Amplitude - Andy</documentation> </annotation> </enumeration> <enumeration value="0282002"> <annotation> <documentation>Corin - ApolloKnee</documentation> </annotation> </enumeration> <enumeration value="0282003"> <annotation> <documentation>Corin - OMNIBotics</documentation> </annotation> </enumeration> <enumeration value="0282004"> <annotation> <documentation>Microport - Skywalker</documentation> </annotation> </enumeration> <enumeration value="0282005"> <annotation> <documentation>Orthokey - Orthokey Robin</documentation> </annotation> </enumeration> <enumeration value="0282006"> <annotation> <documentation>Smith & Nephew - CORI</documentation> </annotation> </enumeration> <enumeration value="0282007"> <annotation> <documentation>Smith & Nephew - NAVIO</documentation> </annotation> </enumeration> </restriction> </simpleType> </pre>

```

<enumeration value="0282008">
  <annotation>
    <documentation>Stryker - Mako SmartRobotics</documentation>
  </annotation>
</enumeration>
<enumeration value="0282009">
  <annotation>
    <documentation>Zimmer Biomet - ROSA</documentation>
  </annotation>
</enumeration>
<enumeration value="0282010">
  <annotation>
    <documentation>Johnson & Johnson - VELYS Robotic Assisted
Solution</documentation>
  </annotation>
</enumeration>
<enumeration value="0282011">
  <annotation>
    <documentation>nicht belegter Wert</documentation>
  </annotation>
</enumeration>
<enumeration value="0282012">
  <annotation>
    <documentation>nicht belegter Wert</documentation>
  </annotation>
</enumeration>
<enumeration value="0282013">
  <annotation>
    <documentation>nicht belegter Wert</documentation>
  </annotation>
</enumeration>
<enumeration value="0282014">
  <annotation>
    <documentation>nicht belegter Wert</documentation>
  </annotation>
</enumeration>
<enumeration value="0282015">
  <annotation>
    <documentation>nicht belegter Wert</documentation>
  </annotation>
</enumeration>
<enumeration value="0282042">
  <annotation>
    <documentation>sonstige</documentation>
  </annotation>
</enumeration>
</restriction>
</simpleType>

```

simpleType enum_0290

namespace	http://xml.ir-d.de/emg
type	restriction of string
properties	base xs:string
used by	element ArtikelEndoprotheseBasis/AEP ArtikelTypSchluessel

facets	<table border="1"> <thead> <tr> <th>Kind</th> <th>Value</th> <th>Annotation</th> </tr> </thead> <tbody> <tr> <td>enumeration</td> <td>0290001</td> <td>documentation Hüft-Komponente</td> </tr> <tr> <td>enumeration</td> <td>0290002</td> <td>documentation Knie-Komponente</td> </tr> <tr> <td>enumeration</td> <td>0290003</td> <td>documentation Modulare Komponente (Hüfte/Knie)</td> </tr> <tr> <td>enumeration</td> <td>0290004</td> <td>documentation Knochenzement</td> </tr> <tr> <td>enumeration</td> <td>0290042</td> <td>documentation sonstiger</td> </tr> </tbody> </table>	Kind	Value	Annotation	enumeration	0290001	documentation Hüft-Komponente	enumeration	0290002	documentation Knie-Komponente	enumeration	0290003	documentation Modulare Komponente (Hüfte/Knie)	enumeration	0290004	documentation Knochenzement	enumeration	0290042	documentation sonstiger
Kind	Value	Annotation																	
enumeration	0290001	documentation Hüft-Komponente																	
enumeration	0290002	documentation Knie-Komponente																	
enumeration	0290003	documentation Modulare Komponente (Hüfte/Knie)																	
enumeration	0290004	documentation Knochenzement																	
enumeration	0290042	documentation sonstiger																	
annotation	documentation Kat_EP_Artikeltyp																		
source	<pre> <simpleType name="enum_0290"> <annotation> <documentation>Kat_EP_Artikeltyp</documentation> </annotation> <restriction base="xs:string"> <enumeration value="0290001"> <annotation> <documentation>Hüft-Komponente</documentation> </annotation> </enumeration> <enumeration value="0290002"> <annotation> <documentation>Knie-Komponente</documentation> </annotation> </enumeration> <enumeration value="0290003"> <annotation> <documentation>Modulare Komponente (Hüfte/Knie)</documentation> </annotation> </enumeration> <enumeration value="0290004"> <annotation> <documentation>Knochenzement</documentation> </annotation> </enumeration> <enumeration value="0290042"> <annotation> <documentation>sonstiger</documentation> </annotation> </enumeration> </restriction> </simpleType> </pre>																		

simpleType enum_0292

namespace	http://xml.ir-d.de/emg									
type	restriction of string									
properties	base xs:string									
used by	element ArtikelEndoprotheseBasis/AEP_ArtikelTypHuefteSchluessel									
facets	<table border="1"> <thead> <tr> <th>Kind</th> <th>Value</th> <th>Annotation</th> </tr> </thead> <tbody> <tr> <td>enumeration</td> <td>0292001</td> <td>documentation Pfanne</td> </tr> <tr> <td>enumeration</td> <td>0292002</td> <td>documentation Inlay</td> </tr> </tbody> </table>	Kind	Value	Annotation	enumeration	0292001	documentation Pfanne	enumeration	0292002	documentation Inlay
Kind	Value	Annotation								
enumeration	0292001	documentation Pfanne								
enumeration	0292002	documentation Inlay								

	<p>enumeration 0292003 documentation Kopf</p> <p>enumeration 0292004 documentation Schaft</p> <p>enumeration 0292005 documentation Vormontierte Acetabularkomponente (Pfanne mit Inlay)</p> <p>enumeration 0292006 documentation Einteilige Femoralkomponente (Schaft mit Kopf)</p> <p>enumeration 0292042 documentation sonstiger</p>
annotation	documentation Kat_EP_ArtikeltypHuefte
source	<pre> <simpleType name="enum_0292"> <annotation> <documentation>Kat_EP_ArtikeltypHuefte</documentation> </annotation> <restriction base="xs:string"> <enumeration value="0292001"> <annotation> <documentation>Pfanne</documentation> </annotation> </enumeration> <enumeration value="0292002"> <annotation> <documentation>Inlay</documentation> </annotation> </enumeration> <enumeration value="0292003"> <annotation> <documentation>Kopf</documentation> </annotation> </enumeration> <enumeration value="0292004"> <annotation> <documentation>Schaft</documentation> </annotation> </enumeration> <enumeration value="0292005"> <annotation> <documentation>Vormontierte Acetabularkomponente (Pfanne mit Inlay)</documentation> </annotation> </enumeration> <enumeration value="0292006"> <annotation> <documentation>Einteilige Femoralkomponente (Schaft mit Kopf)</documentation> </annotation> </enumeration> <enumeration value="0292042"> <annotation> <documentation>sonstiger</documentation> </annotation> </enumeration> </restriction> </simpleType> </pre>

simpleType enum_0293

namespace	http://xml.ir-d.de/emg		
type	restriction of string		
properties	base xs:string		
used by	element ArtikelEndoprotheseBasis/AEP ArtikelTypKnieSchluessel		
facets	Kind	Value	Annotation
	enumeration	0293001	documentation Tibiakomponente
	enumeration	0293002	documentation Femurkomponente
	enumeration	0293003	documentation Patella
	enumeration	0293004	documentation Insert
	enumeration	0293005	documentation Vormontierte Tibiakomponente mit Insert
	enumeration	0293042	documentation sonstiger
annotation	documentation Kat_EP_ArtikeltypKnie		
source	<pre> <simpleType name="enum_0293"> <annotation> <documentation>Kat_EP_ArtikeltypKnie</documentation> </annotation> <restriction base="xs:string"> <enumeration value="0293001"> <annotation> <documentation>Tibiakomponente</documentation> </annotation> </enumeration> <enumeration value="0293002"> <annotation> <documentation>Femurkomponente</documentation> </annotation> </enumeration> <enumeration value="0293003"> <annotation> <documentation>Patella</documentation> </annotation> </enumeration> <enumeration value="0293004"> <annotation> <documentation>Insert</documentation> </annotation> </enumeration> <enumeration value="0293005"> <annotation> <documentation>Vormontierte Tibiakomponente mit Insert</documentation> </annotation> </enumeration> <enumeration value="0293042"> <annotation> <documentation>sonstiger</documentation> </annotation> </enumeration> </restriction> </pre>		

	<code></simpleType></code>
--	----------------------------------

simpleType enum_0300

namespace	http://xml.ir-d.de/emg		
type	restriction of string		
properties	base xs:string		
used by	element OperationAortenklappeBasis/OAK ArtEingriffSchluessel		
facets	Kind	Value	Annotation
	enumeration	0300001	documentation konventioneller Aortenklappenersatz
	enumeration	0300002	documentation kathetergestützte Aortenklappenimplantation (TAVI)
annotation	documentation Kat_AK_ArtEingriff		
source	<pre> <simpleType name="enum_0300"> <annotation> <documentation>Kat_AK_ArtEingriff</documentation> </annotation> <restriction base="xs:string"> <enumeration value="0300001"> <annotation> <documentation>konventioneller Aortenklappenersatz</documentation> </annotation> </enumeration> <enumeration value="0300002"> <annotation> <documentation>kathetergestützte Aortenklappenimplantation (TAVI)</documentation> </annotation> </enumeration> </restriction> </simpleType> </pre>		

simpleType enum_0301

namespace	http://xml.ir-d.de/emg		
type	restriction of string		
properties	base xs:string		
used by	element OperationAortenklappeBasis/OAK GrundAbbruchSchluessel		
facets	Kind	Value	Annotation
	enumeration	0301001	documentation produktbezogen
	enumeration	0301002	documentation nicht-produktbezogen
annotation	documentation Kat_AK_GrundAbbruch		
source	<pre> <simpleType name="enum_0301"> <annotation> <documentation>Kat_AK_GrundAbbruch</documentation> </annotation> <restriction base="xs:string"> <enumeration value="0301001"> </pre>		

	<pre> <annotation> <documentation>produktbezogen</documentation> </annotation> </enumeration> <enumeration value="0301002"> <annotation> <documentation>nicht-produktbezogen</documentation> </annotation> </enumeration> </restriction> </simpleType> </pre>
--	---

simpleType enum_0302

namespace	http://xml.ir-d.de/emg		
type	restriction of string		
properties	base xs:string		
used by	element OperationAortenklappeBasis/OAK GrundEingriffSchluessel		
facets	Kind	Value	Annotation
	enumeration	0302001	documentation Stenose
	enumeration	0302002	documentation Insuffizienz
	enumeration	0302003	documentation Stenose und Insuffizienz
	enumeration	0302042	documentation sonstiger
annotation	documentation Kat_AK_GrundEingriff		
source	<pre> <simpleType name="enum_0302"> <annotation> <documentation>Kat_AK_GrundEingriff</documentation> </annotation> <restriction base="xs:string"> <enumeration value="0302001"> <annotation> <documentation>Stenose</documentation> </annotation> </enumeration> <enumeration value="0302002"> <annotation> <documentation>Insuffizienz</documentation> </annotation> </enumeration> <enumeration value="0302003"> <annotation> <documentation>Stenose und Insuffizienz</documentation> </annotation> </enumeration> <enumeration value="0302042"> <annotation> <documentation>sonstiger</documentation> </annotation> </enumeration> </restriction> </simpleType> </pre>		

simpleType enum 0318

namespace	http://xml.ir-d.de/emg		
type	restriction of string		
properties	base xs:string		
used by	element OperationAortenklappeBasis/OAK ZugangKatheterSchluessel		
facets	Kind	Value	Annotation
	enumeration	0318001	documentation transapikal
	enumeration	0318002	documentation transaortal
	enumeration	0318003	documentation transfemoral
	enumeration	0318004	documentation transaxillär
	enumeration	0318042	documentation anderer Zugangsweg
annotation	documentation Kat_AK_ZugangKatheter		
source	<pre> <simpleType name="enum_0318"> <annotation> <documentation>Kat_AK_ZugangKatheter</documentation> </annotation> <restriction base="xs:string"> <enumeration value="0318001"> <annotation> <documentation>transapikal</documentation> </annotation> </enumeration> <enumeration value="0318002"> <annotation> <documentation>transaortal</documentation> </annotation> </enumeration> <enumeration value="0318003"> <annotation> <documentation>transfemoral</documentation> </annotation> </enumeration> <enumeration value="0318004"> <annotation> <documentation>transaxillär</documentation> </annotation> </enumeration> <enumeration value="0318042"> <annotation> <documentation>anderer Zugangsweg</documentation> </annotation> </enumeration> </restriction> </simpleType> </pre>		

simpleType enum_0320

namespace	http://xml.ir-d.de/emg		
type	restriction of string		
properties	base xs:string		
used by	element OperationAortenklappeBasis/OAK ZugangKonventionellSchluessel		
facets	Kind	Value	Annotation
	enumeration	0320001	documentation konventionelle Sternotomie
	enumeration	0320002	documentation partielle Sternotomie
	enumeration	0320003	documentation parasternaler Zugang
	enumeration	0320042	documentation anderer Zugangsweg
annotation	documentation Kat_AK_ZugangKonventionell		
source	<pre> <simpleType name="enum_0320"> <annotation> <documentation>Kat_AK_ZugangKonventionell</documentation> </annotation> <restriction base="xs:string"> <enumeration value="0320001"> <annotation> <documentation>konventionelle Sternotomie</documentation> </annotation> </enumeration> <enumeration value="0320002"> <annotation> <documentation>partielle Sternotomie</documentation> </annotation> </enumeration> <enumeration value="0320003"> <annotation> <documentation>parasternaler Zugang</documentation> </annotation> </enumeration> <enumeration value="0320042"> <annotation> <documentation>anderer Zugangsweg</documentation> </annotation> </enumeration> </restriction> </simpleType> </pre>		

simpleType enum_0322

namespace	http://xml.ir-d.de/emg		
type	restriction of string		
properties	base xs:string		
used by	element PatientenaufnahmeKardiologieBasis/PKA DiabetesSchluessel		
facets	Kind	Value	Annotation
	enumeration	0322001	documentation nein
	enumeration	0322002	documentation

	<p>enumeration 0322003 ja, diätetisch behandelt documentation</p> <p>enumeration 0322004 ja, orale Medikation documentation</p> <p>enumeration 0322005 ja, mit Insulin behandelt documentation</p> <p>enumeration 0322099 ja, unbehandelt documentation unbekannt</p>
annotation	documentation Kat_AK_Diabetes
source	<pre> <simpleType name="enum_0322"> <annotation> <documentation>Kat_AK_Diabetes</documentation> </annotation> <restriction base="xs:string"> <enumeration value="0322001"> <annotation> <documentation>nein</documentation> </annotation> </enumeration> <enumeration value="0322002"> <annotation> <documentation>ja, diätetisch behandelt</documentation> </annotation> </enumeration> <enumeration value="0322003"> <annotation> <documentation>ja, orale Medikation</documentation> </annotation> </enumeration> <enumeration value="0322004"> <annotation> <documentation>ja, mit Insulin behandelt</documentation> </annotation> </enumeration> <enumeration value="0322005"> <annotation> <documentation>ja, unbehandelt</documentation> </annotation> </enumeration> <enumeration value="0322099"> <annotation> <documentation>unbekannt</documentation> </annotation> </enumeration> </restriction> </simpleType> </pre>

simpleType enum_0324

namespace	http://xml.ir-d.de/emg
type	restriction of string
properties	base xs:string
used by	element PatientenaufnahmeKardiologieBasis/PKA NyhaSchluessel
facets	Kind Value Annotation

	<p>enumeration 0324001 documentation (I): Beschwerdefreiheit, normale körperliche Belastbarkeit</p> <p>enumeration 0324002 documentation (II): Beschwerden bei stärkerer körperlicher Belastung</p> <p>enumeration 0324003 documentation (III): Beschwerden bei leichter körperlicher Belastung</p> <p>enumeration 0324004 documentation (IV): Beschwerden in Ruhe</p>
annotation	documentation Kat_AK_NYHA
source	<pre> <simpleType name="enum_0324"> <annotation> <documentation>Kat_AK_NYHA</documentation> </annotation> <restriction base="xs:string"> <enumeration value="0324001"> <annotation> <documentation>(I): Beschwerdefreiheit, normale körperliche Belastbarkeit</documentation> </annotation> </enumeration> <enumeration value="0324002"> <annotation> <documentation>(II): Beschwerden bei stärkerer körperlicher Belastung</documentation> </annotation> </enumeration> <enumeration value="0324003"> <annotation> <documentation>(III): Beschwerden bei leichter körperlicher Belastung</documentation> </annotation> </enumeration> <enumeration value="0324004"> <annotation> <documentation>(IV): Beschwerden in Ruhe</documentation> </annotation> </enumeration> </restriction> </simpleType> </pre>

simpleType **enum_0338**

namespace	http://xml.ir-d.de/emg		
type	restriction of string		
properties	base	xs:string	
used by	element	PciAortenklappeBasis/PCA_PciArterienSchluessel	
facets	Kind	Value	Annotation
	enumeration	0338001	documentation LAD
	enumeration	0338002	documentation RCA
	enumeration	0338003	documentation RCX
	enumeration	0338004	documentation Hauptstamm

annotation	documentation Kat_AK_PCIArterien
source	<pre> <simpleType name="enum_0338"> <annotation> <documentation>Kat_AK_PCIArterien</documentation> </annotation> <restriction base="xs:string"> <enumeration value="0338001"> <annotation> <documentation>LAD</documentation> </annotation> </enumeration> <enumeration value="0338002"> <annotation> <documentation>RCA</documentation> </annotation> </enumeration> <enumeration value="0338003"> <annotation> <documentation>RCX</documentation> </annotation> </enumeration> <enumeration value="0338004"> <annotation> <documentation>Hauptstamm</documentation> </annotation> </enumeration> </restriction> </simpleType> </pre>

simpleType enum_0339

namespace	http://xml.ir-d.de/emg		
type	restriction of string		
properties	base xs:string		
used by	element	OperationAortenklappeBasis/OAK MessmethodeSchluessel	
facets	Kind	Value	Annotation
	enumeration	0339001	documentation TEE
	enumeration	0339002	documentation CT
	enumeration	0339042	documentation andere
annotation	documentation Kat_AK_AnnulusMessmethode		
source	<pre> <simpleType name="enum_0339"> <annotation> <documentation>Kat_AK_AnnulusMessmethode</documentation> </annotation> <restriction base="xs:string"> <enumeration value="0339001"> <annotation> <documentation>TEE</documentation> </annotation> </enumeration> <enumeration value="0339002"> </pre>		

	<pre> <annotation> <documentation>CT</documentation> </annotation> </enumeration> <enumeration value="0339042"> <annotation> <documentation>andere</documentation> </annotation> </enumeration> </restriction> </simpleType> </pre>
--	---

simpleType enum_0341

namespace	http://xml.ir-d.de/emg		
type	restriction of string		
properties	base xs:string		
used by	element FailureGrundAortenklappeBasis/FAK FailureGrundSchluessel		
facets	Kind	Value	Annotation
	enumeration	0341001	documentation intraprozedural verstorben
	enumeration	0341002	documentation Implantation von mehr als einer Prothese
	enumeration	0341003	documentation gravierende Gefäß- oder Zugangskomplikation (gemäß VARC-3)
	enumeration	0341004	documentation erforderlicher chirurgischer oder interventioneller Eingriff wegen einer Klappenfehlfunktion (gemäß VARC-3)
	enumeration	0341005	documentation >= große strukturelle kardiale Komplikation (gemäß VARC-3)
annotation	documentation Kat_AK_FailureGrund		
source	<pre> <simpleType name="enum_0341"> <annotation> <documentation>Kat_AK_FailureGrund</documentation> </annotation> <restriction base="xs:string"> <enumeration value="0341001"> <annotation> <documentation>intraprozedural verstorben</documentation> </annotation> </enumeration> <enumeration value="0341002"> <annotation> <documentation>Implantation von mehr als einer Prothese</documentation> </annotation> </enumeration> <enumeration value="0341003"> <annotation> <documentation>gravierende Gefäß- oder Zugangskomplikation (gemäß VARC-3)</documentation> </annotation> </enumeration> <enumeration value="0341004"> <annotation> <documentation>erforderlicher chirurgischer oder interventioneller </pre>		

	<pre> Eingriff wegen einer Klappenfehlfunktion (gemäß VARC-3)</documentation> </annotation> </enumeration> <enumeration value="0341005"> <annotation> <documentation>&gt;= große strukturelle kardiale Komplikation (gemäß VARC-3)</documentation> </annotation> </enumeration> </restriction> </simpleType> </pre>
--	---

simpleType enum_0342

namespace	http://xml.ir-d.de/emg		
type	restriction of string		
properties	base xs:string		
used by	element TaviAortenklappeBasis/TAK GrundTaviSchlüssel		
facets	Kind	Value	Annotation
	enumeration	0342001	documentation Alter
	enumeration	0342002	documentation Frailty
	enumeration	0342003	documentation Hochrisiko
	enumeration	0342004	documentation Prognose-limitierende Zweiterkrankung
	enumeration	0342005	documentation Porzellan-Aorta
	enumeration	0342042	documentation sonstiger
annotation	documentation Kat_AK_Tavi		
source	<pre> <simpleType name="enum_0342"> <annotation> <documentation>Kat_AK_Tavi</documentation> </annotation> <restriction base="xs:string"> <enumeration value="0342001"> <annotation> <documentation>Alter</documentation> </annotation> </enumeration> <enumeration value="0342002"> <annotation> <documentation>Frailty</documentation> </annotation> </enumeration> <enumeration value="0342003"> <annotation> <documentation>Hochrisiko</documentation> </annotation> </enumeration> <enumeration value="0342004"> <annotation> <documentation>Prognose-limitierende Zweiterkrankung</documentation> </annotation> </pre>		

```

</enumeration>
<enumeration value="0342005">
  <annotation>
    <documentation>Porzellan-Aorta</documentation>
  </annotation>
</enumeration>
<enumeration value="0342042">
  <annotation>
    <documentation>sonstiger</documentation>
  </annotation>
</enumeration>
</restriction>
</simpleType>

```

simpleType **enum_0343**

namespace	http://xml.ir-d.de/emg		
type	restriction of string		
properties	base xs:string		
used by	element KomplikationAortenklappeBasis/KAK_KomplikationTypSchluessel		
facets	Kind	Value	Annotation
	enumeration	0343001	documentation Device-Fehlpositionierung
	enumeration	0343002	documentation Koronarostienverschluss
	enumeration	0343003	documentation Aortendissektion
	enumeration	0343004	documentation Aortenregurgitation > = 2. Grades
	enumeration	0343005	documentation Annulus-Ruptur
	enumeration	0343006	documentation Ruptur-/Perforation einer Herzhöhle ohne Therapiebedarf
	enumeration	0343007	documentation Ruptur-/Perforation einer Herzhöhle mit Therapiebedarf
	enumeration	0343008	documentation Perikardtamponade
	enumeration	0343009	documentation kardiale Dekompensation
	enumeration	0343010	documentation Himembolie
	enumeration	0343011	documentation Rhythmusstörungen
	enumeration	0343012	documentation Device-Embolisation
	enumeration	0343013	documentation vaskuläre Komplikation
	enumeration	0343014	documentation Low Cardiac Output
	enumeration	0343015	documentation schwerwiegende Blutungen (intraprozedural)
	enumeration	0343016	documentation lebensbedrohliche Blutungen (intraprozedural)
	enumeration	0343017	documentation Patient verstarb im OP/Katheterlabor
	enumeration	0343042	documentation sonstiger
annotation	documentation Kat_AK_KomplikationTyp		

source

```
<simpleType name="enum_0343">
  <annotation>
    <documentation>Kat_AK_KomplikationTyp</documentation>
  </annotation>
  <restriction base="xs:string">
    <enumeration value="0343001">
      <annotation>
        <documentation>Device-Fehlpositionierung</documentation>
      </annotation>
    </enumeration>
    <enumeration value="0343002">
      <annotation>
        <documentation>Koronarostienverschluss</documentation>
      </annotation>
    </enumeration>
    <enumeration value="0343003">
      <annotation>
        <documentation>Aortendissektion</documentation>
      </annotation>
    </enumeration>
    <enumeration value="0343004">
      <annotation>
        <documentation>Aortenregurgitation &gt;= 2. Grades</documentation>
      </annotation>
    </enumeration>
    <enumeration value="0343005">
      <annotation>
        <documentation>Annulus-Ruptur</documentation>
      </annotation>
    </enumeration>
    <enumeration value="0343006">
      <annotation>
        <documentation>Ruptur-/Perforation einer Herzhöhle ohne
Therapiebedarf</documentation>
      </annotation>
    </enumeration>
    <enumeration value="0343007">
      <annotation>
        <documentation>Ruptur-/Perforation einer Herzhöhle mit
Therapiebedarf</documentation>
      </annotation>
    </enumeration>
    <enumeration value="0343008">
      <annotation>
        <documentation>Perikardtamponade</documentation>
      </annotation>
    </enumeration>
    <enumeration value="0343009">
      <annotation>
        <documentation>kardiale Dekompensation</documentation>
      </annotation>
    </enumeration>
    <enumeration value="0343010">
      <annotation>
        <documentation>Hirnembolie</documentation>
      </annotation>
    </enumeration>
    <enumeration value="0343011">
      <annotation>
```

```

    <documentation>Rhythmusstörungen</documentation>
  </annotation>
</enumeration>
<enumeration value="0343012">
  <annotation>
    <documentation>Device-Embolisation</documentation>
  </annotation>
</enumeration>
<enumeration value="0343013">
  <annotation>
    <documentation>vaskuläre Komplikation</documentation>
  </annotation>
</enumeration>
<enumeration value="0343014">
  <annotation>
    <documentation>Low Cardiac Output</documentation>
  </annotation>
</enumeration>
<enumeration value="0343015">
  <annotation>
    <documentation>schwerwiegende Blutungen
(intraprozedural)</documentation>
  </annotation>
</enumeration>
<enumeration value="0343016">
  <annotation>
    <documentation>lebensbedrohliche Blutungen
(intraprozedural)</documentation>
  </annotation>
</enumeration>
<enumeration value="0343017">
  <annotation>
    <documentation>Patient verstarb im OP/Katheterlabor</documentation>
  </annotation>
</enumeration>
<enumeration value="0343042">
  <annotation>
    <documentation>sonstiger</documentation>
  </annotation>
</enumeration>
</restriction>
</simpleType>

```

simpleType **enum_0346**

namespace	http://xml.ir-d.de/emg		
type	restriction of string		
properties	base xs:string		
used by	element OperationAortenklappeBasis/OAK TherapieLcoSchluessel		
facets	Kind	Value	Annotation
	enumeration	0346001	documentation keine Therapie erforderlich
	enumeration	0346002	documentation medikamentös
	enumeration	0346003	documentation IABP

	enumeration 0346004 documentation VAD enumeration 0346005 documentation ECMO enumeration 0346042 documentation sonstige
annotation	documentation Kat_AK_TherapieLCO
source	<pre> <simpleType name="enum_0346"> <annotation> <documentation>Kat_AK_TherapieLCO</documentation> </annotation> <restriction base="xs:string"> <enumeration value="0346001"> <annotation> <documentation>keine Therapie erforderlich</documentation> </annotation> </enumeration> <enumeration value="0346002"> <annotation> <documentation>medikamentös</documentation> </annotation> </enumeration> <enumeration value="0346003"> <annotation> <documentation>IABP</documentation> </annotation> </enumeration> <enumeration value="0346004"> <annotation> <documentation>VAD</documentation> </annotation> </enumeration> <enumeration value="0346005"> <annotation> <documentation>ECMO</documentation> </annotation> </enumeration> <enumeration value="0346042"> <annotation> <documentation>sonstige</documentation> </annotation> </enumeration> </restriction> </simpleType> </pre>

simpleType enum_0347

namespace	http://xml.ir-d.de/emg		
type	restriction of string		
properties	base xs:string		
used by	element OperationAortenklappeBasis/OAK EingriffsumfangSchluessel		
facets	Kind	Value	Annotation
	enumeration	0347001	documentation Einzeleingriff
	enumeration	0347002	documentation

	Kombinationseingriff mit mehreren Prozeduren
annotation	documentation Kat_AK_Eingriffsumfang
source	<pre> <simpleType name="enum_0347"> <annotation> <documentation>Kat_AK_Eingriffsumfang</documentation> </annotation> <restriction base="xs:string"> <enumeration value="0347001"> <annotation> <documentation>Einzeleingriff</documentation> </annotation> </enumeration> <enumeration value="0347002"> <annotation> <documentation>Kombinationseingriff mit mehreren Prozeduren</documentation> </annotation> </enumeration> </restriction> </simpleType> </pre>

simpleType enum_0348

namespace	http://xml.ir-d.de/emg		
type	restriction of string		
properties	base xs:string		
used by	element OperationAortenklappeBasis/OAK VorgehenSchluessel		
facets	Kind	Value	Annotation
	enumeration	0348001	documentation mit HLM
	enumeration	0348002	documentation ohneHLM
	enumeration	0348003	documentation Umstieg von OP ohne HLM auf OP mit HLM
annotation	documentation Kat_AK_OPVorgehen		
source	<pre> <simpleType name="enum_0348"> <annotation> <documentation>Kat_AK_OPVorgehen</documentation> </annotation> <restriction base="xs:string"> <enumeration value="0348001"> <annotation> <documentation>mit HLM</documentation> </annotation> </enumeration> <enumeration value="0348002"> <annotation> <documentation>ohne HLM</documentation> </annotation> </enumeration> <enumeration value="0348003"> <annotation> <documentation>Umstieg von OP ohne HLM auf OP mit HLM</documentation> </annotation> </enumeration> </restriction> </simpleType> </pre>		

	<pre> </enumeration> </restriction> </simpleType> </pre>
--	--

simpleType enum_0350

namespace	http://xml.ir-d.de/emg		
type	restriction of string		
properties	base xs:string		
used by	elements	OperationAortenklappeBasis/OAK IntraOpMethodeSchluessel OperationAortenklappeBasis/OAK PraeOpMethodeSchluessel	
facets	Kind	Value	Annotation
	enumeration	0350001	documentation IABP
	enumeration	0350002	documentation Impella
	enumeration	0350003	documentation vv ECMO
	enumeration	0350004	documentation va ECMO
	enumeration	0350042	documentation andere
annotation	documentation Kat_AK_Methode		
source	<pre> <simpleType name="enum_0350"> <annotation> <documentation>Kat_AK_Methode</documentation> </annotation> <restriction base="xs:string"> <enumeration value="0350001"> <annotation> <documentation>IABP</documentation> </annotation> </enumeration> <enumeration value="0350002"> <annotation> <documentation>Impella</documentation> </annotation> </enumeration> <enumeration value="0350003"> <annotation> <documentation>vv ECMO</documentation> </annotation> </enumeration> <enumeration value="0350004"> <annotation> <documentation>va ECMO</documentation> </annotation> </enumeration> <enumeration value="0350042"> <annotation> <documentation>andere</documentation> </annotation> </enumeration> </restriction> </simpleType> </pre>		

simpleType enum_0351

namespace	http://xml.ir-d.de/emg		
type	restriction of string		
properties	base xs:string		
used by	element OperationAortenklappeBasis/OAK KonversionSchluessel		
facets	Kind	Value	Annotation
	enumeration	0351001	documentation nein
	enumeration	0351002	documentation ja, zu Stenotomie
	enumeration	0351003	documentation ja, zu transapikal
	enumeration	0351004	documentation ja, zu transaortal
	enumeration	0351005	documentation ja, zu transfemoral
	enumeration	0351006	documentation ja, zu transaxillär
	enumeration	0351007	documentation ja, zu anderem endovaskulären Zugang
	enumeration	0351042	documentation ja, zu anderem Zugang
annotation	documentation Kat_AK_Konversion		
source	<pre> <simpleType name="enum_0351"> <annotation> <documentation>Kat_AK_Konversion</documentation> </annotation> <restriction base="xs:string"> <enumeration value="0351001"> <annotation> <documentation>nein</documentation> </annotation> </enumeration> <enumeration value="0351002"> <annotation> <documentation>ja, zu Stenotomie</documentation> </annotation> </enumeration> <enumeration value="0351003"> <annotation> <documentation>ja, zu transapikal</documentation> </annotation> </enumeration> <enumeration value="0351004"> <annotation> <documentation>ja, zu transaortal</documentation> </annotation> </enumeration> <enumeration value="0351005"> <annotation> <documentation>ja, zu transfemoral</documentation> </annotation> </enumeration> <enumeration value="0351006"> <annotation> <documentation>ja, zu transaxillär</documentation> </annotation> </enumeration> </restriction> </simpleType> </pre>		

	<pre> </annotation> </enumeration> <enumeration value="0351007"> <annotation> <documentation>ja, zu anderem endovaskulären Zugang</documentation> </annotation> </enumeration> <enumeration value="0351042"> <annotation> <documentation>ja, zu anderem Zugang</documentation> </annotation> </enumeration> </restriction> </simpleType> </pre>
--	---

simpleType enum_0352

namespace	http://xml.ir-d.de/emg		
type	restriction of string		
properties	base xs:string		
used by	element OperationAortenklappeBasis/OAK AnaesthesieSchluessel		
facets	Kind	Value	Annotation
	enumeration	0352001	documentation nein
	enumeration	0352002	documentation ja, Intubationsnarkose
	enumeration	0352003	documentation ja, Maskenbeatmung, incl. LAMA
	enumeration	0352042	documentation ja, unbekannt welche
annotation	documentation Kat_AK_Anaesthesie		
source	<pre> <simpleType name="enum_0352"> <annotation> <documentation>Kat_AK_Anaesthesie</documentation> </annotation> <restriction base="xs:string"> <enumeration value="0352001"> <annotation> <documentation>nein</documentation> </annotation> </enumeration> <enumeration value="0352002"> <annotation> <documentation>ja, Intubationsnarkose</documentation> </annotation> </enumeration> <enumeration value="0352003"> <annotation> <documentation>ja, Maskenbeatmung, incl. LAMA</documentation> </annotation> </enumeration> <enumeration value="0352042"> <annotation> <documentation>ja, unbekannt welche</documentation> </annotation> </enumeration> </restriction> </simpleType> </pre>		

	<pre> </enumeration> </restriction> </simpleType> </pre>
--	--

simpleType enum_0353

namespace	http://xml.ir-d.de/emg		
type	restriction of string		
properties	base xs:string		
used by	element	OperationAortenklappeBasis/OAK ResidualeInsuffizienzSchlussel	
facets	Kind	Value	Annotation
	enumeration	0353001	documentation keine
	enumeration	0353002	documentation leichtgradig
	enumeration	0353003	documentation mittelgradig
	enumeration	0353004	documentation hochgradig
	enumeration	0353099	documentation nicht bestimmbar
annotation	documentation Kat_AK_ResidualeAorteninsuffizienz		
source	<pre> <simpleType name="enum_0353"> <annotation> <documentation>Kat_AK_ResidualeAorteninsuffizienz</documentation> </annotation> <restriction base="xs:string"> <enumeration value="0353001"> <annotation> <documentation>keine</documentation> </annotation> </enumeration> <enumeration value="0353002"> <annotation> <documentation>leichtgradig</documentation> </annotation> </enumeration> <enumeration value="0353003"> <annotation> <documentation>mittelgradig</documentation> </annotation> </enumeration> <enumeration value="0353004"> <annotation> <documentation>hochgradig</documentation> </annotation> </enumeration> <enumeration value="0353099"> <annotation> <documentation>nicht bestimmbar</documentation> </annotation> </enumeration> </restriction> </simpleType> </pre>		

simpleType enum_0354

namespace	http://xml.ir-d.de/emg		
type	restriction of string		
properties	base xs:string		
used by	element OperationAortenklappeBasis/OAK ZugangVerschlussSchluessel		
facets	Kind	Value	Annotation
	enumeration	0354001	documentation chirurgisch-offen
	enumeration	0354002	documentation Verschluss-System
	enumeration	0354042	documentation sonstiger
annotation	documentation Kat_AK_Zugangswegverschluss		
source	<pre> <simpleType name="enum_0354"> <annotation> <documentation>Kat_AK_Zugangswegverschluss</documentation> </annotation> <restriction base="xs:string"> <enumeration value="0354001"> <annotation> <documentation>chirurgisch-offen</documentation> </annotation> </enumeration> <enumeration value="0354002"> <annotation> <documentation>Verschluss-System</documentation> </annotation> </enumeration> <enumeration value="0354042"> <annotation> <documentation>sonstiger</documentation> </annotation> </enumeration> </restriction> </simpleType> </pre>		

simpleType enum_0357

namespace	http://xml.ir-d.de/emg		
type	restriction of string		
properties	base xs:string		
used by	element PatientenaufnahmeAortenklappeBasis/PAA BefundSchluessel		
facets	Kind	Value	Annotation
	enumeration	0357001	documentation keine KHK
	enumeration	0357002	documentation 1-Gefäßerkrankung
	enumeration	0357003	documentation 2-Gefäßerkrankung
	enumeration	0357004	documentation 3-Gefäßerkrankung
	enumeration	0357005	documentation

	keine koronare Bildgebung
annotation	documentation Kat AK BefundBildgebung
source	<pre> <simpleType name="enum_0357"> <annotation> <documentation>Kat_AK_BefundBildgebung</documentation> </annotation> <restriction base="xs:string"> <enumeration value="0357001"> <annotation> <documentation>keine KHK</documentation> </annotation> </enumeration> <enumeration value="0357002"> <annotation> <documentation>1-Gefäßerkrankung</documentation> </annotation> </enumeration> <enumeration value="0357003"> <annotation> <documentation>2-Gefäßerkrankung</documentation> </annotation> </enumeration> <enumeration value="0357004"> <annotation> <documentation>3-Gefäßerkrankung</documentation> </annotation> </enumeration> <enumeration value="0357005"> <annotation> <documentation>keine koronare Bildgebung</documentation> </annotation> </enumeration> </restriction> </simpleType> </pre>

simpleType enum_0358

namespace	http://xml.ir-d.de/emg		
type	restriction of string		
properties	base xs:string		
used by	element PatientenaufnahmeAortenklappeBasis/PAA_AnzahlVorOpSchluessel		
facets	Kind	Value	Annotation
	enumeration	0358001	documentation 0
	enumeration	0358002	documentation 1
	enumeration	0358003	documentation 2
	enumeration	0358004	documentation 3
	enumeration	0358005	documentation 4
	enumeration	0358006	documentation 5 oder mehr
	enumeration	0358098	documentation genaue Anzahl unbekannt (aber mind. 1)

	enumeration 0358099 documentation unbekannt
annotation	documentation Kat_AK_AnzahlVorOP
source	<pre> <simpleType name="enum_0358"> <annotation> <documentation>Kat_AK_AnzahlVorOP</documentation> </annotation> <restriction base="xs:string"> <enumeration value="0358001"> <annotation> <documentation>0</documentation> </annotation> </enumeration> <enumeration value="0358002"> <annotation> <documentation>1</documentation> </annotation> </enumeration> <enumeration value="0358003"> <annotation> <documentation>2</documentation> </annotation> </enumeration> <enumeration value="0358004"> <annotation> <documentation>3</documentation> </annotation> </enumeration> <enumeration value="0358005"> <annotation> <documentation>4</documentation> </annotation> </enumeration> <enumeration value="0358006"> <annotation> <documentation>5 oder mehr</documentation> </annotation> </enumeration> <enumeration value="0358098"> <annotation> <documentation>genaue Anzahl unbekannt (aber mind. 1)</documentation> </annotation> </enumeration> <enumeration value="0358099"> <annotation> <documentation>unbekannt</documentation> </annotation> </enumeration> </restriction> </simpleType> </pre>

simpleType enum_0359

namespace	http://xml.ir-d.de/emg
type	restriction of string

properties	base xs:string															
used by	element PatientenaufnahmeAortenklappeBasis/PAA LvotSchluessel															
facets	<table border="1"> <thead> <tr> <th>Kind</th> <th>Value</th> <th>Annotation</th> </tr> </thead> <tbody> <tr> <td>enumeration</td> <td>0359001</td> <td>documentation nein</td> </tr> <tr> <td>enumeration</td> <td>0359002</td> <td>documentation ja - einseitig</td> </tr> <tr> <td>enumeration</td> <td>0359003</td> <td>documentation ja - beidseitig</td> </tr> <tr> <td>enumeration</td> <td>0359042</td> <td>documentation unbekannt</td> </tr> </tbody> </table>	Kind	Value	Annotation	enumeration	0359001	documentation nein	enumeration	0359002	documentation ja - einseitig	enumeration	0359003	documentation ja - beidseitig	enumeration	0359042	documentation unbekannt
Kind	Value	Annotation														
enumeration	0359001	documentation nein														
enumeration	0359002	documentation ja - einseitig														
enumeration	0359003	documentation ja - beidseitig														
enumeration	0359042	documentation unbekannt														
annotation	documentation Kat_AK_LVOT															
source	<pre> <simpleType name="enum_0359"> <annotation> <documentation>Kat_AK_LVOT</documentation> </annotation> <restriction base="xs:string"> <enumeration value="0359001"> <annotation> <documentation>nein</documentation> </annotation> </enumeration> <enumeration value="0359002"> <annotation> <documentation>ja - einseitig</documentation> </annotation> </enumeration> <enumeration value="0359003"> <annotation> <documentation>ja - beidseitig</documentation> </annotation> </enumeration> <enumeration value="0359042"> <annotation> <documentation>unbekannt</documentation> </annotation> </enumeration> </restriction> </simpleType> </pre>															

simpleType enum 0360

namespace	http://xml.ir-d.de/emg															
type	restriction of string															
properties	base xs:string															
used by	elements PatientenaufnahmeAortenklappeBasis/PAA TrikuspidalinsuffizienzSchluessel PostoperationAortenklappeBasis/POA TrikuspidalinsuffizienzSchluessel															
facets	<table border="1"> <thead> <tr> <th>Kind</th> <th>Value</th> <th>Annotation</th> </tr> </thead> <tbody> <tr> <td>enumeration</td> <td>0360001</td> <td>documentation keine</td> </tr> <tr> <td>enumeration</td> <td>0360002</td> <td>documentation leichtgradig</td> </tr> <tr> <td>enumeration</td> <td>0360003</td> <td>documentation mittelgradig</td> </tr> <tr> <td>enumeration</td> <td>0360004</td> <td>documentation hochgradig</td> </tr> </tbody> </table>	Kind	Value	Annotation	enumeration	0360001	documentation keine	enumeration	0360002	documentation leichtgradig	enumeration	0360003	documentation mittelgradig	enumeration	0360004	documentation hochgradig
Kind	Value	Annotation														
enumeration	0360001	documentation keine														
enumeration	0360002	documentation leichtgradig														
enumeration	0360003	documentation mittelgradig														
enumeration	0360004	documentation hochgradig														

	enumeration 0360005 documentation massive enumeration 0360006 documentation torrential enumeration 0360099 documentation unbekannt
annotation	documentation Kat_AK_TriskupidallInsuffizienz
source	<pre> <simpleType name="enum_0360"> <annotation> <documentation>Kat_AK_TriskupidallInsuffizienz</documentation> </annotation> <restriction base="xs:string"> <enumeration value="0360001"> <annotation> <documentation>keine</documentation> </annotation> </enumeration> <enumeration value="0360002"> <annotation> <documentation>leichtgradig</documentation> </annotation> </enumeration> <enumeration value="0360003"> <annotation> <documentation>mittelgradig</documentation> </annotation> </enumeration> <enumeration value="0360004"> <annotation> <documentation>hochgradig</documentation> </annotation> </enumeration> <enumeration value="0360005"> <annotation> <documentation>massive</documentation> </annotation> </enumeration> <enumeration value="0360006"> <annotation> <documentation>torrential</documentation> </annotation> </enumeration> <enumeration value="0360099"> <annotation> <documentation>unbekannt</documentation> </annotation> </enumeration> </restriction> </simpleType> </pre>

simpleType enum_0361

namespace	http://xml.ir-d.de/emg
type	restriction of string
properties	base xs:string

used by	elements PatientenaufnahmeAortenklappeBasis/PAA DekompensationSchluessel PatientenaufnahmeAortenklappeBasis/PAA ReanimationSchluessel																					
facets	<table border="1"> <thead> <tr> <th>Kind</th> <th>Value</th> <th>Annotation</th> </tr> </thead> <tbody> <tr> <td>enumeration</td> <td>0361001</td> <td>documentation nein</td> </tr> <tr> <td>enumeration</td> <td>0361002</td> <td>documentation ja, letzte(r) innerhalb der letzten 48 Stunden</td> </tr> <tr> <td>enumeration</td> <td>0361003</td> <td>documentation ja, letzte(r) innerhalb der letzten 21 Tage</td> </tr> <tr> <td>enumeration</td> <td>0361004</td> <td>documentation ja, letzte(r) länger als 21 Tage</td> </tr> <tr> <td>enumeration</td> <td>0361098</td> <td>documentation ja, letzter Zeitpunkt unbekannt</td> </tr> <tr> <td>enumeration</td> <td>0361099</td> <td>documentation unbekannt</td> </tr> </tbody> </table>	Kind	Value	Annotation	enumeration	0361001	documentation nein	enumeration	0361002	documentation ja, letzte(r) innerhalb der letzten 48 Stunden	enumeration	0361003	documentation ja, letzte(r) innerhalb der letzten 21 Tage	enumeration	0361004	documentation ja, letzte(r) länger als 21 Tage	enumeration	0361098	documentation ja, letzter Zeitpunkt unbekannt	enumeration	0361099	documentation unbekannt
Kind	Value	Annotation																				
enumeration	0361001	documentation nein																				
enumeration	0361002	documentation ja, letzte(r) innerhalb der letzten 48 Stunden																				
enumeration	0361003	documentation ja, letzte(r) innerhalb der letzten 21 Tage																				
enumeration	0361004	documentation ja, letzte(r) länger als 21 Tage																				
enumeration	0361098	documentation ja, letzter Zeitpunkt unbekannt																				
enumeration	0361099	documentation unbekannt																				
annotation	documentation Kat_AK_SchockReanimation																					
source	<pre> <simpleType name="enum_0361"> <annotation> <documentation>Kat_AK_SchockReanimation</documentation> </annotation> <restriction base="xs:string"> <enumeration value="0361001"> <annotation> <documentation>nein</documentation> </annotation> </enumeration> <enumeration value="0361002"> <annotation> <documentation>ja, letzte(r) innerhalb der letzten 48 Stunden</documentation> </annotation> </enumeration> <enumeration value="0361003"> <annotation> <documentation>ja, letzte(r) innerhalb der letzten 21 Tage</documentation> </annotation> </enumeration> <enumeration value="0361004"> <annotation> <documentation>ja, letzte(r) länger als 21 Tage</documentation> </annotation> </enumeration> <enumeration value="0361098"> <annotation> <documentation>ja, letzter Zeitpunkt unbekannt</documentation> </annotation> </enumeration> <enumeration value="0361099"> <annotation> <documentation>unbekannt</documentation> </annotation> </enumeration> </restriction> </simpleType> </pre>																					

simpleType enum_0362

namespace	http://xml.ir-d.de/emg		
type	restriction of string		
properties	base xs:string		
used by	element PatientenaufnahmeAortenklappeBasis/PAA_HerzrhythmusSchluessel		
facets	Kind	Value	Annotation
	enumeration	0362001	documentation Sinusrhythmus
	enumeration	0362002	documentation Vorhofflimmern
	enumeration	0362042	documentation anderer Herzrhythmus
annotation	documentation Kat_AK_Herzrhythmus		
source	<pre> <simpleType name="enum_0362"> <annotation> <documentation>Kat_AK_Herzrhythmus</documentation> </annotation> <restriction base="xs:string"> <enumeration value="0362001"> <annotation> <documentation>Sinusrhythmus</documentation> </annotation> </enumeration> <enumeration value="0362002"> <annotation> <documentation>Vorhofflimmern</documentation> </annotation> </enumeration> <enumeration value="0362042"> <annotation> <documentation>anderer Herzrhythmus</documentation> </annotation> </enumeration> </restriction> </simpleType> </pre>		

simpleType enum_0363

namespace	http://xml.ir-d.de/emg		
type	restriction of string		
properties	base xs:string		
used by	element PatientenaufnahmeAortenklappeBasis/PAA_VorhofflimmernSchluessel		
facets	Kind	Value	Annotation
	enumeration	0363001	documentation nein
	enumeration	0363002	documentation paroxysmal
	enumeration	0363003	documentation persistierend
	enumeration	0363004	documentation permanent
annotation	documentation Kat_AK_Vorhofflimmern		

source	<pre> <simpleType name="enum_0363"> <annotation> <documentation>Kat_AK_Vorhofflimmern</documentation> </annotation> <restriction base="xs:string"> <enumeration value="0363001"> <annotation> <documentation>nein</documentation> </annotation> </enumeration> <enumeration value="0363002"> <annotation> <documentation>paroxysmal</documentation> </annotation> </enumeration> <enumeration value="0363003"> <annotation> <documentation>persistierend</documentation> </annotation> </enumeration> <enumeration value="0363004"> <annotation> <documentation>permanent</documentation> </annotation> </enumeration> </restriction> </simpleType> </pre>
--------	--

simpleType enum_0364

namespace	http://xml.lir-d.de/emg		
type	restriction of string		
properties	base xs:string		
used by	elements PatientenaufnahmeAortenklappeBasis/PAA SchrittmacherSchluessel PostoperationAortenklappeBasis/POA SchrittmacherSchluessel		
facets	Kind	Value	Annotation
	enumeration	0364001	documentation nein
	enumeration	0364002	documentation Schrittmacher ohne CRT-System
	enumeration	0364003	documentation Schrittmacher mit CRT-System
	enumeration	0364004	documentation Defibrillator ohne CRT-System
	enumeration	0364005	documentation Defibrillator mit CRT-System
annotation	documentation Kat_AK_SchrittmacherDefi		
source	<pre> <simpleType name="enum_0364"> <annotation> <documentation>Kat_AK_SchrittmacherDefi</documentation> </annotation> <restriction base="xs:string"> <enumeration value="0364001"> <annotation> <documentation>nein</documentation> </annotation> </pre>		

	<pre> </enumeration> <enumeration value="0364002"> <annotation> <documentation>Schrittmacher ohne CRT-System</documentation> </annotation> </enumeration> <enumeration value="0364003"> <annotation> <documentation>Schrittmacher mit CRT-System</documentation> </annotation> </enumeration> <enumeration value="0364004"> <annotation> <documentation>Defibrillator ohne CRT-System</documentation> </annotation> </enumeration> <enumeration value="0364005"> <annotation> <documentation>Defibrillator mit CRT-System</documentation> </annotation> </enumeration> </restriction> </simpleType> </pre>
--	--

simpleType enum_0365

namespace	http://xml.ir-d.de/emg		
type	restriction of string		
properties	base xs:string		
used by	element	PatientenaufnahmeAortenklappeBasis/PAA RevaskularisationSchluessel	
facets	Kind	Value	Annotation
	enumeration	0365001	documentation nein
	enumeration	0365002	documentation ja, operativ
	enumeration	0365003	documentation ja, interventionell
annotation	documentation Kat_AK_MyokardRevaskularisation		
source	<pre> <simpleType name="enum_0365"> <annotation> <documentation>Kat_AK_MyokardRevaskularisation</documentation> </annotation> <restriction base="xs:string"> <enumeration value="0365001"> <annotation> <documentation>nein</documentation> </annotation> </enumeration> <enumeration value="0365002"> <annotation> <documentation>ja, operativ</documentation> </annotation> </enumeration> <enumeration value="0365003"> <annotation> </pre>		

	<pre> <documentation>ja, interventionell</documentation> </annotation> </enumeration> </restriction> </simpleType> </pre>
--	---

simpleType enum_0366

namespace	http://xml.ir-d.de/emg		
type	restriction of string		
properties	base xs:string		
used by	element PatientenaufnahmeAortenklappeBasis/PAA PciSchluessel		
facets	Kind	Value	Annotation
	enumeration	0366001	documentation nein
	enumeration	0366002	documentation ja, <= 6 Stunden
	enumeration	0366003	documentation ja, > 6 Stunden bis <= 3 Monate
	enumeration	0366004	documentation ja, > 3 Monate
	enumeration	0366099	documentation unbekannt
annotation	documentation Kat_AK_PCI		
source	<pre> <simpleType name="enum_0366"> <annotation> <documentation>Kat_AK_PCI</documentation> </annotation> <restriction base="xs:string"> <enumeration value="0366001"> <annotation> <documentation>nein</documentation> </annotation> </enumeration> <enumeration value="0366002"> <annotation> <documentation>ja, &lt;= 6 Stunden</documentation> </annotation> </enumeration> <enumeration value="0366003"> <annotation> <documentation>ja, &gt; 6 Stunden bis &lt;= 3 Monate</documentation> </annotation> </enumeration> <enumeration value="0366004"> <annotation> <documentation>ja, &gt; 3 Monate</documentation> </annotation> </enumeration> <enumeration value="0366099"> <annotation> <documentation>unbekannt</documentation> </annotation> </enumeration> </restriction> </pre>		

</simpleType>

simpleType enum_0367

namespace	http://xml.ir-d.de/emg		
type	restriction of string		
properties	base xs:string		
used by	element InfektionAortenklappeBasis/IAK InfektionSchluessel		
facets	Kind	Value	Annotation
	enumeration	0367001	documentation keine
	enumeration	0367002	documentation Mediastinitis
	enumeration	0367003	documentation Sepsis
	enumeration	0367004	documentation broncho-pulmonale Infektion
	enumeration	0367005	documentation oto-laryngologische Infektion
	enumeration	0367006	documentation floride Endokarditis
	enumeration	0367007	documentation Peritonitis
	enumeration	0367008	documentation Wundinfektion Thorax
	enumeration	0367009	documentation Pleuraempyem
	enumeration	0367010	documentation Venenkatheterinfektion
	enumeration	0367011	documentation Harnwegsinfektion
	enumeration	0367012	documentation Wundinfektion untere Extremitäten
	enumeration	0367013	documentation HIV-Infektion
	enumeration	0367014	documentation Hepatitis B oder C
	enumeration	0367015	documentation andere Wundinfektion
	enumeration	0367042	documentation sonstige
annotation	documentation Kat_AK_Infektion		
source	<pre><simpleType name="enum_0367"> <annotation> <documentation>Kat_AK_Infektion</documentation> </annotation> <restriction base="xs:string"> <enumeration value="0367001"> <annotation> <documentation>keine</documentation> </annotation> </enumeration> <enumeration value="0367002"> <annotation> <documentation>Mediastinitis</documentation> </annotation> </enumeration> <enumeration value="0367003"></pre>		

```
<annotation>
  <documentation>Sepsis</documentation>
</annotation>
</enumeration>
<enumeration value="0367004">
  <annotation>
    <documentation>broncho-pulmonale Infektion</documentation>
  </annotation>
</enumeration>
<enumeration value="0367005">
  <annotation>
    <documentation>oto-laryngologische Infektion</documentation>
  </annotation>
</enumeration>
<enumeration value="0367006">
  <annotation>
    <documentation>floride Endokarditis</documentation>
  </annotation>
</enumeration>
<enumeration value="0367007">
  <annotation>
    <documentation>Peritonitis</documentation>
  </annotation>
</enumeration>
<enumeration value="0367008">
  <annotation>
    <documentation>Wundinfektion Thorax</documentation>
  </annotation>
</enumeration>
<enumeration value="0367009">
  <annotation>
    <documentation>Pleuraempyem</documentation>
  </annotation>
</enumeration>
<enumeration value="0367010">
  <annotation>
    <documentation>Venenkatheterinfektion</documentation>
  </annotation>
</enumeration>
<enumeration value="0367011">
  <annotation>
    <documentation>Harnwegsinfektion</documentation>
  </annotation>
</enumeration>
<enumeration value="0367012">
  <annotation>
    <documentation>Wundinfektion untere Extremitäten</documentation>
  </annotation>
</enumeration>
<enumeration value="0367013">
  <annotation>
    <documentation>HIV-Infektion</documentation>
  </annotation>
</enumeration>
<enumeration value="0367014">
  <annotation>
    <documentation>Hepatitis B oder C</documentation>
  </annotation>
</enumeration>
```

	<pre> <enumeration value="0367015"> <annotation> <documentation>andere Wundinfektion</documentation> </annotation> </enumeration> <enumeration value="0367042"> <annotation> <documentation>sonstige</documentation> </annotation> </enumeration> </restriction> </simpleType> </pre>
--	---

simpleType enum_0368

namespace	http://xml.ir-d.de/emg		
type	restriction of string		
properties	base xs:string		
used by	element PatientenaufnahmeAortenklappeBasis/PAA LungenerkrankungSchluessel		
facets	Kind	Value	Annotation
	enumeration	0368001	documentation nein
	enumeration	0368002	documentation ja, COPD mit Dauermedikation
	enumeration	0368003	documentation ja, COPD ohne Dauermedikation
	enumeration	0368004	documentation ja, andere Lungenerkrankungen
	enumeration	0368099	documentation unbekannt
annotation	documentation Kat_AK_Lungenerkrankung		
source	<pre> <simpleType name="enum_0368"> <annotation> <documentation>Kat_AK_Lungenerkrankung</documentation> </annotation> <restriction base="xs:string"> <enumeration value="0368001"> <annotation> <documentation>nein</documentation> </annotation> </enumeration> <enumeration value="0368002"> <annotation> <documentation>ja, COPD mit Dauermedikation</documentation> </annotation> </enumeration> <enumeration value="0368003"> <annotation> <documentation>ja, COPD ohne Dauermedikation</documentation> </annotation> </enumeration> <enumeration value="0368004"> <annotation> <documentation>ja, andere Lungenerkrankungen</documentation> </annotation> </enumeration> </restriction> </simpleType> </pre>		

	<pre> </enumeration> <enumeration value="0368099"> <annotation> <documentation>unbekannt</documentation> </annotation> </enumeration> </restriction> </simpleType> </pre>
--	---

simpleType enum_0369

namespace	http://xml.ir-d.de/emg		
type	restriction of string		
properties	base xs:string		
used by	element PatientenaufnahmeKardiologieBasis/PKA NierenersatzSchluessel		
facets	Kind	Value	Annotation
	enumeration	0369001	documentation nein
	enumeration	0369002	documentation akut
	enumeration	0369003	documentation chronisch
annotation	documentation Kat_AK_Nierenersatztherapie		
source	<pre> <simpleType name="enum_0369"> <annotation> <documentation>Kat_AK_Nierenersatztherapie</documentation> </annotation> <restriction base="xs:string"> <enumeration value="0369001"> <annotation> <documentation>nein</documentation> </annotation> </enumeration> <enumeration value="0369002"> <annotation> <documentation>akut</documentation> </annotation> </enumeration> <enumeration value="0369003"> <annotation> <documentation>chronisch</documentation> </annotation> </enumeration> </restriction> </simpleType> </pre>		

simpleType enum_0370

namespace	http://xml.ir-d.de/emg		
type	restriction of string		
properties	base xs:string		
used by	element PatientenaufnahmeAortenklappeBasis/PAA AkoefMethodeSchluessel		

facets	<table border="1"> <thead> <tr> <th>Kind</th> <th>Value</th> <th>Annotation</th> </tr> </thead> <tbody> <tr> <td>enumeration</td> <td>0370001</td> <td>documentation Echokardiographie</td> </tr> <tr> <td>enumeration</td> <td>0370002</td> <td>documentation Herzkatheter</td> </tr> <tr> <td>enumeration</td> <td>0370042</td> <td>documentation andere</td> </tr> </tbody> </table>	Kind	Value	Annotation	enumeration	0370001	documentation Echokardiographie	enumeration	0370002	documentation Herzkatheter	enumeration	0370042	documentation andere
Kind	Value	Annotation											
enumeration	0370001	documentation Echokardiographie											
enumeration	0370002	documentation Herzkatheter											
enumeration	0370042	documentation andere											
annotation	documentation Kat_AK_AKOEFMessmethode												
source	<pre> <simpleType name="enum_0370"> <annotation> <documentation>Kat_AK_AKOEFMessmethode</documentation> </annotation> <restriction base="xs:string"> <enumeration value="0370001"> <annotation> <documentation>Echokardiographie</documentation> </annotation> </enumeration> <enumeration value="0370002"> <annotation> <documentation>Herzkatheter</documentation> </annotation> </enumeration> <enumeration value="0370042"> <annotation> <documentation>andere</documentation> </annotation> </enumeration> </restriction> </simpleType> </pre>												

simpleType enum_0371

namespace	http://xml.ir-d.de/emg																		
type	restriction of string																		
properties	base xs:string																		
used by	element PatientenaufnahmeAortenklappeBasis/PAA VerkalkungsgradSchluessel																		
facets	<table border="1"> <thead> <tr> <th>Kind</th> <th>Value</th> <th>Annotation</th> </tr> </thead> <tbody> <tr> <td>enumeration</td> <td>0371001</td> <td>documentation keine</td> </tr> <tr> <td>enumeration</td> <td>0371002</td> <td>documentation leicht</td> </tr> <tr> <td>enumeration</td> <td>0371003</td> <td>documentation mittel</td> </tr> <tr> <td>enumeration</td> <td>0371004</td> <td>documentation schwer</td> </tr> <tr> <td>enumeration</td> <td>0371099</td> <td>documentation unbekannt</td> </tr> </tbody> </table>	Kind	Value	Annotation	enumeration	0371001	documentation keine	enumeration	0371002	documentation leicht	enumeration	0371003	documentation mittel	enumeration	0371004	documentation schwer	enumeration	0371099	documentation unbekannt
Kind	Value	Annotation																	
enumeration	0371001	documentation keine																	
enumeration	0371002	documentation leicht																	
enumeration	0371003	documentation mittel																	
enumeration	0371004	documentation schwer																	
enumeration	0371099	documentation unbekannt																	
annotation	documentation Kat_AK_Verkalkungsgrad																		
source	<pre> <simpleType name="enum_0371"> <annotation> <documentation>Kat_AK_Verkalkungsgrad</documentation> </annotation> <restriction base="xs:string"> <enumeration value="0371001"> </pre>																		

	<pre> <annotation> <documentation>keine</documentation> </annotation> </enumeration> <enumeration value="0371002"> <annotation> <documentation>leicht</documentation> </annotation> </enumeration> <enumeration value="0371003"> <annotation> <documentation>mittel</documentation> </annotation> </enumeration> <enumeration value="0371004"> <annotation> <documentation>schwer</documentation> </annotation> </enumeration> <enumeration value="0371099"> <annotation> <documentation>unbekannt</documentation> </annotation> </enumeration> </restriction> </simpleType> </pre>
--	---

simpleType enum_0372

namespace	http://xml.ir-d.de/emg		
type	restriction of string		
properties	base xs:string		
used by	element	PatientenaufnahmeAortenklappeBasis/PAA BiUnicuspideKlappeSchluessel	
facets	Kind	Value	Annotation
	enumeration	0372001	documentation nein
	enumeration	0372002	documentation ja, bicuspide
	enumeration	0372003	documentation ja, unicuspide
	enumeration	0372099	documentation unbekannt
annotation	documentation	Kat_AK_BiUnicuspideKlappe	
source	<pre> <simpleType name="enum_0372"> <annotation> <documentation>Kat_AK_BiUnicuspideKlappe</documentation> </annotation> <restriction base="xs:string"> <enumeration value="0372001"> <annotation> <documentation>nein</documentation> </annotation> </enumeration> <enumeration value="0372002"> <annotation> </pre>		

	<pre> <documentation>ja, bicuspide</documentation> </annotation> </enumeration> <enumeration value="0372003"> <annotation> <documentation>ja, unicuspide</documentation> </annotation> </enumeration> <enumeration value="0372099"> <annotation> <documentation>unbekannt</documentation> </annotation> </enumeration> </restriction> </simpleType> </pre>
--	--

simpleType enum 0373

namespace	http://xml.ir-d.de/emg		
type	restriction of string		
properties	base xs:string		
used by	elements	PatientenaufnahmeAortenklappeBasis/PAA AorteninsuffizienzSchluessel PatientenaufnahmeAortenklappeBasis/PAA AortenstenoseSchluessel PatientenaufnahmeAortenklappeBasis/PAA MitralinsuffizienzSchluessel PostoperationAortenklappeBasis/POA AorteninsuffizienzSchluessel PostoperationAortenklappeBasis/POA MitralinsuffizienzSchluessel	
facets	Kind	Value	Annotation
	enumeration	0373001	documentation keine
	enumeration	0373002	documentation leichtgradig
	enumeration	0373003	documentation mittelgradig
	enumeration	0373004	documentation hochgradig
	enumeration	0373099	documentation unbekannt
annotation	documentation	Kat_AK_Grad	
source	<pre> <simpleType name="enum_0373"> <annotation> <documentation>Kat_AK_Grad</documentation> </annotation> <restriction base="xs:string"> <enumeration value="0373001"> <annotation> <documentation>keine</documentation> </annotation> </enumeration> <enumeration value="0373002"> <annotation> <documentation>leichtgradig</documentation> </annotation> </enumeration> <enumeration value="0373003"> <annotation> <documentation>mittelgradig</documentation> </pre>		

	<pre> </annotation> </enumeration> <enumeration value="0373004"> <annotation> <documentation>hochgradig</documentation> </annotation> </enumeration> <enumeration value="0373099"> <annotation> <documentation>unbekannt</documentation> </annotation> </enumeration> </restriction> </simpleType> </pre>
--	---

simpleType enum_0374

namespace	http://xml.lir-d.de/emg		
type	restriction of string		
properties	base xs:string		
used by	element PatientenaufnahmeAortenklappeBasis/PAA MyokardinfarktSchluessel		
facets	Kind	Value	Annotation
	enumeration	0374001	documentation nein
	enumeration	0374002	documentation ja, <= 6 Stunden
	enumeration	0374003	documentation ja, > 6 Stunden bis <= 24 Stunden
	enumeration	0374004	documentation ja, > 1 bis 7 Tage
	enumeration	0374005	documentation ja, > 7 bis 21 Tage
	enumeration	0374006	documentation ja, > 21 Tage
	enumeration	0374099	documentation unbekannt
annotation	documentation Kat_AK_InfarktAnamnese		
source	<pre> <simpleType name="enum_0374"> <annotation> <documentation>Kat_AK_InfarktAnamnese</documentation> </annotation> <restriction base="xs:string"> <enumeration value="0374001"> <annotation> <documentation>nein</documentation> </annotation> </enumeration> <enumeration value="0374002"> <annotation> <documentation>ja, &lt;= 6 Stunden</documentation> </annotation> </enumeration> <enumeration value="0374003"> <annotation> <documentation>ja, &gt; 6 Stunden bis &lt;= 24 Stunden</documentation> </pre>		

	<pre> </annotation> </enumeration> <enumeration value="0374004"> <annotation> <documentation>ja, &gt; 1 bis 7 Tage</documentation> </annotation> </enumeration> <enumeration value="0374005"> <annotation> <documentation>ja, &gt; 7 bis 21 Tage</documentation> </annotation> </enumeration> <enumeration value="0374006"> <annotation> <documentation>ja, &gt; 21 Tage</documentation> </annotation> </enumeration> <enumeration value="0374099"> <annotation> <documentation>unbekannt</documentation> </annotation> </enumeration> </restriction> </simpleType> </pre>
--	--

simpleType enum_0375

namespace	http://xml.ir-d.de/emg		
type	restriction of string		
properties	base xs:string		
used by	element	PatientenaufnahmeAortenklappeBasis/PAA_SymptomeSchluessel	
facets	Kind	Value	Annotation
	enumeration	0375001	documentation keine Symptome oder Angina
	enumeration	0375002	documentation Symptome, aber keine Ischämiezeichen
	enumeration	0375003	documentation stabile Angina
	enumeration	0375004	documentation instabile Angina
	enumeration	0375005	documentation Infarkt ohne ST-Hebung (Non-STEMI)
	enumeration	0375006	documentation Infarkt mit ST-Hebung (STEMI)
	enumeration	0375042	documentation unbekannt
annotation	documentation Kat_AK_KardialeSymptome		
source	<pre> <simpleType name="enum_0375"> <annotation> <documentation>Kat_AK_KardialeSymptome</documentation> </annotation> <restriction base="xs:string"> <enumeration value="0375001"> <annotation> <documentation>keine Symptome oder Angina</documentation> </annotation> </pre>		

```

</enumeration>
<enumeration value="0375002">
  <annotation>
    <documentation>Symptome, aber keine Ischämiezeichen</documentation>
  </annotation>
</enumeration>
<enumeration value="0375003">
  <annotation>
    <documentation>stabile Angina</documentation>
  </annotation>
</enumeration>
<enumeration value="0375004">
  <annotation>
    <documentation>instabile Angina</documentation>
  </annotation>
</enumeration>
<enumeration value="0375005">
  <annotation>
    <documentation>Infarkt ohne ST-Hebung (Non-STEMI)</documentation>
  </annotation>
</enumeration>
<enumeration value="0375006">
  <annotation>
    <documentation>Infarkt mit ST-Hebung (STEMI)</documentation>
  </annotation>
</enumeration>
<enumeration value="0375042">
  <annotation>
    <documentation>unbekannt</documentation>
  </annotation>
</enumeration>
</restriction>
</simpleType>

```

simpleType enum_0376

namespace	http://xml.lir-d.de/emg		
type	restriction of string		
properties	base xs:string		
used by	element	PostoperationAortenklappeBasis/POA SchlaganfallSchluessel	
facets	Kind	Value	Annotation
	enumeration	0376001	documentation nein
	enumeration	0376002	documentation ja, ZNS, zerebrovaskuläre Blutung
	enumeration	0376003	documentation ja, ZNS, zerebrovaskuläre Ischämie
	enumeration	0376042	documentation ja, ZNS, andere
annotation	documentation Kat_AK_Schlaganfall		
source	<pre> <simpleType name="enum_0376"> <annotation> <documentation>Kat_AK_Schlaganfall</documentation> </annotation> <restriction base="xs:string"> </pre>		

	<pre> <enumeration value="0376001"> <annotation> <documentation>nein</documentation> </annotation> </enumeration> <enumeration value="0376002"> <annotation> <documentation>ja, ZNS, zerebrovaskuläre Blutung</documentation> </annotation> </enumeration> <enumeration value="0376003"> <annotation> <documentation>ja, ZNS, zerebrovaskuläre Ischämie</documentation> </annotation> </enumeration> <enumeration value="0376042"> <annotation> <documentation>ja, ZNS, andere</documentation> </annotation> </enumeration> </restriction> </simpleType> </pre>
--	---

simpleType enum_0377

namespace	http://xml.ir-d.de/emg		
type	restriction of string		
properties	base xs:string		
used by	element	PostoperationAortenklappeBasis/POA_NihssSchluessel	
facets	Kind	Value	Annotation
	enumeration	0377001	documentation ja, mild neurological dysfunction: NIHSS 0-5
	enumeration	0377002	documentation ja, moderate neurological dysfunction: NIHSS 6-14
	enumeration	0377003	documentation ja, severe neurological dysfunction: NIHSS >=15
annotation	documentation Kat_AK_Nihss		
source	<pre> <simpleType name="enum_0377"> <annotation> <documentation>Kat_AK_Nihss</documentation> </annotation> <restriction base="xs:string"> <enumeration value="0377001"> <annotation> <documentation>ja, mild neurological dysfunction: NIHSS 0-5</documentation> </annotation> </enumeration> <enumeration value="0377002"> <annotation> <documentation>ja, moderate neurological dysfunction: NIHSS 6-14</documentation> </annotation> </enumeration> <enumeration value="0377003"> </pre>		

	<pre> <annotation> <documentation>ja, severe neurological dysfunction: NIHSS &gt;=15</documentation> </annotation> </enumeration> </restriction> </simpleType> </pre>
--	---

simpleType enum_0378

namespace	http://xml.ir-d.de/emg		
type	restriction of string		
properties	base xs:string		
used by	element	PostoperationAortenklappeBasis/POA MyokardinfarktSchlüssel	
facets	Kind	Value	Annotation
	enumeration	0378001	documentation nein
	enumeration	0378002	documentation ja, < 48h gemäss VARC-3-Definition
	enumeration	0378003	documentation ja, >= 48h - <= 72h gemäß VARC-3-Definition
	enumeration	0378004	documentation ja, > 72 h gemäß VARC-3 Definition
annotation	documentation Kat AK Myokardinfarkt		
source	<pre> <simpleType name="enum_0378"> <annotation> <documentation>Kat_AK_Myokardinfarkt</documentation> </annotation> <restriction base="xs:string"> <enumeration value="0378001"> <annotation> <documentation>nein</documentation> </annotation> </enumeration> <enumeration value="0378002"> <annotation> <documentation>ja, &lt; 48h gemäss VARC-3-Definition</documentation> </annotation> </enumeration> <enumeration value="0378003"> <annotation> <documentation>ja, &gt;= 48h - &lt;= 72h gemäß VARC-3- Definition</documentation> </annotation> </enumeration> <enumeration value="0378004"> <annotation> <documentation>ja, &gt; 72 h gemäß VARC-3 Definition</documentation> </annotation> </enumeration> </restriction> </simpleType> </pre>		

simpleType enum_0379

namespace	http://xml.ir-d.de/emg		
type	restriction of string		
properties	base xs:string		
used by	element PostoperationAortenklappeBasis/POA ZugangKomplikationenSchluessel		
facets	Kind	Value	Annotation
	enumeration	0379001	documentation Keine gefäss- oder zugangsassoziierte Komplikationen
	enumeration	0379002	documentation Versagen des perkutanen Verschlusssystems
	enumeration	0379003	documentation Geringfügige Gefäßkomplikationen
	enumeration	0379004	documentation Erhebliche Gefäßkomplikationen
annotation	documentation Kat_AK_ZugangKomplikationen		
source	<pre> <simpleType name="enum_0379"> <annotation> <documentation>Kat_AK_ZugangKomplikationen</documentation> </annotation> <restriction base="xs:string"> <enumeration value="0379001"> <annotation> <documentation>Keine gefäss- oder zugangsassoziierte Komplikationen</documentation> </annotation> </enumeration> <enumeration value="0379002"> <annotation> <documentation>Versagen des perkutanen Verschlusssystems</documentation> </annotation> </enumeration> <enumeration value="0379003"> <annotation> <documentation>Geringfügige Gefäßkomplikationen</documentation> </annotation> </enumeration> <enumeration value="0379004"> <annotation> <documentation>Erhebliche Gefäßkomplikationen</documentation> </annotation> </enumeration> </restriction> </simpleType> </pre>		

simpleType enum_0380

namespace	http://xml.ir-d.de/emg		
type	restriction of string		
properties	base xs:string		
used by	element PostoperationAortenklappeBasis/POA ReanimationSchluessel		
facets	Kind	Value	Annotation
	enumeration	0380001	documentation

	enumeration 0380002 nein documentation ja, intraprozedural enumeration 0380003 documentation ja, postprozedural enumeration 0380004 documentation ja, Zeitpunkt nicht bekannt
annotation	documentation Kat_AK_Reanimation
source	<pre> <simpleType name="enum_0380"> <annotation> <documentation>Kat_AK_Reanimation</documentation> </annotation> <restriction base="xs:string"> <enumeration value="0380001"> <annotation> <documentation>nein</documentation> </annotation> </enumeration> <enumeration value="0380002"> <annotation> <documentation>ja, intraprozedural</documentation> </annotation> </enumeration> <enumeration value="0380003"> <annotation> <documentation>ja, postprozedural</documentation> </annotation> </enumeration> <enumeration value="0380004"> <annotation> <documentation>ja, Zeitpunkt nicht bekannt</documentation> </annotation> </enumeration> </restriction> </simpleType> </pre>

simpleType enum_0381

namespace	http://xml.ir-d.de/emg		
type	restriction of string		
properties	base xs:string		
used by	element PostoperationAortenklappeBasis/POA MassnahmenSchluessel		
facets	Kind	Value	Annotation
	enumeration	0381001	documentation nein
	enumeration	0381002	documentation Thorakotomie/Rethorakotomie
	enumeration	0381003	documentation kathetergestützte Reintervention
	enumeration	0381004	documentation lokale Reinterventionen
	enumeration	0381005	documentation andere Reintervention
annotation	documentation Kat_AK_Massnahmen		
source	<pre> <simpleType name="enum_0381"> </pre>		

```

<annotation>
  <documentation>Kat_AK_Massnahmen</documentation>
</annotation>
<restriction base="xs:string">
  <enumeration value="0381001">
    <annotation>
      <documentation>nein</documentation>
    </annotation>
  </enumeration>
  <enumeration value="0381002">
    <annotation>
      <documentation>Thorakotomie/Rethorakotomie</documentation>
    </annotation>
  </enumeration>
  <enumeration value="0381003">
    <annotation>
      <documentation>kathetergestützte Reintervention</documentation>
    </annotation>
  </enumeration>
  <enumeration value="0381004">
    <annotation>
      <documentation>lokale Reinterventionen</documentation>
    </annotation>
  </enumeration>
  <enumeration value="0381005">
    <annotation>
      <documentation>andere Reintervention</documentation>
    </annotation>
  </enumeration>
</restriction>
</simpleType>

```

simpleType enum_0382

namespace	http://xml.ir-d.de/emg		
type	restriction of string		
properties	base xs:string		
used by	element	PostoperationAortenklappeBasis/POA GrundMassnahmeSchluessel	
facets	Kind	Value	Annotation
	enumeration	0382001	documentation keine Rethorakotomie / kein weiterer Grund
	enumeration	0382002	documentation Blutung/Hämatom
	enumeration	0382003	documentation Low Cardiac Output
	enumeration	0382004	documentation Tamponade
	enumeration	0382005	documentation Graftprobleme, Ischämie
	enumeration	0382006	documentation Wundinfektion, Mediastinitis
	enumeration	0382007	documentation Dissektion
	enumeration	0382008	documentation Prothesendysfunktion
	enumeration	0382009	documentation instabiles Sternum
	enumeration	0382010	documentation

	<p>enumeration 0382011 Chylothorax documentation lokale Revision im Bereich des Zugangsweges</p> <p>enumeration 0382042 documentation anderer Grund</p>
annotation	documentation Kat_AK_Komplikation
source	<pre> <simpleType name="enum_0382"> <annotation> <documentation>Kat_AK_Komplikation</documentation> </annotation> <restriction base="xs:string"> <enumeration value="0382001"> <annotation> <documentation>keine Rethorakotomie / kein weiterer Grund</documentation> </annotation> </enumeration> <enumeration value="0382002"> <annotation> <documentation>Blutung/Hämatom</documentation> </annotation> </enumeration> <enumeration value="0382003"> <annotation> <documentation>Low Cardiac Output</documentation> </annotation> </enumeration> <enumeration value="0382004"> <annotation> <documentation>Tamponade</documentation> </annotation> </enumeration> <enumeration value="0382005"> <annotation> <documentation>Graftprobleme, Ischämie</documentation> </annotation> </enumeration> <enumeration value="0382006"> <annotation> <documentation>Wundinfektion, Mediastinitis</documentation> </annotation> </enumeration> <enumeration value="0382007"> <annotation> <documentation>Dissektion</documentation> </annotation> </enumeration> <enumeration value="0382008"> <annotation> <documentation>Prothesendysfunktion</documentation> </annotation> </enumeration> <enumeration value="0382009"> <annotation> <documentation>instabiles Sternum</documentation> </annotation> </enumeration> <enumeration value="0382010"> </pre>

	<pre> <annotation> <documentation>Chylothorax</documentation> </annotation> </enumeration> <enumeration value="0382011"> <annotation> <documentation>lokale Revision im Bereich des Zugangsweges</documentation> </annotation> </enumeration> <enumeration value="0382042"> <annotation> <documentation>anderer Grund</documentation> </annotation> </enumeration> </restriction> </simpleType> </pre>
--	--

simpleType enum 0383

namespace	http://xml.ir-d.de/emg		
type	restriction of string		
properties	base xs:string		
used by	element PostoperationAortenklappeBasis/POA AteminsuffizienzSchluessel		
facets	Kind	Value	Annotation
	enumeration	0383001	documentation nein
	enumeration	0383002	documentation ja, mit forcierter Atemtherapie
	enumeration	0383003	documentation ja, Reintubation oder längerfristige Beatmung
	enumeration	0383004	documentation ja, Tracheotomie
annotation	documentation Kat_AK_RespiratorischeInsuffizienz		
source	<pre> <simpleType name="enum_0383"> <annotation> <documentation>Kat_AK_RespiratorischeInsuffizienz</documentation> </annotation> <restriction base="xs:string"> <enumeration value="0383001"> <annotation> <documentation>nein</documentation> </annotation> </enumeration> <enumeration value="0383002"> <annotation> <documentation>ja, mit forcierter Atemtherapie</documentation> </annotation> </enumeration> <enumeration value="0383003"> <annotation> <documentation>ja, Reintubation oder längerfristige Beatmung</documentation> </annotation> </enumeration> </restriction> </simpleType> </pre>		

	<pre> <enumeration value="0383004"> <annotation> <documentation>ja, Tracheotomie</documentation> </annotation> </enumeration> </restriction> </simpleType> </pre>
--	---

simpleType enum_0384

namespace	http://xml.ir-d.de/emg		
type	restriction of string		
properties	base xs:string		
used by	element	PostoperationAortenklappeBasis/POA BlutungSchluessel	
facets	Kind	Value	Annotation
	enumeration	0384001	documentation keine Blutungskomplikationen
	enumeration	0384002	documentation Geringfügige Blutung (Minor Bleeding - BARC type 2 or 3a)
	enumeration	0384003	documentation Starke Blutung (Major Bleeding - BARC type 3a)
	enumeration	0384004	documentation Lebensbedrohliche Blutung (Life-threatening or disabling bleeding - BARC type 3b or 3c or type 5)
annotation	documentation	Kat_AK_Blutungskomplikation	
source	<pre> <simpleType name="enum_0384"> <annotation> <documentation>Kat_AK_Blutungskomplikation</documentation> </annotation> <restriction base="xs:string"> <enumeration value="0384001"> <annotation> <documentation>keine Blutungskomplikationen</documentation> </annotation> </enumeration> <enumeration value="0384002"> <annotation> <documentation>Geringfügige Blutung (Minor Bleeding - BARC type 2 or 3a)</documentation> </annotation> </enumeration> <enumeration value="0384003"> <annotation> <documentation>Starke Blutung (Major Bleeding - BARC type 3a)</documentation> </annotation> </enumeration> <enumeration value="0384004"> <annotation> <documentation>Lebensbedrohliche Blutung (Life-threatening or disabling bleeding - BARC type 3b or 3c or type 5)</documentation> </annotation> </enumeration> </restriction> </simpleType> </pre>		

simpleType enum_0385

namespace	http://xml.ir-d.de/emg		
type	restriction of string		
properties	base xs:string		
used by	element PostoperationAortenklappeBasis/POA HerzrhythmusSchluessel		
facets	Kind	Value	Annotation
	enumeration	0385001	documentation Sinusrhythmus
	enumeration	0385002	documentation Vorhofflimmern
	enumeration	0385003	documentation Patient verstorben (kein Herzrhythmus)
	enumeration	0385042	documentation anderer Rhythmus
annotation	documentation Kat_AK_HerzrhythmusEntlassung		
source	<pre> <simpleType name="enum_0385"> <annotation> <documentation>Kat_AK_HerzrhythmusEntlassung</documentation> </annotation> <restriction base="xs:string"> <enumeration value="0385001"> <annotation> <documentation>Sinusrhythmus</documentation> </annotation> </enumeration> <enumeration value="0385002"> <annotation> <documentation>Vorhofflimmern</documentation> </annotation> </enumeration> <enumeration value="0385003"> <annotation> <documentation>Patient verstorben (kein Herzrhythmus)</documentation> </annotation> </enumeration> <enumeration value="0385042"> <annotation> <documentation>anderer Rhythmus</documentation> </annotation> </enumeration> </restriction> </simpleType> </pre>		

simpleType enum_0388

namespace	http://xml.ir-d.de/emg		
type	restriction of string		
properties	base xs:string		
used by	element PostoperationAortenklappeBasis/POA AggregationshemmerSchluessel		
facets	Kind	Value	Annotation
	enumeration	0388001	documentation

	<p>enumeration 0388002 nein documentation ASS</p> <p>enumeration 0388003 documentation ADP-Rezeptor-Antagonist</p> <p>enumeration 0388004 documentation Kombination ASS und ADP-Rezeptor-Antagonist</p> <p>enumeration 0388042 documentation ja, andere</p> <p>enumeration 0388099 documentation unbekannt</p>
annotation	documentation Kat AK Plaettchenaggregationshemmer
source	<pre> <simpleType name="enum_0388"> <annotation> <documentation>Kat_AK_Plaettchenaggregationshemmer</documentation> </annotation> <restriction base="xs:string"> <enumeration value="0388001"> <annotation> <documentation>nein</documentation> </annotation> </enumeration> <enumeration value="0388002"> <annotation> <documentation>ASS</documentation> </annotation> </enumeration> <enumeration value="0388003"> <annotation> <documentation>ADP-Rezeptor-Antagonist</documentation> </annotation> </enumeration> <enumeration value="0388004"> <annotation> <documentation>Kombination ASS und ADP-Rezeptor- Antagonist</documentation> </annotation> </enumeration> <enumeration value="0388042"> <annotation> <documentation>ja, andere</documentation> </annotation> </enumeration> <enumeration value="0388099"> <annotation> <documentation>unbekannt</documentation> </annotation> </enumeration> </restriction> </simpleType> </pre>

simpleType enum_0389

namespace	http://xml.ir-d.de/emg
type	restriction of string
properties	base xs:string

used by	element AntikoagulansAortenklappeBasis/AKA AntikoagulansSchluessel																								
facets	<table border="1"> <thead> <tr> <th>Kind</th> <th>Value</th> <th>Annotation</th> </tr> </thead> <tbody> <tr> <td>enumeration</td> <td>0389001</td> <td>documentation nein</td> </tr> <tr> <td>enumeration</td> <td>0389002</td> <td>documentation Cumarin-Derivate</td> </tr> <tr> <td>enumeration</td> <td>0389003</td> <td>documentation Heparinoide</td> </tr> <tr> <td>enumeration</td> <td>0389004</td> <td>documentation orale Thrombinantagonisten</td> </tr> <tr> <td>enumeration</td> <td>0389006</td> <td>documentation Direkte orale Antikoagulantien (DOAK / NOAK)</td> </tr> <tr> <td>enumeration</td> <td>0389042</td> <td>documentation ja, andere</td> </tr> <tr> <td>enumeration</td> <td>0389099</td> <td>documentation unbekannt</td> </tr> </tbody> </table>	Kind	Value	Annotation	enumeration	0389001	documentation nein	enumeration	0389002	documentation Cumarin-Derivate	enumeration	0389003	documentation Heparinoide	enumeration	0389004	documentation orale Thrombinantagonisten	enumeration	0389006	documentation Direkte orale Antikoagulantien (DOAK / NOAK)	enumeration	0389042	documentation ja, andere	enumeration	0389099	documentation unbekannt
Kind	Value	Annotation																							
enumeration	0389001	documentation nein																							
enumeration	0389002	documentation Cumarin-Derivate																							
enumeration	0389003	documentation Heparinoide																							
enumeration	0389004	documentation orale Thrombinantagonisten																							
enumeration	0389006	documentation Direkte orale Antikoagulantien (DOAK / NOAK)																							
enumeration	0389042	documentation ja, andere																							
enumeration	0389099	documentation unbekannt																							
annotation	documentation Kat_AK_Antikoagulantien																								
source	<pre> <simpleType name="enum_0389"> <annotation> <documentation>Kat_AK_Antikoagulantien</documentation> </annotation> <restriction base="xs:string"> <enumeration value="0389001"> <annotation> <documentation>nein</documentation> </annotation> </enumeration> <enumeration value="0389002"> <annotation> <documentation>Cumarin-Derivate</documentation> </annotation> </enumeration> <enumeration value="0389003"> <annotation> <documentation>Heparinoide</documentation> </annotation> </enumeration> <enumeration value="0389004"> <annotation> <documentation>orale Thrombinantagonisten</documentation> </annotation> </enumeration> <enumeration value="0389006"> <annotation> <documentation>Direkte orale Antikoagulantien (DOAK / NOAK)</documentation> </annotation> </enumeration> <enumeration value="0389042"> <annotation> <documentation>ja, andere</documentation> </annotation> </enumeration> <enumeration value="0389099"> <annotation> <documentation>unbekannt</documentation> </annotation> </enumeration> </restriction> </pre>																								

	<code></simpleType></code>
--	----------------------------------

simpleType enum_0390

namespace	http://xml.ir-d.de/emg		
type	restriction of string		
properties	base xs:string		
used by	element ArtikelAortenklappeBasis/AAK ArtikelTypSchluessel		
facets	Kind	Value	Annotation
	enumeration	0390001	documentation biologisches Klappenmodell
	enumeration	0390002	documentation mechanisches Klappenmodell
annotation	documentation Kat_AK_Artikeltyp		
source	<pre> <simpleType name="enum_0390"> <annotation> <documentation>Kat_AK_Artikeltyp</documentation> </annotation> <restriction base="xs:string"> <enumeration value="0390001"> <annotation> <documentation>biologisches Klappenmodell</documentation> </annotation> </enumeration> <enumeration value="0390002"> <annotation> <documentation>mechanisches Klappenmodell</documentation> </annotation> </enumeration> </restriction> </simpleType> </pre>		

simpleType enum_0391

namespace	http://xml.ir-d.de/emg		
type	restriction of string		
properties	base xs:string		
used by	element ArtikelAortenklappeBasis/AAK KlappenTypSchluessel		
facets	Kind	Value	Annotation
	enumeration	0391001	documentation chirurgische Klappe
	enumeration	0391002	documentation TAVI-Klappe
annotation	documentation Kat_AK_Klappentyp		
source	<pre> <simpleType name="enum_0391"> <annotation> <documentation>Kat_AK_Klappentyp</documentation> </annotation> <restriction base="xs:string"> <enumeration value="0391001"> <annotation> </pre>		

	<pre> <documentation>chirurgische Klappe</documentation> </annotation> </enumeration> <enumeration value="0391002"> <annotation> <documentation>TAVI-Klappe</documentation> </annotation> </enumeration> </restriction> </simpleType> </pre>
--	--

simpleType enum_0398

namespace	http://xml.ir-d.de/emg		
type	restriction of string		
properties	base xs:string		
used by	element	PostoperationAortenklappeBasis/POA TodesursacheSchluessel	
facets	Kind	Value	Annotation
	enumeration	0398001	documentation kardiovaskuläre Ursache
	enumeration	0398002	documentation nicht-kardiovaskuläre Ursache
	enumeration	0398099	documentation Todesursache unbekannt
annotation	documentation Kat_AK_Todesursache		
source	<pre> <simpleType name="enum_0398"> <annotation> <documentation>Kat_AK_Todesursache</documentation> </annotation> <restriction base="xs:string"> <enumeration value="0398001"> <annotation> <documentation>kardiovaskuläre Ursache</documentation> </annotation> </enumeration> <enumeration value="0398002"> <annotation> <documentation>nicht-kardiovaskuläre Ursache</documentation> </annotation> </enumeration> <enumeration value="0398099"> <annotation> <documentation>Todesursache unbekannt</documentation> </annotation> </enumeration> </restriction> </simpleType> </pre>		

simpleType enum_0399

namespace	http://xml.ir-d.de/emg
type	restriction of string

properties	base xs:string									
used by	element PostoperationAortenklappeBasis/POA VitalstatusSchluessel									
facets	<table border="1"> <thead> <tr> <th>Kind</th> <th>Value</th> <th>Annotation</th> </tr> </thead> <tbody> <tr> <td>enumeration</td> <td>0399001</td> <td>documentation Patient lebt</td> </tr> <tr> <td>enumeration</td> <td>0399002</td> <td>documentation Patient im Krankenhaus verstorben</td> </tr> </tbody> </table>	Kind	Value	Annotation	enumeration	0399001	documentation Patient lebt	enumeration	0399002	documentation Patient im Krankenhaus verstorben
Kind	Value	Annotation								
enumeration	0399001	documentation Patient lebt								
enumeration	0399002	documentation Patient im Krankenhaus verstorben								
annotation	documentation Kat_AK_Vitalstatus									
source	<pre> <simpleType name="enum_0399"> <annotation> <documentation>Kat_AK_Vitalstatus</documentation> </annotation> <restriction base="xs:string"> <enumeration value="0399001"> <annotation> <documentation>Patient lebt</documentation> </annotation> </enumeration> <enumeration value="0399002"> <annotation> <documentation>Patient im Krankenhaus verstorben</documentation> </annotation> </enumeration> </restriction> </simpleType> </pre>									

complexType **PatientenaufnahmeBasis**

diagram	
namespace	http://xml.ir-d.de/emg
children	PAT_Alter PAT_Groesse PAT_Gewicht PAT_GeschlechtSchluessel
used by	complexType Patientenaufnahme
source	<pre> <complexType name="PatientenaufnahmeBasis"> <sequence> <element name="PAT_Alter" type="xs:integer"/> <element name="PAT_Groesse" type="xs:integer" minOccurs="0"/> <element name="PAT_Gewicht" type="xs:integer" minOccurs="0"/> <element name="PAT_GeschlechtSchluessel" type="enum_0070"/> </sequence> </complexType> </pre>

element **PatientenaufnahmeBasis/PAT_Alter**

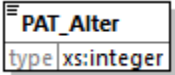
diagram	
type	integer
properties	content simple
source	<code><element name="PAT_Alter" type="xs:integer"/></code>

element **PatientenaufnahmeBasis/PAT_Groesse**

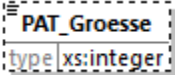
diagram	
type	integer
properties	minOcc 0 maxOcc 1 content simple
source	<code><element name="PAT_Groesse" type="xs:integer" minOccurs="0"/></code>

element **PatientenaufnahmeBasis/PAT_Gewicht**

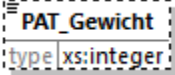
diagram	
type	integer
properties	minOcc 0 maxOcc 1 content simple
source	<code><element name="PAT_Gewicht" type="xs:integer" minOccurs="0"/></code>

element **PatientenaufnahmeBasis/PAT_GeschlechtSchluessel**

diagram																
type	enum_0070															
properties	content simple															
facets	<table border="1"> <thead> <tr> <th>Kind</th> <th>Value</th> <th>Annotation</th> </tr> </thead> <tbody> <tr> <td>enumeration</td> <td>0070001</td> <td>documentation weiblich</td> </tr> <tr> <td>enumeration</td> <td>0070002</td> <td>documentation männlich</td> </tr> <tr> <td>enumeration</td> <td>0070003</td> <td>documentation divers</td> </tr> <tr> <td>enumeration</td> <td>0070042</td> <td>documentation unbestimmt</td> </tr> </tbody> </table>	Kind	Value	Annotation	enumeration	0070001	documentation weiblich	enumeration	0070002	documentation männlich	enumeration	0070003	documentation divers	enumeration	0070042	documentation unbestimmt
Kind	Value	Annotation														
enumeration	0070001	documentation weiblich														
enumeration	0070002	documentation männlich														
enumeration	0070003	documentation divers														
enumeration	0070042	documentation unbestimmt														
source	<code><element name="PAT_GeschlechtSchluessel" type="enum_0070"/></code>															

complexType **PatientenaufnahmeBrustimplantatBasis**

diagram	
namespace	http://xml.lir-d.de/emg
children	PAB_AutoimmunerkrankungSchlüssel PAB_VerlaufAutoimmunerkrankungSchlüssel PAB_GeschlechtGeburtSchlüssel
used by	element Patientenaufnahme/patientenaufnahmeBrustimplantat
source	<pre><complexType name="PatientenaufnahmeBrustimplantatBasis"> <sequence> <element name="PAB_AutoimmunerkrankungSchlüssel" type="enum_0122"/> <element name="PAB_VerlaufAutoimmunerkrankungSchlüssel" type="enum_0123" minOccurs="0"/> <element name="PAB_GeschlechtGeburtSchlüssel" type="enum_0170" minOccurs="0"/> </sequence> </complexType></pre>

element **PatientenaufnahmeBrustimplantatBasis/PAB_AutoimmunerkrankungSchlüssel**

diagram													
type	enum 0122												
properties	content simple												
facets	<table border="1"> <thead> <tr> <th>Kind</th> <th>Value</th> <th>Annotation</th> </tr> </thead> <tbody> <tr> <td>enumeration</td> <td>0122001</td> <td>documentation ja, ärztlich nachgewiesen</td> </tr> <tr> <td>enumeration</td> <td>0122002</td> <td>documentation nein</td> </tr> <tr> <td>enumeration</td> <td>0122042</td> <td>documentation unbekannt</td> </tr> </tbody> </table>	Kind	Value	Annotation	enumeration	0122001	documentation ja, ärztlich nachgewiesen	enumeration	0122002	documentation nein	enumeration	0122042	documentation unbekannt
Kind	Value	Annotation											
enumeration	0122001	documentation ja, ärztlich nachgewiesen											
enumeration	0122002	documentation nein											
enumeration	0122042	documentation unbekannt											
source	<pre><element name="PAB_AutoimmunerkrankungSchlüssel" type="enum_0122"/></pre>												

element **PatientenaufnahmeBrustimplantatBasis/PAB_VerlaufAutoimmunerkrankungSchlüssel**

diagram							
type	enum 0123						
properties	<table border="1"> <tr> <td>minOcc</td> <td>0</td> </tr> <tr> <td>maxOcc</td> <td>1</td> </tr> <tr> <td>content</td> <td>simple</td> </tr> </table>	minOcc	0	maxOcc	1	content	simple
minOcc	0						
maxOcc	1						
content	simple						

facets	Kind	Value	Annotation
	enumeration	0123001	documentation neu aufgetreten
	enumeration	0123002	documentation verschlechtert
	enumeration	0123003	documentation keine Veränderung
	enumeration	0123004	documentation nicht relevant, da Primäreingriff
	enumeration	0123042	documentation unbekannt
source	<code><element name="PAB_VerlaufAutoimmunerkrankungSchluessel" type="enum_0123" minOccurs="0"/></code>		

element **PatientenaufnahmeBrustimplantatBasis/PAB_GeschlechtGeburtSchluessel**

diagram	<p>The diagram shows a dashed box containing the text "PAB_GeschlechtGeburtSchluessel" and "type enum_0170".</p>		
type	enum_0170		
properties	minOcc	0	
	maxOcc	1	
	content	simple	
facets	Kind	Value	Annotation
	enumeration	0170001	documentation weiblich
	enumeration	0170002	documentation männlich
	enumeration	0170003	documentation intersexuell
source	<code><element name="PAB_GeschlechtGeburtSchluessel" type="enum_0170" minOccurs="0"/></code>		

complexType **PatientenaufnahmeKardiologie**

<p>diagram</p>	<p>The diagram illustrates the XSD structure for the complex type PatientenaufnahmeKardiologie. It is an extension of PatientenaufnahmeKardiologieBasis. The structure consists of a sequence of elements: PatientenaufnahmeKardiologie, PatientenaufnahmeAortenklappe, and a choice of the following elements: PKA_NyhaSchluessel (type: enum_0324), PKA_Lvef (type: Zahl3, min/maxIncl: 1 999), PKA_LvefUnbekannt (type: JaLeer, pattern: (1)), PKA_DiabetesSchluessel (type: enum_0322), PKA_NierenersatzSchluessel (type: enum_0369), PKA_KreatininwertMgdl (type: Zahl2_1, min/maxIncl: 0.1 99.9), PKA_KreatininwertMikromol (type: Zahl4, min/maxIncl: 1 9999), and PKA_KreatininwertUnbekannt (type: JaLeer, pattern: (1)).</p>
<p>namespace</p>	<p>http://xml.ir-d.de/emg</p>
<p>type</p>	<p>extension of PatientenaufnahmeKardiologieBasis</p>
<p>properties</p>	<p>base PatientenaufnahmeKardiologieBasis</p>
<p>children</p>	<p>PKA_NyhaSchluessel PKA_Lvef PKA_LvefUnbekannt PKA_DiabetesSchluessel PKA_NierenersatzSchluessel PKA_KreatininwertMgdl PKA_KreatininwertMikromol PKA_KreatininwertUnbekannt patientenaufnahmeAortenklappe</p>
<p>used by</p>	<p>element Patientenaufnahme/patientenaufnahmeKardiologie</p>
<p>source</p>	<pre><complexType name="PatientenaufnahmeKardiologie"> <complexContent> <extension base="PatientenaufnahmeKardiologieBasis"> <sequence> <element name="patientenaufnahmeAortenklappe" type="PatientenaufnahmeAortenklappe"/> </sequence> </extension> </complexContent> </complexType></pre>

element **PatientenaufnahmeKardiologie/patientenaufnahmeAortenklappe**

diagram

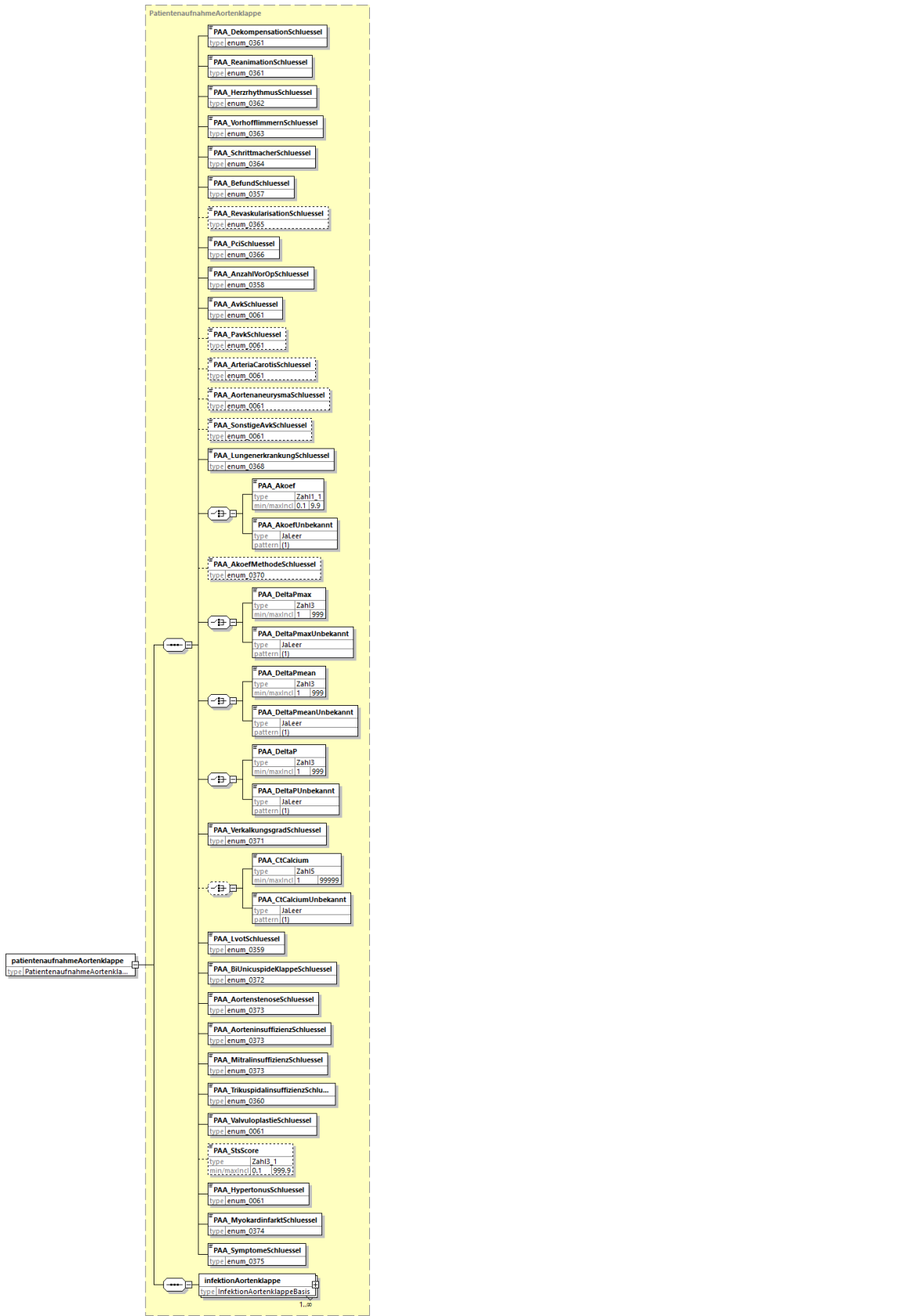

type

[PatientenaufnahmeAortenklappe](#)

properties

content complex

children	PAA DekompensationSchluessel PAA ReanimationSchluessel PAA HerzrhythmusSchluessel PAA VorhofflimmernSchluessel PAA SchrittmacherSchluessel PAA BefundSchluessel PAA RevaskularisationSchluessel PAA PciSchluessel PAA AnzahlVorOpSchluessel PAA AvkSchluessel PAA PavkSchluessel PAA ArteriaCarotisSchluessel PAA AortenaneurysmaSchluessel PAA SonstigeAvkSchluessel PAA LungenerkrankungSchluessel PAA Akoef PAA AkoefUnbekannt PAA AkoefMethodeSchluessel PAA DeltaPmax PAA DeltaPmaxUnbekannt PAA DeltaPmean PAA DeltaPmeanUnbekannt PAA DeltaP PAA DeltaPUnbekannt PAA VerkalkungsgradSchluessel PAA CtCalcium PAA CtCalciumUnbekannt PAA LvotSchluessel PAA BiUnicuspideKlappeSchluessel PAA AortenstenoseSchluessel PAA AorteninsuffizienzSchluessel PAA MitralinsuffizienzSchluessel PAA TrikuspidalinsuffizienzSchluessel PAA ValvuloplastieSchluessel PAA StsScore PAA HypertonusSchluessel PAA MyokardinfarktSchluessel PAA SymptomeSchluessel infektionAortenklappe
source	<pre><element name="patientenaufnahmeAortenklappe" type="PatientenaufnahmeAortenklappe"/></pre>

complexType **OperationBasis**

diagram	
namespace	http://xml.ir-d.de/emg
children	OPE LaufendeNumer OPE Datum OPE SeitenLokalisationSchluessel OPE AsaSchluessel OPE ImplantattypSchluessel
used by	complexType Operation
source	<pre><complexType name="OperationBasis"> <sequence> <element name="OPE_LaufendeNumer" type="Zahl3"/> <element name="OPE_Datum" type="xs:date"/> <element name="OPE_SeitenLokalisationSchluessel" type="enum_0050" minOccurs="0"/> <element name="OPE_AsaSchluessel" type="enum_0044"/> <element name="OPE_ImplantattypSchluessel" type="enum_0080"/> </sequence> </complexType></pre>

element **OperationBasis/OPE_LaufendeNumer**

diagram	
---------	--

type	Zahl3									
properties	content simple									
facets	<table border="1"> <thead> <tr> <th>Kind</th> <th>Value</th> <th>Annotation</th> </tr> </thead> <tbody> <tr> <td>minInclusive</td> <td>1</td> <td></td> </tr> <tr> <td>maxInclusive</td> <td>999</td> <td></td> </tr> </tbody> </table>	Kind	Value	Annotation	minInclusive	1		maxInclusive	999	
Kind	Value	Annotation								
minInclusive	1									
maxInclusive	999									
source	<code><element name="OPE_LaufendeNummer" type="Zahl3"/></code>									

element **OperationBasis/OPE_Datum**

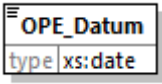
diagram	
type	date
properties	content simple
source	<code><element name="OPE_Datum" type="xs:date"/></code>

element **OperationBasis/OPE_SeitenLokalisationSchluessel**

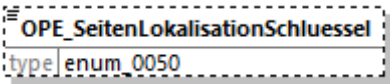
diagram										
type	enum_0050									
properties	<table border="1"> <tbody> <tr> <td>minOcc</td> <td>0</td> </tr> <tr> <td>maxOcc</td> <td>1</td> </tr> <tr> <td>content</td> <td>simple</td> </tr> </tbody> </table>	minOcc	0	maxOcc	1	content	simple			
minOcc	0									
maxOcc	1									
content	simple									
facets	<table border="1"> <thead> <tr> <th>Kind</th> <th>Value</th> <th>Annotation</th> </tr> </thead> <tbody> <tr> <td>enumeration</td> <td>0050001</td> <td>documentation rechts</td> </tr> <tr> <td>enumeration</td> <td>0050002</td> <td>documentation links</td> </tr> </tbody> </table>	Kind	Value	Annotation	enumeration	0050001	documentation rechts	enumeration	0050002	documentation links
Kind	Value	Annotation								
enumeration	0050001	documentation rechts								
enumeration	0050002	documentation links								
source	<code><element name="OPE_SeitenLokalisationSchluessel" type="enum_0050" minOccurs="0"/></code>									

element **OperationBasis/OPE_AsaSchluessel**

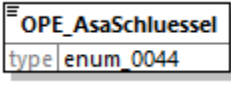
diagram																
type	enum_0044															
properties	content simple															
facets	<table border="1"> <thead> <tr> <th>Kind</th> <th>Value</th> <th>Annotation</th> </tr> </thead> <tbody> <tr> <td>enumeration</td> <td>0044001</td> <td>documentation 1= normaler, sonst gesunder Patient</td> </tr> <tr> <td>enumeration</td> <td>0044002</td> <td>documentation 2= Patient mit leichter Allgemeinerkrankung</td> </tr> <tr> <td>enumeration</td> <td>0044003</td> <td>documentation 3= Patient mit schwerer Allgemeinerkrankung</td> </tr> <tr> <td>enumeration</td> <td>0044004</td> <td>documentation 4= Patient mit schwerer Allgemeinerkrankung, die eine ständige Lebensbedrohung darstellt</td> </tr> </tbody> </table>	Kind	Value	Annotation	enumeration	0044001	documentation 1= normaler, sonst gesunder Patient	enumeration	0044002	documentation 2= Patient mit leichter Allgemeinerkrankung	enumeration	0044003	documentation 3= Patient mit schwerer Allgemeinerkrankung	enumeration	0044004	documentation 4= Patient mit schwerer Allgemeinerkrankung, die eine ständige Lebensbedrohung darstellt
Kind	Value	Annotation														
enumeration	0044001	documentation 1= normaler, sonst gesunder Patient														
enumeration	0044002	documentation 2= Patient mit leichter Allgemeinerkrankung														
enumeration	0044003	documentation 3= Patient mit schwerer Allgemeinerkrankung														
enumeration	0044004	documentation 4= Patient mit schwerer Allgemeinerkrankung, die eine ständige Lebensbedrohung darstellt														

	enumeration 0044005 documentation 5= moribunder Patient, der ohne die Operation voraussichtlich nicht überleben wird
source	<element name="OPE_AsaSchluessel" type="enum_0044"/>

element **OperationBasis/OPE_ImplantattypSchluessel**

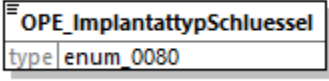
diagram													
type	enum_0080												
properties	content simple												
facets	<table border="1"> <thead> <tr> <th>Kind</th> <th>Value</th> <th>Annotation</th> </tr> </thead> <tbody> <tr> <td>enumeration</td> <td>0080001</td> <td>documentation Endoprothese Hüfte/Knie</td> </tr> <tr> <td>enumeration</td> <td>0080002</td> <td>documentation Brustimplantat</td> </tr> <tr> <td>enumeration</td> <td>0080003</td> <td>documentation Aortenklappenprothese</td> </tr> </tbody> </table>	Kind	Value	Annotation	enumeration	0080001	documentation Endoprothese Hüfte/Knie	enumeration	0080002	documentation Brustimplantat	enumeration	0080003	documentation Aortenklappenprothese
Kind	Value	Annotation											
enumeration	0080001	documentation Endoprothese Hüfte/Knie											
enumeration	0080002	documentation Brustimplantat											
enumeration	0080003	documentation Aortenklappenprothese											
source	<element name="OPE_ImplantattypSchluessel" type="enum_0080"/>												

complexType **OperationBrustimplantat**

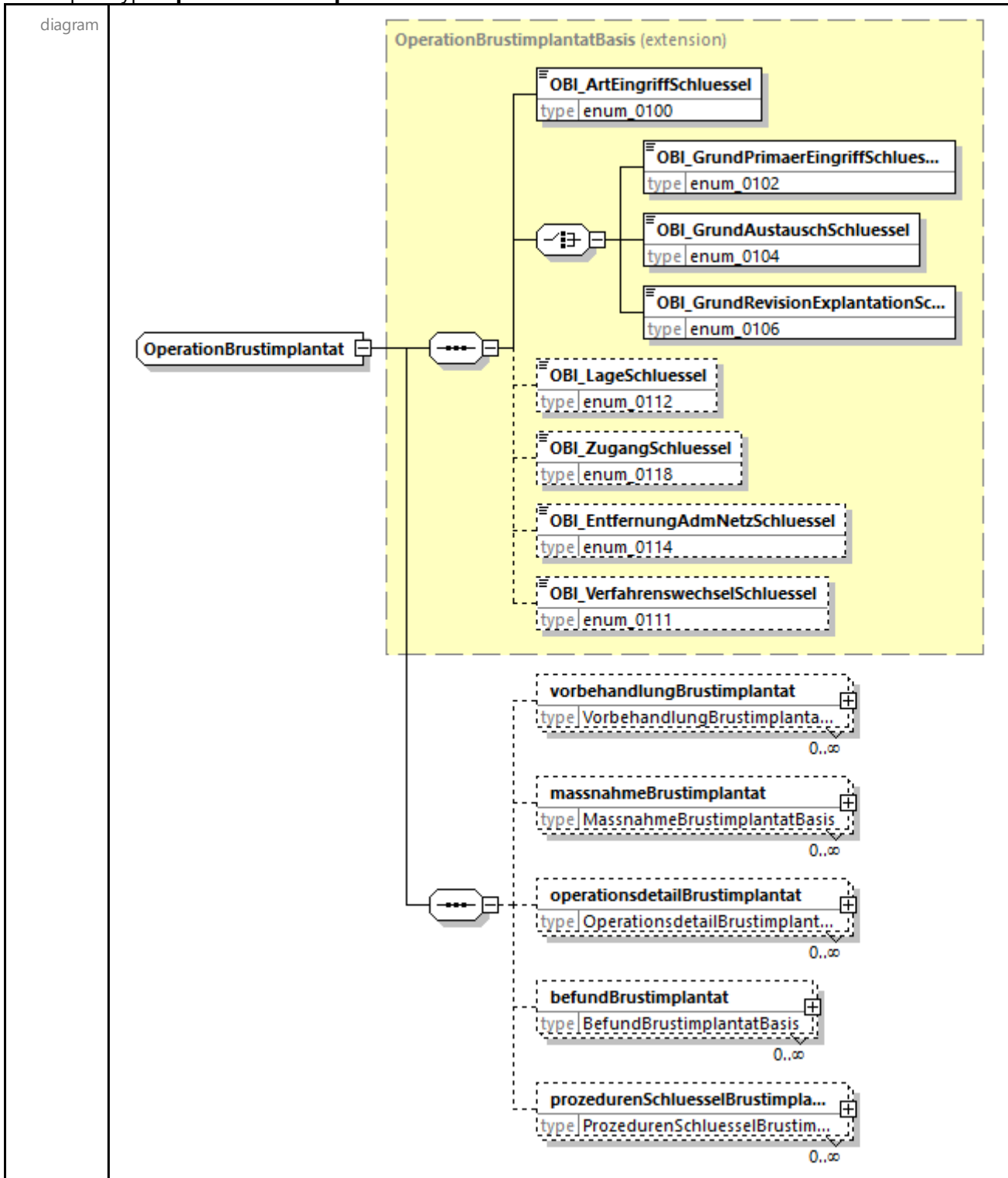

namespace	http://xml.ir-d.de/emg
type	extension of OperationBrustimplantatBasis
properties	base OperationBrustimplantatBasis
children	OBI ArtEingriffSchluessel OBI GrundPrimaerEingriffSchluessel OBI GrundAustauschSchluessel OBI GrundRevisionExplantationSchluessel OBI LageSchluessel OBI ZugangSchluessel OBI EntfernungAdmNetzSchluessel OBI VerfahrenswechselSchluessel vorbehandlungBrustimplantat massnahmeBrustimplantat operationsdetailBrustimplantat befundBrustimplantat

	prozedurenSchluesselBrustimplantat
used by	element Operation/operationBrustimplantat
source	<pre> <complexType name="OperationBrustimplantat"> <complexContent> <extension base="OperationBrustimplantatBasis"> <sequence> <element name="vorbehandlungBrustimplantat" type="VorbehandlungBrustimplantatBasis" minOccurs="0" maxOccurs="unbounded"/> <element name="massnahmeBrustimplantat" type="MassnahmeBrustimplantatBasis" minOccurs="0" maxOccurs="unbounded"/> <element name="operationsdetailBrustimplantat" type="OperationsdetailBrustimplantatBasis" minOccurs="0" maxOccurs="unbounded"/> <element name="befundBrustimplantat" type="BefundBrustimplantatBasis" minOccurs="0" maxOccurs="unbounded"/> <element name="prozedurenSchluesselBrustimplantat" type="ProzedurenSchluesselBrustimplantatBasis" minOccurs="0" maxOccurs="unbounded"/> </sequence> </extension> </complexContent> </complexType> </pre>

element **OperationBrustimplantat/vorbehandlungBrustimplantat**

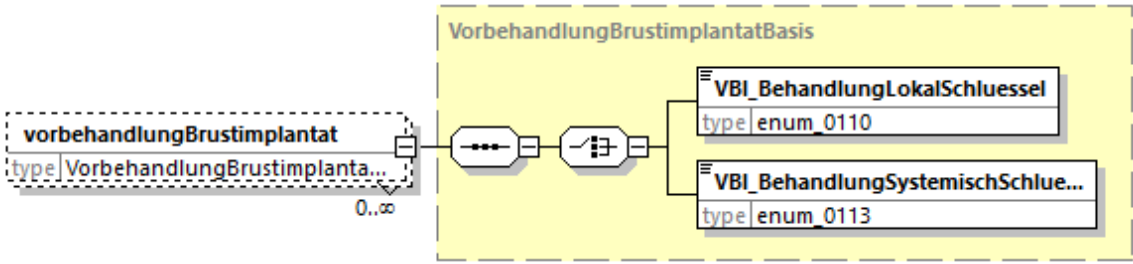
diagram	
type	VorbehandlungBrustimplantatBasis
properties	minOcc 0 maxOcc unbounded content complex
children	VBI BehandlungLokalSchluessel VBI BehandlungSystemischSchluessel
source	<pre> <element name="vorbehandlungBrustimplantat" type="VorbehandlungBrustimplantatBasis" minOccurs="0" maxOccurs="unbounded"/> </pre>

element **OperationBrustimplantat/massnahmeBrustimplantat**

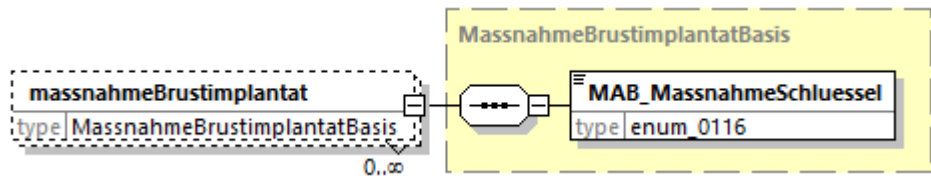
diagram	
type	MassnahmeBrustimplantatBasis
properties	minOcc 0 maxOcc unbounded

content	complex
children	MAB MassnahmeSchluessel
source	<code><element name="massnahmeBrustimplantat" type="MassnahmeBrustimplantatBasis" minOccurs="0" maxOccurs="unbounded"/></code>

element **OperationBrustimplantat/operationsdetailBrustimplantat**

diagram	
type	OperationsdetailBrustimplantatBasis
properties	minOcc 0 maxOcc unbounded content complex
children	ODB_OperationsdetailPrimaerEingriffSchluessel ODB_OperationsdetailAustauschSchluessel ODB_OperationsdetailRevisionSchluessel
source	<code><element name="operationsdetailBrustimplantat" type="OperationsdetailBrustimplantatBasis" minOccurs="0" maxOccurs="unbounded"/></code>

element **OperationBrustimplantat/befundBrustimplantat**

diagram	
type	BefundBrustimplantatBasis
properties	minOcc 0 maxOcc unbounded content complex
children	BEB_BefundSchluessel BEB_BefundAustauschSchluessel
source	<code><element name="befundBrustimplantat" type="BefundBrustimplantatBasis" minOccurs="0" maxOccurs="unbounded"/></code>

element **OperationBrustimplantat/prozedurenSchluesselBrustimplantat**

diagram	
type	ProzedurenSchluesselBrustimplantatBasis
properties	minOcc 0 maxOcc unbounded content complex
children	PBI_ProzedurenSchluessel
source	<pre><element name="prozedurenSchluesselBrustimplantat" type="ProzedurenSchluesselBrustimplantatBasis" minOccurs="0" maxOccurs="unbounded"/></pre>

complexType **OperationEndoprothese**

diagram

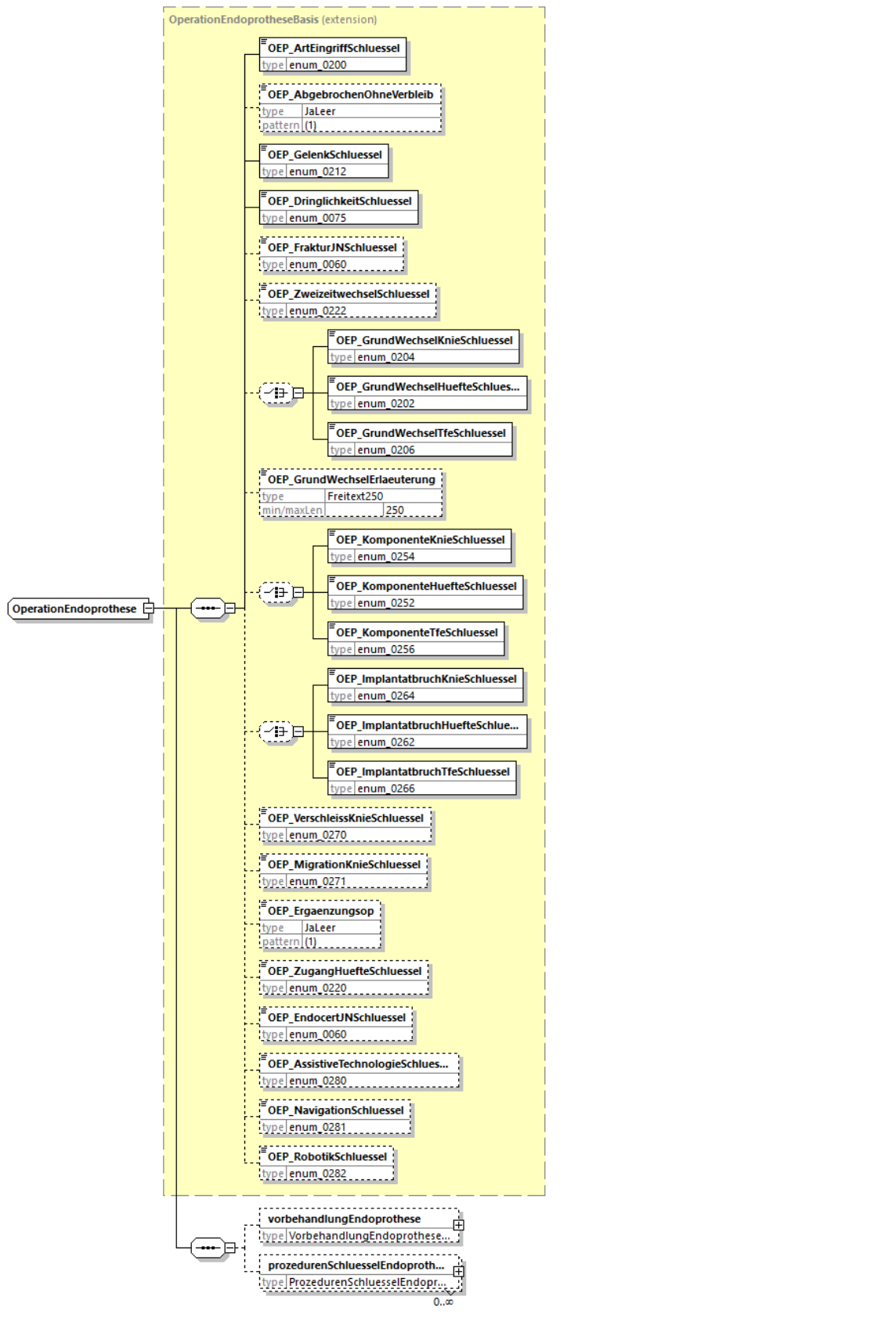

namespace http://xml.ir-d.de/emg

type extension of [OperationEndoprotheseBasis](#)

properties	base OperationEndoprotheseBasis
children	OEP ArtEingriffSchluessel OEP AbgebrochenOhneVerbleib OEP GelenkSchluessel OEP DringlichkeitSchluessel OEP FrakturJNSchluessel OEP ZweizeitwechselSchluessel OEP GrundWechselKnieSchluessel OEP GrundWechselHuefteSchluessel OEP GrundWechselTfeSchluessel OEP GrundWechselErlaeuterung OEP KomponenteKnieSchluessel OEP KomponenteHuefteSchluessel OEP KomponenteTfeSchluessel OEP ImplantatbruchKnieSchluessel OEP ImplantatbruchHuefteSchluessel OEP ImplantatbruchTfeSchluessel OEP VerschleissKnieSchluessel OEP MigrationKnieSchluessel OEP Ergaenzungsop OEP ZugangHuefteSchluessel OEP EndocertJNSchluessel OEP AssistiveTechnologieSchluessel OEP NavigationSchluessel OEP RobotikSchluessel vorbehandlungEndoprothese prozedurenSchluesselEndoprothese
used by	element Operation/operationEndoprothese
source	<pre> <complexType name="OperationEndoprothese"> <complexContent> <extension base="OperationEndoprotheseBasis"> <sequence> <element name="vorbehandlungEndoprothese" type="VorbehandlungEndoprotheseBasis" minOccurs="0"/> <element name="prozedurenSchluesselEndoprothese" type="ProzedurenSchluesselEndoprotheseBasis" minOccurs="0" maxOccurs="unbounded"/> </sequence> </extension> </complexContent> </complexType> </pre>

element **OperationEndoprothese/vorbehandlungEndoprothese**

diagram	
type	VorbehandlungEndoprotheseBasis
properties	minOcc 0 maxOcc 1 content complex
children	VEP_VorOpKnieSchluessel VEP_VorOpHuefteSchluessel VEP_VorOpErlaeuterung
source	<pre> <element name="vorbehandlungEndoprothese" type="VorbehandlungEndoprotheseBasis" minOccurs="0"/> </pre>

element **OperationEndoprothese/prozedurenSchluesselEndoprothese**

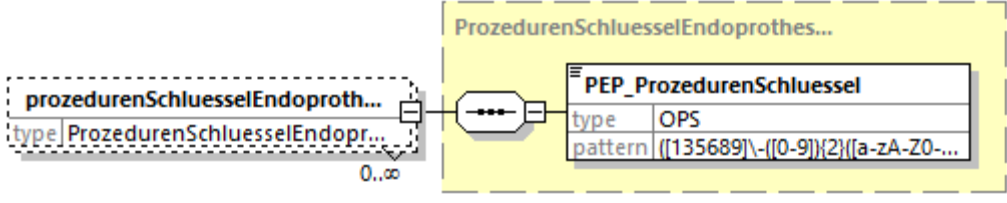
<p>diagram</p>	
<p>type</p>	<p>ProzedurenSchluesselEndoprotheseBasis</p>
<p>properties</p>	<p>minOcc 0 maxOcc unbounded content complex</p>
<p>children</p>	<p>PEP_ProzedurenSchluessel</p>
<p>source</p>	<pre><element name="prozedurenSchluesselEndoprothese" type="ProzedurenSchluesselEndoprotheseBasis" minOccurs="0" maxOccurs="unbounded"/></pre>

properties	base OperationAortenklappeBasis
children	OAK NummerEingriff OAK ArtEingriffSchluessel OAK AbgebrochenOhneVerbleib OAK GrundAbbruchSchluessel OAK ImplantationAllograft OAK GrundEingriffSchluessel OAK DringlichkeitSchluessel OAK ExplantationSchluessel OAK IsoliertSchluessel OAK ZugangKonventionellSchluessel OAK ZugangKatheterSchluessel OAK KomplikationenSchluessel OAK TherapieLcoSchluessel OAK Durchleuchtungszeit OAK BeatmungSchluessel OAK TroponinSchluessel OAK InotropeSchluessel OAK Eingriffsdauer OAK EingriffsumfangSchluessel OAK ProzedurenAnzahl OAK VorgehenSchluessel OAK Bypasszeit OAK BypasszeitUnbekannt OAK Abklemmzeit OAK AbklemmzeitUnbekannt OAK AortaThorakalSchluessel OAK NeuroprotektionSchluessel OAK KreislaufunterstuetzungSchluessel OAK PraeOpUnterstuetzungSchluessel OAK PraeOpMethodeSchluessel OAK IntraOpUnterstuetzungSchluessel OAK IntraOpMethodeSchluessel OAK AortenklappenOpAnzahl OAK ValvelnValveSchluessel OAK ZugangsGefaessdiameter OAK ZugangsGefaessUnbekannt OAK ZugangVerkalkungSchluessel OAK Aortenklappenannulus OAK MessmethodeSchluessel OAK DistanzRca OAK DistanzRcaUnbekannt OAK DistanzLca OAK DistanzLcaUnbekannt OAK PtcaVorSchluessel OAK PtcaVorDurchmesser OAK PtcaVorDurchmesserUnbekannt OAK PtcaVorAnzahl OAK RapidPacingVorSchluessel OAK RapidPacingIntraSchluessel OAK PtcaNachSchluessel OAK PtcaNachDurchmesser OAK PtcaNachDurchmesserUnbekannt OAK PtcaNachAnzahl OAK RapidPacingNachSchluessel OAK KonversionSchluessel OAK SuccessSchluessel OAK AnaesthesieSchluessel OAK DeltaPmeanNachOp OAK DeltaPmeanNachOpUnbekannt OAK ResidualeInsuffizienzSchluessel OAK ZugangVerschlussSchluessel OAK ZusaetzlichePciSchluessel OAK PciWegenKhkSchluessel OAK PciWegenKomplikationSchluessel OAK LaesionenAnzahl komplikationAortenklappe taviAortenklappe pciAortenklappe failureGrundAortenklappe prozedurenSchluesselAortenklappe
used by	element Operation/operationAortenklappe
source	<pre> <complexType name="OperationAortenklappe"> <complexContent> <extension base="OperationAortenklappeBasis"> <sequence> <element name="komplikationAortenklappe" type="KomplikationAortenklappeBasis" minOccurs="0" maxOccurs="unbounded"/> <element name="taviAortenklappe" type="TaviAortenklappeBasis" minOccurs="0" maxOccurs="unbounded"/> <element name="pciAortenklappe" type="PciAortenklappeBasis" minOccurs="0" maxOccurs="unbounded"/> <element name="failureGrundAortenklappe" type="FailureGrundAortenklappeBasis" minOccurs="0" maxOccurs="unbounded"/> <element name="prozedurenSchluesselAortenklappe" type="ProzedurenSchluesselAortenklappeBasis" minOccurs="0" maxOccurs="unbounded"/> </sequence> </extension> </complexContent> </complexType> </pre>

element **OperationAortenklappe/komplikationAortenklappe**

diagram	
type	KomplikationAortenklappeBasis
properties	minOcc 0 maxOcc unbounded content complex
children	KAK_KomplikationTypSchluessel

source	<code><element name="komplikationAortenklappe" type="KomplikationAortenklappeBasis" minOccurs="0" maxOccurs="unbounded"/></code>
--------	--

element **OperationAortenklappe/taviAortenklappe**

diagram	
type	TaviAortenklappeBasis
properties	minOcc 0 maxOcc unbounded content complex
children	TAK GrundTaviSchlüssel
source	<code><element name="taviAortenklappe" type="TaviAortenklappeBasis" minOccurs="0" maxOccurs="unbounded"/></code>

element **OperationAortenklappe/pciAortenklappe**

diagram	
type	PciAortenklappeBasis
properties	minOcc 0 maxOcc unbounded content complex
children	PCA PciArterienSchlüssel
source	<code><element name="pciAortenklappe" type="PciAortenklappeBasis" minOccurs="0" maxOccurs="unbounded"/></code>

element **OperationAortenklappe/failureGrundAortenklappe**

diagram	
type	FailureGrundAortenklappeBasis
properties	minOcc 0 maxOcc unbounded content complex
children	FAK FailureGrundSchlüssel
source	<code><element name="failureGrundAortenklappe" type="FailureGrundAortenklappeBasis" minOccurs="0" maxOccurs="unbounded"/></code>

`minOccurs="0" maxOccurs="unbounded"/>`

element **OperationAortenklappe/prozedurenSchluesselAortenklappe**

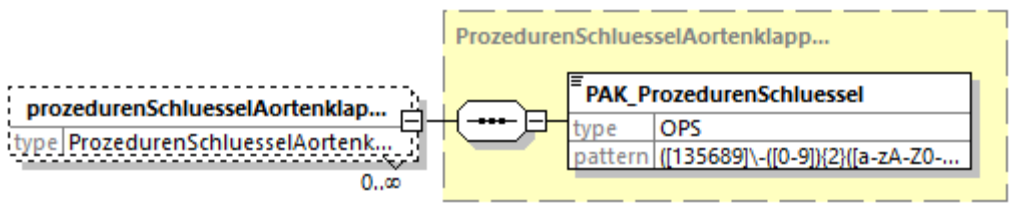
diagram	
type	ProzedurenSchluesselAortenklappeBasis
properties	minOcc 0 maxOcc unbounded content complex
children	PAK_ProzedurenSchluessel
source	<code><element name="prozedurenSchluesselAortenklappe" type="ProzedurenSchluesselAortenklappeBasis" minOccurs="0" maxOccurs="unbounded"/></code>

complexType Artikelidentifikation

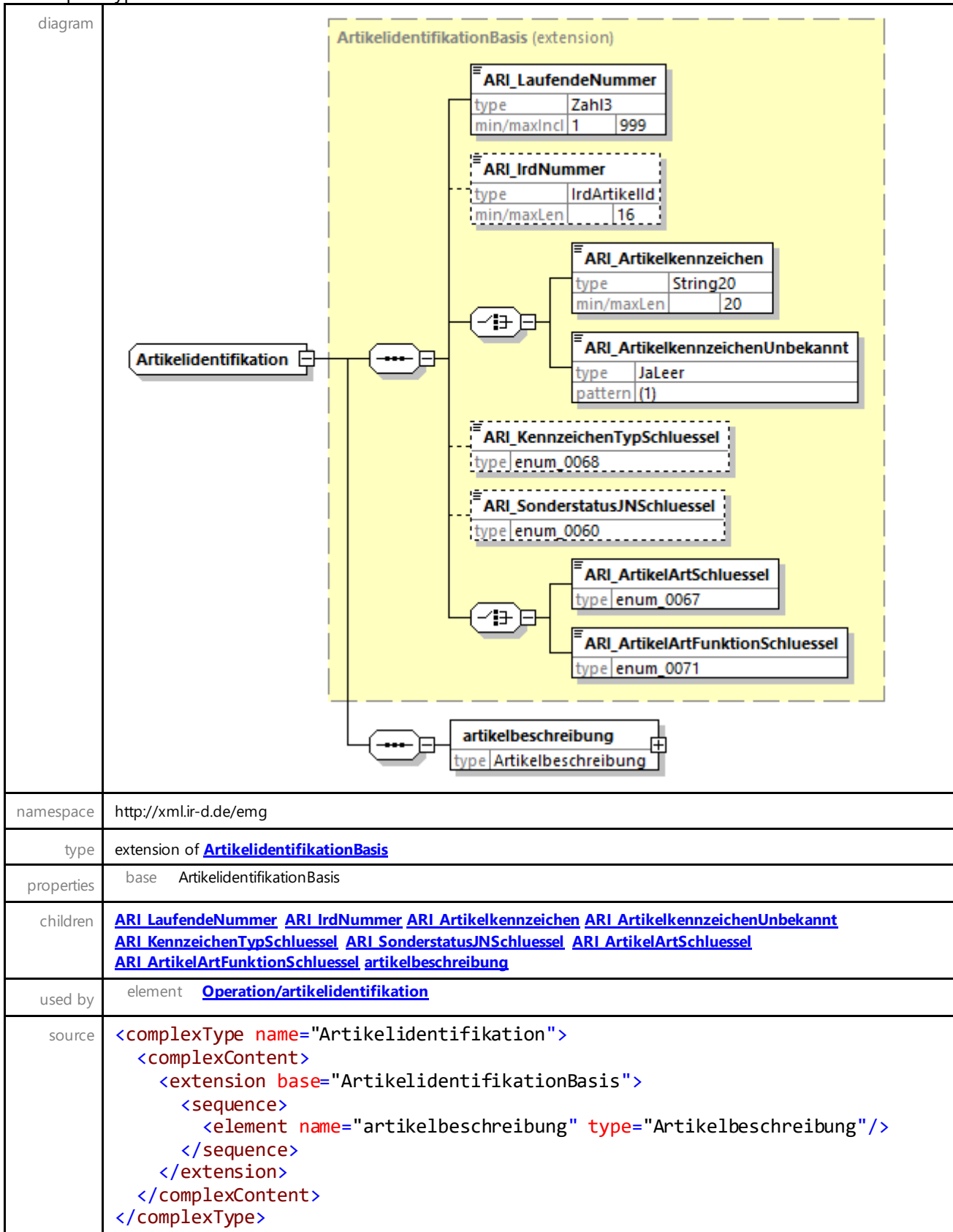

element **Artikelidentifikation/artikelbeschreibung**

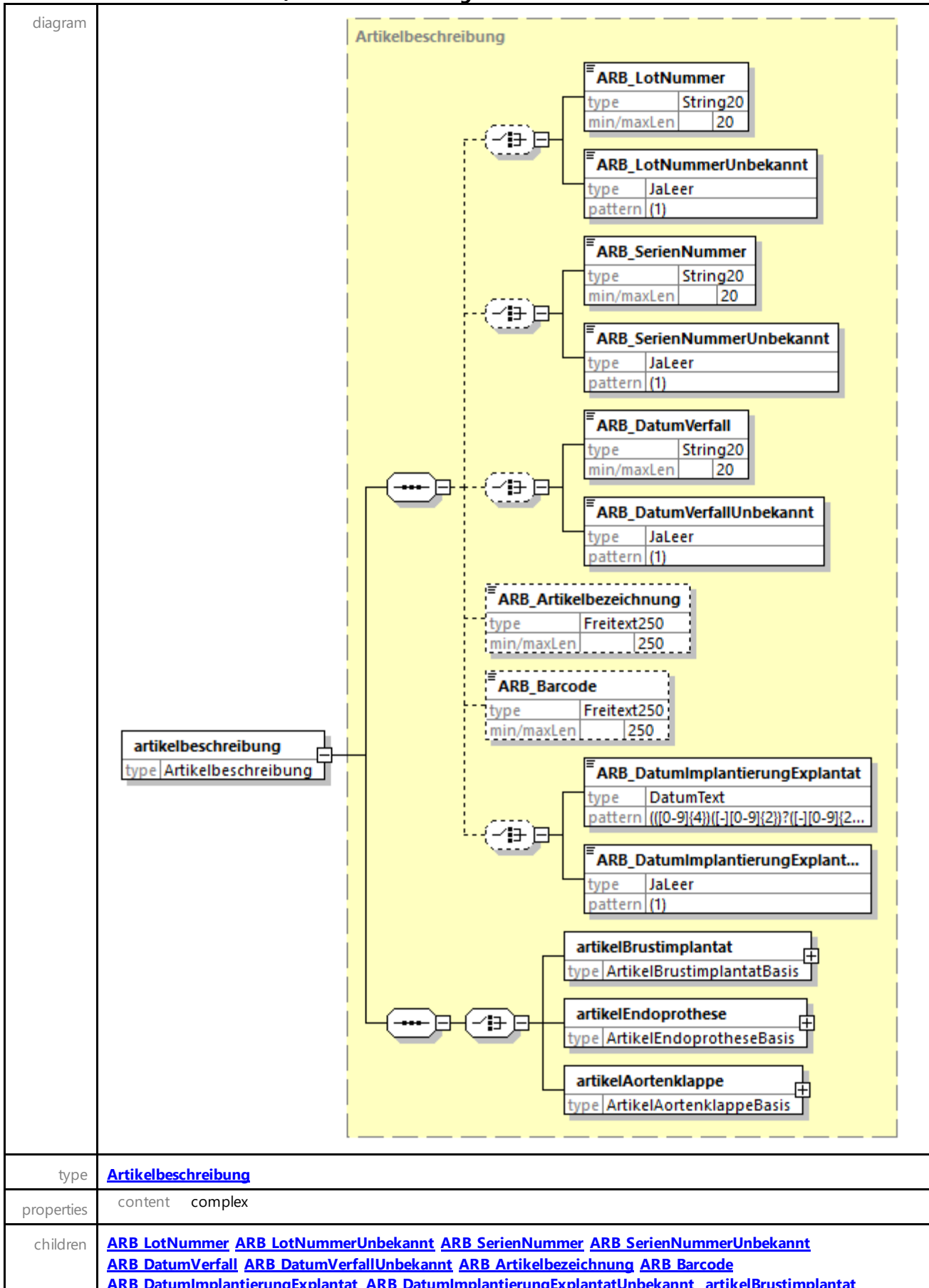

	artikelEndoprothese artikelAortenklappe
source	<code><element name="artikelbeschreibung" type="Artikelbeschreibung"/></code>

complexType **Zubehoer**

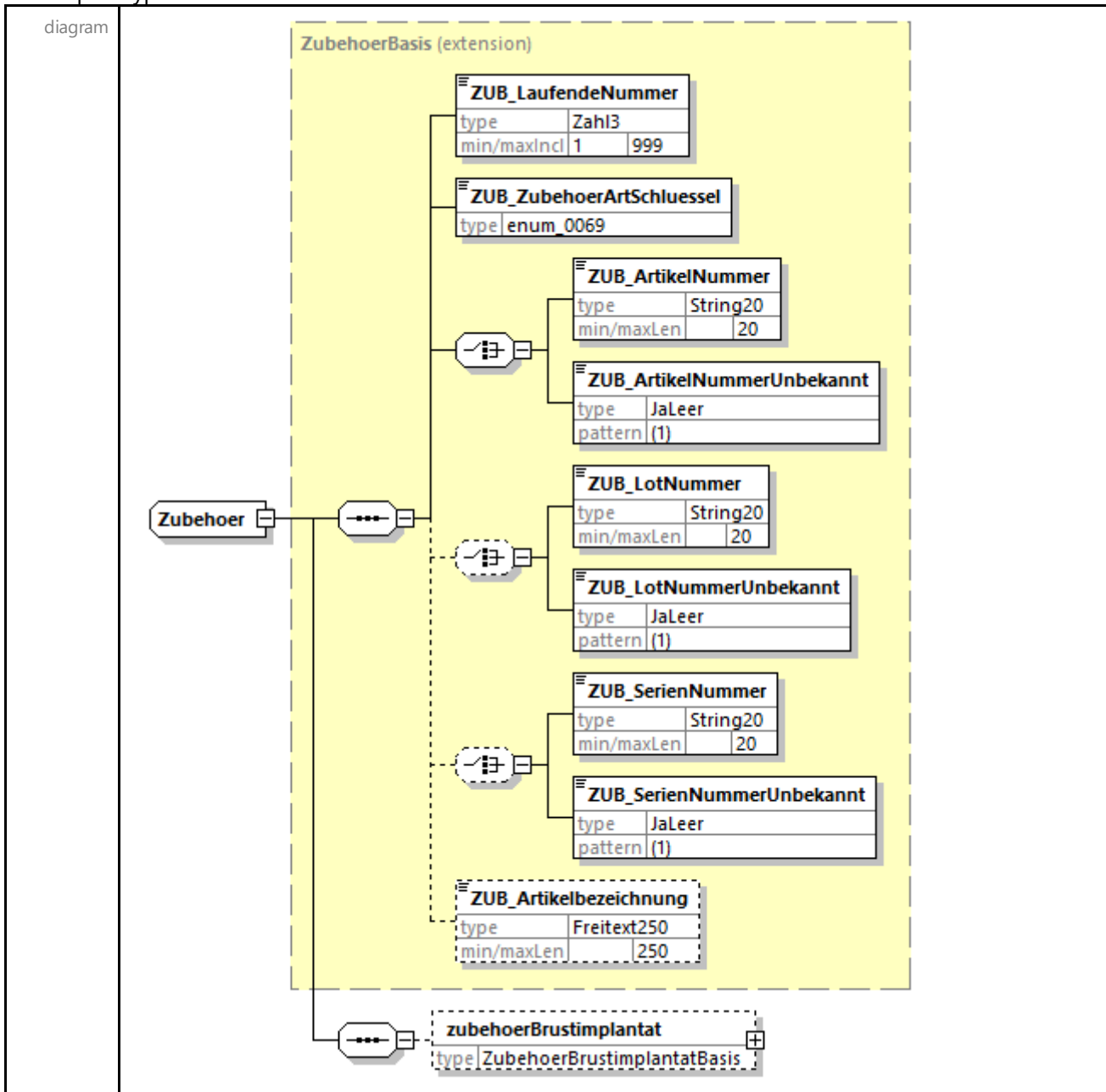

namespace	http://xml.ir-d.de/emg
type	extension of ZubehoerBasis
properties	base ZubehoerBasis
children	ZUB LaufendeNummer ZUB ZubehoerArtSchluessel ZUB ArtikelNummer ZUB ArtikelNummerUnbekannt ZUB LotNummer ZUB LotNummerUnbekannt ZUB SerienNummer ZUB SerienNummerUnbekannt ZUB Artikelbezeichnung zubehoerBrustimplantat
used by	element Operation/zubehoer
source	<code><complexType name="Zubehoer"></code>

	<pre> <complexContent> <extension base="ZubehoerBasis"> <sequence> <element name="zubehoerBrustimplantat" type="ZubehoerBrustimplantatBasis" minOccurs="0"/> </sequence> </extension> </complexContent> </complexType> </pre>
--	---

element **Zubehoer/zubehoerBrustimplantat**

diagram	
type	ZubehoerBrustimplantatBasis
properties	minOcc 0 maxOcc 1 content complex
children	ZBI HerstellerSchluessel ZBI HerstellerUnbekannt ZBI HerstellerSonstiger ZBI ZubehoerTypSchluessel
source	<pre> <element name="zubehoerBrustimplantat" type="ZubehoerBrustimplantatBasis" minOccurs="0"/> </pre>

complexType **EntlassungBasis**

diagram	
namespace	http://xml.ir-d.de/emg
children	ENT Datum ENT GrundSchluessel
used by	complexType Entlassung
source	<pre> <complexType name="EntlassungBasis"> <sequence> <element name="ENT_Datum" type="xs:date"/> <element name="ENT_GrundSchluessel" type="String2" minOccurs="0"/> </sequence> </complexType> </pre>

	<pre> </sequence> </complexType> </pre>
--	---

element **EntlassungBasis/ENT_Datum**

diagram	
type	date
properties	content simple
source	<code><element name="ENT_Datum" type="xs:date"/></code>

element **EntlassungBasis/ENT_GrundSchluessel**

diagram	
type	String2
properties	minOcc 0 maxOcc 1 content simple
facets	Kind Value Annotation pattern ([0-9]{2})
source	<code><element name="ENT_GrundSchluessel" type="String2" minOccurs="0"/></code>

complexType **DiagnoseBrustimplantatBasis**

diagram	
namespace	http://xml.ir-d.de/emg
children	DBI_IcdSchluessel
used by	element Entlassung/diagnoseBrustimplantat
source	<pre> <complexType name="DiagnoseBrustimplantatBasis"> <sequence> <element name="DBI_IcdSchluessel" type="ICD"/> </sequence> </complexType> </pre>

element **DiagnoseBrustimplantatBasis/DBI_IcdSchluessel**

diagram	
---------	--

type	ICD						
properties	content simple						
facets	<table border="1"> <tr> <td>Kind</td> <td>Value</td> <td>Annotation</td> </tr> <tr> <td>pattern</td> <td><code>([a-zA-Z][0-9]{2}(\.[0-9]{1,2})?)(:[RLB])?</code></td> <td></td> </tr> </table>	Kind	Value	Annotation	pattern	<code>([a-zA-Z][0-9]{2}(\.[0-9]{1,2})?)(:[RLB])?</code>	
Kind	Value	Annotation					
pattern	<code>([a-zA-Z][0-9]{2}(\.[0-9]{1,2})?)(:[RLB])?</code>						
source	<code><element name="DBI_IcdSchluessel" type="ICD"/></code>						

complexType **DiagnoseEndoprotheseBasis**

diagram	<p>The diagram shows a rounded rectangle labeled 'DiagnoseEndoprotheseBasis' connected to a smaller rounded rectangle containing a sequence of three dots. This sequence is connected to a box labeled 'DEP_IcdSchluessel' which contains the following details:</p> <table border="1"> <tr> <td>type</td> <td>ICD</td> </tr> <tr> <td>pattern</td> <td><code>([a-zA-Z][0-9]{2}(\.[0-9]{1,2})?)(:...</code></td> </tr> </table>	type	ICD	pattern	<code>([a-zA-Z][0-9]{2}(\.[0-9]{1,2})?)(:...</code>
type	ICD				
pattern	<code>([a-zA-Z][0-9]{2}(\.[0-9]{1,2})?)(:...</code>				
namespace	http://xml.ir-d.de/emg				
children	DEP_IcdSchluessel				
used by	element Entlassung/diagnoseEndoprothese				
source	<pre><complexType name="DiagnoseEndoprotheseBasis"> <sequence> <element name="DEP_IcdSchluessel" type="ICD"/> </sequence> </complexType></pre>				

element **DiagnoseEndoprotheseBasis/DEP_IcdSchluessel**

diagram	<p>The diagram shows a box labeled 'DEP_IcdSchluessel' containing the following details:</p> <table border="1"> <tr> <td>type</td> <td>ICD</td> </tr> <tr> <td>pattern</td> <td><code>([a-zA-Z][0-9]{2}(\.[0-9]{1,2})?)(:...</code></td> </tr> </table>	type	ICD	pattern	<code>([a-zA-Z][0-9]{2}(\.[0-9]{1,2})?)(:...</code>		
type	ICD						
pattern	<code>([a-zA-Z][0-9]{2}(\.[0-9]{1,2})?)(:...</code>						
type	ICD						
properties	content simple						
facets	<table border="1"> <tr> <td>Kind</td> <td>Value</td> <td>Annotation</td> </tr> <tr> <td>pattern</td> <td><code>([a-zA-Z][0-9]{2}(\.[0-9]{1,2})?)(:[RLB])?</code></td> <td></td> </tr> </table>	Kind	Value	Annotation	pattern	<code>([a-zA-Z][0-9]{2}(\.[0-9]{1,2})?)(:[RLB])?</code>	
Kind	Value	Annotation					
pattern	<code>([a-zA-Z][0-9]{2}(\.[0-9]{1,2})?)(:[RLB])?</code>						
source	<code><element name="DEP_IcdSchluessel" type="ICD"/></code>						

complexType **DiagnoseAortenklappeBasis**

diagram	<p>The diagram shows a rounded rectangle labeled 'DiagnoseAortenklappeBasis' connected to a smaller rounded rectangle containing a sequence of three dots. This sequence is connected to a box labeled 'DAK_IcdSchluessel' which contains the following details:</p> <table border="1"> <tr> <td>type</td> <td>ICD</td> </tr> <tr> <td>pattern</td> <td><code>([a-zA-Z][0-9]{2}(\.[0-9]{1,2})?)(:...</code></td> </tr> </table>	type	ICD	pattern	<code>([a-zA-Z][0-9]{2}(\.[0-9]{1,2})?)(:...</code>
type	ICD				
pattern	<code>([a-zA-Z][0-9]{2}(\.[0-9]{1,2})?)(:...</code>				
namespace	http://xml.ir-d.de/emg				
children	DAK_IcdSchluessel				
used by	element Entlassung/diagnoseAortenklappe				
source	<pre><complexType name="DiagnoseAortenklappeBasis"> <sequence> <element name="DAK_IcdSchluessel" type="ICD"/> </sequence></pre>				

</complexType>

element **DiagnoseAortenklappeBasis/DAK_IcdSchluessel**

diagram	<table border="1"><tr><td colspan="2">DAK_IcdSchluessel</td></tr><tr><td>type</td><td>ICD</td></tr><tr><td>pattern</td><td>([a-zA-Z][0-9]{2}(\.[0-9]{1,2})?:(...</td></tr></table>	DAK_IcdSchluessel		type	ICD	pattern	([a-zA-Z][0-9]{2}(\.[0-9]{1,2})?:(...
DAK_IcdSchluessel							
type	ICD						
pattern	([a-zA-Z][0-9]{2}(\.[0-9]{1,2})?:(...						
type	ICD						
properties	content simple						
facets	<table border="1"><thead><tr><th>Kind</th><th>Value</th><th>Annotation</th></tr></thead><tbody><tr><td>pattern</td><td>([a-zA-Z][0-9]{2}(\.[0-9]{1,2})?:(:[RLB])?)</td><td></td></tr></tbody></table>	Kind	Value	Annotation	pattern	([a-zA-Z][0-9]{2}(\.[0-9]{1,2})?:(:[RLB])?)	
Kind	Value	Annotation					
pattern	([a-zA-Z][0-9]{2}(\.[0-9]{1,2})?:(:[RLB])?)						
source	<element name="DAK_IcdSchluessel" type="ICD"/>						

complexType PostoperationAortenklappeBasis

diagram

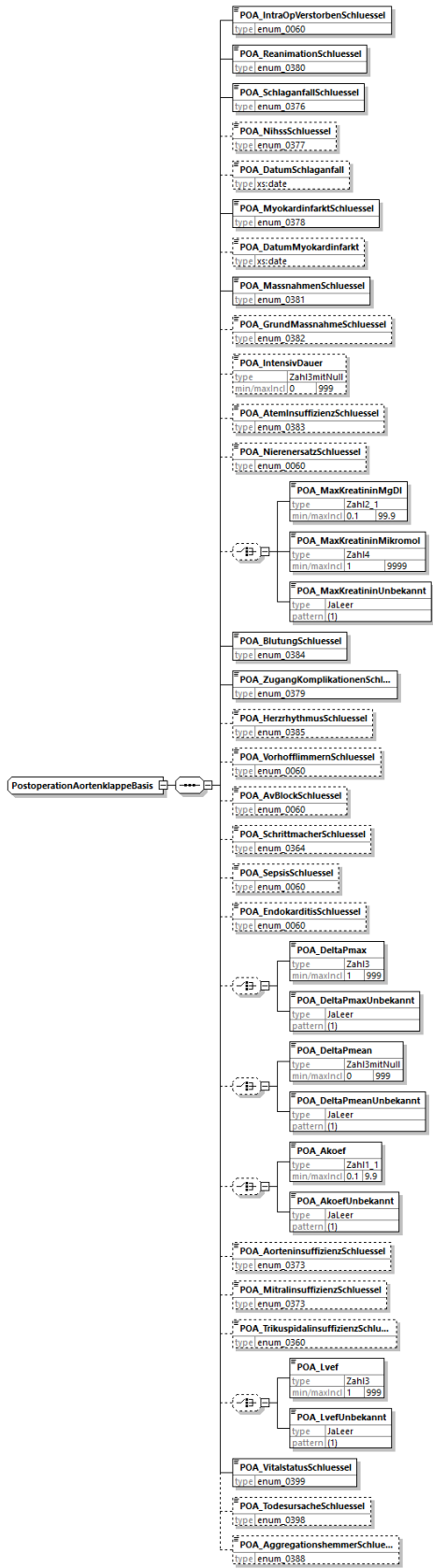

namespace <http://xml.ir-d.de/emg>

children [POA_IntraOpVerstorbenSchluessel](#) [POA_ReanimationSchluessel](#) [POA_SchlaganfallSchluessel](#) [POA_NihssSchluessel](#) [POA_DatumSchlaganfall](#) [POA_MyokardinfarktSchluessel](#) [POA_DatumMyokardinfarkt](#)

	POA MassnahmenSchluessel POA GrundMassnahmeSchluessel POA IntensivDauer POA AtemInsuffizienzSchluessel POA NierenersatzSchluessel POA MaxKreatininMgDl POA MaxKreatininMikromol POA MaxKreatininUnbekannt POA BlutungSchluessel POA ZugangKomplikationenSchluessel POA HerzrhythmusSchluessel POA VorhofflimmernSchluessel POA AvBlockSchluessel POA SchrittmacherSchluessel POA SepsisSchluessel POA EndokarditisSchluessel POA DeltaPmax POA DeltaPmaxUnbekannt POA DeltaPmean POA DeltaPmeanUnbekannt POA Akoef POA AkoefUnbekannt POA AorteninsuffizienzSchluessel POA MitralinsuffizienzSchluessel POA TrikuspidalinsuffizienzSchluessel POA Lvef POA LvefUnbekannt POA VitalstatusSchluessel POA TodesursacheSchluessel POA AggregationshemmerSchluessel
used by	complexType PostoperationAortenklappe
source	<pre> <complexType name="PostoperationAortenklappeBasis"> <sequence> <element name="POA_IntraOpVerstorbenSchluessel" type="enum_0060"/> <element name="POA_ReanimationSchluessel" type="enum_0380"/> <element name="POA_SchlaganfallSchluessel" type="enum_0376"/> <element name="POA_NihssSchluessel" type="enum_0377" minOccurs="0"/> <element name="POA_DatumSchlaganfall" type="xs:date" minOccurs="0"/> <element name="POA_MyokardinfarktSchluessel" type="enum_0378"/> <element name="POA_DatumMyokardinfarkt" type="xs:date" minOccurs="0"/> <element name="POA_MassnahmenSchluessel" type="enum_0381"/> <element name="POA_GrundMassnahmeSchluessel" type="enum_0382" minOccurs="0"/> <element name="POA_IntensivDauer" type="Zahl3mitNull" minOccurs="0"/> <element name="POA_AtemInsuffizienzSchluessel" type="enum_0383" minOccurs="0"/> <element name="POA_NierenersatzSchluessel" type="enum_0060" minOccurs="0"/> <choice minOccurs="0"> <element name="POA_MaxKreatininMgDl" type="Zahl2_1"/> <element name="POA_MaxKreatininMikromol" type="Zahl4"/> <element name="POA_MaxKreatininUnbekannt" type="JaLeer"/> </choice> <element name="POA_BlutungSchluessel" type="enum_0384"/> <element name="POA_ZugangKomplikationenSchluessel" type="enum_0379"/> <element name="POA_HerzrhythmusSchluessel" type="enum_0385" minOccurs="0"/> <element name="POA_VorhofflimmernSchluessel" type="enum_0060" minOccurs="0"/> <element name="POA_AvBlockSchluessel" type="enum_0060" minOccurs="0"/> <element name="POA_SchrittmacherSchluessel" type="enum_0364" minOccurs="0"/> <element name="POA_SepsisSchluessel" type="enum_0060" minOccurs="0"/> <element name="POA_EndokarditisSchluessel" type="enum_0060" minOccurs="0"/> <choice minOccurs="0"> <element name="POA_DeltaPmax" type="Zahl3"/> <element name="POA_DeltaPmaxUnbekannt" type="JaLeer"/> </choice> <choice minOccurs="0"> <element name="POA_DeltaPmean" type="Zahl3mitNull"/> <element name="POA_DeltaPmeanUnbekannt" type="JaLeer"/> </choice> <choice minOccurs="0"> <element name="POA_Akoef" type="Zahl1_1"/> <element name="POA_AkoefUnbekannt" type="JaLeer"/> </choice> <element name="POA_AorteninsuffizienzSchluessel" type="enum_0373" minOccurs="0"/> <element name="POA MitralinsuffizienzSchluessel" type="enum_0373" </pre>

	<pre> minOccurs="0"/> <element name="POA_TrikuspidalinsuffizienzSchluessel" type="enum_0360" minOccurs="0"/> <choice minOccurs="0"> <element name="POA_Lvef" type="Zahl3"/> <element name="POA_LvefUnbekannt" type="JaLeer"/> </choice> <element name="POA_VitalstatusSchluessel" type="enum_0399"/> <element name="POA_TodesursacheSchluessel" type="enum_0398" minOccurs="0"/> <element name="POA_AggregationshemmerSchluessel" type="enum_0388" minOccurs="0"/> </sequence> </complexType> </pre>
--	---

element **PostoperationAortenklappeBasis/POA_IntraOpVerstorbenSchluessel**

diagram										
type	enum_0060									
properties	content simple									
facets	<table border="1"> <thead> <tr> <th>Kind</th> <th>Value</th> <th>Annotation</th> </tr> </thead> <tbody> <tr> <td>enumeration</td> <td>0060001</td> <td>documentation ja</td> </tr> <tr> <td>enumeration</td> <td>0060002</td> <td>documentation nein</td> </tr> </tbody> </table>	Kind	Value	Annotation	enumeration	0060001	documentation ja	enumeration	0060002	documentation nein
Kind	Value	Annotation								
enumeration	0060001	documentation ja								
enumeration	0060002	documentation nein								
source	<code><element name="POA_IntraOpVerstorbenSchluessel" type="enum_0060"/></code>									

element **PostoperationAortenklappeBasis/POA_ReanimationSchluessel**

diagram																
type	enum_0380															
properties	content simple															
facets	<table border="1"> <thead> <tr> <th>Kind</th> <th>Value</th> <th>Annotation</th> </tr> </thead> <tbody> <tr> <td>enumeration</td> <td>0380001</td> <td>documentation nein</td> </tr> <tr> <td>enumeration</td> <td>0380002</td> <td>documentation ja, intraprozedural</td> </tr> <tr> <td>enumeration</td> <td>0380003</td> <td>documentation ja, postprozedural</td> </tr> <tr> <td>enumeration</td> <td>0380004</td> <td>documentation ja, Zeitpunkt nicht bekannt</td> </tr> </tbody> </table>	Kind	Value	Annotation	enumeration	0380001	documentation nein	enumeration	0380002	documentation ja, intraprozedural	enumeration	0380003	documentation ja, postprozedural	enumeration	0380004	documentation ja, Zeitpunkt nicht bekannt
Kind	Value	Annotation														
enumeration	0380001	documentation nein														
enumeration	0380002	documentation ja, intraprozedural														
enumeration	0380003	documentation ja, postprozedural														
enumeration	0380004	documentation ja, Zeitpunkt nicht bekannt														
source	<code><element name="POA_ReanimationSchluessel" type="enum_0380"/></code>															

element **PostoperationAortenklappeBasis/POA_SchlaganfallSchluessel**

diagram	
---------	--

type	enum_0376															
properties	content simple															
facets	<table border="1"> <thead> <tr> <th>Kind</th> <th>Value</th> <th>Annotation</th> </tr> </thead> <tbody> <tr> <td>enumeration</td> <td>0376001</td> <td>documentation nein</td> </tr> <tr> <td>enumeration</td> <td>0376002</td> <td>documentation ja, ZNS, zerebrovaskuläre Blutung</td> </tr> <tr> <td>enumeration</td> <td>0376003</td> <td>documentation ja, ZNS, zerebrovaskuläre Ischämie</td> </tr> <tr> <td>enumeration</td> <td>0376042</td> <td>documentation ja, ZNS, andere</td> </tr> </tbody> </table>	Kind	Value	Annotation	enumeration	0376001	documentation nein	enumeration	0376002	documentation ja, ZNS, zerebrovaskuläre Blutung	enumeration	0376003	documentation ja, ZNS, zerebrovaskuläre Ischämie	enumeration	0376042	documentation ja, ZNS, andere
Kind	Value	Annotation														
enumeration	0376001	documentation nein														
enumeration	0376002	documentation ja, ZNS, zerebrovaskuläre Blutung														
enumeration	0376003	documentation ja, ZNS, zerebrovaskuläre Ischämie														
enumeration	0376042	documentation ja, ZNS, andere														
source	<code><element name="POA_SchlaganfallSchluessel" type="enum_0376"/></code>															

element **PostoperationAortenklappeBasis/POA_NihssSchluessel**

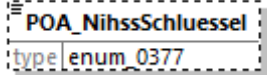
diagram													
type	enum_0377												
properties	minOcc 0 maxOcc 1 content simple												
facets	<table border="1"> <thead> <tr> <th>Kind</th> <th>Value</th> <th>Annotation</th> </tr> </thead> <tbody> <tr> <td>enumeration</td> <td>0377001</td> <td>documentation ja, mild neurological dysfunction: NIHSS 0-5</td> </tr> <tr> <td>enumeration</td> <td>0377002</td> <td>documentation ja, moderate neurological dysfunction: NIHSS 6-14</td> </tr> <tr> <td>enumeration</td> <td>0377003</td> <td>documentation ja, severe neurological dysfunction: NIHSS &gt;=15</td> </tr> </tbody> </table>	Kind	Value	Annotation	enumeration	0377001	documentation ja, mild neurological dysfunction: NIHSS 0-5	enumeration	0377002	documentation ja, moderate neurological dysfunction: NIHSS 6-14	enumeration	0377003	documentation ja, severe neurological dysfunction: NIHSS >=15
Kind	Value	Annotation											
enumeration	0377001	documentation ja, mild neurological dysfunction: NIHSS 0-5											
enumeration	0377002	documentation ja, moderate neurological dysfunction: NIHSS 6-14											
enumeration	0377003	documentation ja, severe neurological dysfunction: NIHSS >=15											
source	<code><element name="POA_NihssSchluessel" type="enum_0377" minOccurs="0"/></code>												

element **PostoperationAortenklappeBasis/POA_DatumSchlaganfall**

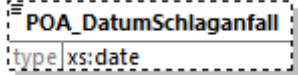
diagram	
type	date
properties	minOcc 0 maxOcc 1 content simple
source	<code><element name="POA_DatumSchlaganfall" type="xs:date" minOccurs="0"/></code>

element **PostoperationAortenklappeBasis/POA_MyokardinfarktSchluessel**

diagram							
type	enum_0378						
properties	content simple						
facets	<table border="1"> <thead> <tr> <th>Kind</th> <th>Value</th> <th>Annotation</th> </tr> </thead> <tbody> <tr> <td>enumeration</td> <td>0378001</td> <td>documentation</td> </tr> </tbody> </table>	Kind	Value	Annotation	enumeration	0378001	documentation
Kind	Value	Annotation					
enumeration	0378001	documentation					

	enumeration	0378002	nein documentation ja, < 48h gemäss VARC-3-Definition
	enumeration	0378003	documentation ja, >= 48h - <= 72h gemäß VARC-3-Definition
	enumeration	0378004	documentation ja, > 72 h gemäß VARC-3 Definition
source	<code><element name="POA_MyokardinfarktSchluessel" type="enum_0378"/></code>		

element **PostoperationAortenklappeBasis/POA_DatumMyokardinfarkt**

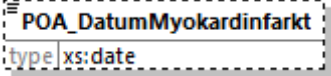
diagram			
type	date		
properties	minOcc	0	
	maxOcc	1	
	content	simple	
source	<code><element name="POA_DatumMyokardinfarkt" type="xs:date" minOccurs="0"/></code>		

element **PostoperationAortenklappeBasis/POA_MassnahmenSchluessel**

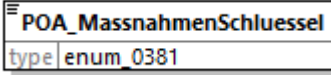
diagram			
type	enum 0381		
properties	content	simple	
facets	Kind	Value	Annotation
	enumeration	0381001	documentation nein
	enumeration	0381002	documentation Thorakotomie/Rethorakotomie
	enumeration	0381003	documentation kathetergestützte Reintervention
	enumeration	0381004	documentation lokale Reinterventionen
	enumeration	0381005	documentation andere Reintervention
source	<code><element name="POA_MassnahmenSchluessel" type="enum_0381"/></code>		

element **PostoperationAortenklappeBasis/POA_GrundMassnahmeSchluessel**

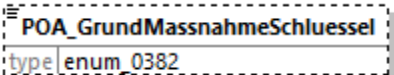
diagram			
type	enum 0382		
properties	minOcc	0	
	maxOcc	1	
	content	simple	
facets	Kind	Value	Annotation
	enumeration	0382001	documentation keine Rethorakotomie / kein weiterer Grund
	enumeration	0382002	documentation

	enumeration	0382003	Blutung/Hämatom documentation
	enumeration	0382004	Low Cardiac Output documentation
	enumeration	0382005	Tamponade documentation
	enumeration	0382006	Graftprobleme, Ischämie documentation
	enumeration	0382007	Wundinfektion, Mediastinitis documentation
	enumeration	0382008	Dissektion documentation
	enumeration	0382009	Prothesendysfunktion documentation
	enumeration	0382010	instabiles Sternum documentation
	enumeration	0382011	Chylothorax documentation
	enumeration	0382042	lokale Revision im Bereich des Zugangsweges documentation
			anderer Grund
source	<code><element name="POA_GrundMassnahmeSchluessel" type="enum_0382" minOccurs="0"/></code>		

element **PostoperationAortenklappeBasis/POA_IntensivDauer**

diagram			
type	Zahl3mitNull		
properties	minOcc	0	
	maxOcc	1	
	content	simple	
facets	Kind	Value	Annotation
	minInclusive	0	
	maxInclusive	999	
source	<code><element name="POA_IntensivDauer" type="Zahl3mitNull" minOccurs="0"/></code>		

element **PostoperationAortenklappeBasis/POA_AtemInsuffizienzSchluessel**

diagram			
type	enum 0383		
properties	minOcc	0	
	maxOcc	1	
	content	simple	
facets	Kind	Value	Annotation
	enumeration	0383001	documentation nein
	enumeration	0383002	documentation ja, mit forcierter Atemtherapie
	enumeration	0383003	documentation ja, Reintubation oder längerfristige Beatmung
	enumeration	0383004	documentation ja, Tracheotomie

source	<code><element name="POA_AtemInsuffizienzSchluessel" type="enum_0383" minOccurs="0"/></code>
--------	--

element **PostoperationAortenklappeBasis/POA_NierenersatzSchluessel**

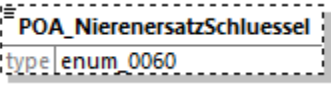
diagram										
type	enum_0060									
properties	minOcc 0 maxOcc 1 content simple									
facets	<table border="1"> <thead> <tr> <th>Kind</th> <th>Value</th> <th>Annotation</th> </tr> </thead> <tbody> <tr> <td>enumeration</td> <td>0060001</td> <td>documentation ja</td> </tr> <tr> <td>enumeration</td> <td>0060002</td> <td>documentation nein</td> </tr> </tbody> </table>	Kind	Value	Annotation	enumeration	0060001	documentation ja	enumeration	0060002	documentation nein
Kind	Value	Annotation								
enumeration	0060001	documentation ja								
enumeration	0060002	documentation nein								
source	<code><element name="POA_NierenersatzSchluessel" type="enum_0060" minOccurs="0"/></code>									

element **PostoperationAortenklappeBasis/POA_MaxKreatininMgDI**

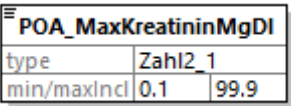
diagram																
type	Zahl2_1															
properties	content simple															
facets	<table border="1"> <thead> <tr> <th>Kind</th> <th>Value</th> <th>Annotation</th> </tr> </thead> <tbody> <tr> <td>minInclusive</td> <td>0.1</td> <td></td> </tr> <tr> <td>maxInclusive</td> <td>99.9</td> <td></td> </tr> <tr> <td>totalDigits</td> <td>3</td> <td></td> </tr> <tr> <td>fractionDigits</td> <td>1</td> <td></td> </tr> </tbody> </table>	Kind	Value	Annotation	minInclusive	0.1		maxInclusive	99.9		totalDigits	3		fractionDigits	1	
Kind	Value	Annotation														
minInclusive	0.1															
maxInclusive	99.9															
totalDigits	3															
fractionDigits	1															
source	<code><element name="POA_MaxKreatininMgDI" type="Zahl2_1"/></code>															

element **PostoperationAortenklappeBasis/POA_MaxKreatininMikromol**

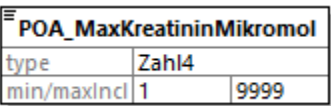
diagram										
type	Zahl4									
properties	content simple									
facets	<table border="1"> <thead> <tr> <th>Kind</th> <th>Value</th> <th>Annotation</th> </tr> </thead> <tbody> <tr> <td>minInclusive</td> <td>1</td> <td></td> </tr> <tr> <td>maxInclusive</td> <td>9999</td> <td></td> </tr> </tbody> </table>	Kind	Value	Annotation	minInclusive	1		maxInclusive	9999	
Kind	Value	Annotation								
minInclusive	1									
maxInclusive	9999									
source	<code><element name="POA_MaxKreatininMikromol" type="Zahl4"/></code>									

element **PostoperationAortenklappeBasis/POA_MaxKreatininUnbekannt**

diagram							
type	JaLeer						
properties	content simple						
facets	<table border="1"> <thead> <tr> <th>Kind</th> <th>Value</th> <th>Annotation</th> </tr> </thead> <tbody> <tr> <td>pattern</td> <td>(1)</td> <td></td> </tr> </tbody> </table>	Kind	Value	Annotation	pattern	(1)	
Kind	Value	Annotation					
pattern	(1)						
source	<code><element name="POA_MaxKreatininUnbekannt" type="JaLeer"/></code>						

element **PostoperationAortenklappeBasis/POA_BlutungSchluessel**

diagram																
type	enum_0384															
properties	content simple															
facets	<table border="1"> <thead> <tr> <th>Kind</th> <th>Value</th> <th>Annotation</th> </tr> </thead> <tbody> <tr> <td>enumeration</td> <td>0384001</td> <td>documentation keine Blutungskomplikationen</td> </tr> <tr> <td>enumeration</td> <td>0384002</td> <td>documentation Geringfügige Blutung (Minor Bleeding - BARC type 2 or 3a)</td> </tr> <tr> <td>enumeration</td> <td>0384003</td> <td>documentation Starke Blutung (Major Bleeding - BARC type 3a)</td> </tr> <tr> <td>enumeration</td> <td>0384004</td> <td>documentation Lebensbedrohliche Blutung (Life-threatening or disabling bleeding - BARC type 3b or 3c or type 5)</td> </tr> </tbody> </table>	Kind	Value	Annotation	enumeration	0384001	documentation keine Blutungskomplikationen	enumeration	0384002	documentation Geringfügige Blutung (Minor Bleeding - BARC type 2 or 3a)	enumeration	0384003	documentation Starke Blutung (Major Bleeding - BARC type 3a)	enumeration	0384004	documentation Lebensbedrohliche Blutung (Life-threatening or disabling bleeding - BARC type 3b or 3c or type 5)
Kind	Value	Annotation														
enumeration	0384001	documentation keine Blutungskomplikationen														
enumeration	0384002	documentation Geringfügige Blutung (Minor Bleeding - BARC type 2 or 3a)														
enumeration	0384003	documentation Starke Blutung (Major Bleeding - BARC type 3a)														
enumeration	0384004	documentation Lebensbedrohliche Blutung (Life-threatening or disabling bleeding - BARC type 3b or 3c or type 5)														
source	<code><element name="POA_BlutungSchluessel" type="enum_0384"/></code>															

element **PostoperationAortenklappeBasis/POA_ZugangKomplikationenSchluessel**

diagram																
type	enum_0379															
properties	content simple															
facets	<table border="1"> <thead> <tr> <th>Kind</th> <th>Value</th> <th>Annotation</th> </tr> </thead> <tbody> <tr> <td>enumeration</td> <td>0379001</td> <td>documentation Keine gefäss- oder zugangsassoziierte Komplikationen</td> </tr> <tr> <td>enumeration</td> <td>0379002</td> <td>documentation Versagen des perkutanen Verschlusssystems</td> </tr> <tr> <td>enumeration</td> <td>0379003</td> <td>documentation Geringfügige Gefäßkomplikationen</td> </tr> <tr> <td>enumeration</td> <td>0379004</td> <td>documentation Erhebliche Gefäßkomplikationen</td> </tr> </tbody> </table>	Kind	Value	Annotation	enumeration	0379001	documentation Keine gefäss- oder zugangsassoziierte Komplikationen	enumeration	0379002	documentation Versagen des perkutanen Verschlusssystems	enumeration	0379003	documentation Geringfügige Gefäßkomplikationen	enumeration	0379004	documentation Erhebliche Gefäßkomplikationen
Kind	Value	Annotation														
enumeration	0379001	documentation Keine gefäss- oder zugangsassoziierte Komplikationen														
enumeration	0379002	documentation Versagen des perkutanen Verschlusssystems														
enumeration	0379003	documentation Geringfügige Gefäßkomplikationen														
enumeration	0379004	documentation Erhebliche Gefäßkomplikationen														
source	<code><element name="POA_ZugangKomplikationenSchluessel" type="enum_0379"/></code>															

element **PostoperationAortenklappeBasis/POA_HerzrhythmusSchluessel**

diagram																
type	enum 0385															
properties	minOcc 0 maxOcc 1 content simple															
facets	<table border="1"> <thead> <tr> <th>Kind</th> <th>Value</th> <th>Annotation</th> </tr> </thead> <tbody> <tr> <td>enumeration</td> <td>0385001</td> <td>documentation Sinusrhythmus</td> </tr> <tr> <td>enumeration</td> <td>0385002</td> <td>documentation Vorhofflimmern</td> </tr> <tr> <td>enumeration</td> <td>0385003</td> <td>documentation Patient verstorben (kein Herzrhythmus)</td> </tr> <tr> <td>enumeration</td> <td>0385042</td> <td>documentation anderer Rhythmus</td> </tr> </tbody> </table>	Kind	Value	Annotation	enumeration	0385001	documentation Sinusrhythmus	enumeration	0385002	documentation Vorhofflimmern	enumeration	0385003	documentation Patient verstorben (kein Herzrhythmus)	enumeration	0385042	documentation anderer Rhythmus
Kind	Value	Annotation														
enumeration	0385001	documentation Sinusrhythmus														
enumeration	0385002	documentation Vorhofflimmern														
enumeration	0385003	documentation Patient verstorben (kein Herzrhythmus)														
enumeration	0385042	documentation anderer Rhythmus														
source	<code><element name="POA_HerzrhythmusSchluessel" type="enum_0385" minOccurs="0"/></code>															

element **PostoperationAortenklappeBasis/POA_VorhofflimmernSchluessel**

diagram										
type	enum 0060									
properties	minOcc 0 maxOcc 1 content simple									
facets	<table border="1"> <thead> <tr> <th>Kind</th> <th>Value</th> <th>Annotation</th> </tr> </thead> <tbody> <tr> <td>enumeration</td> <td>0060001</td> <td>documentation ja</td> </tr> <tr> <td>enumeration</td> <td>0060002</td> <td>documentation nein</td> </tr> </tbody> </table>	Kind	Value	Annotation	enumeration	0060001	documentation ja	enumeration	0060002	documentation nein
Kind	Value	Annotation								
enumeration	0060001	documentation ja								
enumeration	0060002	documentation nein								
source	<code><element name="POA_VorhofflimmernSchluessel" type="enum_0060" minOccurs="0"/></code>									

element **PostoperationAortenklappeBasis/POA_AvBlockSchluessel**

diagram										
type	enum 0060									
properties	minOcc 0 maxOcc 1 content simple									
facets	<table border="1"> <thead> <tr> <th>Kind</th> <th>Value</th> <th>Annotation</th> </tr> </thead> <tbody> <tr> <td>enumeration</td> <td>0060001</td> <td>documentation ja</td> </tr> <tr> <td>enumeration</td> <td>0060002</td> <td>documentation nein</td> </tr> </tbody> </table>	Kind	Value	Annotation	enumeration	0060001	documentation ja	enumeration	0060002	documentation nein
Kind	Value	Annotation								
enumeration	0060001	documentation ja								
enumeration	0060002	documentation nein								
source	<code><element name="POA_AvBlockSchluessel" type="enum_0060" minOccurs="0"/></code>									

element **PostoperationAortenklappeBasis/POA_SchrittmacherSchluessel**

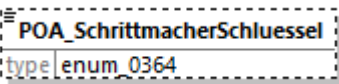
diagram																			
type	enum 0364																		
properties	minOcc 0 maxOcc 1 content simple																		
facets	<table border="1"> <thead> <tr> <th>Kind</th> <th>Value</th> <th>Annotation</th> </tr> </thead> <tbody> <tr> <td>enumeration</td> <td>0364001</td> <td>documentation nein</td> </tr> <tr> <td>enumeration</td> <td>0364002</td> <td>documentation Schrittmacher ohne CRT-System</td> </tr> <tr> <td>enumeration</td> <td>0364003</td> <td>documentation Schrittmacher mit CRT-System</td> </tr> <tr> <td>enumeration</td> <td>0364004</td> <td>documentation Defibrillator ohne CRT-System</td> </tr> <tr> <td>enumeration</td> <td>0364005</td> <td>documentation Defibrillator mit CRT-System</td> </tr> </tbody> </table>	Kind	Value	Annotation	enumeration	0364001	documentation nein	enumeration	0364002	documentation Schrittmacher ohne CRT-System	enumeration	0364003	documentation Schrittmacher mit CRT-System	enumeration	0364004	documentation Defibrillator ohne CRT-System	enumeration	0364005	documentation Defibrillator mit CRT-System
Kind	Value	Annotation																	
enumeration	0364001	documentation nein																	
enumeration	0364002	documentation Schrittmacher ohne CRT-System																	
enumeration	0364003	documentation Schrittmacher mit CRT-System																	
enumeration	0364004	documentation Defibrillator ohne CRT-System																	
enumeration	0364005	documentation Defibrillator mit CRT-System																	
source	<code><element name="POA_SchrittmacherSchluessel" type="enum_0364" minOccurs="0"/></code>																		

element **PostoperationAortenklappeBasis/POA_SepsisSchluessel**

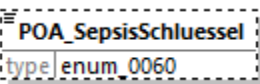
diagram										
type	enum 0060									
properties	minOcc 0 maxOcc 1 content simple									
facets	<table border="1"> <thead> <tr> <th>Kind</th> <th>Value</th> <th>Annotation</th> </tr> </thead> <tbody> <tr> <td>enumeration</td> <td>0060001</td> <td>documentation ja</td> </tr> <tr> <td>enumeration</td> <td>0060002</td> <td>documentation nein</td> </tr> </tbody> </table>	Kind	Value	Annotation	enumeration	0060001	documentation ja	enumeration	0060002	documentation nein
Kind	Value	Annotation								
enumeration	0060001	documentation ja								
enumeration	0060002	documentation nein								
source	<code><element name="POA_SepsisSchluessel" type="enum_0060" minOccurs="0"/></code>									

element **PostoperationAortenklappeBasis/POA_EndokarditisSchluessel**

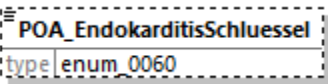
diagram										
type	enum 0060									
properties	minOcc 0 maxOcc 1 content simple									
facets	<table border="1"> <thead> <tr> <th>Kind</th> <th>Value</th> <th>Annotation</th> </tr> </thead> <tbody> <tr> <td>enumeration</td> <td>0060001</td> <td>documentation ja</td> </tr> <tr> <td>enumeration</td> <td>0060002</td> <td>documentation nein</td> </tr> </tbody> </table>	Kind	Value	Annotation	enumeration	0060001	documentation ja	enumeration	0060002	documentation nein
Kind	Value	Annotation								
enumeration	0060001	documentation ja								
enumeration	0060002	documentation nein								
source	<code><element name="POA_EndokarditisSchluessel" type="enum_0060" minOccurs="0"/></code>									

element **PostoperationAortenklappeBasis/POA_DeltaPmax**

diagram										
type	Zahl3									
properties	content simple									
facets	<table border="1"> <thead> <tr> <th>Kind</th> <th>Value</th> <th>Annotation</th> </tr> </thead> <tbody> <tr> <td>minInclusive</td> <td>1</td> <td></td> </tr> <tr> <td>maxInclusive</td> <td>999</td> <td></td> </tr> </tbody> </table>	Kind	Value	Annotation	minInclusive	1		maxInclusive	999	
Kind	Value	Annotation								
minInclusive	1									
maxInclusive	999									
source	<code><element name="POA_DeltaPmax" type="Zahl3"/></code>									

element **PostoperationAortenklappeBasis/POA_DeltaPmaxUnbekannt**

diagram							
type	JaLeer						
properties	content simple						
facets	<table border="1"> <thead> <tr> <th>Kind</th> <th>Value</th> <th>Annotation</th> </tr> </thead> <tbody> <tr> <td>pattern</td> <td>(1)</td> <td></td> </tr> </tbody> </table>	Kind	Value	Annotation	pattern	(1)	
Kind	Value	Annotation					
pattern	(1)						
source	<code><element name="POA_DeltaPmaxUnbekannt" type="JaLeer"/></code>						

element **PostoperationAortenklappeBasis/POA_DeltaPmean**

diagram										
type	Zahl3mitNull									
properties	content simple									
facets	<table border="1"> <thead> <tr> <th>Kind</th> <th>Value</th> <th>Annotation</th> </tr> </thead> <tbody> <tr> <td>minInclusive</td> <td>0</td> <td></td> </tr> <tr> <td>maxInclusive</td> <td>999</td> <td></td> </tr> </tbody> </table>	Kind	Value	Annotation	minInclusive	0		maxInclusive	999	
Kind	Value	Annotation								
minInclusive	0									
maxInclusive	999									
source	<code><element name="POA_DeltaPmean" type="Zahl3mitNull"/></code>									

element **PostoperationAortenklappeBasis/POA_DeltaPmeanUnbekannt**

diagram							
type	JaLeer						
properties	content simple						
facets	<table border="1"> <thead> <tr> <th>Kind</th> <th>Value</th> <th>Annotation</th> </tr> </thead> <tbody> <tr> <td>pattern</td> <td>(1)</td> <td></td> </tr> </tbody> </table>	Kind	Value	Annotation	pattern	(1)	
Kind	Value	Annotation					
pattern	(1)						

source	<code><element name="POA_DeltaPmeanUnbekannt" type="JaLeer"/></code>
--------	--

element **PostoperationAortenklappeBasis/POA_Akoef**

diagram																
type	Zahl1_1															
properties	content simple															
facets	<table border="1"> <thead> <tr> <th>Kind</th> <th>Value</th> <th>Annotation</th> </tr> </thead> <tbody> <tr> <td>minInclusive</td> <td>0.1</td> <td></td> </tr> <tr> <td>maxInclusive</td> <td>9.9</td> <td></td> </tr> <tr> <td>totalDigits</td> <td>2</td> <td></td> </tr> <tr> <td>fractionDigits</td> <td>1</td> <td></td> </tr> </tbody> </table>	Kind	Value	Annotation	minInclusive	0.1		maxInclusive	9.9		totalDigits	2		fractionDigits	1	
Kind	Value	Annotation														
minInclusive	0.1															
maxInclusive	9.9															
totalDigits	2															
fractionDigits	1															
source	<code><element name="POA_Akoef" type="Zahl1_1"/></code>															

element **PostoperationAortenklappeBasis/POA_AkoefUnbekannt**

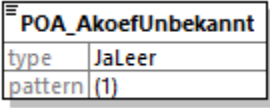
diagram							
type	JaLeer						
properties	content simple						
facets	<table border="1"> <thead> <tr> <th>Kind</th> <th>Value</th> <th>Annotation</th> </tr> </thead> <tbody> <tr> <td>pattern</td> <td>(1)</td> <td></td> </tr> </tbody> </table>	Kind	Value	Annotation	pattern	(1)	
Kind	Value	Annotation					
pattern	(1)						
source	<code><element name="POA_AkoefUnbekannt" type="JaLeer"/></code>						

element **PostoperationAortenklappeBasis/POA_AorteninsuffizienzSchluessel**

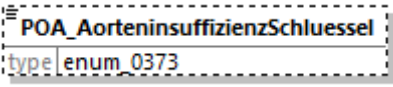
diagram																			
type	enum_0373																		
properties	<table border="1"> <tbody> <tr> <td>minOcc</td> <td>0</td> </tr> <tr> <td>maxOcc</td> <td>1</td> </tr> <tr> <td>content</td> <td>simple</td> </tr> </tbody> </table>	minOcc	0	maxOcc	1	content	simple												
minOcc	0																		
maxOcc	1																		
content	simple																		
facets	<table border="1"> <thead> <tr> <th>Kind</th> <th>Value</th> <th>Annotation</th> </tr> </thead> <tbody> <tr> <td>enumeration</td> <td>0373001</td> <td>documentation keine</td> </tr> <tr> <td>enumeration</td> <td>0373002</td> <td>documentation leichtgradig</td> </tr> <tr> <td>enumeration</td> <td>0373003</td> <td>documentation mittelgradig</td> </tr> <tr> <td>enumeration</td> <td>0373004</td> <td>documentation hochgradig</td> </tr> <tr> <td>enumeration</td> <td>0373099</td> <td>documentation unbekannt</td> </tr> </tbody> </table>	Kind	Value	Annotation	enumeration	0373001	documentation keine	enumeration	0373002	documentation leichtgradig	enumeration	0373003	documentation mittelgradig	enumeration	0373004	documentation hochgradig	enumeration	0373099	documentation unbekannt
Kind	Value	Annotation																	
enumeration	0373001	documentation keine																	
enumeration	0373002	documentation leichtgradig																	
enumeration	0373003	documentation mittelgradig																	
enumeration	0373004	documentation hochgradig																	
enumeration	0373099	documentation unbekannt																	
source	<code><element name="POA_AorteninsuffizienzSchluessel" type="enum_0373"></code>																		

	<code>minOccurs="0"/></code>
--	---------------------------------

element **PostoperationAortenklappeBasis/POA_MitralinsuffizienzSchluessel**

diagram																			
type	enum 0373																		
properties	minOcc 0 maxOcc 1 content simple																		
facets	<table border="1"> <thead> <tr> <th>Kind</th> <th>Value</th> <th>Annotation</th> </tr> </thead> <tbody> <tr> <td>enumeration</td> <td>0373001</td> <td>documentation keine</td> </tr> <tr> <td>enumeration</td> <td>0373002</td> <td>documentation leichtgradig</td> </tr> <tr> <td>enumeration</td> <td>0373003</td> <td>documentation mittelgradig</td> </tr> <tr> <td>enumeration</td> <td>0373004</td> <td>documentation hochgradig</td> </tr> <tr> <td>enumeration</td> <td>0373099</td> <td>documentation unbekannt</td> </tr> </tbody> </table>	Kind	Value	Annotation	enumeration	0373001	documentation keine	enumeration	0373002	documentation leichtgradig	enumeration	0373003	documentation mittelgradig	enumeration	0373004	documentation hochgradig	enumeration	0373099	documentation unbekannt
Kind	Value	Annotation																	
enumeration	0373001	documentation keine																	
enumeration	0373002	documentation leichtgradig																	
enumeration	0373003	documentation mittelgradig																	
enumeration	0373004	documentation hochgradig																	
enumeration	0373099	documentation unbekannt																	
source	<code><element name="POA_MitralinsuffizienzSchluessel" type="enum_0373" minOccurs="0"/></code>																		

element **PostoperationAortenklappeBasis/POA_TrikuspidalinsuffizienzSchluessel**

diagram																									
type	enum 0360																								
properties	minOcc 0 maxOcc 1 content simple																								
facets	<table border="1"> <thead> <tr> <th>Kind</th> <th>Value</th> <th>Annotation</th> </tr> </thead> <tbody> <tr> <td>enumeration</td> <td>0360001</td> <td>documentation keine</td> </tr> <tr> <td>enumeration</td> <td>0360002</td> <td>documentation leichtgradig</td> </tr> <tr> <td>enumeration</td> <td>0360003</td> <td>documentation mittelgradig</td> </tr> <tr> <td>enumeration</td> <td>0360004</td> <td>documentation hochgradig</td> </tr> <tr> <td>enumeration</td> <td>0360005</td> <td>documentation massive</td> </tr> <tr> <td>enumeration</td> <td>0360006</td> <td>documentation torrential</td> </tr> <tr> <td>enumeration</td> <td>0360099</td> <td>documentation unbekannt</td> </tr> </tbody> </table>	Kind	Value	Annotation	enumeration	0360001	documentation keine	enumeration	0360002	documentation leichtgradig	enumeration	0360003	documentation mittelgradig	enumeration	0360004	documentation hochgradig	enumeration	0360005	documentation massive	enumeration	0360006	documentation torrential	enumeration	0360099	documentation unbekannt
Kind	Value	Annotation																							
enumeration	0360001	documentation keine																							
enumeration	0360002	documentation leichtgradig																							
enumeration	0360003	documentation mittelgradig																							
enumeration	0360004	documentation hochgradig																							
enumeration	0360005	documentation massive																							
enumeration	0360006	documentation torrential																							
enumeration	0360099	documentation unbekannt																							
source	<code><element name="POA_TrikuspidalinsuffizienzSchluessel" type="enum_0360" minOccurs="0"/></code>																								

element **PostoperationAortenklappeBasis/POA_Lvef**

diagram										
type	Zahl3									
properties	content simple									
facets	<table border="1"> <thead> <tr> <th>Kind</th> <th>Value</th> <th>Annotation</th> </tr> </thead> <tbody> <tr> <td>minInclusive</td> <td>1</td> <td></td> </tr> <tr> <td>maxInclusive</td> <td>999</td> <td></td> </tr> </tbody> </table>	Kind	Value	Annotation	minInclusive	1		maxInclusive	999	
Kind	Value	Annotation								
minInclusive	1									
maxInclusive	999									
source	<code><element name="POA_Lvef" type="Zahl3"/></code>									

element **PostoperationAortenklappeBasis/POA_LvefUnbekannt**

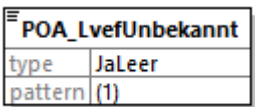
diagram							
type	JaLeer						
properties	content simple						
facets	<table border="1"> <thead> <tr> <th>Kind</th> <th>Value</th> <th>Annotation</th> </tr> </thead> <tbody> <tr> <td>pattern</td> <td>(1)</td> <td></td> </tr> </tbody> </table>	Kind	Value	Annotation	pattern	(1)	
Kind	Value	Annotation					
pattern	(1)						
source	<code><element name="POA_LvefUnbekannt" type="JaLeer"/></code>						

element **PostoperationAortenklappeBasis/POA_VitalstatusSchluessel**

diagram										
type	enum 0399									
properties	content simple									
facets	<table border="1"> <thead> <tr> <th>Kind</th> <th>Value</th> <th>Annotation</th> </tr> </thead> <tbody> <tr> <td>enumeration</td> <td>0399001</td> <td>documentation Patient lebt</td> </tr> <tr> <td>enumeration</td> <td>0399002</td> <td>documentation Patient im Krankenhaus verstorben</td> </tr> </tbody> </table>	Kind	Value	Annotation	enumeration	0399001	documentation Patient lebt	enumeration	0399002	documentation Patient im Krankenhaus verstorben
Kind	Value	Annotation								
enumeration	0399001	documentation Patient lebt								
enumeration	0399002	documentation Patient im Krankenhaus verstorben								
source	<code><element name="POA_VitalstatusSchluessel" type="enum_0399"/></code>									

element **PostoperationAortenklappeBasis/POA_TodesursacheSchluessel**

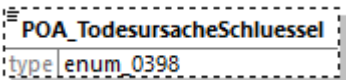
diagram							
type	enum 0398						
properties	<table border="1"> <tbody> <tr> <td>minOcc</td> <td>0</td> </tr> <tr> <td>maxOcc</td> <td>1</td> </tr> <tr> <td>content</td> <td>simple</td> </tr> </tbody> </table>	minOcc	0	maxOcc	1	content	simple
minOcc	0						
maxOcc	1						
content	simple						

facets	Kind	Value	Annotation
	enumeration	0398001	documentation kardiovaskuläre Ursache
	enumeration	0398002	documentation nicht-kardiovaskuläre Ursache
	enumeration	0398099	documentation Todesursache unbekannt
source	<code><element name="POA_TodesursacheSchluessel" type="enum_0398" minOccurs="0"/></code>		

element **PostoperationAortenklappeBasis/POA_AggregationshemmerSchluessel**

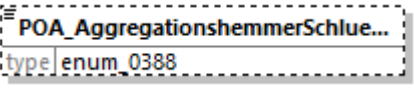
diagram			
type	enum 0388		
properties	minOcc 0 maxOcc 1 content simple		
facets	Kind	Value	Annotation
	enumeration	0388001	documentation nein
	enumeration	0388002	documentation ASS
	enumeration	0388003	documentation ADP-Rezeptor-Antagonist
	enumeration	0388004	documentation Kombination ASS und ADP-Rezeptor-Antagonist
	enumeration	0388042	documentation ja, andere
	enumeration	0388099	documentation unbekannt
source	<code><element name="POA_AggregationshemmerSchluessel" type="enum_0388" minOccurs="0"/></code>		

complexType **AntikoagulansAortenklappeBasis**

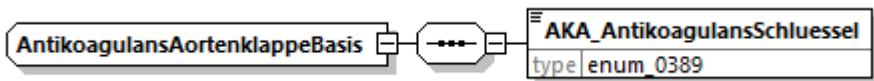
diagram	
namespace	http://xml.ir-d.de/emg
children	AKA_AntikoagulansSchluessel
used by	element PostoperationAortenklappe/antikoagulansAortenklappe
source	<code><complexType name="AntikoagulansAortenklappeBasis"> <sequence> <element name="AKA_AntikoagulansSchluessel" type="enum_0389"/> </sequence> </complexType></code>

element **AntikoagulansAortenklappeBasis/AKA_AntikoagulansSchluessel**

diagram			
type	enum 0389		
properties	content simple		
facets	Kind	Value	Annotation
	enumeration	0389001	documentation nein
	enumeration	0389002	documentation Cumarin-Derivate
	enumeration	0389003	documentation Heparinoide
	enumeration	0389004	documentation orale Thrombinantagonisten
	enumeration	0389006	documentation Direkte orale Antikoagulantien (DOAK / NOAK)
	enumeration	0389042	documentation ja, andere
	enumeration	0389099	documentation unbekannt
source	<code><element name="AKA_AntikoagulansSchluessel" type="enum_0389"/></code>		

complexType **PatientenaufnahmeKardiologieBasis**

diagram			
namespace	http://xml.ir-d.de/emg		

children	PKA NyhaSchluessel PKA Lvef PKA LvefUnbekannt PKA DiabetesSchluessel PKA NierenersatzSchluessel PKA KreatininwertMgdl PKA KreatininwertMikromol PKA KreatininwertUnbekannt
used by	complexType PatientenaufnahmeKardiologie
source	<pre><complexType name="PatientenaufnahmeKardiologieBasis"> <sequence> <element name="PKA_NyhaSchluessel" type="enum_0324"/> <choice> <element name="PKA_Lvef" type="Zahl3"/> <element name="PKA_LvefUnbekannt" type="JaLeer"/> </choice> <element name="PKA_DiabetesSchluessel" type="enum_0322"/> <element name="PKA_NierenersatzSchluessel" type="enum_0369"/> <choice minOccurs="0"> <element name="PKA_KreatininwertMgdl" type="Zahl2_1"/> <element name="PKA_KreatininwertMikromol" type="Zahl4"/> <element name="PKA_KreatininwertUnbekannt" type="JaLeer"/> </choice> </sequence> </complexType></pre>

element [PatientenaufnahmeKardiologieBasis/PKA_NyhaSchluessel](#)

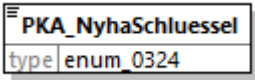
diagram																
type	enum 0324															
properties	content simple															
facets	<table border="1"> <thead> <tr> <th>Kind</th> <th>Value</th> <th>Annotation</th> </tr> </thead> <tbody> <tr> <td>enumeration</td> <td>0324001</td> <td>documentation (I): Beschwerdefreiheit, normale körperliche Belastbarkeit</td> </tr> <tr> <td>enumeration</td> <td>0324002</td> <td>documentation (II): Beschwerden bei stärkerer körperlicher Belastung</td> </tr> <tr> <td>enumeration</td> <td>0324003</td> <td>documentation (III): Beschwerden bei leichter körperlicher Belastung</td> </tr> <tr> <td>enumeration</td> <td>0324004</td> <td>documentation (IV): Beschwerden in Ruhe</td> </tr> </tbody> </table>	Kind	Value	Annotation	enumeration	0324001	documentation (I): Beschwerdefreiheit, normale körperliche Belastbarkeit	enumeration	0324002	documentation (II): Beschwerden bei stärkerer körperlicher Belastung	enumeration	0324003	documentation (III): Beschwerden bei leichter körperlicher Belastung	enumeration	0324004	documentation (IV): Beschwerden in Ruhe
Kind	Value	Annotation														
enumeration	0324001	documentation (I): Beschwerdefreiheit, normale körperliche Belastbarkeit														
enumeration	0324002	documentation (II): Beschwerden bei stärkerer körperlicher Belastung														
enumeration	0324003	documentation (III): Beschwerden bei leichter körperlicher Belastung														
enumeration	0324004	documentation (IV): Beschwerden in Ruhe														
source	<pre><element name="PKA_NyhaSchluessel" type="enum_0324"/></pre>															

element [PatientenaufnahmeKardiologieBasis/PKA_Lvef](#)

diagram										
type	Zahl3									
properties	content simple									
facets	<table border="1"> <thead> <tr> <th>Kind</th> <th>Value</th> <th>Annotation</th> </tr> </thead> <tbody> <tr> <td>minInclusive</td> <td>1</td> <td></td> </tr> <tr> <td>maxInclusive</td> <td>999</td> <td></td> </tr> </tbody> </table>	Kind	Value	Annotation	minInclusive	1		maxInclusive	999	
Kind	Value	Annotation								
minInclusive	1									
maxInclusive	999									
source	<pre><element name="PKA_Lvef" type="Zahl3"/></pre>									

element **PatientenaufnahmeKardiologieBasis/PKA_LvefUnbekannt**

diagram							
type	JaLeer						
properties	content simple						
facets	<table border="1"> <thead> <tr> <th>Kind</th> <th>Value</th> <th>Annotation</th> </tr> </thead> <tbody> <tr> <td>pattern</td> <td>(1)</td> <td></td> </tr> </tbody> </table>	Kind	Value	Annotation	pattern	(1)	
Kind	Value	Annotation					
pattern	(1)						
source	<code><element name="PKA_LvefUnbekannt" type="JaLeer"/></code>						

element **PatientenaufnahmeKardiologieBasis/PKA_DiabetesSchluessel**

diagram																						
type	enum 0322																					
properties	content simple																					
facets	<table border="1"> <thead> <tr> <th>Kind</th> <th>Value</th> <th>Annotation</th> </tr> </thead> <tbody> <tr> <td>enumeration</td> <td>0322001</td> <td>documentation nein</td> </tr> <tr> <td>enumeration</td> <td>0322002</td> <td>documentation ja, diätetisch behandelt</td> </tr> <tr> <td>enumeration</td> <td>0322003</td> <td>documentation ja, orale Medikation</td> </tr> <tr> <td>enumeration</td> <td>0322004</td> <td>documentation ja, mit Insulin behandelt</td> </tr> <tr> <td>enumeration</td> <td>0322005</td> <td>documentation ja, unbehandelt</td> </tr> <tr> <td>enumeration</td> <td>0322099</td> <td>documentation unbekannt</td> </tr> </tbody> </table>	Kind	Value	Annotation	enumeration	0322001	documentation nein	enumeration	0322002	documentation ja, diätetisch behandelt	enumeration	0322003	documentation ja, orale Medikation	enumeration	0322004	documentation ja, mit Insulin behandelt	enumeration	0322005	documentation ja, unbehandelt	enumeration	0322099	documentation unbekannt
Kind	Value	Annotation																				
enumeration	0322001	documentation nein																				
enumeration	0322002	documentation ja, diätetisch behandelt																				
enumeration	0322003	documentation ja, orale Medikation																				
enumeration	0322004	documentation ja, mit Insulin behandelt																				
enumeration	0322005	documentation ja, unbehandelt																				
enumeration	0322099	documentation unbekannt																				
source	<code><element name="PKA_DiabetesSchluessel" type="enum_0322"/></code>																					

element **PatientenaufnahmeKardiologieBasis/PKA_NierenersatzSchluessel**

diagram													
type	enum 0369												
properties	content simple												
facets	<table border="1"> <thead> <tr> <th>Kind</th> <th>Value</th> <th>Annotation</th> </tr> </thead> <tbody> <tr> <td>enumeration</td> <td>0369001</td> <td>documentation nein</td> </tr> <tr> <td>enumeration</td> <td>0369002</td> <td>documentation akut</td> </tr> <tr> <td>enumeration</td> <td>0369003</td> <td>documentation chronisch</td> </tr> </tbody> </table>	Kind	Value	Annotation	enumeration	0369001	documentation nein	enumeration	0369002	documentation akut	enumeration	0369003	documentation chronisch
Kind	Value	Annotation											
enumeration	0369001	documentation nein											
enumeration	0369002	documentation akut											
enumeration	0369003	documentation chronisch											
source	<code><element name="PKA_NierenersatzSchluessel" type="enum_0369"/></code>												

element **PatientenaufnahmeKardiologieBasis/PKA_KreatininwertMgdl**

diagram	<pre> PKA_KreatininwertMgdl type Zahl2_1 min/maxIncl 0.1 99.9 </pre>															
type	Zahl2_1															
properties	content simple															
facets	<table border="1"> <thead> <tr> <th>Kind</th> <th>Value</th> <th>Annotation</th> </tr> </thead> <tbody> <tr> <td>minInclusive</td> <td>0.1</td> <td></td> </tr> <tr> <td>maxInclusive</td> <td>99.9</td> <td></td> </tr> <tr> <td>totalDigits</td> <td>3</td> <td></td> </tr> <tr> <td>fractionDigits</td> <td>1</td> <td></td> </tr> </tbody> </table>	Kind	Value	Annotation	minInclusive	0.1		maxInclusive	99.9		totalDigits	3		fractionDigits	1	
Kind	Value	Annotation														
minInclusive	0.1															
maxInclusive	99.9															
totalDigits	3															
fractionDigits	1															
source	<code><element name="PKA_KreatininwertMgdl" type="Zahl2_1"/></code>															

element **PatientenaufnahmeKardiologieBasis/PKA_KreatininwertMikromol**

diagram	<pre> PKA_KreatininwertMikromol type Zahl4 min/maxIncl 1 9999 </pre>									
type	Zahl4									
properties	content simple									
facets	<table border="1"> <thead> <tr> <th>Kind</th> <th>Value</th> <th>Annotation</th> </tr> </thead> <tbody> <tr> <td>minInclusive</td> <td>1</td> <td></td> </tr> <tr> <td>maxInclusive</td> <td>9999</td> <td></td> </tr> </tbody> </table>	Kind	Value	Annotation	minInclusive	1		maxInclusive	9999	
Kind	Value	Annotation								
minInclusive	1									
maxInclusive	9999									
source	<code><element name="PKA_KreatininwertMikromol" type="Zahl4"/></code>									

element **PatientenaufnahmeKardiologieBasis/PKA_KreatininwertUnbekannt**

diagram	<pre> PKA_KreatininwertUnbekannt type JaLeer pattern (1) </pre>						
type	JaLeer						
properties	content simple						
facets	<table border="1"> <thead> <tr> <th>Kind</th> <th>Value</th> <th>Annotation</th> </tr> </thead> <tbody> <tr> <td>pattern</td> <td>(1)</td> <td></td> </tr> </tbody> </table>	Kind	Value	Annotation	pattern	(1)	
Kind	Value	Annotation					
pattern	(1)						
source	<code><element name="PKA_KreatininwertUnbekannt" type="JaLeer"/></code>						

complexType PatientenaufnahmeAortenklappe

diagram

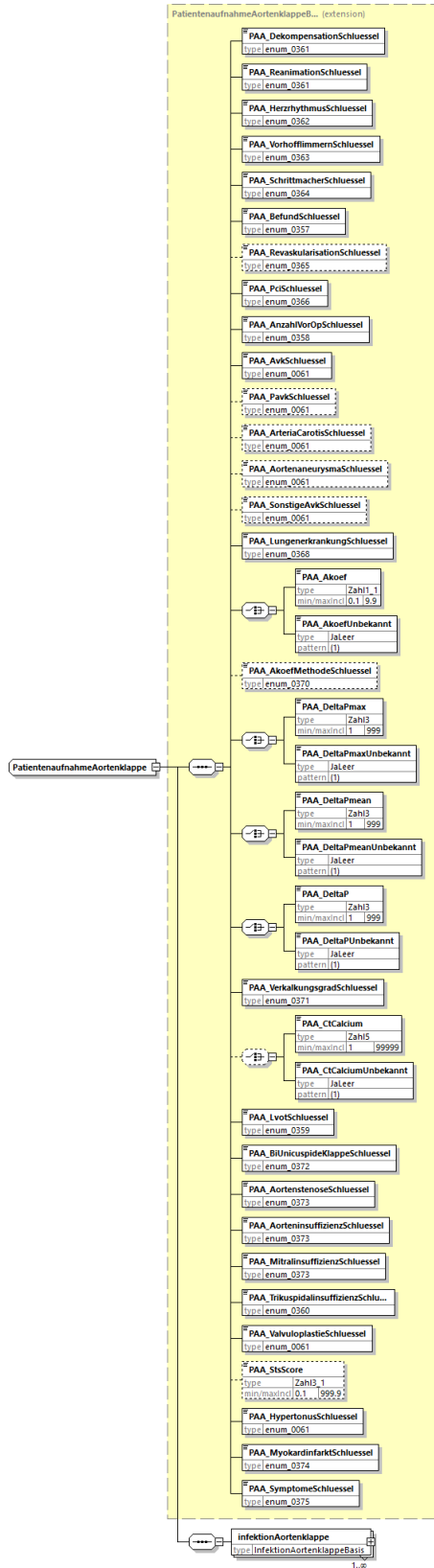

namespace	http://xml.ir-d.de/emg
type	extension of PatientenaufnahmeAortenklappeBasis
properties	base PatientenaufnahmeAortenklappeBasis

children	PAA DekompensationSchluessel PAA ReanimationSchluessel PAA HerzrhythmusSchluessel PAA VorhofflimmernSchluessel PAA SchrittmacherSchluessel PAA BefundSchluessel PAA RevaskularisationSchluessel PAA PciSchluessel PAA AnzahlVorOpSchluessel PAA AvkSchluessel PAA PavkSchluessel PAA ArteriaCarotisSchluessel PAA AortenaneurysmaSchluessel PAA SonstigeAvkSchluessel PAA LungenerkrankungSchluessel PAA Akoef PAA AkoefUnbekannt PAA AkoefMethodeSchluessel PAA DeltaPmax PAA DeltaPmaxUnbekannt PAA DeltaPmean PAA DeltaPmeanUnbekannt PAA DeltaP PAA DeltaPUnbekannt PAA VerkalkungsgradSchluessel PAA CtCalcium PAA CtCalciumUnbekannt PAA LvotSchluessel PAA BiUnicuspideKlappeSchluessel PAA AortenstenoseSchluessel PAA AorteninsuffizienzSchluessel PAA MitralsuffizienzSchluessel PAA TrikuspidalinsuffizienzSchluessel PAA ValvuloplastieSchluessel PAA StsScore PAA HypertonusSchluessel PAA MyokardinfarktSchluessel PAA SymptomeSchluessel infektionAortenklappe
used by	element PatientenaufnahmeKardiologie/patientenaufnahmeAortenklappe
source	<pre><complexType name="PatientenaufnahmeAortenklappe"> <complexContent> <extension base="PatientenaufnahmeAortenklappeBasis"> <sequence> <element name="infektionAortenklappe" type="InfektionAortenklappeBasis" maxOccurs="unbounded"/> </sequence> </extension> </complexContent> </complexType></pre>

element **PatientenaufnahmeAortenklappe/infektionAortenklappe**

diagram	
type	InfektionAortenklappeBasis
properties	minOcc 1 maxOcc unbounded content complex
children	IAK InfektionSchluessel
source	<pre><element name="infektionAortenklappe" type="InfektionAortenklappeBasis" maxOccurs="unbounded"/></pre>

complexType **OperationBrustimplantatBasis**

diagram	
namespace	http://xml.ir-d.de/emg
children	OBI_ArtEingriffSchluessel OBI_GrundPrimaerEingriffSchluessel OBI_GrundAustauschSchluessel OBI_GrundRevisionExplantationSchluessel OBI_LageSchluessel OBI_ZugangSchluessel OBI_EntfernungAdmNetzSchluessel OBI_VerfahrenswechselSchluessel
used by	complexType OperationBrustimplantat
source	<pre> <complexType name="OperationBrustimplantatBasis"> <sequence> <element name="OBI_ArtEingriffSchluessel" type="enum_0100"/> <choice> <element name="OBI_GrundPrimaerEingriffSchluessel" type="enum_0102"/> <element name="OBI_GrundAustauschSchluessel" type="enum_0104"/> <element name="OBI_GrundRevisionExplantationSchluessel" type="enum_0106"/> </choice> <element name="OBI_LageSchluessel" type="enum_0112" minOccurs="0"/> <element name="OBI_ZugangSchluessel" type="enum_0118" minOccurs="0"/> <element name="OBI_EntfernungAdmNetzSchluessel" type="enum_0114" minOccurs="0"/> <element name="OBI_VerfahrenswechselSchluessel" type="enum_0111" minOccurs="0"/> </sequence> </complexType> </pre>

element **OperationBrustimplantatBasis/OBI_ArtEingriffSchluessel**

diagram	
type	enum 0100

properties	content simple		
facets	Kind	Value	Annotation
	enumeration	0100002	documentation Austausch Expander gegen dauerhaftes Brustimplantat
	enumeration	0100003	documentation Wechsel
	enumeration	0100004	documentation Nur Explantation
	enumeration	0100005	documentation Ersteingriff
	enumeration	0100006	documentation Zweizeitige Implantation
source	<element name="OBI_ArtEingriffSchlüssel" type="enum_0100"/>		

element **OperationBrustimplantatBasis/OBI_GrundPrimaerEingriffSchlüssel**

diagram			
type	enum_0102		
properties	content simple		
facets	Kind	Value	Annotation
	enumeration	0102001	documentation kosmetische Augmentation
	enumeration	0102002	documentation Rekonstruktion, benigne
	enumeration	0102003	documentation Rekonstruktion nach Mastektomie aufgrund eines Karzinoms
	enumeration	0102004	documentation Rekonstruktion nach risikoreduzierender Mastektomie
source	<element name="OBI_GrundPrimaerEingriffSchlüssel" type="enum_0102"/>		

element **OperationBrustimplantatBasis/OBI_GrundAustauschSchlüssel**

diagram			
type	enum_0104		
properties	content simple		
facets	Kind	Value	Annotation
	enumeration	0104001	documentation Austausch Expander gegen dauerhaftes Brustimplantat
source	<element name="OBI_GrundAustauschSchlüssel" type="enum_0104"/>		

element **OperationBrustimplantatBasis/OBI_GrundRevisionExplantationSchlüssel**

diagram			
type	enum_0106		
properties	content simple		

facets	Kind	Value	Annotation
	enumeration	0106001	documentation Patientenwunsch
	enumeration	0106002	documentation asymptomatisch
	enumeration	0106003	documentation Komplikation
source	<code><element name="OBI_GrundRevisionExplantationSchluessel" type="enum_0106"/></code>		

element **OperationBrustimplantatBasis/OBI_LageSchluessel**

diagram			
type	enum 0112		
properties	minOcc	0	
	maxOcc	1	
	content	simple	
facets	Kind	Value	Annotation
	enumeration	0112001	documentation subglandulär / epipektoral
	enumeration	0112002	documentation subpektoral
	enumeration	0112003	documentation subfaszial
	enumeration	0112004	documentation sub-flap
	enumeration	0112005	documentation subkutan
	enumeration	0112006	documentation dual plane
	enumeration	0112042	documentation andere
source	<code><element name="OBI_LageSchluessel" type="enum_0112" minOccurs="0"/></code>		

element **OperationBrustimplantatBasis/OBI_ZugangSchluessel**

diagram			
type	enum 0118		
properties	minOcc	0	
	maxOcc	1	
	content	simple	
facets	Kind	Value	Annotation
	enumeration	0118001	documentation axillär
	enumeration	0118002	documentation periareolär
	enumeration	0118003	documentation inframammär
	enumeration	0118004	documentation Mastektomienarbe
	enumeration	0118042	documentation anderer
source	<code><element name="OBI_ZugangSchluessel" type="enum_0118" minOccurs="0"/></code>		

element **OperationBrustimplantatBasis/OBI_EntfernungAdmNetzSchluessel**

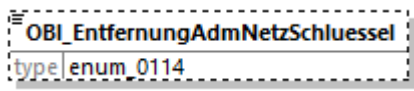
diagram																
type	enum 0114															
properties	minOcc 0 maxOcc 1 content simple															
facets	<table border="1"> <thead> <tr> <th>Kind</th> <th>Value</th> <th>Annotation</th> </tr> </thead> <tbody> <tr> <td>enumeration</td> <td>0114001</td> <td>documentation vollständig</td> </tr> <tr> <td>enumeration</td> <td>0114002</td> <td>documentation nein</td> </tr> <tr> <td>enumeration</td> <td>0114003</td> <td>documentation teilweise</td> </tr> <tr> <td>enumeration</td> <td>0114004</td> <td>documentation nicht vorhanden</td> </tr> </tbody> </table>	Kind	Value	Annotation	enumeration	0114001	documentation vollständig	enumeration	0114002	documentation nein	enumeration	0114003	documentation teilweise	enumeration	0114004	documentation nicht vorhanden
Kind	Value	Annotation														
enumeration	0114001	documentation vollständig														
enumeration	0114002	documentation nein														
enumeration	0114003	documentation teilweise														
enumeration	0114004	documentation nicht vorhanden														
source	<code><element name="OBI_EntfernungAdmNetzSchluessel" type="enum_0114" minOccurs="0"/></code>															

element **OperationBrustimplantatBasis/OBI_VerfahrenswechselSchluessel**

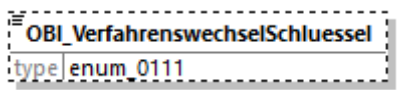
diagram													
type	enum 0111												
properties	minOcc 0 maxOcc 1 content simple												
facets	<table border="1"> <thead> <tr> <th>Kind</th> <th>Value</th> <th>Annotation</th> </tr> </thead> <tbody> <tr> <td>enumeration</td> <td>0111001</td> <td>documentation nein</td> </tr> <tr> <td>enumeration</td> <td>0111002</td> <td>documentation Lipofilling</td> </tr> <tr> <td>enumeration</td> <td>0111003</td> <td>documentation Eigengewebsrekonstruktion</td> </tr> </tbody> </table>	Kind	Value	Annotation	enumeration	0111001	documentation nein	enumeration	0111002	documentation Lipofilling	enumeration	0111003	documentation Eigengewebsrekonstruktion
Kind	Value	Annotation											
enumeration	0111001	documentation nein											
enumeration	0111002	documentation Lipofilling											
enumeration	0111003	documentation Eigengewebsrekonstruktion											
source	<code><element name="OBI_VerfahrenswechselSchluessel" type="enum_0111" minOccurs="0"/></code>												

complexType **VorbehandlungBrustimplantatBasis**

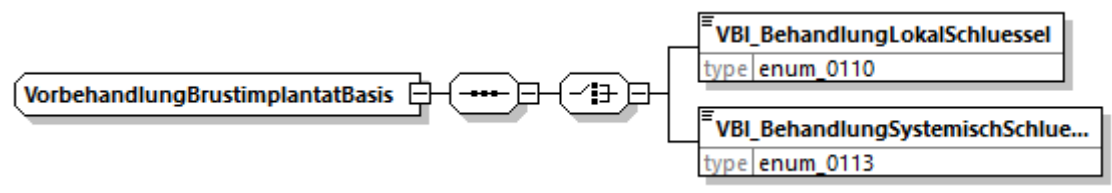
diagram	
namespace	http://xml.ir-d.de/emg
children	VBI_BehandlungLokalSchluessel VBI_BehandlungSystemischSchluessel
used by	element OperationBrustimplantat/vorbehandlungBrustimplantat

source	<pre><complexType name="VorbehandlungBrustimplantatBasis"> <sequence> <choice> <element name="VBI_BehandlungLokalSchluessel" type="enum_0110"/> <element name="VBI_BehandlungSystemischSchluessel" type="enum_0113"/> </choice> </sequence> </complexType></pre>
--------	--

element **VorbehandlungBrustimplantatBasis/VBI_BehandlungLokalSchluessel**

diagram							
type	enum 0110						
properties	content simple						
facets	<table border="1"> <thead> <tr> <th>Kind</th> <th>Value</th> <th>Annotation</th> </tr> </thead> <tbody> <tr> <td>enumeration</td> <td>0110001</td> <td>documentation Bestrahlung</td> </tr> </tbody> </table>	Kind	Value	Annotation	enumeration	0110001	documentation Bestrahlung
Kind	Value	Annotation					
enumeration	0110001	documentation Bestrahlung					
source	<pre><element name="VBI_BehandlungLokalSchluessel" type="enum_0110"/></pre>						

element **VorbehandlungBrustimplantatBasis/VBI_BehandlungSystemischSchluessel**

diagram							
type	enum 0113						
properties	content simple						
facets	<table border="1"> <thead> <tr> <th>Kind</th> <th>Value</th> <th>Annotation</th> </tr> </thead> <tbody> <tr> <td>enumeration</td> <td>0113001</td> <td>documentation Chemotherapie innerhalb der letzten drei Monate</td> </tr> </tbody> </table>	Kind	Value	Annotation	enumeration	0113001	documentation Chemotherapie innerhalb der letzten drei Monate
Kind	Value	Annotation					
enumeration	0113001	documentation Chemotherapie innerhalb der letzten drei Monate					
source	<pre><element name="VBI_BehandlungSystemischSchluessel" type="enum_0113"/></pre>						

complexType **MassnahmeBrustimplantatBasis**

diagram	
namespace	http://xml.lir-d.de/emg
children	MAB_MassnahmeSchluessel
used by	element OperationBrustimplantat/massnahmeBrustimplantat
source	<pre><complexType name="MassnahmeBrustimplantatBasis"> <sequence> <element name="MAB_MassnahmeSchluessel" type="enum_0116"/> </sequence> </complexType></pre>

element **MassnahmeBrustimplantatBasis/MAB_MassnahmeSchluessel**

diagram			
type	enum 0116		
properties	content simple		
facets	Kind	Value	Annotation
	enumeration	0116001	documentation Spülung, antibiotisch
	enumeration	0116002	documentation Spülung, antiseptisch
	enumeration	0116003	documentation Spülung, wirkstofffrei
	enumeration	0116004	documentation Spülung, andere
	enumeration	0116005	documentation prä-/perioperative Antibiotika
	enumeration	0116006	documentation postoperative Antibiotika
	enumeration	0116007	documentation Handschuhwechsel vor Implantation
	enumeration	0116008	documentation Implantationshilfe
source	<code><element name="MAB_MassnahmeSchluessel" type="enum_0116"/></code>		

complexType **OperationsdetailBrustimplantatBasis**

diagram			
namespace	http://xml.ir-d.de/emg		
children	ODB_OperationsdetailPrimaerEingriffSchluessel ODB_OperationsdetailAustauschSchluessel ODB_OperationsdetailRevisionSchluessel		
used by	element	OperationBrustimplantat/operationsdetailBrustimplantat	
source	<pre> <complexType name="OperationsdetailBrustimplantatBasis"> <sequence> <choice> <element name="ODB_OperationsdetailPrimaerEingriffSchluessel" type="enum_0103"/> <element name="ODB_OperationsdetailAustauschSchluessel" type="enum_0105"/> <element name="ODB_OperationsdetailRevisionSchluessel" type="enum_0107"/> </choice> </sequence> </complexType> </pre>		

element **OperationsdetailBrustimplantatBasis/ODB_OperationsdetailPrimaerEingriffSchluessel**

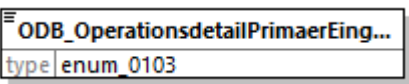
diagram			
type	enum 0103		
properties	content simple		
facets	Kind	Value	Annotation
	enumeration	0103001	documentation simultane Lappendeckung
	enumeration	0103002	documentation simultane Eigenfetttransplantation
	enumeration	0103003	documentation simultane Mastopexie
	enumeration	0103005	documentation simultane Mastektomie, Ablatio / hautsparend
	enumeration	0103006	documentation simultane Mastektomie, nippelerhaltend
	enumeration	0103007	documentation Axilla-Dissektion
	enumeration	0103008	documentation Drainage
source	<pre><element name="ODB_OperationsdetailPrimaerEingriffSchluessel" type="enum_0103"/></pre>		

element **OperationsdetailBrustimplantatBasis/ODB_OperationsdetailAustauschSchluessel**

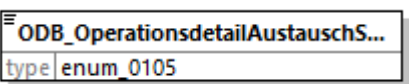
diagram			
type	enum 0105		
properties	content simple		
facets	Kind	Value	Annotation
	enumeration	0105001	documentation simultane Lappendeckung
	enumeration	0105002	documentation simultane Eigenfetttransplantation
	enumeration	0105003	documentation simultane Mastopexie
	enumeration	0105008	documentation Drainage
	enumeration	0105009	documentation Kapsulektomie, komplett
	enumeration	0105010	documentation Kapsulektomie, partiell
	enumeration	0105011	documentation Neopocket
source	<pre><element name="ODB_OperationsdetailAustauschSchluessel" type="enum_0105"/></pre>		

element **OperationsdetailBrustimplantatBasis/ODB_OperationsdetailRevisionSchluessel**

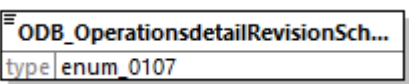
diagram			
type	enum 0107		

properties	content simple		
facets	Kind	Value	Annotation
	enumeration	0107001	documentation simultane Lappendeckung
	enumeration	0107002	documentation simultane Eigenfetttransplantation
	enumeration	0107003	documentation simultane Mastopexie
	enumeration	0107005	documentation simultane Mastektomie, Ablatio / hautsparend
	enumeration	0107006	documentation simultane Mastektomie, nippelerhaltend
	enumeration	0107007	documentation Axilla-Dissektion
	enumeration	0107008	documentation Drainage
	enumeration	0107009	documentation Kapsulektomie, komplett
	enumeration	0107010	documentation Kapsulektomie, partiell
	enumeration	0107011	documentation Neopocket
source	<code><element name="ODB_OperationsdetailRevisionSchluessel" type="enum_0107"/></code>		

complexType **BefundBrustimplantatBasis**

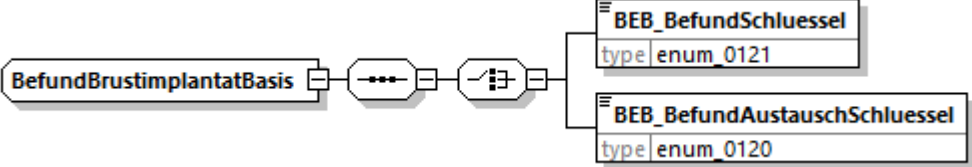
diagram	
namespace	http://xml.ir-d.de/emg
children	BEB_BefundSchluessel BEB_BefundAustauschSchluessel
used by	element OperationBrustimplantat/befundBrustimplantat
source	<pre> <complexType name="BefundBrustimplantatBasis"> <sequence> <choice> <element name="BEB_BefundSchluessel" type="enum_0121"/> <element name="BEB_BefundAustauschSchluessel" type="enum_0120"/> </choice> </sequence> </complexType> </pre>

element **BefundBrustimplantatBasis/BEB_BefundSchluessel**

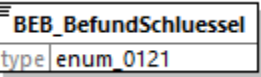
diagram							
type	enum 0121						
properties	content simple						
facets	<table border="1"> <tr> <td>Kind</td> <td>Value</td> <td>Annotation</td> </tr> <tr> <td>enumeration</td> <td>0121001</td> <td>documentation</td> </tr> </table>	Kind	Value	Annotation	enumeration	0121001	documentation
Kind	Value	Annotation					
enumeration	0121001	documentation					

	enumeration	0121002	Infektion documentation Serom
	enumeration	0121004	documentation Kapselfibrose
	enumeration	0121005	documentation Implantatruptur
	enumeration	0121006	documentation Fehlpositionierung/Rotation
	enumeration	0121007	documentation BIA-ALCL/-BCL/-SCC, Verdacht
	enumeration	0121008	documentation BIA-ALCL/-BCL/-SCC, pathologisch bestätigt
	enumeration	0121009	documentation Brustschmerzen
	enumeration	0121010	documentation Doppelkapsel
	enumeration	0121011	documentation Netz-/ADM-bedingte Komplikation, Non-Integration
	enumeration	0121012	documentation Netz-/ADM-bedingte Komplikation, andere
	enumeration	0121013	documentation Hautnekrose/exponiertes Implantat
	enumeration	0121014	documentation BII/ASIA (Brustimplantat assoziierte Symptome), Verdacht
	enumeration	0121015	documentation Lymphadenopathie
	enumeration	0121016	documentation Brustkrebs, neu aufgetreten/Rezidiv
	enumeration	0121042	documentation sonstiger
source	<code><element name="BEB_BefundSchluessel" type="enum_0121"/></code>		

element **BefundBrustimplantatBasis/BEB_BefundAustauschSchluessel**

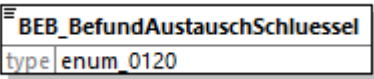
diagram			
type	enum 0120		
properties	content simple		
facets	Kind	Value	Annotation
	enumeration	0120001	documentation Expander defekt
source	<code><element name="BEB_BefundAustauschSchluessel" type="enum_0120"/></code>		

complexType **ProzedurenSchluesselBrustimplantatBasis**

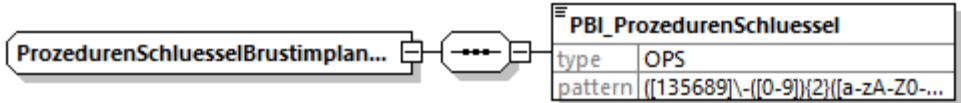
diagram			
namespace	http://xml.ir-d.de/emg		
children	PBI_ProzedurenSchluessel		
used by	element	OperationBrustimplantat/prozedurenSchluesselBrustimplantat	

source	<pre><complexType name="ProzedurenSchluesselBrustimplantatBasis"> <sequence> <element name="PBI_ProzedurenSchluessel" type="OPS"/> </sequence> </complexType></pre>
--------	---

element **ProzedurenSchluesselBrustimplantatBasis/PBI_ProzedurenSchluessel**

diagram							
type	OPS						
properties	content simple						
facets	<table border="1"> <thead> <tr> <th>Kind</th> <th>Value</th> <th>Annotation</th> </tr> </thead> <tbody> <tr> <td>pattern</td> <td>(([135689]\-([0-9]){2})([a-zA-Z0-9]{1}\.([a-zA-Z0-9]{1,2}))*\:([:RLB])?)</td> <td></td> </tr> </tbody> </table>	Kind	Value	Annotation	pattern	(([135689]\-([0-9]){2})([a-zA-Z0-9]{1}\.([a-zA-Z0-9]{1,2}))*\:([:RLB])?)	
Kind	Value	Annotation					
pattern	(([135689]\-([0-9]){2})([a-zA-Z0-9]{1}\.([a-zA-Z0-9]{1,2}))*\:([:RLB])?)						
source	<pre><element name="PBI_ProzedurenSchluessel" type="OPS"/></pre>						

complexType **OperationEndoprotheseBasis**

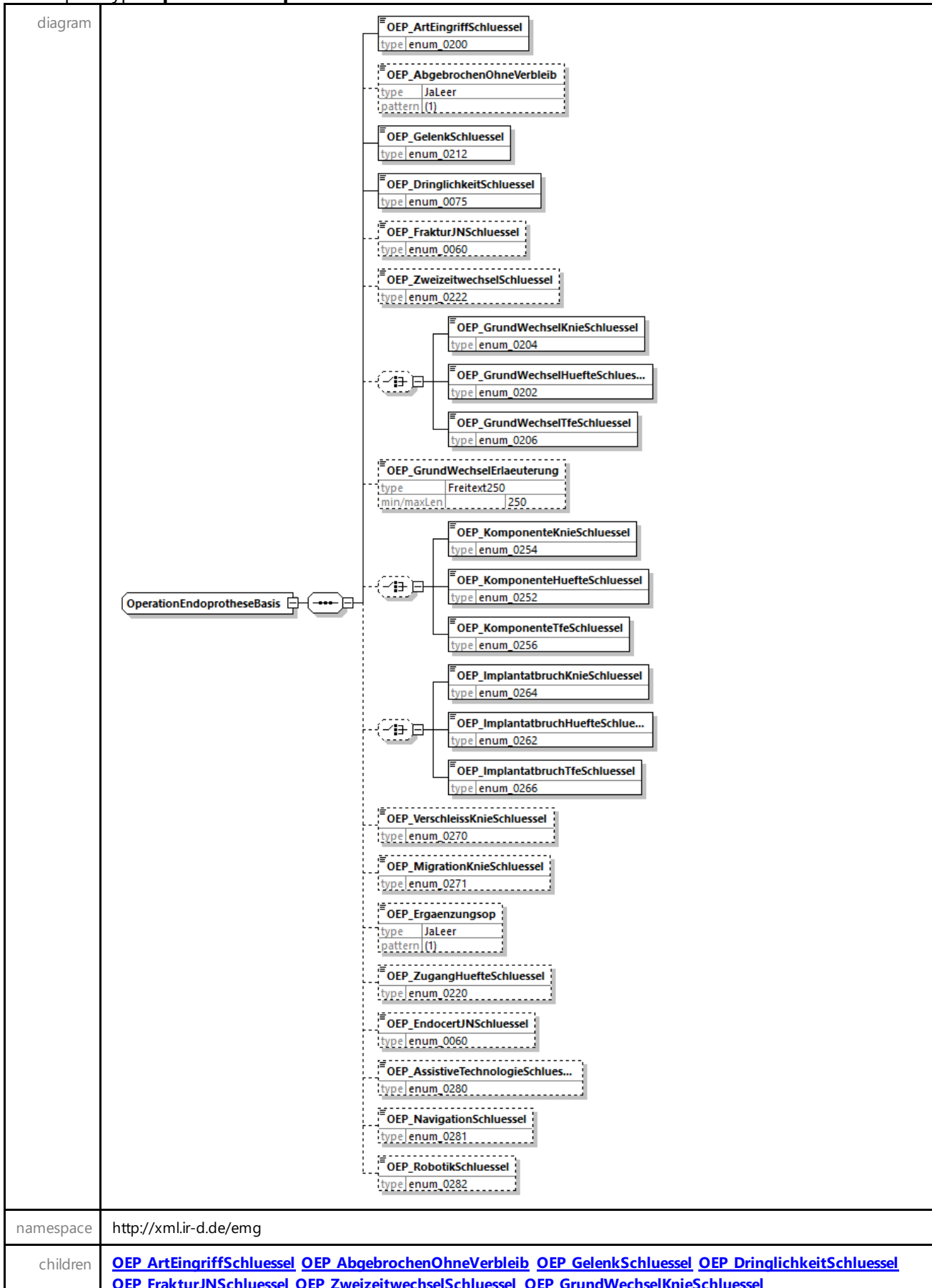

	OEP GrundWechselHuefteSchluessel OEP GrundWechselTfeSchluessel OEP GrundWechselErlaeuterung OEP KomponenteKnieSchluessel OEP KomponenteHuefteSchluessel OEP KomponenteTfeSchluessel OEP ImplantatbruchKnieSchluessel OEP ImplantatbruchHuefteSchluessel OEP ImplantatbruchTfeSchluessel OEP VerschleissKnieSchluessel OEP MigrationKnieSchluessel OEP Ergaenzungsop OEP ZugangHuefteSchluessel OEP EndocertJNSchluessel OEP AssistiveTechnologieSchluessel OEP NavigationSchluessel OEP RobotikSchluessel
used by	complexType OperationEndoprothese
source	<pre> <complexType name="OperationEndoprotheseBasis"> <sequence> <element name="OEP_ArtEingriffSchluessel" type="enum_0200"/> <element name="OEP_AbgebrochenOhneVerbleib" type="JaLeer" minOccurs="0"/> <element name="OEP_GelenkSchluessel" type="enum_0212"/> <element name="OEP_DringlichkeitSchluessel" type="enum_0075"/> <element name="OEP_FrakturJNSchluessel" type="enum_0060" minOccurs="0"/> <element name="OEP_ZweizeitwechselSchluessel" type="enum_0222" minOccurs="0"/> <choice minOccurs="0"> <element name="OEP_GrundWechselKnieSchluessel" type="enum_0204"/> <element name="OEP_GrundWechselHuefteSchluessel" type="enum_0202"/> <element name="OEP_GrundWechselTfeSchluessel" type="enum_0206"/> </choice> <element name="OEP_GrundWechselErlaeuterung" type="Freitext250" minOccurs="0"/> <choice minOccurs="0"> <element name="OEP_KomponenteKnieSchluessel" type="enum_0254"/> <element name="OEP_KomponenteHuefteSchluessel" type="enum_0252"/> <element name="OEP_KomponenteTfeSchluessel" type="enum_0256"/> </choice> <choice minOccurs="0"> <element name="OEP_ImplantatbruchKnieSchluessel" type="enum_0264"/> <element name="OEP_ImplantatbruchHuefteSchluessel" type="enum_0262"/> <element name="OEP_ImplantatbruchTfeSchluessel" type="enum_0266"/> </choice> <element name="OEP_VerschleissKnieSchluessel" type="enum_0270" minOccurs="0"/> <element name="OEP_MigrationKnieSchluessel" type="enum_0271" minOccurs="0"/> <element name="OEP_Ergaenzungsop" type="JaLeer" minOccurs="0"/> <element name="OEP_ZugangHuefteSchluessel" type="enum_0220" minOccurs="0"/> <element name="OEP_EndocertJNSchluessel" type="enum_0060" minOccurs="0"/> <element name="OEP_AssistiveTechnologieSchluessel" type="enum_0280" minOccurs="0"/> <element name="OEP_NavigationSchluessel" type="enum_0281" minOccurs="0"/> <element name="OEP_RobotikSchluessel" type="enum_0282" minOccurs="0"/> </sequence> </complexType> </pre>

element **OperationEndoprotheseBasis/OEP_ArtEingriffSchluessel**

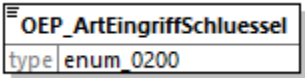
diagram	
type	enum_0200
properties	content simple

facets	Kind	Value	Annotation
	enumeration	0200001	documentation Erst-OP
source	enumeration	0200002	documentation Folgeeingriff
	<code><element name="OEP_ArtEingriffSchluesse1" type="enum_0200"/></code>		

element **OperationEndoprotheseBasis/OEP_AbgebrochenOhneVerbleib**

diagram	
type	JaLeer
properties	minOcc 0 maxOcc 1 content simple
facets	Kind Value Annotation pattern (1)
source	<code><element name="OEP_AbgebrochenOhneVerbleib" type="JaLeer" minOccurs="0"/></code>

element **OperationEndoprotheseBasis/OEP_GelenkSchluesse1**

diagram	
type	enum 0212
properties	content simple
facets	Kind Value Annotation enumeration 0212001 documentation Hüfte enumeration 0212002 documentation Knie enumeration 0212003 documentation Totaler Femurersatz inkl. Durchsteck-Prothese
source	<code><element name="OEP_GelenkSchluesse1" type="enum_0212"/></code>

element **OperationEndoprotheseBasis/OEP_DringlichkeitSchluesse1**

diagram	
type	enum 0075
properties	content simple
facets	Kind Value Annotation enumeration 0075001 documentation elektiv enumeration 0075002 documentation dringlich enumeration 0075003 documentation Notfall

source	<code><element name="OEP_DringlichkeitSchluessel" type="enum_0075"/></code>
--------	---

element **OperationEndoprotheseBasis/OEP_FrakturJNSchluessel**

diagram										
type	enum 0060									
properties	minOcc 0 maxOcc 1 content simple									
facets	<table border="1"> <thead> <tr> <th>Kind</th> <th>Value</th> <th>Annotation</th> </tr> </thead> <tbody> <tr> <td>enumeration</td> <td>0060001</td> <td>documentation ja</td> </tr> <tr> <td>enumeration</td> <td>0060002</td> <td>documentation nein</td> </tr> </tbody> </table>	Kind	Value	Annotation	enumeration	0060001	documentation ja	enumeration	0060002	documentation nein
Kind	Value	Annotation								
enumeration	0060001	documentation ja								
enumeration	0060002	documentation nein								
source	<code><element name="OEP_FrakturJNSchluessel" type="enum_0060" minOccurs="0"/></code>									

element **OperationEndoprotheseBasis/OEP_ZweizeitwechselSchluessel**

diagram													
type	enum 0222												
properties	minOcc 0 maxOcc 1 content simple												
facets	<table border="1"> <thead> <tr> <th>Kind</th> <th>Value</th> <th>Annotation</th> </tr> </thead> <tbody> <tr> <td>enumeration</td> <td>0222001</td> <td>documentation nein</td> </tr> <tr> <td>enumeration</td> <td>0222002</td> <td>documentation ja- Ausbau</td> </tr> <tr> <td>enumeration</td> <td>0222003</td> <td>documentation ja- Einbau</td> </tr> </tbody> </table>	Kind	Value	Annotation	enumeration	0222001	documentation nein	enumeration	0222002	documentation ja- Ausbau	enumeration	0222003	documentation ja- Einbau
Kind	Value	Annotation											
enumeration	0222001	documentation nein											
enumeration	0222002	documentation ja- Ausbau											
enumeration	0222003	documentation ja- Einbau											
source	<code><element name="OEP_ZweizeitwechselSchluessel" type="enum_0222" minOccurs="0"/></code>												

element **OperationEndoprotheseBasis/OEP_GrundWechselKnieSchluessel**

diagram																
type	enum 0204															
properties	content simple															
facets	<table border="1"> <thead> <tr> <th>Kind</th> <th>Value</th> <th>Annotation</th> </tr> </thead> <tbody> <tr> <td>enumeration</td> <td>0204001</td> <td>documentation Lockerung</td> </tr> <tr> <td>enumeration</td> <td>0204002</td> <td>documentation Infektion, Verdacht auf</td> </tr> <tr> <td>enumeration</td> <td>0204003</td> <td>documentation Infektion, gesichert</td> </tr> <tr> <td>enumeration</td> <td>0204006</td> <td>documentation Periprothetische Fraktur</td> </tr> </tbody> </table>	Kind	Value	Annotation	enumeration	0204001	documentation Lockerung	enumeration	0204002	documentation Infektion, Verdacht auf	enumeration	0204003	documentation Infektion, gesichert	enumeration	0204006	documentation Periprothetische Fraktur
Kind	Value	Annotation														
enumeration	0204001	documentation Lockerung														
enumeration	0204002	documentation Infektion, Verdacht auf														
enumeration	0204003	documentation Infektion, gesichert														
enumeration	0204006	documentation Periprothetische Fraktur														

	enumeration	0204007	documentation Verschleiß
	enumeration	0204008	documentation Implantatbruch
	enumeration	0204009	documentation Implantatfehlage/Malalignent
	enumeration	0204010	documentation Osteolysen bei festem Implantat
	enumeration	0204011	documentation Progression der Grunderkrankung
	enumeration	0204012	documentation ARMD
	enumeration	0204013	documentation Verdacht auf allergische Reaktion
	enumeration	0204014	documentation Dislokation/Migration von Komponenten
	enumeration	0204015	documentation Bandinstabilität
	enumeration	0204016	documentation Bewegungseinschränkung
	enumeration	0204042	documentation andere Gründe
source	<code><element name="OEP_GrundWechselKnieSchluessel" type="enum_0204"/></code>		

element **OperationEndoprotheseBasis/OEP_GrundWechselHuefteSchluessel**

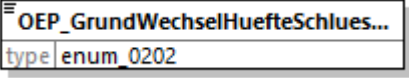
diagram			
type	enum_0202		
properties	content simple		
facets	Kind	Value	Annotation
	enumeration	0202001	documentation Lockerung
	enumeration	0202002	documentation Infektion, Verdacht auf
	enumeration	0202003	documentation Infektion, gesichert
	enumeration	0202004	documentation Luxation, Inlay aus der Pfanne
	enumeration	0202005	documentation Luxation, Kopf aus Pfanne/Inlay
	enumeration	0202006	documentation Periprothetische Fraktur
	enumeration	0202007	documentation Verschleiß des PE-Inlays
	enumeration	0202008	documentation Implantatbruch
	enumeration	0202009	documentation Implantatfehlage/Malalignent
	enumeration	0202010	documentation Osteolysen bei festem Implantat
	enumeration	0202011	documentation Progression der Grunderkrankung
	enumeration	0202012	documentation ARMD
	enumeration	0202013	documentation Verdacht auf allergische Reaktion
	enumeration	0202042	documentation andere Gründe

source	<element name="OEP_GrundWechselHuefteSchluessel" type="enum_0202"/>
--------	---

element **OperationEndoprotheseBasis/OEP_GrundWechselTfeSchluessel**

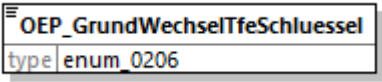
diagram			
type	enum 0206		
properties	content simple		
facets	Kind	Value	Annotation
	enumeration	0206001	documentation Lockerung
	enumeration	0206002	documentation Infektion, Verdacht auf
	enumeration	0206003	documentation Infektion, gesichert
	enumeration	0206004	documentation Luxation, Inlay aus der Pfanne
	enumeration	0206005	documentation Luxation, Kopf aus Pfanne/Inlay
	enumeration	0206006	documentation Periprothetische Fraktur
	enumeration	0206007	documentation Verschleiß
	enumeration	0206008	documentation Implantatbruch
	enumeration	0206009	documentation Implantatfehlage/Malalignent
	enumeration	0206010	documentation Osteolysen bei festem Implantat
	enumeration	0206011	documentation Progression der Grunderkrankung
	enumeration	0206012	documentation ARMD
	enumeration	0206013	documentation Verdacht auf allergische Reaktion
	enumeration	0206014	documentation Dislokation/Migration von Komponenten
	enumeration	0206015	documentation Bandinstabilität
	enumeration	0206016	documentation Bewegungseinschränkung
	enumeration	0206042	documentation andere Gründe
source	<element name="OEP_GrundWechselTfeSchluessel" type="enum_0206"/>		

element **OperationEndoprotheseBasis/OEP_GrundWechselErlaeuterung**

diagram			
type	Freitext250		
properties	minOcc	0	
	maxOcc	1	
	content	simple	

facets	Kind maxLength	Value 250	Annotation
source	<code><element name="OEP_GrundWechselErlaeuterung" type="Freitext250" minOccurs="0"/></code>		

element **OperationEndoprotheseBasis/OEP_KomponenteKnieSchluessel**

diagram			
type	enum 0254		
properties	content simple		
facets	Kind	Value	Annotation
	enumeration	0254001	documentation Femur
	enumeration	0254002	documentation Tibia
	enumeration	0254003	documentation Patella
	enumeration	0254004	documentation mehrere
source	<code><element name="OEP_KomponenteKnieSchluessel" type="enum_0254"/></code>		

element **OperationEndoprotheseBasis/OEP_KomponenteHuefteSchluessel**

diagram			
type	enum 0252		
properties	content simple		
facets	Kind	Value	Annotation
	enumeration	0252001	documentation Pfanne
	enumeration	0252002	documentation Schaft
	enumeration	0252003	documentation beides
source	<code><element name="OEP_KomponenteHuefteSchluessel" type="enum_0252"/></code>		

element **OperationEndoprotheseBasis/OEP_KomponenteTfeSchluessel**

diagram			
type	enum 0256		
properties	content simple		
facets	Kind	Value	Annotation
	enumeration	0256001	documentation Pfanne
	enumeration	0256002	documentation Schaft

	enumeration	0256003	documentation	Pfanne und Schaft
	enumeration	0256004	documentation	Femur
	enumeration	0256005	documentation	Tibia
	enumeration	0256006	documentation	Patella
	enumeration	0256007	documentation	mehrere
source	<code><element name="OEP_KomponenteTfeSchluessel" type="enum_0256"/></code>			

element **OperationEndoprotheseBasis/OEP_ImplantatbruchKnieSchluessel**

diagram				
type	enum 0264			
properties	content simple			
facets	Kind	Value	Annotation	
	enumeration	0264001	documentation Femur	
	enumeration	0264002	documentation Tibia	
	enumeration	0264003	documentation Inlay	
	enumeration	0264004	documentation Adapter	
	enumeration	0264005	documentation Verlängerung	
	enumeration	0264006	documentation Schrauben	
	enumeration	0264007	documentation mehrere	
	enumeration	0264042	documentation andere	
source	<code><element name="OEP_ImplantatbruchKnieSchluessel" type="enum_0264"/></code>			

element **OperationEndoprotheseBasis/OEP_ImplantatbruchHuefteSchluessel**

diagram				
type	enum 0262			
properties	content simple			
facets	Kind	Value	Annotation	
	enumeration	0262001	documentation Pfanne	
	enumeration	0262002	documentation Schaft	
	enumeration	0262003	documentation Kopf	
	enumeration	0262004	documentation Inlay	
	enumeration	0262005	documentation Adapter	

	enumeration 0262006 documentation mehrere
source	<code><element name="OEP_ImplantatbruchHuefteSchluessel" type="enum_0262"/></code>

element **OperationEndoprotheseBasis/OEP_ImplantatbruchTfeSchluessel**

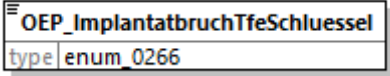
diagram																																					
type	enum 0266																																				
properties	content simple																																				
facets	<table border="1"> <thead> <tr> <th>Kind</th> <th>Value</th> <th>Annotation</th> </tr> </thead> <tbody> <tr> <td>enumeration</td> <td>0266001</td> <td>documentation Pfanne</td> </tr> <tr> <td>enumeration</td> <td>0266002</td> <td>documentation Schaft</td> </tr> <tr> <td>enumeration</td> <td>0266003</td> <td>documentation Kopf</td> </tr> <tr> <td>enumeration</td> <td>0266004</td> <td>documentation Inlay</td> </tr> <tr> <td>enumeration</td> <td>0266005</td> <td>documentation Adapter</td> </tr> <tr> <td>enumeration</td> <td>0266006</td> <td>documentation Femur</td> </tr> <tr> <td>enumeration</td> <td>0266007</td> <td>documentation Tibia</td> </tr> <tr> <td>enumeration</td> <td>0266008</td> <td>documentation Verlängerung</td> </tr> <tr> <td>enumeration</td> <td>0266009</td> <td>documentation Schrauben</td> </tr> <tr> <td>enumeration</td> <td>0266010</td> <td>documentation mehrere</td> </tr> <tr> <td>enumeration</td> <td>0266042</td> <td>documentation andere</td> </tr> </tbody> </table>	Kind	Value	Annotation	enumeration	0266001	documentation Pfanne	enumeration	0266002	documentation Schaft	enumeration	0266003	documentation Kopf	enumeration	0266004	documentation Inlay	enumeration	0266005	documentation Adapter	enumeration	0266006	documentation Femur	enumeration	0266007	documentation Tibia	enumeration	0266008	documentation Verlängerung	enumeration	0266009	documentation Schrauben	enumeration	0266010	documentation mehrere	enumeration	0266042	documentation andere
Kind	Value	Annotation																																			
enumeration	0266001	documentation Pfanne																																			
enumeration	0266002	documentation Schaft																																			
enumeration	0266003	documentation Kopf																																			
enumeration	0266004	documentation Inlay																																			
enumeration	0266005	documentation Adapter																																			
enumeration	0266006	documentation Femur																																			
enumeration	0266007	documentation Tibia																																			
enumeration	0266008	documentation Verlängerung																																			
enumeration	0266009	documentation Schrauben																																			
enumeration	0266010	documentation mehrere																																			
enumeration	0266042	documentation andere																																			
source	<code><element name="OEP_ImplantatbruchTfeSchluessel" type="enum_0266"/></code>																																				

element **OperationEndoprotheseBasis/OEP_VerschleissKnieSchluessel**

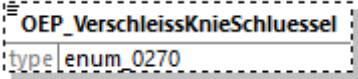
diagram													
type	enum 0270												
properties	minOcc 0 maxOcc 1 content simple												
facets	<table border="1"> <thead> <tr> <th>Kind</th> <th>Value</th> <th>Annotation</th> </tr> </thead> <tbody> <tr> <td>enumeration</td> <td>0270001</td> <td>documentation PE-Inlay</td> </tr> <tr> <td>enumeration</td> <td>0270002</td> <td>documentation patellare Komponente</td> </tr> <tr> <td>enumeration</td> <td>0270003</td> <td>documentation beides</td> </tr> </tbody> </table>	Kind	Value	Annotation	enumeration	0270001	documentation PE-Inlay	enumeration	0270002	documentation patellare Komponente	enumeration	0270003	documentation beides
Kind	Value	Annotation											
enumeration	0270001	documentation PE-Inlay											
enumeration	0270002	documentation patellare Komponente											
enumeration	0270003	documentation beides											
source	<code><element name="OEP_VerschleissKnieSchluessel" type="enum_0270" minOccurs="0"/></code>												

element **OperationEndoprotheseBasis/OEP_MigrationKnieSchluessel**

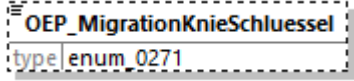
diagram																						
type	enum 0271																					
properties	minOcc 0 maxOcc 1 content simple																					
facets	<table border="1"> <thead> <tr> <th>Kind</th> <th>Value</th> <th>Annotation</th> </tr> </thead> <tbody> <tr> <td>enumeration</td> <td>0271001</td> <td>documentation Schraube</td> </tr> <tr> <td>enumeration</td> <td>0271002</td> <td>documentation Inlay</td> </tr> <tr> <td>enumeration</td> <td>0271003</td> <td>documentation patellare Komponente</td> </tr> <tr> <td>enumeration</td> <td>0271004</td> <td>documentation Kopplung</td> </tr> <tr> <td>enumeration</td> <td>0271005</td> <td>documentation mehrere</td> </tr> <tr> <td>enumeration</td> <td>0271042</td> <td>documentation andere</td> </tr> </tbody> </table>	Kind	Value	Annotation	enumeration	0271001	documentation Schraube	enumeration	0271002	documentation Inlay	enumeration	0271003	documentation patellare Komponente	enumeration	0271004	documentation Kopplung	enumeration	0271005	documentation mehrere	enumeration	0271042	documentation andere
Kind	Value	Annotation																				
enumeration	0271001	documentation Schraube																				
enumeration	0271002	documentation Inlay																				
enumeration	0271003	documentation patellare Komponente																				
enumeration	0271004	documentation Kopplung																				
enumeration	0271005	documentation mehrere																				
enumeration	0271042	documentation andere																				
source	<code><element name="OEP_MigrationKnieSchluessel" type="enum_0271" minOccurs="0"/></code>																					

element **OperationEndoprotheseBasis/OEP_Ergaenzungsop**

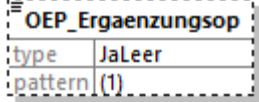
diagram							
type	JaLeer						
properties	minOcc 0 maxOcc 1 content simple						
facets	<table border="1"> <thead> <tr> <th>Kind</th> <th>Value</th> <th>Annotation</th> </tr> </thead> <tbody> <tr> <td>pattern</td> <td>(1)</td> <td></td> </tr> </tbody> </table>	Kind	Value	Annotation	pattern	(1)	
Kind	Value	Annotation					
pattern	(1)						
source	<code><element name="OEP_Ergaenzungsop" type="JaLeer" minOccurs="0"/></code>						

element **OperationEndoprotheseBasis/OEP_ZugangHuefteSchluessel**

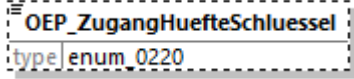
diagram													
type	enum 0220												
properties	minOcc 0 maxOcc 1 content simple												
facets	<table border="1"> <thead> <tr> <th>Kind</th> <th>Value</th> <th>Annotation</th> </tr> </thead> <tbody> <tr> <td>enumeration</td> <td>0220001</td> <td>documentation anterior</td> </tr> <tr> <td>enumeration</td> <td>0220002</td> <td>documentation anterolateral</td> </tr> <tr> <td>enumeration</td> <td>0220003</td> <td>documentation lateral</td> </tr> </tbody> </table>	Kind	Value	Annotation	enumeration	0220001	documentation anterior	enumeration	0220002	documentation anterolateral	enumeration	0220003	documentation lateral
Kind	Value	Annotation											
enumeration	0220001	documentation anterior											
enumeration	0220002	documentation anterolateral											
enumeration	0220003	documentation lateral											

	enumeration 0220004 documentation posterior
	enumeration 0220005 documentation posterolateral
	enumeration 0220006 documentation 2-Inzisionen-Zugang
	enumeration 0220042 documentation sonstiger
source	<code><element name="OEP_ZugangHuefteSchluessel" type="enum_0220" minOccurs="0"/></code>

element **OperationEndoprotheseBasis/OEP_EndocertJNSchluessel**

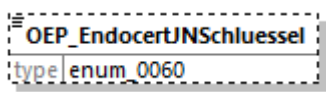
diagram										
type	enum 0060									
properties	minOcc 0 maxOcc 1 content simple									
facets	<table border="1"> <thead> <tr> <th>Kind</th> <th>Value</th> <th>Annotation</th> </tr> </thead> <tbody> <tr> <td>enumeration</td> <td>0060001</td> <td>documentation ja</td> </tr> <tr> <td>enumeration</td> <td>0060002</td> <td>documentation nein</td> </tr> </tbody> </table>	Kind	Value	Annotation	enumeration	0060001	documentation ja	enumeration	0060002	documentation nein
Kind	Value	Annotation								
enumeration	0060001	documentation ja								
enumeration	0060002	documentation nein								
source	<code><element name="OEP_EndocertJNSchluessel" type="enum_0060" minOccurs="0"/></code>									

element **OperationEndoprotheseBasis/OEP_AssistiveTechnologieSchluessel**

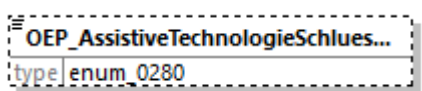
diagram																			
type	enum 0280																		
properties	minOcc 0 maxOcc 1 content simple																		
facets	<table border="1"> <thead> <tr> <th>Kind</th> <th>Value</th> <th>Annotation</th> </tr> </thead> <tbody> <tr> <td>enumeration</td> <td>0280001</td> <td>documentation Ohne</td> </tr> <tr> <td>enumeration</td> <td>0280002</td> <td>documentation PSI</td> </tr> <tr> <td>enumeration</td> <td>0280003</td> <td>documentation Navigation</td> </tr> <tr> <td>enumeration</td> <td>0280004</td> <td>documentation Robotik</td> </tr> <tr> <td>enumeration</td> <td>0280042</td> <td>documentation Unbekannt</td> </tr> </tbody> </table>	Kind	Value	Annotation	enumeration	0280001	documentation Ohne	enumeration	0280002	documentation PSI	enumeration	0280003	documentation Navigation	enumeration	0280004	documentation Robotik	enumeration	0280042	documentation Unbekannt
Kind	Value	Annotation																	
enumeration	0280001	documentation Ohne																	
enumeration	0280002	documentation PSI																	
enumeration	0280003	documentation Navigation																	
enumeration	0280004	documentation Robotik																	
enumeration	0280042	documentation Unbekannt																	
source	<code><element name="OEP_AssistiveTechnologieSchluessel" type="enum_0280" minOccurs="0"/></code>																		

element **OperationEndoprotheseBasis/OEP_NavigationSchluessel**

diagram	
---------	---

type	enum_0281		
properties	minOcc	0	
	maxOcc	1	
	content	simple	
facets	Kind	Value	Annotation
	enumeration	0281001	documentation Aesculap - OrthoPilot
	enumeration	0281002	documentation Amplitude - Amplivision
	enumeration	0281003	documentation Johnson & Johnson - VELYS
	enumeration	0281004	documentation Orthokey - Orthokey Miro
	enumeration	0281005	documentation Orthokey - BLU-IGS
	enumeration	0281006	documentation Smith & Nephew - Brainlab Plattformen (TBD)
	enumeration	0281007	documentation Stryker - Stryker NAV3i
	enumeration	0281008	documentation Stryker - Stryker Ortho Q Guidance System
	enumeration	0281009	documentation ThinkSurgical - TMINI
	enumeration	0281010	documentation Zimmer Biomet - Sesamoid Navigation
	enumeration	0281011	documentation Zimmer Biomet - iAssist Navigation
	enumeration	0281012	documentation nicht belegter Wert
	enumeration	0281013	documentation nicht belegter Wert
	enumeration	0281014	documentation nicht belegter Wert
	enumeration	0281015	documentation nicht belegter Wert
	enumeration	0281016	documentation nicht belegter Wert
	enumeration	0281042	documentation sonstige
source	<code><element name="OEP_NavigationSchluessel" type="enum_0281" minOccurs="0"/></code>		

element **OperationEndoprotheseBasis/OEP_RobotikSchluessel**

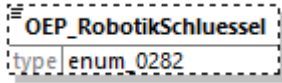
diagram			
type	enum_0282		
properties	minOcc	0	
	maxOcc	1	
	content	simple	
facets	Kind	Value	Annotation
	enumeration	0282001	documentation Amplitude - Andy
	enumeration	0282002	documentation Corin - ApolloKnee
	enumeration	0282003	documentation Corin - OMNIBotics
	enumeration	0282004	documentation Microport - Skywalker
	enumeration	0282005	documentation

	enumeration	0282006	Orthokey - Orthokey Robin documentation
	enumeration	0282007	Smith & Nephew - CORI documentation
	enumeration	0282008	Smith & Nephew - NAVIO documentation
	enumeration	0282009	Stryker - Mako SmartRobotics documentation
	enumeration	0282010	Zimmer Biomet - ROSA documentation
	enumeration	0282011	Johnson & Johnson - VELYS Robotic Assisted Solution documentation
	enumeration	0282012	nicht belegter Wert documentation
	enumeration	0282013	nicht belegter Wert documentation
	enumeration	0282014	nicht belegter Wert documentation
	enumeration	0282015	nicht belegter Wert documentation
	enumeration	0282042	sonstige documentation
source	<code><element name="OEP_RobotikSchluessel" type="enum_0282" minOccurs="0"/></code>		

complexType **VorbehandlungEndoprotheseBasis**

diagram	
namespace	http://xml.ir-d.de/emg
children	VEP_VorOpKnieSchluessel VEP_VorOpHuefteSchluessel VEP_VorOpErlaeuterung
used by	element OperationEndoprothese/vorbehandlungEndoprothese
source	<pre> <complexType name="VorbehandlungEndoprotheseBasis"> <sequence> <choice minOccurs="0"> <element name="VEP_VorOpKnieSchluessel" type="enum_0211"/> <element name="VEP_VorOpHuefteSchluessel" type="enum_0210"/> </choice> <element name="VEP_VorOpErlaeuterung" type="Freitext250" minOccurs="0"/> </sequence> </complexType> </pre>

element **VorbehandlungEndoprotheseBasis/VEP_VorOpKnieSchluessel**

diagram	
---------	--

type	enum_0211		
properties	content simple		
facets	Kind	Value	Annotation
	enumeration	0211001	documentation keine relevante Voroperation
	enumeration	0211002	documentation Osteosynthese/Osteotomie (Femur)
	enumeration	0211003	documentation Osteosynthese/Osteotomie (Tibia)
	enumeration	0211004	documentation Osteosynthese/Osteotomie (Patella)
	enumeration	0211005	documentation Osteosynthese/Osteotomie (mehrere)
	enumeration	0211006	documentation Kapsel-/Bandapparat
	enumeration	0211007	documentation Arthrodese
	enumeration	0211042	documentation andere
source	<code><element name="VEP_VorOpKnieSchluessel" type="enum_0211"/></code>		

element **VorbehandlungEndoprotheseBasis/VEP_VorOpHuefteSchluessel**

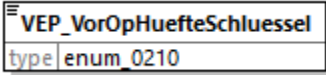
diagram			
type	enum_0210		
properties	content simple		
facets	Kind	Value	Annotation
	enumeration	0210001	documentation keine relevante Voroperation
	enumeration	0210002	documentation Osteosynthese/Osteotomie (Becken)
	enumeration	0210003	documentation Osteosynthese/Osteotomie (Femur)
	enumeration	0210004	documentation Osteosynthese/Osteotomie (beides)
	enumeration	0210005	documentation Operation bei Hüftkopfnekrose
	enumeration	0210006	documentation Arthrodese
	enumeration	0210042	documentation andere
source	<code><element name="VEP_VorOpHuefteSchluessel" type="enum_0210"/></code>		

element **VorbehandlungEndoprotheseBasis/VEP_VorOpErlaeuterung**

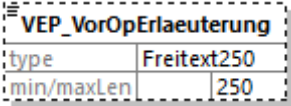
diagram			
type	Freitext250		
properties	minOcc	0	
	maxOcc	1	
	content	simple	

facets	Kind	Value	Annotation
	maxLength	250	
source	<code><element name="VEP_VorOpErklaerung" type="Freitext250" minOccurs="0"/></code>		

complexType **ProzedurenSchluesselEndprotheseBasis**

diagram	<table border="1"> <tr> <td colspan="2">PEP_ProzedurenSchluessel</td> </tr> <tr> <td>type</td> <td>OPS</td> </tr> <tr> <td>pattern</td> <td>[(135689)\-[0-9]]{2}([a-zA-Z0-9]...</td> </tr> </table>	PEP_ProzedurenSchluessel		type	OPS	pattern	[(135689)\-[0-9]]{2}([a-zA-Z0-9]...
PEP_ProzedurenSchluessel							
type	OPS						
pattern	[(135689)\-[0-9]]{2}([a-zA-Z0-9]...						
namespace	http://xml.ir-d.de/emg						
children	PEP_ProzedurenSchluessel						
used by	element OperationEndprothese/prozedurenSchluesselEndprothese						
source	<pre><complexType name="ProzedurenSchluesselEndprotheseBasis"> <sequence> <element name="PEP_ProzedurenSchluessel" type="OPS"/> </sequence> </complexType></pre>						

element **ProzedurenSchluesselEndprotheseBasis/PEP_ProzedurenSchluessel**

diagram	<table border="1"> <tr> <td colspan="2">PEP_ProzedurenSchluessel</td> </tr> <tr> <td>type</td> <td>OPS</td> </tr> <tr> <td>pattern</td> <td>[(135689)\-[0-9]]{2}([a-zA-Z0-9]...</td> </tr> </table>	PEP_ProzedurenSchluessel		type	OPS	pattern	[(135689)\-[0-9]]{2}([a-zA-Z0-9]...
PEP_ProzedurenSchluessel							
type	OPS						
pattern	[(135689)\-[0-9]]{2}([a-zA-Z0-9]...						
type	OPS						
properties	content simple						
facets	<table border="1"> <tr> <td>Kind</td> <td>Value</td> <td>Annotation</td> </tr> <tr> <td>pattern</td> <td>[(135689)\-[0-9]]{2}([a-zA-Z0-9]]{1}\.[a-zA-Z0-9]]{1,2}))*(:[RLB])?</td> <td></td> </tr> </table>	Kind	Value	Annotation	pattern	[(135689)\-[0-9]]{2}([a-zA-Z0-9]]{1}\.[a-zA-Z0-9]]{1,2}))*(:[RLB])?	
Kind	Value	Annotation					
pattern	[(135689)\-[0-9]]{2}([a-zA-Z0-9]]{1}\.[a-zA-Z0-9]]{1,2}))*(:[RLB])?						
source	<code><element name="PEP_ProzedurenSchluessel" type="OPS"/></code>						

complexType OperationAortenklappeBasis

diagram

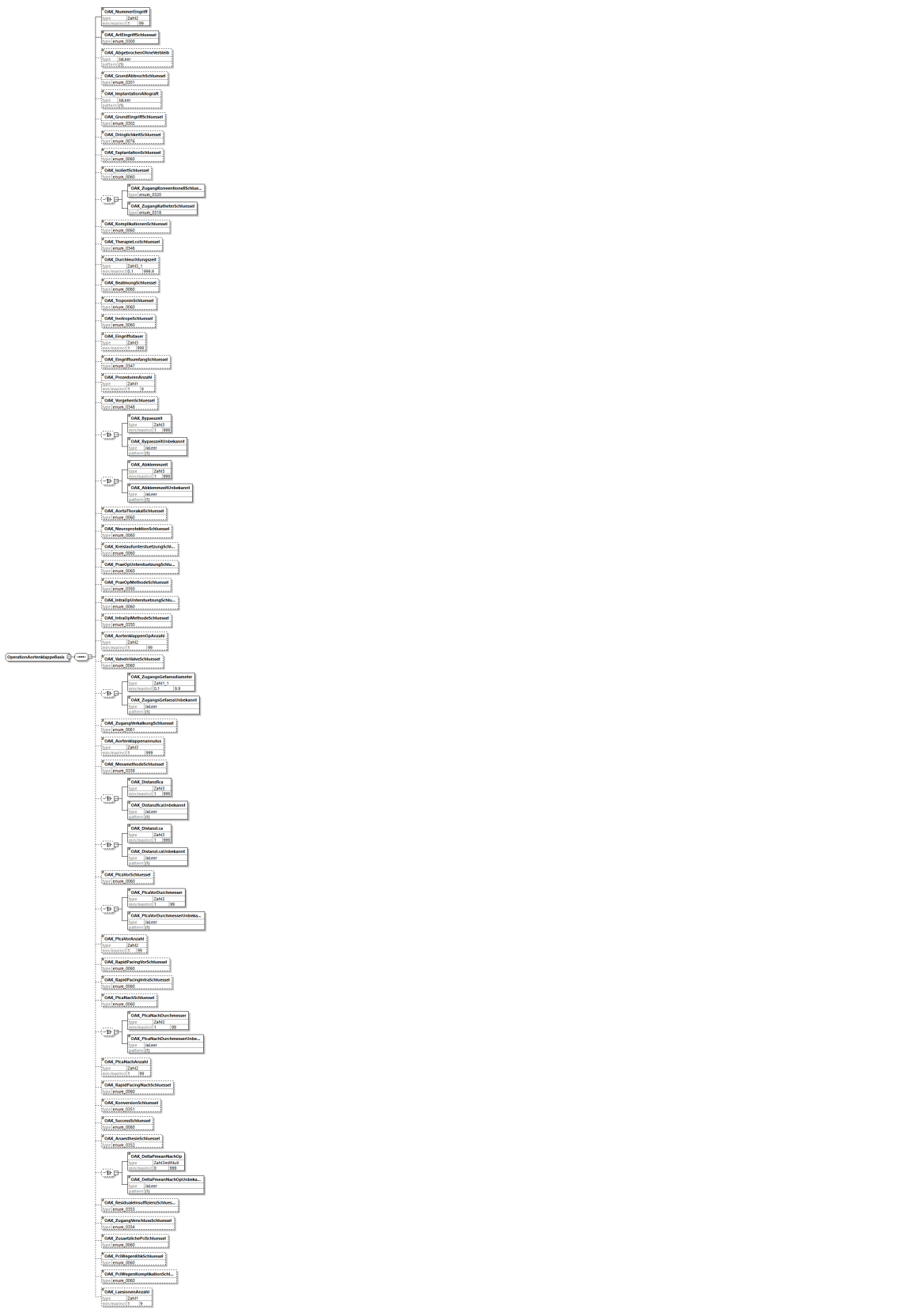

namespace	http://xml.ir-d.de/emg
children	OAK NummerEingriff OAK ArtEingriffSchlüssel OAK AbgebrochenOhneVerbleib OAK GrundAbbruchSchlüssel OAK ImplantationAllograft OAK GrundEingriffSchlüssel OAK DringlichkeitSchlüssel OAK ExplantationSchlüssel OAK IsoliertSchlüssel OAK ZugangKonventionellSchlüssel

	<p> OAK ZugangKatheterSchlüssel OAK KomplikationenSchlüssel OAK TherapieLcoSchlüssel OAK Durchleuchtungszeit OAK BeatmungSchlüssel OAK TroponinSchlüssel OAK InotropeSchlüssel OAK Eingriffsdauer OAK EingriffsumfangSchlüssel OAK ProzedurenAnzahl OAK VorgehenSchlüssel OAK Bypasszeit OAK BypasszeitUnbekannt OAK Abklemmzeit OAK AbklemmzeitUnbekannt OAK AortaThorakalSchlüssel OAK NeuroprotektionSchlüssel OAK KreislaufunterstützungSchlüssel OAK PraeOpUnterstützungSchlüssel OAK PraeOpMethodeSchlüssel OAK IntraOpUnterstützungSchlüssel OAK IntraOpMethodeSchlüssel OAK AortenklappenOpAnzahl OAK ValvelnValveSchlüssel OAK ZugangsGefaessdiameter OAK ZugangsGefaessUnbekannt OAK ZugangVerkalkungSchlüssel OAK Aortenklappenannulus OAK MessmethodeSchlüssel OAK DistanzRca OAK DistanzRcaUnbekannt OAK DistanzLca OAK DistanzLcaUnbekannt OAK PtcaVorSchlüssel OAK PtcaVorDurchmesser OAK PtcaVorDurchmesserUnbekannt OAK PtcaVorAnzahl OAK RapidPacingVorSchlüssel OAK RapidPacingIntraSchlüssel OAK PtcaNachSchlüssel OAK PtcaNachDurchmesser OAK PtcaNachDurchmesserUnbekannt OAK PtcaNachAnzahl OAK RapidPacingNachSchlüssel OAK KonversionSchlüssel OAK SuccessSchlüssel OAK AnaesthetieSchlüssel OAK DeltaPmeanNachOp OAK DeltaPmeanNachOpUnbekannt OAK ResidualeinsuffizienzSchlüssel OAK ZugangVerschlussSchlüssel OAK ZusätzlichePciSchlüssel OAK PciWegenKhkSchlüssel OAK PciWegenKomplikationSchlüssel OAK LaesionenAnzahl </p>
used by	<p>complexType OperationAortenklappe</p>
source	<pre> <complexType name="OperationAortenklappeBasis"> <sequence> <element name="OAK_NummerEingriff" type="Zahl2"/> <element name="OAK_ArtEingriffSchlüssel" type="enum_0300"/> <element name="OAK_AbgebrochenOhneVerbleib" type="JaLeer" minOccurs="0"/> <element name="OAK_GrundAbbruchSchlüssel" type="enum_0301" minOccurs="0"/> <element name="OAK_ImplantationAllograft" type="JaLeer" minOccurs="0"/> <element name="OAK_GrundEingriffSchlüssel" type="enum_0302" minOccurs="0"/> <element name="OAK_DringlichkeitSchlüssel" type="enum_0076" minOccurs="0"/> <element name="OAK_ExplantationSchlüssel" type="enum_0060" minOccurs="0"/> <element name="OAK_IsoliertSchlüssel" type="enum_0060" minOccurs="0"/> <choice minOccurs="0"> <element name="OAK_ZugangKonventionellSchlüssel" type="enum_0320"/> <element name="OAK_ZugangKatheterSchlüssel" type="enum_0318"/> </choice> <element name="OAK_KomplikationenSchlüssel" type="enum_0060" minOccurs="0"/> <element name="OAK_TherapieLcoSchlüssel" type="enum_0346" minOccurs="0"/> <element name="OAK_Durchleuchtungszeit" type="Zahl3_1" minOccurs="0"/> <element name="OAK_BeatmungSchlüssel" type="enum_0060" minOccurs="0"/> <element name="OAK_TroponinSchlüssel" type="enum_0060" minOccurs="0"/> <element name="OAK_InotropeSchlüssel" type="enum_0060" minOccurs="0"/> <element name="OAK_Eingriffsdauer" type="Zahl3" minOccurs="0"/> <element name="OAK_EingriffsumfangSchlüssel" type="enum_0347" minOccurs="0"/> <element name="OAK_ProzedurenAnzahl" type="Zahl1" minOccurs="0"/> <element name="OAK_VorgehenSchlüssel" type="enum_0348" minOccurs="0"/> <choice minOccurs="0"> <element name="OAK_Bypasszeit" type="Zahl3"/> <element name="OAK_BypasszeitUnbekannt" type="JaLeer"/> </choice> <choice minOccurs="0"> <element name="OAK_Abklemmzeit" type="Zahl3"/> <element name="OAK_AbklemmzeitUnbekannt" type="JaLeer"/> </choice> <element name="OAK_AortaThorakalSchlüssel" type="enum_0060" </pre>

```

minOccurs="0"/>
  <element name="OAK_NeuroprotektionSchluessel" type="enum_0060"
minOccurs="0"/>
  <element name="OAK_KreislaufunterstuetzungSchluessel" type="enum_0060"
minOccurs="0"/>
  <element name="OAK_PraeOpUnterstuetzungSchluessel" type="enum_0060"
minOccurs="0"/>
  <element name="OAK_PraeOpMethodeSchluessel" type="enum_0350"
minOccurs="0"/>
  <element name="OAK_IntraOpUnterstuetzungSchluessel" type="enum_0060"
minOccurs="0"/>
  <element name="OAK_IntraOpMethodeSchluessel" type="enum_0350"
minOccurs="0"/>
  <element name="OAK_AortenklappenOpAnzahl" type="Zahl2" minOccurs="0"/>
  <element name="OAK_ValveInValveSchluessel" type="enum_0060"
minOccurs="0"/>
  <choice minOccurs="0">
    <element name="OAK_ZugangsGefaessdiameter" type="Zahl1_1"/>
    <element name="OAK_ZugangsGefaessUnbekannt" type="JaLeer"/>
  </choice>
  <element name="OAK_ZugangVerkalkungSchluessel" type="enum_0061"
minOccurs="0"/>
  <element name="OAK_Aortenklappenannulus" type="Zahl3" minOccurs="0"/>
  <element name="OAK_MessmethodeSchluessel" type="enum_0339"
minOccurs="0"/>
  <choice minOccurs="0">
    <element name="OAK_DistanzRca" type="Zahl3"/>
    <element name="OAK_DistanzRcaUnbekannt" type="JaLeer"/>
  </choice>
  <choice minOccurs="0">
    <element name="OAK_DistanzLca" type="Zahl3"/>
    <element name="OAK_DistanzLcaUnbekannt" type="JaLeer"/>
  </choice>
  <element name="OAK_PtcaVorSchluessel" type="enum_0060" minOccurs="0"/>
  <choice minOccurs="0">
    <element name="OAK_PtcaVorDurchmesser" type="Zahl2"/>
    <element name="OAK_PtcaVorDurchmesserUnbekannt" type="JaLeer"/>
  </choice>
  <element name="OAK_PtcaVorAnzahl" type="Zahl2" minOccurs="0"/>
  <element name="OAK_RapidPacingVorSchluessel" type="enum_0060"
minOccurs="0"/>
  <element name="OAK_RapidPacingIntraSchluessel" type="enum_0060"
minOccurs="0"/>
  <element name="OAK_PtcaNachSchluessel" type="enum_0060" minOccurs="0"/>
  <choice minOccurs="0">
    <element name="OAK_PtcaNachDurchmesser" type="Zahl2"/>
    <element name="OAK_PtcaNachDurchmesserUnbekannt" type="JaLeer"/>
  </choice>
  <element name="OAK_PtcaNachAnzahl" type="Zahl2" minOccurs="0"/>
  <element name="OAK_RapidPacingNachSchluessel" type="enum_0060"
minOccurs="0"/>
  <element name="OAK_KonversionSchluessel" type="enum_0351" minOccurs="0"/>
  <element name="OAK_SuccessSchluessel" type="enum_0060" minOccurs="0"/>
  <element name="OAK_AnaesthesieSchluessel" type="enum_0352"
minOccurs="0"/>
  <choice minOccurs="0">
    <element name="OAK_DeltaPmeanNachOp" type="Zahl3mitNull"/>
    <element name="OAK_DeltaPmeanNachOpUnbekannt" type="JaLeer"/>
  </choice>

```

	<pre> <element name="OAK_ResidualeInsuffizienzSchluessel" type="enum_0353" minOccurs="0"/> <element name="OAK_ZugangVerschlussSchluessel" type="enum_0354" minOccurs="0"/> <element name="OAK_ZusaetzlichePciSchluessel" type="enum_0060" minOccurs="0"/> <element name="OAK_PciWegenKhkSchluessel" type="enum_0060" minOccurs="0"/> <element name="OAK_PciWegenKomplikationSchluessel" type="enum_0060" minOccurs="0"/> <element name="OAK_LaesionenAnzahl" type="Zahl1" minOccurs="0"/> </sequence> </complexType> </pre>
--	---

element **OperationAortenklappeBasis/OAK_NummerEingriff**

diagram										
type	Zahl2									
properties	content simple									
facets	<table border="1"> <thead> <tr> <th>Kind</th> <th>Value</th> <th>Annotation</th> </tr> </thead> <tbody> <tr> <td>minInclusive</td> <td>1</td> <td></td> </tr> <tr> <td>maxInclusive</td> <td>99</td> <td></td> </tr> </tbody> </table>	Kind	Value	Annotation	minInclusive	1		maxInclusive	99	
Kind	Value	Annotation								
minInclusive	1									
maxInclusive	99									
source	<code><element name="OAK_NummerEingriff" type="Zahl2"/></code>									

element **OperationAortenklappeBasis/OAK_ArtEingriffSchluessel**

diagram										
type	enum_0300									
properties	content simple									
facets	<table border="1"> <thead> <tr> <th>Kind</th> <th>Value</th> <th>Annotation</th> </tr> </thead> <tbody> <tr> <td>enumeration</td> <td>0300001</td> <td>documentation konventioneller Aortenklappenersatz</td> </tr> <tr> <td>enumeration</td> <td>0300002</td> <td>documentation kathetergestützte Aortenklappenimplantation (TAVI)</td> </tr> </tbody> </table>	Kind	Value	Annotation	enumeration	0300001	documentation konventioneller Aortenklappenersatz	enumeration	0300002	documentation kathetergestützte Aortenklappenimplantation (TAVI)
Kind	Value	Annotation								
enumeration	0300001	documentation konventioneller Aortenklappenersatz								
enumeration	0300002	documentation kathetergestützte Aortenklappenimplantation (TAVI)								
source	<code><element name="OAK_ArtEingriffSchluessel" type="enum_0300"/></code>									

element **OperationAortenklappeBasis/OAK_AbgebrochenOhneVerbleib**

diagram							
type	JaLeer						
properties	<table border="1"> <tbody> <tr> <td>minOcc</td> <td>0</td> </tr> <tr> <td>maxOcc</td> <td>1</td> </tr> <tr> <td>content</td> <td>simple</td> </tr> </tbody> </table>	minOcc	0	maxOcc	1	content	simple
minOcc	0						
maxOcc	1						
content	simple						

facets	Kind Value Annotation pattern (1)
source	<element name="OAK_AbgebrochenOhneVerbleib" type="JaLeer" minOccurs="0"/>

element OperationAortenklappeBasis/OAK_GrundAbbruchSchluessel

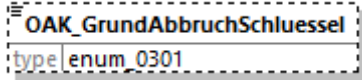
diagram										
type	enum 0301									
properties	minOcc 0 maxOcc 1 content simple									
facets	<table border="1"> <thead> <tr> <th>Kind</th> <th>Value</th> <th>Annotation</th> </tr> </thead> <tbody> <tr> <td>enumeration</td> <td>0301001</td> <td>documentation produktbezogen</td> </tr> <tr> <td>enumeration</td> <td>0301002</td> <td>documentation nicht-produktbezogen</td> </tr> </tbody> </table>	Kind	Value	Annotation	enumeration	0301001	documentation produktbezogen	enumeration	0301002	documentation nicht-produktbezogen
Kind	Value	Annotation								
enumeration	0301001	documentation produktbezogen								
enumeration	0301002	documentation nicht-produktbezogen								
source	<element name="OAK_GrundAbbruchSchluessel" type="enum_0301" minOccurs="0"/>									

element OperationAortenklappeBasis/OAK_ImplantationAllograft

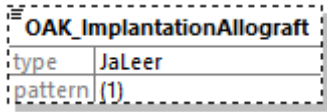
diagram	
type	JaLeer
properties	minOcc 0 maxOcc 1 content simple
facets	Kind Value Annotation pattern (1)
source	<element name="OAK_ImplantationAllograft" type="JaLeer" minOccurs="0"/>

element OperationAortenklappeBasis/OAK_GrundEingriffSchluessel

diagram																
type	enum 0302															
properties	minOcc 0 maxOcc 1 content simple															
facets	<table border="1"> <thead> <tr> <th>Kind</th> <th>Value</th> <th>Annotation</th> </tr> </thead> <tbody> <tr> <td>enumeration</td> <td>0302001</td> <td>documentation Stenose</td> </tr> <tr> <td>enumeration</td> <td>0302002</td> <td>documentation Insuffizienz</td> </tr> <tr> <td>enumeration</td> <td>0302003</td> <td>documentation Stenose und Insuffizienz</td> </tr> <tr> <td>enumeration</td> <td>0302042</td> <td>documentation sonstiger</td> </tr> </tbody> </table>	Kind	Value	Annotation	enumeration	0302001	documentation Stenose	enumeration	0302002	documentation Insuffizienz	enumeration	0302003	documentation Stenose und Insuffizienz	enumeration	0302042	documentation sonstiger
Kind	Value	Annotation														
enumeration	0302001	documentation Stenose														
enumeration	0302002	documentation Insuffizienz														
enumeration	0302003	documentation Stenose und Insuffizienz														
enumeration	0302042	documentation sonstiger														

source	<code><element name="OAK_GrundEingriffSchluessel" type="enum_0302" minOccurs="0"/></code>
--------	---

element **OperationAortenklappeBasis/OAK_DringlichkeitSchluessel**

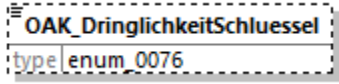
diagram																
type	enum 0076															
properties	minOcc 0 maxOcc 1 content simple															
facets	<table border="1"> <thead> <tr> <th>Kind</th> <th>Value</th> <th>Annotation</th> </tr> </thead> <tbody> <tr> <td>enumeration</td> <td>0076001</td> <td>documentation elektiv</td> </tr> <tr> <td>enumeration</td> <td>0076002</td> <td>documentation dringlich</td> </tr> <tr> <td>enumeration</td> <td>0076003</td> <td>documentation Notfall</td> </tr> <tr> <td>enumeration</td> <td>0076004</td> <td>documentation Notfall (Reanimation / ultima ratio)</td> </tr> </tbody> </table>	Kind	Value	Annotation	enumeration	0076001	documentation elektiv	enumeration	0076002	documentation dringlich	enumeration	0076003	documentation Notfall	enumeration	0076004	documentation Notfall (Reanimation / ultima ratio)
Kind	Value	Annotation														
enumeration	0076001	documentation elektiv														
enumeration	0076002	documentation dringlich														
enumeration	0076003	documentation Notfall														
enumeration	0076004	documentation Notfall (Reanimation / ultima ratio)														
source	<code><element name="OAK_DringlichkeitSchluessel" type="enum_0076" minOccurs="0"/></code>															

element **OperationAortenklappeBasis/OAK_ExplantationSchluessel**

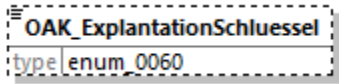
diagram										
type	enum 0060									
properties	minOcc 0 maxOcc 1 content simple									
facets	<table border="1"> <thead> <tr> <th>Kind</th> <th>Value</th> <th>Annotation</th> </tr> </thead> <tbody> <tr> <td>enumeration</td> <td>0060001</td> <td>documentation ja</td> </tr> <tr> <td>enumeration</td> <td>0060002</td> <td>documentation nein</td> </tr> </tbody> </table>	Kind	Value	Annotation	enumeration	0060001	documentation ja	enumeration	0060002	documentation nein
Kind	Value	Annotation								
enumeration	0060001	documentation ja								
enumeration	0060002	documentation nein								
source	<code><element name="OAK_ExplantationSchluessel" type="enum_0060" minOccurs="0"/></code>									

element **OperationAortenklappeBasis/OAK_IsoliertSchluessel**

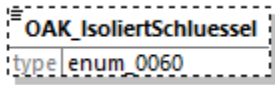
diagram										
type	enum 0060									
properties	minOcc 0 maxOcc 1 content simple									
facets	<table border="1"> <thead> <tr> <th>Kind</th> <th>Value</th> <th>Annotation</th> </tr> </thead> <tbody> <tr> <td>enumeration</td> <td>0060001</td> <td>documentation ja</td> </tr> <tr> <td>enumeration</td> <td>0060002</td> <td>documentation nein</td> </tr> </tbody> </table>	Kind	Value	Annotation	enumeration	0060001	documentation ja	enumeration	0060002	documentation nein
Kind	Value	Annotation								
enumeration	0060001	documentation ja								
enumeration	0060002	documentation nein								
source	<code><element name="OAK_IsoliertSchluessel" type="enum_0060" minOccurs="0"/></code>									

element **OperationAortenklappeBasis/OAK_ZugangKonventionellSchluessel**

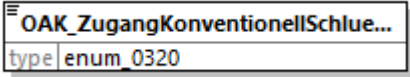
diagram																
type	enum 0320															
properties	content simple															
facets	<table border="1"> <thead> <tr> <th>Kind</th> <th>Value</th> <th>Annotation</th> </tr> </thead> <tbody> <tr> <td>enumeration</td> <td>0320001</td> <td>documentation konventionelle Sternotomie</td> </tr> <tr> <td>enumeration</td> <td>0320002</td> <td>documentation partielle Sternotomie</td> </tr> <tr> <td>enumeration</td> <td>0320003</td> <td>documentation parastemaler Zugang</td> </tr> <tr> <td>enumeration</td> <td>0320042</td> <td>documentation anderer Zugangsweg</td> </tr> </tbody> </table>	Kind	Value	Annotation	enumeration	0320001	documentation konventionelle Sternotomie	enumeration	0320002	documentation partielle Sternotomie	enumeration	0320003	documentation parastemaler Zugang	enumeration	0320042	documentation anderer Zugangsweg
Kind	Value	Annotation														
enumeration	0320001	documentation konventionelle Sternotomie														
enumeration	0320002	documentation partielle Sternotomie														
enumeration	0320003	documentation parastemaler Zugang														
enumeration	0320042	documentation anderer Zugangsweg														
source	<code><element name="OAK_ZugangKonventionellSchluessel" type="enum_0320"/></code>															

element **OperationAortenklappeBasis/OAK_ZugangKatheterSchluessel**

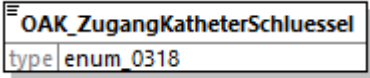
diagram																			
type	enum 0318																		
properties	content simple																		
facets	<table border="1"> <thead> <tr> <th>Kind</th> <th>Value</th> <th>Annotation</th> </tr> </thead> <tbody> <tr> <td>enumeration</td> <td>0318001</td> <td>documentation transapikal</td> </tr> <tr> <td>enumeration</td> <td>0318002</td> <td>documentation transaortal</td> </tr> <tr> <td>enumeration</td> <td>0318003</td> <td>documentation transfemoral</td> </tr> <tr> <td>enumeration</td> <td>0318004</td> <td>documentation transaxillär</td> </tr> <tr> <td>enumeration</td> <td>0318042</td> <td>documentation anderer Zugangsweg</td> </tr> </tbody> </table>	Kind	Value	Annotation	enumeration	0318001	documentation transapikal	enumeration	0318002	documentation transaortal	enumeration	0318003	documentation transfemoral	enumeration	0318004	documentation transaxillär	enumeration	0318042	documentation anderer Zugangsweg
Kind	Value	Annotation																	
enumeration	0318001	documentation transapikal																	
enumeration	0318002	documentation transaortal																	
enumeration	0318003	documentation transfemoral																	
enumeration	0318004	documentation transaxillär																	
enumeration	0318042	documentation anderer Zugangsweg																	
source	<code><element name="OAK_ZugangKatheterSchluessel" type="enum_0318"/></code>																		

element **OperationAortenklappeBasis/OAK_KomplikationenSchluessel**

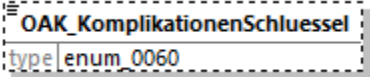
diagram										
type	enum 0060									
properties	<table border="1"> <tr> <td>minOcc</td> <td>0</td> </tr> <tr> <td>maxOcc</td> <td>1</td> </tr> <tr> <td>content</td> <td>simple</td> </tr> </table>	minOcc	0	maxOcc	1	content	simple			
minOcc	0									
maxOcc	1									
content	simple									
facets	<table border="1"> <thead> <tr> <th>Kind</th> <th>Value</th> <th>Annotation</th> </tr> </thead> <tbody> <tr> <td>enumeration</td> <td>0060001</td> <td>documentation ja</td> </tr> <tr> <td>enumeration</td> <td>0060002</td> <td>documentation nein</td> </tr> </tbody> </table>	Kind	Value	Annotation	enumeration	0060001	documentation ja	enumeration	0060002	documentation nein
Kind	Value	Annotation								
enumeration	0060001	documentation ja								
enumeration	0060002	documentation nein								

source	<code><element name="OAK_KomplikationenSchluessel" type="enum_0060" minOccurs="0"/></code>
--------	--

element **OperationAortenklappeBasis/OAK_TherapieLcoSchluessel**

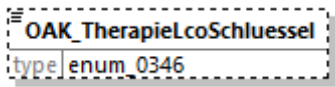
diagram																						
type	enum 0346																					
properties	minOcc 0 maxOcc 1 content simple																					
facets	<table border="1"> <thead> <tr> <th>Kind</th> <th>Value</th> <th>Annotation</th> </tr> </thead> <tbody> <tr> <td>enumeration</td> <td>0346001</td> <td>documentation keine Therapie erforderlich</td> </tr> <tr> <td>enumeration</td> <td>0346002</td> <td>documentation medikamentös</td> </tr> <tr> <td>enumeration</td> <td>0346003</td> <td>documentation IABP</td> </tr> <tr> <td>enumeration</td> <td>0346004</td> <td>documentation VAD</td> </tr> <tr> <td>enumeration</td> <td>0346005</td> <td>documentation ECMO</td> </tr> <tr> <td>enumeration</td> <td>0346042</td> <td>documentation sonstige</td> </tr> </tbody> </table>	Kind	Value	Annotation	enumeration	0346001	documentation keine Therapie erforderlich	enumeration	0346002	documentation medikamentös	enumeration	0346003	documentation IABP	enumeration	0346004	documentation VAD	enumeration	0346005	documentation ECMO	enumeration	0346042	documentation sonstige
Kind	Value	Annotation																				
enumeration	0346001	documentation keine Therapie erforderlich																				
enumeration	0346002	documentation medikamentös																				
enumeration	0346003	documentation IABP																				
enumeration	0346004	documentation VAD																				
enumeration	0346005	documentation ECMO																				
enumeration	0346042	documentation sonstige																				
source	<code><element name="OAK_TherapieLcoSchluessel" type="enum_0346" minOccurs="0"/></code>																					

element **OperationAortenklappeBasis/OAK_Durchleuchtungszeit**

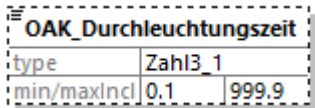
diagram																
type	Zahl3_1															
properties	minOcc 0 maxOcc 1 content simple															
facets	<table border="1"> <thead> <tr> <th>Kind</th> <th>Value</th> <th>Annotation</th> </tr> </thead> <tbody> <tr> <td>minInclusive</td> <td>0.1</td> <td></td> </tr> <tr> <td>maxInclusive</td> <td>999.9</td> <td></td> </tr> <tr> <td>totalDigits</td> <td>4</td> <td></td> </tr> <tr> <td>fractionDigits</td> <td>1</td> <td></td> </tr> </tbody> </table>	Kind	Value	Annotation	minInclusive	0.1		maxInclusive	999.9		totalDigits	4		fractionDigits	1	
Kind	Value	Annotation														
minInclusive	0.1															
maxInclusive	999.9															
totalDigits	4															
fractionDigits	1															
source	<code><element name="OAK_Durchleuchtungszeit" type="Zahl3_1" minOccurs="0"/></code>															

element **OperationAortenklappeBasis/OAK_BeatmungSchluessel**

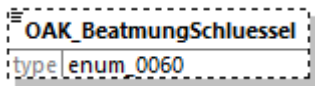
diagram	
type	enum 0060
properties	minOcc 0 maxOcc 1 content simple

facets	Kind enumeration	Value 0060001	Annotation documentation ja
	enumeration	0060002	documentation nein
source	<code><element name="OAK_BeatmungSchluessel" type="enum_0060" minOccurs="0"/></code>		

element **OperationAortenklappeBasis/OAK_TroponinSchluessel**

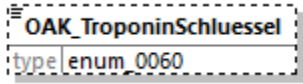
diagram			
type	enum_0060		
properties	minOcc 0 maxOcc 1 content simple		
facets	Kind enumeration	Value 0060001	Annotation documentation ja
	enumeration	0060002	documentation nein
source	<code><element name="OAK_TroponinSchluessel" type="enum_0060" minOccurs="0"/></code>		

element **OperationAortenklappeBasis/OAK_InotropeSchluessel**

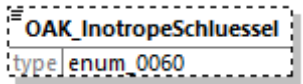
diagram			
type	enum_0060		
properties	minOcc 0 maxOcc 1 content simple		
facets	Kind enumeration	Value 0060001	Annotation documentation ja
	enumeration	0060002	documentation nein
source	<code><element name="OAK_InotropeSchluessel" type="enum_0060" minOccurs="0"/></code>		

element **OperationAortenklappeBasis/OAK_Eingriffsdauer**

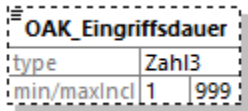
diagram			
type	Zahl3		
properties	minOcc 0 maxOcc 1 content simple		
facets	Kind minInclusive	Value 1	Annotation
	maxInclusive	999	

source	<code><element name="OAK_Eingriffsdauer" type="Zahl3" minOccurs="0"/></code>
--------	--

element **OperationAortenklappeBasis/OAK_EingriffsumfangSchluessel**

diagram										
type	enum 0347									
properties	minOcc 0 maxOcc 1 content simple									
facets	<table border="1"> <thead> <tr> <th>Kind</th> <th>Value</th> <th>Annotation</th> </tr> </thead> <tbody> <tr> <td>enumeration</td> <td>0347001</td> <td>documentation Einzeleingriff</td> </tr> <tr> <td>enumeration</td> <td>0347002</td> <td>documentation Kombinationseingriff mit mehreren Prozeduren</td> </tr> </tbody> </table>	Kind	Value	Annotation	enumeration	0347001	documentation Einzeleingriff	enumeration	0347002	documentation Kombinationseingriff mit mehreren Prozeduren
Kind	Value	Annotation								
enumeration	0347001	documentation Einzeleingriff								
enumeration	0347002	documentation Kombinationseingriff mit mehreren Prozeduren								
source	<code><element name="OAK_EingriffsumfangSchluessel" type="enum_0347" minOccurs="0"/></code>									

element **OperationAortenklappeBasis/OAK_ProzedurenAnzahl**

diagram										
type	Zahl1									
properties	minOcc 0 maxOcc 1 content simple									
facets	<table border="1"> <thead> <tr> <th>Kind</th> <th>Value</th> <th>Annotation</th> </tr> </thead> <tbody> <tr> <td>minInclusive</td> <td>1</td> <td></td> </tr> <tr> <td>maxInclusive</td> <td>9</td> <td></td> </tr> </tbody> </table>	Kind	Value	Annotation	minInclusive	1		maxInclusive	9	
Kind	Value	Annotation								
minInclusive	1									
maxInclusive	9									
source	<code><element name="OAK_ProzedurenAnzahl" type="Zahl1" minOccurs="0"/></code>									

element **OperationAortenklappeBasis/OAK_VorgehenSchluessel**

diagram													
type	enum 0348												
properties	minOcc 0 maxOcc 1 content simple												
facets	<table border="1"> <thead> <tr> <th>Kind</th> <th>Value</th> <th>Annotation</th> </tr> </thead> <tbody> <tr> <td>enumeration</td> <td>0348001</td> <td>documentation mit HLM</td> </tr> <tr> <td>enumeration</td> <td>0348002</td> <td>documentation ohne HLM</td> </tr> <tr> <td>enumeration</td> <td>0348003</td> <td>documentation Umstieg von OP ohne HLM auf OP mit HLM</td> </tr> </tbody> </table>	Kind	Value	Annotation	enumeration	0348001	documentation mit HLM	enumeration	0348002	documentation ohne HLM	enumeration	0348003	documentation Umstieg von OP ohne HLM auf OP mit HLM
Kind	Value	Annotation											
enumeration	0348001	documentation mit HLM											
enumeration	0348002	documentation ohne HLM											
enumeration	0348003	documentation Umstieg von OP ohne HLM auf OP mit HLM											
source	<code><element name="OAK_VorgehenSchluessel" type="enum_0348" minOccurs="0"/></code>												

element **OperationAortenklappeBasis/OAK_Bypasszeit**

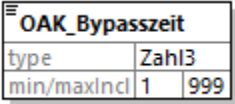
diagram										
type	Zahl3									
properties	content simple									
facets	<table border="1"> <thead> <tr> <th>Kind</th> <th>Value</th> <th>Annotation</th> </tr> </thead> <tbody> <tr> <td>minInclusive</td> <td>1</td> <td></td> </tr> <tr> <td>maxInclusive</td> <td>999</td> <td></td> </tr> </tbody> </table>	Kind	Value	Annotation	minInclusive	1		maxInclusive	999	
Kind	Value	Annotation								
minInclusive	1									
maxInclusive	999									
source	<code><element name="OAK_Bypasszeit" type="Zahl3"/></code>									

element **OperationAortenklappeBasis/OAK_BypasszeitUnbekannt**

diagram							
type	JaLeer						
properties	content simple						
facets	<table border="1"> <thead> <tr> <th>Kind</th> <th>Value</th> <th>Annotation</th> </tr> </thead> <tbody> <tr> <td>pattern</td> <td>(1)</td> <td></td> </tr> </tbody> </table>	Kind	Value	Annotation	pattern	(1)	
Kind	Value	Annotation					
pattern	(1)						
source	<code><element name="OAK_BypasszeitUnbekannt" type="JaLeer"/></code>						

element **OperationAortenklappeBasis/OAK_Abklemmzeit**

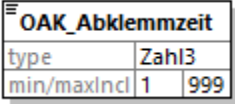
diagram										
type	Zahl3									
properties	content simple									
facets	<table border="1"> <thead> <tr> <th>Kind</th> <th>Value</th> <th>Annotation</th> </tr> </thead> <tbody> <tr> <td>minInclusive</td> <td>1</td> <td></td> </tr> <tr> <td>maxInclusive</td> <td>999</td> <td></td> </tr> </tbody> </table>	Kind	Value	Annotation	minInclusive	1		maxInclusive	999	
Kind	Value	Annotation								
minInclusive	1									
maxInclusive	999									
source	<code><element name="OAK_Abklemmzeit" type="Zahl3"/></code>									

element **OperationAortenklappeBasis/OAK_AbklemmzeitUnbekannt**

diagram	
type	JaLeer
properties	content simple

facets	Kind Value Annotation pattern (1)
source	<element name="OAK_AbklemmzeitUnbekannt" type="JaLeer"/>

element OperationAortenklappeBasis/OAK_AortaThorakalSchluessel

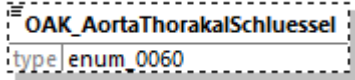
diagram										
type	enum_0060									
properties	minOcc 0 maxOcc 1 content simple									
facets	<table border="1"> <thead> <tr> <th>Kind</th> <th>Value</th> <th>Annotation</th> </tr> </thead> <tbody> <tr> <td>enumeration</td> <td>0060001</td> <td>documentation ja</td> </tr> <tr> <td>enumeration</td> <td>0060002</td> <td>documentation nein</td> </tr> </tbody> </table>	Kind	Value	Annotation	enumeration	0060001	documentation ja	enumeration	0060002	documentation nein
Kind	Value	Annotation								
enumeration	0060001	documentation ja								
enumeration	0060002	documentation nein								
source	<element name="OAK_AortaThorakalSchluessel" type="enum_0060" minOccurs="0"/>									

element OperationAortenklappeBasis/OAK_NeuroprotektionSchluessel

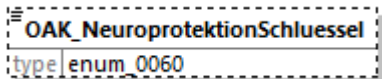
diagram										
type	enum_0060									
properties	minOcc 0 maxOcc 1 content simple									
facets	<table border="1"> <thead> <tr> <th>Kind</th> <th>Value</th> <th>Annotation</th> </tr> </thead> <tbody> <tr> <td>enumeration</td> <td>0060001</td> <td>documentation ja</td> </tr> <tr> <td>enumeration</td> <td>0060002</td> <td>documentation nein</td> </tr> </tbody> </table>	Kind	Value	Annotation	enumeration	0060001	documentation ja	enumeration	0060002	documentation nein
Kind	Value	Annotation								
enumeration	0060001	documentation ja								
enumeration	0060002	documentation nein								
source	<element name="OAK_NeuroprotektionSchluessel" type="enum_0060" minOccurs="0"/>									

element OperationAortenklappeBasis/OAK_KreislaufunterstuetzungSchluessel

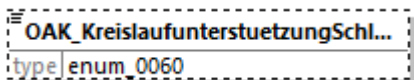
diagram										
type	enum_0060									
properties	minOcc 0 maxOcc 1 content simple									
facets	<table border="1"> <thead> <tr> <th>Kind</th> <th>Value</th> <th>Annotation</th> </tr> </thead> <tbody> <tr> <td>enumeration</td> <td>0060001</td> <td>documentation ja</td> </tr> <tr> <td>enumeration</td> <td>0060002</td> <td>documentation nein</td> </tr> </tbody> </table>	Kind	Value	Annotation	enumeration	0060001	documentation ja	enumeration	0060002	documentation nein
Kind	Value	Annotation								
enumeration	0060001	documentation ja								
enumeration	0060002	documentation nein								
source	<element name="OAK_KreislaufunterstuetzungSchluessel" type="enum_0060"/>									

	<code>minOccurs="0"/></code>
--	---------------------------------

element **OperationAortenklappeBasis/OAK_PraeOpUnterstuetzungSchluessel**

diagram										
type	enum_0060									
properties	minOcc 0 maxOcc 1 content simple									
facets	<table border="1"> <thead> <tr> <th>Kind</th> <th>Value</th> <th>Annotation</th> </tr> </thead> <tbody> <tr> <td>enumeration</td> <td>0060001</td> <td>documentation ja</td> </tr> <tr> <td>enumeration</td> <td>0060002</td> <td>documentation nein</td> </tr> </tbody> </table>	Kind	Value	Annotation	enumeration	0060001	documentation ja	enumeration	0060002	documentation nein
Kind	Value	Annotation								
enumeration	0060001	documentation ja								
enumeration	0060002	documentation nein								
source	<code><element name="OAK_PraeOpUnterstuetzungSchluessel" type="enum_0060" minOccurs="0"/></code>									

element **OperationAortenklappeBasis/OAK_PraeOpMethodeSchluessel**

diagram																			
type	enum_0350																		
properties	minOcc 0 maxOcc 1 content simple																		
facets	<table border="1"> <thead> <tr> <th>Kind</th> <th>Value</th> <th>Annotation</th> </tr> </thead> <tbody> <tr> <td>enumeration</td> <td>0350001</td> <td>documentation IABP</td> </tr> <tr> <td>enumeration</td> <td>0350002</td> <td>documentation Impella</td> </tr> <tr> <td>enumeration</td> <td>0350003</td> <td>documentation vv ECMO</td> </tr> <tr> <td>enumeration</td> <td>0350004</td> <td>documentation va ECMO</td> </tr> <tr> <td>enumeration</td> <td>0350042</td> <td>documentation andere</td> </tr> </tbody> </table>	Kind	Value	Annotation	enumeration	0350001	documentation IABP	enumeration	0350002	documentation Impella	enumeration	0350003	documentation vv ECMO	enumeration	0350004	documentation va ECMO	enumeration	0350042	documentation andere
Kind	Value	Annotation																	
enumeration	0350001	documentation IABP																	
enumeration	0350002	documentation Impella																	
enumeration	0350003	documentation vv ECMO																	
enumeration	0350004	documentation va ECMO																	
enumeration	0350042	documentation andere																	
source	<code><element name="OAK_PraeOpMethodeSchluessel" type="enum_0350" minOccurs="0"/></code>																		

element **OperationAortenklappeBasis/OAK_IntraOpUnterstuetzungSchluessel**

diagram										
type	enum_0060									
properties	minOcc 0 maxOcc 1 content simple									
facets	<table border="1"> <thead> <tr> <th>Kind</th> <th>Value</th> <th>Annotation</th> </tr> </thead> <tbody> <tr> <td>enumeration</td> <td>0060001</td> <td>documentation ja</td> </tr> <tr> <td>enumeration</td> <td>0060002</td> <td>documentation</td> </tr> </tbody> </table>	Kind	Value	Annotation	enumeration	0060001	documentation ja	enumeration	0060002	documentation
Kind	Value	Annotation								
enumeration	0060001	documentation ja								
enumeration	0060002	documentation								

	nein
source	<element name="OAK_IntraOpUnterstuetzungSchluessel" type="enum_0060" minOccurs="0"/>

element **OperationAortenklappeBasis/OAK_IntraOpMethodeSchluessel**

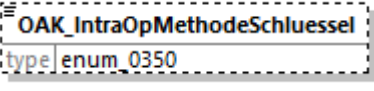
diagram			
type	enum 0350		
properties	minOcc 0 maxOcc 1 content simple		
facets	Kind	Value	Annotation
	enumeration	0350001	documentation IABP
	enumeration	0350002	documentation Impella
	enumeration	0350003	documentation vv ECMO
	enumeration	0350004	documentation va ECMO
	enumeration	0350042	documentation andere
source	<element name="OAK_IntraOpMethodeSchluessel" type="enum_0350" minOccurs="0"/>		

element **OperationAortenklappeBasis/OAK_AortenklappenOpAnzahl**

diagram			
type	Zahl2		
properties	minOcc 0 maxOcc 1 content simple		
facets	Kind	Value	Annotation
	minInclusive	1	
	maxInclusive	99	
source	<element name="OAK_AortenklappenOpAnzahl" type="Zahl2" minOccurs="0"/>		

element **OperationAortenklappeBasis/OAK_ValveInValveSchluessel**

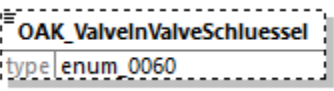
diagram			
type	enum 0060		
properties	minOcc 0 maxOcc 1 content simple		
facets	Kind	Value	Annotation
	enumeration	0060001	documentation ja

	enumeration 0060002 documentation nein
source	<code><element name="OAK_ValveInValveSchluessel" type="enum_0060" minOccurs="0"/></code>

element **OperationAortenklappeBasis/OAK_ZugangsGefaessdiameter**

diagram																
type	Zahl1_1															
properties	content simple															
facets	<table border="1"> <thead> <tr> <th>Kind</th> <th>Value</th> <th>Annotation</th> </tr> </thead> <tbody> <tr> <td>minInclusive</td> <td>0.1</td> <td></td> </tr> <tr> <td>maxInclusive</td> <td>9.9</td> <td></td> </tr> <tr> <td>totalDigits</td> <td>2</td> <td></td> </tr> <tr> <td>fractionDigits</td> <td>1</td> <td></td> </tr> </tbody> </table>	Kind	Value	Annotation	minInclusive	0.1		maxInclusive	9.9		totalDigits	2		fractionDigits	1	
Kind	Value	Annotation														
minInclusive	0.1															
maxInclusive	9.9															
totalDigits	2															
fractionDigits	1															
source	<code><element name="OAK_ZugangsGefaessdiameter" type="Zahl1_1"/></code>															

element **OperationAortenklappeBasis/OAK_ZugangsGefaessUnbekannt**

diagram							
type	JaLeer						
properties	content simple						
facets	<table border="1"> <thead> <tr> <th>Kind</th> <th>Value</th> <th>Annotation</th> </tr> </thead> <tbody> <tr> <td>pattern</td> <td>(1)</td> <td></td> </tr> </tbody> </table>	Kind	Value	Annotation	pattern	(1)	
Kind	Value	Annotation					
pattern	(1)						
source	<code><element name="OAK_ZugangsGefaessUnbekannt" type="JaLeer"/></code>						

element **OperationAortenklappeBasis/OAK_ZugangVerkalkungSchluessel**

diagram													
type	enum_0061												
properties	<table border="1"> <tbody> <tr> <td>minOcc</td> <td>0</td> </tr> <tr> <td>maxOcc</td> <td>1</td> </tr> <tr> <td>content</td> <td>simple</td> </tr> </tbody> </table>	minOcc	0	maxOcc	1	content	simple						
minOcc	0												
maxOcc	1												
content	simple												
facets	<table border="1"> <thead> <tr> <th>Kind</th> <th>Value</th> <th>Annotation</th> </tr> </thead> <tbody> <tr> <td>enumeration</td> <td>0061001</td> <td>documentation ja</td> </tr> <tr> <td>enumeration</td> <td>0061002</td> <td>documentation nein</td> </tr> <tr> <td>enumeration</td> <td>0061099</td> <td>documentation unbekannt</td> </tr> </tbody> </table>	Kind	Value	Annotation	enumeration	0061001	documentation ja	enumeration	0061002	documentation nein	enumeration	0061099	documentation unbekannt
Kind	Value	Annotation											
enumeration	0061001	documentation ja											
enumeration	0061002	documentation nein											
enumeration	0061099	documentation unbekannt											
source	<code><element name="OAK_ZugangVerkalkungSchluessel" type="enum_0061" minOccurs="0"/></code>												

element **OperationAortenklappeBasis/OAK_Aortenklappenannulus**

diagram	
type	Zahl3
properties	minOcc 0 maxOcc 1 content simple
facets	Kind Value Annotation minInclusive 1 maxInclusive 999
source	<code><element name="OAK_Aortenklappenannulus" type="Zahl3" minOccurs="0"/></code>

element **OperationAortenklappeBasis/OAK_MessmethodeSchluessel**

diagram	
type	enum_0339
properties	minOcc 0 maxOcc 1 content simple
facets	Kind Value Annotation enumeration 0339001 documentation TEE enumeration 0339002 documentation CT enumeration 0339042 documentation andere
source	<code><element name="OAK_MessmethodeSchluessel" type="enum_0339" minOccurs="0"/></code>

element **OperationAortenklappeBasis/OAK_DistanzRca**

diagram	
type	Zahl3
properties	content simple
facets	Kind Value Annotation minInclusive 1 maxInclusive 999
source	<code><element name="OAK_DistanzRca" type="Zahl3"/></code>

element **OperationAortenklappeBasis/OAK_DistanzRcaUnbekannt**

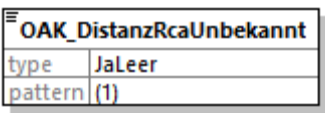
diagram							
type	JaLeer						
properties	content simple						
facets	<table border="1"> <thead> <tr> <th>Kind</th> <th>Value</th> <th>Annotation</th> </tr> </thead> <tbody> <tr> <td>pattern</td> <td>(1)</td> <td></td> </tr> </tbody> </table>	Kind	Value	Annotation	pattern	(1)	
Kind	Value	Annotation					
pattern	(1)						
source	<code><element name="OAK_DistanzRcaUnbekannt" type="JaLeer"/></code>						

element **OperationAortenklappeBasis/OAK_DistanzLca**

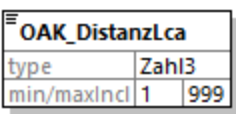
diagram										
type	Zahl3									
properties	content simple									
facets	<table border="1"> <thead> <tr> <th>Kind</th> <th>Value</th> <th>Annotation</th> </tr> </thead> <tbody> <tr> <td>minInclusive</td> <td>1</td> <td></td> </tr> <tr> <td>maxInclusive</td> <td>999</td> <td></td> </tr> </tbody> </table>	Kind	Value	Annotation	minInclusive	1		maxInclusive	999	
Kind	Value	Annotation								
minInclusive	1									
maxInclusive	999									
source	<code><element name="OAK_DistanzLca" type="Zahl3"/></code>									

element **OperationAortenklappeBasis/OAK_DistanzLcaUnbekannt**

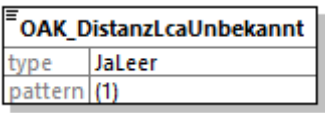
diagram							
type	JaLeer						
properties	content simple						
facets	<table border="1"> <thead> <tr> <th>Kind</th> <th>Value</th> <th>Annotation</th> </tr> </thead> <tbody> <tr> <td>pattern</td> <td>(1)</td> <td></td> </tr> </tbody> </table>	Kind	Value	Annotation	pattern	(1)	
Kind	Value	Annotation					
pattern	(1)						
source	<code><element name="OAK_DistanzLcaUnbekannt" type="JaLeer"/></code>						

element **OperationAortenklappeBasis/OAK_PtcaVorSchluessel**

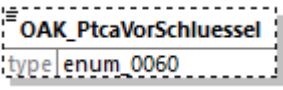
diagram							
type	enum_0060						
properties	<table border="1"> <tbody> <tr> <td>minOcc</td> <td>0</td> </tr> <tr> <td>maxOcc</td> <td>1</td> </tr> <tr> <td>content</td> <td>simple</td> </tr> </tbody> </table>	minOcc	0	maxOcc	1	content	simple
minOcc	0						
maxOcc	1						
content	simple						
facets	<table border="1"> <thead> <tr> <th>Kind</th> <th>Value</th> <th>Annotation</th> </tr> </thead> <tbody> <tr> <td>enumeration</td> <td>0060001</td> <td>documentation ja</td> </tr> </tbody> </table>	Kind	Value	Annotation	enumeration	0060001	documentation ja
Kind	Value	Annotation					
enumeration	0060001	documentation ja					

	enumeration 0060002 documentation nein
source	<element name="OAK_PtcaVorSchluessel" type="enum_0060" minOccurs="0"/>

element **OperationAortenklappeBasis/OAK_PtcaVorDurchmesser**

diagram										
type	Zahl2									
properties	content simple									
facets	<table border="1"> <thead> <tr> <th>Kind</th> <th>Value</th> <th>Annotation</th> </tr> </thead> <tbody> <tr> <td>minInclusive</td> <td>1</td> <td></td> </tr> <tr> <td>maxInclusive</td> <td>99</td> <td></td> </tr> </tbody> </table>	Kind	Value	Annotation	minInclusive	1		maxInclusive	99	
Kind	Value	Annotation								
minInclusive	1									
maxInclusive	99									
source	<element name="OAK_PtcaVorDurchmesser" type="Zahl2"/>									

element **OperationAortenklappeBasis/OAK_PtcaVorDurchmesserUnbekannt**

diagram							
type	JaLeer						
properties	content simple						
facets	<table border="1"> <thead> <tr> <th>Kind</th> <th>Value</th> <th>Annotation</th> </tr> </thead> <tbody> <tr> <td>pattern</td> <td>(1)</td> <td></td> </tr> </tbody> </table>	Kind	Value	Annotation	pattern	(1)	
Kind	Value	Annotation					
pattern	(1)						
source	<element name="OAK_PtcaVorDurchmesserUnbekannt" type="JaLeer"/>						

element **OperationAortenklappeBasis/OAK_PtcaVorAnzahl**

diagram										
type	Zahl2									
properties	<table border="1"> <tbody> <tr> <td>minOcc</td> <td>0</td> </tr> <tr> <td>maxOcc</td> <td>1</td> </tr> <tr> <td>content</td> <td>simple</td> </tr> </tbody> </table>	minOcc	0	maxOcc	1	content	simple			
minOcc	0									
maxOcc	1									
content	simple									
facets	<table border="1"> <thead> <tr> <th>Kind</th> <th>Value</th> <th>Annotation</th> </tr> </thead> <tbody> <tr> <td>minInclusive</td> <td>1</td> <td></td> </tr> <tr> <td>maxInclusive</td> <td>99</td> <td></td> </tr> </tbody> </table>	Kind	Value	Annotation	minInclusive	1		maxInclusive	99	
Kind	Value	Annotation								
minInclusive	1									
maxInclusive	99									
source	<element name="OAK_PtcaVorAnzahl" type="Zahl2" minOccurs="0"/>									

element **OperationAortenklappeBasis/OAK_RapidPacingVorSchluessel**

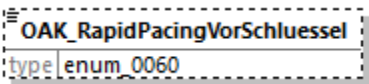
diagram										
type	enum 0060									
properties	minOcc 0 maxOcc 1 content simple									
facets	<table border="1"> <thead> <tr> <th>Kind</th> <th>Value</th> <th>Annotation</th> </tr> </thead> <tbody> <tr> <td>enumeration</td> <td>0060001</td> <td>documentation ja</td> </tr> <tr> <td>enumeration</td> <td>0060002</td> <td>documentation nein</td> </tr> </tbody> </table>	Kind	Value	Annotation	enumeration	0060001	documentation ja	enumeration	0060002	documentation nein
Kind	Value	Annotation								
enumeration	0060001	documentation ja								
enumeration	0060002	documentation nein								
source	<code><element name="OAK_RapidPacingVorSchluessel" type="enum_0060" minOccurs="0"/></code>									

element **OperationAortenklappeBasis/OAK_RapidPacingIntraSchluessel**

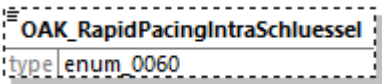
diagram										
type	enum 0060									
properties	minOcc 0 maxOcc 1 content simple									
facets	<table border="1"> <thead> <tr> <th>Kind</th> <th>Value</th> <th>Annotation</th> </tr> </thead> <tbody> <tr> <td>enumeration</td> <td>0060001</td> <td>documentation ja</td> </tr> <tr> <td>enumeration</td> <td>0060002</td> <td>documentation nein</td> </tr> </tbody> </table>	Kind	Value	Annotation	enumeration	0060001	documentation ja	enumeration	0060002	documentation nein
Kind	Value	Annotation								
enumeration	0060001	documentation ja								
enumeration	0060002	documentation nein								
source	<code><element name="OAK_RapidPacingIntraSchluessel" type="enum_0060" minOccurs="0"/></code>									

element **OperationAortenklappeBasis/OAK_PtcaNachSchluessel**

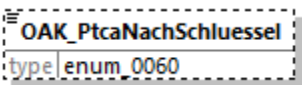
diagram										
type	enum 0060									
properties	minOcc 0 maxOcc 1 content simple									
facets	<table border="1"> <thead> <tr> <th>Kind</th> <th>Value</th> <th>Annotation</th> </tr> </thead> <tbody> <tr> <td>enumeration</td> <td>0060001</td> <td>documentation ja</td> </tr> <tr> <td>enumeration</td> <td>0060002</td> <td>documentation nein</td> </tr> </tbody> </table>	Kind	Value	Annotation	enumeration	0060001	documentation ja	enumeration	0060002	documentation nein
Kind	Value	Annotation								
enumeration	0060001	documentation ja								
enumeration	0060002	documentation nein								
source	<code><element name="OAK_PtcaNachSchluessel" type="enum_0060" minOccurs="0"/></code>									

element **OperationAortenklappeBasis/OAK_PtcaNachDurchmesser**

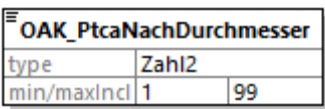
diagram										
type	Zahl2									
properties	content simple									
facets	<table border="1"> <thead> <tr> <th>Kind</th> <th>Value</th> <th>Annotation</th> </tr> </thead> <tbody> <tr> <td>minInclusive</td> <td>1</td> <td></td> </tr> <tr> <td>maxInclusive</td> <td>99</td> <td></td> </tr> </tbody> </table>	Kind	Value	Annotation	minInclusive	1		maxInclusive	99	
Kind	Value	Annotation								
minInclusive	1									
maxInclusive	99									
source	<code><element name="OAK_PtcaNachDurchmesser" type="Zahl2"/></code>									

element **OperationAortenklappeBasis/OAK_PtcaNachDurchmesserUnbekannt**

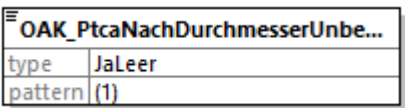
diagram							
type	JaLeer						
properties	content simple						
facets	<table border="1"> <thead> <tr> <th>Kind</th> <th>Value</th> <th>Annotation</th> </tr> </thead> <tbody> <tr> <td>pattern</td> <td>(1)</td> <td></td> </tr> </tbody> </table>	Kind	Value	Annotation	pattern	(1)	
Kind	Value	Annotation					
pattern	(1)						
source	<code><element name="OAK_PtcaNachDurchmesserUnbekannt" type="JaLeer"/></code>						

element **OperationAortenklappeBasis/OAK_PtcaNachAnzahl**

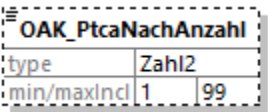
diagram										
type	Zahl2									
properties	<table border="1"> <tbody> <tr> <td>minOcc</td> <td>0</td> </tr> <tr> <td>maxOcc</td> <td>1</td> </tr> <tr> <td>content</td> <td>simple</td> </tr> </tbody> </table>	minOcc	0	maxOcc	1	content	simple			
minOcc	0									
maxOcc	1									
content	simple									
facets	<table border="1"> <thead> <tr> <th>Kind</th> <th>Value</th> <th>Annotation</th> </tr> </thead> <tbody> <tr> <td>minInclusive</td> <td>1</td> <td></td> </tr> <tr> <td>maxInclusive</td> <td>99</td> <td></td> </tr> </tbody> </table>	Kind	Value	Annotation	minInclusive	1		maxInclusive	99	
Kind	Value	Annotation								
minInclusive	1									
maxInclusive	99									
source	<code><element name="OAK_PtcaNachAnzahl" type="Zahl2" minOccurs="0"/></code>									

element **OperationAortenklappeBasis/OAK_RapidPacingNachSchluessel**

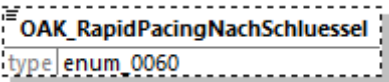
diagram							
type	enum_0060						
properties	<table border="1"> <tbody> <tr> <td>minOcc</td> <td>0</td> </tr> <tr> <td>maxOcc</td> <td>1</td> </tr> <tr> <td>content</td> <td>simple</td> </tr> </tbody> </table>	minOcc	0	maxOcc	1	content	simple
minOcc	0						
maxOcc	1						
content	simple						

facets	Kind enumeration	Value 0060001	Annotation documentation ja
	enumeration	0060002	documentation nein
source	<code><element name="OAK_RapidPacingNachSchluessel" type="enum_0060" minOccurs="0"/></code>		

element **OperationAortenklappeBasis/OAK_KonversionSchluessel**

diagram			
type	enum 0351		
properties	minOcc 0 maxOcc 1 content simple		
facets	Kind enumeration	Value 0351001	Annotation documentation nein
	enumeration	0351002	documentation ja, zu Stenotomie
	enumeration	0351003	documentation ja, zu transapikal
	enumeration	0351004	documentation ja, zu transaortal
	enumeration	0351005	documentation ja, zu transfemoral
	enumeration	0351006	documentation ja, zu transaxillär
	enumeration	0351007	documentation ja, zu anderem endovaskulären Zugang
	enumeration	0351042	documentation ja, zu anderem Zugang
source	<code><element name="OAK_KonversionSchluessel" type="enum_0351" minOccurs="0"/></code>		

element **OperationAortenklappeBasis/OAK_SuccessSchluessel**

diagram			
type	enum 0060		
properties	minOcc 0 maxOcc 1 content simple		
facets	Kind enumeration	Value 0060001	Annotation documentation ja
	enumeration	0060002	documentation nein
source	<code><element name="OAK_SuccessSchluessel" type="enum_0060" minOccurs="0"/></code>		

element **OperationAortenklappeBasis/OAK_AnaesthesieSchluessel**

diagram																
type	enum_0352															
properties	minOcc 0 maxOcc 1 content simple															
facets	<table border="1"> <thead> <tr> <th>Kind</th> <th>Value</th> <th>Annotation</th> </tr> </thead> <tbody> <tr> <td>enumeration</td> <td>0352001</td> <td>documentation nein</td> </tr> <tr> <td>enumeration</td> <td>0352002</td> <td>documentation ja, Intubationsnarkose</td> </tr> <tr> <td>enumeration</td> <td>0352003</td> <td>documentation ja, Maskenbeatmung, incl. LAMA</td> </tr> <tr> <td>enumeration</td> <td>0352042</td> <td>documentation ja, unbekannt welche</td> </tr> </tbody> </table>	Kind	Value	Annotation	enumeration	0352001	documentation nein	enumeration	0352002	documentation ja, Intubationsnarkose	enumeration	0352003	documentation ja, Maskenbeatmung, incl. LAMA	enumeration	0352042	documentation ja, unbekannt welche
Kind	Value	Annotation														
enumeration	0352001	documentation nein														
enumeration	0352002	documentation ja, Intubationsnarkose														
enumeration	0352003	documentation ja, Maskenbeatmung, incl. LAMA														
enumeration	0352042	documentation ja, unbekannt welche														
source	<code><element name="OAK_AnaesthesieSchluessel" type="enum_0352" minOccurs="0"/></code>															

element **OperationAortenklappeBasis/OAK_DeltaPmeanNachOp**

diagram										
type	Zahl3mitNull									
properties	content simple									
facets	<table border="1"> <thead> <tr> <th>Kind</th> <th>Value</th> <th>Annotation</th> </tr> </thead> <tbody> <tr> <td>minInclusive</td> <td>0</td> <td></td> </tr> <tr> <td>maxInclusive</td> <td>999</td> <td></td> </tr> </tbody> </table>	Kind	Value	Annotation	minInclusive	0		maxInclusive	999	
Kind	Value	Annotation								
minInclusive	0									
maxInclusive	999									
source	<code><element name="OAK_DeltaPmeanNachOp" type="Zahl3mitNull"/></code>									

element **OperationAortenklappeBasis/OAK_DeltaPmeanNachOpUnbekannt**

diagram							
type	JaLeer						
properties	content simple						
facets	<table border="1"> <thead> <tr> <th>Kind</th> <th>Value</th> <th>Annotation</th> </tr> </thead> <tbody> <tr> <td>pattern</td> <td>(1)</td> <td></td> </tr> </tbody> </table>	Kind	Value	Annotation	pattern	(1)	
Kind	Value	Annotation					
pattern	(1)						
source	<code><element name="OAK_DeltaPmeanNachOpUnbekannt" type="JaLeer"/></code>						

element **OperationAortenklappeBasis/OAK_ResidualeInsuffizienzSchluessel**

diagram	
---------	--

type	enum 0353																		
properties	minOcc 0 maxOcc 1 content simple																		
facets	<table border="1"> <thead> <tr> <th>Kind</th> <th>Value</th> <th>Annotation</th> </tr> </thead> <tbody> <tr> <td>enumeration</td> <td>0353001</td> <td>documentation keine</td> </tr> <tr> <td>enumeration</td> <td>0353002</td> <td>documentation leichtgradig</td> </tr> <tr> <td>enumeration</td> <td>0353003</td> <td>documentation mittelgradig</td> </tr> <tr> <td>enumeration</td> <td>0353004</td> <td>documentation hochgradig</td> </tr> <tr> <td>enumeration</td> <td>0353099</td> <td>documentation nicht bestimmbar</td> </tr> </tbody> </table>	Kind	Value	Annotation	enumeration	0353001	documentation keine	enumeration	0353002	documentation leichtgradig	enumeration	0353003	documentation mittelgradig	enumeration	0353004	documentation hochgradig	enumeration	0353099	documentation nicht bestimmbar
Kind	Value	Annotation																	
enumeration	0353001	documentation keine																	
enumeration	0353002	documentation leichtgradig																	
enumeration	0353003	documentation mittelgradig																	
enumeration	0353004	documentation hochgradig																	
enumeration	0353099	documentation nicht bestimmbar																	
source	<code><element name="OAK_ResidualeInsuffizienzSchluessel" type="enum_0353" minOccurs="0"/></code>																		

element **OperationAortenklappeBasis/OAK_ZugangVerschlussSchluessel**

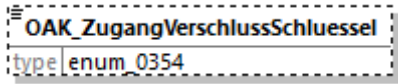
diagram													
type	enum 0354												
properties	minOcc 0 maxOcc 1 content simple												
facets	<table border="1"> <thead> <tr> <th>Kind</th> <th>Value</th> <th>Annotation</th> </tr> </thead> <tbody> <tr> <td>enumeration</td> <td>0354001</td> <td>documentation chirurgisch-offen</td> </tr> <tr> <td>enumeration</td> <td>0354002</td> <td>documentation Verschluss-System</td> </tr> <tr> <td>enumeration</td> <td>0354042</td> <td>documentation sonstiger</td> </tr> </tbody> </table>	Kind	Value	Annotation	enumeration	0354001	documentation chirurgisch-offen	enumeration	0354002	documentation Verschluss-System	enumeration	0354042	documentation sonstiger
Kind	Value	Annotation											
enumeration	0354001	documentation chirurgisch-offen											
enumeration	0354002	documentation Verschluss-System											
enumeration	0354042	documentation sonstiger											
source	<code><element name="OAK_ZugangVerschlussSchluessel" type="enum_0354" minOccurs="0"/></code>												

element **OperationAortenklappeBasis/OAK_ZusaetzlichePciSchluessel**

diagram										
type	enum 0060									
properties	minOcc 0 maxOcc 1 content simple									
facets	<table border="1"> <thead> <tr> <th>Kind</th> <th>Value</th> <th>Annotation</th> </tr> </thead> <tbody> <tr> <td>enumeration</td> <td>0060001</td> <td>documentation ja</td> </tr> <tr> <td>enumeration</td> <td>0060002</td> <td>documentation nein</td> </tr> </tbody> </table>	Kind	Value	Annotation	enumeration	0060001	documentation ja	enumeration	0060002	documentation nein
Kind	Value	Annotation								
enumeration	0060001	documentation ja								
enumeration	0060002	documentation nein								
source	<code><element name="OAK_ZusaetzlichePciSchluessel" type="enum_0060" minOccurs="0"/></code>									

element **OperationAortenklappeBasis/OAK_PciWegenKhkSchluessel**

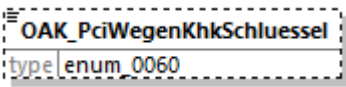
diagram										
type	enum 0060									
properties	minOcc 0 maxOcc 1 content simple									
facets	<table border="1"> <thead> <tr> <th>Kind</th> <th>Value</th> <th>Annotation</th> </tr> </thead> <tbody> <tr> <td>enumeration</td> <td>0060001</td> <td>documentation ja</td> </tr> <tr> <td>enumeration</td> <td>0060002</td> <td>documentation nein</td> </tr> </tbody> </table>	Kind	Value	Annotation	enumeration	0060001	documentation ja	enumeration	0060002	documentation nein
Kind	Value	Annotation								
enumeration	0060001	documentation ja								
enumeration	0060002	documentation nein								
source	<code><element name="OAK_PciWegenKhkSchluessel" type="enum_0060" minOccurs="0"/></code>									

element **OperationAortenklappeBasis/OAK_PciWegenKomplikationSchluessel**

diagram										
type	enum 0060									
properties	minOcc 0 maxOcc 1 content simple									
facets	<table border="1"> <thead> <tr> <th>Kind</th> <th>Value</th> <th>Annotation</th> </tr> </thead> <tbody> <tr> <td>enumeration</td> <td>0060001</td> <td>documentation ja</td> </tr> <tr> <td>enumeration</td> <td>0060002</td> <td>documentation nein</td> </tr> </tbody> </table>	Kind	Value	Annotation	enumeration	0060001	documentation ja	enumeration	0060002	documentation nein
Kind	Value	Annotation								
enumeration	0060001	documentation ja								
enumeration	0060002	documentation nein								
source	<code><element name="OAK_PciWegenKomplikationSchluessel" type="enum_0060" minOccurs="0"/></code>									

element **OperationAortenklappeBasis/OAK_LaesionenAnzahl**

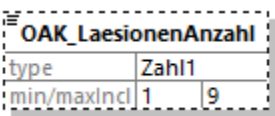
diagram										
type	Zahl1									
properties	minOcc 0 maxOcc 1 content simple									
facets	<table border="1"> <thead> <tr> <th>Kind</th> <th>Value</th> <th>Annotation</th> </tr> </thead> <tbody> <tr> <td>minInclusive</td> <td>1</td> <td></td> </tr> <tr> <td>maxInclusive</td> <td>9</td> <td></td> </tr> </tbody> </table>	Kind	Value	Annotation	minInclusive	1		maxInclusive	9	
Kind	Value	Annotation								
minInclusive	1									
maxInclusive	9									
source	<code><element name="OAK_LaesionenAnzahl" type="Zahl1" minOccurs="0"/></code>									

complexType TaviAortenklappeBasis

diagram	
namespace	http://xml.ir-d.de/emg
children	TAK GrundTaviSchluessel
used by	element OperationAortenklappe/taviAortenklappe
source	<pre><complexType name="TaviAortenklappeBasis"> <sequence> <element name="TAK_GrundTaviSchluessel" type="enum_0342"/> </sequence> </complexType></pre>

element TaviAortenklappeBasis/TAK_GrundTaviSchluessel

diagram																						
type	enum 0342																					
properties	content simple																					
facets	<table border="1"> <thead> <tr> <th>Kind</th> <th>Value</th> <th>Annotation</th> </tr> </thead> <tbody> <tr> <td>enumeration</td> <td>0342001</td> <td>documentation Alter</td> </tr> <tr> <td>enumeration</td> <td>0342002</td> <td>documentation Frailty</td> </tr> <tr> <td>enumeration</td> <td>0342003</td> <td>documentation Hochrisiko</td> </tr> <tr> <td>enumeration</td> <td>0342004</td> <td>documentation Prognose-limitierende Zweiterkrankung</td> </tr> <tr> <td>enumeration</td> <td>0342005</td> <td>documentation Porzellan-Aorta</td> </tr> <tr> <td>enumeration</td> <td>0342042</td> <td>documentation sonstiger</td> </tr> </tbody> </table>	Kind	Value	Annotation	enumeration	0342001	documentation Alter	enumeration	0342002	documentation Frailty	enumeration	0342003	documentation Hochrisiko	enumeration	0342004	documentation Prognose-limitierende Zweiterkrankung	enumeration	0342005	documentation Porzellan-Aorta	enumeration	0342042	documentation sonstiger
Kind	Value	Annotation																				
enumeration	0342001	documentation Alter																				
enumeration	0342002	documentation Frailty																				
enumeration	0342003	documentation Hochrisiko																				
enumeration	0342004	documentation Prognose-limitierende Zweiterkrankung																				
enumeration	0342005	documentation Porzellan-Aorta																				
enumeration	0342042	documentation sonstiger																				
source	<pre><element name="TAK_GrundTaviSchluessel" type="enum_0342"/></pre>																					

complexType ProzedurenSchluesselAortenklappeBasis

diagram	
namespace	http://xml.ir-d.de/emg
children	PAK ProzedurenSchluessel
used by	element OperationAortenklappe/prozedurenSchluesselAortenklappe
source	<pre><complexType name="ProzedurenSchluesselAortenklappeBasis"> <sequence> <element name="PAK_ProzedurenSchluessel" type="OPS"/> </sequence> </complexType></pre>

element **ProzedurenSchluesselAortenklappeBasis/PAK_ProzedurenSchluessel**

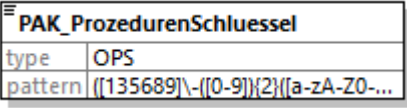
diagram							
type	OPS						
properties	content simple						
facets	<table border="1"> <thead> <tr> <th>Kind</th> <th>Value</th> <th>Annotation</th> </tr> </thead> <tbody> <tr> <td>pattern</td> <td>(([135689]\-[0-9]){2}([a-zA-Z0-9]{1}\.[a-zA-Z0-9]{1,2}))*(:[RLB])?</td> <td></td> </tr> </tbody> </table>	Kind	Value	Annotation	pattern	(([135689]\-[0-9]){2}([a-zA-Z0-9]{1}\.[a-zA-Z0-9]{1,2}))*(:[RLB])?	
Kind	Value	Annotation					
pattern	(([135689]\-[0-9]){2}([a-zA-Z0-9]{1}\.[a-zA-Z0-9]{1,2}))*(:[RLB])?						
source	<code><element name="PAK_ProzedurenSchluessel" type="OPS"/></code>						

complexType **FailureGrundAortenklappeBasis**

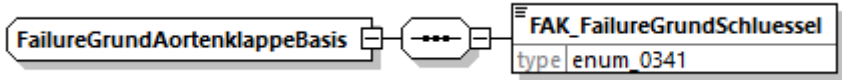
diagram	
namespace	http://xml.ir-d.de/emg
children	FAK_FailureGrundSchluessel
used by	element OperationAortenklappe/failureGrundAortenklappe
source	<code><complexType name="FailureGrundAortenklappeBasis"> <sequence> <element name="FAK_FailureGrundSchluessel" type="enum_0341"/> </sequence> </complexType></code>

element **FailureGrundAortenklappeBasis/FAK_FailureGrundSchluessel**

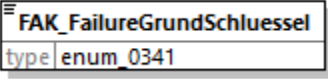
diagram																			
type	enum 0341																		
properties	content simple																		
facets	<table border="1"> <thead> <tr> <th>Kind</th> <th>Value</th> <th>Annotation</th> </tr> </thead> <tbody> <tr> <td>enumeration</td> <td>0341001</td> <td>documentation intraprozedural verstorben</td> </tr> <tr> <td>enumeration</td> <td>0341002</td> <td>documentation Implantation von mehr als einer Prothese</td> </tr> <tr> <td>enumeration</td> <td>0341003</td> <td>documentation gravierende Gefäß- oder Zugangskomplikation (gemäß VARC-3)</td> </tr> <tr> <td>enumeration</td> <td>0341004</td> <td>documentation erforderlicher chirurgischer oder interventioneller Eingriff wegen einer Klappenfehlfunktion (gemäß VARC-3)</td> </tr> <tr> <td>enumeration</td> <td>0341005</td> <td>documentation &gt;= große strukturelle kardiale Komplikation (gemäß VARC-3)</td> </tr> </tbody> </table>	Kind	Value	Annotation	enumeration	0341001	documentation intraprozedural verstorben	enumeration	0341002	documentation Implantation von mehr als einer Prothese	enumeration	0341003	documentation gravierende Gefäß- oder Zugangskomplikation (gemäß VARC-3)	enumeration	0341004	documentation erforderlicher chirurgischer oder interventioneller Eingriff wegen einer Klappenfehlfunktion (gemäß VARC-3)	enumeration	0341005	documentation >= große strukturelle kardiale Komplikation (gemäß VARC-3)
Kind	Value	Annotation																	
enumeration	0341001	documentation intraprozedural verstorben																	
enumeration	0341002	documentation Implantation von mehr als einer Prothese																	
enumeration	0341003	documentation gravierende Gefäß- oder Zugangskomplikation (gemäß VARC-3)																	
enumeration	0341004	documentation erforderlicher chirurgischer oder interventioneller Eingriff wegen einer Klappenfehlfunktion (gemäß VARC-3)																	
enumeration	0341005	documentation >= große strukturelle kardiale Komplikation (gemäß VARC-3)																	
source	<code><element name="FAK_FailureGrundSchluessel" type="enum_0341"/></code>																		

complexType **PciAortenklappeBasis**

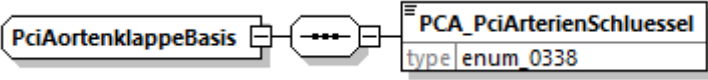
diagram	
namespace	http://xml.ir-d.de/emg
children	PCA_PciArterienSchluessel
used by	element OperationAortenklappe/pciAortenklappe
source	<pre><complexType name="PciAortenklappeBasis"> <sequence> <element name="PCA_PciArterienSchluessel" type="enum_0338"/> </sequence> </complexType></pre>

element **PciAortenklappeBasis/PCA_PciArterienSchluessel**

diagram																
type	enum_0338															
properties	content simple															
facets	<table border="1"> <thead> <tr> <th>Kind</th> <th>Value</th> <th>Annotation</th> </tr> </thead> <tbody> <tr> <td>enumeration</td> <td>0338001</td> <td>documentation LAD</td> </tr> <tr> <td>enumeration</td> <td>0338002</td> <td>documentation RCA</td> </tr> <tr> <td>enumeration</td> <td>0338003</td> <td>documentation RCX</td> </tr> <tr> <td>enumeration</td> <td>0338004</td> <td>documentation Hauptstamm</td> </tr> </tbody> </table>	Kind	Value	Annotation	enumeration	0338001	documentation LAD	enumeration	0338002	documentation RCA	enumeration	0338003	documentation RCX	enumeration	0338004	documentation Hauptstamm
Kind	Value	Annotation														
enumeration	0338001	documentation LAD														
enumeration	0338002	documentation RCA														
enumeration	0338003	documentation RCX														
enumeration	0338004	documentation Hauptstamm														
source	<pre><element name="PCA_PciArterienSchluessel" type="enum_0338"/></pre>															

complexType **KomplikationAortenklappeBasis**

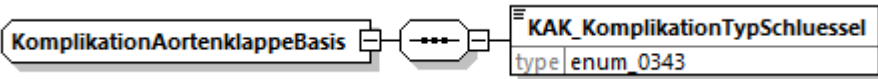
diagram	
namespace	http://xml.ir-d.de/emg
children	KAK_KomplikationTypSchluessel
used by	element OperationAortenklappe/komplikationAortenklappe
source	<pre><complexType name="KomplikationAortenklappeBasis"> <sequence> <element name="KAK_KomplikationTypSchluessel" type="enum_0343"/> </sequence> </complexType></pre>

element **KomplikationAortenklappeBasis/KAK_KomplikationTypSchluessel**

diagram			
type	enum 0343		
properties	content simple		
facets	Kind	Value	Annotation
	enumeration	0343001	documentation Device-Fehlpositionierung
	enumeration	0343002	documentation Koronarostienverschluss
	enumeration	0343003	documentation Aortendissektion
	enumeration	0343004	documentation Aortenregurgitation > = 2. Grades
	enumeration	0343005	documentation Annulus-Ruptur
	enumeration	0343006	documentation Ruptur-/Perforation einer Herzhöhle ohne Therapiebedarf
	enumeration	0343007	documentation Ruptur-/Perforation einer Herzhöhle mit Therapiebedarf
	enumeration	0343008	documentation Perikardtamponade
	enumeration	0343009	documentation kardiale Dekompensation
	enumeration	0343010	documentation Hirnembolie
	enumeration	0343011	documentation Rhythmusstörungen
	enumeration	0343012	documentation Device-Embolisation
	enumeration	0343013	documentation vaskuläre Komplikation
	enumeration	0343014	documentation Low Cardiac Output
	enumeration	0343015	documentation schwerwiegende Blutungen (intraprozedural)
	enumeration	0343016	documentation lebensbedrohliche Blutungen (intraprozedural)
	enumeration	0343017	documentation Patient verstarb im OP/Katheterlabor
	enumeration	0343042	documentation sonstiger
source	<code><element name="KAK_KomplikationTypSchluessel" type="enum_0343"/></code>		

complexType ArtikelidentifikationBasis

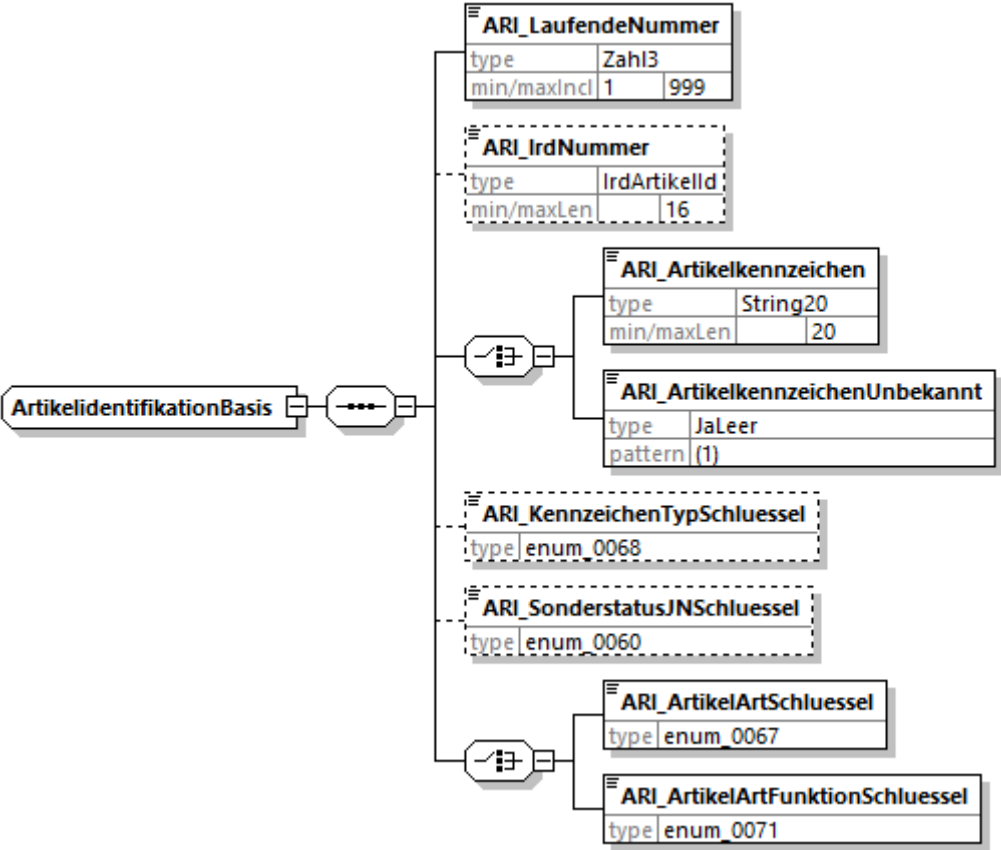
<p>diagram</p>	
<p>namespace</p>	<p>http://xml.ir-d.de/emg</p>
<p>children</p>	<p>ARI LaufendeNummer ARI IrdNummer ARI Artikelkennzeichen ARI ArtikelkennzeichenUnbekannt ARI KennzeichenTypSchluessel ARI SonderstatusJNSchluessel ARI ArtikelArtSchluessel ARI ArtikelArtFunktionSchluessel</p>
<p>used by</p>	<p>complexType Artikelidentifikation</p>
<p>source</p>	<pre> <complexType name="ArtikelidentifikationBasis"> <sequence> <element name="ARI_LaufendeNummer" type="Zahl3"/> <element name="ARI_IrdNummer" type="IrdArtikelId" minOccurs="0"/> <choice> <element name="ARI_Artikelkennzeichen" type="String20"/> <element name="ARI_ArtikelkennzeichenUnbekannt" type="JaLeer"/> </choice> <element name="ARI_KennzeichenTypSchluessel" type="enum_0068" minOccurs="0"/> <element name="ARI_SonderstatusJNSchluessel" type="enum_0060" minOccurs="0"/> <choice> <element name="ARI_ArtikelArtSchluessel" type="enum_0067"/> <element name="ARI_ArtikelArtFunktionSchluessel" type="enum_0071"/> </choice> </sequence> </complexType> </pre>

element **ArtikelidentifikationBasis/ARI_LaufendeNummer**

diagram										
type	Zahl3									
properties	content simple									
facets	<table border="1"> <thead> <tr> <th>Kind</th> <th>Value</th> <th>Annotation</th> </tr> </thead> <tbody> <tr> <td>minInclusive</td> <td>1</td> <td></td> </tr> <tr> <td>maxInclusive</td> <td>999</td> <td></td> </tr> </tbody> </table>	Kind	Value	Annotation	minInclusive	1		maxInclusive	999	
Kind	Value	Annotation								
minInclusive	1									
maxInclusive	999									
source	<code><element name="ARI_LaufendeNummer" type="Zahl3"/></code>									

element **ArtikelidentifikationBasis/ARI_IrdNummer**

diagram							
type	IrdArtikelId						
properties	<table border="1"> <tbody> <tr> <td>minOcc</td> <td>0</td> </tr> <tr> <td>maxOcc</td> <td>1</td> </tr> <tr> <td>content</td> <td>simple</td> </tr> </tbody> </table>	minOcc	0	maxOcc	1	content	simple
minOcc	0						
maxOcc	1						
content	simple						
facets	<table border="1"> <thead> <tr> <th>Kind</th> <th>Value</th> <th>Annotation</th> </tr> </thead> <tbody> <tr> <td>maxLength</td> <td>16</td> <td></td> </tr> </tbody> </table>	Kind	Value	Annotation	maxLength	16	
Kind	Value	Annotation					
maxLength	16						
source	<code><element name="ARI_IrdNummer" type="IrdArtikelId" minOccurs="0"/></code>						

element **ArtikelidentifikationBasis/ARI_Artikelkennzeichen**

diagram							
type	String20						
properties	content simple						
facets	<table border="1"> <thead> <tr> <th>Kind</th> <th>Value</th> <th>Annotation</th> </tr> </thead> <tbody> <tr> <td>maxLength</td> <td>20</td> <td></td> </tr> </tbody> </table>	Kind	Value	Annotation	maxLength	20	
Kind	Value	Annotation					
maxLength	20						
source	<code><element name="ARI_Artikelkennzeichen" type="String20"/></code>						

element **ArtikelidentifikationBasis/ARI_ArtikelkennzeichenUnbekannt**

diagram							
type	JaLeer						
properties	content simple						
facets	<table border="1"> <thead> <tr> <th>Kind</th> <th>Value</th> <th>Annotation</th> </tr> </thead> <tbody> <tr> <td>pattern</td> <td>(1)</td> <td></td> </tr> </tbody> </table>	Kind	Value	Annotation	pattern	(1)	
Kind	Value	Annotation					
pattern	(1)						

source	<code><element name="ARI_ArtikelkennzeichenUnbekannt" type="JaLeer"/></code>
--------	--

element ArtikelidentifikationBasis/ARI_KennzeichenTypSchluessel

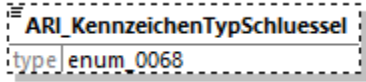
diagram										
type	enum 0068									
properties	minOcc 0 maxOcc 1 content simple									
facets	<table border="1"> <thead> <tr> <th>Kind</th> <th>Value</th> <th>Annotation</th> </tr> </thead> <tbody> <tr> <td>enumeration</td> <td>0068001</td> <td>documentation UDI</td> </tr> <tr> <td>enumeration</td> <td>0068002</td> <td>documentation Referenz (REF)</td> </tr> </tbody> </table>	Kind	Value	Annotation	enumeration	0068001	documentation UDI	enumeration	0068002	documentation Referenz (REF)
Kind	Value	Annotation								
enumeration	0068001	documentation UDI								
enumeration	0068002	documentation Referenz (REF)								
source	<code><element name="ARI_KennzeichenTypSchluessel" type="enum_0068" minOccurs="0"/></code>									

element ArtikelidentifikationBasis/ARI_SonderstatusJNSchluessel

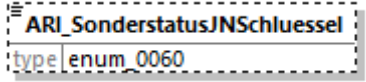
diagram										
type	enum 0060									
properties	minOcc 0 maxOcc 1 content simple									
facets	<table border="1"> <thead> <tr> <th>Kind</th> <th>Value</th> <th>Annotation</th> </tr> </thead> <tbody> <tr> <td>enumeration</td> <td>0060001</td> <td>documentation ja</td> </tr> <tr> <td>enumeration</td> <td>0060002</td> <td>documentation nein</td> </tr> </tbody> </table>	Kind	Value	Annotation	enumeration	0060001	documentation ja	enumeration	0060002	documentation nein
Kind	Value	Annotation								
enumeration	0060001	documentation ja								
enumeration	0060002	documentation nein								
source	<code><element name="ARI_SonderstatusJNSchluessel" type="enum_0060" minOccurs="0"/></code>									

element ArtikelidentifikationBasis/ARI_ArtikelArtSchluessel

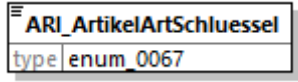
diagram										
type	enum 0067									
properties	content simple									
facets	<table border="1"> <thead> <tr> <th>Kind</th> <th>Value</th> <th>Annotation</th> </tr> </thead> <tbody> <tr> <td>enumeration</td> <td>0067001</td> <td>documentation Implantat</td> </tr> <tr> <td>enumeration</td> <td>0067002</td> <td>documentation Explantat</td> </tr> </tbody> </table>	Kind	Value	Annotation	enumeration	0067001	documentation Implantat	enumeration	0067002	documentation Explantat
Kind	Value	Annotation								
enumeration	0067001	documentation Implantat								
enumeration	0067002	documentation Explantat								
source	<code><element name="ARI_ArtikelArtSchluessel" type="enum_0067"/></code>									

element **ArtikelidentifikationBasis/ARI_ArtikelArtFunktionSchluessel**

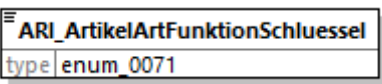
diagram			
type	enum 0071		
properties	content	simple	
facets	Kind	Value	Annotation
	enumeration	0071001	documentation Implantat
	enumeration	0071002	documentation Explantat
	enumeration	0071003	documentation Degeneriertes/defektes Produkt, das funktionslos im Körper verbleibt
source	<pre><element name="ARI_ArtikelArtFunktionSchluessel" type="enum_0071"/></pre>		

complexType Artikelbeschreibung

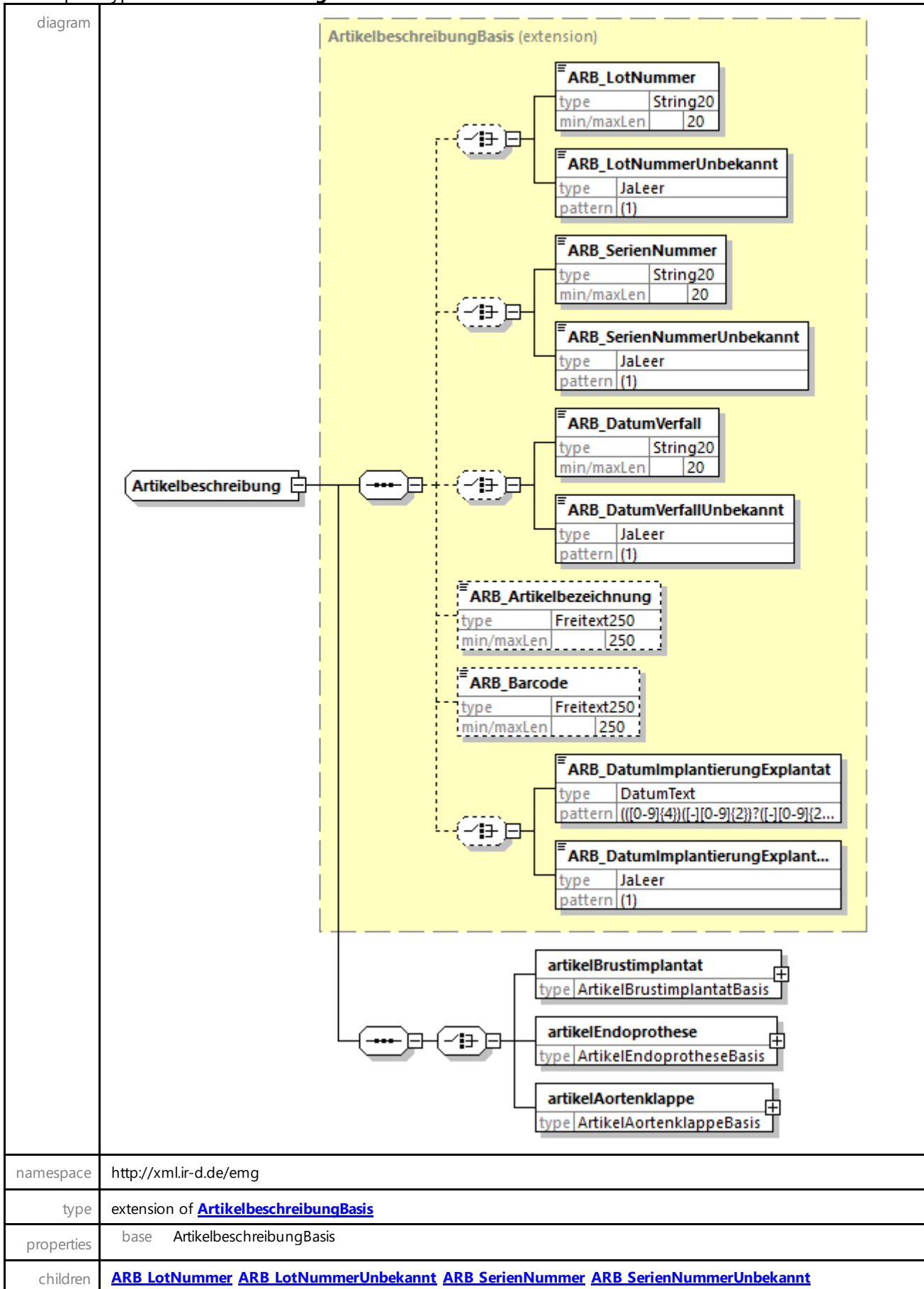

	ARB DatumVerfall ARB DatumVerfallUnbekannt ARB Artikelbezeichnung ARB Barcode ARB DatumImplantierungExplantat ARB DatumImplantierungExplantatUnbekannt artikelBrustimplantat artikelEndoprothese artikelAortenklappe
used by	element Artikelidentifikation/artikelbeschreibung
source	<pre> <complexType name="Artikelbeschreibung"> <complexContent> <extension base="ArtikelbeschreibungBasis"> <sequence> <choice> <element name="artikelBrustimplantat" type="ArtikelBrustimplantatBasis"/> <element name="artikelEndoprothese" type="ArtikelEndoprotheseBasis"/> <element name="artikelAortenklappe" type="ArtikelAortenklappeBasis"/> </choice> </sequence> </extension> </complexContent> </complexType> </pre>

element **Artikelbeschreibung/artikelBrustimplantat**

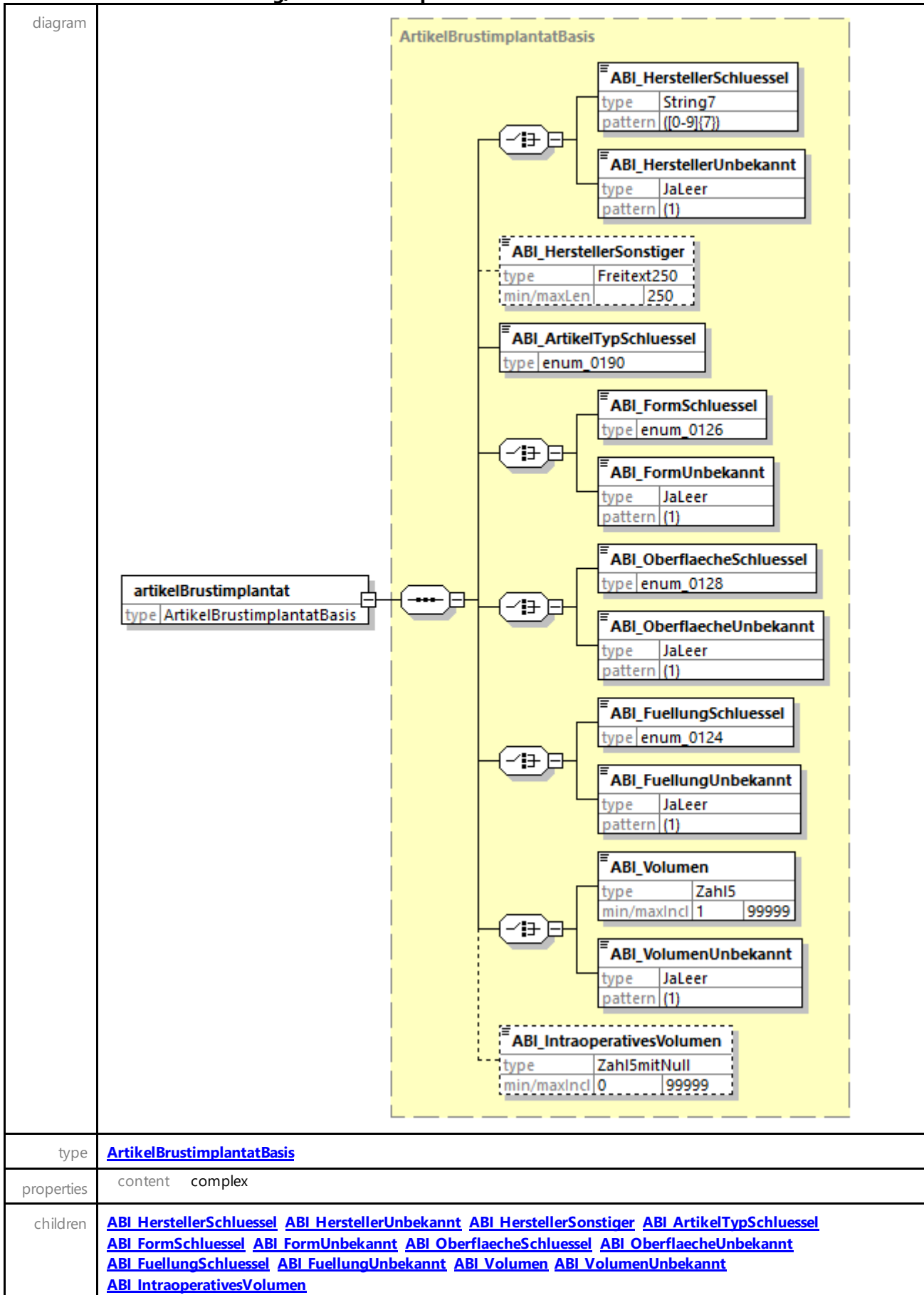

source <element name="artikelBrustimplantat" type="ArtikelBrustimplantatBasis"/>

element **Artikelbeschreibung/artikelEndoprothese**

diagram

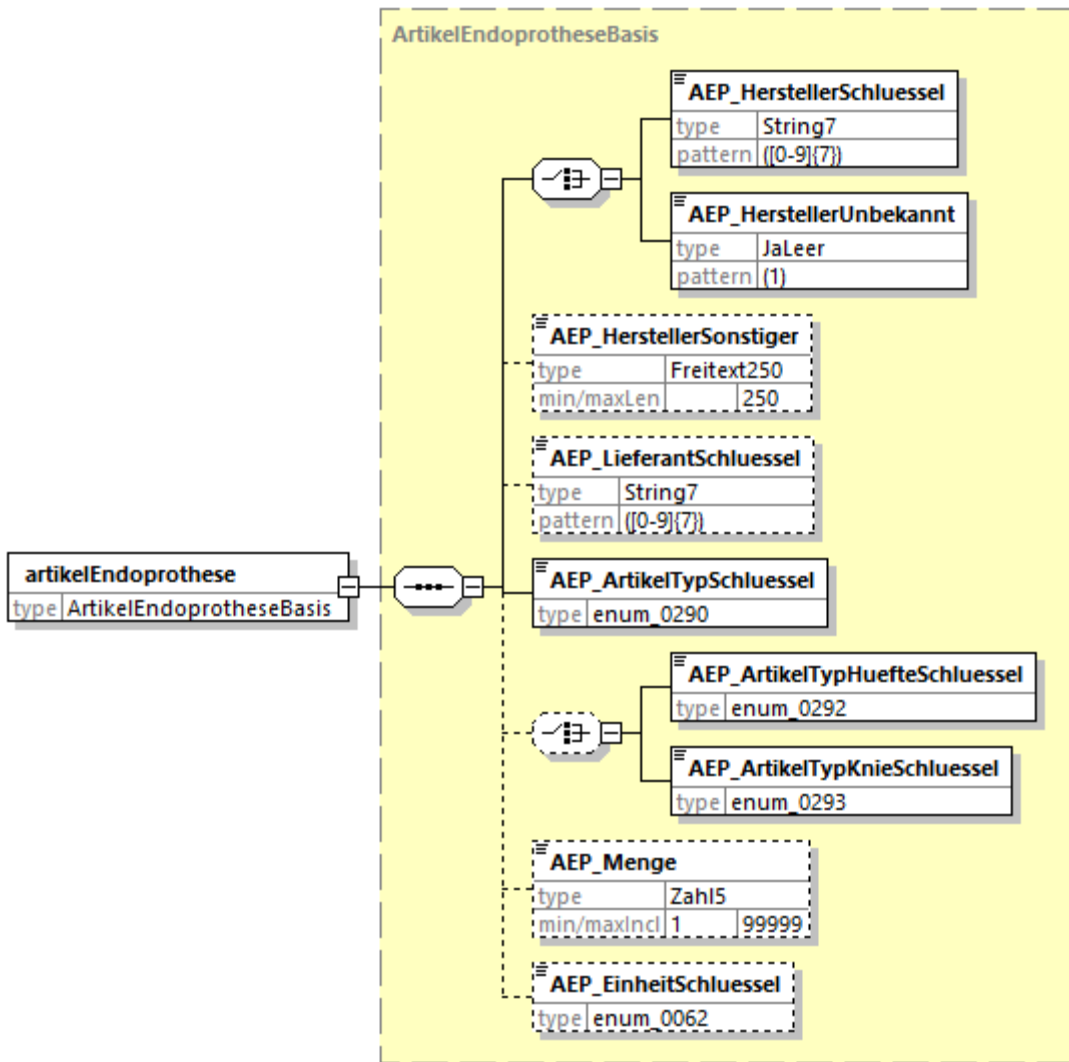

type [ArtikelEndoprotheseBasis](#)

properties content complex

children [AEP HerstellerSchluessel](#) [AEP HerstellerUnbekannt](#) [AEP HerstellerSonstiger](#) [AEP LieferantSchluessel](#) [AEP ArtikelTypSchluessel](#) [AEP ArtikelTypHuefteSchluessel](#) [AEP ArtikelTypKnieSchluessel](#) [AEP Menge](#) [AEP EinheitSchluessel](#)

source <element name="artikelEndoprothese" type="ArtikelEndoprotheseBasis"/>

element **Artikelbeschreibung/artikelAortenklappe**

<p>diagram</p>	
<p>type</p>	<p>ArtikelAortenklappeBasis</p>
<p>properties</p>	<p>content complex</p>
<p>children</p>	<p>AAK HerstellerSchluessel AAK HerstellerUnbekannt AAK HerstellerSonstiger AAK KlappenTypSchluessel AAK KlappenTypUnbekannt AAK ArtikelTypSchluessel AAK ProthesenGroesse AAK ProthesenGroesseUnbekannt AAK Dislokation</p>
<p>source</p>	<pre><element name="artikelAortenklappe" type="ArtikelAortenklappeBasis"/></pre>

complexType **ZubehoerBasis**

<p>diagram</p>	
<p>namespace</p>	<p>http://xml.ir-d.de/emg</p>
<p>children</p>	<p>ZUB LaufendeNummer ZUB ZubehoerArtSchluessel ZUB ArtikelNummer ZUB ArtikelNummerUnbekannt ZUB LotNummer ZUB LotNummerUnbekannt ZUB SerienNummer ZUB SerienNummerUnbekannt ZUB Artikelbezeichnung</p>
<p>used by</p>	<p>complexType Zubehoer</p>
<p>source</p>	<pre> <complexType name="ZubehoerBasis"> <sequence> <element name="ZUB_LaufendeNummer" type="Zahl3"/> <element name="ZUB_ZubehoerArtSchluessel" type="enum_0069"/> <choice> <element name="ZUB_ArtikelNummer" type="String20"/> <element name="ZUB_ArtikelNummerUnbekannt" type="JaLeer"/> </choice> <choice minOccurs="0"> <element name="ZUB_LotNummer" type="String20"/> <element name="ZUB_LotNummerUnbekannt" type="JaLeer"/> </choice> <choice minOccurs="0"> <element name="ZUB_SerienNummer" type="String20"/> <element name="ZUB_SerienNummerUnbekannt" type="JaLeer"/> </choice> </sequence> </pre>

	<pre><element name="ZUB_Artikelbezeichnung" type="Freitext250" minOccurs="0"/> </sequence> </complexType></pre>
--	---

element **ZubehoerBasis/ZUB_LaufendeNummer**

diagram										
type	Zahl3									
properties	content simple									
facets	<table border="1"> <thead> <tr> <th>Kind</th> <th>Value</th> <th>Annotation</th> </tr> </thead> <tbody> <tr> <td>minInclusive</td> <td>1</td> <td></td> </tr> <tr> <td>maxInclusive</td> <td>999</td> <td></td> </tr> </tbody> </table>	Kind	Value	Annotation	minInclusive	1		maxInclusive	999	
Kind	Value	Annotation								
minInclusive	1									
maxInclusive	999									
source	<pre><element name="ZUB_LaufendeNummer" type="Zahl3"/></pre>									

element **ZubehoerBasis/ZUB_ZubehoerArtSchluessel**

diagram										
type	enum_0069									
properties	content simple									
facets	<table border="1"> <thead> <tr> <th>Kind</th> <th>Value</th> <th>Annotation</th> </tr> </thead> <tbody> <tr> <td>enumeration</td> <td>0069001</td> <td>documentation Implantat</td> </tr> <tr> <td>enumeration</td> <td>0069002</td> <td>documentation Explantat</td> </tr> </tbody> </table>	Kind	Value	Annotation	enumeration	0069001	documentation Implantat	enumeration	0069002	documentation Explantat
Kind	Value	Annotation								
enumeration	0069001	documentation Implantat								
enumeration	0069002	documentation Explantat								
source	<pre><element name="ZUB_ZubehoerArtSchluessel" type="enum_0069"/></pre>									

element **ZubehoerBasis/ZUB_ArtikelNummer**

diagram							
type	String20						
properties	content simple						
facets	<table border="1"> <thead> <tr> <th>Kind</th> <th>Value</th> <th>Annotation</th> </tr> </thead> <tbody> <tr> <td>maxLength</td> <td>20</td> <td></td> </tr> </tbody> </table>	Kind	Value	Annotation	maxLength	20	
Kind	Value	Annotation					
maxLength	20						
source	<pre><element name="ZUB_ArtikelNummer" type="String20"/></pre>						

element **ZubehoerBasis/ZUB_ArtikelNummerUnbekannt**

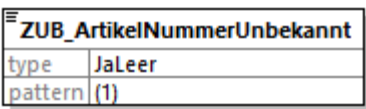
diagram	
type	JaLeer
properties	content simple
facets	Kind Value Annotation pattern (1)
source	<code><element name="ZUB_ArtikelNummerUnbekannt" type="JaLeer"/></code>

element **ZubehoerBasis/ZUB_LotNummer**

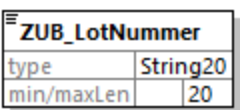
diagram	
type	String20
properties	content simple
facets	Kind Value Annotation maxLength 20
source	<code><element name="ZUB_LotNummer" type="String20"/></code>

element **ZubehoerBasis/ZUB_LotNummerUnbekannt**

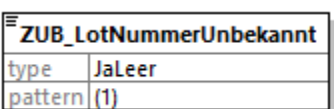
diagram	
type	JaLeer
properties	content simple
facets	Kind Value Annotation pattern (1)
source	<code><element name="ZUB_LotNummerUnbekannt" type="JaLeer"/></code>

element **ZubehoerBasis/ZUB_SerienNummer**

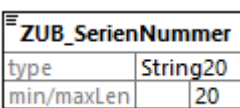
diagram	
type	String20
properties	content simple
facets	Kind Value Annotation maxLength 20
source	<code><element name="ZUB_SerienNummer" type="String20"/></code>

element **ZubehoerBasis/ZUB_SerienNummerUnbekannt**

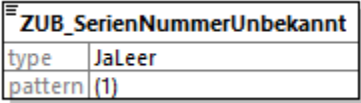
diagram							
type	JaLeer						
properties	content simple						
facets	<table border="1"> <thead> <tr> <th>Kind</th> <th>Value</th> <th>Annotation</th> </tr> </thead> <tbody> <tr> <td>pattern</td> <td>(1)</td> <td></td> </tr> </tbody> </table>	Kind	Value	Annotation	pattern	(1)	
Kind	Value	Annotation					
pattern	(1)						
source	<code><element name="ZUB_SerienNummerUnbekannt" type="JaLeer"/></code>						

element **ZubehoerBasis/ZUB_Artikelbezeichnung**

diagram							
type	Freitext250						
properties	<table border="1"> <tbody> <tr> <td>minOcc</td> <td>0</td> </tr> <tr> <td>maxOcc</td> <td>1</td> </tr> <tr> <td>content</td> <td>simple</td> </tr> </tbody> </table>	minOcc	0	maxOcc	1	content	simple
minOcc	0						
maxOcc	1						
content	simple						
facets	<table border="1"> <thead> <tr> <th>Kind</th> <th>Value</th> <th>Annotation</th> </tr> </thead> <tbody> <tr> <td>maxLength</td> <td>250</td> <td></td> </tr> </tbody> </table>	Kind	Value	Annotation	maxLength	250	
Kind	Value	Annotation					
maxLength	250						
source	<code><element name="ZUB_Artikelbezeichnung" type="Freitext250" minOccurs="0"/></code>						

complexType **ZubehoerBrustimplantatBasis**

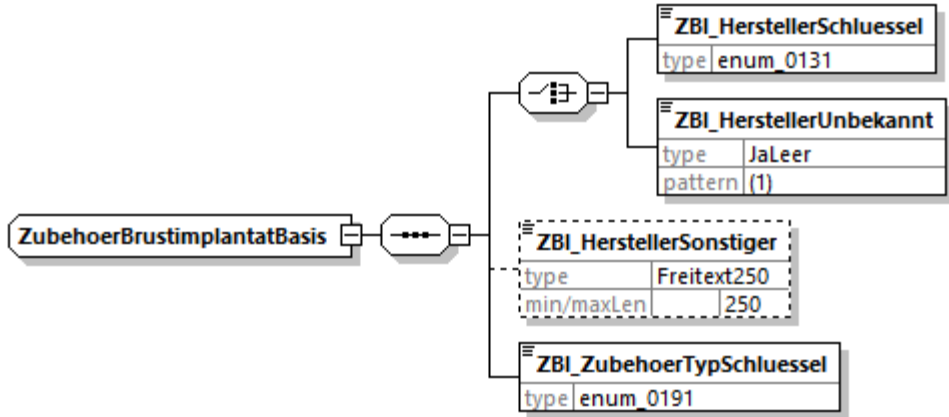
diagram	
namespace	http://xml.ir-d.de/emg
children	ZBI_HerstellerSchluessel ZBI_HerstellerUnbekannt ZBI_HerstellerSonstiger ZBI_ZubehoerTypSchluessel
used by	element Zubehoer/zubehoerBrustimplantat
source	<pre> <complexType name="ZubehoerBrustimplantatBasis"> <sequence> <choice> <element name="ZBI_HerstellerSchluessel" type="enum_0131"/> </pre>

```

<element name="ZBI_HerstellerUnbekannt" type="JaLeer"/>
</choice>
<element name="ZBI_HerstellerSonstiger" type="Freitext250"
minOccurs="0"/>
<element name="ZBI_ZubehoerTypSchluessel" type="enum_0191"/>
</sequence>
</complexType>

```

element **ZubehoerBrustimplantatBasis/ZBI_HerstellerSchluessel**

diagram			
type	enum 0131		
properties	content simple		
facets	Kind	Value	Annotation
	enumeration	0131001	documentation Allergan
	enumeration	0131002	documentation Establishment Labs
	enumeration	0131003	documentation Eurosilicone
	enumeration	0131004	documentation Galatea
	enumeration	0131005	documentation Integra
	enumeration	0131006	documentation Lifecell
	enumeration	0131007	documentation MBP (Medical Biomaterial Products)
	enumeration	0131008	documentation Mentor
	enumeration	0131009	documentation Novus Scientific
	enumeration	0131010	documentation pfmMedical
	enumeration	0131011	documentation Serag Wiessner
	enumeration	0131012	documentation nicht belegter Wert
	enumeration	0131013	documentation nicht belegter Wert
	enumeration	0131014	documentation nicht belegter Wert
	enumeration	0131015	documentation nicht belegter Wert
	enumeration	0131042	documentation sonstiger
source	<code><element name="ZBI_HerstellerSchluessel" type="enum_0131"/></code>		

element **ZubehoerBrustimplantatBasis/ZBI_HerstellerUnbekannt**

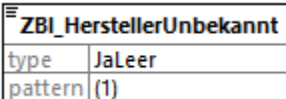
diagram			
type	JaLeer		

properties	content simple
facets	Kind Value Annotation pattern (1)
source	<code><element name="ZBI_HerstellerUnbekannt" type="JaLeer"/></code>

element **ZubehoerBrustimplantatBasis/ZBI_HerstellerSonstiger**

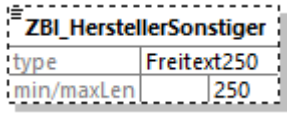
diagram	
type	Freitext250
properties	minOcc 0 maxOcc 1 content simple
facets	Kind Value Annotation maxLength 250
source	<code><element name="ZBI_HerstellerSonstiger" type="Freitext250" minOccurs="0"/></code>

element **ZubehoerBrustimplantatBasis/ZBI_ZubehoerTypSchluessel**

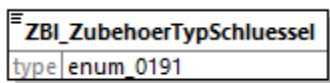
diagram	
type	enum 0191
properties	content simple
facets	Kind Value Annotation enumeration 0191001 documentation Netz enumeration 0191002 documentation ADM
source	<code><element name="ZBI_ZubehoerTypSchluessel" type="enum_0191"/></code>

complexType PatientenaufnahmeAortenklappeBasis

diagram

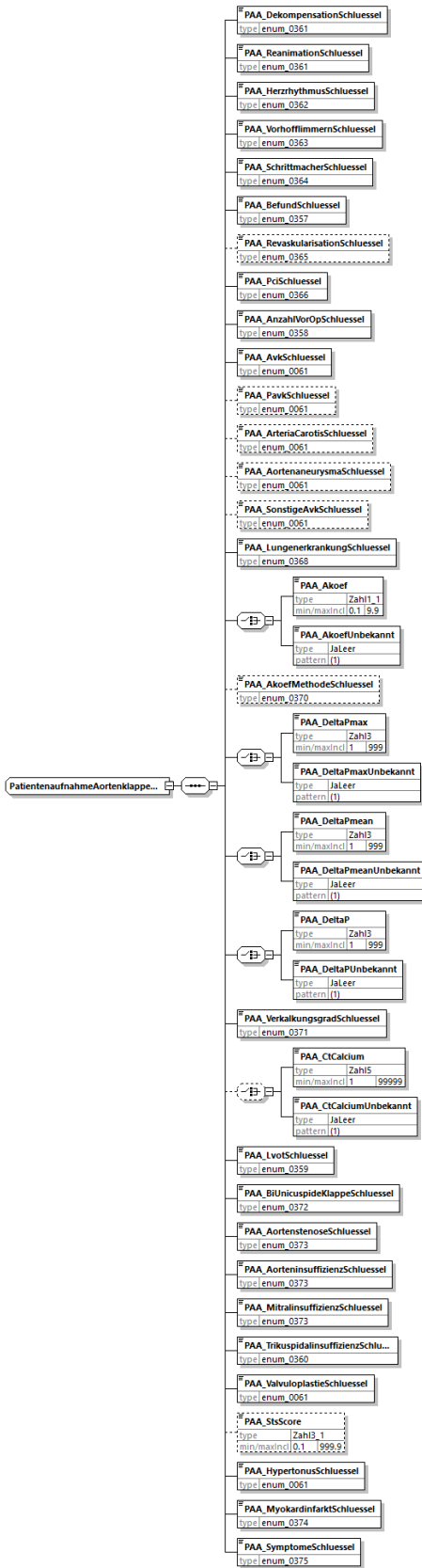

namespace http://xml.ir-d.de/emg

children [PAA DekompensationSchlüssel](#) [PAA ReanimationSchlüssel](#) [PAA HerzrhythmusSchlüssel](#) [PAA VorhofflimmernSchlüssel](#) [PAA SchrittmacherSchlüssel](#) [PAA BefundSchlüssel](#)

	PAA RevaskularisationSchluessel PAA PciSchluessel PAA AnzahlVorOpSchluessel PAA AvkSchluessel PAA PavkSchluessel PAA ArteriaCarotisSchluessel PAA AortenaneurysmaSchluessel PAA SonstigeAvkSchluessel PAA LungenerkrankungSchluessel PAA Akoef PAA AkoefUnbekannt PAA AkoefMethodeSchluessel PAA DeltaPmax PAA DeltaPmaxUnbekannt PAA DeltaPmean PAA DeltaPmeanUnbekannt PAA DeltaP PAA DeltaPUnbekannt PAA VerkalkungsgradSchluessel PAA CtCalcium PAA CtCalciumUnbekannt PAA LvotSchluessel PAA BiUnicuspideKlappeSchluessel PAA AortenstenoseSchluessel PAA AorteninsuffizienzSchluessel PAA MitralinsuffizienzSchluessel PAA TrikuspidalinsuffizienzSchluessel PAA ValvuloplastieSchluessel PAA StsScore PAA HypertonusSchluessel PAA MyokardinfarktSchluessel PAA SymptomeSchluessel
used by	complexType PatientenaufnahmeAortenklappe
source	<pre> <complexType name="PatientenaufnahmeAortenklappeBasis"> <sequence> <element name="PAA_DekompensationSchluessel" type="enum_0361"/> <element name="PAA_ReanimationSchluessel" type="enum_0361"/> <element name="PAA_HerzrhythmusSchluessel" type="enum_0362"/> <element name="PAA_VorhofflimmernSchluessel" type="enum_0363"/> <element name="PAA_SchrittmacherSchluessel" type="enum_0364"/> <element name="PAA_BefundSchluessel" type="enum_0357"/> <element name="PAA_RevaskularisationSchluessel" type="enum_0365" minOccurs="0"/> <element name="PAA_PciSchluessel" type="enum_0366"/> <element name="PAA_AnzahlVorOpSchluessel" type="enum_0358"/> <element name="PAA_AvkSchluessel" type="enum_0061"/> <element name="PAA_PavkSchluessel" type="enum_0061" minOccurs="0"/> <element name="PAA_ArteriaCarotisSchluessel" type="enum_0061" minOccurs="0"/> <element name="PAA_AortenaneurysmaSchluessel" type="enum_0061" minOccurs="0"/> <element name="PAA_SonstigeAvkSchluessel" type="enum_0061" minOccurs="0"/> <element name="PAA_LungenerkrankungSchluessel" type="enum_0368"/> <choice> <element name="PAA_Akoef" type="Zahl1_1"/> <element name="PAA_AkoefUnbekannt" type="JaLeer"/> </choice> <element name="PAA_AkoefMethodeSchluessel" type="enum_0370" minOccurs="0"/> <choice> <element name="PAA_DeltaPmax" type="Zahl3"/> <element name="PAA_DeltaPmaxUnbekannt" type="JaLeer"/> </choice> <choice> <element name="PAA_DeltaPmean" type="Zahl3"/> <element name="PAA_DeltaPmeanUnbekannt" type="JaLeer"/> </choice> <choice> <element name="PAA_DeltaP" type="Zahl3"/> <element name="PAA_DeltaPUnbekannt" type="JaLeer"/> </choice> <element name="PAA_VerkalkungsgradSchluessel" type="enum_0371"/> <choice minOccurs="0"> <element name="PAA_CtCalcium" type="Zahl15"/> <element name="PAA_CtCalciumUnbekannt" type="JaLeer"/> </choice> <element name="PAA_LvotSchluessel" type="enum_0359"/> <element name="PAA_BiUnicuspideKlappeSchluessel" type="enum_0372"/> <element name="PAA_AortenstenoseSchluessel" type="enum_0373"/> <element name="PAA_AorteninsuffizienzSchluessel" type="enum_0373"/> <element name="PAA_MitralinsuffizienzSchluessel" type="enum_0373"/> </pre>

	<pre> <element name="PAA_TrikuspidalinsuffizienzSchluessel" type="enum_0360"/> <element name="PAA_ValvuloplastieSchluessel" type="enum_0061"/> <element name="PAA_StsScore" type="Zahl3_1" minOccurs="0"/> <element name="PAA_HypertonusSchluessel" type="enum_0061"/> <element name="PAA_MyokardinfarktSchluessel" type="enum_0374"/> <element name="PAA_SymptomeSchluessel" type="enum_0375"/> </sequence> </complexType> </pre>
--	--

element **PatientenaufnahmeAortenklappeBasis/PAA_DekompensationSchluessel**

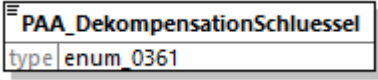
diagram			
type	enum 0361		
properties	content	simple	
facets	Kind	Value	Annotation
	enumeration	0361001	documentation nein
	enumeration	0361002	documentation ja, letzte(r) innerhalb der letzten 48 Stunden
	enumeration	0361003	documentation ja, letzte(r) innerhalb der letzten 21 Tage
	enumeration	0361004	documentation ja, letzte(r) länger als 21 Tage
	enumeration	0361098	documentation ja, letzter Zeitpunkt unbekannt
	enumeration	0361099	documentation unbekannt
source	<code><element name="PAA_DekompensationSchluessel" type="enum_0361"/></code>		

element **PatientenaufnahmeAortenklappeBasis/PAA_ReanimationSchluessel**

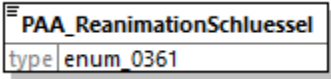
diagram			
type	enum 0361		
properties	content	simple	
facets	Kind	Value	Annotation
	enumeration	0361001	documentation nein
	enumeration	0361002	documentation ja, letzte(r) innerhalb der letzten 48 Stunden
	enumeration	0361003	documentation ja, letzte(r) innerhalb der letzten 21 Tage
	enumeration	0361004	documentation ja, letzte(r) länger als 21 Tage
	enumeration	0361098	documentation ja, letzter Zeitpunkt unbekannt
	enumeration	0361099	documentation unbekannt
source	<code><element name="PAA_ReanimationSchluessel" type="enum_0361"/></code>		

element **PatientenaufnahmeAortenklappeBasis/PAA_HerzrhythmusSchluessel**

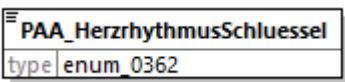
diagram			
type	enum 0362		
properties	content simple		
facets	Kind	Value	Annotation
	enumeration	0362001	documentation Sinusrhythmus
	enumeration	0362002	documentation Vorhofflimmern
	enumeration	0362042	documentation anderer Herzrhythmus
source	<code><element name="PAA_HerzrhythmusSchluessel" type="enum_0362"/></code>		

element **PatientenaufnahmeAortenklappeBasis/PAA_VorhofflimmernSchluessel**

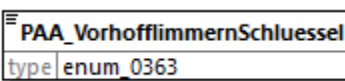
diagram			
type	enum 0363		
properties	content simple		
facets	Kind	Value	Annotation
	enumeration	0363001	documentation nein
	enumeration	0363002	documentation paroxysmal
	enumeration	0363003	documentation persistierend
	enumeration	0363004	documentation permanent
source	<code><element name="PAA_VorhofflimmernSchluessel" type="enum_0363"/></code>		

element **PatientenaufnahmeAortenklappeBasis/PAA_SchrittmacherSchluessel**

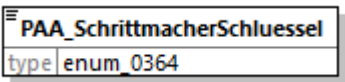
diagram			
type	enum 0364		
properties	content simple		
facets	Kind	Value	Annotation
	enumeration	0364001	documentation nein
	enumeration	0364002	documentation Schrittmacher ohne CRT-System
	enumeration	0364003	documentation Schrittmacher mit CRT-System
	enumeration	0364004	documentation Defibrillator ohne CRT-System
	enumeration	0364005	documentation Defibrillator mit CRT-System
source	<code><element name="PAA_SchrittmacherSchluessel" type="enum_0364"/></code>		

element **PatientenaufnahmeAortenklappeBasis/PAA_BefundSchluessel**

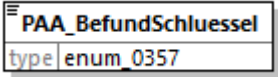
diagram																			
type	enum 0357																		
properties	content simple																		
facets	<table border="1"> <thead> <tr> <th>Kind</th> <th>Value</th> <th>Annotation</th> </tr> </thead> <tbody> <tr> <td>enumeration</td> <td>0357001</td> <td>documentation keine KHK</td> </tr> <tr> <td>enumeration</td> <td>0357002</td> <td>documentation 1-Gefäßerkrankung</td> </tr> <tr> <td>enumeration</td> <td>0357003</td> <td>documentation 2-Gefäßerkrankung</td> </tr> <tr> <td>enumeration</td> <td>0357004</td> <td>documentation 3-Gefäßerkrankung</td> </tr> <tr> <td>enumeration</td> <td>0357005</td> <td>documentation keine koronare Bildgebung</td> </tr> </tbody> </table>	Kind	Value	Annotation	enumeration	0357001	documentation keine KHK	enumeration	0357002	documentation 1-Gefäßerkrankung	enumeration	0357003	documentation 2-Gefäßerkrankung	enumeration	0357004	documentation 3-Gefäßerkrankung	enumeration	0357005	documentation keine koronare Bildgebung
Kind	Value	Annotation																	
enumeration	0357001	documentation keine KHK																	
enumeration	0357002	documentation 1-Gefäßerkrankung																	
enumeration	0357003	documentation 2-Gefäßerkrankung																	
enumeration	0357004	documentation 3-Gefäßerkrankung																	
enumeration	0357005	documentation keine koronare Bildgebung																	
source	<code><element name="PAA_BefundSchluessel" type="enum_0357"/></code>																		

element **PatientenaufnahmeAortenklappeBasis/PAA_RevaskularisationSchluessel**

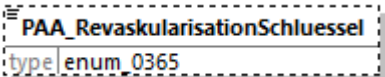
diagram													
type	enum 0365												
properties	minOcc 0 maxOcc 1 content simple												
facets	<table border="1"> <thead> <tr> <th>Kind</th> <th>Value</th> <th>Annotation</th> </tr> </thead> <tbody> <tr> <td>enumeration</td> <td>0365001</td> <td>documentation nein</td> </tr> <tr> <td>enumeration</td> <td>0365002</td> <td>documentation ja, operativ</td> </tr> <tr> <td>enumeration</td> <td>0365003</td> <td>documentation ja, interventionell</td> </tr> </tbody> </table>	Kind	Value	Annotation	enumeration	0365001	documentation nein	enumeration	0365002	documentation ja, operativ	enumeration	0365003	documentation ja, interventionell
Kind	Value	Annotation											
enumeration	0365001	documentation nein											
enumeration	0365002	documentation ja, operativ											
enumeration	0365003	documentation ja, interventionell											
source	<code><element name="PAA_RevaskularisationSchluessel" type="enum_0365" minOccurs="0"/></code>												

element **PatientenaufnahmeAortenklappeBasis/PAA_PciSchluessel**

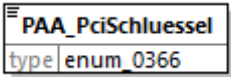
diagram													
type	enum 0366												
properties	content simple												
facets	<table border="1"> <thead> <tr> <th>Kind</th> <th>Value</th> <th>Annotation</th> </tr> </thead> <tbody> <tr> <td>enumeration</td> <td>0366001</td> <td>documentation nein</td> </tr> <tr> <td>enumeration</td> <td>0366002</td> <td>documentation ja, &lt;= 6 Stunden</td> </tr> <tr> <td>enumeration</td> <td>0366003</td> <td>documentation</td> </tr> </tbody> </table>	Kind	Value	Annotation	enumeration	0366001	documentation nein	enumeration	0366002	documentation ja, <= 6 Stunden	enumeration	0366003	documentation
Kind	Value	Annotation											
enumeration	0366001	documentation nein											
enumeration	0366002	documentation ja, <= 6 Stunden											
enumeration	0366003	documentation											

	enumeration 0366004	ja, > 6 Stunden bis <= 3 Monate documentation
	enumeration 0366099	ja, > 3 Monate documentation unbekannt
source	<code><element name="PAA_PciSchluessel" type="enum_0366"/></code>	

element **PatientenaufnahmeAortenklappeBasis/PAA_AnzahlVorOpSchluessel**

diagram			
type	enum 0358		
properties	content simple		
facets	Kind	Value	Annotation
	enumeration	0358001	documentation 0
	enumeration	0358002	documentation 1
	enumeration	0358003	documentation 2
	enumeration	0358004	documentation 3
	enumeration	0358005	documentation 4
	enumeration	0358006	documentation 5 oder mehr
	enumeration	0358098	documentation genaue Anzahl unbekannt (aber mind. 1)
	enumeration	0358099	documentation unbekannt
source	<code><element name="PAA_AnzahlVorOpSchluessel" type="enum_0358"/></code>		

element **PatientenaufnahmeAortenklappeBasis/PAA_AvkSchluessel**

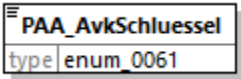
diagram			
type	enum 0061		
properties	content simple		
facets	Kind	Value	Annotation
	enumeration	0061001	documentation ja
	enumeration	0061002	documentation nein
	enumeration	0061099	documentation unbekannt
source	<code><element name="PAA_AvkSchluessel" type="enum_0061"/></code>		

element **PatientenaufnahmeAortenklappeBasis/PAA_PavkSchluessel**

diagram													
type	enum 0061												
properties	minOcc 0 maxOcc 1 content simple												
facets	<table border="1"> <thead> <tr> <th>Kind</th> <th>Value</th> <th>Annotation</th> </tr> </thead> <tbody> <tr> <td>enumeration</td> <td>0061001</td> <td>documentation ja</td> </tr> <tr> <td>enumeration</td> <td>0061002</td> <td>documentation nein</td> </tr> <tr> <td>enumeration</td> <td>0061099</td> <td>documentation unbekannt</td> </tr> </tbody> </table>	Kind	Value	Annotation	enumeration	0061001	documentation ja	enumeration	0061002	documentation nein	enumeration	0061099	documentation unbekannt
Kind	Value	Annotation											
enumeration	0061001	documentation ja											
enumeration	0061002	documentation nein											
enumeration	0061099	documentation unbekannt											
source	<code><element name="PAA_PavkSchluessel" type="enum_0061" minOccurs="0"/></code>												

element **PatientenaufnahmeAortenklappeBasis/PAA_ArteriaCarotisSchluessel**

diagram													
type	enum 0061												
properties	minOcc 0 maxOcc 1 content simple												
facets	<table border="1"> <thead> <tr> <th>Kind</th> <th>Value</th> <th>Annotation</th> </tr> </thead> <tbody> <tr> <td>enumeration</td> <td>0061001</td> <td>documentation ja</td> </tr> <tr> <td>enumeration</td> <td>0061002</td> <td>documentation nein</td> </tr> <tr> <td>enumeration</td> <td>0061099</td> <td>documentation unbekannt</td> </tr> </tbody> </table>	Kind	Value	Annotation	enumeration	0061001	documentation ja	enumeration	0061002	documentation nein	enumeration	0061099	documentation unbekannt
Kind	Value	Annotation											
enumeration	0061001	documentation ja											
enumeration	0061002	documentation nein											
enumeration	0061099	documentation unbekannt											
source	<code><element name="PAA_ArteriaCarotisSchluessel" type="enum_0061" minOccurs="0"/></code>												

element **PatientenaufnahmeAortenklappeBasis/PAA_AortenaneurysmaSchluessel**

diagram													
type	enum 0061												
properties	minOcc 0 maxOcc 1 content simple												
facets	<table border="1"> <thead> <tr> <th>Kind</th> <th>Value</th> <th>Annotation</th> </tr> </thead> <tbody> <tr> <td>enumeration</td> <td>0061001</td> <td>documentation ja</td> </tr> <tr> <td>enumeration</td> <td>0061002</td> <td>documentation nein</td> </tr> <tr> <td>enumeration</td> <td>0061099</td> <td>documentation unbekannt</td> </tr> </tbody> </table>	Kind	Value	Annotation	enumeration	0061001	documentation ja	enumeration	0061002	documentation nein	enumeration	0061099	documentation unbekannt
Kind	Value	Annotation											
enumeration	0061001	documentation ja											
enumeration	0061002	documentation nein											
enumeration	0061099	documentation unbekannt											
source	<code><element name="PAA_AortenaneurysmaSchluessel" type="enum_0061" minOccurs="0"/></code>												

element **PatientenaufnahmeAortenklappeBasis/PAA_SonstigeAvkSchluessel**

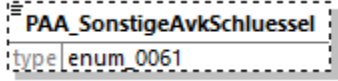
diagram													
type	enum 0061												
properties	minOcc 0 maxOcc 1 content simple												
facets	<table border="1"> <thead> <tr> <th>Kind</th> <th>Value</th> <th>Annotation</th> </tr> </thead> <tbody> <tr> <td>enumeration</td> <td>0061001</td> <td>documentation ja</td> </tr> <tr> <td>enumeration</td> <td>0061002</td> <td>documentation nein</td> </tr> <tr> <td>enumeration</td> <td>0061099</td> <td>documentation unbekannt</td> </tr> </tbody> </table>	Kind	Value	Annotation	enumeration	0061001	documentation ja	enumeration	0061002	documentation nein	enumeration	0061099	documentation unbekannt
Kind	Value	Annotation											
enumeration	0061001	documentation ja											
enumeration	0061002	documentation nein											
enumeration	0061099	documentation unbekannt											
source	<code><element name="PAA_SonstigeAvkSchluessel" type="enum_0061" minOccurs="0"/></code>												

element **PatientenaufnahmeAortenklappeBasis/PAA_LungenerkrankungSchluessel**

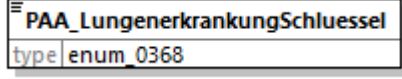
diagram																			
type	enum 0368																		
properties	content simple																		
facets	<table border="1"> <thead> <tr> <th>Kind</th> <th>Value</th> <th>Annotation</th> </tr> </thead> <tbody> <tr> <td>enumeration</td> <td>0368001</td> <td>documentation nein</td> </tr> <tr> <td>enumeration</td> <td>0368002</td> <td>documentation ja, COPD mit Dauermedikation</td> </tr> <tr> <td>enumeration</td> <td>0368003</td> <td>documentation ja, COPD ohne Dauermedikation</td> </tr> <tr> <td>enumeration</td> <td>0368004</td> <td>documentation ja, andere Lungenerkrankungen</td> </tr> <tr> <td>enumeration</td> <td>0368099</td> <td>documentation unbekannt</td> </tr> </tbody> </table>	Kind	Value	Annotation	enumeration	0368001	documentation nein	enumeration	0368002	documentation ja, COPD mit Dauermedikation	enumeration	0368003	documentation ja, COPD ohne Dauermedikation	enumeration	0368004	documentation ja, andere Lungenerkrankungen	enumeration	0368099	documentation unbekannt
Kind	Value	Annotation																	
enumeration	0368001	documentation nein																	
enumeration	0368002	documentation ja, COPD mit Dauermedikation																	
enumeration	0368003	documentation ja, COPD ohne Dauermedikation																	
enumeration	0368004	documentation ja, andere Lungenerkrankungen																	
enumeration	0368099	documentation unbekannt																	
source	<code><element name="PAA_LungenerkrankungSchluessel" type="enum_0368"/></code>																		

element **PatientenaufnahmeAortenklappeBasis/PAA_Akoef**

diagram																
type	Zahl1_1															
properties	content simple															
facets	<table border="1"> <thead> <tr> <th>Kind</th> <th>Value</th> <th>Annotation</th> </tr> </thead> <tbody> <tr> <td>minInclusive</td> <td>0.1</td> <td></td> </tr> <tr> <td>maxInclusive</td> <td>9.9</td> <td></td> </tr> <tr> <td>totalDigits</td> <td>2</td> <td></td> </tr> <tr> <td>fractionDigits</td> <td>1</td> <td></td> </tr> </tbody> </table>	Kind	Value	Annotation	minInclusive	0.1		maxInclusive	9.9		totalDigits	2		fractionDigits	1	
Kind	Value	Annotation														
minInclusive	0.1															
maxInclusive	9.9															
totalDigits	2															
fractionDigits	1															

source	<code><element name="PAA_Akoef" type="Zahl1_1"/></code>
--------	---

element **PatientenaufnahmeAortenklappeBasis/PAA_AkoefUnbekannt**

diagram							
type	JaLeer						
properties	content simple						
facets	<table border="1"> <thead> <tr> <th>Kind</th> <th>Value</th> <th>Annotation</th> </tr> </thead> <tbody> <tr> <td>pattern</td> <td>(1)</td> <td></td> </tr> </tbody> </table>	Kind	Value	Annotation	pattern	(1)	
Kind	Value	Annotation					
pattern	(1)						
source	<code><element name="PAA_AkoefUnbekannt" type="JaLeer"/></code>						

element **PatientenaufnahmeAortenklappeBasis/PAA_AkoefMethodeSchluessel**

diagram													
type	enum_0370												
properties	<table border="1"> <tr> <td>minOcc</td> <td>0</td> </tr> <tr> <td>maxOcc</td> <td>1</td> </tr> <tr> <td>content</td> <td>simple</td> </tr> </table>	minOcc	0	maxOcc	1	content	simple						
minOcc	0												
maxOcc	1												
content	simple												
facets	<table border="1"> <thead> <tr> <th>Kind</th> <th>Value</th> <th>Annotation</th> </tr> </thead> <tbody> <tr> <td>enumeration</td> <td>0370001</td> <td>documentation Echokardiographie</td> </tr> <tr> <td>enumeration</td> <td>0370002</td> <td>documentation Herzkatheter</td> </tr> <tr> <td>enumeration</td> <td>0370042</td> <td>documentation andere</td> </tr> </tbody> </table>	Kind	Value	Annotation	enumeration	0370001	documentation Echokardiographie	enumeration	0370002	documentation Herzkatheter	enumeration	0370042	documentation andere
Kind	Value	Annotation											
enumeration	0370001	documentation Echokardiographie											
enumeration	0370002	documentation Herzkatheter											
enumeration	0370042	documentation andere											
source	<code><element name="PAA_AkoefMethodeSchluessel" type="enum_0370" minOccurs="0"/></code>												

element **PatientenaufnahmeAortenklappeBasis/PAA_DeltaPmax**

diagram										
type	Zahl3									
properties	content simple									
facets	<table border="1"> <thead> <tr> <th>Kind</th> <th>Value</th> <th>Annotation</th> </tr> </thead> <tbody> <tr> <td>minInclusive</td> <td>1</td> <td></td> </tr> <tr> <td>maxInclusive</td> <td>999</td> <td></td> </tr> </tbody> </table>	Kind	Value	Annotation	minInclusive	1		maxInclusive	999	
Kind	Value	Annotation								
minInclusive	1									
maxInclusive	999									
source	<code><element name="PAA_DeltaPmax" type="Zahl3"/></code>									

element **PatientenaufnahmeAortenklappeBasis/PAA_DeltaPmaxUnbekannt**

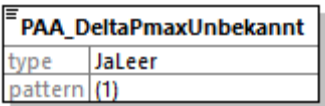
diagram							
type	JaLeer						
properties	content simple						
facets	<table border="1"> <thead> <tr> <th>Kind</th> <th>Value</th> <th>Annotation</th> </tr> </thead> <tbody> <tr> <td>pattern</td> <td>(1)</td> <td></td> </tr> </tbody> </table>	Kind	Value	Annotation	pattern	(1)	
Kind	Value	Annotation					
pattern	(1)						
source	<code><element name="PAA_DeltaPmaxUnbekannt" type="JaLeer"/></code>						

element **PatientenaufnahmeAortenklappeBasis/PAA_DeltaPmean**

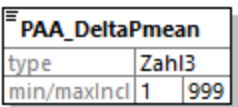
diagram										
type	Zahl3									
properties	content simple									
facets	<table border="1"> <thead> <tr> <th>Kind</th> <th>Value</th> <th>Annotation</th> </tr> </thead> <tbody> <tr> <td>minInclusive</td> <td>1</td> <td></td> </tr> <tr> <td>maxInclusive</td> <td>999</td> <td></td> </tr> </tbody> </table>	Kind	Value	Annotation	minInclusive	1		maxInclusive	999	
Kind	Value	Annotation								
minInclusive	1									
maxInclusive	999									
source	<code><element name="PAA_DeltaPmean" type="Zahl3"/></code>									

element **PatientenaufnahmeAortenklappeBasis/PAA_DeltaPmeanUnbekannt**

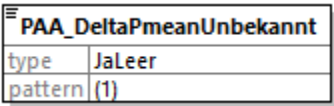
diagram							
type	JaLeer						
properties	content simple						
facets	<table border="1"> <thead> <tr> <th>Kind</th> <th>Value</th> <th>Annotation</th> </tr> </thead> <tbody> <tr> <td>pattern</td> <td>(1)</td> <td></td> </tr> </tbody> </table>	Kind	Value	Annotation	pattern	(1)	
Kind	Value	Annotation					
pattern	(1)						
source	<code><element name="PAA_DeltaPmeanUnbekannt" type="JaLeer"/></code>						

element **PatientenaufnahmeAortenklappeBasis/PAA_DeltaP**

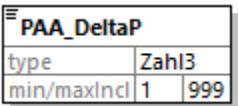
diagram										
type	Zahl3									
properties	content simple									
facets	<table border="1"> <thead> <tr> <th>Kind</th> <th>Value</th> <th>Annotation</th> </tr> </thead> <tbody> <tr> <td>minInclusive</td> <td>1</td> <td></td> </tr> <tr> <td>maxInclusive</td> <td>999</td> <td></td> </tr> </tbody> </table>	Kind	Value	Annotation	minInclusive	1		maxInclusive	999	
Kind	Value	Annotation								
minInclusive	1									
maxInclusive	999									

source	<code><element name="PAA_DeltaP" type="Zahl3"/></code>
--------	--

element **PatientenaufnahmeAortenklappeBasis/PAA_DeltaPUnbekannt**

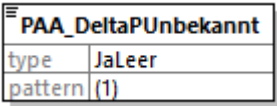
diagram							
type	JaLeer						
properties	content simple						
facets	<table border="1"> <thead> <tr> <th>Kind</th> <th>Value</th> <th>Annotation</th> </tr> </thead> <tbody> <tr> <td>pattern</td> <td>(1)</td> <td></td> </tr> </tbody> </table>	Kind	Value	Annotation	pattern	(1)	
Kind	Value	Annotation					
pattern	(1)						
source	<code><element name="PAA_DeltaPUnbekannt" type="JaLeer"/></code>						

element **PatientenaufnahmeAortenklappeBasis/PAA_VerkalkungsgradSchluessel**

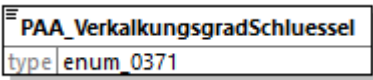
diagram																			
type	enum 0371																		
properties	content simple																		
facets	<table border="1"> <thead> <tr> <th>Kind</th> <th>Value</th> <th>Annotation</th> </tr> </thead> <tbody> <tr> <td>enumeration</td> <td>0371001</td> <td>documentation keine</td> </tr> <tr> <td>enumeration</td> <td>0371002</td> <td>documentation leicht</td> </tr> <tr> <td>enumeration</td> <td>0371003</td> <td>documentation mittel</td> </tr> <tr> <td>enumeration</td> <td>0371004</td> <td>documentation schwer</td> </tr> <tr> <td>enumeration</td> <td>0371099</td> <td>documentation unbekannt</td> </tr> </tbody> </table>	Kind	Value	Annotation	enumeration	0371001	documentation keine	enumeration	0371002	documentation leicht	enumeration	0371003	documentation mittel	enumeration	0371004	documentation schwer	enumeration	0371099	documentation unbekannt
Kind	Value	Annotation																	
enumeration	0371001	documentation keine																	
enumeration	0371002	documentation leicht																	
enumeration	0371003	documentation mittel																	
enumeration	0371004	documentation schwer																	
enumeration	0371099	documentation unbekannt																	
source	<code><element name="PAA_VerkalkungsgradSchluessel" type="enum_0371"/></code>																		

element **PatientenaufnahmeAortenklappeBasis/PAA_CtCalcium**

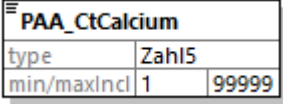
diagram										
type	Zahl5									
properties	content simple									
facets	<table border="1"> <thead> <tr> <th>Kind</th> <th>Value</th> <th>Annotation</th> </tr> </thead> <tbody> <tr> <td>minInclusive</td> <td>1</td> <td></td> </tr> <tr> <td>maxInclusive</td> <td>99999</td> <td></td> </tr> </tbody> </table>	Kind	Value	Annotation	minInclusive	1		maxInclusive	99999	
Kind	Value	Annotation								
minInclusive	1									
maxInclusive	99999									
source	<code><element name="PAA_CtCalcium" type="Zahl5"/></code>									

element **PatientenaufnahmeAortenklappeBasis/PAA_CtCalciumUnbekannt**

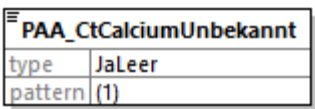
diagram							
type	JaLeer						
properties	content simple						
facets	<table border="1"> <thead> <tr> <th>Kind</th> <th>Value</th> <th>Annotation</th> </tr> </thead> <tbody> <tr> <td>pattern</td> <td>(1)</td> <td></td> </tr> </tbody> </table>	Kind	Value	Annotation	pattern	(1)	
Kind	Value	Annotation					
pattern	(1)						
source	<code><element name="PAA_CtCalciumUnbekannt" type="JaLeer"/></code>						

element **PatientenaufnahmeAortenklappeBasis/PAA_LvotSchluessel**

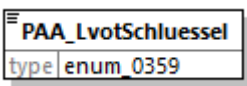
diagram																
type	enum_0359															
properties	content simple															
facets	<table border="1"> <thead> <tr> <th>Kind</th> <th>Value</th> <th>Annotation</th> </tr> </thead> <tbody> <tr> <td>enumeration</td> <td>0359001</td> <td>documentation nein</td> </tr> <tr> <td>enumeration</td> <td>0359002</td> <td>documentation ja - einseitig</td> </tr> <tr> <td>enumeration</td> <td>0359003</td> <td>documentation ja - beidseitig</td> </tr> <tr> <td>enumeration</td> <td>0359042</td> <td>documentation unbekannt</td> </tr> </tbody> </table>	Kind	Value	Annotation	enumeration	0359001	documentation nein	enumeration	0359002	documentation ja - einseitig	enumeration	0359003	documentation ja - beidseitig	enumeration	0359042	documentation unbekannt
Kind	Value	Annotation														
enumeration	0359001	documentation nein														
enumeration	0359002	documentation ja - einseitig														
enumeration	0359003	documentation ja - beidseitig														
enumeration	0359042	documentation unbekannt														
source	<code><element name="PAA_LvotSchluessel" type="enum_0359"/></code>															

element **PatientenaufnahmeAortenklappeBasis/PAA_BiUnicuspideKlappeSchluessel**

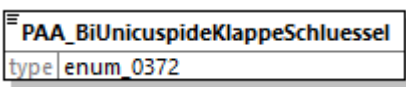
diagram																
type	enum_0372															
properties	content simple															
facets	<table border="1"> <thead> <tr> <th>Kind</th> <th>Value</th> <th>Annotation</th> </tr> </thead> <tbody> <tr> <td>enumeration</td> <td>0372001</td> <td>documentation nein</td> </tr> <tr> <td>enumeration</td> <td>0372002</td> <td>documentation ja, bicuspide</td> </tr> <tr> <td>enumeration</td> <td>0372003</td> <td>documentation ja, unicuspide</td> </tr> <tr> <td>enumeration</td> <td>0372099</td> <td>documentation unbekannt</td> </tr> </tbody> </table>	Kind	Value	Annotation	enumeration	0372001	documentation nein	enumeration	0372002	documentation ja, bicuspide	enumeration	0372003	documentation ja, unicuspide	enumeration	0372099	documentation unbekannt
Kind	Value	Annotation														
enumeration	0372001	documentation nein														
enumeration	0372002	documentation ja, bicuspide														
enumeration	0372003	documentation ja, unicuspide														
enumeration	0372099	documentation unbekannt														
source	<code><element name="PAA_BiUnicuspideKlappeSchluessel" type="enum_0372"/></code>															

element **PatientenaufnahmeAortenklappeBasis/PAA_AortenstenoseSchluessel**

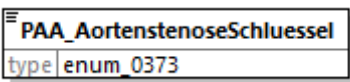
diagram			
type	enum 0373		
properties	content simple		
facets	Kind	Value	Annotation
	enumeration	0373001	documentation keine
	enumeration	0373002	documentation leichtgradig
	enumeration	0373003	documentation mittelgradig
	enumeration	0373004	documentation hochgradig
	enumeration	0373099	documentation unbekannt
source	<code><element name="PAA_AortenstenoseSchluessel" type="enum_0373"/></code>		

element **PatientenaufnahmeAortenklappeBasis/PAA_AorteninsuffizienzSchluessel**

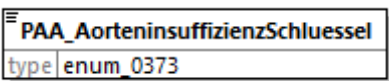
diagram			
type	enum 0373		
properties	content simple		
facets	Kind	Value	Annotation
	enumeration	0373001	documentation keine
	enumeration	0373002	documentation leichtgradig
	enumeration	0373003	documentation mittelgradig
	enumeration	0373004	documentation hochgradig
	enumeration	0373099	documentation unbekannt
source	<code><element name="PAA_AorteninsuffizienzSchluessel" type="enum_0373"/></code>		

element **PatientenaufnahmeAortenklappeBasis/PAA_MitralinsuffizienzSchluessel**

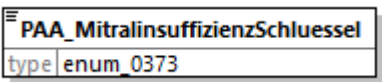
diagram			
type	enum 0373		
properties	content simple		
facets	Kind	Value	Annotation
	enumeration	0373001	documentation keine
	enumeration	0373002	documentation leichtgradig
	enumeration	0373003	documentation mittelgradig

	enumeration 0373004 documentation hochgradig
	enumeration 0373099 documentation unbekannt
source	<code><element name="PAA_MitralinsuffizienzSchluessel" type="enum_0373"/></code>

element **PatientenaufnahmeAortenklappeBasis/PAA_TrikuspidalinsuffizienzSchluessel**

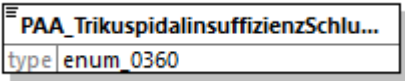
diagram			
type	enum 0360		
properties	content simple		
facets	Kind	Value	Annotation
	enumeration	0360001	documentation keine
	enumeration	0360002	documentation leichtgradig
	enumeration	0360003	documentation mittelgradig
	enumeration	0360004	documentation hochgradig
	enumeration	0360005	documentation massive
	enumeration	0360006	documentation torrential
	enumeration	0360099	documentation unbekannt
source	<code><element name="PAA_TrikuspidalinsuffizienzSchluessel" type="enum_0360"/></code>		

element **PatientenaufnahmeAortenklappeBasis/PAA_ValvuloplastieSchluessel**

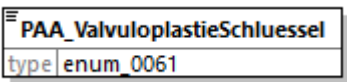
diagram			
type	enum 0061		
properties	content simple		
facets	Kind	Value	Annotation
	enumeration	0061001	documentation ja
	enumeration	0061002	documentation nein
	enumeration	0061099	documentation unbekannt
source	<code><element name="PAA_ValvuloplastieSchluessel" type="enum_0061"/></code>		

element **PatientenaufnahmeAortenklappeBasis/PAA_StsScore**

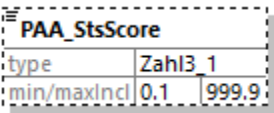
diagram			
---------	---	--	--

type	Zahl3_1															
properties	minOcc 0 maxOcc 1 content simple															
facets	<table border="1"> <thead> <tr> <th>Kind</th> <th>Value</th> <th>Annotation</th> </tr> </thead> <tbody> <tr> <td>minInclusive</td> <td>0.1</td> <td></td> </tr> <tr> <td>maxInclusive</td> <td>999.9</td> <td></td> </tr> <tr> <td>totalDigits</td> <td>4</td> <td></td> </tr> <tr> <td>fractionDigits</td> <td>1</td> <td></td> </tr> </tbody> </table>	Kind	Value	Annotation	minInclusive	0.1		maxInclusive	999.9		totalDigits	4		fractionDigits	1	
Kind	Value	Annotation														
minInclusive	0.1															
maxInclusive	999.9															
totalDigits	4															
fractionDigits	1															
source	<code><element name="PAA_StsScore" type="Zahl3_1" minOccurs="0"/></code>															

element **PatientenaufnahmeAortenklappeBasis/PAA_HypertonusSchluessel**

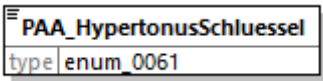
diagram													
type	enum 0061												
properties	content simple												
facets	<table border="1"> <thead> <tr> <th>Kind</th> <th>Value</th> <th>Annotation</th> </tr> </thead> <tbody> <tr> <td>enumeration</td> <td>0061001</td> <td>documentation ja</td> </tr> <tr> <td>enumeration</td> <td>0061002</td> <td>documentation nein</td> </tr> <tr> <td>enumeration</td> <td>0061099</td> <td>documentation unbekannt</td> </tr> </tbody> </table>	Kind	Value	Annotation	enumeration	0061001	documentation ja	enumeration	0061002	documentation nein	enumeration	0061099	documentation unbekannt
Kind	Value	Annotation											
enumeration	0061001	documentation ja											
enumeration	0061002	documentation nein											
enumeration	0061099	documentation unbekannt											
source	<code><element name="PAA_HypertonusSchluessel" type="enum_0061"/></code>												

element **PatientenaufnahmeAortenklappeBasis/PAA_MyokardinfarktSchluessel**

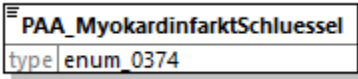
diagram																									
type	enum 0374																								
properties	content simple																								
facets	<table border="1"> <thead> <tr> <th>Kind</th> <th>Value</th> <th>Annotation</th> </tr> </thead> <tbody> <tr> <td>enumeration</td> <td>0374001</td> <td>documentation nein</td> </tr> <tr> <td>enumeration</td> <td>0374002</td> <td>documentation ja, &lt;= 6 Stunden</td> </tr> <tr> <td>enumeration</td> <td>0374003</td> <td>documentation ja, &gt; 6 Stunden bis &lt;= 24 Stunden</td> </tr> <tr> <td>enumeration</td> <td>0374004</td> <td>documentation ja, &gt; 1 bis 7 Tage</td> </tr> <tr> <td>enumeration</td> <td>0374005</td> <td>documentation ja, &gt; 7 bis 21 Tage</td> </tr> <tr> <td>enumeration</td> <td>0374006</td> <td>documentation ja, &gt; 21 Tage</td> </tr> <tr> <td>enumeration</td> <td>0374099</td> <td>documentation unbekannt</td> </tr> </tbody> </table>	Kind	Value	Annotation	enumeration	0374001	documentation nein	enumeration	0374002	documentation ja, <= 6 Stunden	enumeration	0374003	documentation ja, > 6 Stunden bis <= 24 Stunden	enumeration	0374004	documentation ja, > 1 bis 7 Tage	enumeration	0374005	documentation ja, > 7 bis 21 Tage	enumeration	0374006	documentation ja, > 21 Tage	enumeration	0374099	documentation unbekannt
Kind	Value	Annotation																							
enumeration	0374001	documentation nein																							
enumeration	0374002	documentation ja, <= 6 Stunden																							
enumeration	0374003	documentation ja, > 6 Stunden bis <= 24 Stunden																							
enumeration	0374004	documentation ja, > 1 bis 7 Tage																							
enumeration	0374005	documentation ja, > 7 bis 21 Tage																							
enumeration	0374006	documentation ja, > 21 Tage																							
enumeration	0374099	documentation unbekannt																							
source	<code><element name="PAA_MyokardinfarktSchluessel" type="enum_0374"/></code>																								

element **PatientenaufnahmeAortenklappeBasis/PAA_SymptomeSchluessel**

diagram			
type	enum 0375		
properties	content simple		
facets	Kind	Value	Annotation
	enumeration	0375001	documentation keine Symptome oder Angina
	enumeration	0375002	documentation Symptome, aber keine Ischämiezeichen
	enumeration	0375003	documentation stabile Angina
	enumeration	0375004	documentation instabile Angina
	enumeration	0375005	documentation Infarkt ohne ST-Hebung (Non-STEMI)
	enumeration	0375006	documentation Infarkt mit ST-Hebung (STEMI)
	enumeration	0375042	documentation unbekannt
source	<pre><element name="PAA_SymptomeSchluessel" type="enum_0375"/></pre>		

complexType **InfektionAortenklappeBasis**

diagram			
namespace	http://xml.ir-d.de/emg		
children	IAK_InfektionSchluessel		
used by	element	PatientenaufnahmeAortenklappe/infektionAortenklappe	
source	<pre><complexType name="InfektionAortenklappeBasis"> <sequence> <element name="IAK_InfektionSchluessel" type="enum_0367"/> </sequence> </complexType></pre>		

element **InfektionAortenklappeBasis/IAK_InfektionSchluessel**

diagram			
type	enum 0367		
properties	content simple		
facets	Kind	Value	Annotation
	enumeration	0367001	documentation keine
	enumeration	0367002	documentation Mediastinitis
	enumeration	0367003	documentation Sepsis
	enumeration	0367004	documentation

	enumeration	0367005	broncho-pulmonale Infektion documentation
	enumeration	0367006	oto-laryngologische Infektion documentation
	enumeration	0367007	floride Endokarditis documentation
	enumeration	0367008	Peritonitis documentation
	enumeration	0367009	Wundinfektion Thorax documentation
	enumeration	0367010	Pleuraempyem documentation
	enumeration	0367011	Venenkatheterinfektion documentation
	enumeration	0367012	Hamwegsinfektion documentation
	enumeration	0367013	Wundinfektion untere Extremitäten documentation
	enumeration	0367014	HIV-Infektion documentation
	enumeration	0367015	Hepatitis B oder C documentation
	enumeration	0367042	andere Wundinfektion documentation
			sonstige
source	<code><element name="IAK_InfektionSchluessel" type="enum_0367"/></code>		

complexType **ArtikelbeschreibungBasis**

<p>diagram</p>	
<p>namespace</p>	<p>http://xml.ir-d.de/emg</p>
<p>children</p>	<p>ARB LotNumber ARB LotNumberUnbekannt ARB SerienNumber ARB SerienNumberUnbekannt ARB DatumVerfall ARB DatumVerfallUnbekannt ARB Artikelbezeichnung ARB Barcode ARB DatumImplantierungExplantat ARB DatumImplantierungExplantatUnbekannt</p>
<p>used by</p>	<p>complexType Artikelbeschreibung</p>
<p>source</p>	<pre><complexType name="ArtikelbeschreibungBasis"> <sequence> <choice minOccurs="0"> <element name="ARB_LotNumber" type="String20"/> <element name="ARB_LotNumberUnbekannt" type="JaLeer"/> </choice> <choice minOccurs="0"> <element name="ARB_SerienNumber" type="String20"/> <element name="ARB_SerienNumberUnbekannt" type="JaLeer"/> </choice> <choice minOccurs="0"></pre>

	<pre> <element name="ARB_DatumVerfall" type="String20"/> <element name="ARB_DatumVerfallUnbekannt" type="JaLeer"/> </choice> <element name="ARB_Artikelbezeichnung" type="Freitext250" minOccurs="0"/> <element name="ARB_Barcode" type="Freitext250" minOccurs="0"/> <choice minOccurs="0"> <element name="ARB_DatumImplantierungExplantat" type="DatumText"/> <element name="ARB_DatumImplantierungExplantatUnbekannt" type="JaLeer"/> </choice> </sequence> </complexType> </pre>
--	--

element **ArtikelbeschreibungBasis/ARB_LotNummer**

diagram							
type	String20						
properties	content simple						
facets	<table border="1"> <thead> <tr> <th>Kind</th> <th>Value</th> <th>Annotation</th> </tr> </thead> <tbody> <tr> <td>maxLength</td> <td>20</td> <td></td> </tr> </tbody> </table>	Kind	Value	Annotation	maxLength	20	
Kind	Value	Annotation					
maxLength	20						
source	<code><element name="ARB_LotNummer" type="String20"/></code>						

element **ArtikelbeschreibungBasis/ARB_LotNummerUnbekannt**

diagram							
type	JaLeer						
properties	content simple						
facets	<table border="1"> <thead> <tr> <th>Kind</th> <th>Value</th> <th>Annotation</th> </tr> </thead> <tbody> <tr> <td>pattern</td> <td>(1)</td> <td></td> </tr> </tbody> </table>	Kind	Value	Annotation	pattern	(1)	
Kind	Value	Annotation					
pattern	(1)						
source	<code><element name="ARB_LotNummerUnbekannt" type="JaLeer"/></code>						

element **ArtikelbeschreibungBasis/ARB_Seriennummer**

diagram							
type	String20						
properties	content simple						
facets	<table border="1"> <thead> <tr> <th>Kind</th> <th>Value</th> <th>Annotation</th> </tr> </thead> <tbody> <tr> <td>maxLength</td> <td>20</td> <td></td> </tr> </tbody> </table>	Kind	Value	Annotation	maxLength	20	
Kind	Value	Annotation					
maxLength	20						
source	<code><element name="ARB_Seriennummer" type="String20"/></code>						

element **ArtikelbeschreibungBasis/ARB_SerienNummerUnbekannt**

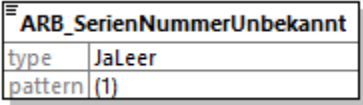
diagram	
type	JaLeer
properties	content simple
facets	Kind Value Annotation pattern (1)
source	<code><element name="ARB_SerienNummerUnbekannt" type="JaLeer"/></code>

element **ArtikelbeschreibungBasis/ARB_DatumVerfall**

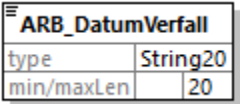
diagram	
type	String20
properties	content simple
facets	Kind Value Annotation maxLength 20
source	<code><element name="ARB_DatumVerfall" type="String20"/></code>

element **ArtikelbeschreibungBasis/ARB_DatumVerfallUnbekannt**

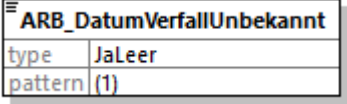
diagram	
type	JaLeer
properties	content simple
facets	Kind Value Annotation pattern (1)
source	<code><element name="ARB_DatumVerfallUnbekannt" type="JaLeer"/></code>

element **ArtikelbeschreibungBasis/ARB_Artikelbezeichnung**

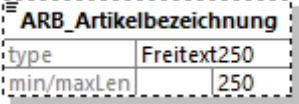
diagram	
type	Freitext250
properties	minOcc 0 maxOcc 1 content simple
facets	Kind Value Annotation maxLength 250

source	<code><element name="ARB_Artikelbezeichnung" type="Freitext250" minOccurs="0"/></code>
--------	--

element **ArtikelbeschreibungBasis/ARB_Barcode**

diagram							
type	Freitext250						
properties	minOcc 0 maxOcc 1 content simple						
facets	<table border="1"> <thead> <tr> <th>Kind</th> <th>Value</th> <th>Annotation</th> </tr> </thead> <tbody> <tr> <td>maxLength</td> <td>250</td> <td></td> </tr> </tbody> </table>	Kind	Value	Annotation	maxLength	250	
Kind	Value	Annotation					
maxLength	250						
source	<code><element name="ARB_Barcode" type="Freitext250" minOccurs="0"/></code>						

element **ArtikelbeschreibungBasis/ARB_DatumImplantierungExplantat**

diagram							
type	DatumText						
properties	content simple						
facets	<table border="1"> <thead> <tr> <th>Kind</th> <th>Value</th> <th>Annotation</th> </tr> </thead> <tbody> <tr> <td>pattern</td> <td>((([0-9]{4})([0-9]{2})?)([0-9]{2})?)</td> <td></td> </tr> </tbody> </table>	Kind	Value	Annotation	pattern	((([0-9]{4})([0-9]{2})?)([0-9]{2})?)	
Kind	Value	Annotation					
pattern	((([0-9]{4})([0-9]{2})?)([0-9]{2})?)						
source	<code><element name="ARB_DatumImplantierungExplantat" type="DatumText"/></code>						

element **ArtikelbeschreibungBasis/ARB_DatumImplantierungExplantatUnbekannt**

diagram							
type	JaLeer						
properties	content simple						
facets	<table border="1"> <thead> <tr> <th>Kind</th> <th>Value</th> <th>Annotation</th> </tr> </thead> <tbody> <tr> <td>pattern</td> <td>(1)</td> <td></td> </tr> </tbody> </table>	Kind	Value	Annotation	pattern	(1)	
Kind	Value	Annotation					
pattern	(1)						
source	<code><element name="ARB_DatumImplantierungExplantatUnbekannt" type="JaLeer"/></code>						

complexType **ArtikelBrustimplantatBasis**

<p>diagram</p>	
<p>namespace</p>	<p>http://xml.ir-d.de/emg</p>
<p>children</p>	<p>ABI_HerstellerSchluessel ABI_HerstellerUnbekannt ABI_HerstellerSonstiger ABI_ArtikelTypSchluessel ABI_FormSchluessel ABI_FormUnbekannt ABI_OberflaecheSchluessel ABI_OberflaecheUnbekannt ABI_FuellungSchluessel ABI_FuellungUnbekannt ABI_Volumen ABI_VolumenUnbekannt ABI_IntraoperativesVolumen</p>
<p>used by</p>	<p>element Artikelbeschreibung/artikelBrustimplantat</p>
<p>source</p>	<pre><complexType name="ArtikelBrustimplantatBasis"> <sequence></pre>

```

<choice>
  <element name="ABI_HerstellerSchluessel" type="String7"/>
  <element name="ABI_HerstellerUnbekannt" type="JaLeer"/>
</choice>
<element name="ABI_HerstellerSonstiger" type="Freitext250"
minOccurs="0"/>
<element name="ABI_ArtikelTypSchluessel" type="enum_0190"/>
<choice>
  <element name="ABI_FormSchluessel" type="enum_0126"/>
  <element name="ABI_FormUnbekannt" type="JaLeer"/>
</choice>
<choice>
  <element name="ABI_OberflaecheSchluessel" type="enum_0128"/>
  <element name="ABI_OberflaecheUnbekannt" type="JaLeer"/>
</choice>
<choice>
  <element name="ABI_FuellungSchluessel" type="enum_0124"/>
  <element name="ABI_FuellungUnbekannt" type="JaLeer"/>
</choice>
<choice>
  <element name="ABI_Volumen" type="Zahl5"/>
  <element name="ABI_VolumenUnbekannt" type="JaLeer"/>
</choice>
<element name="ABI_IntraoperativesVolumen" type="Zahl5mitNull"
minOccurs="0"/>
</sequence>
</complexType>

```

element ArtikelBrustimplantatBasis/ABI_HerstellerSchluessel

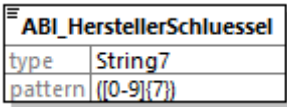
diagram							
type	String7						
properties	content simple						
facets	<table border="1"> <thead> <tr> <th>Kind</th> <th>Value</th> <th>Annotation</th> </tr> </thead> <tbody> <tr> <td>pattern</td> <td>([0-9]{7})</td> <td></td> </tr> </tbody> </table>	Kind	Value	Annotation	pattern	([0-9]{7})	
Kind	Value	Annotation					
pattern	([0-9]{7})						
source	<code><element name="ABI_HerstellerSchluessel" type="String7"/></code>						

element ArtikelBrustimplantatBasis/ABI_HerstellerUnbekannt

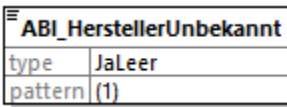
diagram							
type	JaLeer						
properties	content simple						
facets	<table border="1"> <thead> <tr> <th>Kind</th> <th>Value</th> <th>Annotation</th> </tr> </thead> <tbody> <tr> <td>pattern</td> <td>(1)</td> <td></td> </tr> </tbody> </table>	Kind	Value	Annotation	pattern	(1)	
Kind	Value	Annotation					
pattern	(1)						
source	<code><element name="ABI_HerstellerUnbekannt" type="JaLeer"/></code>						

element **ArtikelBrustimplantatBasis/ABI_HerstellerSonstiger**

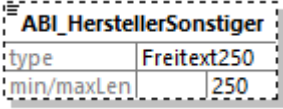
diagram							
type	Freitext250						
properties	minOcc 0 maxOcc 1 content simple						
facets	<table border="1"> <thead> <tr> <th>Kind</th> <th>Value</th> <th>Annotation</th> </tr> </thead> <tbody> <tr> <td>maxLength</td> <td>250</td> <td></td> </tr> </tbody> </table>	Kind	Value	Annotation	maxLength	250	
Kind	Value	Annotation					
maxLength	250						
source	<code><element name="ABI_HerstellerSonstiger" type="Freitext250" minOccurs="0"/></code>						

element **ArtikelBrustimplantatBasis/ABI_ArtikelTypSchluessel**

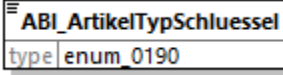
diagram										
type	enum_0190									
properties	content simple									
facets	<table border="1"> <thead> <tr> <th>Kind</th> <th>Value</th> <th>Annotation</th> </tr> </thead> <tbody> <tr> <td>enumeration</td> <td>0190001</td> <td>documentation Brustimplantat</td> </tr> <tr> <td>enumeration</td> <td>0190003</td> <td>documentation Brustexpander</td> </tr> </tbody> </table>	Kind	Value	Annotation	enumeration	0190001	documentation Brustimplantat	enumeration	0190003	documentation Brustexpander
Kind	Value	Annotation								
enumeration	0190001	documentation Brustimplantat								
enumeration	0190003	documentation Brustexpander								
source	<code><element name="ABI_ArtikelTypSchluessel" type="enum_0190"/></code>									

element **ArtikelBrustimplantatBasis/ABI_FomSchluessel**

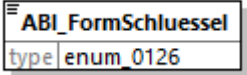
diagram													
type	enum_0126												
properties	content simple												
facets	<table border="1"> <thead> <tr> <th>Kind</th> <th>Value</th> <th>Annotation</th> </tr> </thead> <tbody> <tr> <td>enumeration</td> <td>0126001</td> <td>documentation anatomisch (tropfenförmig)</td> </tr> <tr> <td>enumeration</td> <td>0126002</td> <td>documentation rund (punktsymmetrisch)</td> </tr> <tr> <td>enumeration</td> <td>0126042</td> <td>documentation sonstige</td> </tr> </tbody> </table>	Kind	Value	Annotation	enumeration	0126001	documentation anatomisch (tropfenförmig)	enumeration	0126002	documentation rund (punktsymmetrisch)	enumeration	0126042	documentation sonstige
Kind	Value	Annotation											
enumeration	0126001	documentation anatomisch (tropfenförmig)											
enumeration	0126002	documentation rund (punktsymmetrisch)											
enumeration	0126042	documentation sonstige											
source	<code><element name="ABI_FomSchluessel" type="enum_0126"/></code>												

element **ArtikelBrustimplantatBasis/ABI_FomUnbekannt**

diagram	
---------	---

type	JaLeer						
properties	content simple						
facets	<table border="1"> <thead> <tr> <th>Kind</th> <th>Value</th> <th>Annotation</th> </tr> </thead> <tbody> <tr> <td>pattern</td> <td>(1)</td> <td></td> </tr> </tbody> </table>	Kind	Value	Annotation	pattern	(1)	
Kind	Value	Annotation					
pattern	(1)						
source	<code><element name="ABI_FormUnbekannt" type="JaLeer"/></code>						

element ArtikelBrustimplantatBasis/ABI_OberflaecheSchluessel

diagram													
type	enum 0128												
properties	content simple												
facets	<table border="1"> <thead> <tr> <th>Kind</th> <th>Value</th> <th>Annotation</th> </tr> </thead> <tbody> <tr> <td>enumeration</td> <td>0128001</td> <td>documentation glattwandig</td> </tr> <tr> <td>enumeration</td> <td>0128002</td> <td>documentation beschichtet</td> </tr> <tr> <td>enumeration</td> <td>0128003</td> <td>documentation texturiert</td> </tr> </tbody> </table>	Kind	Value	Annotation	enumeration	0128001	documentation glattwandig	enumeration	0128002	documentation beschichtet	enumeration	0128003	documentation texturiert
Kind	Value	Annotation											
enumeration	0128001	documentation glattwandig											
enumeration	0128002	documentation beschichtet											
enumeration	0128003	documentation texturiert											
source	<code><element name="ABI_OberflaecheSchluessel" type="enum_0128"/></code>												

element ArtikelBrustimplantatBasis/ABI_OberflaecheUnbekannt

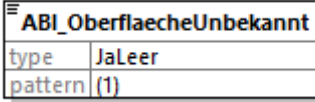
diagram							
type	JaLeer						
properties	content simple						
facets	<table border="1"> <thead> <tr> <th>Kind</th> <th>Value</th> <th>Annotation</th> </tr> </thead> <tbody> <tr> <td>pattern</td> <td>(1)</td> <td></td> </tr> </tbody> </table>	Kind	Value	Annotation	pattern	(1)	
Kind	Value	Annotation					
pattern	(1)						
source	<code><element name="ABI_OberflaecheUnbekannt" type="JaLeer"/></code>						

element ArtikelBrustimplantatBasis/ABI_FuellungSchluessel

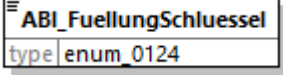
diagram																
type	enum 0124															
properties	content simple															
facets	<table border="1"> <thead> <tr> <th>Kind</th> <th>Value</th> <th>Annotation</th> </tr> </thead> <tbody> <tr> <td>enumeration</td> <td>0124001</td> <td>documentation Salzlösung</td> </tr> <tr> <td>enumeration</td> <td>0124002</td> <td>documentation Silikongel</td> </tr> <tr> <td>enumeration</td> <td>0124003</td> <td>documentation Kombination Silikongel und Salzlösung</td> </tr> <tr> <td>enumeration</td> <td>0124042</td> <td>documentation</td> </tr> </tbody> </table>	Kind	Value	Annotation	enumeration	0124001	documentation Salzlösung	enumeration	0124002	documentation Silikongel	enumeration	0124003	documentation Kombination Silikongel und Salzlösung	enumeration	0124042	documentation
Kind	Value	Annotation														
enumeration	0124001	documentation Salzlösung														
enumeration	0124002	documentation Silikongel														
enumeration	0124003	documentation Kombination Silikongel und Salzlösung														
enumeration	0124042	documentation														

	sonstige
source	<element name="ABI_FuellungSchluesse1" type="enum_0124"/>

element **ArtikelBrustimplantatBasis/ABI_FuellungUnbekannt**

diagram	
type	JaLeer
properties	content simple
facets	Kind Value Annotation pattern (1)
source	<element name="ABI_FuellungUnbekannt" type="JaLeer"/>

element **ArtikelBrustimplantatBasis/ABI_Volumen**

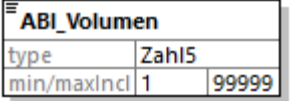
diagram	
type	Zahl5
properties	content simple
facets	Kind Value Annotation minInclusive 1 maxInclusive 99999
source	<element name="ABI_Volumen" type="Zahl5"/>

element **ArtikelBrustimplantatBasis/ABI_VolumenUnbekannt**

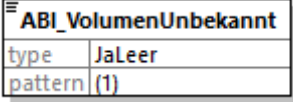
diagram	
type	JaLeer
properties	content simple
facets	Kind Value Annotation pattern (1)
source	<element name="ABI_VolumenUnbekannt" type="JaLeer"/>

element **ArtikelBrustimplantatBasis/ABI_IntraoperativesVolumen**

diagram	
type	Zahl5mitNull
properties	content simple
facets	Kind Value Annotation minInclusive 0 maxInclusive 99999
source	<element name="ABI_IntraoperativesVolumen" type="Zahl5mitNull"/>

type	Zahl5mitNull
properties	minOcc 0 maxOcc 1 content simple
facets	Kind Value Annotation minInclusive 0 maxInclusive 99999
source	<code><element name="ABI_IntraoperativesVolumen" type="Zahl5mitNull" minOccurs="0"/></code>

complexType ArtikelEndoprotheseBasis

diagram	
namespace	http://xml.ir-d.de/emg
children	AEP_HerstellerSchluessel AEP_HerstellerUnbekannt AEP_HerstellerSonstiger AEP_LieferantSchluessel AEP_ArtikelTypSchluessel AEP_ArtikelTypHuefteSchluessel AEP_ArtikelTypKnieSchluessel AEP_Menge AEP_EinheitSchluessel
used by	element Artikelbeschreibung/artikelEndoprothese
source	<pre> <complexType name="ArtikelEndoprotheseBasis"> <sequence> <choice> <element name="AEP_HerstellerSchluessel" type="String7"/> <element name="AEP_HerstellerUnbekannt" type="JaLeer"/> </choice> </pre>

```

<element name="AEP_HerstellerSonstiger" type="Freitext250"
minOccurs="0"/>
<element name="AEP_LieferantSchluessel" type="String7" minOccurs="0"/>
<element name="AEP_ArtikelTypSchluessel" type="enum_0290"/>
<choice minOccurs="0">
  <element name="AEP_ArtikelTypHuefteSchluessel" type="enum_0292"/>
  <element name="AEP_ArtikelTypKnieSchluessel" type="enum_0293"/>
</choice>
<element name="AEP_Menge" type="Zahl5" minOccurs="0"/>
<element name="AEP_EinheitSchluessel" type="enum_0062" minOccurs="0"/>
</sequence>
</complexType>

```

element **ArtikelEndoprotheseBasis/AEP_HerstellerSchluessel**

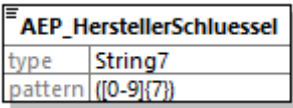
diagram							
type	String7						
properties	content simple						
facets	<table border="1"> <thead> <tr> <th>Kind</th> <th>Value</th> <th>Annotation</th> </tr> </thead> <tbody> <tr> <td>pattern</td> <td>([0-9]{7})</td> <td></td> </tr> </tbody> </table>	Kind	Value	Annotation	pattern	([0-9]{7})	
Kind	Value	Annotation					
pattern	([0-9]{7})						
source	<code><element name="AEP_HerstellerSchluessel" type="String7"/></code>						

element **ArtikelEndoprotheseBasis/AEP_HerstellerUnbekannt**

diagram							
type	JaLeer						
properties	content simple						
facets	<table border="1"> <thead> <tr> <th>Kind</th> <th>Value</th> <th>Annotation</th> </tr> </thead> <tbody> <tr> <td>pattern</td> <td>(1)</td> <td></td> </tr> </tbody> </table>	Kind	Value	Annotation	pattern	(1)	
Kind	Value	Annotation					
pattern	(1)						
source	<code><element name="AEP_HerstellerUnbekannt" type="JaLeer"/></code>						

element **ArtikelEndoprotheseBasis/AEP_HerstellerSonstiger**

diagram							
type	Freitext250						
properties	<table border="1"> <tbody> <tr> <td>minOcc</td> <td>0</td> </tr> <tr> <td>maxOcc</td> <td>1</td> </tr> <tr> <td>content</td> <td>simple</td> </tr> </tbody> </table>	minOcc	0	maxOcc	1	content	simple
minOcc	0						
maxOcc	1						
content	simple						
facets	<table border="1"> <thead> <tr> <th>Kind</th> <th>Value</th> <th>Annotation</th> </tr> </thead> <tbody> <tr> <td>maxLength</td> <td>250</td> <td></td> </tr> </tbody> </table>	Kind	Value	Annotation	maxLength	250	
Kind	Value	Annotation					
maxLength	250						
source	<code><element name="AEP_HerstellerSonstiger" type="Freitext250" minOccurs="0"/></code>						

element **ArtikelEndoprotheseBasis/AEP_LieferantSchluessel**

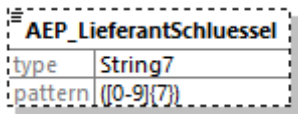
diagram	
type	String7
properties	minOcc 0 maxOcc 1 content simple
facets	Kind Value Annotation pattern ([0-9]{7})
source	<code><element name="AEP_LieferantSchluessel" type="String7" minOccurs="0"/></code>

element **ArtikelEndoprotheseBasis/AEP_ArtikelTypSchluessel**

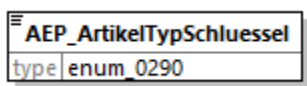
diagram																			
type	enum_0290																		
properties	content simple																		
facets	<table border="1"> <thead> <tr> <th>Kind</th> <th>Value</th> <th>Annotation</th> </tr> </thead> <tbody> <tr> <td>enumeration</td> <td>0290001</td> <td>documentation Hüft-Komponente</td> </tr> <tr> <td>enumeration</td> <td>0290002</td> <td>documentation Knie-Komponente</td> </tr> <tr> <td>enumeration</td> <td>0290003</td> <td>documentation Modulare Komponente (Hüfte/Knie)</td> </tr> <tr> <td>enumeration</td> <td>0290004</td> <td>documentation Knochenzement</td> </tr> <tr> <td>enumeration</td> <td>0290042</td> <td>documentation sonstiger</td> </tr> </tbody> </table>	Kind	Value	Annotation	enumeration	0290001	documentation Hüft-Komponente	enumeration	0290002	documentation Knie-Komponente	enumeration	0290003	documentation Modulare Komponente (Hüfte/Knie)	enumeration	0290004	documentation Knochenzement	enumeration	0290042	documentation sonstiger
Kind	Value	Annotation																	
enumeration	0290001	documentation Hüft-Komponente																	
enumeration	0290002	documentation Knie-Komponente																	
enumeration	0290003	documentation Modulare Komponente (Hüfte/Knie)																	
enumeration	0290004	documentation Knochenzement																	
enumeration	0290042	documentation sonstiger																	
source	<code><element name="AEP_ArtikelTypSchluessel" type="enum_0290"/></code>																		

element **ArtikelEndoprotheseBasis/AEP_ArtikelTypHuefteSchluessel**

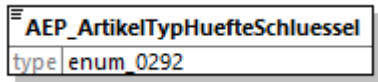
diagram																			
type	enum_0292																		
properties	content simple																		
facets	<table border="1"> <thead> <tr> <th>Kind</th> <th>Value</th> <th>Annotation</th> </tr> </thead> <tbody> <tr> <td>enumeration</td> <td>0292001</td> <td>documentation Pfanne</td> </tr> <tr> <td>enumeration</td> <td>0292002</td> <td>documentation Inlay</td> </tr> <tr> <td>enumeration</td> <td>0292003</td> <td>documentation Kopf</td> </tr> <tr> <td>enumeration</td> <td>0292004</td> <td>documentation Schaft</td> </tr> <tr> <td>enumeration</td> <td>0292005</td> <td>documentation Vormontierte Acetabularkomponente (Pfanne mit Inlay)</td> </tr> </tbody> </table>	Kind	Value	Annotation	enumeration	0292001	documentation Pfanne	enumeration	0292002	documentation Inlay	enumeration	0292003	documentation Kopf	enumeration	0292004	documentation Schaft	enumeration	0292005	documentation Vormontierte Acetabularkomponente (Pfanne mit Inlay)
Kind	Value	Annotation																	
enumeration	0292001	documentation Pfanne																	
enumeration	0292002	documentation Inlay																	
enumeration	0292003	documentation Kopf																	
enumeration	0292004	documentation Schaft																	
enumeration	0292005	documentation Vormontierte Acetabularkomponente (Pfanne mit Inlay)																	

	enumeration 0292006 documentation Einteilige Femoralkomponente (Schaft mit Kopf)
	enumeration 0292042 documentation sonstiger
source	<code><element name="AEP_ArtikelTypHuefteSchluessel" type="enum_0292"/></code>

element **ArtikelEndoprotheseBasis/AEP_ArtikelTypKnieSchluessel**

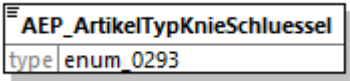
diagram			
type	enum 0293		
properties	content simple		
facets	Kind	Value	Annotation
	enumeration	0293001	documentation Tibiakomponente
	enumeration	0293002	documentation Femurkomponente
	enumeration	0293003	documentation Patella
	enumeration	0293004	documentation Insert
	enumeration	0293005	documentation Vormontierte Tibiakomponente mit Insert
	enumeration	0293042	documentation sonstiger
source	<code><element name="AEP_ArtikelTypKnieSchluessel" type="enum_0293"/></code>		

element **ArtikelEndoprotheseBasis/AEP_Menge**

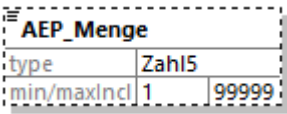
diagram			
type	Zahl5		
properties	minOcc 0	maxOcc 1	content simple
facets	Kind	Value	Annotation
	minInclusive	1	
	maxInclusive	99999	
source	<code><element name="AEP_Menge" type="Zahl5" minOccurs="0"/></code>		

element **ArtikelEndoprotheseBasis/AEP_EinheitSchluessel**

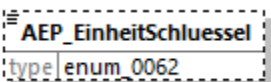
diagram			
type	enum 0062		
properties	minOcc 0	maxOcc 1	content simple

facets	Kind	Value	Annotation
	enumeration	0062001	documentation Stück
	enumeration	0062002	documentation g
	enumeration	0062003	documentation mg
	enumeration	0062004	documentation l
	enumeration	0062005	documentation ml
	enumeration	0062006	documentation cm ³
	enumeration	0062007	documentation mm
	enumeration	0062008	documentation cm
	enumeration	0062009	documentation dm
	enumeration	0062010	documentation m
	enumeration	0062042	documentation andere
source	<code><element name="AEP_EinheitSchluessel" type="enum_0062" minOccurs="0"/></code>		

complexType **ArtikelAortenklappeBasis**

<p>diagram</p>	
<p>namespace</p>	<p>http://xml.ir-d.de/emg</p>
<p>children</p>	<p>AAK HerstellerSchluessel AAK HerstellerUnbekannt AAK HerstellerSonstiger AAK KlappenTypSchluessel AAK KlappenTypUnbekannt AAK ArtikelTypSchluessel AAK ProthesenGroesse AAK ProthesenGroesseUnbekannt AAK Dislokation</p>
<p>used by</p>	<p>element Artikelbeschreibung/artikelAortenklappe</p>
<p>source</p>	<pre><complexType name="ArtikelAortenklappeBasis"> <sequence> <choice> <element name="AAK_HerstellerSchluessel" type="String7"/> <element name="AAK_HerstellerUnbekannt" type="JaLeer"/> </choice> <element name="AAK_HerstellerSonstiger" type="Freitext250" minOccurs="0"/> <choice> <element name="AAK_KlappenTypSchluessel" type="enum_0391"/> <element name="AAK_KlappenTypUnbekannt" type="JaLeer"/> </choice> <element name="AAK_ArtikelTypSchluessel" type="enum_0390" minOccurs="0"/> <choice> <element name="AAK_ProthesenGroesse" type="Zahl2"/> <element name="AAK_ProthesenGroesseUnbekannt" type="JaLeer"/> </choice> </sequence> </complexType></pre>

	<pre><element name="AAK_Dislokation" type="JaLeer" minOccurs="0"/> </sequence> </complexType></pre>
--	---

element **ArtikelAortenklappeBasis/AAK_HerstellerSchluessel**

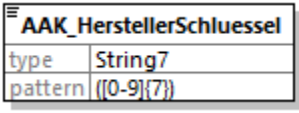
diagram							
type	String7						
properties	content simple						
facets	<table border="1"> <thead> <tr> <th>Kind</th> <th>Value</th> <th>Annotation</th> </tr> </thead> <tbody> <tr> <td>pattern</td> <td>([0-9]{7})</td> <td></td> </tr> </tbody> </table>	Kind	Value	Annotation	pattern	([0-9]{7})	
Kind	Value	Annotation					
pattern	([0-9]{7})						
source	<pre><element name="AAK_HerstellerSchluessel" type="String7"/></pre>						

element **ArtikelAortenklappeBasis/AAK_HerstellerUnbekannt**

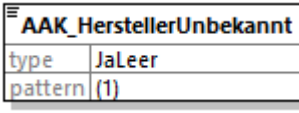
diagram							
type	JaLeer						
properties	content simple						
facets	<table border="1"> <thead> <tr> <th>Kind</th> <th>Value</th> <th>Annotation</th> </tr> </thead> <tbody> <tr> <td>pattern</td> <td>(1)</td> <td></td> </tr> </tbody> </table>	Kind	Value	Annotation	pattern	(1)	
Kind	Value	Annotation					
pattern	(1)						
source	<pre><element name="AAK_HerstellerUnbekannt" type="JaLeer"/></pre>						

element **ArtikelAortenklappeBasis/AAK_HerstellerSonstiger**

diagram							
type	Freitext250						
properties	<table border="1"> <tbody> <tr> <td>minOcc</td> <td>0</td> </tr> <tr> <td>maxOcc</td> <td>1</td> </tr> <tr> <td>content</td> <td>simple</td> </tr> </tbody> </table>	minOcc	0	maxOcc	1	content	simple
minOcc	0						
maxOcc	1						
content	simple						
facets	<table border="1"> <thead> <tr> <th>Kind</th> <th>Value</th> <th>Annotation</th> </tr> </thead> <tbody> <tr> <td>maxLength</td> <td>250</td> <td></td> </tr> </tbody> </table>	Kind	Value	Annotation	maxLength	250	
Kind	Value	Annotation					
maxLength	250						
source	<pre><element name="AAK_HerstellerSonstiger" type="Freitext250" minOccurs="0"/></pre>						

element **ArtikelAortenklappeBasis/AAK_KlappenTypSchluessel**

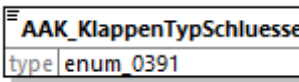
diagram	
type	enum_0391

properties	content simple									
facets	<table border="1"> <thead> <tr> <th>Kind</th> <th>Value</th> <th>Annotation</th> </tr> </thead> <tbody> <tr> <td>enumeration</td> <td>0391001</td> <td>documentation chirurgische Klappe</td> </tr> <tr> <td>enumeration</td> <td>0391002</td> <td>documentation TAVI-Klappe</td> </tr> </tbody> </table>	Kind	Value	Annotation	enumeration	0391001	documentation chirurgische Klappe	enumeration	0391002	documentation TAVI-Klappe
Kind	Value	Annotation								
enumeration	0391001	documentation chirurgische Klappe								
enumeration	0391002	documentation TAVI-Klappe								
source	<code><element name="AAK_KlappenTypSchluesse1" type="enum_0391"/></code>									

element ArtikelAortenklappeBasis/AAK_KlappenTypUnbekannt

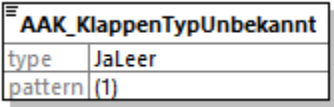
diagram							
type	JaLeer						
properties	content simple						
facets	<table border="1"> <thead> <tr> <th>Kind</th> <th>Value</th> <th>Annotation</th> </tr> </thead> <tbody> <tr> <td>pattern</td> <td>(1)</td> <td></td> </tr> </tbody> </table>	Kind	Value	Annotation	pattern	(1)	
Kind	Value	Annotation					
pattern	(1)						
source	<code><element name="AAK_KlappenTypUnbekannt" type="JaLeer"/></code>						

element ArtikelAortenklappeBasis/AAK_ArtikelTypSchluesse1

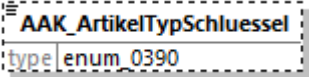
diagram										
type	enum_0390									
properties	<table border="1"> <tbody> <tr> <td>minOcc</td> <td>0</td> </tr> <tr> <td>maxOcc</td> <td>1</td> </tr> <tr> <td>content</td> <td>simple</td> </tr> </tbody> </table>	minOcc	0	maxOcc	1	content	simple			
minOcc	0									
maxOcc	1									
content	simple									
facets	<table border="1"> <thead> <tr> <th>Kind</th> <th>Value</th> <th>Annotation</th> </tr> </thead> <tbody> <tr> <td>enumeration</td> <td>0390001</td> <td>documentation biologisches Klappenmodell</td> </tr> <tr> <td>enumeration</td> <td>0390002</td> <td>documentation mechanisches Klappenmodell</td> </tr> </tbody> </table>	Kind	Value	Annotation	enumeration	0390001	documentation biologisches Klappenmodell	enumeration	0390002	documentation mechanisches Klappenmodell
Kind	Value	Annotation								
enumeration	0390001	documentation biologisches Klappenmodell								
enumeration	0390002	documentation mechanisches Klappenmodell								
source	<code><element name="AAK_ArtikelTypSchluesse1" type="enum_0390" minOccurs="0"/></code>									

element ArtikelAortenklappeBasis/AAK_ProthesenGrossesse

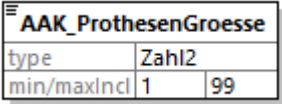
diagram										
type	Zahl2									
properties	content simple									
facets	<table border="1"> <thead> <tr> <th>Kind</th> <th>Value</th> <th>Annotation</th> </tr> </thead> <tbody> <tr> <td>minInclusive</td> <td>1</td> <td></td> </tr> <tr> <td>maxInclusive</td> <td>99</td> <td></td> </tr> </tbody> </table>	Kind	Value	Annotation	minInclusive	1		maxInclusive	99	
Kind	Value	Annotation								
minInclusive	1									
maxInclusive	99									
source	<code><element name="AAK_ProthesenGrossesse" type="Zahl2"/></code>									

element **ArtikelAortenklappeBasis/AAK_ProthesenGrosseUnbekannt**

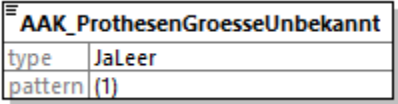
diagram							
type	JaLeer						
properties	content simple						
facets	<table border="1"> <tr> <td>Kind</td> <td>Value</td> <td>Annotation</td> </tr> <tr> <td>pattern</td> <td>(1)</td> <td></td> </tr> </table>	Kind	Value	Annotation	pattern	(1)	
Kind	Value	Annotation					
pattern	(1)						
source	<code><element name="AAK_ProthesenGrosseUnbekannt" type="JaLeer"/></code>						

element **ArtikelAortenklappeBasis/AAK_Dislokation**

diagram							
type	JaLeer						
properties	<table border="1"> <tr> <td>minOcc</td> <td>0</td> </tr> <tr> <td>maxOcc</td> <td>1</td> </tr> <tr> <td>content</td> <td>simple</td> </tr> </table>	minOcc	0	maxOcc	1	content	simple
minOcc	0						
maxOcc	1						
content	simple						
facets	<table border="1"> <tr> <td>Kind</td> <td>Value</td> <td>Annotation</td> </tr> <tr> <td>pattern</td> <td>(1)</td> <td></td> </tr> </table>	Kind	Value	Annotation	pattern	(1)	
Kind	Value	Annotation					
pattern	(1)						
source	<code><element name="AAK_Dislokation" type="JaLeer" minOccurs="0"/></code>						