

Schema IRD_XML_Spezifikation.xsd

schema location: http://xml.ir-d.de/rst/schema/verbindlich/V2.1.2/IRD_XML_Spezifikation.xsd
attributeFormDefault:
elementFormDefault: **unqualified**
targetNamespace: **http://xml.ir-d.de/rst**

Elements

[GEMeldung](#)
[GESelbstauskunft](#)
[GESTorno](#)
[IRDMeldungAntwort](#)
[IRDSelbstauskunftAntwort](#)
[IRDStornoAntwort](#)

schema location: <http://xml.ir-d.de/rst/schema/verbindlich/V2.1.2/GEMeldung.xsd>
attributeFormDefault:
elementFormDefault: **unqualified**
targetNamespace: **http://xml.ir-d.de/emg**

Complex types

[GeMeldung](#)

schema location: <http://xml.ir-d.de/rst/schema/verbindlich/V2.1.2/GESTorno.xsd>
attributeFormDefault:
elementFormDefault: **unqualified**
targetNamespace: **http://xml.ir-d.de/stn**

Complex types

[GeStorno](#)

schema location: <http://xml.ir-d.de/rst/schema/verbindlich/V2.1.2/IRDMeldungAntwort.xsd>
attributeFormDefault:
elementFormDefault: **unqualified**
targetNamespace: **http://xml.ir-d.de/irdma**

Complex types

[meldungAntwort](#)

schema location: <http://xml.ir-d.de/rst/schema/verbindlich/V2.1.2/IRDStornoAntwort.xsd>
attributeFormDefault:
elementFormDefault: **unqualified**
targetNamespace: **http://xml.ir-d.de/irdsa**

Complex types

[stornoAntwort](#)

schema location: <http://xml.ir-d.de/rst/schema/verbindlich/V2.1.2/GESelbstauskunft.xsd>
attributeFormDefault:
elementFormDefault: **unqualified**
targetNamespace: **http://xml.ir-d.de/sak**

Complex types

[GeSelbstauskunft](#)

schema location: <http://xml.ir-d.de/rst/schema/verbindlich/V2.1.2/IRDSelbstauskunftAntwort.xsd>
attributeFormDefault:
elementFormDefault: **unqualified**
targetNamespace: **http://xml.ir-d.de/irdsaa**

Complex types

[selbstauskunftAntwort](#)

schema location: <http://xml.ir-d.de/rst/schema/verbindlich/V2.1.2/Bausteine/Meldung.xsd>
attributeFormDefault:
elementFormDefault: **unqualified**
targetNamespace: **http://xml.ir-d.de/emg**

Complex types

[Meldung](#)

schema location: <http://xml.ir-d.de/rst/schema/verbindlich/V2.1.2/Bausteine/Storno.xsd>
attributeFormDefault:
elementFormDefault: **unqualified**
targetNamespace: **http://xml.ir-d.de/stn**

Complex types

[Storno](#)

schema location: <http://xml.ir-d.de/rst/schema/verbindlich/V2.1.2/Bausteine/MeldungIrd.xsd>
attributeFormDefault:
elementFormDefault: **unqualified**
targetNamespace: **http://xml.ir-d.de/irdma**

Complex types

[MeldungIrd](#)

schema location: <http://xml.ir-d.de/rst/schema/verbindlich/V2.1.2/Bausteine/EmpfangsbestaetigungBasis.xsd>
attributeFormDefault:
elementFormDefault: **unqualified**
targetNamespace: **http://xml.ir-d.de/irdma**

Complex types

[EmpfangsbestaetigungBasis](#)

schema location: <http://xml.ir-d.de/rst/schema/verbindlich/V2.1.2/Bausteine/HinweisBasis.xsd>
attributeFormDefault:
elementFormDefault: **unqualified**
targetNamespace: **http://xml.ir-d.de/irdma**

Complex types

[HinweisBasis](#)

schema location: <http://xml.ir-d.de/rst/schema/verbindlich/V2.1.2/Bausteine/Warnung.xsd>
attributeFormDefault:
elementFormDefault: **unqualified**
targetNamespace: **http://xml.ir-d.de/irdma**

Complex types

[Warnung](#)

schema location: <http://xml.ir-d.de/rst/schema/verbindlich/V2.1.2/Bausteine/BestaetigungBasis.xsd>
attributeFormDefault:
elementFormDefault: **unqualified**
targetNamespace: **http://xml.ir-d.de/irdma**

Complex types

[BestaetigungBasis](#)

schema location: <http://xml.ir-d.de/rst/schema/verbindlich/V2.1.2/Bausteine/Storno.xsd>
attributeFormDefault:
elementFormDefault: **unqualified**
targetNamespace: **http://xml.ir-d.de/irdsa**

Complex types

[Storno](#)

schema location: <http://xml.ir-d.de/rst/schema/verbindlich/V2.1.2/Bausteine/EmpfangsbestaetigungBasis.xsd>
attributeFormDefault:
elementFormDefault: **unqualified**
targetNamespace: **http://xml.ir-d.de/irdsa**

Complex types

[EmpfangsbestaetigungBasis](#)

schema location: <http://xml.ir-d.de/rst/schema/verbindlich/V2.1.2/Bausteine/HinweisBasis.xsd>
attributeFormDefault:
elementFormDefault: **unqualified**
targetNamespace: **http://xml.ir-d.de/irdsa**

Complex types

[HinweisBasis](#)

schema location: <http://xml.ir-d.de/rst/schema/verbindlich/V2.1.2/Bausteine/Selbstauskunft.xsd>
attributeFormDefault:
elementFormDefault: **unqualified**
targetNamespace: **http://xml.ir-d.de/sak**

Complex types

[Selbstauskunft](#)

schema location: <http://xml.ir-d.de/rst/schema/verbindlich/V2.1.2/Bausteine/Selbstauskunft.xsd>
attributeFormDefault:
elementFormDefault: **unqualified**
targetNamespace: **http://xml.ir-d.de/irdsaa**

Complex types

[Selbstauskunft](#)

schema location: <http://xml.ir-d.de/rst/schema/verbindlich/V2.1.2/Bausteine/EmpfangsbestaetigungBasis.xsd>
attributeFormDefault:
elementFormDefault: **unqualified**
targetNamespace: **http://xml.ir-d.de/irdsaa**

Complex types

[EmpfangsbestaetigungBasis](#)

schema location: <http://xml.ir-d.de/rst/schema/verbindlich/V2.1.2/Bausteine/MeldungBasis.xsd>
attributeFormDefault:
elementFormDefault: **unqualified**
targetNamespace: **http://xml.ir-d.de/emg**

Complex types

[MeldungBasis](#)

schema location: <http://xml.ir-d.de/rst/schema/verbindlich/V2.1.2/Bausteine/Fall.xsd>
attributeFormDefault:
elementFormDefault: **unqualified**
targetNamespace: **http://xml.ir-d.de/emg**

Complex types

[Fall](#)

schema location: http://xml.ir-d.de/rst/schema/verbindlich/V2.1.2/Datentypen/IRD_DatenTypen.xsd
attributeFormDefault:
elementFormDefault: **unqualified**
targetNamespace: **http://xml.ir-d.de/stn**

Simple types

[DatumText](#)

[Freitext250](#)

[Freitext500](#)

[HashString](#)

[HashWert](#)

[ICD](#)

[IdEinrichtung](#)

[IrdArtikelId](#)

[IrdSpezVersion](#)

[JaLeer](#)

[Meldebestaetigung](#)

[OPS](#)

[String2](#)

[String20](#)

[Sw](#)

[Transfervnummer](#)

[Versionsnummer](#)

[Zahl1](#)

[Zahl1_1](#)

[Zahl2](#)

[Zahl2_1](#)

[Zahl3](#)

[Zahl3_1](#)

[Zahl4](#)
[Zahl5](#)
[Zahl5mitNull](#)

schema location: <http://xml.ir-d.de/rst/schema/verbindlich/V2.1.2/Bausteine/MeldungIrdBasis.xsd>
attributeFormDefault:
elementFormDefault: **unqualified**
targetNamespace: **http://xml.ir-d.de/stn**

Complex types
[MeldungIrdBasis](#)

schema location: <http://xml.ir-d.de/rst/schema/verbindlich/V2.1.2/Bausteine/StornoFallBasis.xsd>
attributeFormDefault:
elementFormDefault: **unqualified**
targetNamespace: **http://xml.ir-d.de/stn**

Complex types
[StornoFallBasis](#)

schema location: http://xml.ir-d.de/rst/schema/verbindlich/V2.1.2/Datentypen/IRD_DatenTypen.xsd
attributeFormDefault:
elementFormDefault: **unqualified**
targetNamespace: **http://xml.ir-d.de/irdma**

Simple types
[DatumText](#)
[Freitext250](#)
[Freitext500](#)
[HashString](#)
[HashWert](#)
[ICD](#)
[IdEinrichtung](#)
[IrdArtikelId](#)
[IrdSpezVersion](#)
[JaLeer](#)
[Meldebestaetigung](#)
[OPS](#)
[String2](#)
[String20](#)
[Sw](#)
[Transfervummer](#)
[Versionsnummer](#)
[Zahl1](#)
[Zahl1_1](#)
[Zahl2](#)
[Zahl2_1](#)
[Zahl3](#)
[Zahl3_1](#)
[Zahl4](#)

[Zahl5](#)
[Zahl5mitNull](#)

schema location: <http://xml.ir-d.de/rst/schema/verbindlich/V2.1.2/Bausteine/MeldungIrdBasis.xsd>
attributeFormDefault:
elementFormDefault: **unqualified**
targetNamespace: **http://xml.ir-d.de/irdma**

Complex types
[MeldungIrdBasis](#)

schema location: <http://xml.ir-d.de/rst/schema/verbindlich/V2.1.2/Bausteine/MeldungIrdFallBasis.xsd>
attributeFormDefault:
elementFormDefault: **unqualified**
targetNamespace: **http://xml.ir-d.de/irdma**

Complex types
[MeldungIrdFallBasis](#)

schema location: http://xml.ir-d.de/rst/schema/verbindlich/V2.1.2/Datentypen/IRD_DatenTypen.xsd
attributeFormDefault:
elementFormDefault: **unqualified**
targetNamespace: **http://xml.ir-d.de/irdsa**

Simple types
[DatumText](#)
[Freitext250](#)
[Freitext500](#)
[HashString](#)
[HashWert](#)
[ICD](#)
[IdEinrichtung](#)
[IrdArtikelId](#)
[IrdSpezVersion](#)
[JaLeer](#)
[Meldebestaetigung](#)
[OPS](#)
[String2](#)
[String20](#)
[Sw](#)
[Transfervnummer](#)
[Versionsnummer](#)
[Zahl1](#)
[Zahl1_1](#)
[Zahl2](#)
[Zahl2_1](#)
[Zahl3](#)
[Zahl3_1](#)
[Zahl4](#)
[Zahl5](#)

Zahl5mitNull

schema location: <http://xml.ir-d.de/rst/schema/verbindlich/V2.1.2/Bausteine/MeldungIrdBasis.xsd>
attributeFormDefault:
elementFormDefault: **unqualified**
targetNamespace: **http://xml.ir-d.de/irdsa**

Complex types

MeldungIrdBasis

schema location: <http://xml.ir-d.de/rst/schema/verbindlich/V2.1.2/Bausteine/StornoFallBasis.xsd>
attributeFormDefault:
elementFormDefault: **unqualified**
targetNamespace: **http://xml.ir-d.de/irdsa**

Complex types

StornoFallBasis

schema location: http://xml.ir-d.de/rst/schema/verbindlich/V2.1.2/Datentypen/IRD_DatenTypen.xsd
attributeFormDefault:
elementFormDefault: **unqualified**
targetNamespace: **http://xml.ir-d.de/sak**

Simple types

[DatumText](#)

[Freitext250](#)

[Freitext500](#)

[HashString](#)

[HashWert](#)

[ICD](#)

[IdEinrichtung](#)

[IrdArtikellId](#)

[IrdSpezVersion](#)

[JaLeer](#)

[Meldebestaetigung](#)

[OPS](#)

[String2](#)

[String20](#)

[Sw](#)

[Transfervnummer](#)

[Versionsnummer](#)

[Zahl1](#)

[Zahl1_1](#)

[Zahl2](#)

[Zahl2_1](#)

[Zahl3](#)

[Zahl3_1](#)

[Zahl4](#)

[Zahl5](#)

[Zahl5mitNull](#)

schema location: <http://xml.ir-d.de/rst/schema/verbindlich/V2.1.2/Bausteine/MeldungIrdBasis.xsd>
attributeFormDefault:
elementFormDefault: **unqualified**
targetNamespace: **http://xml.ir-d.de/sak**

Complex types
[MeldungIrdBasis](#)

schema location: <http://xml.ir-d.de/rst/schema/verbindlich/V2.1.2/Bausteine/SelbstauskunftFallBasis.xsd>
attributeFormDefault:
elementFormDefault: **unqualified**
targetNamespace: **http://xml.ir-d.de/sak**

Complex types
[SelbstauskunftFallBasis](#)

schema location: http://xml.ir-d.de/rst/schema/verbindlich/V2.1.2/Datentypen/IRD_DatenTypen.xsd
attributeFormDefault:
elementFormDefault: **unqualified**
targetNamespace: **http://xml.ir-d.de/irdsaa**

Simple types
[DatumText](#)
[Freitext250](#)
[Freitext500](#)
[HashString](#)
[HashWert](#)
[ICD](#)
[IdEinrichtung](#)
[IrdArtikelId](#)
[IrdSpezVersion](#)
[JaLeer](#)
[Meldebestaetigung](#)
[OPS](#)
[String2](#)
[String20](#)
[Sw](#)
[Transfervnummer](#)
[Versionsnummer](#)
[Zahl1](#)
[Zahl1_1](#)
[Zahl2](#)
[Zahl2_1](#)
[Zahl3](#)
[Zahl3_1](#)
[Zahl4](#)
[Zahl5](#)
[Zahl5mitNull](#)

schema location: <http://xml.ir-d.de/rst/schema/verbindlich/V2.1.2/Bausteine/MeldungIrdBasis.xsd>
attributeFormDefault:
elementFormDefault: **unqualified**
targetNamespace: **http://xml.ir-d.de/irdsaa**

Complex types
[MeldungIrdBasis](#)

schema location: <http://xml.ir-d.de/rst/schema/verbindlich/V2.1.2/Bausteine/SelbstauskunftFallBasis.xsd>
attributeFormDefault:
elementFormDefault: **unqualified**
targetNamespace: **http://xml.ir-d.de/irdsaa**

Complex types
[SelbstauskunftFallBasis](#)

schema location: http://xml.ir-d.de/rst/schema/verbindlich/V2.1.2/Datentypen/IRD_DatenTypen.xsd
attributeFormDefault:
elementFormDefault: **unqualified**
targetNamespace: **http://xml.ir-d.de/emg**

Simple types
[DatumText](#)
[Freitext250](#)
[Freitext500](#)
[HashString](#)
[HashWert](#)
[ICD](#)
[IdEinrichtung](#)
[IrdArtikelId](#)
[IrdSpezVersion](#)
[JaLeer](#)
[Meldebestaetigung](#)
[OPS](#)
[String2](#)
[String20](#)
[Sw](#)
[Transfervnummer](#)
[Versionsnummer](#)
[Zahl1](#)
[Zahl1 1](#)
[Zahl2](#)
[Zahl2 1](#)
[Zahl3](#)
[Zahl3 1](#)
[Zahl4](#)
[Zahl5](#)
[Zahl5mitNull](#)

schema location: <http://xml.ir-d.de/rst/schema/verbindlich/V2.1.2/Bausteine/FallBasis.xsd>
attributeFormDefault:
elementFormDefault: **unqualified**
targetNamespace: **http://xml.ir-d.de/emg**

Complex types
[FallBasis](#)

schema location: <http://xml.ir-d.de/rst/schema/verbindlich/V2.1.2/Bausteine/AusloeserBasis.xsd>
attributeFormDefault:
elementFormDefault: **unqualified**
targetNamespace: **http://xml.ir-d.de/emg**

Complex types
[AusloeserBasis](#)

schema location: <http://xml.ir-d.de/rst/schema/verbindlich/V2.1.2/Bausteine/Patientenaufnahme.xsd>
attributeFormDefault:
elementFormDefault: **unqualified**
targetNamespace: **http://xml.ir-d.de/emg**

Complex types
[Patientenaufnahme](#)

schema location: <http://xml.ir-d.de/rst/schema/verbindlich/V2.1.2/Bausteine/Operation.xsd>
attributeFormDefault:
elementFormDefault: **unqualified**
targetNamespace: **http://xml.ir-d.de/emg**

Complex types
[Operation](#)

schema location: <http://xml.ir-d.de/rst/schema/verbindlich/V2.1.2/Bausteine/Entlassung.xsd>
attributeFormDefault:
elementFormDefault: **unqualified**
targetNamespace: **http://xml.ir-d.de/emg**

Complex types
[Entlassung](#)

schema location: <http://xml.ir-d.de/rst/schema/verbindlich/V2.1.2/Bausteine/PostoperationAortenklappe.xsd>
attributeFormDefault:
elementFormDefault: **unqualified**
targetNamespace: **http://xml.ir-d.de/emg**

Complex types

[PostoperationAortenklappe](#)

schema location: http://xml.ir-d.de/rst/schema/verbindlich/V2.1.2/Datentypen/IRD_Wertelisten.xsd
attributeFormDefault:
elementFormDefault: **qualified**
targetNamespace: **http://xml.ir-d.de/stn**

Simple types

[enum 0044](#)
[enum 0050](#)
[enum 0060](#)
[enum 0061](#)
[enum 0062](#)
[enum 0065](#)
[enum 0067](#)
[enum 0068](#)
[enum 0069](#)
[enum 0070](#)
[enum 0071](#)
[enum 0075](#)
[enum 0076](#)
[enum 0080](#)
[enum 0100](#)
[enum 0102](#)
[enum 0103](#)
[enum 0104](#)
[enum 0105](#)
[enum 0106](#)
[enum 0107](#)
[enum 0110](#)
[enum 0111](#)
[enum 0112](#)
[enum 0113](#)
[enum 0114](#)
[enum 0116](#)
[enum 0118](#)
[enum 0120](#)
[enum 0121](#)
[enum 0122](#)
[enum 0123](#)
[enum 0124](#)
[enum 0126](#)
[enum 0128](#)
[enum 0130](#)
[enum 0131](#)
[enum 0190](#)
[enum 0191](#)
[enum 0200](#)
[enum 0202](#)
[enum 0204](#)
[enum 0206](#)

[enum 0210](#)
[enum 0211](#)
[enum 0212](#)
[enum 0220](#)
[enum 0222](#)
[enum 0230](#)
[enum 0252](#)
[enum 0254](#)
[enum 0256](#)
[enum 0262](#)
[enum 0264](#)
[enum 0266](#)
[enum 0270](#)
[enum 0271](#)
[enum 0290](#)
[enum 0291](#)
[enum 0300](#)
[enum 0302](#)
[enum 0318](#)
[enum 0320](#)
[enum 0322](#)
[enum 0324](#)
[enum 0330](#)
[enum 0338](#)
[enum 0339](#)
[enum 0341](#)
[enum 0342](#)
[enum 0343](#)
[enum 0346](#)
[enum 0347](#)
[enum 0348](#)
[enum 0350](#)
[enum 0351](#)
[enum 0352](#)
[enum 0353](#)
[enum 0354](#)
[enum 0357](#)
[enum 0358](#)
[enum 0359](#)
[enum 0360](#)
[enum 0361](#)
[enum 0362](#)
[enum 0363](#)
[enum 0364](#)
[enum 0365](#)
[enum 0366](#)
[enum 0367](#)
[enum 0368](#)
[enum 0369](#)
[enum 0370](#)
[enum 0371](#)
[enum 0372](#)
[enum 0373](#)
[enum 0374](#)
[enum 0375](#)
[enum 0376](#)
[enum 0377](#)
[enum 0378](#)
[enum 0379](#)
[enum 0380](#)
[enum 0381](#)
[enum 0382](#)
[enum 0383](#)
[enum 0384](#)
[enum 0385](#)

[enum 0388](#)
[enum 0389](#)
[enum 0390](#)
[enum 0398](#)
[enum 0399](#)

schema location: http://xml.ir-d.de/rst/schema/verbindlich/V2.1.2/Datentypen/IRD_Wertelisten.xsd
attributeFormDefault:
elementFormDefault: **qualified**
targetNamespace: <http://xml.ir-d.de/irdma>

Simple types

[enum 0044](#)
[enum 0050](#)
[enum 0060](#)
[enum 0061](#)
[enum 0062](#)
[enum 0065](#)
[enum 0067](#)
[enum 0068](#)
[enum 0069](#)
[enum 0070](#)
[enum 0071](#)
[enum 0075](#)
[enum 0076](#)
[enum 0080](#)
[enum 0100](#)
[enum 0102](#)
[enum 0103](#)
[enum 0104](#)
[enum 0105](#)
[enum 0106](#)
[enum 0107](#)
[enum 0110](#)
[enum 0111](#)
[enum 0112](#)
[enum 0113](#)
[enum 0114](#)
[enum 0116](#)
[enum 0118](#)
[enum 0120](#)
[enum 0121](#)
[enum 0122](#)
[enum 0123](#)
[enum 0124](#)
[enum 0126](#)
[enum 0128](#)
[enum 0130](#)
[enum 0131](#)
[enum 0190](#)
[enum 0191](#)
[enum 0200](#)
[enum 0202](#)
[enum 0204](#)
[enum 0206](#)
[enum 0210](#)
[enum 0211](#)
[enum 0212](#)
[enum 0220](#)
[enum 0222](#)

[enum 0230](#)
[enum 0252](#)
[enum 0254](#)
[enum 0256](#)
[enum 0262](#)
[enum 0264](#)
[enum 0266](#)
[enum 0270](#)
[enum 0271](#)
[enum 0290](#)
[enum 0291](#)
[enum 0300](#)
[enum 0302](#)
[enum 0318](#)
[enum 0320](#)
[enum 0322](#)
[enum 0324](#)
[enum 0330](#)
[enum 0338](#)
[enum 0339](#)
[enum 0341](#)
[enum 0342](#)
[enum 0343](#)
[enum 0346](#)
[enum 0347](#)
[enum 0348](#)
[enum 0350](#)
[enum 0351](#)
[enum 0352](#)
[enum 0353](#)
[enum 0354](#)
[enum 0357](#)
[enum 0358](#)
[enum 0359](#)
[enum 0360](#)
[enum 0361](#)
[enum 0362](#)
[enum 0363](#)
[enum 0364](#)
[enum 0365](#)
[enum 0366](#)
[enum 0367](#)
[enum 0368](#)
[enum 0369](#)
[enum 0370](#)
[enum 0371](#)
[enum 0372](#)
[enum 0373](#)
[enum 0374](#)
[enum 0375](#)
[enum 0376](#)
[enum 0377](#)
[enum 0378](#)
[enum 0379](#)
[enum 0380](#)
[enum 0381](#)
[enum 0382](#)
[enum 0383](#)
[enum 0384](#)
[enum 0385](#)
[enum 0388](#)
[enum 0389](#)
[enum 0390](#)
[enum 0398](#)
[enum 0399](#)

schema location: http://xml.ir-d.de/rst/schema/verbindlich/V2.1.2/Datentypen/IRD_Wertelisten.xsd
attributeFormDefault:
elementFormDefault: **qualified**
targetNamespace: **http://xml.ir-d.de/irdsa**

Simple types

[enum 0044](#)
[enum 0050](#)
[enum 0060](#)
[enum 0061](#)
[enum 0062](#)
[enum 0065](#)
[enum 0067](#)
[enum 0068](#)
[enum 0069](#)
[enum 0070](#)
[enum 0071](#)
[enum 0075](#)
[enum 0076](#)
[enum 0080](#)
[enum 0100](#)
[enum 0102](#)
[enum 0103](#)
[enum 0104](#)
[enum 0105](#)
[enum 0106](#)
[enum 0107](#)
[enum 0110](#)
[enum 0111](#)
[enum 0112](#)
[enum 0113](#)
[enum 0114](#)
[enum 0116](#)
[enum 0118](#)
[enum 0120](#)
[enum 0121](#)
[enum 0122](#)
[enum 0123](#)
[enum 0124](#)
[enum 0126](#)
[enum 0128](#)
[enum 0130](#)
[enum 0131](#)
[enum 0190](#)
[enum 0191](#)
[enum 0200](#)
[enum 0202](#)
[enum 0204](#)
[enum 0206](#)
[enum 0210](#)
[enum 0211](#)
[enum 0212](#)
[enum 0220](#)
[enum 0222](#)
[enum 0230](#)
[enum 0252](#)
[enum 0254](#)
[enum 0256](#)
[enum 0262](#)

[enum 0264](#)
[enum 0266](#)
[enum 0270](#)
[enum 0271](#)
[enum 0290](#)
[enum 0291](#)
[enum 0300](#)
[enum 0302](#)
[enum 0318](#)
[enum 0320](#)
[enum 0322](#)
[enum 0324](#)
[enum 0330](#)
[enum 0338](#)
[enum 0339](#)
[enum 0341](#)
[enum 0342](#)
[enum 0343](#)
[enum 0346](#)
[enum 0347](#)
[enum 0348](#)
[enum 0350](#)
[enum 0351](#)
[enum 0352](#)
[enum 0353](#)
[enum 0354](#)
[enum 0357](#)
[enum 0358](#)
[enum 0359](#)
[enum 0360](#)
[enum 0361](#)
[enum 0362](#)
[enum 0363](#)
[enum 0364](#)
[enum 0365](#)
[enum 0366](#)
[enum 0367](#)
[enum 0368](#)
[enum 0369](#)
[enum 0370](#)
[enum 0371](#)
[enum 0372](#)
[enum 0373](#)
[enum 0374](#)
[enum 0375](#)
[enum 0376](#)
[enum 0377](#)
[enum 0378](#)
[enum 0379](#)
[enum 0380](#)
[enum 0381](#)
[enum 0382](#)
[enum 0383](#)
[enum 0384](#)
[enum 0385](#)
[enum 0388](#)
[enum 0389](#)
[enum 0390](#)
[enum 0398](#)
[enum 0399](#)

schema location:

http://xml.ir-d.de/rst/schema/verbindlich/V2.1.2/Datentypen/IRD_Wertelisten.xsd

attributeFormDefault:

elementFormDefault:

targetNamespace:

qualified

http://xml.ir-d.de/sak

Simple types

[enum 0044](#)

[enum 0050](#)

[enum 0060](#)

[enum 0061](#)

[enum 0062](#)

[enum 0065](#)

[enum 0067](#)

[enum 0068](#)

[enum 0069](#)

[enum 0070](#)

[enum 0071](#)

[enum 0075](#)

[enum 0076](#)

[enum 0080](#)

[enum 0100](#)

[enum 0102](#)

[enum 0103](#)

[enum 0104](#)

[enum 0105](#)

[enum 0106](#)

[enum 0107](#)

[enum 0110](#)

[enum 0111](#)

[enum 0112](#)

[enum 0113](#)

[enum 0114](#)

[enum 0116](#)

[enum 0118](#)

[enum 0120](#)

[enum 0121](#)

[enum 0122](#)

[enum 0123](#)

[enum 0124](#)

[enum 0126](#)

[enum 0128](#)

[enum 0130](#)

[enum 0131](#)

[enum 0190](#)

[enum 0191](#)

[enum 0200](#)

[enum 0202](#)

[enum 0204](#)

[enum 0206](#)

[enum 0210](#)

[enum 0211](#)

[enum 0212](#)

[enum 0220](#)

[enum 0222](#)

[enum 0230](#)

[enum 0252](#)

[enum 0254](#)

[enum 0256](#)

[enum 0262](#)

[enum 0264](#)

[enum 0266](#)

[enum 0270](#)

[enum 0271](#)

[enum 0290](#)

[enum 0291](#)
[enum 0300](#)
[enum 0302](#)
[enum 0318](#)
[enum 0320](#)
[enum 0322](#)
[enum 0324](#)
[enum 0330](#)
[enum 0338](#)
[enum 0339](#)
[enum 0341](#)
[enum 0342](#)
[enum 0343](#)
[enum 0346](#)
[enum 0347](#)
[enum 0348](#)
[enum 0350](#)
[enum 0351](#)
[enum 0352](#)
[enum 0353](#)
[enum 0354](#)
[enum 0357](#)
[enum 0358](#)
[enum 0359](#)
[enum 0360](#)
[enum 0361](#)
[enum 0362](#)
[enum 0363](#)
[enum 0364](#)
[enum 0365](#)
[enum 0366](#)
[enum 0367](#)
[enum 0368](#)
[enum 0369](#)
[enum 0370](#)
[enum 0371](#)
[enum 0372](#)
[enum 0373](#)
[enum 0374](#)
[enum 0375](#)
[enum 0376](#)
[enum 0377](#)
[enum 0378](#)
[enum 0379](#)
[enum 0380](#)
[enum 0381](#)
[enum 0382](#)
[enum 0383](#)
[enum 0384](#)
[enum 0385](#)
[enum 0388](#)
[enum 0389](#)
[enum 0390](#)
[enum 0398](#)
[enum 0399](#)

schema location: http://xml.ir-d.de/rst/schema/verbindlich/V2.1.2/Datentypen/IRD_Wertlisten.xsd
attributeFormDefault:
elementFormDefault: **qualified**
targetNamespace: <http://xml.ir-d.de/irdsaa>

Simple types

[enum 0044](#)
[enum 0050](#)
[enum 0060](#)
[enum 0061](#)
[enum 0062](#)
[enum 0065](#)
[enum 0067](#)
[enum 0068](#)
[enum 0069](#)
[enum 0070](#)
[enum 0071](#)
[enum 0075](#)
[enum 0076](#)
[enum 0080](#)
[enum 0100](#)
[enum 0102](#)
[enum 0103](#)
[enum 0104](#)
[enum 0105](#)
[enum 0106](#)
[enum 0107](#)
[enum 0110](#)
[enum 0111](#)
[enum 0112](#)
[enum 0113](#)
[enum 0114](#)
[enum 0116](#)
[enum 0118](#)
[enum 0120](#)
[enum 0121](#)
[enum 0122](#)
[enum 0123](#)
[enum 0124](#)
[enum 0126](#)
[enum 0128](#)
[enum 0130](#)
[enum 0131](#)
[enum 0190](#)
[enum 0191](#)
[enum 0200](#)
[enum 0202](#)
[enum 0204](#)
[enum 0206](#)
[enum 0210](#)
[enum 0211](#)
[enum 0212](#)
[enum 0220](#)
[enum 0222](#)
[enum 0230](#)
[enum 0252](#)
[enum 0254](#)
[enum 0256](#)
[enum 0262](#)
[enum 0264](#)
[enum 0266](#)
[enum 0270](#)
[enum 0271](#)
[enum 0290](#)
[enum 0291](#)
[enum 0300](#)
[enum 0302](#)
[enum 0318](#)
[enum 0320](#)

[enum 0322](#)
[enum 0324](#)
[enum 0330](#)
[enum 0338](#)
[enum 0339](#)
[enum 0341](#)
[enum 0342](#)
[enum 0343](#)
[enum 0346](#)
[enum 0347](#)
[enum 0348](#)
[enum 0350](#)
[enum 0351](#)
[enum 0352](#)
[enum 0353](#)
[enum 0354](#)
[enum 0357](#)
[enum 0358](#)
[enum 0359](#)
[enum 0360](#)
[enum 0361](#)
[enum 0362](#)
[enum 0363](#)
[enum 0364](#)
[enum 0365](#)
[enum 0366](#)
[enum 0367](#)
[enum 0368](#)
[enum 0369](#)
[enum 0370](#)
[enum 0371](#)
[enum 0372](#)
[enum 0373](#)
[enum 0374](#)
[enum 0375](#)
[enum 0376](#)
[enum 0377](#)
[enum 0378](#)
[enum 0379](#)
[enum 0380](#)
[enum 0381](#)
[enum 0382](#)
[enum 0383](#)
[enum 0384](#)
[enum 0385](#)
[enum 0388](#)
[enum 0389](#)
[enum 0390](#)
[enum 0398](#)
[enum 0399](#)

schema location: http://xml.ir-d.de/rst/schema/verbindlich/V2.1.2/Datentypen/IRD_Wertelisten.xsd
attributeFormDefault:
elementFormDefault: **qualified**
targetNamespace: <http://xml.ir-d.de/emg>

Simple types
[enum 0044](#)
[enum 0050](#)
[enum 0060](#)

[enum 0061](#)
[enum 0062](#)
[enum 0065](#)
[enum 0067](#)
[enum 0068](#)
[enum 0069](#)
[enum 0070](#)
[enum 0071](#)
[enum 0075](#)
[enum 0076](#)
[enum 0080](#)
[enum 0100](#)
[enum 0102](#)
[enum 0103](#)
[enum 0104](#)
[enum 0105](#)
[enum 0106](#)
[enum 0107](#)
[enum 0110](#)
[enum 0111](#)
[enum 0112](#)
[enum 0113](#)
[enum 0114](#)
[enum 0116](#)
[enum 0118](#)
[enum 0120](#)
[enum 0121](#)
[enum 0122](#)
[enum 0123](#)
[enum 0124](#)
[enum 0126](#)
[enum 0128](#)
[enum 0130](#)
[enum 0131](#)
[enum 0190](#)
[enum 0191](#)
[enum 0200](#)
[enum 0202](#)
[enum 0204](#)
[enum 0206](#)
[enum 0210](#)
[enum 0211](#)
[enum 0212](#)
[enum 0220](#)
[enum 0222](#)
[enum 0230](#)
[enum 0252](#)
[enum 0254](#)
[enum 0256](#)
[enum 0262](#)
[enum 0264](#)
[enum 0266](#)
[enum 0270](#)
[enum 0271](#)
[enum 0290](#)
[enum 0291](#)
[enum 0300](#)
[enum 0302](#)
[enum 0318](#)
[enum 0320](#)
[enum 0322](#)
[enum 0324](#)
[enum 0330](#)
[enum 0338](#)
[enum 0339](#)

[enum 0341](#)
[enum 0342](#)
[enum 0343](#)
[enum 0346](#)
[enum 0347](#)
[enum 0348](#)
[enum 0350](#)
[enum 0351](#)
[enum 0352](#)
[enum 0353](#)
[enum 0354](#)
[enum 0357](#)
[enum 0358](#)
[enum 0359](#)
[enum 0360](#)
[enum 0361](#)
[enum 0362](#)
[enum 0363](#)
[enum 0364](#)
[enum 0365](#)
[enum 0366](#)
[enum 0367](#)
[enum 0368](#)
[enum 0369](#)
[enum 0370](#)
[enum 0371](#)
[enum 0372](#)
[enum 0373](#)
[enum 0374](#)
[enum 0375](#)
[enum 0376](#)
[enum 0377](#)
[enum 0378](#)
[enum 0379](#)
[enum 0380](#)
[enum 0381](#)
[enum 0382](#)
[enum 0383](#)
[enum 0384](#)
[enum 0385](#)
[enum 0388](#)
[enum 0389](#)
[enum 0390](#)
[enum 0398](#)
[enum 0399](#)

schema location: <http://xml.ir-d.de/rst/schema/verbindlich/V2.1.2/Bausteine/PatientenaufnahmeBasis.xsd>
attributeFormDefault:
elementFormDefault: **unqualified**
targetNamespace: **http://xml.ir-d.de/emg**

Complex types
[PatientenaufnahmeBasis](#)

schema location: <http://xml.ir-d.de/rst/schema/verbindlich/V2.1.2/Bausteine/PatientenaufnahmeBrustimplantatBasis.xsd>
attributeFormDefault:
elementFormDefault: **unqualified**

targetNamespace: <http://xml.ir-d.de/emg>

Complex types

[PatientenaufnahmeBrustimplantatBasis](#)

schema location: <http://xml.ir-d.de/rst/schema/verbindlich/V2.1.2/Bausteine/PatientenaufnahmeKardiologie.xsd>

attributeFormDefault:

elementFormDefault: **unqualified**

targetNamespace: <http://xml.ir-d.de/emg>

Complex types

[PatientenaufnahmeKardiologie](#)

schema location: <http://xml.ir-d.de/rst/schema/verbindlich/V2.1.2/Bausteine/OperationBasis.xsd>

attributeFormDefault:

elementFormDefault: **unqualified**

targetNamespace: <http://xml.ir-d.de/emg>

Complex types

[OperationBasis](#)

schema location: <http://xml.ir-d.de/rst/schema/verbindlich/V2.1.2/Bausteine/OperationBrustimplantat.xsd>

attributeFormDefault:

elementFormDefault: **unqualified**

targetNamespace: <http://xml.ir-d.de/emg>

Complex types

[OperationBrustimplantat](#)

schema location: <http://xml.ir-d.de/rst/schema/verbindlich/V2.1.2/Bausteine/OperationEndoprothese.xsd>

attributeFormDefault:

elementFormDefault: **unqualified**

targetNamespace: <http://xml.ir-d.de/emg>

Complex types

[OperationEndoprothese](#)

schema location: <http://xml.ir-d.de/rst/schema/verbindlich/V2.1.2/Bausteine/OperationAortenklappe.xsd>

attributeFormDefault:

elementFormDefault: **unqualified**

targetNamespace: **<http://xml.ir-d.de/emg>**

Complex types

[OperationAortenklappe](#)

schema location: **<http://xml.ir-d.de/rst/schema/verbindlich/V2.1.2/Bausteine/Artikelidentifikation.xsd>**

attributeFormDefault:

elementFormDefault:

unqualified

targetNamespace: **<http://xml.ir-d.de/emg>**

Complex types

[Artikelidentifikation](#)

schema location: **<http://xml.ir-d.de/rst/schema/verbindlich/V2.1.2/Bausteine/Zubehoer.xsd>**

attributeFormDefault:

elementFormDefault:

unqualified

targetNamespace: **<http://xml.ir-d.de/emg>**

Complex types

[Zubehoer](#)

schema location: **<http://xml.ir-d.de/rst/schema/verbindlich/V2.1.2/Bausteine/EntlassungBasis.xsd>**

attributeFormDefault:

elementFormDefault:

unqualified

targetNamespace: **<http://xml.ir-d.de/emg>**

Complex types

[EntlassungBasis](#)

schema location: **<http://xml.ir-d.de/rst/schema/verbindlich/V2.1.2/Bausteine/DiagnoseBrustimplantatBasis.xsd>**

attributeFormDefault:

elementFormDefault:

unqualified

targetNamespace: **<http://xml.ir-d.de/emg>**

Complex types

[DiagnoseBrustimplantatBasis](#)

schema location: **<http://xml.ir-d.de/rst/schema/verbindlich/V2.1.2/Bausteine/DiagnoseEndoprotheseBasis.xsd>**

attributeFormDefault:

elementFormDefault:

unqualified

targetNamespace: **<http://xml.ir-d.de/emg>**

Complex types

[DiagnoseEndoprotheseBasis](#)

schema location: **<http://xml.ir-d.de/rst/schema/verbindlich/V2.1.2/Bausteine/DiagnoseAortenklappeBasis.xsd>**

attributeFormDefault:

elementFormDefault: **unqualified**

targetNamespace: **<http://xml.ir-d.de/emg>**

Complex types

[DiagnoseAortenklappeBasis](#)

schema location: **<http://xml.ir-d.de/rst/schema/verbindlich/V2.1.2/Bausteine/PostoperationAortenklappeBasis.xsd>**

attributeFormDefault:

elementFormDefault: **unqualified**

targetNamespace: **<http://xml.ir-d.de/emg>**

Complex types

[PostoperationAortenklappeBasis](#)

schema location: **<http://xml.ir-d.de/rst/schema/verbindlich/V2.1.2/Bausteine/AntikoagulansAortenklappeBasis.xsd>**

attributeFormDefault:

elementFormDefault: **unqualified**

targetNamespace: **<http://xml.ir-d.de/emg>**

Complex types

[AntikoagulansAortenklappeBasis](#)

schema location: **<http://xml.ir-d.de/rst/schema/verbindlich/V2.1.2/Bausteine/PatientenaufnahmeKardiologieBasis.xsd>**

attributeFormDefault:

elementFormDefault: **unqualified**

targetNamespace: **<http://xml.ir-d.de/emg>**

Complex types

[PatientenaufnahmeKardiologieBasis](#)

schema location: **<http://xml.ir-d.de/rst/schema/verbindlich/V2.1.2/Bausteine/PatientenaufnahmeAortenklappe.xsd>**

attributeFormDefault:

elementFormDefault: **unqualified**

targetNamespace: <http://xml.ir-d.de/emg>

Complex types

[PatientenaufnahmeAortenklappe](#)

schema location: <http://xml.ir-d.de/rst/schema/verbindlich/V2.1.2/Bausteine/OperationBrustimplantatBasis.xsd>

attributeFormDefault:

elementFormDefault: **unqualified**

targetNamespace: <http://xml.ir-d.de/emg>

Complex types

[OperationBrustimplantatBasis](#)

schema location: <http://xml.ir-d.de/rst/schema/verbindlich/V2.1.2/Bausteine/VorbehandlungBrustimplantatBasis.xsd>

attributeFormDefault:

elementFormDefault: **unqualified**

targetNamespace: <http://xml.ir-d.de/emg>

Complex types

[VorbehandlungBrustimplantatBasis](#)

schema location: <http://xml.ir-d.de/rst/schema/verbindlich/V2.1.2/Bausteine/MassnahmeBrustimplantatBasis.xsd>

attributeFormDefault:

elementFormDefault: **unqualified**

targetNamespace: <http://xml.ir-d.de/emg>

Complex types

[MassnahmeBrustimplantatBasis](#)

schema location: <http://xml.ir-d.de/rst/schema/verbindlich/V2.1.2/Bausteine/OperationsdetailBrustimplantatBasis.xsd>

attributeFormDefault:

elementFormDefault: **unqualified**

targetNamespace: <http://xml.ir-d.de/emg>

Complex types

[OperationsdetailBrustimplantatBasis](#)

schema location: <http://xml.ir-d.de/rst/schema/verbindlich/V2.1.2/Bausteine/BefundBrustimplantatBasis.xsd>

attributeFormDefault:

elementFormDefault: **unqualified**

targetNamespace: **http://xml.ir-d.de/emg**

Complex types

[BefundBrustimplantatBasis](#)

schema location: **<http://xml.ir-d.de/rst/schema/verbindlich/V2.1.2/Bausteine/ProzedurenSchluesselBrustimplantatBasis.xsd>**

attributeFormDefault

:

elementFormDefault: **unqualified**

targetNamespace: **http://xml.ir-d.de/emg**

Complex types

[ProzedurenSchluesselBrustimplantatBasis](#)

schema location: **<http://xml.ir-d.de/rst/schema/verbindlich/V2.1.2/Bausteine/OperationEndoprotheseBasis.xsd>**

attributeFormDefault:

elementFormDefault: **unqualified**

targetNamespace: **http://xml.ir-d.de/emg**

Complex types

[OperationEndoprotheseBasis](#)

schema location: **<http://xml.ir-d.de/rst/schema/verbindlich/V2.1.2/Bausteine/VorbehandlungEndoprotheseBasis.xsd>**

attributeFormDefault:

elementFormDefault: **unqualified**

targetNamespace: **http://xml.ir-d.de/emg**

Complex types

[VorbehandlungEndoprotheseBasis](#)

schema location: **<http://xml.ir-d.de/rst/schema/verbindlich/V2.1.2/Bausteine/ProzedurenSchluesselEndoprotheseBasis.xsd>**

attributeFormDefault

:

elementFormDefault: **unqualified**

targetNamespace: **http://xml.ir-d.de/emg**

Complex types

[ProzedurenSchluesselEndoprotheseBasis](#)

schema location: <http://xml.ir-d.de/rst/schema/verbindlich/V2.1.2/Bausteine/OperationAortenklappeBasis.xsd>
attributeFormDefault:
elementFormDefault: **unqualified**
targetNamespace: **http://xml.ir-d.de/emg**

Complex types
[OperationAortenklappeBasis](#)

schema location: <http://xml.ir-d.de/rst/schema/verbindlich/V2.1.2/Bausteine/TaviAortenklappeBasis.xsd>
attributeFormDefault:
elementFormDefault: **unqualified**
targetNamespace: **http://xml.ir-d.de/emg**

Complex types
[TaviAortenklappeBasis](#)

schema location: <http://xml.ir-d.de/rst/schema/verbindlich/V2.1.2/Bausteine/ProzedurenSchluesselAortenklappeBasis.xsd>
attributeFormDefault:
:
elementFormDefault: **unqualified**
targetNamespace: **http://xml.ir-d.de/emg**

Complex types
[ProzedurenSchluesselAortenklappeBasis](#)

schema location: <http://xml.ir-d.de/rst/schema/verbindlich/V2.1.2/Bausteine/FailureGrundAortenklappeBasis.xsd>
attributeFormDefault:
elementFormDefault: **unqualified**
targetNamespace: **http://xml.ir-d.de/emg**

Complex types
[FailureGrundAortenklappeBasis](#)

schema location: <http://xml.ir-d.de/rst/schema/verbindlich/V2.1.2/Bausteine/PciAortenklappeBasis.xsd>
attributeFormDefault:
elementFormDefault: **unqualified**
targetNamespace: **http://xml.ir-d.de/emg**

Complex types
[PciAortenklappeBasis](#)

schema location: <http://xml.ir-d.de/rst/schema/verbindlich/V2.1.2/Bausteine/KomplikationAortenklappeBasis.xsd>
attributeFormDefault:
elementFormDefault: **unqualified**
targetNamespace: **http://xml.ir-d.de/emg**

Complex types
[KomplikationAortenklappeBasis](#)

schema location: <http://xml.ir-d.de/rst/schema/verbindlich/V2.1.2/Bausteine/ArtikelidentifikationBasis.xsd>
attributeFormDefault:
elementFormDefault: **unqualified**
targetNamespace: **http://xml.ir-d.de/emg**

Complex types
[ArtikelidentifikationBasis](#)

schema location: <http://xml.ir-d.de/rst/schema/verbindlich/V2.1.2/Bausteine/Artikelbeschreibung.xsd>
attributeFormDefault:
elementFormDefault: **unqualified**
targetNamespace: **http://xml.ir-d.de/emg**

Complex types
[Artikelbeschreibung](#)

schema location: <http://xml.ir-d.de/rst/schema/verbindlich/V2.1.2/Bausteine/ZubehoerBasis.xsd>
attributeFormDefault:
elementFormDefault: **unqualified**
targetNamespace: **http://xml.ir-d.de/emg**

Complex types
[ZubehoerBasis](#)

schema location: <http://xml.ir-d.de/rst/schema/verbindlich/V2.1.2/Bausteine/ZubehoerBrustimplantatBasis.xsd>
attributeFormDefault:
elementFormDefault: **unqualified**
targetNamespace: **http://xml.ir-d.de/emg**

Complex types
[ZubehoerBrustimplantatBasis](#)

schema location: <http://xml.ir-d.de/rst/schema/verbindlich/V2.1.2/Bausteine/ZubehoerEndoprotheseBasis.xsd>
attributeFormDefault:
elementFormDefault: **unqualified**
targetNamespace: **http://xml.ir-d.de/emg**

Complex types
[ZubehoerEndoprotheseBasis](#)

schema location: <http://xml.ir-d.de/rst/schema/verbindlich/V2.1.2/Bausteine/PatientenaufnahmeAortenklappeBasis.xsd>
attributeFormDefault:
elementFormDefault: **unqualified**
targetNamespace: **http://xml.ir-d.de/emg**

Complex types
[PatientenaufnahmeAortenklappeBasis](#)

schema location: <http://xml.ir-d.de/rst/schema/verbindlich/V2.1.2/Bausteine/InfektionAortenklappeBasis.xsd>
attributeFormDefault:
elementFormDefault: **unqualified**
targetNamespace: **http://xml.ir-d.de/emg**

Complex types
[InfektionAortenklappeBasis](#)

schema location: <http://xml.ir-d.de/rst/schema/verbindlich/V2.1.2/Bausteine/ArtikelbeschreibungBasis.xsd>
attributeFormDefault:
elementFormDefault: **unqualified**
targetNamespace: **http://xml.ir-d.de/emg**

Complex types
[ArtikelbeschreibungBasis](#)

schema location: <http://xml.ir-d.de/rst/schema/verbindlich/V2.1.2/Bausteine/ArtikelBrustimplantatBasis.xsd>
attributeFormDefault:
elementFormDefault: **unqualified**
targetNamespace: **http://xml.ir-d.de/emg**

Complex types
[ArtikelBrustimplantatBasis](#)

schema location: <http://xml.ir-d.de/rst/schema/verbindlich/V2.1.2/Bausteine/ArtikelEndoprotheseBasis.xsd>
 attributeFormDefault:
 elementFormDefault: **unqualified**
 targetNamespace: **http://xml.ir-d.de/emg**

Complex types
[ArtikelEndoprotheseBasis](#)

schema location: <http://xml.ir-d.de/rst/schema/verbindlich/V2.1.2/Bausteine/ArtikelAortenklappeBasis.xsd>
 attributeFormDefault:
 elementFormDefault: **unqualified**
 targetNamespace: **http://xml.ir-d.de/emg**

Complex types
[ArtikelAortenklappeBasis](#)

element **GEMeldung**

| | |
|------------|--|
| diagram | <p>Meldung einer implantatbezogenen Massnahme nach § 16 IRegG. Hier: Meldung/Korrektur der Gesundheitseinrichtung an die Registerstelle. Die Meldung muss wohlgeformt und im Sinne dieses Schemas gültig sein. ...</p> |
| namespace | http://xml.ir-d.de/rst |
| type | emg:GeMeldung |
| properties | content complex |
| children | meldung |
| annotation | <p>documentation Meldung einer implantatbezogenen Massnahme nach § 16 IRegG. Hier: Meldung/Korrektur der Gesundheitseinrichtung an die Registerstelle. Die Meldung muss wohlgeformt und im Sinne dieses Schemas gültig sein.</p> |
| source | <pre> <element name="GEMeldung" type="emg:GeMeldung"> <annotation> <documentation>Meldung einer implantatbezogenen Massnahme nach § 16 IRegG. Hier: Meldung/Korrektur der Gesundheitseinrichtung an die Registerstelle. Die Meldung muss wohlgeformt und im Sinne dieses Schemas gültig sein. </documentation> </annotation> </element> </pre> |

element **GESelbstauskunft**

| | |
|------------|---|
| diagram | |
| namespace | http://xml.ir-d.de/rst |
| type | sak:Geselbstauskunft |
| properties | content complex |
| children | meldung |
| annotation | documentation Selbstauskunftersuchen an die Registerstelle. |
| source | <pre> <element name="GESelbstauskunft" type="sak:Geselbstauskunft"> <annotation> <documentation>Selbstauskunftersuchen an die Registerstelle.</documentation> </annotation> </element> </pre> |

element **GEStorno**

| | |
|------------|---|
| diagram | |
| namespace | http://xml.ir-d.de/rst |
| type | stn:GeStorno |
| properties | content complex |
| children | meldung |
| annotation | documentation Stornierung einer Meldung mit allen evtl. erfolgten Korrekturen der Gesundheitseinrichtung an die Registerstelle. |
| source | <pre> <element name="GEStorno" type="stn:GeStorno"> <annotation> <documentation>Stornierung einer Meldung mit allen evtl. erfolgten Korrekturen der Gesundheitseinrichtung an die Registerstelle.</documentation> </annotation> </element> </pre> |

element IRDMeldungAntwort

| | |
|------------|--|
| diagram | |
| namespace | http://xml.ir-d.de/rst |
| type | irdma:meldungAntwort |
| properties | content complex |
| children | meldung empfangsbestaetigung fehler warnung bestaetigung |
| annotation | documentation Antwort der Registerstelle auf eine Meldung/Korrektur der Gesundheitseinrichtung. |
| source | <pre> <element name="IRDMeldungAntwort" type="irdma:meldungAntwort"> <annotation> <documentation>Antwort der Registerstelle auf eine Meldung/Korrektur der Gesundheitseinrichtung.</documentation> </annotation> </element> </pre> |

element IRDSelbstauskunftAntwort

| | |
|------------|--|
| diagram | |
| namespace | http://xml.ir-d.de/rst |
| type | irdsaa:selbstauskunftAntwort |
| properties | content complex |
| children | meldung empfangsbestaetigung |
| annotation | documentation Antwort der Registerstelle auf ein Selbstauskunftersuchen der Gesundheitseinrichtung. |
| source | <pre> <element name="IRDSelbstauskunftAntwort" type="irdsaa:selbstauskunftAntwort"> </pre> |

| | |
|--|---|
| | <pre> <annotation> <documentation>Antwort der Registerstelle auf ein Selbstauskunftersuchen der Gesundheitseinrichtung.</documentation> </annotation> </element> </pre> |
|--|---|

element IRDStornoAntwort

| | |
|------------|--|
| diagram | |
| namespace | http://xml.ir-d.de/rst |
| type | irdsa:stornoAntwort |
| properties | content complex |
| children | meldung empfangsbestaetigung fehler |
| annotation | documentation Antwort der Registerstelle auf ein Storno einer Meldung mit allen evtl. erfolgten Korrekturen der Gesundheitseinrichtung. |
| source | <pre> <element name="IRDStornoAntwort" type="irdsa:stornoAntwort"> <annotation> <documentation>Antwort der Registerstelle auf ein Storno einer Meldung mit allen evtl. erfolgten Korrekturen der Gesundheitseinrichtung.</documentation> </annotation> </element> </pre> |

complexType GeMeldung

| | |
|-----------|--|
| diagram | |
| namespace | http://xml.ir-d.de/emg |
| children | meldung |
| used by | element GEMeldung |
| source | <pre> <complexType name="GeMeldung"> <sequence> <element name="meldung" type="emg:Meldung"/> </sequence> </complexType> </pre> |

element **GeMeldung/meldung**

| | |
|------------|---|
| diagram | |
| type | Meldung |
| properties | content complex |
| children | MEL_IrdIdGesundheitseinrichtung MEL_StandortId MEL_Bsnr MEL_IrdSpezVersion MEL_SwName MEL_SwHersteller MEL_SwVersion fall |
| source | <code><element name="meldung" type="emg:Meldung"/></code> |

complexType **GeStorno**

| | |
|-----------|--|
| diagram | |
| namespace | http://xml.ir-d.de/stn |
| children | meldung |
| used by | element GeStorno |
| source | <pre> <complexType name="GeStorno"> <sequence> <element name="meldung" type="stn:Storno"/> </sequence> </complexType> </pre> |

element **GeStorno/meldung**

| | |
|------------|--|
| diagram | |
| type | Storno |
| properties | content complex |
| children | MEL_IrdIdGesundheitseinrichtung fall |
| source | <code><element name="meldung" type="stn:Storno"/></code> |

complexType **meldungAntwort**

| | |
|-----------|---|
| diagram | |
| namespace | http://xml.ir-d.de/irdma |
| children | meldung empfangsbestaetigung fehler warnung bestaetigung |
| used by | element IRDMeldungAntwort |
| source | <pre> <complexType name="meldungAntwort"> <sequence> <element name="meldung" type="irdma:MeldungIrd"/> <element name="empfangsbestaetigung" type="irdma:EmpfangsbestaetigungBasis"/> <choice> <element name="fehler" type="irdma:HinweisBasis" maxOccurs="unbounded"/> <element name="warnung" type="irdma:Warnung"/> <element name="bestaetigung" type="irdma:BestaetigungBasis"/> </choice> </sequence> </complexType> </pre> |

element **meldungAntwort/meldung**

| | |
|------------|--|
| diagram | |
| type | MeldungIrd |
| properties | content complex |
| children | MEL_IrdIdGesundheitseinrichtung fall |
| source | <code><element name="meldung" type="irdma:MeldungIrd"/></code> |

element **meldungAntwort/empfangsbestaetigung**

| | |
|------------|--|
| diagram | |
| type | EmpfangsbestaetigungBasis |
| properties | content complex |
| children | EBG_Empfangsbestaetigung EBG_DatumZeitEmpfang |
| source | <code><element name="empfangsbestaetigung" type="irdma:EmpfangsbestaetigungBasis"/></code> |

element **meldungAntwort/fehler**

| | |
|------------|---|
| diagram | |
| type | HinweisBasis |
| properties | minOcc 1 maxOcc unbounded content complex |
| children | HNW_Datenelement HNW_Meldung HNW_Wert |
| source | <code><element name="fehler" type="irdma:HinweisBasis" maxOccurs="unbounded"/></code> |

element **meldungAntwort/warnung**

| | |
|------------|---|
| diagram | |
| type | Warnung |
| properties | content complex |
| children | bestaetigung hinweis |
| source | <code><element name="warnung" type="irdma:Warnung"/></code> |

element **meldungAntwort/bestaetigung**

| | |
|------------|---|
| diagram | |
| type | BestaetigungBasis |
| properties | content complex |
| children | BEG Meldebestaetigung ID BEG DatumZeitMeldebestaetigung BEG AusloesendeOpsListe BEG Produktzuordnung BEG Hash String BEG Hash Wert |
| source | <code><element name="bestaetigung" type="irdma:BestaetigungBasis"/></code> |

complexType **stornoAntwort**

| | |
|-----------|--|
| diagram | |
| namespace | http://xml.ir-d.de/irdsa |
| children | meldung empfangsbestaetigung fehler |
| used by | element IRDSstornoAntwort |
| source | <pre> <complexType name="stornoAntwort"> <sequence> <element name="meldung" type="irdsa:Storno"/> <element name="empfangsbestaetigung" type="irdsa:EmpfangsbestaetigungBasis"/> <element name="fehler" type="irdsa:HinweisBasis" minOccurs="0" </pre> |

```

maxOccurs="unbounded"/>
</sequence>
</complexType>

```

element **stornoAntwort/meldung**

| | |
|------------|--|
| diagram | |
| type | Storno |
| properties | content complex |
| children | MEL_IrdIdGesundheitseinrichtung fall |
| source | <code><element name="meldung" type="irdsa:Storno"/></code> |

element **stornoAntwort/empfangsbestaetigung**

| | |
|------------|--|
| diagram | |
| type | EmpfangsbestaetigungBasis |
| properties | content complex |
| children | EBG_Empfangsbestaetigung EBG_DatumZeitEmpfang |
| source | <code><element name="empfangsbestaetigung" type="irdsa:EmpfangsbestaetigungBasis"/></code> |

element **stornoAntwort/fehler**

| | |
|------------|---|
| diagram | |
| type | HinweisBasis |
| properties | minOcc 0 maxOcc unbounded content complex |
| children | HNW_Datenelement HNW_Meldung HNW_Wert |
| source | <code><element name="fehler" type="irdsa:HinweisBasis" minOccurs="0" maxOccurs="unbounded"/></code> |

complexType **GeSelbstauskunft**

| | |
|-----------|--|
| diagram | |
| namespace | http://xml.ir-d.de/sak |
| children | meldung |
| used by | element GESelbstauskunft |
| source | <pre><complexType name="GeSelbstauskunft"> <sequence> <element name="meldung" type="sak:Selbstauskunft"/> </sequence> </complexType></pre> |

element **GeSelbstauskunft/meldung**

| | |
|---------|--------------------------------|
| diagram | |
| type | Selbstauskunft |

| | |
|------------|--|
| properties | content complex |
| children | MEL_IrdIdGesundheitseinrichtung fall |
| source | <code><element name="meldung" type="sak:Selbstauskunft"/></code> |

complexType **selbstauskunftAntwort**

| | |
|-----------|---|
| diagram | |
| namespace | http://xml.ir-d.de/irdsaa |
| children | meldung empfangsbestaetigung |
| used by | element IRDSelbstauskunftAntwort |
| source | <pre> <complexType name="selbstauskunftAntwort"> <sequence> <element name="meldung" type="irdsaa:Selbstauskunft"/> <element name="empfangsbestaetigung" type="irdsaa:EmpfangsbestaetigungBasis"/> </sequence> </complexType> </pre> |

element **selbstauskunftAntwort/meldung**

| | |
|------------|---|
| diagram | |
| type | Selbstauskunft |
| properties | content complex |
| children | MEL_IrdIdGesundheitseinrichtung fall |
| source | <code><element name="meldung" type="irdsaa:Selbstauskunft"/></code> |

element **selbstauskunftAntwort/empfangsbestaetigung**

| | |
|------------|---|
| diagram | |
| type | EmpfangsbestaetigungBasis |
| properties | content complex |
| children | EBG_Empfangsbestaetigung EBG_DatumZeitEmpfang |
| source | <code><element name="empfangsbestaetigung" type="irdsaa:EmpfangsbestaetigungBasis"/></code> |

complexType **Meldung**

| | |
|-----------|---|
| diagram | |
| namespace | http://xml.ir-d.de/emg |
| type | extension of MeldungBasis |

| | |
|------------|--|
| properties | base MeldungBasis |
| children | MEL IrdIdGesundheitseinrichtung MEL StandortId MEL Bsnr MEL IrdSpezVersion MEL SwName MEL SwHersteller MEL SwVersion fall |
| used by | element GeMeldung/meldung |
| source | <pre> <complexType name="Meldung"> <complexContent> <extension base="MeldungBasis"> <sequence> <element name="fall" type="Fall"/> </sequence> </extension> </complexContent> </complexType> </pre> |

element **Meldung/fall**

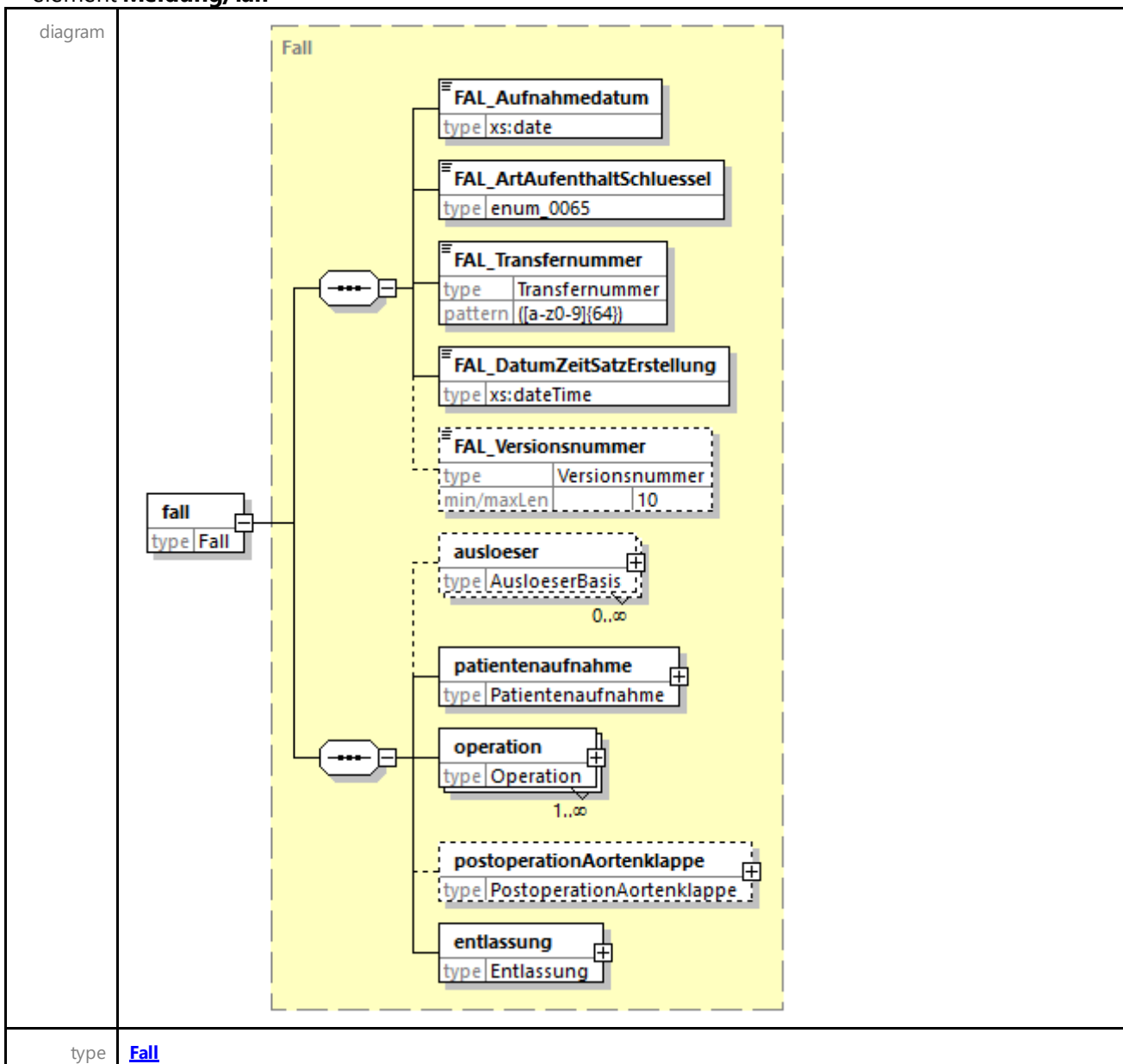

| | |
|------------|---|
| properties | content complex |
| children | FAL_Aufnahmedatum FAL_ArtAufenthaltSchluessel FAL_Transfernummer FAL_DatumZeitSatzErstellung FAL_Versionsnummer ausloeser patientenaufnahme operation postoperationAortenklappe entlassung |
| source | <code><element name="fall" type="Fall"/></code> |

complexType **Storno**

| | |
|------------|---|
| diagram | |
| namespace | http://xml.ir-d.de/stn |
| type | extension of MeldungIrdBasis |
| properties | base MeldungIrdBasis |
| children | MEL_IrdIdGesundheitseinrichtung fall |
| used by | element GeStorno/meldung |
| source | <pre> <complexType name="Storno"> <complexContent> <extension base="MeldungIrdBasis"> <sequence> <element name="fall" type="StornoFallBasis"/> </sequence> </extension> </complexContent> </complexType> </pre> |

element **Storno/fall**

| | |
|------------|--|
| diagram | |
| type | StornoFallBasis |
| properties | content complex |
| children | FAL_Transfernummer FAL_Aufnahmedatum |
| source | <code><element name="fall" type="StornoFallBasis"/></code> |

complexType MeldungIrd

| | |
|------------|---|
| diagram | |
| namespace | http://xml.ir-d.de/irdma |
| type | extension of MeldungIrdBasis |
| properties | base MeldungIrdBasis |
| children | MEL_IrdIdGesundheitseinrichtung fall |
| used by | element meldungAntwort/meldung |
| source | <pre> <complexType name="MeldungIrd"> <complexContent> <extension base="MeldungIrdBasis"> <sequence> <element name="fall" type="MeldungIrdFallBasis"/> </sequence> </extension> </complexContent> </complexType> </pre> |

element MeldungIrd/fall

| | |
|------------|--|
| diagram | |
| type | MeldungIrdFallBasis |
| properties | content complex |
| children | FAL_Transfernummer FAL_DatumZeitSatzErstellung |
| source | <pre> <element name="fall" type="MeldungIrdFallBasis"/> </pre> |

complexType **EmpfangsbestaetigungBasis**

| | |
|-----------|--|
| diagram | |
| namespace | http://xml.ir-d.de/irdma |
| children | EBG Empfangsbestaetigung EBG DatumZeitEmpfang |
| used by | element meldungAntwort/empfangsbestaetigung |
| source | <pre><complexType name="EmpfangsbestaetigungBasis"> <sequence> <element name="EBG_Empfangsbestaetigung" type="Freitext250" fixed="Hiermit wird der Eingang Ihrer Anfrage bestätigt"/> <element name="EBG_DatumZeitEmpfang" type="xs:dateTime"/> </sequence> </complexType></pre> |

element **EmpfangsbestaetigungBasis/EBG_Empfangsbestaetigung**

| diagram | | | | | | | |
|------------|--|------------|-------|------------|-----------|-----|--|
| type | Freitext250 | | | | | | |
| properties | content simple fixed Hiermit wird der Eingang Ihrer Anfrage bestätigt | | | | | | |
| facets | <table border="1"> <thead> <tr> <th>Kind</th> <th>Value</th> <th>Annotation</th> </tr> </thead> <tbody> <tr> <td>maxLength</td> <td>250</td> <td></td> </tr> </tbody> </table> | Kind | Value | Annotation | maxLength | 250 | |
| Kind | Value | Annotation | | | | | |
| maxLength | 250 | | | | | | |
| source | <pre><element name="EBG_Empfangsbestaetigung" type="Freitext250" fixed="Hiermit wird der Eingang Ihrer Anfrage bestätigt"/></pre> | | | | | | |

element **EmpfangsbestaetigungBasis/EBG_DatumZeitEmpfang**

| | |
|------------|--|
| diagram | |
| type | dateTime |
| properties | content simple |
| source | <pre><element name="EBG_DatumZeitEmpfang" type="xs:dateTime"/></pre> |

complexType **HinweisBasis**

| | |
|-----------|---|
| diagram | |
| namespace | http://xml.ir-d.de/irdma |
| children | HNW_Datenelement HNW Meldung HNW Wert |
| used by | elements meldungAntwort/fehler Warnung/hinweis |
| source | <pre><complexType name="HinweisBasis"> <sequence> <element name="HNW_Datenelement" type="Freitext500"/> <element name="HNW_Meldung" type="Freitext500"/> <element name="HNW_Wert" type="Freitext500"/> </sequence> </complexType></pre> |

element **HinweisBasis/HNW_Datenelement**

| diagram | | | | | | | |
|------------|--|------------|-------|------------|-----------|-----|--|
| type | Freitext500 | | | | | | |
| properties | content simple | | | | | | |
| facets | <table border="1"> <thead> <tr> <th>Kind</th> <th>Value</th> <th>Annotation</th> </tr> </thead> <tbody> <tr> <td>maxLength</td> <td>500</td> <td></td> </tr> </tbody> </table> | Kind | Value | Annotation | maxLength | 500 | |
| Kind | Value | Annotation | | | | | |
| maxLength | 500 | | | | | | |
| source | <pre><element name="HNW_Datenelement" type="Freitext500"/></pre> | | | | | | |

element **HinweisBasis/HNW_Meldung**

| diagram | | | | | | | |
|------------|--|------------|-------|------------|-----------|-----|--|
| type | Freitext500 | | | | | | |
| properties | content simple | | | | | | |
| facets | <table border="1"> <thead> <tr> <th>Kind</th> <th>Value</th> <th>Annotation</th> </tr> </thead> <tbody> <tr> <td>maxLength</td> <td>500</td> <td></td> </tr> </tbody> </table> | Kind | Value | Annotation | maxLength | 500 | |
| Kind | Value | Annotation | | | | | |
| maxLength | 500 | | | | | | |
| source | <pre><element name="HNW_Meldung" type="Freitext500"/></pre> | | | | | | |

element **HinweisBasis/HNW_Wert**

| | | | | | | | |
|------------|--|------------|-------|------------|-----------|-----|--|
| diagram |  | | | | | | |
| type | Freitext500 | | | | | | |
| properties | content simple | | | | | | |
| facets | <table border="1"> <tr> <td>Kind</td> <td>Value</td> <td>Annotation</td> </tr> <tr> <td>maxLength</td> <td>500</td> <td></td> </tr> </table> | Kind | Value | Annotation | maxLength | 500 | |
| Kind | Value | Annotation | | | | | |
| maxLength | 500 | | | | | | |
| source | <code><element name="HNW_Wert" type="Freitext500"/></code> | | | | | | |

complexType **Warnung**

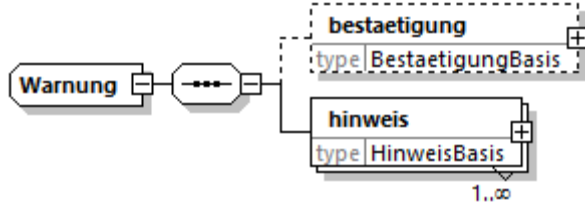
| | |
|-----------|---|
| diagram |  |
| namespace | http://xml.ir-d.de/irdma |
| children | bestaetigung hinweis |
| used by | element meldungAntwort/warnung |
| source | <pre> <complexType name="Warnung"> <sequence> <element name="bestaetigung" type="BestaetigungBasis" minOccurs="0"/> <element name="hinweis" type="HinweisBasis" maxOccurs="unbounded"/> </sequence> </complexType> </pre> |

element **Warnung/bestaetigung**

| | |
|------------|---|
| diagram | |
| type | BestaetigungBasis |
| properties | minOcc 0 maxOcc 1 content complex |
| children | BEG Meldebestaetigung ID BEG DatumZeitMeldebestaetigung BEG AusloesendeOpsListe BEG Produktzuordnung BEG Hash String BEG Hash Wert |
| source | <code><element name="bestaetigung" type="BestaetigungBasis" minOccurs="0"/></code> |

element **Warnung/hinweis**

| | |
|------------|---|
| diagram | |
| type | HinweisBasis |
| properties | minOcc 1 maxOcc unbounded content complex |

| | |
|----------|--|
| children | HNW Datenelement HNW Meldung HNW Wert |
| source | <code><element name="hinweis" type="HinweisBasis" maxOccurs="unbounded"/></code> |

complexType **BestaetigungBasis**

| | |
|-----------|---|
| diagram | |
| namespace | http://xml.ir-d.de/irdma |
| children | BEG Meldebestaetigung ID BEG DatumZeitMeldebestaetigung BEG AusloesendeOpsListe BEG Produktzuordnung BEG Hash String BEG Hash Wert |
| used by | elements meldungAntwort/bestaetigung Warnung/bestaetigung |
| source | <pre> <complexType name="BestaetigungBasis"> <sequence> <element name="BEG_Meldebestaetigung_ID" type="Meldebestaetigung"/> <element name="BEG_DatumZeitMeldebestaetigung" type="xs:dateTime"/> <element name="BEG_AusloesendeOpsListe" type="Freitext250" minOccurs="0"/> <element name="BEG_Produktzuordnung" type="xs:boolean"/> <element name="BEG_Hash_String" type="HashString"/> <element name="BEG_Hash_Wert" type="HashWert"/> </sequence> </complexType> </pre> |

element **BestaetigungBasis/BEG_Meldebestaetigung_ID**

| | |
|------------|------------------------------------|
| diagram | |
| type | Meldebestaetigung |
| properties | content simple |
| facets | Kind Value Annotation length 10 |

| | |
|--------|--|
| source | <code><element name="BEG_Meldebestaetigung_ID" type="Meldebestaetigung"/></code> |
|--------|--|

element **BestaetigungBasis/BEG_DatumZeitMeldebestaetigung**

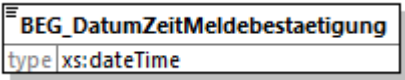
| | |
|------------|--|
| diagram |  |
| type | dateTime |
| properties | content simple |
| source | <code><element name="BEG_DatumZeitMeldebestaetigung" type="xs:dateTime"/></code> |

element **BestaetigungBasis/BEG_AusloesendeOpsListe**

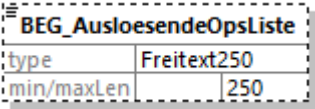
| | |
|------------|---|
| diagram |  |
| type | Freitext250 |
| properties | minOcc 0 maxOcc 1 content simple |
| facets | Kind Value Annotation maxLength 250 |
| source | <code><element name="BEG_AusloesendeOpsListe" type="Freitext250" minOccurs="0"/></code> |

element **BestaetigungBasis/BEG_Produktzuordnung**

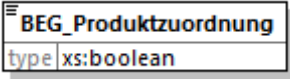
| | |
|------------|---|
| diagram |  |
| type | boolean |
| properties | content simple |
| source | <code><element name="BEG_Produktzuordnung" type="xs:boolean"/></code> |

element **BestaetigungBasis/BEG_Hash_String**

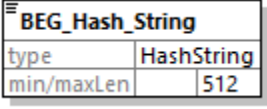
| | |
|------------|---|
| diagram |  |
| type | HashString |
| properties | content simple |
| facets | Kind Value Annotation maxLength 512 |
| source | <code><element name="BEG_Hash_String" type="HashString"/></code> |

element **BestaetigungBasis/BEG_Hash_Wert**

| | |
|------------|--|
| diagram | |
| type | HashWert |
| properties | content simple |
| facets | Kind Value Annotation length 64 |
| source | <code><element name="BEG_Hash_Wert" type="HashWert"/></code> |

complexType **Storno**

| | |
|------------|---|
| diagram | |
| namespace | http://xml.ir-d.de/irdsa |
| type | extension of MeldungIrdBasis |
| properties | base MeldungIrdBasis |
| children | MEL_IrdIdGesundheitseinrichtung fall |
| used by | element stornoAntwort/meldung |
| source | <pre> <complexType name="Storno"> <complexContent> <extension base="MeldungIrdBasis"> <sequence> <element name="fall" type="StornoFallBasis"/> </sequence> </extension> </complexContent> </complexType> </pre> |

element **Storno/fall**

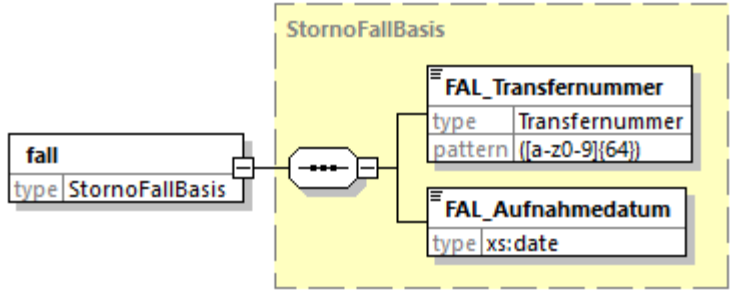
| | |
|------------|--|
| diagram |  |
| type | StornoFallBasis |
| properties | content complex |
| children | FAL Transfernummer FAL Aufnahmedatum |
| source | <code><element name="fall" type="StornoFallBasis"/></code> |

complexType **EmpfangsbestaetigungBasis**

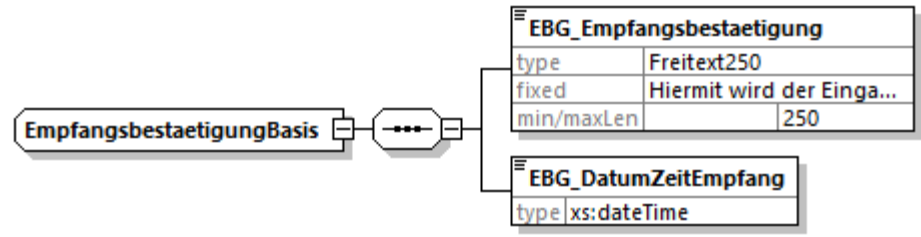
| | |
|-----------|--|
| diagram |  |
| namespace | http://xml.ir-d.de/irdsa |
| children | EBG Empfangsbestaetigung EBG DatumZeitEmpfang |
| used by | element stornoAntwort/empfangsbestaetigung |
| source | <pre> <complexType name="EmpfangsbestaetigungBasis"> <sequence> <element name="EBG_Empfangsbestaetigung" type="Freitext250" fixed="Hiermit wird der Eingang Ihrer Anfrage bestätigt"/> <element name="EBG_DatumZeitEmpfang" type="xs:dateTime"/> </sequence> </complexType> </pre> |

element **EmpfangsbestaetigungBasis/EBG_Empfangsbestaetigung**

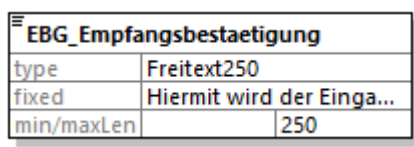
| diagram |  | | | | | | |
|------------|--|------------|-------|------------|-----------|-----|--|
| type | Freitext250 | | | | | | |
| properties | content simple fixed Hiermit wird der Eingang Ihrer Anfrage bestätigt | | | | | | |
| facets | <table border="1"> <thead> <tr> <th>Kind</th> <th>Value</th> <th>Annotation</th> </tr> </thead> <tbody> <tr> <td>maxLength</td> <td>250</td> <td></td> </tr> </tbody> </table> | Kind | Value | Annotation | maxLength | 250 | |
| Kind | Value | Annotation | | | | | |
| maxLength | 250 | | | | | | |
| source | <code><element name="EBG_Empfangsbestaetigung" type="Freitext250" fixed="Hiermit wird</code> | | | | | | |

der Eingang Ihrer Anfrage bestätigt"/>

element **EmpfangsbestaetigungBasis/EBG_DatumZeitEmpfang**

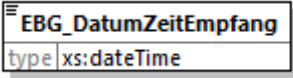
| | | | |
|------------|---|------|-------------|
| diagram |  <p>The diagram shows a box for the element EBG_DatumZeitEmpfang with a table below it containing the following information:</p> <table border="1"><tr><td>type</td><td>xs:dateTime</td></tr></table> | type | xs:dateTime |
| type | xs:dateTime | | |
| type | dateTime | | |
| properties | content simple | | |
| source | <code><element name="EBG_DatumZeitEmpfang" type="xs:dateTime"/></code> | | |

complexType **HinweisBasis**

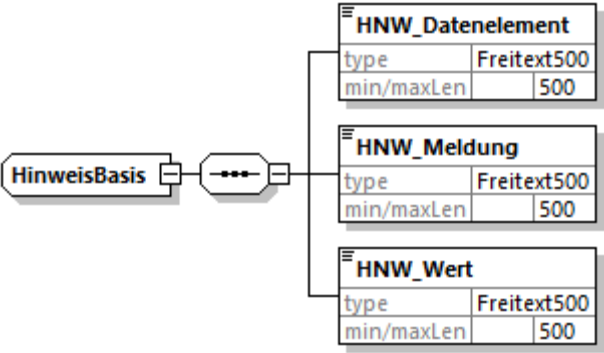
| | | | | | |
|------------|---|------|-------------|------------|-----|
| diagram |  <p>The diagram shows a complex type HinweisBasis connected to a sequence container. The sequence contains three elements: HNW_Datenelement, HNW_Meldung, and HNW_Wert. Each element is represented by a box with a table below it containing the following information:</p> <table border="1"><tr><td>type</td><td>Freitext500</td></tr><tr><td>min/maxLen</td><td>500</td></tr></table> | type | Freitext500 | min/maxLen | 500 |
| type | Freitext500 | | | | |
| min/maxLen | 500 | | | | |
| namespace | http://xml.ir-d.de/irdsa | | | | |
| children | HNW_Datenelement HNW_Meldung HNW_Wert | | | | |
| used by | element stornoAntwort/fehler | | | | |
| source | <pre><complexType name="HinweisBasis"> <sequence> <element name="HNW_Datenelement" type="Freitext500"/> <element name="HNW_Meldung" type="Freitext500"/> <element name="HNW_Wert" type="Freitext500"/> </sequence> </complexType></pre> | | | | |

element **HinweisBasis/HNW_Datenelement**

| | | | | | |
|------------|---|------|-------------|------------|-----|
| diagram |  <p>The diagram shows a box for the element HNW_Datenelement with a table below it containing the following information:</p> <table border="1"><tr><td>type</td><td>Freitext500</td></tr><tr><td>min/maxLen</td><td>500</td></tr></table> | type | Freitext500 | min/maxLen | 500 |
| type | Freitext500 | | | | |
| min/maxLen | 500 | | | | |
| type | Freitext500 | | | | |
| properties | content simple | | | | |
| facets | Kind Value Annotation maxLength 500 | | | | |
| source | <code><element name="HNW_Datenelement" type="Freitext500"/></code> | | | | |

element HinweisBasis/HNW_Meldung

| diagram | | | | | | | |
|------------|--|------------|-------|------------|-----------|-----|--|
| type | Freitext500 | | | | | | |
| properties | content simple | | | | | | |
| facets | <table border="1"> <thead> <tr> <th>Kind</th> <th>Value</th> <th>Annotation</th> </tr> </thead> <tbody> <tr> <td>maxLength</td> <td>500</td> <td></td> </tr> </tbody> </table> | Kind | Value | Annotation | maxLength | 500 | |
| Kind | Value | Annotation | | | | | |
| maxLength | 500 | | | | | | |
| source | <code><element name="HNW_Meldung" type="Freitext500"/></code> | | | | | | |

element HinweisBasis/HNW_Wert

| diagram | | | | | | | |
|------------|--|------------|-------|------------|-----------|-----|--|
| type | Freitext500 | | | | | | |
| properties | content simple | | | | | | |
| facets | <table border="1"> <thead> <tr> <th>Kind</th> <th>Value</th> <th>Annotation</th> </tr> </thead> <tbody> <tr> <td>maxLength</td> <td>500</td> <td></td> </tr> </tbody> </table> | Kind | Value | Annotation | maxLength | 500 | |
| Kind | Value | Annotation | | | | | |
| maxLength | 500 | | | | | | |
| source | <code><element name="HNW_Wert" type="Freitext500"/></code> | | | | | | |

complexType Selbstauskunft

| | |
|------------|---|
| diagram | |
| namespace | http://xml.ir-d.de/sak |
| type | extension of MeldungIrdBasis |
| properties | base MeldungIrdBasis |
| children | MEL_IrdIdGesundheitseinrichtung fall |
| used by | element GeSelbstauskunft/meldung |
| source | <pre> <complexType name="Selbstauskunft"> <complexContent> <extension base="MeldungIrdBasis"> <sequence> <element name="fall" type="SelbstauskunftFallBasis"/> </sequence> </extension> </complexContent> </complexType> </pre> |

```
</complexContent>
</complexType>
```

element **Selbstauskunft/fall**

| | |
|------------|--|
| diagram | |
| type | SelbstauskunftFallBasis |
| properties | content complex |
| children | FAL_Transfernummer |
| source | <code><element name="fall" type="SelbstauskunftFallBasis"/></code> |

complexType **Selbstauskunft**

| | |
|------------|---|
| diagram | |
| namespace | http://xml.ir-d.de/irdsaa |
| type | extension of MeldungIrdBasis |
| properties | base MeldungIrdBasis |
| children | MEL_IrdIdGesundheitseinrichtung fall |
| used by | element selbstauskunftAntwort/meldung |
| source | <pre><complexType name="Selbstauskunft"> <complexContent> <extension base="MeldungIrdBasis"> <sequence> <element name="fall" type="SelbstauskunftFallBasis"/> </sequence> </extension> </complexContent> </complexType></pre> |

element **Selbstauskunft/fall**

| | |
|------------|--|
| diagram | |
| type | SelbstauskunftFallBasis |
| properties | content complex |
| children | FAL_Transfernummer |
| source | <code><element name="fall" type="SelbstauskunftFallBasis"/></code> |

complexType **EmpfangsbestaetigungBasis**

| | |
|-----------|--|
| diagram | |
| namespace | http://xml.ir-d.de/irdsaa |
| children | EBG_Empfangsbestaetigung EBG_DatumZeitEmpfang |
| used by | element selbstauskunftAntwort/empfangsbestaetigung |
| source | <pre> <complexType name="EmpfangsbestaetigungBasis"> <sequence> <element name="EBG_Empfangsbestaetigung" type="Freitext250" fixed="Hiermit wird der Eingang Ihrer Anfrage bestätigt"/> <element name="EBG_DatumZeitEmpfang" type="xs:dateTime"/> </sequence> </complexType> </pre> |

element **EmpfangsbestaetigungBasis/EBG_Empfangsbestaetigung**

| diagram | | | | | | | |
|------------|--|------------|-------|------------|-----------|-----|--|
| type | Freitext250 | | | | | | |
| properties | content simple fixed Hiermit wird der Eingang Ihrer Anfrage bestätigt | | | | | | |
| facets | <table border="1"> <thead> <tr> <th>Kind</th> <th>Value</th> <th>Annotation</th> </tr> </thead> <tbody> <tr> <td>maxLength</td> <td>250</td> <td></td> </tr> </tbody> </table> | Kind | Value | Annotation | maxLength | 250 | |
| Kind | Value | Annotation | | | | | |
| maxLength | 250 | | | | | | |
| source | <code><element name="EBG_Empfangsbestaetigung" type="Freitext250" fixed="Hiermit wird der Eingang Ihrer Anfrage bestätigt"/></code> | | | | | | |

element **EmpfangsbestaetigungBasis/EBG_DatumZeitEmpfang**

| | |
|------------|--|
| diagram | |
| type | dateTime |
| properties | content simple |
| source | <code><element name="EBG_DatumZeitEmpfang" type="xs:dateTime"/></code> |

complexType **MeldungBasis**

| | |
|-----------|--|
| diagram | |
| namespace | http://xml.ir-d.de/emg |
| children | MEL_IrdIdGesundheitseinrichtung MEL_StandortId MEL_Bsnr MEL_IrdSpezVersion MEL_SwName MEL_SwHersteller MEL_SwVersion |
| used by | complexType Meldung |
| source | <pre> <complexType name="MeldungBasis"> <sequence> <element name="MEL_IrdIdGesundheitseinrichtung" type="IdEinrichtung"/> <element name="MEL_StandortId" type="xs:token" minOccurs="0"/> <element name="MEL_Bsnr" type="xs:token" minOccurs="0"/> <element name="MEL_IrdSpezVersion" type="IrdSpezVersion"/> <element name="MEL_SwName" type="Sw"/> <element name="MEL_SwHersteller" type="Sw"/> <element name="MEL_SwVersion" type="Sw"/> </sequence> </complexType> </pre> |

element **MeldungBasis/MEL_IrdIdGesundheitseinrichtung**

| diagram |  | | | | | | |
|------------|--|------------|-------|------------|---------|-------------------|--|
| type | IdEinrichtung | | | | | | |
| properties | content simple | | | | | | |
| facets | <table border="1"> <thead> <tr> <th>Kind</th> <th>Value</th> <th>Annotation</th> </tr> </thead> <tbody> <tr> <td>pattern</td> <td>(IRD-GE-[0-9]{8})</td> <td></td> </tr> </tbody> </table> | Kind | Value | Annotation | pattern | (IRD-GE-[0-9]{8}) | |
| Kind | Value | Annotation | | | | | |
| pattern | (IRD-GE-[0-9]{8}) | | | | | | |
| source | <code><element name="MEL_IrdIdGesundheitseinrichtung" type="IdEinrichtung"/></code> | | | | | | |

element **MeldungBasis/MEL_StandortId**

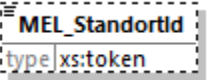
| | | | | | | | |
|------------|--|--------|---|--------|---|---------|--------|
| diagram |  | | | | | | |
| type | token | | | | | | |
| properties | <table border="1"> <tbody> <tr> <td>minOcc</td> <td>0</td> </tr> <tr> <td>maxOcc</td> <td>1</td> </tr> <tr> <td>content</td> <td>simple</td> </tr> </tbody> </table> | minOcc | 0 | maxOcc | 1 | content | simple |
| minOcc | 0 | | | | | | |
| maxOcc | 1 | | | | | | |
| content | simple | | | | | | |
| source | <code><element name="MEL_StandortId" type="xs:token" minOccurs="0"/></code> | | | | | | |

element **MeldungBasis/MEL_Bsnr**

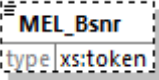
| | | | | | | | |
|------------|--|--------|---|--------|---|---------|--------|
| diagram |  | | | | | | |
| type | token | | | | | | |
| properties | <table border="1"> <tbody> <tr> <td>minOcc</td> <td>0</td> </tr> <tr> <td>maxOcc</td> <td>1</td> </tr> <tr> <td>content</td> <td>simple</td> </tr> </tbody> </table> | minOcc | 0 | maxOcc | 1 | content | simple |
| minOcc | 0 | | | | | | |
| maxOcc | 1 | | | | | | |
| content | simple | | | | | | |
| source | <code><element name="MEL_Bsnr" type="xs:token" minOccurs="0"/></code> | | | | | | |

element **MeldungBasis/MEL_IrdSpezVersion**

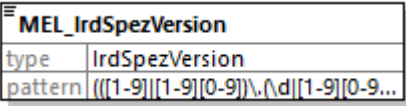
| diagram |  | | | | | | |
|------------|---|------------|-------|------------|---------|--|--|
| type | IrdSpezVersion | | | | | | |
| properties | content simple | | | | | | |
| facets | <table border="1"> <thead> <tr> <th>Kind</th> <th>Value</th> <th>Annotation</th> </tr> </thead> <tbody> <tr> <td>pattern</td> <td>((([1-9] [1-9][0-9])\.\d [1-9][0-9])\.\d [1-9][0-9])</td> <td></td> </tr> </tbody> </table> | Kind | Value | Annotation | pattern | ((([1-9] [1-9][0-9])\.\d [1-9][0-9])\.\d [1-9][0-9]) | |
| Kind | Value | Annotation | | | | | |
| pattern | ((([1-9] [1-9][0-9])\.\d [1-9][0-9])\.\d [1-9][0-9]) | | | | | | |
| source | <code><element name="MEL_IrdSpezVersion" type="IrdSpezVersion"/></code> | | | | | | |

element **MeldungBasis/MEL_SwName**

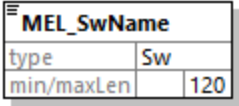
| | | | | | | | |
|------------|--|------------|-------|------------|-----------|-----|--|
| diagram |  | | | | | | |
| type | Sw | | | | | | |
| properties | content simple | | | | | | |
| facets | <table border="1"> <tr> <td>Kind</td> <td>Value</td> <td>Annotation</td> </tr> <tr> <td>maxLength</td> <td>120</td> <td></td> </tr> </table> | Kind | Value | Annotation | maxLength | 120 | |
| Kind | Value | Annotation | | | | | |
| maxLength | 120 | | | | | | |
| source | <code><element name="MEL_SwName" type="Sw"/></code> | | | | | | |

element **MeldungBasis/MEL_SwHersteller**

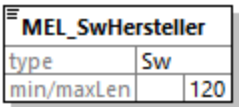
| | | | | | | | |
|------------|--|------------|-------|------------|-----------|-----|--|
| diagram |  | | | | | | |
| type | Sw | | | | | | |
| properties | content simple | | | | | | |
| facets | <table border="1"> <tr> <td>Kind</td> <td>Value</td> <td>Annotation</td> </tr> <tr> <td>maxLength</td> <td>120</td> <td></td> </tr> </table> | Kind | Value | Annotation | maxLength | 120 | |
| Kind | Value | Annotation | | | | | |
| maxLength | 120 | | | | | | |
| source | <code><element name="MEL_SwHersteller" type="Sw"/></code> | | | | | | |

element **MeldungBasis/MEL_SwVersion**

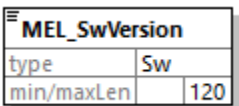
| | | | | | | | |
|------------|--|------------|-------|------------|-----------|-----|--|
| diagram |  | | | | | | |
| type | Sw | | | | | | |
| properties | content simple | | | | | | |
| facets | <table border="1"> <tr> <td>Kind</td> <td>Value</td> <td>Annotation</td> </tr> <tr> <td>maxLength</td> <td>120</td> <td></td> </tr> </table> | Kind | Value | Annotation | maxLength | 120 | |
| Kind | Value | Annotation | | | | | |
| maxLength | 120 | | | | | | |
| source | <code><element name="MEL_SwVersion" type="Sw"/></code> | | | | | | |

complexType **Fall**

| | |
|-------------------|---|
| <p>diagram</p> | |
| <p>namespace</p> | <p>http://xml.ir-d.de/emg</p> |
| <p>type</p> | <p>extension of FallBasis</p> |
| <p>properties</p> | <p>base FallBasis</p> |
| <p>children</p> | <p>FAL Aufnahmedatum FAL ArtAufenthaltSchluessel FAL Transfernummer FAL DatumZeitSatzErstellung FAL Versionsnummer ausloeser patientenaufnahme operation postoperationAortenklappe entlassung</p> |
| <p>used by</p> | <p>element Meldung/fall</p> |
| <p>source</p> | <pre><complexType name="Fall"> <complexContent> <extension base="FallBasis"> <sequence> <element name="ausloeser" type="AusloeserBasis" minOccurs="0" maxOccurs="unbounded"/> <element name="patientenaufnahme" type="Patientenaufnahme"/> <element name="operation" type="Operation" maxOccurs="unbounded"/> <element name="postoperationAortenklappe" type="PostoperationAortenklappe" minOccurs="0"/> <element name="entlassung" type="Entlassung"/> </sequence> </extension> </complexContent> </complexType></pre> |

```

</sequence>
</extension>
</complexContent>
</complexType>

```

element Fall/ausloeser

| | |
|------------|--|
| diagram | |
| type | AusloeserBasis |
| properties | minOcc 0 maxOcc unbounded content complex |
| children | ALR_ProzedurenSchluessel |
| source | <code><element name="ausloeser" type="AusloeserBasis" minOccurs="0" maxOccurs="unbounded"/></code> |

element Fall/patientenaufnahme

| | |
|------------|---|
| diagram | |
| type | Patientenaufnahme |
| properties | content complex |
| children | PAT Alter PAT Groesse PAT Gewicht PAT GeschlechtSchluessel patientenaufnahmeBrustimplantat patientenaufnahmeKardiologie |
| source | <code><element name="patientenaufnahme" type="Patientenaufnahme"/></code> |

element **Fall/operation**

| | |
|-------------------|--|
| <p>diagram</p> | |
| <p>type</p> | <p>Operation</p> |
| <p>properties</p> | <p>minOcc 1 maxOcc unbounded content complex</p> |
| <p>children</p> | <p>OPE LaufendeNummer OPE Datum OPE SeitenLokalisationSchluessel OPE AsaSchluessel OPE ImplantattypSchluessel operationBrustimplantat operationEndoprothese operationAortenklappe artikelidentifikation zubehoer</p> |
| <p>source</p> | <pre><element name="operation" type="Operation" maxOccurs="unbounded"/></pre> |

element Fall/postoperationAortenklappe

diagram

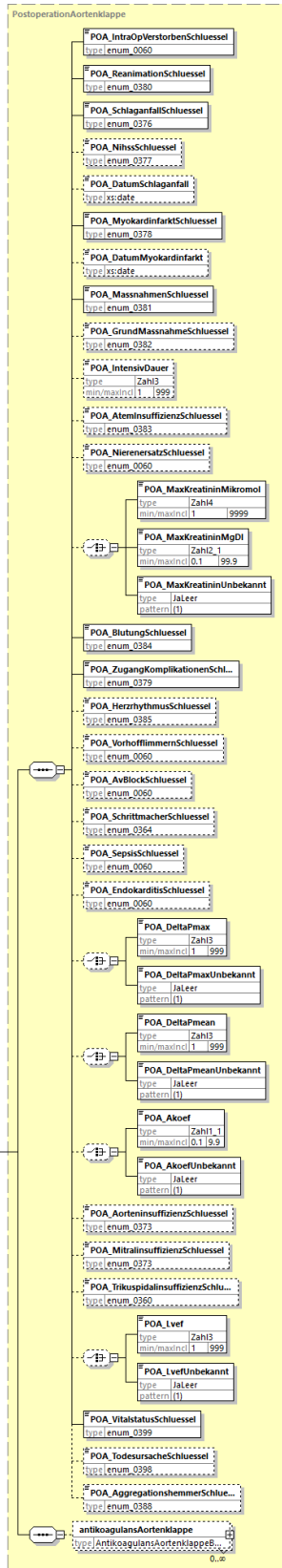

PostoperationAortenklappe
type PostoperationAortenklappe

| | |
|------------|---|
| type | PostoperationAortenklappe |
| properties | minOcc 0 maxOcc 1 content complex |

| | |
|----------|--|
| children | POA IntraOpVerstorbenSchluessel POA ReanimationSchluessel POA SchlaganfallSchluessel POA NihssSchluessel POA DatumSchlaganfall POA MyokardinfarktSchluessel POA DatumMyokardinfarkt POA MassnahmenSchluessel POA GrundMassnahmeSchluessel POA IntensivDauer POA AtemInsuffizienzSchluessel POA NierenersatzSchluessel POA MaxKreatininMikromol POA MaxKreatininMgDI POA MaxKreatininUnbekannt POA BlutungSchluessel POA ZugangKomplikationenSchluessel POA HerzrhythmusSchluessel POA VorhofflimmernSchluessel POA AvBlockSchluessel POA SchrittmacherSchluessel POA SepsisSchluessel POA EndokarditisSchluessel POA DeltaPmax POA DeltaPmaxUnbekannt POA DeltaPmean POA DeltaPmeanUnbekannt POA Akoef POA AkoefUnbekannt POA AorteninsuffizienzSchluessel POA MitralinsuffizienzSchluessel POA TrikuspidalinsuffizienzSchluessel POA Lvef POA LvefUnbekannt POA VitalstatusSchluessel POA TodesursacheSchluessel POA AggregationshemmerSchluessel antikoagulansAortenklappe |
| source | <pre><element name="postoperationAortenklappe" type="PostoperationAortenklappe" minOccurs="0"/></pre> |

element **Fall/entlassung**

| | |
|------------|--|
| diagram | |
| type | Entlassung |
| properties | content complex |
| children | ENT_Datum ENT_GrundSchluessel diagnoseBrustimplantat diagnoseEndoprothese diagnoseAortenklappe |
| source | <pre><element name="entlassung" type="Entlassung"/></pre> |

simpleType **DatumText**

| | | | | | | | |
|------------|--|------------|-------|------------|---------|---------------------------------------|--|
| namespace | http://xml.ir-d.de/stn | | | | | | |
| type | restriction of token | | | | | | |
| properties | base xs:token | | | | | | |
| facets | <table border="0"> <tr> <td>Kind</td> <td>Value</td> <td>Annotation</td> </tr> <tr> <td>pattern</td> <td>((([0-9]{4})([0-9]{2})?([0-9]{2})?)?)</td> <td></td> </tr> </table> | Kind | Value | Annotation | pattern | ((([0-9]{4})([0-9]{2})?([0-9]{2})?)?) | |
| Kind | Value | Annotation | | | | | |
| pattern | ((([0-9]{4})([0-9]{2})?([0-9]{2})?)?) | | | | | | |
| annotation | documentation Facette zur Festlegung des freien Datumformats: JJJJ[-MM][-TT] | | | | | | |

| | |
|--------|---|
| source | <pre> <simpleType name="DatumText"> <annotation> <documentation>Facette zur Festlegung des freien Datumformats: JJJJ[-MM[-TT]]</documentation> </annotation> <restriction base="xs:token"> <pattern value="((([0-9]{4})([-][0-9]{2})?([-][0-9]{2})?)"/> </restriction> </simpleType> </pre> |
|--------|---|

simpleType **Freitext250**

| namespace | http://xml.ir-d.de/stn | | | | | | |
|------------|--|------------|-------|------------|-----------|-----|--|
| type | restriction of token | | | | | | |
| properties | base xs:token | | | | | | |
| facets | <table border="1"> <thead> <tr> <th>Kind</th> <th>Value</th> <th>Annotation</th> </tr> </thead> <tbody> <tr> <td>maxLength</td> <td>250</td> <td></td> </tr> </tbody> </table> | Kind | Value | Annotation | maxLength | 250 | |
| Kind | Value | Annotation | | | | | |
| maxLength | 250 | | | | | | |
| annotation | documentation Facette zur Festlegung des Freitextes von 250 Zeichen | | | | | | |
| source | <pre> <simpleType name="Freitext250"> <annotation> <documentation>Facette zur Festlegung des Freitextes von 250 Zeichen</documentation> </annotation> <restriction base="xs:token"> <maxLength value="250"/> </restriction> </simpleType> </pre> | | | | | | |

simpleType **Freitext500**

| namespace | http://xml.ir-d.de/stn | | | | | | |
|------------|--|------------|-------|------------|-----------|-----|--|
| type | restriction of token | | | | | | |
| properties | base xs:token | | | | | | |
| facets | <table border="1"> <thead> <tr> <th>Kind</th> <th>Value</th> <th>Annotation</th> </tr> </thead> <tbody> <tr> <td>maxLength</td> <td>500</td> <td></td> </tr> </tbody> </table> | Kind | Value | Annotation | maxLength | 500 | |
| Kind | Value | Annotation | | | | | |
| maxLength | 500 | | | | | | |
| annotation | documentation Facette zur Festlegung des Freitextes von 500 Zeichen | | | | | | |
| source | <pre> <simpleType name="Freitext500"> <annotation> <documentation>Facette zur Festlegung des Freitextes von 500 Zeichen</documentation> </annotation> <restriction base="xs:token"> <maxLength value="500"/> </restriction> </simpleType> </pre> | | | | | | |

simpleType **HashString**

| | |
|-----------|------------------------|
| namespace | http://xml.ir-d.de/stn |
|-----------|------------------------|

| type | restriction of token | | | | | | |
|------------|--|------------|-------|------------|-----------|-----|--|
| properties | base xs:token | | | | | | |
| facets | <table border="1"> <thead> <tr> <th>Kind</th> <th>Value</th> <th>Annotation</th> </tr> </thead> <tbody> <tr> <td>maxLength</td> <td>512</td> <td></td> </tr> </tbody> </table> | Kind | Value | Annotation | maxLength | 512 | |
| Kind | Value | Annotation | | | | | |
| maxLength | 512 | | | | | | |
| annotation | documentation Facette zur Festlegung des Hash-Strings der Meldebestätigung | | | | | | |
| source | <pre><simpleType name="HashString"> <annotation> <documentation>Facette zur Festlegung des Hash-Strings der Meldebestätigung</documentation> </annotation> <restriction base="xs:token"> <maxLength value="512"/> </restriction> </simpleType></pre> | | | | | | |

simpleType HashWert

| namespace | http://xml.ir-d.de/stn | | | | | | |
|------------|--|------------|-------|------------|--------|----|--|
| type | restriction of token | | | | | | |
| properties | base xs:token | | | | | | |
| facets | <table border="1"> <thead> <tr> <th>Kind</th> <th>Value</th> <th>Annotation</th> </tr> </thead> <tbody> <tr> <td>length</td> <td>64</td> <td></td> </tr> </tbody> </table> | Kind | Value | Annotation | length | 64 | |
| Kind | Value | Annotation | | | | | |
| length | 64 | | | | | | |
| annotation | documentation Facette zur Festlegung des Hashwertes der Meldebestätigung | | | | | | |
| source | <pre><simpleType name="HashWert"> <annotation> <documentation>Facette zur Festlegung des Hashwertes der Meldebestätigung</documentation> </annotation> <restriction base="xs:token"> <length value="64"/> </restriction> </simpleType></pre> | | | | | | |

simpleType ICD

| namespace | http://xml.ir-d.de/stn | | | | | | |
|------------|--|------------|-------|------------|---------|--|--|
| type | restriction of token | | | | | | |
| properties | base xs:token | | | | | | |
| facets | <table border="1"> <thead> <tr> <th>Kind</th> <th>Value</th> <th>Annotation</th> </tr> </thead> <tbody> <tr> <td>pattern</td> <td>([a-zA-Z][0-9]{2}\.[0-9]{1,2})?(:[RLB])?</td> <td></td> </tr> </tbody> </table> | Kind | Value | Annotation | pattern | ([a-zA-Z][0-9]{2}\.[0-9]{1,2})?(:[RLB])? | |
| Kind | Value | Annotation | | | | | |
| pattern | ([a-zA-Z][0-9]{2}\.[0-9]{1,2})?(:[RLB])? | | | | | | |
| annotation | documentation Facette zur Festlegung des ICD Code | | | | | | |
| source | <pre><simpleType name="ICD"> <annotation> <documentation>Facette zur Festlegung des ICD Code</documentation> </annotation> <restriction base="xs:token"> <pattern value="([a-zA-Z][0-9]{2}\.[0-9]{1,2})?(:[RLB])?" /> </restriction> </simpleType></pre> | | | | | | |

| | |
|--|----------------------------------|
| | <code></simpleType></code> |
|--|----------------------------------|

simpleType IdEinrichtung

| namespace | http://xml.ir-d.de/stn | | | | | | |
|------------|---|------------|-------|------------|---------|-------------------|--|
| type | restriction of token | | | | | | |
| properties | base xs:token | | | | | | |
| used by | element MeldungIrdBasis/MEL IrdIdGesundheitseinrichtung | | | | | | |
| facets | <table border="1"> <thead> <tr> <th>Kind</th> <th>Value</th> <th>Annotation</th> </tr> </thead> <tbody> <tr> <td>pattern</td> <td>(IRD-GE-[0-9]{8})</td> <td></td> </tr> </tbody> </table> | Kind | Value | Annotation | pattern | (IRD-GE-[0-9]{8}) | |
| Kind | Value | Annotation | | | | | |
| pattern | (IRD-GE-[0-9]{8}) | | | | | | |
| annotation | documentation Facette zur Festlegung der Gesundheitseinrichtung-ID | | | | | | |
| source | <pre><simpleType name="IdEinrichtung"> <annotation> <documentation>Facette zur Festlegung der Gesundheitseinrichtung-ID</documentation> </annotation> <restriction base="xs:token"> <pattern value="(IRD-GE-[0-9]{8})"/> </restriction> </simpleType></pre> | | | | | | |

simpleType IrdArtikelId

| namespace | http://xml.ir-d.de/stn | | | | | | |
|------------|---|------------|-------|------------|-----------|----|--|
| type | restriction of token | | | | | | |
| properties | base xs:token | | | | | | |
| facets | <table border="1"> <thead> <tr> <th>Kind</th> <th>Value</th> <th>Annotation</th> </tr> </thead> <tbody> <tr> <td>maxLength</td> <td>16</td> <td></td> </tr> </tbody> </table> | Kind | Value | Annotation | maxLength | 16 | |
| Kind | Value | Annotation | | | | | |
| maxLength | 16 | | | | | | |
| annotation | documentation Facette zur Festlegung der IrdNummer | | | | | | |
| source | <pre><simpleType name="IrdArtikelId"> <annotation> <documentation>Facette zur Festlegung der IrdNummer</documentation> </annotation> <restriction base="xs:token"> <maxLength value="16"/> </restriction> </simpleType></pre> | | | | | | |

simpleType IrdSpezVersion

| namespace | http://xml.ir-d.de/stn | | | | | | |
|------------|--|------------|-------|------------|---------|---|--|
| type | restriction of token | | | | | | |
| properties | base xs:token | | | | | | |
| facets | <table border="1"> <thead> <tr> <th>Kind</th> <th>Value</th> <th>Annotation</th> </tr> </thead> <tbody> <tr> <td>pattern</td> <td>(([1-9][1-9][0-9])\.\d{1}[1-9][0-9]\.\d{1}[1-9][0-9])</td> <td></td> </tr> </tbody> </table> | Kind | Value | Annotation | pattern | (([1-9][1-9][0-9])\.\d{1}[1-9][0-9]\.\d{1}[1-9][0-9]) | |
| Kind | Value | Annotation | | | | | |
| pattern | (([1-9][1-9][0-9])\.\d{1}[1-9][0-9]\.\d{1}[1-9][0-9]) | | | | | | |
| annotation | documentation Facette zur Festlegung der Version der IRD-Spezifikation | | | | | | |

| | |
|--------|---|
| source | <pre> <simpleType name="IrdSpezVersion"> <annotation> <documentation>Facette zur Festlegung der Version der IRD-Spezifikation</documentation> </annotation> <restriction base="xs:token"> <pattern value="(([1-9] [1-9][0-9])\.(\\d [1-9][0-9])\.(\\d [1-9][0-9]))"/> </restriction> </simpleType> </pre> |
|--------|---|

simpleType **JaLeer**

| namespace | http://xml.ir-d.de/stn | | | | | | |
|------------|--|------------|-------|------------|---------|-----|--|
| type | restriction of integer | | | | | | |
| properties | base xs:integer | | | | | | |
| facets | <table border="1"> <thead> <tr> <th>Kind</th> <th>Value</th> <th>Annotation</th> </tr> </thead> <tbody> <tr> <td>pattern</td> <td>(1)</td> <td></td> </tr> </tbody> </table> | Kind | Value | Annotation | pattern | (1) | |
| Kind | Value | Annotation | | | | | |
| pattern | (1) | | | | | | |
| annotation | documentation Facette zur Festlegung des Unbekannt-Wertes (Bedeutung 1=true) | | | | | | |
| source | <pre> <simpleType name="JaLeer"> <annotation> <documentation>Facette zur Festlegung des Unbekannt-Wertes (Bedeutung 1=true)</documentation> </annotation> <restriction base="xs:integer"> <pattern value="(1)"/> </restriction> </simpleType> </pre> | | | | | | |

simpleType **Meldebestaetigung**

| namespace | http://xml.ir-d.de/stn | | | | | | |
|------------|--|------------|-------|------------|--------|----|--|
| type | restriction of token | | | | | | |
| properties | base xs:token | | | | | | |
| facets | <table border="1"> <thead> <tr> <th>Kind</th> <th>Value</th> <th>Annotation</th> </tr> </thead> <tbody> <tr> <td>length</td> <td>10</td> <td></td> </tr> </tbody> </table> | Kind | Value | Annotation | length | 10 | |
| Kind | Value | Annotation | | | | | |
| length | 10 | | | | | | |
| annotation | documentation Facette zur Festlegung der Meldebestätigungslaenge von 10 Zeichen | | | | | | |
| source | <pre> <simpleType name="Meldebestaetigung"> <annotation> <documentation>Facette zur Festlegung der Meldebestätigungslaenge von 10 Zeichen</documentation> </annotation> <restriction base="xs:token"> <length value="10"/> </restriction> </simpleType> </pre> | | | | | | |

simpleType **OPS**

| | |
|----------|------------------------|
| namespac | http://xml.ir-d.de/stn |
|----------|------------------------|

| e | | | | | | | |
|------------|--|------------|-------|------------|---------|---|--|
| type | restriction of token | | | | | | |
| properties | base xs:token | | | | | | |
| facets | <table border="1"> <thead> <tr> <th>Kind</th> <th>Value</th> <th>Annotation</th> </tr> </thead> <tbody> <tr> <td>pattern</td> <td>(([135689]\-([0-9]){2}([a-zA-Z0-9]){1}\.([a-zA-Z0-9]{1,2}))*(:[RLBr1b])?)</td> <td></td> </tr> </tbody> </table> | Kind | Value | Annotation | pattern | (([135689]\-([0-9]){2}([a-zA-Z0-9]){1}\.([a-zA-Z0-9]{1,2}))*(:[RLBr1b])?) | |
| Kind | Value | Annotation | | | | | |
| pattern | (([135689]\-([0-9]){2}([a-zA-Z0-9]){1}\.([a-zA-Z0-9]{1,2}))*(:[RLBr1b])?) | | | | | | |
| annotation | documentation Facette zur Festlegung des Prozedurenschlüssels | | | | | | |
| source | <pre><simpleType name="OPS"> <annotation> <documentation>Facette zur Festlegung des Prozedurenschlüssels</documentation> </annotation> <restriction base="xs:token"> <pattern value="([135689]\-([0-9]){2}([a-zA-Z0-9]){1}\.([a-zA-Z0-9]{1,2}))*(:[RLBr1b] ?)" /> </restriction> </simpleType></pre> | | | | | | |

simpleType **String2**

| namespace | http://xml.ir-d.de/stn | | | | | | |
|------------|--|------------|-------|------------|---------|------------|--|
| type | restriction of token | | | | | | |
| properties | base xs:token | | | | | | |
| facets | <table border="1"> <thead> <tr> <th>Kind</th> <th>Value</th> <th>Annotation</th> </tr> </thead> <tbody> <tr> <td>pattern</td> <td>([0-9]{2})</td> <td></td> </tr> </tbody> </table> | Kind | Value | Annotation | pattern | ([0-9]{2}) | |
| Kind | Value | Annotation | | | | | |
| pattern | ([0-9]{2}) | | | | | | |
| annotation | documentation Facette zur Festlegung des kodierten Entlassungsgrundes | | | | | | |
| source | <pre><simpleType name="String2"> <annotation> <documentation>Facette zur Festlegung des kodierten Entlassungsgrundes</documentation> </annotation> <restriction base="xs:token"> <pattern value="([0-9]{2})" /> </restriction> </simpleType></pre> | | | | | | |

simpleType **String20**

| namespace | http://xml.ir-d.de/stn | | | | | | |
|------------|---|------------|-------|------------|-----------|----|--|
| type | restriction of token | | | | | | |
| properties | base xs:token | | | | | | |
| facets | <table border="1"> <thead> <tr> <th>Kind</th> <th>Value</th> <th>Annotation</th> </tr> </thead> <tbody> <tr> <td>maxLength</td> <td>20</td> <td></td> </tr> </tbody> </table> | Kind | Value | Annotation | maxLength | 20 | |
| Kind | Value | Annotation | | | | | |
| maxLength | 20 | | | | | | |
| annotation | documentation Facette zur Festlegung von: Artikel-, Ident-, Serien-, Lot-Nummer des Produkts | | | | | | |
| source | <pre><simpleType name="String20"> <annotation> <documentation>Facette zur Festlegung von: Artikel-, Ident-, Serien-,</pre> | | | | | | |

| | |
|--|---|
| | <pre> Lot-Nummer des Produkts</documentation> </annotation> <restriction base="xs:token"> <maxLength value="20"/> </restriction> </simpleType> </pre> |
|--|---|

simpleType Sw

| namespace | http://xml.ir-d.de/stn | | | | | | |
|------------|--|------------|-------|------------|-----------|-----|--|
| type | restriction of token | | | | | | |
| properties | base xs:token | | | | | | |
| facets | <table border="1"> <thead> <tr> <th>Kind</th> <th>Value</th> <th>Annotation</th> </tr> </thead> <tbody> <tr> <td>maxLength</td> <td>120</td> <td></td> </tr> </tbody> </table> | Kind | Value | Annotation | maxLength | 120 | |
| Kind | Value | Annotation | | | | | |
| maxLength | 120 | | | | | | |
| annotation | documentation Facette für Merkmale der externen Software | | | | | | |
| source | <pre> <simpleType name="Sw"> <annotation> <documentation>Facette für Merkmale der externen Software</documentation> </annotation> <restriction base="xs:token"> <maxLength value="120"/> </restriction> </simpleType> </pre> | | | | | | |

simpleType Transfervummer

| namespace | http://xml.ir-d.de/stn | | | | | | |
|------------|--|------------|-------|------------|---------|----------------|--|
| type | restriction of token | | | | | | |
| properties | base xs:token | | | | | | |
| used by | element StornoFallBasis/FAL Transfervummer | | | | | | |
| facets | <table border="1"> <thead> <tr> <th>Kind</th> <th>Value</th> <th>Annotation</th> </tr> </thead> <tbody> <tr> <td>pattern</td> <td>([a-z0-9]{64})</td> <td></td> </tr> </tbody> </table> | Kind | Value | Annotation | pattern | ([a-z0-9]{64}) | |
| Kind | Value | Annotation | | | | | |
| pattern | ([a-z0-9]{64}) | | | | | | |
| annotation | documentation Facette zur Festlegung der Transfervummer | | | | | | |
| source | <pre> <simpleType name="Transfervummer"> <annotation> <documentation>Facette zur Festlegung der Transfervummer</documentation> </annotation> <restriction base="xs:token"> <pattern value="([a-z0-9]{64})"/> </restriction> </simpleType> </pre> | | | | | | |

simpleType Versionsnummer

| | |
|------------|-----------------------------|
| namespace | http://xml.ir-d.de/stn |
| type | restriction of token |
| properties | base xs:token |

| facets | <table border="1"> <thead> <tr> <th>Kind</th> <th>Value</th> <th>Annotation</th> </tr> </thead> <tbody> <tr> <td>maxLength</td> <td>10</td> <td></td> </tr> </tbody> </table> | Kind | Value | Annotation | maxLength | 10 | |
|------------|--|------------|-------|------------|-----------|----|--|
| Kind | Value | Annotation | | | | | |
| maxLength | 10 | | | | | | |
| annotation | documentation Facette zur Festlegung der Versionsnummer des gelieferten Datensatzes | | | | | | |
| source | <pre><simpleType name="Versionsnummer"> <annotation> <documentation>Facette zur Festlegung der Versionsnummer des gelieferten Datensatzes</documentation> </annotation> <restriction base="xs:token"> <maxLength value="10"/> </restriction> </simpleType></pre> | | | | | | |

simpleType Zahl1

| namespace | http://xml.ir-d.de/stn | | | | | | | | | |
|--------------|--|------------|-------|------------|--------------|---|--|--------------|---|--|
| type | restriction of positivInteger | | | | | | | | | |
| properties | base xs:positivInteger | | | | | | | | | |
| facets | <table border="1"> <thead> <tr> <th>Kind</th> <th>Value</th> <th>Annotation</th> </tr> </thead> <tbody> <tr> <td>minInclusive</td> <td>1</td> <td></td> </tr> <tr> <td>maxInclusive</td> <td>9</td> <td></td> </tr> </tbody> </table> | Kind | Value | Annotation | minInclusive | 1 | | maxInclusive | 9 | |
| Kind | Value | Annotation | | | | | | | | |
| minInclusive | 1 | | | | | | | | | |
| maxInclusive | 9 | | | | | | | | | |
| annotation | documentation Facette zur Festlegung der 1-stelligen Ganzzahlenwerte | | | | | | | | | |
| source | <pre><simpleType name="Zahl1"> <annotation> <documentation>Facette zur Festlegung der 1-stelligen Ganzzahlenwerte</documentation> </annotation> <restriction base="xs:positiveInteger"> <minInclusive value="1"/> <maxInclusive value="9"/> </restriction> </simpleType></pre> | | | | | | | | | |

simpleType Zahl1_1

| namespace | http://xml.ir-d.de/stn | | | | | | | | | | | | | | | |
|----------------|--|------------|-------|------------|--------------|-----|--|--------------|-----|--|-------------|---|--|----------------|---|--|
| type | restriction of decimal | | | | | | | | | | | | | | | |
| properties | base xs:decimal | | | | | | | | | | | | | | | |
| facets | <table border="1"> <thead> <tr> <th>Kind</th> <th>Value</th> <th>Annotation</th> </tr> </thead> <tbody> <tr> <td>minInclusive</td> <td>0.1</td> <td></td> </tr> <tr> <td>maxInclusive</td> <td>9.9</td> <td></td> </tr> <tr> <td>totalDigits</td> <td>2</td> <td></td> </tr> <tr> <td>fractionDigits</td> <td>1</td> <td></td> </tr> </tbody> </table> | Kind | Value | Annotation | minInclusive | 0.1 | | maxInclusive | 9.9 | | totalDigits | 2 | | fractionDigits | 1 | |
| Kind | Value | Annotation | | | | | | | | | | | | | | |
| minInclusive | 0.1 | | | | | | | | | | | | | | | |
| maxInclusive | 9.9 | | | | | | | | | | | | | | | |
| totalDigits | 2 | | | | | | | | | | | | | | | |
| fractionDigits | 1 | | | | | | | | | | | | | | | |
| annotation | documentation Facette zur Festlegung des Formats [N].[N] | | | | | | | | | | | | | | | |
| source | <pre><simpleType name="Zahl1_1"> <annotation> <documentation>Facette zur Festlegung des Formats [N].[N]</documentation> </annotation> <restriction base="xs:decimal"></pre> | | | | | | | | | | | | | | | |

| | |
|--|--|
| | <pre> <totalDigits value="2"/> <fractionDigits value="1"/> <minInclusive value="0.1"/> <maxInclusive value="9.9"/> </restriction> </simpleType> </pre> |
|--|--|

simpleType Zahl2

| namespace | http://xml.ir-d.de/stn | | | | | | | | | |
|--------------|---|------------|-------|------------|--------------|---|--|--------------|----|--|
| type | restriction of positiveInteger | | | | | | | | | |
| properties | base xs:positiveInteger | | | | | | | | | |
| facets | <table border="1"> <thead> <tr> <th>Kind</th> <th>Value</th> <th>Annotation</th> </tr> </thead> <tbody> <tr> <td>minInclusive</td> <td>1</td> <td></td> </tr> <tr> <td>maxInclusive</td> <td>99</td> <td></td> </tr> </tbody> </table> | Kind | Value | Annotation | minInclusive | 1 | | maxInclusive | 99 | |
| Kind | Value | Annotation | | | | | | | | |
| minInclusive | 1 | | | | | | | | | |
| maxInclusive | 99 | | | | | | | | | |
| annotation | documentation Facette zur Festlegung der 2-stelligen Ganzzahlenwerte | | | | | | | | | |
| source | <pre> <simpleType name="Zahl2"> <annotation> <documentation>Facette zur Festlegung der 2-stelligen Ganzzahlenwerte</documentation> </annotation> <restriction base="xs:positiveInteger"> <minInclusive value="1"/> <maxInclusive value="99"/> </restriction> </simpleType> </pre> | | | | | | | | | |

simpleType Zahl2_1

| namespace | http://xml.ir-d.de/stn | | | | | | | | | | | | | | | |
|----------------|---|------------|-------|------------|--------------|-----|--|--------------|------|--|-------------|---|--|----------------|---|--|
| type | restriction of decimal | | | | | | | | | | | | | | | |
| properties | base xs:decimal | | | | | | | | | | | | | | | |
| facets | <table border="1"> <thead> <tr> <th>Kind</th> <th>Value</th> <th>Annotation</th> </tr> </thead> <tbody> <tr> <td>minInclusive</td> <td>0.1</td> <td></td> </tr> <tr> <td>maxInclusive</td> <td>99.9</td> <td></td> </tr> <tr> <td>totalDigits</td> <td>3</td> <td></td> </tr> <tr> <td>fractionDigits</td> <td>1</td> <td></td> </tr> </tbody> </table> | Kind | Value | Annotation | minInclusive | 0.1 | | maxInclusive | 99.9 | | totalDigits | 3 | | fractionDigits | 1 | |
| Kind | Value | Annotation | | | | | | | | | | | | | | |
| minInclusive | 0.1 | | | | | | | | | | | | | | | |
| maxInclusive | 99.9 | | | | | | | | | | | | | | | |
| totalDigits | 3 | | | | | | | | | | | | | | | |
| fractionDigits | 1 | | | | | | | | | | | | | | | |
| annotation | documentation Facette zur Festlegung des Formats [NN].[N] | | | | | | | | | | | | | | | |
| source | <pre> <simpleType name="Zahl2_1"> <annotation> <documentation>Facette zur Festlegung des Formats [NN].[N]</documentation> </annotation> <restriction base="xs:decimal"> <totalDigits value="3"/> <fractionDigits value="1"/> <minInclusive value="0.1"/> <maxInclusive value="99.9"/> </restriction> </simpleType> </pre> | | | | | | | | | | | | | | | |

simpleType Zahl3

| namespace | http://xml.ir-d.de/stn | | | | | | | | | |
|--------------|--|------------|-------|------------|--------------|---|--|--------------|-----|--|
| type | restriction of positiveInteger | | | | | | | | | |
| properties | base xs:positiveInteger | | | | | | | | | |
| facets | <table border="1"> <thead> <tr> <th>Kind</th> <th>Value</th> <th>Annotation</th> </tr> </thead> <tbody> <tr> <td>minInclusive</td> <td>1</td> <td></td> </tr> <tr> <td>maxInclusive</td> <td>999</td> <td></td> </tr> </tbody> </table> | Kind | Value | Annotation | minInclusive | 1 | | maxInclusive | 999 | |
| Kind | Value | Annotation | | | | | | | | |
| minInclusive | 1 | | | | | | | | | |
| maxInclusive | 999 | | | | | | | | | |
| annotation | documentation Facette zur Festlegung der 3-stelligen Ganzzahlenwerte | | | | | | | | | |
| source | <pre><simpleType name="Zahl3"> <annotation> <documentation>Facette zur Festlegung der 3-stelligen Ganzzahlenwerte</documentation> </annotation> <restriction base="xs:positiveInteger"> <minInclusive value="1"/> <maxInclusive value="999"/> </restriction> </simpleType></pre> | | | | | | | | | |

simpleType Zahl3_1

| namespace | http://xml.ir-d.de/stn | | | | | | | | | | | | | | | |
|----------------|---|------------|-------|------------|--------------|-----|--|--------------|-------|--|-------------|---|--|----------------|---|--|
| type | restriction of decimal | | | | | | | | | | | | | | | |
| properties | base xs:decimal | | | | | | | | | | | | | | | |
| facets | <table border="1"> <thead> <tr> <th>Kind</th> <th>Value</th> <th>Annotation</th> </tr> </thead> <tbody> <tr> <td>minInclusive</td> <td>0.1</td> <td></td> </tr> <tr> <td>maxInclusive</td> <td>999.9</td> <td></td> </tr> <tr> <td>totalDigits</td> <td>4</td> <td></td> </tr> <tr> <td>fractionDigits</td> <td>1</td> <td></td> </tr> </tbody> </table> | Kind | Value | Annotation | minInclusive | 0.1 | | maxInclusive | 999.9 | | totalDigits | 4 | | fractionDigits | 1 | |
| Kind | Value | Annotation | | | | | | | | | | | | | | |
| minInclusive | 0.1 | | | | | | | | | | | | | | | |
| maxInclusive | 999.9 | | | | | | | | | | | | | | | |
| totalDigits | 4 | | | | | | | | | | | | | | | |
| fractionDigits | 1 | | | | | | | | | | | | | | | |
| annotation | documentation Facette zur Festlegung des Formats [NNN].[N] | | | | | | | | | | | | | | | |
| source | <pre><simpleType name="Zahl3_1"> <annotation> <documentation>Facette zur Festlegung des Formats [NNN].[N]</documentation> </annotation> <restriction base="xs:decimal"> <totalDigits value="4"/> <fractionDigits value="1"/> <minInclusive value="0.1"/> <maxInclusive value="999.9"/> </restriction> </simpleType></pre> | | | | | | | | | | | | | | | |

simpleType Zahl4

| | |
|------------|---------------------------------------|
| namespace | http://xml.ir-d.de/stn |
| type | restriction of positiveInteger |
| properties | base xs:positiveInteger |

| facets | <table border="1"> <thead> <tr> <th>Kind</th> <th>Value</th> <th>Annotation</th> </tr> </thead> <tbody> <tr> <td>minInclusive</td> <td>1</td> <td></td> </tr> <tr> <td>maxInclusive</td> <td>9999</td> <td></td> </tr> </tbody> </table> | Kind | Value | Annotation | minInclusive | 1 | | maxInclusive | 9999 | |
|--------------|---|------------|-------|------------|--------------|---|--|--------------|------|--|
| Kind | Value | Annotation | | | | | | | | |
| minInclusive | 1 | | | | | | | | | |
| maxInclusive | 9999 | | | | | | | | | |
| annotation | documentation Facette zur Festlegung der 4-stelligen Ganzzahlenwerte | | | | | | | | | |
| source | <pre><simpleType name="Zahl4"> <annotation> <documentation>Facette zur Festlegung der 4-stelligen Ganzzahlenwerte</documentation> </annotation> <restriction base="xs:positiveInteger"> <minInclusive value="1"/> <maxInclusive value="9999"/> </restriction> </simpleType></pre> | | | | | | | | | |

simpleType **Zahl5**

| namespace | http://xml.ir-d.de/stn | | | | | | | | | |
|--------------|--|------------|-------|------------|--------------|---|--|--------------|-------|--|
| type | restriction of positiveInteger | | | | | | | | | |
| properties | base xs:positiveInteger | | | | | | | | | |
| facets | <table border="1"> <thead> <tr> <th>Kind</th> <th>Value</th> <th>Annotation</th> </tr> </thead> <tbody> <tr> <td>minInclusive</td> <td>1</td> <td></td> </tr> <tr> <td>maxInclusive</td> <td>99999</td> <td></td> </tr> </tbody> </table> | Kind | Value | Annotation | minInclusive | 1 | | maxInclusive | 99999 | |
| Kind | Value | Annotation | | | | | | | | |
| minInclusive | 1 | | | | | | | | | |
| maxInclusive | 99999 | | | | | | | | | |
| annotation | documentation Facette zur Festlegung der 5-stelligen Ganzzahlenwerte | | | | | | | | | |
| source | <pre><simpleType name="Zahl5"> <annotation> <documentation>Facette zur Festlegung der 5-stelligen Ganzzahlenwerte</documentation> </annotation> <restriction base="xs:positiveInteger"> <minInclusive value="1"/> <maxInclusive value="99999"/> </restriction> </simpleType></pre> | | | | | | | | | |

simpleType **Zahl5mitNull**

| namespace | http://xml.ir-d.de/stn | | | | | | | | | |
|--------------|---|------------|-------|------------|--------------|---|--|--------------|-------|--|
| type | restriction of integer | | | | | | | | | |
| properties | base xs:integer | | | | | | | | | |
| facets | <table border="1"> <thead> <tr> <th>Kind</th> <th>Value</th> <th>Annotation</th> </tr> </thead> <tbody> <tr> <td>minInclusive</td> <td>0</td> <td></td> </tr> <tr> <td>maxInclusive</td> <td>99999</td> <td></td> </tr> </tbody> </table> | Kind | Value | Annotation | minInclusive | 0 | | maxInclusive | 99999 | |
| Kind | Value | Annotation | | | | | | | | |
| minInclusive | 0 | | | | | | | | | |
| maxInclusive | 99999 | | | | | | | | | |
| annotation | documentation Facette zur Festlegung der 5-stelligen Ganzzahlenwerte inklusive "0" | | | | | | | | | |
| source | <pre><simpleType name="Zahl5mitNull"> <annotation> <documentation>Facette zur Festlegung der 5-stelligen Ganzzahlenwerte inklusive "0"</documentation> </annotation></pre> | | | | | | | | | |

```

<restriction base="xs:integer">
  <minInclusive value="0"/>
  <maxInclusive value="99999"/>
</restriction>
</simpleType>

```

complexType MeldungIrdBasis

| | |
|-----------|--|
| diagram | |
| namespace | http://xml.ir-d.de/stn |
| children | MEL_IrdIdGesundheitseinrichtung |
| used by | complexType Storno |
| source | <pre> <complexType name="MeldungIrdBasis"> <sequence> <element name="MEL_IrdIdGesundheitseinrichtung" type="IdEinrichtung"/> </sequence> </complexType> </pre> |

element MeldungIrdBasis/MEL_IrdIdGesundheitseinrichtung

| diagram | | | | | | | |
|------------|--|------------|-------|------------|---------|-------------------|--|
| type | IdEinrichtung | | | | | | |
| properties | content simple | | | | | | |
| facets | <table border="1"> <thead> <tr> <th>Kind</th> <th>Value</th> <th>Annotation</th> </tr> </thead> <tbody> <tr> <td>pattern</td> <td>(IRD-GE-[0-9]{8})</td> <td></td> </tr> </tbody> </table> | Kind | Value | Annotation | pattern | (IRD-GE-[0-9]{8}) | |
| Kind | Value | Annotation | | | | | |
| pattern | (IRD-GE-[0-9]{8}) | | | | | | |
| source | <pre> <element name="MEL_IrdIdGesundheitseinrichtung" type="IdEinrichtung"/> </pre> | | | | | | |

complexType StornoFallBasis

| | |
|-----------|---|
| diagram | |
| namespace | http://xml.ir-d.de/stn |
| children | FAL Transfernummer FAL Aufnahmedatum |
| used by | element Storno/fall |
| source | <pre> <complexType name="StornoFallBasis"> <sequence> <element name="FAL Transfernummer" type="Transfernummer"/> </pre> |

| | |
|--|--|
| | <pre><element name="FAL_Aufnahmedatum" type="xs:date"/> </sequence> </complexType></pre> |
|--|--|

element **StornoFallBasis/FAL_Transfernummer**

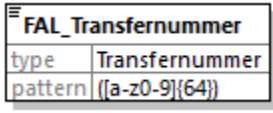
| diagram |  | | | | | | |
|------------|---|------------|-------|------------|---------|----------------|--|
| type | Transfernummer | | | | | | |
| properties | content simple | | | | | | |
| facets | <table border="1"> <thead> <tr> <th>Kind</th> <th>Value</th> <th>Annotation</th> </tr> </thead> <tbody> <tr> <td>pattern</td> <td>([a-z0-9]{64})</td> <td></td> </tr> </tbody> </table> | Kind | Value | Annotation | pattern | ([a-z0-9]{64}) | |
| Kind | Value | Annotation | | | | | |
| pattern | ([a-z0-9]{64}) | | | | | | |
| source | <pre><element name="FAL_Transfernummer" type="Transfernummer"/></pre> | | | | | | |

element **StornoFallBasis/FAL_Aufnahmedatum**

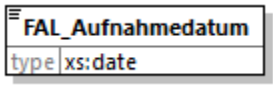
| | |
|------------|---|
| diagram |  |
| type | date |
| properties | content simple |
| source | <pre><element name="FAL_Aufnahmedatum" type="xs:date"/></pre> |

simpleType **DatumText**

| namespace | http://xml.ir-d.de/irdma | | | | | | |
|------------|--|------------|-------|------------|---------|------------------------------------|--|
| type | restriction of token | | | | | | |
| properties | base xs:token | | | | | | |
| facets | <table border="1"> <thead> <tr> <th>Kind</th> <th>Value</th> <th>Annotation</th> </tr> </thead> <tbody> <tr> <td>pattern</td> <td>(([0-9]{4})([0-9]{2})?([0-9]{2})?)</td> <td></td> </tr> </tbody> </table> | Kind | Value | Annotation | pattern | (([0-9]{4})([0-9]{2})?([0-9]{2})?) | |
| Kind | Value | Annotation | | | | | |
| pattern | (([0-9]{4})([0-9]{2})?([0-9]{2})?) | | | | | | |
| annotation | documentation Facette zur Festlegung des freien Datumformats: JJJJ[-MM[-TT]] | | | | | | |
| source | <pre><simpleType name="DatumText"> <annotation> <documentation>Facette zur Festlegung des freien Datumformats: JJJJ[-MM[-TT]]</documentation> </annotation> <restriction base="xs:token"> <pattern value="(([0-9]{4})([0-9]{2})?([0-9]{2})?)"/> </restriction> </simpleType></pre> | | | | | | |

simpleType **Freitext250**

| | |
|-----------|--------------------------|
| namespace | http://xml.ir-d.de/irdma |
|-----------|--------------------------|

| | |
|------------|--|
| type | restriction of token |
| properties | base xs:token |
| used by | elements BestaetigungBasis/BEG AusloesendeOpsListe EmpfangsbestaetigungBasis/EBG Empfangsbestaetigung |
| facets | Kind Value Annotation maxLength 250 |
| annotation | documentation Facette zur Festlegung des Freitextes von 250 Zeichen |
| source | <pre><simpleType name="Freitext250"> <annotation> <documentation>Facette zur Festlegung des Freitextes von 250 Zeichen</documentation> </annotation> <restriction base="xs:token"> <maxLength value="250"/> </restriction> </simpleType></pre> |

simpleType **Freitext500**

| | |
|------------|--|
| namespace | http://xml.ir-d.de/irdma |
| type | restriction of token |
| properties | base xs:token |
| used by | elements HinweisBasis/HNW Datenelement HinweisBasis/HNW Meldung HinweisBasis/HNW Wert |
| facets | Kind Value Annotation maxLength 500 |
| annotation | documentation Facette zur Festlegung des Freitextes von 500 Zeichen |
| source | <pre><simpleType name="Freitext500"> <annotation> <documentation>Facette zur Festlegung des Freitextes von 500 Zeichen</documentation> </annotation> <restriction base="xs:token"> <maxLength value="500"/> </restriction> </simpleType></pre> |

simpleType **HashString**

| | |
|------------|---|
| namespace | http://xml.ir-d.de/irdma |
| type | restriction of token |
| properties | base xs:token |
| used by | element BestaetigungBasis/BEG Hash String |
| facets | Kind Value Annotation maxLength 512 |
| annotation | documentation Facette zur Festlegung des Hash-Strings der Meldebestätigung |
| source | <pre><simpleType name="HashString"> <annotation></pre> |

| | |
|--|--|
| | <pre> <documentation>Facette zur Festlegung des Hash-Strings der Meldebestätigung</documentation> </annotation> <restriction base="xs:token"> <maxLength value="512"/> </restriction> </simpleType> </pre> |
|--|--|

simpleType HashWert

| | |
|------------|--|
| namespace | http://xml.ir-d.de/irdma |
| type | restriction of token |
| properties | base xs:token |
| used by | element BestaetigungBasis/BEG Hash Wert |
| facets | Kind Value Annotation length 64 |
| annotation | documentation Facette zur Festlegung des Hashwertes der Meldebestätigung |
| source | <pre> <simpleType name="HashWert"> <annotation> <documentation>Facette zur Festlegung des Hashwertes der Meldebestätigung</documentation> </annotation> <restriction base="xs:token"> <length value="64"/> </restriction> </simpleType> </pre> |

simpleType ICD

| | |
|------------|---|
| namespace | http://xml.ir-d.de/irdma |
| type | restriction of token |
| properties | base xs:token |
| facets | Kind Value Annotation pattern ([a-zA-Z][0-9]{2}(\.[0-9]{1,2})?(:[RLB])?) |
| annotation | documentation Facette zur Festlegung des ICD Code |
| source | <pre> <simpleType name="ICD"> <annotation> <documentation>Facette zur Festlegung des ICD Code</documentation> </annotation> <restriction base="xs:token"> <pattern value="([a-zA-Z][0-9]{2}(\.[0-9]{1,2})?(:[RLB])?)"/> </restriction> </simpleType> </pre> |

simpleType IdEinrichtung

| | |
|-----------|-----------------------------|
| namespace | http://xml.ir-d.de/irdma |
| type | restriction of token |

| properties | base xs:token | | | | | | |
|------------|---|------------|-------|------------|---------|-------------------|--|
| used by | element MeldungIrdBasis/MEL_IrdIdGesundheitseinrichtung | | | | | | |
| facets | <table border="1"> <thead> <tr> <th>Kind</th> <th>Value</th> <th>Annotation</th> </tr> </thead> <tbody> <tr> <td>pattern</td> <td>(IRD-GE-[0-9]{8})</td> <td></td> </tr> </tbody> </table> | Kind | Value | Annotation | pattern | (IRD-GE-[0-9]{8}) | |
| Kind | Value | Annotation | | | | | |
| pattern | (IRD-GE-[0-9]{8}) | | | | | | |
| annotation | documentation Facette zur Festlegung der Gesundheitseinrichtung-ID | | | | | | |
| source | <pre><simpleType name="IdEinrichtung"> <annotation> <documentation>Facette zur Festlegung der Gesundheitseinrichtung-ID</documentation> </annotation> <restriction base="xs:token"> <pattern value="(IRD-GE-[0-9]{8})"/> </restriction> </simpleType></pre> | | | | | | |

simpleType IrdArtikelId

| namespace | http://xml.ir-d.de/irdma | | | | | | |
|------------|---|------------|-------|------------|-----------|----|--|
| type | restriction of token | | | | | | |
| properties | base xs:token | | | | | | |
| facets | <table border="1"> <thead> <tr> <th>Kind</th> <th>Value</th> <th>Annotation</th> </tr> </thead> <tbody> <tr> <td>maxLength</td> <td>16</td> <td></td> </tr> </tbody> </table> | Kind | Value | Annotation | maxLength | 16 | |
| Kind | Value | Annotation | | | | | |
| maxLength | 16 | | | | | | |
| annotation | documentation Facette zur Festlegung der IrdNummer | | | | | | |
| source | <pre><simpleType name="IrdArtikelId"> <annotation> <documentation>Facette zur Festlegung der IrdNummer</documentation> </annotation> <restriction base="xs:token"> <maxLength value="16"/> </restriction> </simpleType></pre> | | | | | | |

simpleType IrdSpezVersion

| namespace | http://xml.ir-d.de/irdma | | | | | | |
|------------|---|------------|-------|------------|---------|---|--|
| type | restriction of token | | | | | | |
| properties | base xs:token | | | | | | |
| facets | <table border="1"> <thead> <tr> <th>Kind</th> <th>Value</th> <th>Annotation</th> </tr> </thead> <tbody> <tr> <td>pattern</td> <td>(([1-9] [1-9][0-9])\.\d{1}[0-9])\.\d{1}[0-9])</td> <td></td> </tr> </tbody> </table> | Kind | Value | Annotation | pattern | (([1-9] [1-9][0-9])\.\d{1}[0-9])\.\d{1}[0-9]) | |
| Kind | Value | Annotation | | | | | |
| pattern | (([1-9] [1-9][0-9])\.\d{1}[0-9])\.\d{1}[0-9]) | | | | | | |
| annotation | documentation Facette zur Festlegung der Version der IRD-Spezifikation | | | | | | |
| source | <pre><simpleType name="IrdSpezVersion"> <annotation> <documentation>Facette zur Festlegung der Version der IRD-Spezifikation</documentation> </annotation> <restriction base="xs:token"> <pattern value="(([1-9] [1-9][0-9])\.\d{1}[0-9])\.\d{1}[0-9]"/> </restriction> </simpleType></pre> | | | | | | |

| | |
|--|----------------------------------|
| | <code></simpleType></code> |
|--|----------------------------------|

simpleType **JaLeer**

| namespace | http://xml.ir-d.de/irdma | | | | | | |
|------------|--|------------|-------|------------|---------|-----|--|
| type | restriction of integer | | | | | | |
| properties | base xs:integer | | | | | | |
| facets | <table border="1"> <tr> <th>Kind</th> <th>Value</th> <th>Annotation</th> </tr> <tr> <td>pattern</td> <td>(1)</td> <td></td> </tr> </table> | Kind | Value | Annotation | pattern | (1) | |
| Kind | Value | Annotation | | | | | |
| pattern | (1) | | | | | | |
| annotation | documentation Facette zur Festlegung des Unbekannt-Wertes (Bedeutung 1=true) | | | | | | |
| source | <pre> <simpleType name="JaLeer"> <annotation> <documentation>Facette zur Festlegung des Unbekannt-Wertes (Bedeutung 1=true)</documentation> </annotation> <restriction base="xs:integer"> <pattern value="(1)"/> </restriction> </simpleType> </pre> | | | | | | |

simpleType **Meldebestaetigung**

| namespace | http://xml.ir-d.de/irdma | | | | | | |
|------------|--|------------|-------|------------|--------|----|--|
| type | restriction of token | | | | | | |
| properties | base xs:token | | | | | | |
| used by | element BestaetigungBasis/BEG Meldebestaetigung ID | | | | | | |
| facets | <table border="1"> <tr> <th>Kind</th> <th>Value</th> <th>Annotation</th> </tr> <tr> <td>length</td> <td>10</td> <td></td> </tr> </table> | Kind | Value | Annotation | length | 10 | |
| Kind | Value | Annotation | | | | | |
| length | 10 | | | | | | |
| annotation | documentation Facette zur Festlegung der Meldebestätigungslaenge von 10 Zeichen | | | | | | |
| source | <pre> <simpleType name="Meldebestaetigung"> <annotation> <documentation>Facette zur Festlegung der Meldebestätigungslaenge von 10 Zeichen</documentation> </annotation> <restriction base="xs:token"> <length value="10"/> </restriction> </simpleType> </pre> | | | | | | |

simpleType **OPS**

| namespace | http://xml.ir-d.de/irdma | | | | | | |
|------------|--|------------|-------|------------|---------|---|--|
| type | restriction of token | | | | | | |
| properties | base xs:token | | | | | | |
| facets | <table border="1"> <tr> <th>Kind</th> <th>Value</th> <th>Annotation</th> </tr> <tr> <td>pattern</td> <td>((135689)\-(0-9){2}([a-zA-Z0-9]{1}\.([a-zA-Z0-9]{1,2}))*(:[RLBrIb])?)</td> <td></td> </tr> </table> | Kind | Value | Annotation | pattern | ((135689)\-(0-9){2}([a-zA-Z0-9]{1}\.([a-zA-Z0-9]{1,2}))*(:[RLBrIb])?) | |
| Kind | Value | Annotation | | | | | |
| pattern | ((135689)\-(0-9){2}([a-zA-Z0-9]{1}\.([a-zA-Z0-9]{1,2}))*(:[RLBrIb])?) | | | | | | |

| | |
|------------|--|
| annotation | documentation Facette zur Festlegung des Prozedurenschlüssels |
| source | <pre> <simpleType name="OPS"> <annotation> <documentation>Facette zur Festlegung des Prozedurenschlüssels</documentation> </annotation> <restriction base="xs:token"> <pattern value="([135689]\-([0-9]){2}([a-zA-Z0-9]){1}(\.([a-zA-Z0-9]{1,2}))*(:[RLBr1b]) ?)"> </restriction> </simpleType> </pre> |

simpleType **String2**

| namespace | http://xml.ir-d.de/irdma | | | | | | |
|------------|--|------------|-------|------------|---------|------------|--|
| type | restriction of token | | | | | | |
| properties | base xs:token | | | | | | |
| facets | <table border="1"> <thead> <tr> <th>Kind</th> <th>Value</th> <th>Annotation</th> </tr> </thead> <tbody> <tr> <td>pattern</td> <td>([0-9]{2})</td> <td></td> </tr> </tbody> </table> | Kind | Value | Annotation | pattern | ([0-9]{2}) | |
| Kind | Value | Annotation | | | | | |
| pattern | ([0-9]{2}) | | | | | | |
| annotation | documentation Facette zur Festlegung des kodierten Entlassungsgrundes | | | | | | |
| source | <pre> <simpleType name="String2"> <annotation> <documentation>Facette zur Festlegung des kodierten Entlassungsgrundes</documentation> </annotation> <restriction base="xs:token"> <pattern value="([0-9]{2})" /> </restriction> </simpleType> </pre> | | | | | | |

simpleType **String20**

| namespace | http://xml.ir-d.de/irdma | | | | | | |
|------------|--|------------|-------|------------|-----------|----|--|
| type | restriction of token | | | | | | |
| properties | base xs:token | | | | | | |
| facets | <table border="1"> <thead> <tr> <th>Kind</th> <th>Value</th> <th>Annotation</th> </tr> </thead> <tbody> <tr> <td>maxLength</td> <td>20</td> <td></td> </tr> </tbody> </table> | Kind | Value | Annotation | maxLength | 20 | |
| Kind | Value | Annotation | | | | | |
| maxLength | 20 | | | | | | |
| annotation | documentation Facette zur Festlegung von: Artikel-, Ident-, Serien-, Lot-Nummer des Produkts | | | | | | |
| source | <pre> <simpleType name="String20"> <annotation> <documentation>Facette zur Festlegung von: Artikel-, Ident-, Serien-, Lot-Nummer des Produkts</documentation> </annotation> <restriction base="xs:token"> <maxLength value="20" /> </restriction> </simpleType> </pre> | | | | | | |

simpleType Sw

| namespace | http://xml.ir-d.de/irdma | | | | | | |
|------------|--|------------|-------|------------|-----------|-----|--|
| type | restriction of token | | | | | | |
| properties | base xs:token | | | | | | |
| facets | <table border="1"> <thead> <tr> <th>Kind</th> <th>Value</th> <th>Annotation</th> </tr> </thead> <tbody> <tr> <td>maxLength</td> <td>120</td> <td></td> </tr> </tbody> </table> | Kind | Value | Annotation | maxLength | 120 | |
| Kind | Value | Annotation | | | | | |
| maxLength | 120 | | | | | | |
| annotation | documentation Facette für Merkmale der externen Software | | | | | | |
| source | <pre> <simpleType name="Sw"> <annotation> <documentation>Facette für Merkmale der externen Software</documentation> </annotation> <restriction base="xs:token"> <maxLength value="120"/> </restriction> </simpleType> </pre> | | | | | | |

simpleType Transfervummer

| namespace | http://xml.ir-d.de/irdma | | | | | | |
|------------|--|------------|-------|------------|---------|----------------|--|
| type | restriction of token | | | | | | |
| properties | base xs:token | | | | | | |
| used by | element MeldungIrdFallBasis/FAL Transfervummer | | | | | | |
| facets | <table border="1"> <thead> <tr> <th>Kind</th> <th>Value</th> <th>Annotation</th> </tr> </thead> <tbody> <tr> <td>pattern</td> <td>([a-z0-9]{64})</td> <td></td> </tr> </tbody> </table> | Kind | Value | Annotation | pattern | ([a-z0-9]{64}) | |
| Kind | Value | Annotation | | | | | |
| pattern | ([a-z0-9]{64}) | | | | | | |
| annotation | documentation Facette zur Festlegung der Transfervummer | | | | | | |
| source | <pre> <simpleType name="Transfervummer"> <annotation> <documentation>Facette zur Festlegung der Transfervummer</documentation> </annotation> <restriction base="xs:token"> <pattern value="([a-z0-9]{64})"/> </restriction> </simpleType> </pre> | | | | | | |

simpleType Versionsnummer

| namespace | http://xml.ir-d.de/irdma | | | | | | |
|------------|--|------------|-------|------------|-----------|----|--|
| type | restriction of token | | | | | | |
| properties | base xs:token | | | | | | |
| facets | <table border="1"> <thead> <tr> <th>Kind</th> <th>Value</th> <th>Annotation</th> </tr> </thead> <tbody> <tr> <td>maxLength</td> <td>10</td> <td></td> </tr> </tbody> </table> | Kind | Value | Annotation | maxLength | 10 | |
| Kind | Value | Annotation | | | | | |
| maxLength | 10 | | | | | | |
| annotation | documentation Facette zur Festlegung der Versionsnummer des gelieferten Datensatzes | | | | | | |
| source | <pre> <simpleType name="Versionsnummer"> <annotation> <documentation>Facette zur Festlegung der Versionsnummer des gelieferten Datensatzes</documentation> </annotation> <restriction base="xs:token"> <maxLength value="10"/> </restriction> </simpleType> </pre> | | | | | | |

| | |
|--|---|
| | <pre> </annotation> <restriction base="xs:token"> <maxLength value="10"/> </restriction> </simpleType> </pre> |
|--|---|

simpleType **Zahl1**

| namespace | http://xml.ir-d.de/irdma | | | | | | | | | |
|--------------|--|------------|-------|------------|--------------|---|--|--------------|---|--|
| type | restriction of positiveInteger | | | | | | | | | |
| properties | base xs:positiveInteger | | | | | | | | | |
| facets | <table border="1"> <thead> <tr> <th>Kind</th> <th>Value</th> <th>Annotation</th> </tr> </thead> <tbody> <tr> <td>minInclusive</td> <td>1</td> <td></td> </tr> <tr> <td>maxInclusive</td> <td>9</td> <td></td> </tr> </tbody> </table> | Kind | Value | Annotation | minInclusive | 1 | | maxInclusive | 9 | |
| Kind | Value | Annotation | | | | | | | | |
| minInclusive | 1 | | | | | | | | | |
| maxInclusive | 9 | | | | | | | | | |
| annotation | documentation Facette zur Festlegung der 1-stelligen Ganzzahlenwerte | | | | | | | | | |
| source | <pre> <simpleType name="Zahl1"> <annotation> <documentation>Facette zur Festlegung der 1-stelligen Ganzzahlenwerte</documentation> </annotation> <restriction base="xs:positiveInteger"> <minInclusive value="1"/> <maxInclusive value="9"/> </restriction> </simpleType> </pre> | | | | | | | | | |

simpleType **Zahl1_1**

| namespace | http://xml.ir-d.de/irdma | | | | | | | | | | | | | | | |
|----------------|---|------------|-------|------------|--------------|-----|--|--------------|-----|--|-------------|---|--|----------------|---|--|
| type | restriction of decimal | | | | | | | | | | | | | | | |
| properties | base xs:decimal | | | | | | | | | | | | | | | |
| facets | <table border="1"> <thead> <tr> <th>Kind</th> <th>Value</th> <th>Annotation</th> </tr> </thead> <tbody> <tr> <td>minInclusive</td> <td>0.1</td> <td></td> </tr> <tr> <td>maxInclusive</td> <td>9.9</td> <td></td> </tr> <tr> <td>totalDigits</td> <td>2</td> <td></td> </tr> <tr> <td>fractionDigits</td> <td>1</td> <td></td> </tr> </tbody> </table> | Kind | Value | Annotation | minInclusive | 0.1 | | maxInclusive | 9.9 | | totalDigits | 2 | | fractionDigits | 1 | |
| Kind | Value | Annotation | | | | | | | | | | | | | | |
| minInclusive | 0.1 | | | | | | | | | | | | | | | |
| maxInclusive | 9.9 | | | | | | | | | | | | | | | |
| totalDigits | 2 | | | | | | | | | | | | | | | |
| fractionDigits | 1 | | | | | | | | | | | | | | | |
| annotation | documentation Facette zur Festlegung des Formats [N].[N] | | | | | | | | | | | | | | | |
| source | <pre> <simpleType name="Zahl1_1"> <annotation> <documentation>Facette zur Festlegung des Formats [N].[N]</documentation> </annotation> <restriction base="xs:decimal"> <totalDigits value="2"/> <fractionDigits value="1"/> <minInclusive value="0.1"/> <maxInclusive value="9.9"/> </restriction> </simpleType> </pre> | | | | | | | | | | | | | | | |

simpleType Zahl2

| namespace | http://xml.ir-d.de/irdma | | | | | | | | | |
|--------------|---|------------|-------|------------|--------------|---|--|--------------|----|--|
| type | restriction of positiveInteger | | | | | | | | | |
| properties | base xs:positiveInteger | | | | | | | | | |
| facets | <table><thead><tr><th>Kind</th><th>Value</th><th>Annotation</th></tr></thead><tbody><tr><td>minInclusive</td><td>1</td><td></td></tr><tr><td>maxInclusive</td><td>99</td><td></td></tr></tbody></table> | Kind | Value | Annotation | minInclusive | 1 | | maxInclusive | 99 | |
| Kind | Value | Annotation | | | | | | | | |
| minInclusive | 1 | | | | | | | | | |
| maxInclusive | 99 | | | | | | | | | |
| annotation | documentation Facette zur Festlegung der 2-stelligen Ganzzahlenwerte | | | | | | | | | |
| source | <pre><simpleType name="Zahl2"> <annotation> <documentation>Facette zur Festlegung der 2-stelligen Ganzzahlenwerte</documentation> </annotation> <restriction base="xs:positiveInteger"> <minInclusive value="1"/> <maxInclusive value="99"/> </restriction> </simpleType></pre> | | | | | | | | | |

simpleType Zahl2_1

| namespace | http://xml.ir-d.de/irdma | | | | | | | | | | | | | | | |
|----------------|---|------------|-------|------------|--------------|-----|--|--------------|------|--|-------------|---|--|----------------|---|--|
| type | restriction of decimal | | | | | | | | | | | | | | | |
| properties | base xs:decimal | | | | | | | | | | | | | | | |
| facets | <table><thead><tr><th>Kind</th><th>Value</th><th>Annotation</th></tr></thead><tbody><tr><td>minInclusive</td><td>0.1</td><td></td></tr><tr><td>maxInclusive</td><td>99.9</td><td></td></tr><tr><td>totalDigits</td><td>3</td><td></td></tr><tr><td>fractionDigits</td><td>1</td><td></td></tr></tbody></table> | Kind | Value | Annotation | minInclusive | 0.1 | | maxInclusive | 99.9 | | totalDigits | 3 | | fractionDigits | 1 | |
| Kind | Value | Annotation | | | | | | | | | | | | | | |
| minInclusive | 0.1 | | | | | | | | | | | | | | | |
| maxInclusive | 99.9 | | | | | | | | | | | | | | | |
| totalDigits | 3 | | | | | | | | | | | | | | | |
| fractionDigits | 1 | | | | | | | | | | | | | | | |
| annotation | documentation Facette zur Festlegung des Formats [NN].[N] | | | | | | | | | | | | | | | |
| source | <pre><simpleType name="Zahl2_1"> <annotation> <documentation>Facette zur Festlegung des Formats [NN].[N]</documentation> </annotation> <restriction base="xs:decimal"> <totalDigits value="3"/> <fractionDigits value="1"/> <minInclusive value="0.1"/> <maxInclusive value="99.9"/> </restriction> </simpleType></pre> | | | | | | | | | | | | | | | |

simpleType Zahl3

| | |
|------------|---------------------------------------|
| namespace | http://xml.ir-d.de/irdma |
| type | restriction of positiveInteger |
| properties | base xs:positiveInteger |

| facets | <table border="1"> <thead> <tr> <th>Kind</th> <th>Value</th> <th>Annotation</th> </tr> </thead> <tbody> <tr> <td>minInclusive</td> <td>1</td> <td></td> </tr> <tr> <td>maxInclusive</td> <td>999</td> <td></td> </tr> </tbody> </table> | Kind | Value | Annotation | minInclusive | 1 | | maxInclusive | 999 | |
|--------------|--|------------|-------|------------|--------------|---|--|--------------|-----|--|
| Kind | Value | Annotation | | | | | | | | |
| minInclusive | 1 | | | | | | | | | |
| maxInclusive | 999 | | | | | | | | | |
| annotation | documentation Facette zur Festlegung der 3-stelligen Ganzzahlenwerte | | | | | | | | | |
| source | <pre><simpleType name="Zahl3"> <annotation> <documentation>Facette zur Festlegung der 3-stelligen Ganzzahlenwerte</documentation> </annotation> <restriction base="xs:positiveInteger"> <minInclusive value="1"/> <maxInclusive value="999"/> </restriction> </simpleType></pre> | | | | | | | | | |

simpleType **Zahl3_1**

| namespace | http://xml.ir-d.de/irdma | | | | | | | | | | | | | | | |
|----------------|---|------------|-------|------------|--------------|-----|--|--------------|-------|--|-------------|---|--|----------------|---|--|
| type | restriction of decimal | | | | | | | | | | | | | | | |
| properties | base xs:decimal | | | | | | | | | | | | | | | |
| facets | <table border="1"> <thead> <tr> <th>Kind</th> <th>Value</th> <th>Annotation</th> </tr> </thead> <tbody> <tr> <td>minInclusive</td> <td>0.1</td> <td></td> </tr> <tr> <td>maxInclusive</td> <td>999.9</td> <td></td> </tr> <tr> <td>totalDigits</td> <td>4</td> <td></td> </tr> <tr> <td>fractionDigits</td> <td>1</td> <td></td> </tr> </tbody> </table> | Kind | Value | Annotation | minInclusive | 0.1 | | maxInclusive | 999.9 | | totalDigits | 4 | | fractionDigits | 1 | |
| Kind | Value | Annotation | | | | | | | | | | | | | | |
| minInclusive | 0.1 | | | | | | | | | | | | | | | |
| maxInclusive | 999.9 | | | | | | | | | | | | | | | |
| totalDigits | 4 | | | | | | | | | | | | | | | |
| fractionDigits | 1 | | | | | | | | | | | | | | | |
| annotation | documentation Facette zur Festlegung des Formats [NNN].[N] | | | | | | | | | | | | | | | |
| source | <pre><simpleType name="Zahl3_1"> <annotation> <documentation>Facette zur Festlegung des Formats [NNN].[N]</documentation> </annotation> <restriction base="xs:decimal"> <totalDigits value="4"/> <fractionDigits value="1"/> <minInclusive value="0.1"/> <maxInclusive value="999.9"/> </restriction> </simpleType></pre> | | | | | | | | | | | | | | | |

simpleType **Zahl4**

| namespace | http://xml.ir-d.de/irdma | | | | | | | | | |
|--------------|--|------------|-------|------------|--------------|---|--|--------------|------|--|
| type | restriction of positiveInteger | | | | | | | | | |
| properties | base xs:positiveInteger | | | | | | | | | |
| facets | <table border="1"> <thead> <tr> <th>Kind</th> <th>Value</th> <th>Annotation</th> </tr> </thead> <tbody> <tr> <td>minInclusive</td> <td>1</td> <td></td> </tr> <tr> <td>maxInclusive</td> <td>9999</td> <td></td> </tr> </tbody> </table> | Kind | Value | Annotation | minInclusive | 1 | | maxInclusive | 9999 | |
| Kind | Value | Annotation | | | | | | | | |
| minInclusive | 1 | | | | | | | | | |
| maxInclusive | 9999 | | | | | | | | | |
| annotation | documentation Facette zur Festlegung der 4-stelligen Ganzzahlenwerte | | | | | | | | | |
| source | <pre><simpleType name="Zahl4"> <annotation></pre> | | | | | | | | | |

| | |
|--|--|
| | <pre> <documentation>Facette zur Festlegung der 4-stelligen Ganzzahlenwerte</documentation> </annotation> <restriction base="xs:positiveInteger"> <minInclusive value="1"/> <maxInclusive value="9999"/> </restriction> </simpleType> </pre> |
|--|--|

simpleType **Zahl5**

| namespace | http://xml.ir-d.de/irdma | | | | | | | | | |
|--------------|--|------------|-------|------------|--------------|---|--|--------------|-------|--|
| type | restriction of positiveInteger | | | | | | | | | |
| properties | base xs:positiveInteger | | | | | | | | | |
| facets | <table border="1"> <thead> <tr> <th>Kind</th> <th>Value</th> <th>Annotation</th> </tr> </thead> <tbody> <tr> <td>minInclusive</td> <td>1</td> <td></td> </tr> <tr> <td>maxInclusive</td> <td>99999</td> <td></td> </tr> </tbody> </table> | Kind | Value | Annotation | minInclusive | 1 | | maxInclusive | 99999 | |
| Kind | Value | Annotation | | | | | | | | |
| minInclusive | 1 | | | | | | | | | |
| maxInclusive | 99999 | | | | | | | | | |
| annotation | documentation Facette zur Festlegung der 5-stelligen Ganzzahlenwerte | | | | | | | | | |
| source | <pre> <simpleType name="Zahl5"> <annotation> <documentation>Facette zur Festlegung der 5-stelligen Ganzzahlenwerte</documentation> </annotation> <restriction base="xs:positiveInteger"> <minInclusive value="1"/> <maxInclusive value="99999"/> </restriction> </simpleType> </pre> | | | | | | | | | |

simpleType **Zahl5mitNull**

| namespace | http://xml.ir-d.de/irdma | | | | | | | | | |
|--------------|---|------------|-------|------------|--------------|---|--|--------------|-------|--|
| type | restriction of integer | | | | | | | | | |
| properties | base xs:integer | | | | | | | | | |
| facets | <table border="1"> <thead> <tr> <th>Kind</th> <th>Value</th> <th>Annotation</th> </tr> </thead> <tbody> <tr> <td>minInclusive</td> <td>0</td> <td></td> </tr> <tr> <td>maxInclusive</td> <td>99999</td> <td></td> </tr> </tbody> </table> | Kind | Value | Annotation | minInclusive | 0 | | maxInclusive | 99999 | |
| Kind | Value | Annotation | | | | | | | | |
| minInclusive | 0 | | | | | | | | | |
| maxInclusive | 99999 | | | | | | | | | |
| annotation | documentation Facette zur Festlegung der 5-stelligen Ganzzahlenwerte inklusive "0" | | | | | | | | | |
| source | <pre> <simpleType name="Zahl5mitNull"> <annotation> <documentation>Facette zur Festlegung der 5-stelligen Ganzzahlenwerte inklusive "0"</documentation> </annotation> <restriction base="xs:integer"> <minInclusive value="0"/> <maxInclusive value="99999"/> </restriction> </simpleType> </pre> | | | | | | | | | |

complexType MeldungIrdBasis

| | |
|-----------|--|
| diagram | |
| namespace | http://xml.ir-d.de/irdma |
| children | MEL_IrdIdGesundheitseinrichtung |
| used by | complexType MeldungIrd |
| source | <pre><complexType name="MeldungIrdBasis"> <sequence> <element name="MEL_IrdIdGesundheitseinrichtung" type="IdEinrichtung"/> </sequence> </complexType></pre> |

element MeldungIrdBasis/MEL_IrdIdGesundheitseinrichtung

| diagram | | | | | | | |
|------------|--|------------|-------|------------|---------|-------------------|--|
| type | IdEinrichtung | | | | | | |
| properties | content simple | | | | | | |
| facets | <table border="1"> <thead> <tr> <th>Kind</th> <th>Value</th> <th>Annotation</th> </tr> </thead> <tbody> <tr> <td>pattern</td> <td>(IRD-GE-[0-9]{8})</td> <td></td> </tr> </tbody> </table> | Kind | Value | Annotation | pattern | (IRD-GE-[0-9]{8}) | |
| Kind | Value | Annotation | | | | | |
| pattern | (IRD-GE-[0-9]{8}) | | | | | | |
| source | <pre><element name="MEL_IrdIdGesundheitseinrichtung" type="IdEinrichtung"/></pre> | | | | | | |

complexType MeldungIrdFallBasis

| | |
|-----------|---|
| diagram | |
| namespace | http://xml.ir-d.de/irdma |
| children | FAL_Transfernummer FAL_DatumZeitSatzErstellung |
| used by | element MeldungIrd/fall |
| source | <pre><complexType name="MeldungIrdFallBasis"> <sequence> <element name="FAL_Transfernummer" type="Transfernummer"/> <element name="FAL_DatumZeitSatzErstellung" type="xs:dateTime"/> </sequence> </complexType></pre> |

element MeldungIrdFallBasis/FAL_Transfernummer

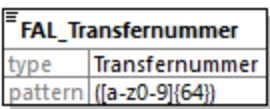
| | |
|------------|---|
| diagram |  |
| type | Transfernummer |
| properties | content simple |
| facets | Kind Value Annotation pattern ([a-z0-9]{64}) |
| source | <code><element name="FAL_Transfernummer" type="Transfernummer"/></code> |

element MeldungIrdFallBasis/FAL_DatumZeitSatzErstellung

| | |
|------------|---|
| diagram |  |
| type | dateTime |
| properties | content simple |
| source | <code><element name="FAL_DatumZeitSatzErstellung" type="xs:dateTime"/></code> |

simpleType DatumText

| | |
|------------|--|
| namespace | http://xml.ir-d.de/irdsa |
| type | restriction of token |
| properties | base xs:token |
| facets | Kind Value Annotation pattern ((([0-9]{4})([0-9]{2})?)([0-9]{2})?) |
| annotation | documentation Facette zur Festlegung des freien Datumformats: JJJJ[-MM[-TT]] |
| source | <pre><simpleType name="DatumText"> <annotation> <documentation>Facette zur Festlegung des freien Datumformats: JJJJ[-MM[-TT]]</documentation> </annotation> <restriction base="xs:token"> <pattern value="((([0-9]{4})([0-9]{2})?)([0-9]{2})?)"/> </restriction> </simpleType></pre> |

simpleType Freitext250

| | |
|------------|--|
| namespace | http://xml.ir-d.de/irdsa |
| type | restriction of token |
| properties | base xs:token |
| used by | element EmpfangsbestaetigungBasis/EBG_Empfangsbestaetigung |
| facets | Kind Value Annotation maxLength 250 |

| | |
|------------|--|
| annotation | documentation Facette zur Festlegung des Freitextes von 250 Zeichen |
| source | <pre><simpleType name="Freitext250"> <annotation> <documentation>Facette zur Festlegung des Freitextes von 250 Zeichen</documentation> </annotation> <restriction base="xs:token"> <maxLength value="250"/> </restriction> </simpleType></pre> |

simpleType **Freitext500**

| namespace | http://xml.ir-d.de/irdsa | | | | | | |
|------------|--|------------|-------|------------|-----------|-----|--|
| type | restriction of token | | | | | | |
| properties | base xs:token | | | | | | |
| used by | elements HinweisBasis/HNW Datenelement HinweisBasis/HNW Meldung HinweisBasis/HNW Wert | | | | | | |
| facets | <table border="1"> <thead> <tr> <th>Kind</th> <th>Value</th> <th>Annotation</th> </tr> </thead> <tbody> <tr> <td>maxLength</td> <td>500</td> <td></td> </tr> </tbody> </table> | Kind | Value | Annotation | maxLength | 500 | |
| Kind | Value | Annotation | | | | | |
| maxLength | 500 | | | | | | |
| annotation | documentation Facette zur Festlegung des Freitextes von 500 Zeichen | | | | | | |
| source | <pre><simpleType name="Freitext500"> <annotation> <documentation>Facette zur Festlegung des Freitextes von 500 Zeichen</documentation> </annotation> <restriction base="xs:token"> <maxLength value="500"/> </restriction> </simpleType></pre> | | | | | | |

simpleType **HashString**

| namespace | http://xml.ir-d.de/irdsa | | | | | | |
|------------|--|------------|-------|------------|-----------|-----|--|
| type | restriction of token | | | | | | |
| properties | base xs:token | | | | | | |
| facets | <table border="1"> <thead> <tr> <th>Kind</th> <th>Value</th> <th>Annotation</th> </tr> </thead> <tbody> <tr> <td>maxLength</td> <td>512</td> <td></td> </tr> </tbody> </table> | Kind | Value | Annotation | maxLength | 512 | |
| Kind | Value | Annotation | | | | | |
| maxLength | 512 | | | | | | |
| annotation | documentation Facette zur Festlegung des Hash-Strings der Meldebestätigung | | | | | | |
| source | <pre><simpleType name="HashString"> <annotation> <documentation>Facette zur Festlegung des Hash-Strings der Meldebestätigung</documentation> </annotation> <restriction base="xs:token"> <maxLength value="512"/> </restriction> </simpleType></pre> | | | | | | |

simpleType HashWert

| namespace | http://xml.ir-d.de/irdsa | | | | | | |
|------------|--|------------|-------|------------|--------|----|--|
| type | restriction of token | | | | | | |
| properties | base xs:token | | | | | | |
| facets | <table border="1"> <thead> <tr> <th>Kind</th> <th>Value</th> <th>Annotation</th> </tr> </thead> <tbody> <tr> <td>length</td> <td>64</td> <td></td> </tr> </tbody> </table> | Kind | Value | Annotation | length | 64 | |
| Kind | Value | Annotation | | | | | |
| length | 64 | | | | | | |
| annotation | documentation Facette zur Festlegung des Hashwertes der Meldebestätigung | | | | | | |
| source | <pre> <simpleType name="HashWert"> <annotation> <documentation>Facette zur Festlegung des Hashwertes der Meldebestätigung</documentation> </annotation> <restriction base="xs:token"> <length value="64"/> </restriction> </simpleType> </pre> | | | | | | |

simpleType ICD

| namespace | http://xml.ir-d.de/irdsa | | | | | | |
|------------|---|------------|-------|------------|---------|--|--|
| type | restriction of token | | | | | | |
| properties | base xs:token | | | | | | |
| facets | <table border="1"> <thead> <tr> <th>Kind</th> <th>Value</th> <th>Annotation</th> </tr> </thead> <tbody> <tr> <td>pattern</td> <td>([a-zA-Z][0-9]{2}(\.[0-9]{1,2})?(:[RLB])?)</td> <td></td> </tr> </tbody> </table> | Kind | Value | Annotation | pattern | ([a-zA-Z][0-9]{2}(\.[0-9]{1,2})?(:[RLB])?) | |
| Kind | Value | Annotation | | | | | |
| pattern | ([a-zA-Z][0-9]{2}(\.[0-9]{1,2})?(:[RLB])?) | | | | | | |
| annotation | documentation Facette zur Festlegung des ICD Code | | | | | | |
| source | <pre> <simpleType name="ICD"> <annotation> <documentation>Facette zur Festlegung des ICD Code</documentation> </annotation> <restriction base="xs:token"> <pattern value="([a-zA-Z][0-9]{2}(\.[0-9]{1,2})?(:[RLB])?)"/> </restriction> </simpleType> </pre> | | | | | | |

simpleType IdEinrichtung

| namespace | http://xml.ir-d.de/irdsa | | | | | | |
|------------|--|------------|-------|------------|---------|-------------------|--|
| type | restriction of token | | | | | | |
| properties | base xs:token | | | | | | |
| used by | element MeldungIrdBasis/MEL_IrdIdGesundheitseinrichtung | | | | | | |
| facets | <table border="1"> <thead> <tr> <th>Kind</th> <th>Value</th> <th>Annotation</th> </tr> </thead> <tbody> <tr> <td>pattern</td> <td>(IRD-GE-[0-9](8))</td> <td></td> </tr> </tbody> </table> | Kind | Value | Annotation | pattern | (IRD-GE-[0-9](8)) | |
| Kind | Value | Annotation | | | | | |
| pattern | (IRD-GE-[0-9](8)) | | | | | | |
| annotation | documentation Facette zur Festlegung der Gesundheitseinrichtung-ID | | | | | | |
| source | <pre> <simpleType name="IdEinrichtung"> <annotation> <documentation>Facette zur Festlegung der </pre> | | | | | | |

| | |
|--|--|
| | <pre> Gesundheitseinrichtung-ID</documentation> </annotation> <restriction base="xs:token"> <pattern value="(IRD-GE-[0-9]{8})"/> </restriction> </simpleType> </pre> |
|--|--|

simpleType IrdArtikelId

| namespace | http://xml.ir-d.de/irdsa | | | | | | |
|------------|---|------------|-------|------------|-----------|----|--|
| type | restriction of token | | | | | | |
| properties | base xs:token | | | | | | |
| facets | <table border="1"> <thead> <tr> <th>Kind</th> <th>Value</th> <th>Annotation</th> </tr> </thead> <tbody> <tr> <td>maxLength</td> <td>16</td> <td></td> </tr> </tbody> </table> | Kind | Value | Annotation | maxLength | 16 | |
| Kind | Value | Annotation | | | | | |
| maxLength | 16 | | | | | | |
| annotation | documentation Facette zur Festlegung der IrdNummer | | | | | | |
| source | <pre> <simpleType name="IrdArtikelId"> <annotation> <documentation>Facette zur Festlegung der IrdNummer</documentation> </annotation> <restriction base="xs:token"> <maxLength value="16"/> </restriction> </simpleType> </pre> | | | | | | |

simpleType IrdSpezVersion

| namespace | http://xml.ir-d.de/irdsa | | | | | | |
|------------|--|------------|-------|------------|---------|---|--|
| type | restriction of token | | | | | | |
| properties | base xs:token | | | | | | |
| facets | <table border="1"> <thead> <tr> <th>Kind</th> <th>Value</th> <th>Annotation</th> </tr> </thead> <tbody> <tr> <td>pattern</td> <td>(([1-9] [1-9][0-9])\.\d [1-9][0-9])\.\d [1-9][0-9])</td> <td></td> </tr> </tbody> </table> | Kind | Value | Annotation | pattern | (([1-9] [1-9][0-9])\.\d [1-9][0-9])\.\d [1-9][0-9]) | |
| Kind | Value | Annotation | | | | | |
| pattern | (([1-9] [1-9][0-9])\.\d [1-9][0-9])\.\d [1-9][0-9]) | | | | | | |
| annotation | documentation Facette zur Festlegung der Version der IRD-Spezifikation | | | | | | |
| source | <pre> <simpleType name="IrdSpezVersion"> <annotation> <documentation>Facette zur Festlegung der Version der IRD-Spezifikation</documentation> </annotation> <restriction base="xs:token"> <pattern value="(([1-9] [1-9][0-9])\.\d [1-9][0-9])\.\d [1-9][0-9])"/> </restriction> </simpleType> </pre> | | | | | | |

simpleType JaLeer

| namespace | http://xml.ir-d.de/irdsa | | | |
|------------|---|------------|-------|------------|
| type | restriction of integer | | | |
| properties | base xs:integer | | | |
| facets | <table border="1"> <thead> <tr> <th>Kind</th> <th>Value</th> <th>Annotation</th> </tr> </thead> <tbody> </tbody> </table> | Kind | Value | Annotation |
| Kind | Value | Annotation | | |

| | |
|------------|--|
| | pattern (1) |
| annotation | documentation Facette zur Festlegung des Unbekannt-Wertes (Bedeutung 1=true) |
| source | <pre><simpleType name="JaLeer"> <annotation> <documentation>Facette zur Festlegung des Unbekannt-Wertes (Bedeutung 1=true)</documentation> </annotation> <restriction base="xs:integer"> <pattern value="(1)"/> </restriction> </simpleType></pre> |

simpleType **Meldebestaetigung**

| namespace | http://xml.ir-d.de/irdsa | | | | | | |
|------------|--|------------|-------|------------|--------|----|--|
| type | restriction of token | | | | | | |
| properties | base xs:token | | | | | | |
| facets | <table border="1"> <thead> <tr> <th>Kind</th> <th>Value</th> <th>Annotation</th> </tr> </thead> <tbody> <tr> <td>length</td> <td>10</td> <td></td> </tr> </tbody> </table> | Kind | Value | Annotation | length | 10 | |
| Kind | Value | Annotation | | | | | |
| length | 10 | | | | | | |
| annotation | documentation Facette zur Festlegung der Meldebestätigungslaenge von 10 Zeichen | | | | | | |
| source | <pre><simpleType name="Meldebestaetigung"> <annotation> <documentation>Facette zur Festlegung der Meldebestätigungslaenge von 10 Zeichen</documentation> </annotation> <restriction base="xs:token"> <length value="10"/> </restriction> </simpleType></pre> | | | | | | |

simpleType **OPS**

| namespace | http://xml.ir-d.de/irdsa | | | | | | |
|------------|---|------------|-------|------------|---------|---|--|
| type | restriction of token | | | | | | |
| properties | base xs:token | | | | | | |
| facets | <table border="1"> <thead> <tr> <th>Kind</th> <th>Value</th> <th>Annotation</th> </tr> </thead> <tbody> <tr> <td>pattern</td> <td>((135689)\-([0-9]){2}([a-zA-Z0-9]){1}\.([a-zA-Z0-9]{1,2}))*(:[RLBr1b])?</td> <td></td> </tr> </tbody> </table> | Kind | Value | Annotation | pattern | ((135689)\-([0-9]){2}([a-zA-Z0-9]){1}\.([a-zA-Z0-9]{1,2}))*(:[RLBr1b])? | |
| Kind | Value | Annotation | | | | | |
| pattern | ((135689)\-([0-9]){2}([a-zA-Z0-9]){1}\.([a-zA-Z0-9]{1,2}))*(:[RLBr1b])? | | | | | | |
| annotation | documentation Facette zur Festlegung des Prozedurenschlüssels | | | | | | |
| source | <pre><simpleType name="OPS"> <annotation> <documentation>Facette zur Festlegung des Prozedurenschlüssels</documentation> </annotation> <restriction base="xs:token"> <pattern value="((135689)\-([0-9]){2}([a-zA-Z0-9]){1}\.([a-zA-Z0-9]{1,2}))*(:[RLBr1b])?" /> </restriction></pre> | | | | | | |

| | |
|--|----------------------------------|
| | <code></simpleType></code> |
|--|----------------------------------|

simpleType **String2**

| namespace | http://xml.ir-d.de/irdsa | | | | | | |
|------------|---|------------|-------|------------|---------|------------|--|
| type | restriction of token | | | | | | |
| properties | base xs:token | | | | | | |
| facets | <table border="1"> <thead> <tr> <th>Kind</th> <th>Value</th> <th>Annotation</th> </tr> </thead> <tbody> <tr> <td>pattern</td> <td>([0-9]{2})</td> <td></td> </tr> </tbody> </table> | Kind | Value | Annotation | pattern | ([0-9]{2}) | |
| Kind | Value | Annotation | | | | | |
| pattern | ([0-9]{2}) | | | | | | |
| annotation | documentation Facette zur Festlegung des kodierten Entlassungsgrundes | | | | | | |
| source | <pre> <simpleType name="String2"> <annotation> <documentation>Facette zur Festlegung des kodierten Entlassungsgrundes</documentation> </annotation> <restriction base="xs:token"> <pattern value="([0-9]{2})"/> </restriction> </simpleType> </pre> | | | | | | |

simpleType **String20**

| namespace | http://xml.ir-d.de/irdsa | | | | | | |
|------------|---|------------|-------|------------|-----------|----|--|
| type | restriction of token | | | | | | |
| properties | base xs:token | | | | | | |
| facets | <table border="1"> <thead> <tr> <th>Kind</th> <th>Value</th> <th>Annotation</th> </tr> </thead> <tbody> <tr> <td>maxLength</td> <td>20</td> <td></td> </tr> </tbody> </table> | Kind | Value | Annotation | maxLength | 20 | |
| Kind | Value | Annotation | | | | | |
| maxLength | 20 | | | | | | |
| annotation | documentation Facette zur Festlegung von: Artikel-, Ident-, Serien-, Lot-Nummer des Produkts | | | | | | |
| source | <pre> <simpleType name="String20"> <annotation> <documentation>Facette zur Festlegung von: Artikel-, Ident-, Serien-, Lot-Nummer des Produkts</documentation> </annotation> <restriction base="xs:token"> <maxLength value="20"/> </restriction> </simpleType> </pre> | | | | | | |

simpleType **Sw**

| namespace | http://xml.ir-d.de/irdsa | | | | | | |
|------------|--|------------|-------|------------|-----------|-----|--|
| type | restriction of token | | | | | | |
| properties | base xs:token | | | | | | |
| facets | <table border="1"> <thead> <tr> <th>Kind</th> <th>Value</th> <th>Annotation</th> </tr> </thead> <tbody> <tr> <td>maxLength</td> <td>120</td> <td></td> </tr> </tbody> </table> | Kind | Value | Annotation | maxLength | 120 | |
| Kind | Value | Annotation | | | | | |
| maxLength | 120 | | | | | | |
| annotation | documentation Facette für Merkmale der externen Software | | | | | | |
| source | <pre> <simpleType name="Sw"> </pre> | | | | | | |

| | |
|--|---|
| | <pre> <annotation> <documentation>Facette für Merkmale der externen Software</documentation> </annotation> <restriction base="xs:token"> <maxLength value="120"/> </restriction> </simpleType> </pre> |
|--|---|

simpleType **Transfervummer**

| namespace | http://xml.ir-d.de/irdsa | | | | | | |
|------------|--|------------|-------|------------|---------|----------------|--|
| type | restriction of token | | | | | | |
| properties | base xs:token | | | | | | |
| used by | element StornoFallBasis/FAL Transfervummer | | | | | | |
| facets | <table border="1"> <thead> <tr> <th>Kind</th> <th>Value</th> <th>Annotation</th> </tr> </thead> <tbody> <tr> <td>pattern</td> <td>([a-z0-9]{64})</td> <td></td> </tr> </tbody> </table> | Kind | Value | Annotation | pattern | ([a-z0-9]{64}) | |
| Kind | Value | Annotation | | | | | |
| pattern | ([a-z0-9]{64}) | | | | | | |
| annotation | documentation Facette zur Festlegung der Transfervummer | | | | | | |
| source | <pre> <simpleType name="Transfervummer"> <annotation> <documentation>Facette zur Festlegung der Transfervummer</documentation> </annotation> <restriction base="xs:token"> <pattern value="([a-z0-9]{64})"/> </restriction> </simpleType> </pre> | | | | | | |

simpleType **Versionsnummer**

| namespace | http://xml.ir-d.de/irdsa | | | | | | |
|------------|--|------------|-------|------------|-----------|----|--|
| type | restriction of token | | | | | | |
| properties | base xs:token | | | | | | |
| facets | <table border="1"> <thead> <tr> <th>Kind</th> <th>Value</th> <th>Annotation</th> </tr> </thead> <tbody> <tr> <td>maxLength</td> <td>10</td> <td></td> </tr> </tbody> </table> | Kind | Value | Annotation | maxLength | 10 | |
| Kind | Value | Annotation | | | | | |
| maxLength | 10 | | | | | | |
| annotation | documentation Facette zur Festlegung der Versionsnummer des gelieferten Datensatzes | | | | | | |
| source | <pre> <simpleType name="Versionsnummer"> <annotation> <documentation>Facette zur Festlegung der Versionsnummer des gelieferten Datensatzes</documentation> </annotation> <restriction base="xs:token"> <maxLength value="10"/> </restriction> </simpleType> </pre> | | | | | | |

simpleType **Zahl1**

| | |
|-----------|---------------------------------------|
| namespace | http://xml.ir-d.de/irdsa |
| type | restriction of positivelnteger |

| properties | base xs:positiveInteger | | | | | | | | | |
|--------------|--|------------|-------|------------|--------------|---|--|--------------|---|--|
| facets | <table border="1"> <thead> <tr> <th>Kind</th> <th>Value</th> <th>Annotation</th> </tr> </thead> <tbody> <tr> <td>minInclusive</td> <td>1</td> <td></td> </tr> <tr> <td>maxInclusive</td> <td>9</td> <td></td> </tr> </tbody> </table> | Kind | Value | Annotation | minInclusive | 1 | | maxInclusive | 9 | |
| Kind | Value | Annotation | | | | | | | | |
| minInclusive | 1 | | | | | | | | | |
| maxInclusive | 9 | | | | | | | | | |
| annotation | documentation Facette zur Festlegung der 1-stelligen Ganzzahlenwerte | | | | | | | | | |
| source | <pre><simpleType name="Zahl1"> <annotation> <documentation>Facette zur Festlegung der 1-stelligen Ganzzahlenwerte</documentation> </annotation> <restriction base="xs:positiveInteger"> <minInclusive value="1"/> <maxInclusive value="9"/> </restriction> </simpleType></pre> | | | | | | | | | |

simpleType Zahl1_1

| namespace | http://xml.ir-d.de/irdsa | | | | | | | | | | | | | | | |
|----------------|---|------------|-------|------------|--------------|-----|--|--------------|-----|--|-------------|---|--|----------------|---|--|
| type | restriction of decimal | | | | | | | | | | | | | | | |
| properties | base xs:decimal | | | | | | | | | | | | | | | |
| facets | <table border="1"> <thead> <tr> <th>Kind</th> <th>Value</th> <th>Annotation</th> </tr> </thead> <tbody> <tr> <td>minInclusive</td> <td>0.1</td> <td></td> </tr> <tr> <td>maxInclusive</td> <td>9.9</td> <td></td> </tr> <tr> <td>totalDigits</td> <td>2</td> <td></td> </tr> <tr> <td>fractionDigits</td> <td>1</td> <td></td> </tr> </tbody> </table> | Kind | Value | Annotation | minInclusive | 0.1 | | maxInclusive | 9.9 | | totalDigits | 2 | | fractionDigits | 1 | |
| Kind | Value | Annotation | | | | | | | | | | | | | | |
| minInclusive | 0.1 | | | | | | | | | | | | | | | |
| maxInclusive | 9.9 | | | | | | | | | | | | | | | |
| totalDigits | 2 | | | | | | | | | | | | | | | |
| fractionDigits | 1 | | | | | | | | | | | | | | | |
| annotation | documentation Facette zur Festlegung des Formats [N].[N] | | | | | | | | | | | | | | | |
| source | <pre><simpleType name="Zahl1_1"> <annotation> <documentation>Facette zur Festlegung des Formats [N].[N]</documentation> </annotation> <restriction base="xs:decimal"> <totalDigits value="2"/> <fractionDigits value="1"/> <minInclusive value="0.1"/> <maxInclusive value="9.9"/> </restriction> </simpleType></pre> | | | | | | | | | | | | | | | |

simpleType Zahl2

| namespace | http://xml.ir-d.de/irdsa | | | | | | | | | |
|--------------|--|------------|-------|------------|--------------|---|--|--------------|----|--|
| type | restriction of positiveInteger | | | | | | | | | |
| properties | base xs:positiveInteger | | | | | | | | | |
| facets | <table border="1"> <thead> <tr> <th>Kind</th> <th>Value</th> <th>Annotation</th> </tr> </thead> <tbody> <tr> <td>minInclusive</td> <td>1</td> <td></td> </tr> <tr> <td>maxInclusive</td> <td>99</td> <td></td> </tr> </tbody> </table> | Kind | Value | Annotation | minInclusive | 1 | | maxInclusive | 99 | |
| Kind | Value | Annotation | | | | | | | | |
| minInclusive | 1 | | | | | | | | | |
| maxInclusive | 99 | | | | | | | | | |
| annotation | documentation Facette zur Festlegung der 2-stelligen Ganzzahlenwerte | | | | | | | | | |

| | |
|--------|---|
| source | <pre><simpleType name="Zahl2"> <annotation> <documentation>Facette zur Festlegung der 2-stelligen Ganzzahlenwerte</documentation> </annotation> <restriction base="xs:positiveInteger"> <minInclusive value="1"/> <maxInclusive value="99"/> </restriction> </simpleType></pre> |
|--------|---|

simpleType Zahl2_1

| namespace | http://xml.ir-d.de/irdsa | | | | | | | | | | | | | | | |
|----------------|---|------------|-------|------------|--------------|-----|--|--------------|------|--|-------------|---|--|----------------|---|--|
| type | restriction of decimal | | | | | | | | | | | | | | | |
| properties | base xs:decimal | | | | | | | | | | | | | | | |
| facets | <table border="1"> <thead> <tr> <th>Kind</th> <th>Value</th> <th>Annotation</th> </tr> </thead> <tbody> <tr> <td>minInclusive</td> <td>0.1</td> <td></td> </tr> <tr> <td>maxInclusive</td> <td>99.9</td> <td></td> </tr> <tr> <td>totalDigits</td> <td>3</td> <td></td> </tr> <tr> <td>fractionDigits</td> <td>1</td> <td></td> </tr> </tbody> </table> | Kind | Value | Annotation | minInclusive | 0.1 | | maxInclusive | 99.9 | | totalDigits | 3 | | fractionDigits | 1 | |
| Kind | Value | Annotation | | | | | | | | | | | | | | |
| minInclusive | 0.1 | | | | | | | | | | | | | | | |
| maxInclusive | 99.9 | | | | | | | | | | | | | | | |
| totalDigits | 3 | | | | | | | | | | | | | | | |
| fractionDigits | 1 | | | | | | | | | | | | | | | |
| annotation | documentation Facette zur Festlegung des Formats [NN].[N] | | | | | | | | | | | | | | | |
| source | <pre><simpleType name="Zahl2_1"> <annotation> <documentation>Facette zur Festlegung des Formats [NN].[N]</documentation> </annotation> <restriction base="xs:decimal"> <totalDigits value="3"/> <fractionDigits value="1"/> <minInclusive value="0.1"/> <maxInclusive value="99.9"/> </restriction> </simpleType></pre> | | | | | | | | | | | | | | | |

simpleType Zahl3

| namespace | http://xml.ir-d.de/irdsa | | | | | | | | | |
|--------------|--|------------|-------|------------|--------------|---|--|--------------|-----|--|
| type | restriction of positiveInteger | | | | | | | | | |
| properties | base xs:positiveInteger | | | | | | | | | |
| facets | <table border="1"> <thead> <tr> <th>Kind</th> <th>Value</th> <th>Annotation</th> </tr> </thead> <tbody> <tr> <td>minInclusive</td> <td>1</td> <td></td> </tr> <tr> <td>maxInclusive</td> <td>999</td> <td></td> </tr> </tbody> </table> | Kind | Value | Annotation | minInclusive | 1 | | maxInclusive | 999 | |
| Kind | Value | Annotation | | | | | | | | |
| minInclusive | 1 | | | | | | | | | |
| maxInclusive | 999 | | | | | | | | | |
| annotation | documentation Facette zur Festlegung der 3-stelligen Ganzzahlenwerte | | | | | | | | | |
| source | <pre><simpleType name="Zahl3"> <annotation> <documentation>Facette zur Festlegung der 3-stelligen Ganzzahlenwerte</documentation> </annotation> <restriction base="xs:positiveInteger"> <minInclusive value="1"/> </restriction> </simpleType></pre> | | | | | | | | | |

| | |
|--|---|
| | <pre> <maxInclusive value="999"/> </restriction> </simpleType> </pre> |
|--|---|

simpleType **Zahl3_1**

| namespace | http://xml.ir-d.de/irdsa | | | | | | | | | | | | | | | |
|----------------|---|------------|-------|------------|--------------|-----|--|--------------|-------|--|-------------|---|--|----------------|---|--|
| type | restriction of decimal | | | | | | | | | | | | | | | |
| properties | base xs:decimal | | | | | | | | | | | | | | | |
| facets | <table border="1"> <thead> <tr> <th>Kind</th> <th>Value</th> <th>Annotation</th> </tr> </thead> <tbody> <tr> <td>minInclusive</td> <td>0.1</td> <td></td> </tr> <tr> <td>maxInclusive</td> <td>999.9</td> <td></td> </tr> <tr> <td>totalDigits</td> <td>4</td> <td></td> </tr> <tr> <td>fractionDigits</td> <td>1</td> <td></td> </tr> </tbody> </table> | Kind | Value | Annotation | minInclusive | 0.1 | | maxInclusive | 999.9 | | totalDigits | 4 | | fractionDigits | 1 | |
| Kind | Value | Annotation | | | | | | | | | | | | | | |
| minInclusive | 0.1 | | | | | | | | | | | | | | | |
| maxInclusive | 999.9 | | | | | | | | | | | | | | | |
| totalDigits | 4 | | | | | | | | | | | | | | | |
| fractionDigits | 1 | | | | | | | | | | | | | | | |
| annotation | documentation Facette zur Festlegung des Formats [NNN].[N] | | | | | | | | | | | | | | | |
| source | <pre> <simpleType name="Zahl3_1"> <annotation> <documentation>Facette zur Festlegung des Formats [NNN].[N]</documentation> </annotation> <restriction base="xs:decimal"> <totalDigits value="4"/> <fractionDigits value="1"/> <minInclusive value="0.1"/> <maxInclusive value="999.9"/> </restriction> </simpleType> </pre> | | | | | | | | | | | | | | | |

simpleType **Zahl4**

| namespace | http://xml.ir-d.de/irdsa | | | | | | | | | |
|--------------|---|------------|-------|------------|--------------|---|--|--------------|------|--|
| type | restriction of positiveInteger | | | | | | | | | |
| properties | base xs:positiveInteger | | | | | | | | | |
| facets | <table border="1"> <thead> <tr> <th>Kind</th> <th>Value</th> <th>Annotation</th> </tr> </thead> <tbody> <tr> <td>minInclusive</td> <td>1</td> <td></td> </tr> <tr> <td>maxInclusive</td> <td>9999</td> <td></td> </tr> </tbody> </table> | Kind | Value | Annotation | minInclusive | 1 | | maxInclusive | 9999 | |
| Kind | Value | Annotation | | | | | | | | |
| minInclusive | 1 | | | | | | | | | |
| maxInclusive | 9999 | | | | | | | | | |
| annotation | documentation Facette zur Festlegung der 4-stelligen Ganzzahlenwerte | | | | | | | | | |
| source | <pre> <simpleType name="Zahl4"> <annotation> <documentation>Facette zur Festlegung der 4-stelligen Ganzzahlenwerte</documentation> </annotation> <restriction base="xs:positiveInteger"> <minInclusive value="1"/> <maxInclusive value="9999"/> </restriction> </simpleType> </pre> | | | | | | | | | |

simpleType **Zahl5**

| namespace | http://xml.ir-d.de/irdsa | | | | | | | | | |
|--------------|--|------------|-------|------------|--------------|---|--|--------------|-------|--|
| type | restriction of positiveInteger | | | | | | | | | |
| properties | base xs:positiveInteger | | | | | | | | | |
| facets | <table border="1"> <thead> <tr> <th>Kind</th> <th>Value</th> <th>Annotation</th> </tr> </thead> <tbody> <tr> <td>minInclusive</td> <td>1</td> <td></td> </tr> <tr> <td>maxInclusive</td> <td>99999</td> <td></td> </tr> </tbody> </table> | Kind | Value | Annotation | minInclusive | 1 | | maxInclusive | 99999 | |
| Kind | Value | Annotation | | | | | | | | |
| minInclusive | 1 | | | | | | | | | |
| maxInclusive | 99999 | | | | | | | | | |
| annotation | documentation Facette zur Festlegung der 5-stelligen Ganzzahlenwerte | | | | | | | | | |
| source | <pre> <simpleType name="Zahl5"> <annotation> <documentation>Facette zur Festlegung der 5-stelligen Ganzzahlenwerte</documentation> </annotation> <restriction base="xs:positiveInteger"> <minInclusive value="1"/> <maxInclusive value="99999"/> </restriction> </simpleType> </pre> | | | | | | | | | |

simpleType **Zahl5mitNull**

| namespace | http://xml.ir-d.de/irdsa | | | | | | | | | |
|--------------|---|------------|-------|------------|--------------|---|--|--------------|-------|--|
| type | restriction of integer | | | | | | | | | |
| properties | base xs:integer | | | | | | | | | |
| facets | <table border="1"> <thead> <tr> <th>Kind</th> <th>Value</th> <th>Annotation</th> </tr> </thead> <tbody> <tr> <td>minInclusive</td> <td>0</td> <td></td> </tr> <tr> <td>maxInclusive</td> <td>99999</td> <td></td> </tr> </tbody> </table> | Kind | Value | Annotation | minInclusive | 0 | | maxInclusive | 99999 | |
| Kind | Value | Annotation | | | | | | | | |
| minInclusive | 0 | | | | | | | | | |
| maxInclusive | 99999 | | | | | | | | | |
| annotation | documentation Facette zur Festlegung der 5-stelligen Ganzzahlenwerte inklusive "0" | | | | | | | | | |
| source | <pre> <simpleType name="Zahl5mitNull"> <annotation> <documentation>Facette zur Festlegung der 5-stelligen Ganzzahlenwerte inklusive "0"</documentation> </annotation> <restriction base="xs:integer"> <minInclusive value="0"/> <maxInclusive value="99999"/> </restriction> </simpleType> </pre> | | | | | | | | | |

complexType **MeldungIrdBasis**

| | |
|-----------|---|
| diagram | |
| namespace | http://xml.ir-d.de/irdsa |
| children | MEL_IrdIdGesundheitseinrichtung |
| used by | complexType Storno |

| | |
|--------|--|
| source | <pre><complexType name="MeldungIrdBasis"> <sequence> <element name="MEL_IrdIdGesundheitseinrichtung" type="IdEinrichtung"/> </sequence> </complexType></pre> |
|--------|--|

element **MeldungIrdBasis/MEL_IrdIdGesundheitseinrichtung**

| diagram | | | | | | | |
|------------|--|------------|-------|------------|---------|-------------------|--|
| type | IdEinrichtung | | | | | | |
| properties | content simple | | | | | | |
| facets | <table border="1"> <thead> <tr> <th>Kind</th> <th>Value</th> <th>Annotation</th> </tr> </thead> <tbody> <tr> <td>pattern</td> <td>(IRD-GE-[0-9]{8})</td> <td></td> </tr> </tbody> </table> | Kind | Value | Annotation | pattern | (IRD-GE-[0-9]{8}) | |
| Kind | Value | Annotation | | | | | |
| pattern | (IRD-GE-[0-9]{8}) | | | | | | |
| source | <pre><element name="MEL_IrdIdGesundheitseinrichtung" type="IdEinrichtung"/></pre> | | | | | | |

complexType **StornoFallBasis**

| | |
|-----------|---|
| diagram | |
| namespace | http://xml.ir-d.de/irdsa |
| children | FAL Transfernummer FAL Aufnahmedatum |
| used by | element Storno/fall |
| source | <pre><complexType name="StornoFallBasis"> <sequence> <element name="FAL_Transfernummer" type="Transfernummer"/> <element name="FAL_Aufnahmedatum" type="xs:date"/> </sequence> </complexType></pre> |

element **StornoFallBasis/FAL_Transfernummer**

| diagram | | | | | | | |
|------------|---|------------|-------|------------|---------|----------------|--|
| type | Transfernummer | | | | | | |
| properties | content simple | | | | | | |
| facets | <table border="1"> <thead> <tr> <th>Kind</th> <th>Value</th> <th>Annotation</th> </tr> </thead> <tbody> <tr> <td>pattern</td> <td>([a-z0-9]{64})</td> <td></td> </tr> </tbody> </table> | Kind | Value | Annotation | pattern | ([a-z0-9]{64}) | |
| Kind | Value | Annotation | | | | | |
| pattern | ([a-z0-9]{64}) | | | | | | |
| source | <pre><element name="FAL_Transfernummer" type="Transfernummer"/></pre> | | | | | | |

element **StornoFallBasis/FAL_Aufnahmedatum**

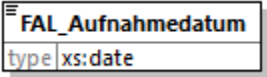
| | |
|------------|---|
| diagram |  |
| type | date |
| properties | content simple |
| source | <code><element name="FAL_Aufnahmedatum" type="xs:date"/></code> |

simpleType **DatumText**

| namespace | http://xml.ir-d.de/sak | | | | | | |
|------------|---|------------|-------|------------|---------|---|--|
| type | restriction of token | | | | | | |
| properties | base xs:token | | | | | | |
| facets | <table border="1"> <thead> <tr> <th>Kind</th> <th>Value</th> <th>Annotation</th> </tr> </thead> <tbody> <tr> <td>pattern</td> <td><code>(([0-9]{4})([-][0-9]{2})?([-][0-9]{2})?)</code></td> <td></td> </tr> </tbody> </table> | Kind | Value | Annotation | pattern | <code>(([0-9]{4})([-][0-9]{2})?([-][0-9]{2})?)</code> | |
| Kind | Value | Annotation | | | | | |
| pattern | <code>(([0-9]{4})([-][0-9]{2})?([-][0-9]{2})?)</code> | | | | | | |
| annotation | documentation Facette zur Festlegung des freien Datumformats: JJJJ[-MM[-TT]] | | | | | | |
| source | <code><simpleType name="DatumText"> <annotation> <documentation>Facette zur Festlegung des freien Datumformats: JJJJ[-MM[-TT]]</documentation> </annotation> <restriction base="xs:token"> <pattern value="((([0-9]{4})([-][0-9]{2})?([-][0-9]{2})?)"/> </restriction> </simpleType></code> | | | | | | |

simpleType **Freitext250**

| namespace | http://xml.ir-d.de/sak | | | | | | |
|------------|--|------------|-------|------------|-----------|-----|--|
| type | restriction of token | | | | | | |
| properties | base xs:token | | | | | | |
| facets | <table border="1"> <thead> <tr> <th>Kind</th> <th>Value</th> <th>Annotation</th> </tr> </thead> <tbody> <tr> <td>maxLength</td> <td>250</td> <td></td> </tr> </tbody> </table> | Kind | Value | Annotation | maxLength | 250 | |
| Kind | Value | Annotation | | | | | |
| maxLength | 250 | | | | | | |
| annotation | documentation Facette zur Festlegung des Freitextes von 250 Zeichen | | | | | | |
| source | <code><simpleType name="Freitext250"> <annotation> <documentation>Facette zur Festlegung des Freitextes von 250 Zeichen</documentation> </annotation> <restriction base="xs:token"> <maxLength value="250"/> </restriction> </simpleType></code> | | | | | | |

simpleType **Freitext500**

| namespace | http://xml.ir-d.de/sak | | | | | | |
|------------|--|------------|-------|------------|-----------|-----|--|
| type | restriction of token | | | | | | |
| properties | base xs:token | | | | | | |
| facets | <table><thead><tr><th>Kind</th><th>Value</th><th>Annotation</th></tr></thead><tbody><tr><td>maxLength</td><td>500</td><td></td></tr></tbody></table> | Kind | Value | Annotation | maxLength | 500 | |
| Kind | Value | Annotation | | | | | |
| maxLength | 500 | | | | | | |
| annotation | documentation Facette zur Festlegung des Freitextes von 500 Zeichen | | | | | | |
| source | <pre><simpleType name="Freitext500"> <annotation> <documentation>Facette zur Festlegung des Freitextes von 500 Zeichen</documentation> </annotation> <restriction base="xs:token"> <maxLength value="500"/> </restriction> </simpleType></pre> | | | | | | |

simpleType **HashString**

| namespace | http://xml.ir-d.de/sak | | | | | | |
|------------|--|------------|-------|------------|-----------|-----|--|
| type | restriction of token | | | | | | |
| properties | base xs:token | | | | | | |
| facets | <table><thead><tr><th>Kind</th><th>Value</th><th>Annotation</th></tr></thead><tbody><tr><td>maxLength</td><td>512</td><td></td></tr></tbody></table> | Kind | Value | Annotation | maxLength | 512 | |
| Kind | Value | Annotation | | | | | |
| maxLength | 512 | | | | | | |
| annotation | documentation Facette zur Festlegung des Hash-Strings der Meldebestätigung | | | | | | |
| source | <pre><simpleType name="HashString"> <annotation> <documentation>Facette zur Festlegung des Hash-Strings der Meldebestätigung</documentation> </annotation> <restriction base="xs:token"> <maxLength value="512"/> </restriction> </simpleType></pre> | | | | | | |

simpleType **HashWert**

| namespace | http://xml.ir-d.de/sak | | | | | | |
|------------|--|------------|-------|------------|--------|----|--|
| type | restriction of token | | | | | | |
| properties | base xs:token | | | | | | |
| facets | <table><thead><tr><th>Kind</th><th>Value</th><th>Annotation</th></tr></thead><tbody><tr><td>length</td><td>64</td><td></td></tr></tbody></table> | Kind | Value | Annotation | length | 64 | |
| Kind | Value | Annotation | | | | | |
| length | 64 | | | | | | |
| annotation | documentation Facette zur Festlegung des Hashwertes der Meldebestätigung | | | | | | |
| source | <pre><simpleType name="HashWert"> <annotation> <documentation>Facette zur Festlegung des Hashwertes der Meldebestätigung</documentation> </annotation></pre> | | | | | | |

| | |
|--|--|
| | <pre> <restriction base="xs:token"> <length value="64"/> </restriction> </simpleType> </pre> |
|--|--|

simpleType ICD

| namespace | http://xml.ir-d.de/sak | | | | | | |
|------------|---|------------|-------|------------|---------|--|--|
| type | restriction of token | | | | | | |
| properties | base xs:token | | | | | | |
| facets | <table border="1"> <thead> <tr> <th>Kind</th> <th>Value</th> <th>Annotation</th> </tr> </thead> <tbody> <tr> <td>pattern</td> <td>([a-zA-Z][0-9]{2}(\.[0-9]{1,2})?(:[RLB])?)</td> <td></td> </tr> </tbody> </table> | Kind | Value | Annotation | pattern | ([a-zA-Z][0-9]{2}(\.[0-9]{1,2})?(:[RLB])?) | |
| Kind | Value | Annotation | | | | | |
| pattern | ([a-zA-Z][0-9]{2}(\.[0-9]{1,2})?(:[RLB])?) | | | | | | |
| annotation | documentation Facette zur Festlegung des ICD Code | | | | | | |
| source | <pre> <simpleType name="ICD"> <annotation> <documentation>Facette zur Festlegung des ICD Code</documentation> </annotation> <restriction base="xs:token"> <pattern value="([a-zA-Z][0-9]{2}(\.[0-9]{1,2})?(:[RLB])?)"/> </restriction> </simpleType> </pre> | | | | | | |

simpleType IdEinrichtung

| namespace | http://xml.ir-d.de/sak | | | | | | |
|------------|---|------------|-------|------------|---------|-------------------|--|
| type | restriction of token | | | | | | |
| properties | base xs:token | | | | | | |
| used by | element MeldungIrdBasis/MEL_IrdIdGesundheitseinrichtung | | | | | | |
| facets | <table border="1"> <thead> <tr> <th>Kind</th> <th>Value</th> <th>Annotation</th> </tr> </thead> <tbody> <tr> <td>pattern</td> <td>(IRD-GE-[0-9]{8})</td> <td></td> </tr> </tbody> </table> | Kind | Value | Annotation | pattern | (IRD-GE-[0-9]{8}) | |
| Kind | Value | Annotation | | | | | |
| pattern | (IRD-GE-[0-9]{8}) | | | | | | |
| annotation | documentation Facette zur Festlegung der Gesundheitseinrichtung-ID | | | | | | |
| source | <pre> <simpleType name="IdEinrichtung"> <annotation> <documentation>Facette zur Festlegung der Gesundheitseinrichtung-ID</documentation> </annotation> <restriction base="xs:token"> <pattern value="(IRD-GE-[0-9]{8})"/> </restriction> </simpleType> </pre> | | | | | | |

simpleType IrdArtikeld

| namespace | http://xml.ir-d.de/sak | | | | | | |
|------------|---|------------|-------|------------|-----------|----|--|
| type | restriction of token | | | | | | |
| properties | base xs:token | | | | | | |
| facets | <table border="1"> <thead> <tr> <th>Kind</th> <th>Value</th> <th>Annotation</th> </tr> </thead> <tbody> <tr> <td>maxLength</td> <td>16</td> <td></td> </tr> </tbody> </table> | Kind | Value | Annotation | maxLength | 16 | |
| Kind | Value | Annotation | | | | | |
| maxLength | 16 | | | | | | |

| | |
|------------|---|
| annotation | documentation Facette zur Festlegung der IrdNummer |
| source | <pre><simpleType name="IrdArtikelId"> <annotation> <documentation>Facette zur Festlegung der IrdNummer</documentation> </annotation> <restriction base="xs:token"> <maxLength value="16"/> </restriction> </simpleType></pre> |

simpleType IrdSpezVersion

| namespace | http://xml.ir-d.de/sak | | | | | | |
|------------|---|------------|-------|------------|---------|--------------------------------------|--|
| type | restriction of token | | | | | | |
| properties | base xs:token | | | | | | |
| facets | <table border="1"> <thead> <tr> <th>Kind</th> <th>Value</th> <th>Annotation</th> </tr> </thead> <tbody> <tr> <td>pattern</td> <td>(([1-9][1-9][0-9])\.\d{1-9} \d{1-9})</td> <td></td> </tr> </tbody> </table> | Kind | Value | Annotation | pattern | (([1-9][1-9][0-9])\.\d{1-9} \d{1-9}) | |
| Kind | Value | Annotation | | | | | |
| pattern | (([1-9][1-9][0-9])\.\d{1-9} \d{1-9}) | | | | | | |
| annotation | documentation Facette zur Festlegung der Version der IRD-Spezifikation | | | | | | |
| source | <pre><simpleType name="IrdSpezVersion"> <annotation> <documentation>Facette zur Festlegung der Version der IRD-Spezifikation</documentation> </annotation> <restriction base="xs:token"> <pattern value="(([1-9][1-9][0-9])\.\d{1-9} \d{1-9})"/> </restriction> </simpleType></pre> | | | | | | |

simpleType JaLeer

| namespace | http://xml.ir-d.de/sak | | | | | | |
|------------|--|------------|-------|------------|---------|-----|--|
| type | restriction of integer | | | | | | |
| properties | base xs:integer | | | | | | |
| facets | <table border="1"> <thead> <tr> <th>Kind</th> <th>Value</th> <th>Annotation</th> </tr> </thead> <tbody> <tr> <td>pattern</td> <td>(1)</td> <td></td> </tr> </tbody> </table> | Kind | Value | Annotation | pattern | (1) | |
| Kind | Value | Annotation | | | | | |
| pattern | (1) | | | | | | |
| annotation | documentation Facette zur Festlegung des Unbekannt-Wertes (Bedeutung 1=true) | | | | | | |
| source | <pre><simpleType name="JaLeer"> <annotation> <documentation>Facette zur Festlegung des Unbekannt-Wertes (Bedeutung 1=true)</documentation> </annotation> <restriction base="xs:integer"> <pattern value="(1)"/> </restriction> </simpleType></pre> | | | | | | |

simpleType **Meldebestaetigung**

| | | | | | | | |
|------------|--|------------|-------|------------|--------|----|--|
| namespace | http://xml.ir-d.de/sak | | | | | | |
| type | restriction of token | | | | | | |
| properties | base xs:token | | | | | | |
| facets | <table border="1"> <tr> <td>Kind</td> <td>Value</td> <td>Annotation</td> </tr> <tr> <td>length</td> <td>10</td> <td></td> </tr> </table> | Kind | Value | Annotation | length | 10 | |
| Kind | Value | Annotation | | | | | |
| length | 10 | | | | | | |
| annotation | documentation Facette zur Festlegung der Meldebestätigungslaenge von 10 Zeichen | | | | | | |
| source | <pre> <simpleType name="Meldebestaetigung"> <annotation> <documentation>Facette zur Festlegung der Meldebestätigungslaenge von 10 Zeichen</documentation> </annotation> <restriction base="xs:token"> <length value="10"/> </restriction> </simpleType> </pre> | | | | | | |

simpleType **OPS**

| | | | | | | | |
|------------|---|------------|-------|------------|---------|---|--|
| namespace | http://xml.ir-d.de/sak | | | | | | |
| type | restriction of token | | | | | | |
| properties | base xs:token | | | | | | |
| facets | <table border="1"> <tr> <td>Kind</td> <td>Value</td> <td>Annotation</td> </tr> <tr> <td>pattern</td> <td>(([135689]\-([0-9]){2}([a-zA-Z0-9]){1}\.([a-zA-Z0-9]{1,2}))*(:[RLBr1b])?)</td> <td></td> </tr> </table> | Kind | Value | Annotation | pattern | (([135689]\-([0-9]){2}([a-zA-Z0-9]){1}\.([a-zA-Z0-9]{1,2}))*(:[RLBr1b])?) | |
| Kind | Value | Annotation | | | | | |
| pattern | (([135689]\-([0-9]){2}([a-zA-Z0-9]){1}\.([a-zA-Z0-9]{1,2}))*(:[RLBr1b])?) | | | | | | |
| annotation | documentation Facette zur Festlegung des Prozedurenschlüssels | | | | | | |
| source | <pre> <simpleType name="OPS"> <annotation> <documentation>Facette zur Festlegung des Prozedurenschlüssels</documentation> </annotation> <restriction base="xs:token"> <pattern value="(([135689]\-([0-9]){2}([a-zA-Z0-9]){1}\.([a-zA-Z0-9]{1,2}))*(:[RLBr1b]) ?)"/> </restriction> </simpleType> </pre> | | | | | | |

simpleType **String2**

| | | | | | | | |
|------------|---|------------|-------|------------|---------|------------|--|
| namespace | http://xml.ir-d.de/sak | | | | | | |
| type | restriction of token | | | | | | |
| properties | base xs:token | | | | | | |
| facets | <table border="1"> <tr> <td>Kind</td> <td>Value</td> <td>Annotation</td> </tr> <tr> <td>pattern</td> <td>([0-9]{2})</td> <td></td> </tr> </table> | Kind | Value | Annotation | pattern | ([0-9]{2}) | |
| Kind | Value | Annotation | | | | | |
| pattern | ([0-9]{2}) | | | | | | |
| annotation | documentation Facette zur Festlegung des kodierten Entlassungsgrundes | | | | | | |
| source | <pre> <simpleType name="String2"> </pre> | | | | | | |

| | |
|--|---|
| | <pre> <annotation> <documentation>Facette zur Festlegung des kodierten Entlassungsgrundes</documentation> </annotation> <restriction base="xs:token"> <pattern value="([0-9]{2})"/> </restriction> </simpleType> </pre> |
|--|---|

simpleType String20

| namespace | http://xml.ir-d.de/sak | | | | | | |
|------------|---|------------|-------|------------|-----------|----|--|
| type | restriction of token | | | | | | |
| properties | base xs:token | | | | | | |
| facets | <table border="1"> <thead> <tr> <th>Kind</th> <th>Value</th> <th>Annotation</th> </tr> </thead> <tbody> <tr> <td>maxLength</td> <td>20</td> <td></td> </tr> </tbody> </table> | Kind | Value | Annotation | maxLength | 20 | |
| Kind | Value | Annotation | | | | | |
| maxLength | 20 | | | | | | |
| annotation | documentation Facette zur Festlegung von: Artikel-, Ident-, Serien-, Lot-Nummer des Produkts | | | | | | |
| source | <pre> <simpleType name="String20"> <annotation> <documentation>Facette zur Festlegung von: Artikel-, Ident-, Serien-, Lot-Nummer des Produkts</documentation> </annotation> <restriction base="xs:token"> <maxLength value="20"/> </restriction> </simpleType> </pre> | | | | | | |

simpleType Sw

| namespace | http://xml.ir-d.de/sak | | | | | | |
|------------|--|------------|-------|------------|-----------|-----|--|
| type | restriction of token | | | | | | |
| properties | base xs:token | | | | | | |
| facets | <table border="1"> <thead> <tr> <th>Kind</th> <th>Value</th> <th>Annotation</th> </tr> </thead> <tbody> <tr> <td>maxLength</td> <td>120</td> <td></td> </tr> </tbody> </table> | Kind | Value | Annotation | maxLength | 120 | |
| Kind | Value | Annotation | | | | | |
| maxLength | 120 | | | | | | |
| annotation | documentation Facette für Merkmale der externen Software | | | | | | |
| source | <pre> <simpleType name="Sw"> <annotation> <documentation>Facette für Merkmale der externen Software</documentation> </annotation> <restriction base="xs:token"> <maxLength value="120"/> </restriction> </simpleType> </pre> | | | | | | |

simpleType Transfervummer

| | |
|-----------|-----------------------------|
| namespace | http://xml.ir-d.de/sak |
| type | restriction of token |

| properties | base xs:token | | | | | | |
|------------|--|------------|-------|------------|---------|----------------|--|
| used by | element SelbstauskunftFallBasis/FAL Transfervummer | | | | | | |
| facets | <table border="1"> <thead> <tr> <th>Kind</th> <th>Value</th> <th>Annotation</th> </tr> </thead> <tbody> <tr> <td>pattern</td> <td>([a-z0-9]{64})</td> <td></td> </tr> </tbody> </table> | Kind | Value | Annotation | pattern | ([a-z0-9]{64}) | |
| Kind | Value | Annotation | | | | | |
| pattern | ([a-z0-9]{64}) | | | | | | |
| annotation | documentation Facette zur Festlegung der Transfervummer | | | | | | |
| source | <pre><simpleType name="Transfervummer"> <annotation> <documentation>Facette zur Festlegung der Transfervummer</documentation> </annotation> <restriction base="xs:token"> <pattern value="([a-z0-9]{64})"/> </restriction> </simpleType></pre> | | | | | | |

simpleType Versionsnummer

| namespace | http://xml.ir-d.de/sak | | | | | | |
|------------|--|------------|-------|------------|-----------|----|--|
| type | restriction of token | | | | | | |
| properties | base xs:token | | | | | | |
| facets | <table border="1"> <thead> <tr> <th>Kind</th> <th>Value</th> <th>Annotation</th> </tr> </thead> <tbody> <tr> <td>maxLength</td> <td>10</td> <td></td> </tr> </tbody> </table> | Kind | Value | Annotation | maxLength | 10 | |
| Kind | Value | Annotation | | | | | |
| maxLength | 10 | | | | | | |
| annotation | documentation Facette zur Festlegung der Versionsnummer des gelieferten Datensatzes | | | | | | |
| source | <pre><simpleType name="Versionsnummer"> <annotation> <documentation>Facette zur Festlegung der Versionsnummer des gelieferten Datensatzes</documentation> </annotation> <restriction base="xs:token"> <maxLength value="10"/> </restriction> </simpleType></pre> | | | | | | |

simpleType Zahl1

| namespace | http://xml.ir-d.de/sak | | | | | | | | | |
|--------------|--|------------|-------|------------|--------------|---|--|--------------|---|--|
| type | restriction of positiveInteger | | | | | | | | | |
| properties | base xs:positiveInteger | | | | | | | | | |
| facets | <table border="1"> <thead> <tr> <th>Kind</th> <th>Value</th> <th>Annotation</th> </tr> </thead> <tbody> <tr> <td>minInclusive</td> <td>1</td> <td></td> </tr> <tr> <td>maxInclusive</td> <td>9</td> <td></td> </tr> </tbody> </table> | Kind | Value | Annotation | minInclusive | 1 | | maxInclusive | 9 | |
| Kind | Value | Annotation | | | | | | | | |
| minInclusive | 1 | | | | | | | | | |
| maxInclusive | 9 | | | | | | | | | |
| annotation | documentation Facette zur Festlegung der 1-stelligen Ganzzahlenwerte | | | | | | | | | |
| source | <pre><simpleType name="Zahl1"> <annotation> <documentation>Facette zur Festlegung der 1-stelligen Ganzzahlenwerte</documentation> </annotation> <restriction base="xs:positiveInteger"> <minInclusive value="1"/> </restriction> </simpleType></pre> | | | | | | | | | |

```

    <maxInclusive value="9"/>
  </restriction>
</simpleType>

```

simpleType Zahl1_1

| namespace | http://xml.ir-d.de/sak | | | | | | | | | | | | | | | |
|----------------|---|------------|-------|------------|--------------|-----|--|--------------|-----|--|-------------|---|--|----------------|---|--|
| type | restriction of decimal | | | | | | | | | | | | | | | |
| properties | base xs:decimal | | | | | | | | | | | | | | | |
| facets | <table border="1"> <thead> <tr> <th>Kind</th> <th>Value</th> <th>Annotation</th> </tr> </thead> <tbody> <tr> <td>minInclusive</td> <td>0.1</td> <td></td> </tr> <tr> <td>maxInclusive</td> <td>9.9</td> <td></td> </tr> <tr> <td>totalDigits</td> <td>2</td> <td></td> </tr> <tr> <td>fractionDigits</td> <td>1</td> <td></td> </tr> </tbody> </table> | Kind | Value | Annotation | minInclusive | 0.1 | | maxInclusive | 9.9 | | totalDigits | 2 | | fractionDigits | 1 | |
| Kind | Value | Annotation | | | | | | | | | | | | | | |
| minInclusive | 0.1 | | | | | | | | | | | | | | | |
| maxInclusive | 9.9 | | | | | | | | | | | | | | | |
| totalDigits | 2 | | | | | | | | | | | | | | | |
| fractionDigits | 1 | | | | | | | | | | | | | | | |
| annotation | documentation Facette zur Festlegung des Formats [N].[N] | | | | | | | | | | | | | | | |
| source | <pre> <simpleType name="Zahl1_1"> <annotation> <documentation>Facette zur Festlegung des Formats [N].[N]</documentation> </annotation> <restriction base="xs:decimal"> <totalDigits value="2"/> <fractionDigits value="1"/> <minInclusive value="0.1"/> <maxInclusive value="9.9"/> </restriction> </simpleType> </pre> | | | | | | | | | | | | | | | |

simpleType Zahl2

| namespace | http://xml.ir-d.de/sak | | | | | | | | | |
|--------------|---|------------|-------|------------|--------------|---|--|--------------|----|--|
| type | restriction of positiveInteger | | | | | | | | | |
| properties | base xs:positiveInteger | | | | | | | | | |
| facets | <table border="1"> <thead> <tr> <th>Kind</th> <th>Value</th> <th>Annotation</th> </tr> </thead> <tbody> <tr> <td>minInclusive</td> <td>1</td> <td></td> </tr> <tr> <td>maxInclusive</td> <td>99</td> <td></td> </tr> </tbody> </table> | Kind | Value | Annotation | minInclusive | 1 | | maxInclusive | 99 | |
| Kind | Value | Annotation | | | | | | | | |
| minInclusive | 1 | | | | | | | | | |
| maxInclusive | 99 | | | | | | | | | |
| annotation | documentation Facette zur Festlegung der 2-stelligen Ganzzahlenwerte | | | | | | | | | |
| source | <pre> <simpleType name="Zahl2"> <annotation> <documentation>Facette zur Festlegung der 2-stelligen Ganzzahlenwerte</documentation> </annotation> <restriction base="xs:positiveInteger"> <minInclusive value="1"/> <maxInclusive value="99"/> </restriction> </simpleType> </pre> | | | | | | | | | |

simpleType Zahl2_1

| namespace | http://xml.ir-d.de/sak | | | | | | | | | | | | | | | |
|----------------|---|------------|-------|------------|--------------|-----|--|--------------|------|--|-------------|---|--|----------------|---|--|
| type | restriction of decimal | | | | | | | | | | | | | | | |
| properties | base xs:decimal | | | | | | | | | | | | | | | |
| facets | <table border="1"> <thead> <tr> <th>Kind</th> <th>Value</th> <th>Annotation</th> </tr> </thead> <tbody> <tr> <td>minInclusive</td> <td>0.1</td> <td></td> </tr> <tr> <td>maxInclusive</td> <td>99.9</td> <td></td> </tr> <tr> <td>totalDigits</td> <td>3</td> <td></td> </tr> <tr> <td>fractionDigits</td> <td>1</td> <td></td> </tr> </tbody> </table> | Kind | Value | Annotation | minInclusive | 0.1 | | maxInclusive | 99.9 | | totalDigits | 3 | | fractionDigits | 1 | |
| Kind | Value | Annotation | | | | | | | | | | | | | | |
| minInclusive | 0.1 | | | | | | | | | | | | | | | |
| maxInclusive | 99.9 | | | | | | | | | | | | | | | |
| totalDigits | 3 | | | | | | | | | | | | | | | |
| fractionDigits | 1 | | | | | | | | | | | | | | | |
| annotation | documentation Facette zur Festlegung des Formats [NN].[N] | | | | | | | | | | | | | | | |
| source | <pre><simpleType name="Zahl2_1"> <annotation> <documentation>Facette zur Festlegung des Formats [NN].[N]</documentation> </annotation> <restriction base="xs:decimal"> <totalDigits value="3"/> <fractionDigits value="1"/> <minInclusive value="0.1"/> <maxInclusive value="99.9"/> </restriction> </simpleType></pre> | | | | | | | | | | | | | | | |

simpleType Zahl3

| namespace | http://xml.ir-d.de/sak | | | | | | | | | |
|--------------|--|------------|-------|------------|--------------|---|--|--------------|-----|--|
| type | restriction of positiveInteger | | | | | | | | | |
| properties | base xs:positiveInteger | | | | | | | | | |
| facets | <table border="1"> <thead> <tr> <th>Kind</th> <th>Value</th> <th>Annotation</th> </tr> </thead> <tbody> <tr> <td>minInclusive</td> <td>1</td> <td></td> </tr> <tr> <td>maxInclusive</td> <td>999</td> <td></td> </tr> </tbody> </table> | Kind | Value | Annotation | minInclusive | 1 | | maxInclusive | 999 | |
| Kind | Value | Annotation | | | | | | | | |
| minInclusive | 1 | | | | | | | | | |
| maxInclusive | 999 | | | | | | | | | |
| annotation | documentation Facette zur Festlegung der 3-stelligen Ganzzahlenwerte | | | | | | | | | |
| source | <pre><simpleType name="Zahl3"> <annotation> <documentation>Facette zur Festlegung der 3-stelligen Ganzzahlenwerte</documentation> </annotation> <restriction base="xs:positiveInteger"> <minInclusive value="1"/> <maxInclusive value="999"/> </restriction> </simpleType></pre> | | | | | | | | | |

simpleType Zahl3_1

| namespace | http://xml.ir-d.de/sak | | | |
|------------|---|------------|-------|------------|
| type | restriction of decimal | | | |
| properties | base xs:decimal | | | |
| facets | <table border="1"> <thead> <tr> <th>Kind</th> <th>Value</th> <th>Annotation</th> </tr> </thead> <tbody> </tbody> </table> | Kind | Value | Annotation |
| Kind | Value | Annotation | | |

| | |
|------------|---|
| | minInclusive 0.1 maxInclusive 999.9 totalDigits 4 fractionDigits 1 |
| annotation | documentation Facette zur Festlegung des Formats [NNN].[N] |
| source | <pre> <simpleType name="Zahl3_1"> <annotation> <documentation>Facette zur Festlegung des Formats [NNN].[N]</documentation> </annotation> <restriction base="xs:decimal"> <totalDigits value="4"/> <fractionDigits value="1"/> <minInclusive value="0.1"/> <maxInclusive value="999.9"/> </restriction> </simpleType> </pre> |

simpleType Zahl4

| namespace | http://xml.ir-d.de/sak | | | | | | | | | |
|--------------|---|------------|-------|------------|--------------|---|--|--------------|------|--|
| type | restriction of positiveInteger | | | | | | | | | |
| properties | base xs:positiveInteger | | | | | | | | | |
| facets | <table border="1"> <thead> <tr> <th>Kind</th> <th>Value</th> <th>Annotation</th> </tr> </thead> <tbody> <tr> <td>minInclusive</td> <td>1</td> <td></td> </tr> <tr> <td>maxInclusive</td> <td>9999</td> <td></td> </tr> </tbody> </table> | Kind | Value | Annotation | minInclusive | 1 | | maxInclusive | 9999 | |
| Kind | Value | Annotation | | | | | | | | |
| minInclusive | 1 | | | | | | | | | |
| maxInclusive | 9999 | | | | | | | | | |
| annotation | documentation Facette zur Festlegung der 4-stelligen Ganzzahlenwerte | | | | | | | | | |
| source | <pre> <simpleType name="Zahl4"> <annotation> <documentation>Facette zur Festlegung der 4-stelligen Ganzzahlenwerte</documentation> </annotation> <restriction base="xs:positiveInteger"> <minInclusive value="1"/> <maxInclusive value="9999"/> </restriction> </simpleType> </pre> | | | | | | | | | |

simpleType Zahl5

| namespace | http://xml.ir-d.de/sak | | | | | | | | | |
|--------------|---|------------|-------|------------|--------------|---|--|--------------|-------|--|
| type | restriction of positiveInteger | | | | | | | | | |
| properties | base xs:positiveInteger | | | | | | | | | |
| facets | <table border="1"> <thead> <tr> <th>Kind</th> <th>Value</th> <th>Annotation</th> </tr> </thead> <tbody> <tr> <td>minInclusive</td> <td>1</td> <td></td> </tr> <tr> <td>maxInclusive</td> <td>99999</td> <td></td> </tr> </tbody> </table> | Kind | Value | Annotation | minInclusive | 1 | | maxInclusive | 99999 | |
| Kind | Value | Annotation | | | | | | | | |
| minInclusive | 1 | | | | | | | | | |
| maxInclusive | 99999 | | | | | | | | | |
| annotation | documentation Facette zur Festlegung der 5-stelligen Ganzzahlenwerte | | | | | | | | | |
| source | <pre> <simpleType name="Zahl5"> <annotation> <documentation>Facette zur Festlegung der 5-stelligen </pre> | | | | | | | | | |

| | |
|--|---|
| | <pre>Ganzzahlenwerte</documentation> </annotation> <restriction base="xs:positiveInteger"> <minInclusive value="1"/> <maxInclusive value="99999"/> </restriction> </simpleType></pre> |
|--|---|

simpleType **Zahl5mitNull**

| namespace | http://xml.ir-d.de/sak | | | | | | | | | |
|--------------|---|------------|-------|------------|--------------|---|--|--------------|-------|--|
| type | restriction of integer | | | | | | | | | |
| properties | base xs:integer | | | | | | | | | |
| facets | <table border="1"> <thead> <tr> <th>Kind</th> <th>Value</th> <th>Annotation</th> </tr> </thead> <tbody> <tr> <td>minInclusive</td> <td>0</td> <td></td> </tr> <tr> <td>maxInclusive</td> <td>99999</td> <td></td> </tr> </tbody> </table> | Kind | Value | Annotation | minInclusive | 0 | | maxInclusive | 99999 | |
| Kind | Value | Annotation | | | | | | | | |
| minInclusive | 0 | | | | | | | | | |
| maxInclusive | 99999 | | | | | | | | | |
| annotation | documentation Facette zur Festlegung der 5-stelligen Ganzzahlenwerte inklusive "0" | | | | | | | | | |
| source | <pre><simpleType name="Zahl5mitNull"> <annotation> <documentation>Facette zur Festlegung der 5-stelligen Ganzzahlenwerte inklusive "0"</documentation> </annotation> <restriction base="xs:integer"> <minInclusive value="0"/> <maxInclusive value="99999"/> </restriction> </simpleType></pre> | | | | | | | | | |

complexType **MeldungIrdBasis**

| | |
|-----------|--|
| diagram | <pre>classDiagram class MeldungIrdBasis { } class MEL_IrdIdGesundheitseinrichtung { IdEinrichtung pattern (IRD-GE-[0-9]{8}) } MeldungIrdBasis "1" -- "*" MEL_IrdIdGesundheitseinrichtung</pre> |
| namespace | http://xml.ir-d.de/sak |
| children | MEL_IrdIdGesundheitseinrichtung |
| used by | complexType Selbstauskunft |
| source | <pre><complexType name="MeldungIrdBasis"> <sequence> <element name="MEL_IrdIdGesundheitseinrichtung" type="IdEinrichtung"/> </sequence> </complexType></pre> |

element **MeldungIrdBasis/MEL_IrdIdGesundheitseinrichtung**

| | |
|---------|---|
| diagram | <pre>classDiagram class MEL_IrdIdGesundheitseinrichtung { IdEinrichtung pattern (IRD-GE-[0-9]{8}) }</pre> |
|---------|---|

| type | IdEinrichtung | | | | | | |
|------------|--|------------|-------|------------|---------|-------------------|--|
| properties | content simple | | | | | | |
| facets | <table border="1"> <thead> <tr> <th>Kind</th> <th>Value</th> <th>Annotation</th> </tr> </thead> <tbody> <tr> <td>pattern</td> <td>(IRD-GE-[0-9]{8})</td> <td></td> </tr> </tbody> </table> | Kind | Value | Annotation | pattern | (IRD-GE-[0-9]{8}) | |
| Kind | Value | Annotation | | | | | |
| pattern | (IRD-GE-[0-9]{8}) | | | | | | |
| source | <code><element name="MEL_IrdIdGesundheitseinrichtung" type="IdEinrichtung"/></code> | | | | | | |

complexType **SelbstauskunftFallBasis**

| | |
|-----------|--|
| diagram | |
| namespace | http://xml.ir-d.de/sak |
| children | FAL Transfernummer |
| used by | element Selbstauskunft/fall |
| source | <pre><complexType name="SelbstauskunftFallBasis"> <sequence> <element name="FAL_Transfernummer" type="Transfernummer"/> </sequence> </complexType></pre> |

element **SelbstauskunftFallBasis/FAL_Transfernummer**

| diagram | | | | | | | |
|------------|---|------------|-------|------------|---------|----------------|--|
| type | Transfernummer | | | | | | |
| properties | content simple | | | | | | |
| facets | <table border="1"> <thead> <tr> <th>Kind</th> <th>Value</th> <th>Annotation</th> </tr> </thead> <tbody> <tr> <td>pattern</td> <td>([a-z0-9]{64})</td> <td></td> </tr> </tbody> </table> | Kind | Value | Annotation | pattern | ([a-z0-9]{64}) | |
| Kind | Value | Annotation | | | | | |
| pattern | ([a-z0-9]{64}) | | | | | | |
| source | <code><element name="FAL_Transfernummer" type="Transfernummer"/></code> | | | | | | |

simpleType **DatumText**

| namespace | http://xml.ir-d.de/irdsaa | | | | | | |
|------------|---|------------|-------|------------|---------|------------------------------------|--|
| type | restriction of token | | | | | | |
| properties | base xs:token | | | | | | |
| facets | <table border="1"> <thead> <tr> <th>Kind</th> <th>Value</th> <th>Annotation</th> </tr> </thead> <tbody> <tr> <td>pattern</td> <td>(([0-9]{4})([0-9]{2})?([0-9]{2})?)</td> <td></td> </tr> </tbody> </table> | Kind | Value | Annotation | pattern | (([0-9]{4})([0-9]{2})?([0-9]{2})?) | |
| Kind | Value | Annotation | | | | | |
| pattern | (([0-9]{4})([0-9]{2})?([0-9]{2})?) | | | | | | |
| annotation | <p>documentation</p> <p>Facette zur Festlegung des freien Datumformats: JJJJ[-MM[-TT]]</p> | | | | | | |
| source | <pre><simpleType name="DatumText"> <annotation> <documentation>Facette zur Festlegung des freien Datumformats: JJJJ[-MM[-TT]]</documentation> </annotation></pre> | | | | | | |

| | |
|--|--|
| | <pre> <restriction base="xs:token"> <pattern value="(([\0-9]{4})([-][\0-9]{2})?([-][\0-9]{2})?)"/> </restriction> </simpleType> </pre> |
|--|--|

simpleType **Freitext250**

| namespace | http://xml.ir-d.de/irdsaa | | | | | | |
|------------|--|------------|-------|------------|-----------|-----|--|
| type | restriction of token | | | | | | |
| properties | base xs:token | | | | | | |
| used by | element EmpfangsbestaetigungBasis/EBG_Empfangsbestaetigung | | | | | | |
| facets | <table border="1"> <thead> <tr> <th>Kind</th> <th>Value</th> <th>Annotation</th> </tr> </thead> <tbody> <tr> <td>maxLength</td> <td>250</td> <td></td> </tr> </tbody> </table> | Kind | Value | Annotation | maxLength | 250 | |
| Kind | Value | Annotation | | | | | |
| maxLength | 250 | | | | | | |
| annotation | documentation Facette zur Festlegung des Freitextes von 250 Zeichen | | | | | | |
| source | <pre> <simpleType name="Freitext250"> <annotation> <documentation>Facette zur Festlegung des Freitextes von 250 Zeichen</documentation> </annotation> <restriction base="xs:token"> <maxLength value="250"/> </restriction> </simpleType> </pre> | | | | | | |

simpleType **Freitext500**

| namespace | http://xml.ir-d.de/irdsaa | | | | | | |
|------------|--|------------|-------|------------|-----------|-----|--|
| type | restriction of token | | | | | | |
| properties | base xs:token | | | | | | |
| facets | <table border="1"> <thead> <tr> <th>Kind</th> <th>Value</th> <th>Annotation</th> </tr> </thead> <tbody> <tr> <td>maxLength</td> <td>500</td> <td></td> </tr> </tbody> </table> | Kind | Value | Annotation | maxLength | 500 | |
| Kind | Value | Annotation | | | | | |
| maxLength | 500 | | | | | | |
| annotation | documentation Facette zur Festlegung des Freitextes von 500 Zeichen | | | | | | |
| source | <pre> <simpleType name="Freitext500"> <annotation> <documentation>Facette zur Festlegung des Freitextes von 500 Zeichen</documentation> </annotation> <restriction base="xs:token"> <maxLength value="500"/> </restriction> </simpleType> </pre> | | | | | | |

simpleType **HashString**

| | |
|------------|-----------------------------|
| namespace | http://xml.ir-d.de/irdsaa |
| type | restriction of token |
| properties | base xs:token |

| | |
|------------|--|
| facets | Kind Value Annotation maxLength 512 |
| annotation | documentation Facette zur Festlegung des Hash-Strings der Meldebestätigung |
| source | <pre><simpleType name="HashString"> <annotation> <documentation>Facette zur Festlegung des Hash-Strings der Meldebestätigung</documentation> </annotation> <restriction base="xs:token"> <maxLength value="512"/> </restriction> </simpleType></pre> |

simpleType HashWert

| | |
|------------|--|
| namespace | http://xml.ir-d.de/irdsaa |
| type | restriction of token |
| properties | base xs:token |
| facets | Kind Value Annotation length 64 |
| annotation | documentation Facette zur Festlegung des Hashwertes der Meldebestätigung |
| source | <pre><simpleType name="HashWert"> <annotation> <documentation>Facette zur Festlegung des Hashwertes der Meldebestätigung</documentation> </annotation> <restriction base="xs:token"> <length value="64"/> </restriction> </simpleType></pre> |

simpleType ICD

| | |
|------------|---|
| namespace | http://xml.ir-d.de/irdsaa |
| type | restriction of token |
| properties | base xs:token |
| facets | Kind Value Annotation pattern ([a-zA-Z][0-9]{2}(\.[0-9]{1,2})?(:[RLB])?) |
| annotation | documentation Facette zur Festlegung des ICD Code |
| source | <pre><simpleType name="ICD"> <annotation> <documentation>Facette zur Festlegung des ICD Code</documentation> </annotation> <restriction base="xs:token"> <pattern value="([a-zA-Z][0-9]{2}(\.[0-9]{1,2})?(:[RLB])?)"/> </restriction> </simpleType></pre> |

simpleType IdEinrichtung

| namespace | http://xml.ir-d.de/irdsaa | | | | | | |
|------------|---|------------|-------|------------|---------|-------------------|--|
| type | restriction of token | | | | | | |
| properties | base xs:token | | | | | | |
| used by | element MeldungIrdBasis/MEL_IrdIdGesundheitseinrichtung | | | | | | |
| facets | <table border="1"> <thead> <tr> <th>Kind</th> <th>Value</th> <th>Annotation</th> </tr> </thead> <tbody> <tr> <td>pattern</td> <td>(IRD-GE-[0-9]{8})</td> <td></td> </tr> </tbody> </table> | Kind | Value | Annotation | pattern | (IRD-GE-[0-9]{8}) | |
| Kind | Value | Annotation | | | | | |
| pattern | (IRD-GE-[0-9]{8}) | | | | | | |
| annotation | documentation Facette zur Festlegung der Gesundheitseinrichtung-ID | | | | | | |
| source | <pre><simpleType name="IdEinrichtung"> <annotation> <documentation>Facette zur Festlegung der Gesundheitseinrichtung-ID</documentation> </annotation> <restriction base="xs:token"> <pattern value="(IRD-GE-[0-9]{8})"/> </restriction> </simpleType></pre> | | | | | | |

simpleType IrdArtikelId

| namespace | http://xml.ir-d.de/irdsaa | | | | | | |
|------------|---|------------|-------|------------|-----------|----|--|
| type | restriction of token | | | | | | |
| properties | base xs:token | | | | | | |
| facets | <table border="1"> <thead> <tr> <th>Kind</th> <th>Value</th> <th>Annotation</th> </tr> </thead> <tbody> <tr> <td>maxLength</td> <td>16</td> <td></td> </tr> </tbody> </table> | Kind | Value | Annotation | maxLength | 16 | |
| Kind | Value | Annotation | | | | | |
| maxLength | 16 | | | | | | |
| annotation | documentation Facette zur Festlegung der IrdNummer | | | | | | |
| source | <pre><simpleType name="IrdArtikelId"> <annotation> <documentation>Facette zur Festlegung der IrdNummer</documentation> </annotation> <restriction base="xs:token"> <maxLength value="16"/> </restriction> </simpleType></pre> | | | | | | |

simpleType IrdSpezVersion

| namespace | http://xml.ir-d.de/irdsaa | | | | | | |
|------------|---|------------|-------|------------|---------|--|--|
| type | restriction of token | | | | | | |
| properties | base xs:token | | | | | | |
| facets | <table border="1"> <thead> <tr> <th>Kind</th> <th>Value</th> <th>Annotation</th> </tr> </thead> <tbody> <tr> <td>pattern</td> <td>((([1-9] [1-9][0-9])\.\d{1}[0-9])\.\d{1}[0-9])</td> <td></td> </tr> </tbody> </table> | Kind | Value | Annotation | pattern | ((([1-9] [1-9][0-9])\.\d{1}[0-9])\.\d{1}[0-9]) | |
| Kind | Value | Annotation | | | | | |
| pattern | ((([1-9] [1-9][0-9])\.\d{1}[0-9])\.\d{1}[0-9]) | | | | | | |
| annotation | documentation Facette zur Festlegung der Version der IRD-Spezifikation | | | | | | |
| source | <pre><simpleType name="IrdSpezVersion"> <annotation> <documentation>Facette zur Festlegung der Version der IRD-Spezifikation</documentation> </annotation></pre> | | | | | | |

| | |
|--|--|
| | <pre> </annotation> <restriction base="xs:token"> <pattern value="((([1-9] [1-9][0-9])\.\(\d [1-9][0-9])\.\(\d [1-9][0-9]))"/> </restriction> </simpleType> </pre> |
|--|--|

simpleType JaLeer

| namespace | http://xml.ir-d.de/irdsaa | | | | | | |
|------------|--|------------|-------|------------|---------|-----|--|
| type | restriction of integer | | | | | | |
| properties | base xs:integer | | | | | | |
| facets | <table border="1"> <thead> <tr> <th>Kind</th> <th>Value</th> <th>Annotation</th> </tr> </thead> <tbody> <tr> <td>pattern</td> <td>(1)</td> <td></td> </tr> </tbody> </table> | Kind | Value | Annotation | pattern | (1) | |
| Kind | Value | Annotation | | | | | |
| pattern | (1) | | | | | | |
| annotation | documentation Facette zur Festlegung des Unbekannt-Wertes (Bedeutung 1=true) | | | | | | |
| source | <pre> <simpleType name="JaLeer"> <annotation> <documentation>Facette zur Festlegung des Unbekannt-Wertes (Bedeutung 1=true)</documentation> </annotation> <restriction base="xs:integer"> <pattern value="(1)"/> </restriction> </simpleType> </pre> | | | | | | |

simpleType Meldebestaetigung

| namespace | http://xml.ir-d.de/irdsaa | | | | | | |
|------------|--|------------|-------|------------|--------|----|--|
| type | restriction of token | | | | | | |
| properties | base xs:token | | | | | | |
| facets | <table border="1"> <thead> <tr> <th>Kind</th> <th>Value</th> <th>Annotation</th> </tr> </thead> <tbody> <tr> <td>length</td> <td>10</td> <td></td> </tr> </tbody> </table> | Kind | Value | Annotation | length | 10 | |
| Kind | Value | Annotation | | | | | |
| length | 10 | | | | | | |
| annotation | documentation Facette zur Festlegung der Meldebestätigungslaenge von 10 Zeichen | | | | | | |
| source | <pre> <simpleType name="Meldebestaetigung"> <annotation> <documentation>Facette zur Festlegung der Meldebestätigungslaenge von 10 Zeichen</documentation> </annotation> <restriction base="xs:token"> <length value="10"/> </restriction> </simpleType> </pre> | | | | | | |

simpleType OPS

| | |
|------------|-----------------------------|
| namespace | http://xml.ir-d.de/irdsaa |
| type | restriction of token |
| properties | base xs:token |

| | | | |
|------------|---|--|------------|
| facets | Kind pattern | Value ([135689]\-([0-9]){2}([a-zA-Z0-9]){1}\.([a-zA-Z0-9]{1,2}))*(:[RLBr1b])? | Annotation |
| annotation | documentation Facette zur Festlegung des Prozedurenschlüssels | | |
| source | <pre><simpleType name="OPS"> <annotation> <documentation>Facette zur Festlegung des Prozedurenschlüssels</documentation> </annotation> <restriction base="xs:token"> <pattern value="([135689]\-([0-9]){2}([a-zA-Z0-9]){1}\.([a-zA-Z0-9]{1,2}))*(:[RLBr1b]) ?)" /> </restriction> </simpleType></pre> | | |

simpleType **String2**

| | | | |
|------------|--|---------------------|------------|
| namespace | http://xml.ir-d.de/irdsaa | | |
| type | restriction of token | | |
| properties | base xs:token | | |
| facets | Kind pattern | Value ([0-9]{2}) | Annotation |
| annotation | documentation Facette zur Festlegung des kodierten Entlassungsgrundes | | |
| source | <pre><simpleType name="String2"> <annotation> <documentation>Facette zur Festlegung des kodierten Entlassungsgrundes</documentation> </annotation> <restriction base="xs:token"> <pattern value="([0-9]{2})" /> </restriction> </simpleType></pre> | | |

simpleType **String20**

| | | | |
|------------|--|-------------|------------|
| namespace | http://xml.ir-d.de/irdsaa | | |
| type | restriction of token | | |
| properties | base xs:token | | |
| facets | Kind maxLength | Value 20 | Annotation |
| annotation | documentation Facette zur Festlegung von: Artikel-, Ident-, Serien-, Lot-Nummer des Produkts | | |
| source | <pre><simpleType name="String20"> <annotation> <documentation>Facette zur Festlegung von: Artikel-, Ident-, Serien-, Lot-Nummer des Produkts</documentation> </annotation> <restriction base="xs:token"> <maxLength value="20" /> </restriction></pre> | | |

| | |
|--|----------------------------------|
| | <code></simpleType></code> |
|--|----------------------------------|

simpleType Sw

| namespace | http://xml.ir-d.de/irdsaa | | | | | | |
|------------|--|------------|-------|------------|-----------|-----|--|
| type | restriction of token | | | | | | |
| properties | base xs:token | | | | | | |
| facets | <table border="1"> <thead> <tr> <th>Kind</th> <th>Value</th> <th>Annotation</th> </tr> </thead> <tbody> <tr> <td>maxLength</td> <td>120</td> <td></td> </tr> </tbody> </table> | Kind | Value | Annotation | maxLength | 120 | |
| Kind | Value | Annotation | | | | | |
| maxLength | 120 | | | | | | |
| annotation | documentation Facette für Merkmale der externen Software | | | | | | |
| source | <pre><simpleType name="Sw"> <annotation> <documentation>Facette für Merkmale der externen Software</documentation> </annotation> <restriction base="xs:token"> <maxLength value="120"/> </restriction> </simpleType></pre> | | | | | | |

simpleType Transfervummer

| namespace | http://xml.ir-d.de/irdsaa | | | | | | |
|------------|--|------------|-------|------------|---------|----------------|--|
| type | restriction of token | | | | | | |
| properties | base xs:token | | | | | | |
| used by | element SelbstauskunftFallBasis/FAL Transfervummer | | | | | | |
| facets | <table border="1"> <thead> <tr> <th>Kind</th> <th>Value</th> <th>Annotation</th> </tr> </thead> <tbody> <tr> <td>pattern</td> <td>([a-z0-9]{64})</td> <td></td> </tr> </tbody> </table> | Kind | Value | Annotation | pattern | ([a-z0-9]{64}) | |
| Kind | Value | Annotation | | | | | |
| pattern | ([a-z0-9]{64}) | | | | | | |
| annotation | documentation Facette zur Festlegung der Transfervummer | | | | | | |
| source | <pre><simpleType name="Transfervummer"> <annotation> <documentation>Facette zur Festlegung der Transfervummer</documentation> </annotation> <restriction base="xs:token"> <pattern value="([a-z0-9]{64})"/> </restriction> </simpleType></pre> | | | | | | |

simpleType Versionsnummer

| namespace | http://xml.ir-d.de/irdsaa | | | | | | |
|------------|---|------------|-------|------------|-----------|----|--|
| type | restriction of token | | | | | | |
| properties | base xs:token | | | | | | |
| facets | <table border="1"> <thead> <tr> <th>Kind</th> <th>Value</th> <th>Annotation</th> </tr> </thead> <tbody> <tr> <td>maxLength</td> <td>10</td> <td></td> </tr> </tbody> </table> | Kind | Value | Annotation | maxLength | 10 | |
| Kind | Value | Annotation | | | | | |
| maxLength | 10 | | | | | | |
| annotation | documentation Facette zur Festlegung der Versionsnummer des gelieferten Datensatzes | | | | | | |
| source | <pre><simpleType name="Versionsnummer"></pre> | | | | | | |

| | |
|--|---|
| | <pre> <annotation> <documentation>Facette zur Festlegung der Versionsnummer des gelieferten Datensatzes</documentation> </annotation> <restriction base="xs:token"> <maxLength value="10"/> </restriction> </simpleType> </pre> |
|--|---|

simpleType Zahl1

| namespace | http://xml.ir-d.de/irdsaa | | | | | | | | | |
|--------------|--|------------|-------|------------|--------------|---|--|--------------|---|--|
| type | restriction of positiveInteger | | | | | | | | | |
| properties | base xs:positiveInteger | | | | | | | | | |
| facets | <table border="1"> <thead> <tr> <th>Kind</th> <th>Value</th> <th>Annotation</th> </tr> </thead> <tbody> <tr> <td>minInclusive</td> <td>1</td> <td></td> </tr> <tr> <td>maxInclusive</td> <td>9</td> <td></td> </tr> </tbody> </table> | Kind | Value | Annotation | minInclusive | 1 | | maxInclusive | 9 | |
| Kind | Value | Annotation | | | | | | | | |
| minInclusive | 1 | | | | | | | | | |
| maxInclusive | 9 | | | | | | | | | |
| annotation | documentation Facette zur Festlegung der 1-stelligen Ganzzahlenwerte | | | | | | | | | |
| source | <pre> <simpleType name="Zahl1"> <annotation> <documentation>Facette zur Festlegung der 1-stelligen Ganzzahlenwerte</documentation> </annotation> <restriction base="xs:positiveInteger"> <minInclusive value="1"/> <maxInclusive value="9"/> </restriction> </simpleType> </pre> | | | | | | | | | |

simpleType Zahl1_1

| namespace | http://xml.ir-d.de/irdsaa | | | | | | | | | | | | | | | |
|----------------|---|------------|-------|------------|--------------|-----|--|--------------|-----|--|-------------|---|--|----------------|---|--|
| type | restriction of decimal | | | | | | | | | | | | | | | |
| properties | base xs:decimal | | | | | | | | | | | | | | | |
| facets | <table border="1"> <thead> <tr> <th>Kind</th> <th>Value</th> <th>Annotation</th> </tr> </thead> <tbody> <tr> <td>minInclusive</td> <td>0.1</td> <td></td> </tr> <tr> <td>maxInclusive</td> <td>9.9</td> <td></td> </tr> <tr> <td>totalDigits</td> <td>2</td> <td></td> </tr> <tr> <td>fractionDigits</td> <td>1</td> <td></td> </tr> </tbody> </table> | Kind | Value | Annotation | minInclusive | 0.1 | | maxInclusive | 9.9 | | totalDigits | 2 | | fractionDigits | 1 | |
| Kind | Value | Annotation | | | | | | | | | | | | | | |
| minInclusive | 0.1 | | | | | | | | | | | | | | | |
| maxInclusive | 9.9 | | | | | | | | | | | | | | | |
| totalDigits | 2 | | | | | | | | | | | | | | | |
| fractionDigits | 1 | | | | | | | | | | | | | | | |
| annotation | documentation Facette zur Festlegung des Formats [N].[N] | | | | | | | | | | | | | | | |
| source | <pre> <simpleType name="Zahl1_1"> <annotation> <documentation>Facette zur Festlegung des Formats [N].[N]</documentation> </annotation> <restriction base="xs:decimal"> <totalDigits value="2"/> <fractionDigits value="1"/> <minInclusive value="0.1"/> <maxInclusive value="9.9"/> </restriction> </pre> | | | | | | | | | | | | | | | |

| | |
|--|----------------------------------|
| | <code></simpleType></code> |
|--|----------------------------------|

simpleType **Zahl2**

| namespace | http://xml.ir-d.de/irdsaa | | | | | | | | | |
|--------------|---|------------|-------|------------|--------------|---|--|--------------|----|--|
| type | restriction of positivelnteger | | | | | | | | | |
| properties | base xs:positivelnteger | | | | | | | | | |
| facets | <table border="1"> <thead> <tr> <th>Kind</th> <th>Value</th> <th>Annotation</th> </tr> </thead> <tbody> <tr> <td>minInclusive</td> <td>1</td> <td></td> </tr> <tr> <td>maxInclusive</td> <td>99</td> <td></td> </tr> </tbody> </table> | Kind | Value | Annotation | minInclusive | 1 | | maxInclusive | 99 | |
| Kind | Value | Annotation | | | | | | | | |
| minInclusive | 1 | | | | | | | | | |
| maxInclusive | 99 | | | | | | | | | |
| annotation | documentation Facette zur Festlegung der 2-stelligen Ganzzahlenwerte | | | | | | | | | |
| source | <pre><simpleType name="Zahl2"> <annotation> <documentation>Facette zur Festlegung der 2-stelligen Ganzzahlenwerte</documentation> </annotation> <restriction base="xs:positivelnteger"> <minInclusive value="1"/> <maxInclusive value="99"/> </restriction> </simpleType></pre> | | | | | | | | | |

simpleType **Zahl2_1**

| namespace | http://xml.ir-d.de/irdsaa | | | | | | | | | | | | | | | |
|----------------|---|------------|-------|------------|--------------|-----|--|--------------|------|--|-------------|---|--|----------------|---|--|
| type | restriction of decimal | | | | | | | | | | | | | | | |
| properties | base xs:decimal | | | | | | | | | | | | | | | |
| facets | <table border="1"> <thead> <tr> <th>Kind</th> <th>Value</th> <th>Annotation</th> </tr> </thead> <tbody> <tr> <td>minInclusive</td> <td>0.1</td> <td></td> </tr> <tr> <td>maxInclusive</td> <td>99.9</td> <td></td> </tr> <tr> <td>totalDigits</td> <td>3</td> <td></td> </tr> <tr> <td>fractionDigits</td> <td>1</td> <td></td> </tr> </tbody> </table> | Kind | Value | Annotation | minInclusive | 0.1 | | maxInclusive | 99.9 | | totalDigits | 3 | | fractionDigits | 1 | |
| Kind | Value | Annotation | | | | | | | | | | | | | | |
| minInclusive | 0.1 | | | | | | | | | | | | | | | |
| maxInclusive | 99.9 | | | | | | | | | | | | | | | |
| totalDigits | 3 | | | | | | | | | | | | | | | |
| fractionDigits | 1 | | | | | | | | | | | | | | | |
| annotation | documentation Facette zur Festlegung des Formats [NN].[N] | | | | | | | | | | | | | | | |
| source | <pre><simpleType name="Zahl2_1"> <annotation> <documentation>Facette zur Festlegung des Formats [NN].[N]</documentation> </annotation> <restriction base="xs:decimal"> <totalDigits value="3"/> <fractionDigits value="1"/> <minInclusive value="0.1"/> <maxInclusive value="99.9"/> </restriction> </simpleType></pre> | | | | | | | | | | | | | | | |

simpleType **Zahl3**

| | |
|-----------|---------------------------|
| namespace | http://xml.ir-d.de/irdsaa |
|-----------|---------------------------|

| type | restriction of positiveInteger | | | | | | | | | |
|--------------|--|------------|-------|------------|--------------|---|--|--------------|-----|--|
| properties | base xs:positiveInteger | | | | | | | | | |
| facets | <table border="1"> <thead> <tr> <th>Kind</th> <th>Value</th> <th>Annotation</th> </tr> </thead> <tbody> <tr> <td>minInclusive</td> <td>1</td> <td></td> </tr> <tr> <td>maxInclusive</td> <td>999</td> <td></td> </tr> </tbody> </table> | Kind | Value | Annotation | minInclusive | 1 | | maxInclusive | 999 | |
| Kind | Value | Annotation | | | | | | | | |
| minInclusive | 1 | | | | | | | | | |
| maxInclusive | 999 | | | | | | | | | |
| annotation | documentation Facette zur Festlegung der 3-stelligen Ganzzahlenwerte | | | | | | | | | |
| source | <pre><simpleType name="Zahl3"> <annotation> <documentation>Facette zur Festlegung der 3-stelligen Ganzzahlenwerte</documentation> </annotation> <restriction base="xs:positiveInteger"> <minInclusive value="1"/> <maxInclusive value="999"/> </restriction> </simpleType></pre> | | | | | | | | | |

simpleType **Zahl3_1**

| namespace | http://xml.ir-d.de/irdsaa | | | | | | | | | | | | | | | |
|----------------|---|------------|-------|------------|--------------|-----|--|--------------|-------|--|-------------|---|--|----------------|---|--|
| type | restriction of decimal | | | | | | | | | | | | | | | |
| properties | base xs:decimal | | | | | | | | | | | | | | | |
| facets | <table border="1"> <thead> <tr> <th>Kind</th> <th>Value</th> <th>Annotation</th> </tr> </thead> <tbody> <tr> <td>minInclusive</td> <td>0.1</td> <td></td> </tr> <tr> <td>maxInclusive</td> <td>999.9</td> <td></td> </tr> <tr> <td>totalDigits</td> <td>4</td> <td></td> </tr> <tr> <td>fractionDigits</td> <td>1</td> <td></td> </tr> </tbody> </table> | Kind | Value | Annotation | minInclusive | 0.1 | | maxInclusive | 999.9 | | totalDigits | 4 | | fractionDigits | 1 | |
| Kind | Value | Annotation | | | | | | | | | | | | | | |
| minInclusive | 0.1 | | | | | | | | | | | | | | | |
| maxInclusive | 999.9 | | | | | | | | | | | | | | | |
| totalDigits | 4 | | | | | | | | | | | | | | | |
| fractionDigits | 1 | | | | | | | | | | | | | | | |
| annotation | documentation Facette zur Festlegung des Formats [NNN].[N] | | | | | | | | | | | | | | | |
| source | <pre><simpleType name="Zahl3_1"> <annotation> <documentation>Facette zur Festlegung des Formats [NNN].[N]</documentation> </annotation> <restriction base="xs:decimal"> <totalDigits value="4"/> <fractionDigits value="1"/> <minInclusive value="0.1"/> <maxInclusive value="999.9"/> </restriction> </simpleType></pre> | | | | | | | | | | | | | | | |

simpleType **Zahl4**

| namespace | http://xml.ir-d.de/irdsaa | | | | | | | | | |
|--------------|--|------------|-------|------------|--------------|---|--|--------------|------|--|
| type | restriction of positiveInteger | | | | | | | | | |
| properties | base xs:positiveInteger | | | | | | | | | |
| facets | <table border="1"> <thead> <tr> <th>Kind</th> <th>Value</th> <th>Annotation</th> </tr> </thead> <tbody> <tr> <td>minInclusive</td> <td>1</td> <td></td> </tr> <tr> <td>maxInclusive</td> <td>9999</td> <td></td> </tr> </tbody> </table> | Kind | Value | Annotation | minInclusive | 1 | | maxInclusive | 9999 | |
| Kind | Value | Annotation | | | | | | | | |
| minInclusive | 1 | | | | | | | | | |
| maxInclusive | 9999 | | | | | | | | | |

| | |
|------------|---|
| annotation | documentation Facette zur Festlegung der 4-stelligen Ganzzahlenwerte |
| source | <pre> <simpleType name="Zahl4"> <annotation> <documentation>Facette zur Festlegung der 4-stelligen Ganzzahlenwerte</documentation> </annotation> <restriction base="xs:positiveInteger"> <minInclusive value="1"/> <maxInclusive value="9999"/> </restriction> </simpleType> </pre> |

simpleType Zahl5

| namespace | http://xml.ir-d.de/irdsaa | | | | | | | | | |
|--------------|--|------------|-------|------------|--------------|---|--|--------------|-------|--|
| type | restriction of positiveInteger | | | | | | | | | |
| properties | base xs:positiveInteger | | | | | | | | | |
| facets | <table border="1"> <thead> <tr> <th>Kind</th> <th>Value</th> <th>Annotation</th> </tr> </thead> <tbody> <tr> <td>minInclusive</td> <td>1</td> <td></td> </tr> <tr> <td>maxInclusive</td> <td>99999</td> <td></td> </tr> </tbody> </table> | Kind | Value | Annotation | minInclusive | 1 | | maxInclusive | 99999 | |
| Kind | Value | Annotation | | | | | | | | |
| minInclusive | 1 | | | | | | | | | |
| maxInclusive | 99999 | | | | | | | | | |
| annotation | documentation Facette zur Festlegung der 5-stelligen Ganzzahlenwerte | | | | | | | | | |
| source | <pre> <simpleType name="Zahl5"> <annotation> <documentation>Facette zur Festlegung der 5-stelligen Ganzzahlenwerte</documentation> </annotation> <restriction base="xs:positiveInteger"> <minInclusive value="1"/> <maxInclusive value="99999"/> </restriction> </simpleType> </pre> | | | | | | | | | |

simpleType Zahl5mitNull

| namespace | http://xml.ir-d.de/irdsaa | | | | | | | | | |
|--------------|---|------------|-------|------------|--------------|---|--|--------------|-------|--|
| type | restriction of integer | | | | | | | | | |
| properties | base xs:integer | | | | | | | | | |
| facets | <table border="1"> <thead> <tr> <th>Kind</th> <th>Value</th> <th>Annotation</th> </tr> </thead> <tbody> <tr> <td>minInclusive</td> <td>0</td> <td></td> </tr> <tr> <td>maxInclusive</td> <td>99999</td> <td></td> </tr> </tbody> </table> | Kind | Value | Annotation | minInclusive | 0 | | maxInclusive | 99999 | |
| Kind | Value | Annotation | | | | | | | | |
| minInclusive | 0 | | | | | | | | | |
| maxInclusive | 99999 | | | | | | | | | |
| annotation | documentation Facette zur Festlegung der 5-stelligen Ganzzahlenwerte inklusive "0" | | | | | | | | | |
| source | <pre> <simpleType name="Zahl5mitNull"> <annotation> <documentation>Facette zur Festlegung der 5-stelligen Ganzzahlenwerte inklusive "0"</documentation> </annotation> <restriction base="xs:integer"> <minInclusive value="0"/> <maxInclusive value="99999"/> </restriction> </simpleType> </pre> | | | | | | | | | |

```

</restriction>
</simpleType>

```

complexType MeldungIrdBasis

| | |
|-----------|--|
| diagram | |
| namespace | http://xml.ir-d.de/irdsaa |
| children | MEL_IrdIdGesundheitseinrichtung |
| used by | complexType Selbstauskunft |
| source | <pre> <complexType name="MeldungIrdBasis"> <sequence> <element name="MEL_IrdIdGesundheitseinrichtung" type="IdEinrichtung"/> </sequence> </complexType> </pre> |

element MeldungIrdBasis/MEL_IrdIdGesundheitseinrichtung

| | | | | | | | |
|------------|--|------------|-------|------------|---------|-------------------|--|
| diagram | | | | | | | |
| type | IdEinrichtung | | | | | | |
| properties | content simple | | | | | | |
| facets | <table border="1"> <tr> <td>Kind</td> <td>Value</td> <td>Annotation</td> </tr> <tr> <td>pattern</td> <td>(IRD-GE-[0-9]{8})</td> <td></td> </tr> </table> | Kind | Value | Annotation | pattern | (IRD-GE-[0-9]{8}) | |
| Kind | Value | Annotation | | | | | |
| pattern | (IRD-GE-[0-9]{8}) | | | | | | |
| source | <pre> <element name="MEL_IrdIdGesundheitseinrichtung" type="IdEinrichtung"/> </pre> | | | | | | |

complexType SelbstauskunftFallBasis

| | |
|-----------|--|
| diagram | |
| namespace | http://xml.ir-d.de/irdsaa |
| children | FAL_Transfernummer |
| used by | element Selbstauskunft/fall |
| source | <pre> <complexType name="SelbstauskunftFallBasis"> <sequence> <element name="FAL_Transfernummer" type="Transfernummer"/> </sequence> </complexType> </pre> |

element **SelbstauskunftFalBasis/FAL_Transfernummer**

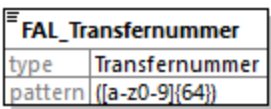
| diagram |  | | | | | | |
|------------|---|------------|-------|------------|---------|----------------|--|
| type | Transfernummer | | | | | | |
| properties | content simple | | | | | | |
| facets | <table border="1"> <thead> <tr> <th>Kind</th> <th>Value</th> <th>Annotation</th> </tr> </thead> <tbody> <tr> <td>pattern</td> <td>([a-z0-9]{64})</td> <td></td> </tr> </tbody> </table> | Kind | Value | Annotation | pattern | ([a-z0-9]{64}) | |
| Kind | Value | Annotation | | | | | |
| pattern | ([a-z0-9]{64}) | | | | | | |
| source | <code><element name="FAL_Transfernummer" type="Transfernummer"/></code> | | | | | | |

simpleType **DatumText**

| namespace | http://xml.ir-d.de/emg | | | | | | |
|------------|---|------------|-------|------------|---------|------------------------------------|--|
| type | restriction of token | | | | | | |
| properties | base xs:token | | | | | | |
| used by | element ArtikelbeschreibungBasis/ARB Datumimplantierung Explantat | | | | | | |
| facets | <table border="1"> <thead> <tr> <th>Kind</th> <th>Value</th> <th>Annotation</th> </tr> </thead> <tbody> <tr> <td>pattern</td> <td>(([0-9]{4})([0-9]{2})?([0-9]{2})?)</td> <td></td> </tr> </tbody> </table> | Kind | Value | Annotation | pattern | (([0-9]{4})([0-9]{2})?([0-9]{2})?) | |
| Kind | Value | Annotation | | | | | |
| pattern | (([0-9]{4})([0-9]{2})?([0-9]{2})?) | | | | | | |
| annotation | documentation Facette zur Festlegung des freien Datumformats: JJJ[-MM[-TT]] | | | | | | |
| source | <pre><simpleType name="DatumText"> <annotation> <documentation>Facette zur Festlegung des freien Datumformats: JJJ[-MM[-TT]]</documentation> </annotation> <restriction base="xs:token"> <pattern value="(([0-9]{4})([0-9]{2})?([0-9]{2})?)"/> </restriction> </simpleType></pre> | | | | | | |

simpleType **Freitext250**

| namespace | http://xml.ir-d.de/emg | | | | | | |
|------------|--|------------|-------|------------|-----------|-----|--|
| type | restriction of token | | | | | | |
| properties | base xs:token | | | | | | |
| used by | elements ArtikelAortenklappeBasis/AAK HerstellerSonstiger ArtikelBrustimplantatBasis/ABI HerstellerSonstiger ArtikelEndoprotheseBasis/AEP HerstellerSonstiger ArtikelbeschreibungBasis/ARB Artikelbezeichnung OperationEndoprotheseBasis/OEP GrundWechselErlaeuterung VorbehandlungEndoprotheseBasis/VEP VorOpErlaeuterung ZubehoerBrustimplantatBasis/ZBI HerstellerSonstiger ZubehoerEndoprotheseBasis/ZEP HerstellerSonstiger ZubehoerBasis/ZUB Artikelbezeichnung | | | | | | |
| facets | <table border="1"> <thead> <tr> <th>Kind</th> <th>Value</th> <th>Annotation</th> </tr> </thead> <tbody> <tr> <td>maxLength</td> <td>250</td> <td></td> </tr> </tbody> </table> | Kind | Value | Annotation | maxLength | 250 | |
| Kind | Value | Annotation | | | | | |
| maxLength | 250 | | | | | | |
| annotation | documentation Facette zur Festlegung des Freitextes von 250 Zeichen | | | | | | |
| source | <pre><simpleType name="Freitext250"> <annotation> <documentation>Facette zur Festlegung des Freitextes von 250</pre> | | | | | | |

| | |
|--|--|
| | <pre> Zeichen</documentation> </annotation> <restriction base="xs:token"> <maxLength value="250"/> </restriction> </simpleType> </pre> |
|--|--|

simpleType **Freitext500**

| namespace | http://xml.ir-d.de/emg | | | | | | |
|------------|--|------------|-------|------------|-----------|-----|--|
| type | restriction of token | | | | | | |
| properties | base xs:token | | | | | | |
| facets | <table border="1"> <thead> <tr> <th>Kind</th> <th>Value</th> <th>Annotation</th> </tr> </thead> <tbody> <tr> <td>maxLength</td> <td>500</td> <td></td> </tr> </tbody> </table> | Kind | Value | Annotation | maxLength | 500 | |
| Kind | Value | Annotation | | | | | |
| maxLength | 500 | | | | | | |
| annotation | documentation Facette zur Festlegung des Freitextes von 500 Zeichen | | | | | | |
| source | <pre> <simpleType name="Freitext500"> <annotation> <documentation>Facette zur Festlegung des Freitextes von 500 Zeichen</documentation> </annotation> <restriction base="xs:token"> <maxLength value="500"/> </restriction> </simpleType> </pre> | | | | | | |

simpleType **HashString**

| namespace | http://xml.ir-d.de/emg | | | | | | |
|------------|--|------------|-------|------------|-----------|-----|--|
| type | restriction of token | | | | | | |
| properties | base xs:token | | | | | | |
| facets | <table border="1"> <thead> <tr> <th>Kind</th> <th>Value</th> <th>Annotation</th> </tr> </thead> <tbody> <tr> <td>maxLength</td> <td>512</td> <td></td> </tr> </tbody> </table> | Kind | Value | Annotation | maxLength | 512 | |
| Kind | Value | Annotation | | | | | |
| maxLength | 512 | | | | | | |
| annotation | documentation Facette zur Festlegung des Hash-Strings der Meldebestätigung | | | | | | |
| source | <pre> <simpleType name="HashString"> <annotation> <documentation>Facette zur Festlegung des Hash-Strings der Meldebestätigung</documentation> </annotation> <restriction base="xs:token"> <maxLength value="512"/> </restriction> </simpleType> </pre> | | | | | | |

simpleType **HashWert**

| | |
|------------|-----------------------------|
| namespace | http://xml.ir-d.de/emg |
| type | restriction of token |
| properties | base xs:token |

| | |
|------------|--|
| facets | Kind Value Annotation length 64 |
| annotation | documentation Facette zur Festlegung des Hashwertes der Meldebestätigung |
| source | <pre><simpleType name="HashWert"> <annotation> <documentation>Facette zur Festlegung des Hashwertes der Meldebestätigung</documentation> </annotation> <restriction base="xs:token"> <length value="64"/> </restriction> </simpleType></pre> |

simpleType ICD

| | |
|------------|---|
| namespace | http://xml.ir-d.de/emg |
| type | restriction of token |
| properties | base xs:token |
| used by | elements DiagnoseAortenklappeBasis/DAK IcdSchluessel DiagnoseBrustimplantatBasis/DBI IcdSchluessel DiagnoseEndoprotheseBasis/DEP IcdSchluessel |
| facets | Kind Value Annotation pattern ([a-zA-Z][0-9]{2}(\.[0-9]{1,2})?(:[RLB])?) |
| annotation | documentation Facette zur Festlegung des ICD Code |
| source | <pre><simpleType name="ICD"> <annotation> <documentation>Facette zur Festlegung des ICD Code</documentation> </annotation> <restriction base="xs:token"> <pattern value="([a-zA-Z][0-9]{2}(\.[0-9]{1,2})?(:[RLB])?)"/> </restriction> </simpleType></pre> |

simpleType IdEinrichtung

| | |
|------------|---|
| namespace | http://xml.ir-d.de/emg |
| type | restriction of token |
| properties | base xs:token |
| used by | element MeldungBasis/MEL IrdIdGesundheitseinrichtung |
| facets | Kind Value Annotation pattern (IRD-GE-[0-9]{8}) |
| annotation | documentation Facette zur Festlegung der Gesundheitseinrichtung-ID |
| source | <pre><simpleType name="IdEinrichtung"> <annotation> <documentation>Facette zur Festlegung der Gesundheitseinrichtung-ID</documentation> </annotation> <restriction base="xs:token"> <pattern value="(IRD-GE-[0-9]{8})"/> </restriction></pre> |

| | |
|--|----------------------------------|
| | <code></simpleType></code> |
|--|----------------------------------|

simpleType IrdArtikelId

| namespace | http://xml.ir-d.de/emg | | | | | | |
|------------|---|------------|-------|------------|-----------|----|--|
| type | restriction of token | | | | | | |
| properties | base xs:token | | | | | | |
| used by | element ArtikelidentifikationBasis/ARI IrdNummer | | | | | | |
| facets | <table border="1"> <thead> <tr> <th>Kind</th> <th>Value</th> <th>Annotation</th> </tr> </thead> <tbody> <tr> <td>maxLength</td> <td>16</td> <td></td> </tr> </tbody> </table> | Kind | Value | Annotation | maxLength | 16 | |
| Kind | Value | Annotation | | | | | |
| maxLength | 16 | | | | | | |
| annotation | documentation Facette zur Festlegung der IrdNummer | | | | | | |
| source | <pre><simpleType name="IrdArtikelId"> <annotation> <documentation>Facette zur Festlegung der IrdNummer</documentation> </annotation> <restriction base="xs:token"> <maxLength value="16"/> </restriction> </simpleType></pre> | | | | | | |

simpleType IrdSpezVersion

| namespace | http://xml.ir-d.de/emg | | | | | | |
|------------|--|------------|-------|------------|---------|---|--|
| type | restriction of token | | | | | | |
| properties | base xs:token | | | | | | |
| used by | element MeldungBasis/MEL IrdSpezVersion | | | | | | |
| facets | <table border="1"> <thead> <tr> <th>Kind</th> <th>Value</th> <th>Annotation</th> </tr> </thead> <tbody> <tr> <td>pattern</td> <td>(([1-9] [1-9][0-9])\.\d{1}[0-9])\.\d{1}[0-9])</td> <td></td> </tr> </tbody> </table> | Kind | Value | Annotation | pattern | (([1-9] [1-9][0-9])\.\d{1}[0-9])\.\d{1}[0-9]) | |
| Kind | Value | Annotation | | | | | |
| pattern | (([1-9] [1-9][0-9])\.\d{1}[0-9])\.\d{1}[0-9]) | | | | | | |
| annotation | documentation Facette zur Festlegung der Version der IRD-Spezifikation | | | | | | |
| source | <pre><simpleType name="IrdSpezVersion"> <annotation> <documentation>Facette zur Festlegung der Version der IRD-Spezifikation</documentation> </annotation> <restriction base="xs:token"> <pattern value="(([1-9] [1-9][0-9])\.\d{1}[0-9])\.\d{1}[0-9])"/> </restriction> </simpleType></pre> | | | | | | |

simpleType JaLeer

| | |
|------------|--|
| namespace | http://xml.ir-d.de/emg |
| type | restriction of integer |
| properties | base xs:integer |
| used by | elements ArtikelAortenklappeBasis/AAK Dislokation ArtikelAortenklappeBasis/AAK HerstellerUnbekannt ArtikelAortenklappeBasis/AAK ProthesenGroesseUnbekannt ArtikelBrustimplantatBasis/ABI FormUnbekannt |

| | ArtikelBrustimplantatBasis/ABI_FuellungUnbekannt ArtikelBrustimplantatBasis/ABI_HerstellerUnbekannt ArtikelBrustimplantatBasis/ABI_OberflaecheUnbekannt ArtikelBrustimplantatBasis/ABI_VolumenUnbekannt ArtikelEndoprotheseBasis/AEP_HerstellerUnbekannt ArtikelbeschreibungBasis/ARB_DatumImplantierungExplantatUnbekannt ArtikelbeschreibungBasis/ARB_DatumVerfallUnbekannt ArtikelbeschreibungBasis/ARB_LotNummerUnbekannt ArtikelbeschreibungBasis/ARB_SerienNummerUnbekannt ArtikelidentifikationBasis/ARI_ArtikelkennzeichenUnbekannt OperationAortenklappeBasis/OAK_AbklemmzeitUnbekannt OperationAortenklappeBasis/OAK_BypasszeitUnbekannt OperationAortenklappeBasis/OAK_DeltaPmeanNachOpUnbekannt OperationAortenklappeBasis/OAK_DistanzLcaUnbekannt OperationAortenklappeBasis/OAK_DistanzRcaUnbekannt OperationAortenklappeBasis/OAK_PtcaNachDurchmesserUnbekannt OperationAortenklappeBasis/OAK_PtcaVorDurchmesserUnbekannt OperationAortenklappeBasis/OAK_ZugangsGefaessUnbekannt PatientenaufnahmeAortenklappeBasis/PAA_AkoefUnbekannt PatientenaufnahmeAortenklappeBasis/PAA_CtCalciumUnbekannt PatientenaufnahmeAortenklappeBasis/PAA_DeltaPmaxUnbekannt PatientenaufnahmeAortenklappeBasis/PAA_DeltaPmeanUnbekannt PatientenaufnahmeAortenklappeBasis/PAA_DeltaPUnbekannt PatientenaufnahmeKardiologieBasis/PKA_KreatininwertUnbekannt PatientenaufnahmeKardiologieBasis/PKA_LvefUnbekannt PostoperationAortenklappeBasis/POA_AkoefUnbekannt PostoperationAortenklappeBasis/POA_DeltaPmaxUnbekannt PostoperationAortenklappeBasis/POA_DeltaPmeanUnbekannt PostoperationAortenklappeBasis/POA_LvefUnbekannt PostoperationAortenklappeBasis/POA_MaxKreatininUnbekannt ZubehoerBrustimplantatBasis/ZBI_HerstellerUnbekannt ZubehoerEndoprotheseBasis/ZEP_HerstellerUnbekannt ZubehoerBasis/ZUB_ArtikelNummerUnbekannt ZubehoerBasis/ZUB_LotNummerUnbekannt ZubehoerBasis/ZUB_SerienNummerUnbekannt | | | | | | |
|------------|--|------------|-------|------------|---------|-----|--|
| facets | <table border="1"> <thead> <tr> <th>Kind</th> <th>Value</th> <th>Annotation</th> </tr> </thead> <tbody> <tr> <td>pattern</td> <td>(1)</td> <td></td> </tr> </tbody> </table> | Kind | Value | Annotation | pattern | (1) | |
| Kind | Value | Annotation | | | | | |
| pattern | (1) | | | | | | |
| annotation | documentation Facette zur Festlegung des Unbekannt-Wertes (Bedeutung 1=true) | | | | | | |
| source | <pre><simpleType name="JaLeer"> <annotation> <documentation>Facette zur Festlegung des Unbekannt-Wertes (Bedeutung 1=true)</documentation> </annotation> <restriction base="xs:integer"> <pattern value="(1)"/> </restriction> </simpleType></pre> | | | | | | |

simpleType Meldebestaetigung

| namespace | http://xml.lir-d.de/emg | | | | | | |
|------------|--|------------|-------|------------|--------|----|--|
| type | restriction of token | | | | | | |
| properties | base xs:token | | | | | | |
| facets | <table border="1"> <thead> <tr> <th>Kind</th> <th>Value</th> <th>Annotation</th> </tr> </thead> <tbody> <tr> <td>length</td> <td>10</td> <td></td> </tr> </tbody> </table> | Kind | Value | Annotation | length | 10 | |
| Kind | Value | Annotation | | | | | |
| length | 10 | | | | | | |
| annotation | documentation Facette zur Festlegung der Meldebestätigungslaenge von 10 Zeichen | | | | | | |
| source | <pre><simpleType name="Meldebestaetigung"> <annotation></pre> | | | | | | |

| | |
|--|---|
| | <pre> <documentation>Facette zur Festlegung der Meldebestätigungslaenge von 10 Zeichen</documentation> </annotation> <restriction base="xs:token"> <length value="10"/> </restriction> </simpleType> </pre> |
|--|---|

simpleType OPS

| | | | |
|------------|---|---|------------|
| namespace | http://xml.ir-d.de/emg | | |
| type | restriction of token | | |
| properties | base xs:token | | |
| used by | elements AusloeserBasis/ALR ProzedurenSchluessel ProzedurenSchluesselAortenklappeBasis/PAK ProzedurenSchluessel ProzedurenSchluesselBrustimplantatBasis/PBI ProzedurenSchluessel ProzedurenSchluesselEndoprotheseBasis/PEP ProzedurenSchluessel | | |
| facets | Kind | Value | Annotation |
| | pattern | (([135689]\-([0-9]){2}([a-zA-Z0-9]){1}\.([a-zA-Z0-9]{1,2}))*(:[RLBr1b])?) | |
| annotation | documentation Facette zur Festlegung des Prozedurenschlüssels | | |
| source | <pre> <simpleType name="OPS"> <annotation> <documentation>Facette zur Festlegung des Prozedurenschlüssels</documentation> </annotation> <restriction base="xs:token"> <pattern value="([135689]\-([0-9]){2}([a-zA-Z0-9]){1}\.([a-zA-Z0-9]{1,2}))*(:[RLBr1b]) ?)" /> </restriction> </simpleType> </pre> | | |

simpleType String2

| | | | |
|------------|--|--------------|------------|
| namespace | http://xml.ir-d.de/emg | | |
| type | restriction of token | | |
| properties | base xs:token | | |
| used by | element EntlassungBasis/ENT GrundSchluessel | | |
| facets | Kind | Value | Annotation |
| | pattern | (([0-9]){2}) | |
| annotation | documentation Facette zur Festlegung des kodierten Entlassungsgrundes | | |
| source | <pre> <simpleType name="String2"> <annotation> <documentation>Facette zur Festlegung des kodierten Entlassungsgrundes</documentation> </annotation> <restriction base="xs:token"> <pattern value="([0-9]{2})" /> </restriction> </pre> | | |

| | |
|--|----------------------------------|
| | <code></simpleType></code> |
|--|----------------------------------|

simpleType **String20**

| | |
|------------|---|
| namespace | http://xml.ir-d.de/emg |
| type | restriction of token |
| properties | base xs:token |
| used by | elements ArtikelbeschreibungBasis/ARB DatumVerfall ArtikelbeschreibungBasis/ARB LotNummer ArtikelbeschreibungBasis/ARB SerienNummer ArtikelidentifikationBasis/ARI Artikelkennzeichen ZubehoerBasis/ZUB ArtikelNummer ZubehoerBasis/ZUB LotNummer ZubehoerBasis/ZUB SerienNummer |
| facets | Kind Value Annotation maxLength 20 |
| annotation | documentation Facette zur Festlegung von: Artikel-, Ident-, Serien-, Lot-Nummer des Produkts |
| source | <pre><simpleType name="String20"> <annotation> <documentation>Facette zur Festlegung von: Artikel-, Ident-, Serien-, Lot-Nummer des Produkts</documentation> </annotation> <restriction base="xs:token"> <maxLength value="20"/> </restriction> </simpleType></pre> |

simpleType **Sw**

| | |
|------------|--|
| namespace | http://xml.ir-d.de/emg |
| type | restriction of token |
| properties | base xs:token |
| used by | elements MeldungBasis/MEL SwHersteller MeldungBasis/MEL SwName MeldungBasis/MEL SwVersion |
| facets | Kind Value Annotation maxLength 120 |
| annotation | documentation Facette für Merkmale der externen Software |
| source | <pre><simpleType name="Sw"> <annotation> <documentation>Facette für Merkmale der externen Software</documentation> </annotation> <restriction base="xs:token"> <maxLength value="120"/> </restriction> </simpleType></pre> |

simpleType **Transfervummer**

| | |
|------------|-----------------------------|
| namespace | http://xml.ir-d.de/emg |
| type | restriction of token |
| properties | base xs:token |

| | |
|------------|--|
| used by | element FallBasis/FAL Transfervummer |
| facets | Kind Value Annotation pattern ([a-z0-9]{64}) |
| annotation | documentation Facette zur Festlegung der Transfervummer |
| source | <pre><simpleType name="Transfervummer"> <annotation> <documentation>Facette zur Festlegung der Transfervummer</documentation> </annotation> <restriction base="xs:token"> <pattern value="([a-z0-9]{64})"/> </restriction> </simpleType></pre> |

simpleType Versionsnummer

| | |
|------------|--|
| namespace | http://xml.ir-d.de/emg |
| type | restriction of token |
| properties | base xs:token |
| used by | element FallBasis/FAL Versionsnummer |
| facets | Kind Value Annotation maxLength 10 |
| annotation | documentation Facette zur Festlegung der Versionsnummer des gelieferten Datensatzes |
| source | <pre><simpleType name="Versionsnummer"> <annotation> <documentation>Facette zur Festlegung der Versionsnummer des gelieferten Datensatzes</documentation> </annotation> <restriction base="xs:token"> <maxLength value="10"/> </restriction> </simpleType></pre> |

simpleType Zahl1

| | |
|------------|---|
| namespace | http://xml.ir-d.de/emg |
| type | restriction of positiveInteger |
| properties | base xs:positiveInteger |
| used by | elements OperationAortenklappeBasis/OAK LaesionenAnzahl OperationAortenklappeBasis/OAK ProzedurenAnzahl |
| facets | Kind Value Annotation minInclusive 1 maxInclusive 9 |
| annotation | documentation Facette zur Festlegung der 1-stelligen Ganzzahlenwerte |
| source | <pre><simpleType name="Zahl1"> <annotation> <documentation>Facette zur Festlegung der 1-stelligen Ganzzahlenwerte</documentation> </annotation></pre> |

| | |
|--|---|
| | <pre> <restriction base="xs:positiveInteger"> <minInclusive value="1"/> <maxInclusive value="9"/> </restriction> </simpleType> </pre> |
|--|---|

simpleType **Zahl1_1**

| namespace | http://xml.ir-d.de/emg | | | | | | | | | | | | | | | |
|----------------|---|------------|-------|------------|--------------|-----|--|--------------|-----|--|-------------|---|--|----------------|---|--|
| type | restriction of decimal | | | | | | | | | | | | | | | |
| properties | base xs:decimal | | | | | | | | | | | | | | | |
| used by | elements OperationAortenklappeBasis/OAK ZugangsGefaessdiameter PatientenaufnahmeAortenklappeBasis/PAA Akoef PostoperationAortenklappeBasis/POA Akoef | | | | | | | | | | | | | | | |
| facets | <table border="1"> <thead> <tr> <th>Kind</th> <th>Value</th> <th>Annotation</th> </tr> </thead> <tbody> <tr> <td>minInclusive</td> <td>0.1</td> <td></td> </tr> <tr> <td>maxInclusive</td> <td>9.9</td> <td></td> </tr> <tr> <td>totalDigits</td> <td>2</td> <td></td> </tr> <tr> <td>fractionDigits</td> <td>1</td> <td></td> </tr> </tbody> </table> | Kind | Value | Annotation | minInclusive | 0.1 | | maxInclusive | 9.9 | | totalDigits | 2 | | fractionDigits | 1 | |
| Kind | Value | Annotation | | | | | | | | | | | | | | |
| minInclusive | 0.1 | | | | | | | | | | | | | | | |
| maxInclusive | 9.9 | | | | | | | | | | | | | | | |
| totalDigits | 2 | | | | | | | | | | | | | | | |
| fractionDigits | 1 | | | | | | | | | | | | | | | |
| annotation | documentation Facette zur Festlegung des Formats [N].[N] | | | | | | | | | | | | | | | |
| source | <pre> <simpleType name="Zahl1_1"> <annotation> <documentation>Facette zur Festlegung des Formats [N].[N]</documentation> </annotation> <restriction base="xs:decimal"> <totalDigits value="2"/> <fractionDigits value="1"/> <minInclusive value="0.1"/> <maxInclusive value="9.9"/> </restriction> </simpleType> </pre> | | | | | | | | | | | | | | | |

simpleType **Zahl2**

| namespace | http://xml.ir-d.de/emg | | | | | | | | | |
|--------------|---|------------|-------|------------|--------------|---|--|--------------|----|--|
| type | restriction of positiveInteger | | | | | | | | | |
| properties | base xs:positiveInteger | | | | | | | | | |
| used by | elements ArtikelAortenklappeBasis/AAK ProthesenGroesse OperationAortenklappeBasis/OAK AortenklappenOpAnzahl OperationAortenklappeBasis/OAK NummerEingriff OperationAortenklappeBasis/OAK PtcaNachAnzahl OperationAortenklappeBasis/OAK PtcaNachDurchmesser OperationAortenklappeBasis/OAK PtcaVorAnzahl OperationAortenklappeBasis/OAK PtcaVorDurchmesser | | | | | | | | | |
| facets | <table border="1"> <thead> <tr> <th>Kind</th> <th>Value</th> <th>Annotation</th> </tr> </thead> <tbody> <tr> <td>minInclusive</td> <td>1</td> <td></td> </tr> <tr> <td>maxInclusive</td> <td>99</td> <td></td> </tr> </tbody> </table> | Kind | Value | Annotation | minInclusive | 1 | | maxInclusive | 99 | |
| Kind | Value | Annotation | | | | | | | | |
| minInclusive | 1 | | | | | | | | | |
| maxInclusive | 99 | | | | | | | | | |
| annotation | documentation Facette zur Festlegung der 2-stelligen Ganzzahlenwerte | | | | | | | | | |
| source | <pre> <simpleType name="Zahl2"> <annotation> <documentation>Facette zur Festlegung der 2-stelligen Ganzzahlenwerte</documentation> </pre> | | | | | | | | | |

| | |
|--|--|
| | <pre> </annotation> <restriction base="xs:positiveInteger"> <minInclusive value="1"/> <maxInclusive value="99"/> </restriction> </simpleType> </pre> |
|--|--|

simpleType **Zahl2_1**

| namespace | http://xml.ir-d.de/emg | | | | | | | | | | | | | | | |
|----------------|---|------------|-------|------------|--------------|-----|--|--------------|------|--|-------------|---|--|----------------|---|--|
| type | restriction of decimal | | | | | | | | | | | | | | | |
| properties | base xs:decimal | | | | | | | | | | | | | | | |
| used by | elements PatientenaufnahmeKardiologieBasis/PKA KreatininwertMqdl PostoperationAortenklappeBasis/POA MaxKreatininMqDI | | | | | | | | | | | | | | | |
| facets | <table border="1"> <thead> <tr> <th>Kind</th> <th>Value</th> <th>Annotation</th> </tr> </thead> <tbody> <tr> <td>minInclusive</td> <td>0.1</td> <td></td> </tr> <tr> <td>maxInclusive</td> <td>99.9</td> <td></td> </tr> <tr> <td>totalDigits</td> <td>3</td> <td></td> </tr> <tr> <td>fractionDigits</td> <td>1</td> <td></td> </tr> </tbody> </table> | Kind | Value | Annotation | minInclusive | 0.1 | | maxInclusive | 99.9 | | totalDigits | 3 | | fractionDigits | 1 | |
| Kind | Value | Annotation | | | | | | | | | | | | | | |
| minInclusive | 0.1 | | | | | | | | | | | | | | | |
| maxInclusive | 99.9 | | | | | | | | | | | | | | | |
| totalDigits | 3 | | | | | | | | | | | | | | | |
| fractionDigits | 1 | | | | | | | | | | | | | | | |
| annotation | documentation Facette zur Festlegung des Formats [NN].[N] | | | | | | | | | | | | | | | |
| source | <pre> <simpleType name="Zahl2_1"> <annotation> <documentation>Facette zur Festlegung des Formats [NN].[N]</documentation> </annotation> <restriction base="xs:decimal"> <totalDigits value="3"/> <fractionDigits value="1"/> <minInclusive value="0.1"/> <maxInclusive value="99.9"/> </restriction> </simpleType> </pre> | | | | | | | | | | | | | | | |

simpleType **Zahl3**

| namespace | http://xml.ir-d.de/emg | | | | | | | | | |
|--------------|--|------------|-------|------------|--------------|---|--|--------------|-----|--|
| type | restriction of positiveInteger | | | | | | | | | |
| properties | base xs:positiveInteger | | | | | | | | | |
| used by | elements ArtikelidentifikationBasis/ARI LaufendeNummer OperationAortenklappeBasis/OAK Abklemmzeit OperationAortenklappeBasis/OAK Aortenklappenannulus OperationAortenklappeBasis/OAK Bypasszeit OperationAortenklappeBasis/OAK DeltaPmeanNachOp OperationAortenklappeBasis/OAK DistanzLca OperationAortenklappeBasis/OAK DistanzRca OperationAortenklappeBasis/OAK Eingriffsdauer OperationBasis/OPE LaufendeNummer PatientenaufnahmeAortenklappeBasis/PAA DeltaP PatientenaufnahmeAortenklappeBasis/PAA DeltaPmax PatientenaufnahmeAortenklappeBasis/PAA DeltaPmean PatientenaufnahmeKardiologieBasis/PKA Lvef PostoperationAortenklappeBasis/POA DeltaPmax PostoperationAortenklappeBasis/POA DeltaPmean PostoperationAortenklappeBasis/POA IntensivDauer PostoperationAortenklappeBasis/POA Lvef ZubehoerBasis/ZUB LaufendeNummer | | | | | | | | | |
| facets | <table border="1"> <thead> <tr> <th>Kind</th> <th>Value</th> <th>Annotation</th> </tr> </thead> <tbody> <tr> <td>minInclusive</td> <td>1</td> <td></td> </tr> <tr> <td>maxInclusive</td> <td>999</td> <td></td> </tr> </tbody> </table> | Kind | Value | Annotation | minInclusive | 1 | | maxInclusive | 999 | |
| Kind | Value | Annotation | | | | | | | | |
| minInclusive | 1 | | | | | | | | | |
| maxInclusive | 999 | | | | | | | | | |

| | |
|------------|--|
| annotation | documentation Facette zur Festlegung der 3-stelligen Ganzzahlenwerte |
| source | <pre><simpleType name="Zahl3"> <annotation> <documentation>Facette zur Festlegung der 3-stelligen Ganzzahlenwerte</documentation> </annotation> <restriction base="xs:positiveInteger"> <minInclusive value="1"/> <maxInclusive value="999"/> </restriction> </simpleType></pre> |

simpleType Zahl3_1

| namespace | http://xml.ir-d.de/emg | | | | | | | | | | | | | | | |
|----------------|---|------------|-------|------------|--------------|-----|--|--------------|-------|--|-------------|---|--|----------------|---|--|
| type | restriction of decimal | | | | | | | | | | | | | | | |
| properties | base xs:decimal | | | | | | | | | | | | | | | |
| used by | elements OperationAortenklappeBasis/OAK Durchleuchtungszeit PatientenaufnahmeAortenklappeBasis/PAA StsScore | | | | | | | | | | | | | | | |
| facets | <table border="1"> <thead> <tr> <th>Kind</th> <th>Value</th> <th>Annotation</th> </tr> </thead> <tbody> <tr> <td>minInclusive</td> <td>0.1</td> <td></td> </tr> <tr> <td>maxInclusive</td> <td>999.9</td> <td></td> </tr> <tr> <td>totalDigits</td> <td>4</td> <td></td> </tr> <tr> <td>fractionDigits</td> <td>1</td> <td></td> </tr> </tbody> </table> | Kind | Value | Annotation | minInclusive | 0.1 | | maxInclusive | 999.9 | | totalDigits | 4 | | fractionDigits | 1 | |
| Kind | Value | Annotation | | | | | | | | | | | | | | |
| minInclusive | 0.1 | | | | | | | | | | | | | | | |
| maxInclusive | 999.9 | | | | | | | | | | | | | | | |
| totalDigits | 4 | | | | | | | | | | | | | | | |
| fractionDigits | 1 | | | | | | | | | | | | | | | |
| annotation | documentation Facette zur Festlegung des Formats [NNN].[N] | | | | | | | | | | | | | | | |
| source | <pre><simpleType name="Zahl3_1"> <annotation> <documentation>Facette zur Festlegung des Formats [NNN].[N]</documentation> </annotation> <restriction base="xs:decimal"> <totalDigits value="4"/> <fractionDigits value="1"/> <minInclusive value="0.1"/> <maxInclusive value="999.9"/> </restriction> </simpleType></pre> | | | | | | | | | | | | | | | |

simpleType Zahl4

| namespace | http://xml.ir-d.de/emg | | | | | | | | | |
|--------------|--|------------|-------|------------|--------------|---|--|--------------|------|--|
| type | restriction of positiveInteger | | | | | | | | | |
| properties | base xs:positiveInteger | | | | | | | | | |
| used by | elements PatientenaufnahmeKardiologieBasis/PKA KreatininwertMikromol PostoperationAortenklappeBasis/POA MaxKreatininMikromol | | | | | | | | | |
| facets | <table border="1"> <thead> <tr> <th>Kind</th> <th>Value</th> <th>Annotation</th> </tr> </thead> <tbody> <tr> <td>minInclusive</td> <td>1</td> <td></td> </tr> <tr> <td>maxInclusive</td> <td>9999</td> <td></td> </tr> </tbody> </table> | Kind | Value | Annotation | minInclusive | 1 | | maxInclusive | 9999 | |
| Kind | Value | Annotation | | | | | | | | |
| minInclusive | 1 | | | | | | | | | |
| maxInclusive | 9999 | | | | | | | | | |
| annotation | documentation Facette zur Festlegung der 4-stelligen Ganzzahlenwerte | | | | | | | | | |
| source | <pre><simpleType name="Zahl4"></pre> | | | | | | | | | |

| | |
|--|---|
| | <pre> <annotation> <documentation>Facette zur Festlegung der 4-stelligen Ganzzahlenwerte</documentation> </annotation> <restriction base="xs:positiveInteger"> <minInclusive value="1"/> <maxInclusive value="9999"/> </restriction> </simpleType> </pre> |
|--|---|

simpleType **Zahl5**

| namespace | http://xml.ir-d.de/emg | | | | | | | | | |
|--------------|--|------------|-------|------------|--------------|---|--|--------------|-------|--|
| type | restriction of positiveInteger | | | | | | | | | |
| properties | base xs:positiveInteger | | | | | | | | | |
| used by | elements ArtikelBrustimplantatBasis/ABI Volumen PatientenaufnahmeAortenklappeBasis/PAA CtCalcium ZubehoerEndoprotheseBasis/ZEP Menge | | | | | | | | | |
| facets | <table border="1"> <thead> <tr> <th>Kind</th> <th>Value</th> <th>Annotation</th> </tr> </thead> <tbody> <tr> <td>minInclusive</td> <td>1</td> <td></td> </tr> <tr> <td>maxInclusive</td> <td>99999</td> <td></td> </tr> </tbody> </table> | Kind | Value | Annotation | minInclusive | 1 | | maxInclusive | 99999 | |
| Kind | Value | Annotation | | | | | | | | |
| minInclusive | 1 | | | | | | | | | |
| maxInclusive | 99999 | | | | | | | | | |
| annotation | documentation Facette zur Festlegung der 5-stelligen Ganzzahlenwerte | | | | | | | | | |
| source | <pre> <simpleType name="Zahl5"> <annotation> <documentation>Facette zur Festlegung der 5-stelligen Ganzzahlenwerte</documentation> </annotation> <restriction base="xs:positiveInteger"> <minInclusive value="1"/> <maxInclusive value="99999"/> </restriction> </simpleType> </pre> | | | | | | | | | |

simpleType **Zahl5mitNull**

| namespace | http://xml.ir-d.de/emg | | | | | | | | | |
|--------------|---|------------|-------|------------|--------------|---|--|--------------|-------|--|
| type | restriction of integer | | | | | | | | | |
| properties | base xs:integer | | | | | | | | | |
| used by | element ArtikelBrustimplantatBasis/ABI IntraoperativesVolumen | | | | | | | | | |
| facets | <table border="1"> <thead> <tr> <th>Kind</th> <th>Value</th> <th>Annotation</th> </tr> </thead> <tbody> <tr> <td>minInclusive</td> <td>0</td> <td></td> </tr> <tr> <td>maxInclusive</td> <td>99999</td> <td></td> </tr> </tbody> </table> | Kind | Value | Annotation | minInclusive | 0 | | maxInclusive | 99999 | |
| Kind | Value | Annotation | | | | | | | | |
| minInclusive | 0 | | | | | | | | | |
| maxInclusive | 99999 | | | | | | | | | |
| annotation | documentation Facette zur Festlegung der 5-stelligen Ganzzahlenwerte inklusive "0" | | | | | | | | | |
| source | <pre> <simpleType name="Zahl5mitNull"> <annotation> <documentation>Facette zur Festlegung der 5-stelligen Ganzzahlenwerte inklusive "0"</documentation> </annotation> <restriction base="xs:integer"> <minInclusive value="0"/> <maxInclusive value="99999"/> </restriction> </simpleType> </pre> | | | | | | | | | |

```

</restriction>
</simpleType>

```

complexType **FallBasis**

| | |
|-----------|--|
| diagram | |
| namespace | http://xml.ir-d.de/emg |
| children | FAL Aufnahmedatum FAL ArtAufenthaltSchluessel FAL Transfernummer FAL DatumZeitSatzErstellung FAL Versionsnummer |
| used by | complexType Fall |
| source | <pre> <complexType name="FallBasis"> <sequence> <element name="FAL_Aufnahmedatum" type="xs:date"/> <element name="FAL_ArtAufenthaltSchluessel" type="enum_0065"/> <element name="FAL_Transfernummer" type="Transfernummer"/> <element name="FAL_DatumZeitSatzErstellung" type="xs:dateTime"/> <element name="FAL_Versionsnummer" type="Versionsnummer" minOccurs="0"/> </sequence> </complexType> </pre> |

element **FallBasis/FAL_Aufnahmedatum**

| | |
|------------|---|
| diagram | |
| type | date |
| properties | content simple |
| source | <pre><element name="FAL_Aufnahmedatum" type="xs:date"/></pre> |

element **FallBasis/FAL_ArtAufenthaltSchluessel**

| | |
|---------|--|
| diagram | |
|---------|--|

| type | enum_0065 | | | | | | | | | | | | |
|-------------|--|--------------------------------|-------|------------|-------------|---------|----------------------------|-------------|---------|--------------------------------|-------------|---------|---------------------------|
| properties | content simple | | | | | | | | | | | | |
| facets | <table border="1"> <thead> <tr> <th>Kind</th> <th>Value</th> <th>Annotation</th> </tr> </thead> <tbody> <tr> <td>enumeration</td> <td>0065001</td> <td>documentation stationär</td> </tr> <tr> <td>enumeration</td> <td>0065002</td> <td>documentation teilstationär</td> </tr> <tr> <td>enumeration</td> <td>0065003</td> <td>documentation ambulant</td> </tr> </tbody> </table> | Kind | Value | Annotation | enumeration | 0065001 | documentation stationär | enumeration | 0065002 | documentation teilstationär | enumeration | 0065003 | documentation ambulant |
| Kind | Value | Annotation | | | | | | | | | | | |
| enumeration | 0065001 | documentation stationär | | | | | | | | | | | |
| enumeration | 0065002 | documentation teilstationär | | | | | | | | | | | |
| enumeration | 0065003 | documentation ambulant | | | | | | | | | | | |
| source | <code><element name="FAL_ArtAufenthaltSchluessel" type="enum_0065"/></code> | | | | | | | | | | | | |

element FallBasis/FAL_Transfernummer

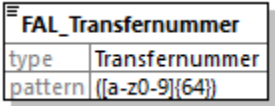
| diagram |  | | | | | | |
|------------|---|------------|-------|------------|---------|----------------|--|
| type | Transfernummer | | | | | | |
| properties | content simple | | | | | | |
| facets | <table border="1"> <thead> <tr> <th>Kind</th> <th>Value</th> <th>Annotation</th> </tr> </thead> <tbody> <tr> <td>pattern</td> <td>([a-z0-9]{64})</td> <td></td> </tr> </tbody> </table> | Kind | Value | Annotation | pattern | ([a-z0-9]{64}) | |
| Kind | Value | Annotation | | | | | |
| pattern | ([a-z0-9]{64}) | | | | | | |
| source | <code><element name="FAL_Transfernummer" type="Transfernummer"/></code> | | | | | | |

element FallBasis/FAL_DatumZeitSatzErstellung

| | |
|------------|---|
| diagram |  |
| type | dateTime |
| properties | content simple |
| source | <code><element name="FAL_DatumZeitSatzErstellung" type="xs:dateTime"/></code> |

element FallBasis/FAL_Versionsnummer

| diagram |  | | | | | | |
|------------|---|------------|-------|------------|-----------|---------|--------|
| type | Versionsnummer | | | | | | |
| properties | <table border="1"> <tbody> <tr> <td>minOcc</td> <td>0</td> </tr> <tr> <td>maxOcc</td> <td>1</td> </tr> <tr> <td>content</td> <td>simple</td> </tr> </tbody> </table> | minOcc | 0 | maxOcc | 1 | content | simple |
| minOcc | 0 | | | | | | |
| maxOcc | 1 | | | | | | |
| content | simple | | | | | | |
| facets | <table border="1"> <thead> <tr> <th>Kind</th> <th>Value</th> <th>Annotation</th> </tr> </thead> <tbody> <tr> <td>maxLength</td> <td>10</td> <td></td> </tr> </tbody> </table> | Kind | Value | Annotation | maxLength | 10 | |
| Kind | Value | Annotation | | | | | |
| maxLength | 10 | | | | | | |
| source | <code><element name="FAL_Versionsnummer" type="Versionsnummer" minOccurs="0"/></code> | | | | | | |

complexType **AusloeserBasis**

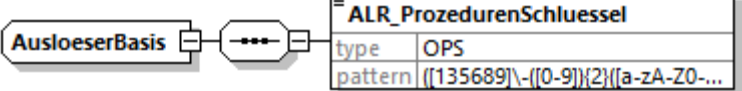
| | |
|-----------|--|
| diagram |  |
| namespace | http://xml.ir-d.de/emg |
| children | ALR_ProzedurenSchluessel |
| used by | element Fall/ausloeser |
| source | <pre><complexType name="AusloeserBasis"> <sequence> <element name="ALR_ProzedurenSchluessel" type="OPS"/> </sequence> </complexType></pre> |

element **AusloeserBasis/ALR_ProzedurenSchluessel**

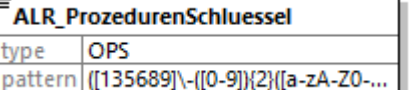
| diagram |  | | | | | | |
|------------|--|------------|-------|------------|---------|---|--|
| type | OPS | | | | | | |
| properties | content simple | | | | | | |
| facets | <table border="1"> <thead> <tr> <th>Kind</th> <th>Value</th> <th>Annotation</th> </tr> </thead> <tbody> <tr> <td>pattern</td> <td>(([135689]\-[0-9]){2}([a-zA-Z0-9]){1}\.[a-zA-Z0-9]{1,2})*(:[RLBrlb])?</td> <td></td> </tr> </tbody> </table> | Kind | Value | Annotation | pattern | (([135689]\-[0-9]){2}([a-zA-Z0-9]){1}\.[a-zA-Z0-9]{1,2})*(:[RLBrlb])? | |
| Kind | Value | Annotation | | | | | |
| pattern | (([135689]\-[0-9]){2}([a-zA-Z0-9]){1}\.[a-zA-Z0-9]{1,2})*(:[RLBrlb])? | | | | | | |
| source | <pre><element name="ALR_ProzedurenSchluessel" type="OPS"/></pre> | | | | | | |

complexType **Patientenaufnahme**

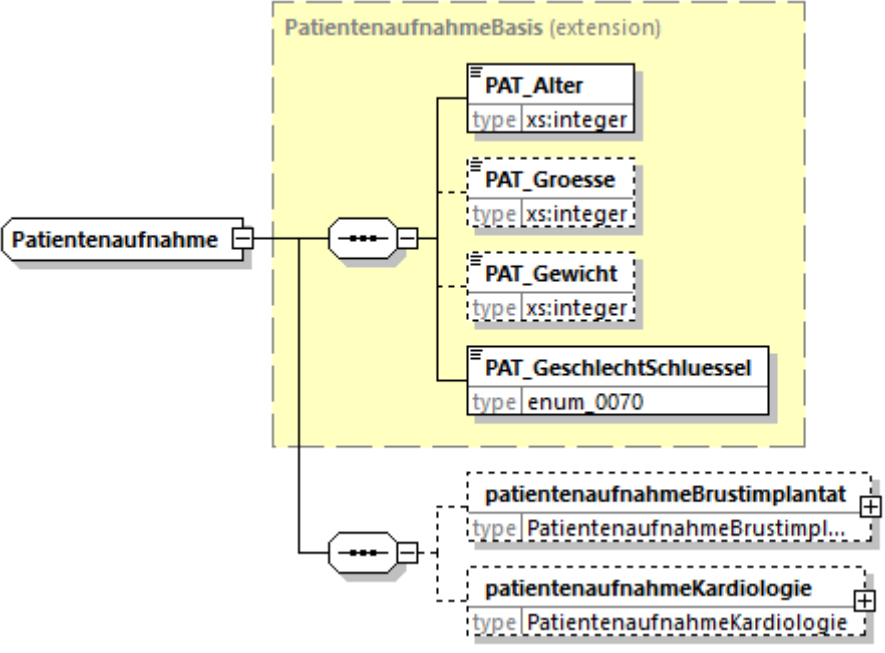
| | |
|-----------|--|
| diagram |  |
| namespace | http://xml.ir-d.de/emg |

| | |
|------------|--|
| type | extension of PatientenaufnahmeBasis |
| properties | base PatientenaufnahmeBasis |
| children | PAT Alter PAT Groesse PAT Gewicht PAT GeschlechtSchluessel patientenaufnahmeBrustimplantat patientenaufnahmeKardiologie |
| used by | element Fall/patientenaufnahme |
| source | <pre> <complexType name="Patientenaufnahme"> <complexContent> <extension base="PatientenaufnahmeBasis"> <sequence> <element name="patientenaufnahmeBrustimplantat" type="PatientenaufnahmeBrustimplantatBasis" minOccurs="0"/> <element name="patientenaufnahmeKardiologie" type="PatientenaufnahmeKardiologie" minOccurs="0"/> </sequence> </extension> </complexContent> </complexType> </pre> |

element **Patientenaufnahme/patientenaufnahmeBrustimplantat**

| | |
|------------|--|
| diagram | |
| type | PatientenaufnahmeBrustimplantatBasis |
| properties | minOcc 0 maxOcc 1 content complex |
| children | PAB AutoimmunerkrankungSchluessel PAB VerlaufAutoimmunerkrankungSchluessel |
| source | <pre> <element name="patientenaufnahmeBrustimplantat" type="PatientenaufnahmeBrustimplantatBasis" minOccurs="0"/> </pre> |

element **Patientenaufnahme/patientenaufnahmeKardiologie**

| | |
|-------------------|---|
| <p>diagram</p> | |
| <p>type</p> | <p>PatientenaufnahmeKardiologie</p> |
| <p>properties</p> | <p>minOcc 0 maxOcc 1 content complex</p> |
| <p>children</p> | <p>PKA NyhaSchluessel PKA Lvef PKA LvefUnbekannt PKA DiabetesSchluessel PKA NierenersatzSchluessel PKA KreatininwertMgdl PKA KreatininwertMikromol PKA KreatininwertUnbekannt patientenaufnahmeAortenklappe</p> |
| <p>source</p> | <pre><element name="patientenaufnahmeKardiologie" type="PatientenaufnahmeKardiologie" minOccurs="0"/></pre> |

complexType Operation

| | |
|-------------------|---|
| <p>diagram</p> | |
| <p>namespace</p> | <p>http://xml.ir-d.de/emg</p> |
| <p>type</p> | <p>extension of OperationBasis</p> |
| <p>properties</p> | <p>base OperationBasis</p> |
| <p>children</p> | <p>OPE LaufendeNummer OPE Datum OPE SeitenLokalisationSchluessel OPE AsaSchluessel OPE ImplantattypSchluessel operationBrustimplantat operationEndoprothese operationAortenklappe artikelidentifikation zubehoer</p> |
| <p>used by</p> | <p>element Fall/operation</p> |
| <p>source</p> | <pre><complexType name="Operation"> <complexContent> <extension base="OperationBasis"> <sequence> <choice> <element name="operationBrustimplantat" type="OperationBrustimplantat"/> <element name="operationEndoprothese" type="OperationEndoprothese"/> <element name="operationAortenklappe" type="OperationAortenklappe"/> </choice> <element name="artikelidentifikation" type="Artikelidentifikation" maxOccurs="unbounded"/> <element name="zubehoer" type="Zubehoer" maxOccurs="unbounded"/> </sequence> </extension> </complexContent> </complexType></pre> |

```

minOccurs="0" maxOccurs="unbounded"/>
  <element name="zubehoer" type="Zubehoer" minOccurs="0"
maxOccurs="unbounded"/>
  </sequence>
</extension>
</complexContent>
</complexType>

```

element **Operation/operationBrustimplantat**

diagram

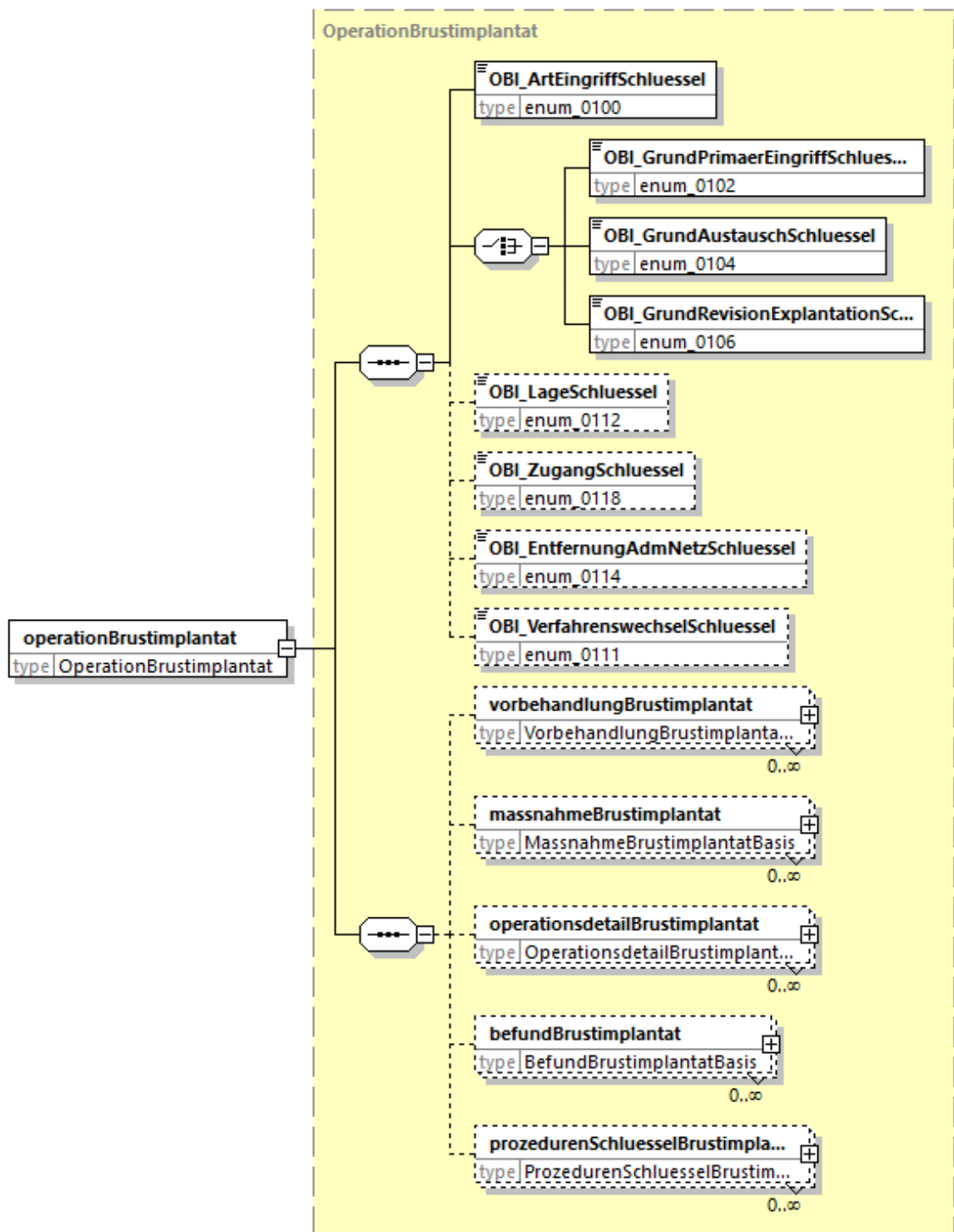

| | |
|------------|--|
| type | OperationBrustimplantat |
| properties | content complex |
| children | OBI ArtEingriffSchluessel OBI GrundPrimaerEingriffSchluessel OBI GrundAustauschSchluessel OBI GrundRevisionExplantationSchluessel OBI LageSchluessel OBI ZugangSchluessel OBI EntfernungAdmNetzSchluessel OBI VerfahrenswechselSchluessel vorbehandlungBrustimplantat massnahmeBrustimplantat operationsdetailBrustimplantat befundBrustimplantat prozedurenSchluesselBrustimplantat |
| source | <code><element name="operationBrustimplantat" type="OperationBrustimplantat"/></code> |

element **Operation/operationEndoprothese**

diagram

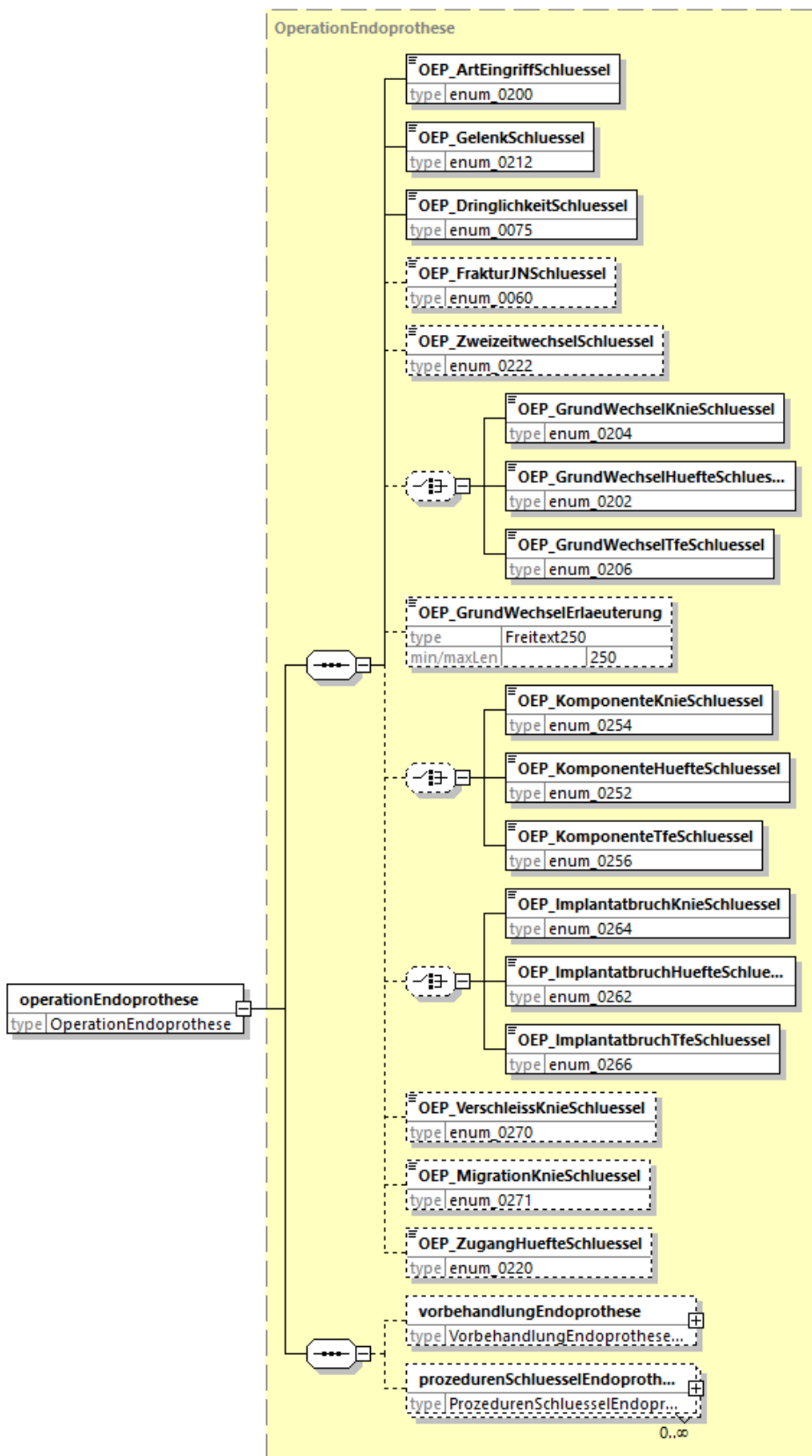

type [OperationEndoprothese](#)

properties content complex

| | |
|----------|---|
| children | OEP ArtEingriffSchluessel OEP GelenkSchluessel OEP DringlichkeitSchluessel OEP FrakturJNSchluessel OEP ZweizeitwechselSchluessel OEP GrundWechselKnieSchluessel OEP GrundWechselHuefteSchluessel OEP GrundWechselTfeSchluessel OEP GrundWechselErlaeuterung OEP KomponenteKnieSchluessel OEP KomponenteHuefteSchluessel OEP KomponenteTfeSchluessel OEP ImplantatbruchKnieSchluessel OEP ImplantatbruchHuefteSchluessel OEP ImplantatbruchTfeSchluessel OEP VerschleissKnieSchluessel OEP MigrationKnieSchluessel OEP ZugangHuefteSchluessel vorbehandlungEndoprothese prozedurenSchluesselEndoprothese |
| source | <code><element name="operationEndoprothese" type="OperationEndoprothese"/></code> |

| | |
|----------|--|
| children | OAK NummerEingriff OAK ArtEingriffSchluessel OAK GrundEingriffSchluessel OAK DringlichkeitSchluessel OAK ExplantationSchluessel OAK IsoliertSchluessel OAK ZugangKonventionellSchluessel OAK ZugangKatheterSchluessel OAK KomplikationenSchluessel OAK TherapieLcoSchluessel OAK Durchleuchtungszeit OAK BeatmungSchluessel OAK TroponinSchluessel OAK InotropeSchluessel OAK Eingriffsdauer OAK EingriffsumfangSchluessel OAK ProzedurenAnzahl OAK VorgehenSchluessel OAK Bypasszeit OAK BypasszeitUnbekannt OAK Abklemmzeit OAK AbklemmzeitUnbekannt OAK AortaThorakalSchluessel OAK NeuroprotektionSchluessel OAK KreislaufunterstuetzungSchluessel OAK PraeOpUnterstuetzungSchluessel OAK PraeOpMethodeSchluessel OAK IntraOpUnterstuetzungSchluessel OAK IntraOpMethodeSchluessel OAK AortenklappenOpAnzahl OAK ValveInValveSchluessel OAK ZugangsGefaessdiameter OAK ZugangsGefaessUnbekannt OAK ZugangVerkalkungSchluessel OAK Aortenklappenannulus OAK MessmethodeSchluessel OAK DistanzRca OAK DistanzRcaUnbekannt OAK DistanzLca OAK DistanzLcaUnbekannt OAK PtcaVorSchluessel OAK PtcaVorDurchmesser OAK PtcaVorDurchmesserUnbekannt OAK PtcaVorAnzahl OAK RapidPacingVorSchluessel OAK RapidPacingIntraSchluessel OAK PtcaNachSchluessel OAK PtcaNachDurchmesser OAK PtcaNachDurchmesserUnbekannt OAK PtcaNachAnzahl OAK RapidPacingNachSchluessel OAK KonversionSchluessel OAK SuccessSchluessel OAK AnaesthesieSchluessel OAK DeltaPmeanNachOp OAK DeltaPmeanNachOpUnbekannt OAK ResidualeInsuffizienzSchluessel OAK ZugangVerschlussSchluessel OAK ZusätzlichePciSchluessel OAK PciWegenKhkSchluessel OAK PciWegenKomplikationSchluessel OAK LaesionenAnzahl komplikationAortenklappe taviAortenklappe pciAortenklappe failureGrundAortenklappe prozedurenSchluesselAortenklappe |
| source | <element name="operationAortenklappe" type="OperationAortenklappe"/> |

element **Operation/artikelidentifikation**

| | |
|-------------------|---|
| <p>diagram</p> | <p>The diagram shows the structure of the 'artikelidentifikation' element. It is composed of several sub-elements:</p> <ul style="list-style-type: none"> ARI_LaufendeNummer: type Zahl3, min/maxIncl 1 999 ARI_IrdNummer: type IrdArtikellid, min/maxLen 16 ARI_Artikelkennzeichen: type String20, min/maxLen 20 ARI_ArtikelkennzeichenUnbekannt: type JaLeer, pattern (1) ARI_KennzeichenTypSchluessel: type enum_0068 ARI_SonderstatusJNSchluessel: type enum_0060 ARI_ArtikelArtSchluessel: type enum_0067 ARI_ArtikelArtFunktionSchluessel: type enum_0071 ARI_GefundenJNSchluessel: type enum_0060 artikelbeschreibung: type Artikelbeschreibung <p>The 'artikelidentifikation' element itself has a type of 'Artikelidentifikation' and a cardinality of '0..∞'.</p> |
| <p>type</p> | <p>Artikelidentifikation</p> |
| <p>properties</p> | <p>minOcc 0 maxOcc unbounded content complex</p> |
| <p>children</p> | <p>ARI LaufendeNummer ARI IrdNummer ARI Artikelkennzeichen ARI ArtikelkennzeichenUnbekannt ARI KennzeichenTypSchluessel ARI SonderstatusJNSchluessel ARI ArtikelArtSchluessel ARI ArtikelArtFunktionSchluessel ARI GefundenJNSchluessel artikelbeschreibung</p> |
| <p>source</p> | <pre><element name="artikelidentifikation" type="Artikelidentifikation" minOccurs="0" maxOccurs="unbounded"/></pre> |

element **Operation/zubehoer**

| | |
|-------------------|---|
| <p>diagram</p> | |
| <p>type</p> | <p>Zubehoer</p> |
| <p>properties</p> | <p>minOcc 0 maxOcc unbounded content complex</p> |
| <p>children</p> | <p>ZUB LaufendeNummer ZUB ZubehoerArtSchluessel ZUB ArtikelNummer ZUB ArtikelNummerUnbekannt ZUB LotNummer ZUB LotNummerUnbekannt ZUB SerienNummer ZUB SerienNummerUnbekannt ZUB Artikelbezeichnung zubehoerBrustimplantat zubehoerEndoprothese</p> |
| <p>source</p> | <p><element name="zubehoer" type="Zubehoer" minOccurs="0" maxOccurs="unbounded"/></p> |

complexType Entlassung

| | |
|------------|---|
| diagram | |
| namespace | http://xml.ir-d.de/emg |
| type | extension of EntlassungBasis |
| properties | base EntlassungBasis |
| children | ENT_Datum ENT_GrundSchluessel diagnoseBrustimplantat diagnoseEndoprothese diagnoseAortenklappe |
| used by | element Fall/entlassung |
| source | <pre> <complexType name="Entlassung"> <complexContent> <extension base="EntlassungBasis"> <sequence> <element name="diagnoseBrustimplantat" type="DiagnoseBrustimplantatBasis" minOccurs="0" maxOccurs="unbounded"/> <element name="diagnoseEndoprothese" type="DiagnoseEndoprotheseBasis" minOccurs="0" maxOccurs="unbounded"/> <element name="diagnoseAortenklappe" type="DiagnoseAortenklappeBasis" minOccurs="0" maxOccurs="unbounded"/> </sequence> </extension> </complexContent> </complexType> </pre> |

element Entlassung/diagnoseBrustimplantat

| | |
|---------|--|
| diagram | |
|---------|--|

| | |
|------------|--|
| type | DiagnoseBrustimplantatBasis |
| properties | minOcc 0 maxOcc unbounded content complex |
| children | DBI IcdSchluessel |
| source | <code><element name="diagnoseBrustimplantat" type="DiagnoseBrustimplantatBasis" minOccurs="0" maxOccurs="unbounded"/></code> |

element Entlassung/diagnoseEndoprothese

| | |
|------------|--|
| diagram | |
| type | DiagnoseEndoprotheseBasis |
| properties | minOcc 0 maxOcc unbounded content complex |
| children | DEP IcdSchluessel |
| source | <code><element name="diagnoseEndoprothese" type="DiagnoseEndoprotheseBasis" minOccurs="0" maxOccurs="unbounded"/></code> |

element Entlassung/diagnoseAortenklappe

| | |
|------------|--|
| diagram | |
| type | DiagnoseAortenklappeBasis |
| properties | minOcc 0 maxOcc unbounded content complex |
| children | DAK IcdSchluessel |
| source | <code><element name="diagnoseAortenklappe" type="DiagnoseAortenklappeBasis" minOccurs="0" maxOccurs="unbounded"/></code> |

complexType PostoperationAortenklappe

diagram

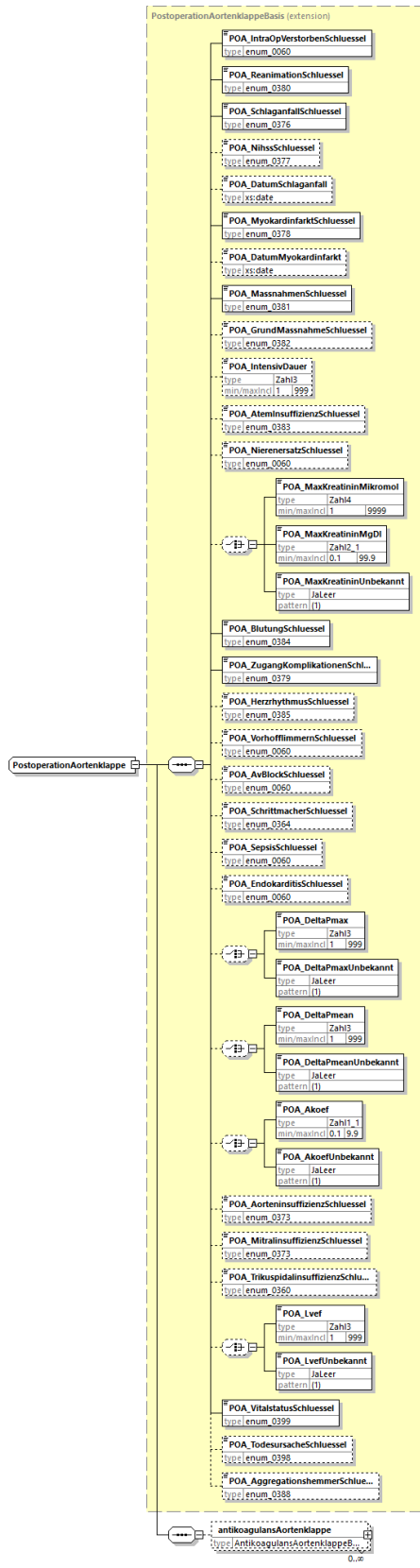

| | |
|-----------|---|
| namespace | http://xml.ir-d.de/emg |
| type | extension of PostoperationAortenklappeBasis |

| | |
|------------|--|
| properties | base PostoperationAortenklappeBasis |
| children | POA IntraOpVerstorbenSchluessel POA ReanimationSchluessel POA SchlaganfallSchluessel POA NihssSchluessel POA DatumSchlaganfall POA MyokardinfarktSchluessel POA DatumMyokardinfarkt POA MassnahmenSchluessel POA GrundMassnahmeSchluessel POA IntensivDauer POA AtemInsuffizienzSchluessel POA NierenersatzSchluessel POA MaxKreatininMikromol POA MaxKreatininMgDL POA MaxKreatininUnbekannt POA BlutungSchluessel POA ZugangKomplikationenSchluessel POA HerzrhythmusSchluessel POA VorhofflimmernSchluessel POA AvBlockSchluessel POA SchrittmacherSchluessel POA SepsisSchluessel POA EndokarditisSchluessel POA DeltaPmax POA DeltaPmaxUnbekannt POA DeltaPmean POA DeltaPmeanUnbekannt POA Akoef POA AkoefUnbekannt POA AorteninsuffizienzSchluessel POA MitralinsuffizienzSchluessel POA TrikuspidalinsuffizienzSchluessel POA Lvef POA LvefUnbekannt POA VitalstatusSchluessel POA TodesursacheSchluessel POA AggregationshemmerSchluessel antikoagulansAortenklappe |
| used by | element Fall/postoperationAortenklappe |
| source | <pre><complexType name="PostoperationAortenklappe"> <complexContent> <extension base="PostoperationAortenklappeBasis"> <sequence> <element name="antikoagulansAortenklappe" type="AntikoagulansAortenklappeBasis" minOccurs="0" maxOccurs="unbounded"/> </sequence> </extension> </complexContent> </complexType></pre> |

element [PostoperationAortenklappe/antikoagulansAortenklappe](#)

| | |
|------------|--|
| diagram | |
| type | AntikoagulansAortenklappeBasis |
| properties | minOcc 0 maxOcc unbounded content complex |
| children | AKA AntikoagulansSchluessel |
| source | <pre><element name="antikoagulansAortenklappe" type="AntikoagulansAortenklappeBasis" minOccurs="0" maxOccurs="unbounded"/></pre> |

simpleType [enum_0044](#)

| | | | |
|------------|--------------------------------|---------|--|
| namespace | http://xml.ir-d.de/stn | | |
| type | restriction of string | | |
| properties | base xs:string | | |
| facets | Kind | Value | Annotation |
| | enumeration | 0044001 | documentation 1= normaler, sonst gesunder Patient |
| | enumeration | 0044002 | documentation 2= Patient mit leichter Allgemeinerkrankung |
| | enumeration | 0044003 | documentation 3= Patient mit schwerer Allgemeinerkrankung |
| | enumeration | 0044004 | documentation |

| | |
|------------|---|
| | <p>4= Patient mit schwerer Allgemeinerkrankung, die eine ständige Lebensbedrohung darstellt</p> <p>enumeration 0044005 documentation</p> <p>5= moribunder Patient, der ohne die Operation voraussichtlich nicht überleben wird</p> |
| annotation | <p>documentation</p> <p>Kat_ASA</p> |
| source | <pre> <simpleType name="enum_0044"> <annotation> <documentation>Kat_ASA</documentation> </annotation> <restriction base="xs:string"> <enumeration value="0044001"> <annotation> <documentation>1= normaler, sonst gesunder Patient</documentation> </annotation> </enumeration> <enumeration value="0044002"> <annotation> <documentation>2= Patient mit leichter Allgemeinerkrankung</documentation> </annotation> </enumeration> <enumeration value="0044003"> <annotation> <documentation>3= Patient mit schwerer Allgemeinerkrankung</documentation> </annotation> </enumeration> <enumeration value="0044004"> <annotation> <documentation>4= Patient mit schwerer Allgemeinerkrankung, die eine ständige Lebensbedrohung darstellt</documentation> </annotation> </enumeration> <enumeration value="0044005"> <annotation> <documentation>5= moribunder Patient, der ohne die Operation voraussichtlich nicht überleben wird</documentation> </annotation> </enumeration> </restriction> </simpleType> </pre> |

simpleType enum_0050

| | | | |
|------------|---|---------|-------------------------|
| namespace | http://xml.ir-d.de/stn | | |
| type | restriction of string | | |
| properties | base xs:string | | |
| facets | Kind | Value | Annotation |
| | enumeration | 0050001 | documentation rechts |
| | enumeration | 0050002 | documentation links |
| annotation | documentation Kat_RechtsLinks | | |
| source | <pre> <simpleType name="enum_0050"> <annotation> </pre> | | |

| | |
|--|--|
| | <pre> <documentation>Kat_RechtsLinks</documentation> </annotation> <restriction base="xs:string"> <enumeration value="0050001"> <annotation> <documentation>rechts</documentation> </annotation> </enumeration> <enumeration value="0050002"> <annotation> <documentation>links</documentation> </annotation> </enumeration> </restriction> </simpleType> </pre> |
|--|--|

simpleType enum_0060

| | | | |
|------------|---|---------|-----------------------|
| namespace | http://xml.ir-d.de/stn | | |
| type | restriction of string | | |
| properties | base xs:string | | |
| facets | Kind | Value | Annotation |
| | enumeration | 0060001 | documentation ja |
| | enumeration | 0060002 | documentation nein |
| annotation | documentation Kat_JaNein | | |
| source | <pre> <simpleType name="enum_0060"> <annotation> <documentation>Kat_JaNein</documentation> </annotation> <restriction base="xs:string"> <enumeration value="0060001"> <annotation> <documentation>ja</documentation> </annotation> </enumeration> <enumeration value="0060002"> <annotation> <documentation>nein</documentation> </annotation> </enumeration> </restriction> </simpleType> </pre> | | |

simpleType enum_0061

| | | | |
|------------|------------------------------|---------|---------------------|
| namespace | http://xml.ir-d.de/stn | | |
| type | restriction of string | | |
| properties | base xs:string | | |
| facets | Kind | Value | Annotation |
| | enumeration | 0061001 | documentation ja |

| | |
|------------|---|
| | enumeration 0061002 documentation nein enumeration 0061099 documentation unbekannt |
| annotation | documentation Kat_JaNeinUnbekannt |
| source | <pre> <simpleType name="enum_0061"> <annotation> <documentation>Kat_JaNeinUnbekannt</documentation> </annotation> <restriction base="xs:string"> <enumeration value="0061001"> <annotation> <documentation>ja</documentation> </annotation> </enumeration> <enumeration value="0061002"> <annotation> <documentation>nein</documentation> </annotation> </enumeration> <enumeration value="0061099"> <annotation> <documentation>unbekannt</documentation> </annotation> </enumeration> </restriction> </simpleType> </pre> |

simpleType enum 0062

| | | | |
|------------|------------------------------|---------|----------------------------------|
| namespace | http://xml.ir-d.de/stn | | |
| type | restriction of string | | |
| properties | base xs:string | | |
| facets | Kind | Value | Annotation |
| | enumeration | 0062001 | documentation Stück |
| | enumeration | 0062002 | documentation g |
| | enumeration | 0062003 | documentation mg |
| | enumeration | 0062004 | documentation l |
| | enumeration | 0062005 | documentation ml |
| | enumeration | 0062006 | documentation cm ³ |
| | enumeration | 0062007 | documentation mm |
| | enumeration | 0062008 | documentation cm |
| | enumeration | 0062009 | documentation dm |
| | enumeration | 0062010 | documentation m |
| | enumeration | 0062042 | documentation andere |
| annotation | documentation Kat_Einheit | | |

source

```
<simpleType name="enum_0062">
  <annotation>
    <documentation>Kat_Einheit</documentation>
  </annotation>
  <restriction base="xs:string">
    <enumeration value="0062001">
      <annotation>
        <documentation>Stück</documentation>
      </annotation>
    </enumeration>
    <enumeration value="0062002">
      <annotation>
        <documentation>g</documentation>
      </annotation>
    </enumeration>
    <enumeration value="0062003">
      <annotation>
        <documentation>mg</documentation>
      </annotation>
    </enumeration>
    <enumeration value="0062004">
      <annotation>
        <documentation>l</documentation>
      </annotation>
    </enumeration>
    <enumeration value="0062005">
      <annotation>
        <documentation>ml</documentation>
      </annotation>
    </enumeration>
    <enumeration value="0062006">
      <annotation>
        <documentation>cm3</documentation>
      </annotation>
    </enumeration>
    <enumeration value="0062007">
      <annotation>
        <documentation>mm</documentation>
      </annotation>
    </enumeration>
    <enumeration value="0062008">
      <annotation>
        <documentation>cm</documentation>
      </annotation>
    </enumeration>
    <enumeration value="0062009">
      <annotation>
        <documentation>dm</documentation>
      </annotation>
    </enumeration>
    <enumeration value="0062010">
      <annotation>
        <documentation>m</documentation>
      </annotation>
    </enumeration>
    <enumeration value="0062042">
      <annotation>
        <documentation>andere</documentation>
      </annotation>
    </enumeration>
  </restriction>
</simpleType>
```

| | |
|--|--|
| | <pre> </enumeration> </restriction> </simpleType> </pre> |
|--|--|

simpleType enum_0065

| | | | |
|------------|--|---------|--------------------------------|
| namespace | http://xml.ir-d.de/stn | | |
| type | restriction of string | | |
| properties | base xs:string | | |
| facets | Kind | Value | Annotation |
| | enumeration | 0065001 | documentation stationär |
| | enumeration | 0065002 | documentation teilstationär |
| | enumeration | 0065003 | documentation ambulant |
| annotation | documentation Kat_ArtAufenthalt | | |
| source | <pre> <simpleType name="enum_0065"> <annotation> <documentation>Kat_ArtAufenthalt</documentation> </annotation> <restriction base="xs:string"> <enumeration value="0065001"> <annotation> <documentation>stationär</documentation> </annotation> </enumeration> <enumeration value="0065002"> <annotation> <documentation>teilstationär</documentation> </annotation> </enumeration> <enumeration value="0065003"> <annotation> <documentation>ambulant</documentation> </annotation> </enumeration> </restriction> </simpleType> </pre> | | |

simpleType enum_0067

| | | | |
|------------|--|---------|----------------------------|
| namespace | http://xml.ir-d.de/stn | | |
| type | restriction of string | | |
| properties | base xs:string | | |
| facets | Kind | Value | Annotation |
| | enumeration | 0067001 | documentation Implantat |
| | enumeration | 0067002 | documentation Explantat |
| annotation | documentation Kat_ArtArtikel | | |
| source | <pre> <simpleType name="enum_0067"> </pre> | | |

| | |
|--|---|
| | <pre> <annotation> <documentation>Kat_ArtArtikel</documentation> </annotation> <restriction base="xs:string"> <enumeration value="0067001"> <annotation> <documentation>Implantat</documentation> </annotation> </enumeration> <enumeration value="0067002"> <annotation> <documentation>Explantat</documentation> </annotation> </enumeration> </restriction> </simpleType> </pre> |
|--|---|

simpleType enum 0068

| | | | |
|------------|--|---------|---------------------------------|
| namespace | http://xml.ir-d.de/stn | | |
| type | restriction of string | | |
| properties | base xs:string | | |
| facets | Kind | Value | Annotation |
| | enumeration | 0068001 | documentation UDI |
| | enumeration | 0068002 | documentation Referenz (REF) |
| | enumeration | 0068003 | documentation Katalognummer |
| | enumeration | 0068042 | documentation sonstiger |
| annotation | documentation Kat_KennzeichenTyp | | |
| source | <pre> <simpleType name="enum_0068"> <annotation> <documentation>Kat_KennzeichenTyp</documentation> </annotation> <restriction base="xs:string"> <enumeration value="0068001"> <annotation> <documentation>UDI</documentation> </annotation> </enumeration> <enumeration value="0068002"> <annotation> <documentation>Referenz (REF)</documentation> </annotation> </enumeration> <enumeration value="0068003"> <annotation> <documentation>Katalognummer</documentation> </annotation> </enumeration> <enumeration value="0068042"> <annotation> <documentation>sonstiger</documentation> </annotation> </enumeration> </restriction> </simpleType> </pre> | | |

| | |
|--|--|
| | <pre> </enumeration> </restriction> </simpleType> </pre> |
|--|--|

simpleType enum_0069

| | | | |
|------------|--|---------|----------------------------|
| namespace | http://xml.ir-d.de/stn | | |
| type | restriction of string | | |
| properties | base xs:string | | |
| facets | Kind | Value | Annotation |
| | enumeration | 0069001 | documentation Implantat |
| | enumeration | 0069002 | documentation Explantat |
| annotation | documentation Kat_ArtZubehoer | | |
| source | <pre> <simpleType name="enum_0069"> <annotation> <documentation>Kat_ArtZubehoer</documentation> </annotation> <restriction base="xs:string"> <enumeration value="0069001"> <annotation> <documentation>Implantat</documentation> </annotation> </enumeration> <enumeration value="0069002"> <annotation> <documentation>Explantat</documentation> </annotation> </enumeration> </restriction> </simpleType> </pre> | | |

simpleType enum_0070

| | | | |
|------------|---|---------|-----------------------------|
| namespace | http://xml.ir-d.de/stn | | |
| type | restriction of string | | |
| properties | base xs:string | | |
| facets | Kind | Value | Annotation |
| | enumeration | 0070001 | documentation weiblich |
| | enumeration | 0070002 | documentation männlich |
| | enumeration | 0070003 | documentation divers |
| | enumeration | 0070042 | documentation unbestimmt |
| annotation | documentation Kat_Geschlecht | | |
| source | <pre> <simpleType name="enum_0070"> <annotation> <documentation>Kat_Geschlecht</documentation> </annotation> </pre> | | |

| | |
|--|--|
| | <pre> <restriction base="xs:string"> <enumeration value="0070001"> <annotation> <documentation>weiblich</documentation> </annotation> </enumeration> <enumeration value="0070002"> <annotation> <documentation>männlich</documentation> </annotation> </enumeration> <enumeration value="0070003"> <annotation> <documentation>divers</documentation> </annotation> </enumeration> <enumeration value="0070042"> <annotation> <documentation>unbestimmt</documentation> </annotation> </enumeration> </restriction> </simpleType> </pre> |
|--|--|

simpleType enum_0071

| | | | |
|------------|---|---------|---|
| namespace | http://xml.ir-d.de/stn | | |
| type | restriction of string | | |
| properties | base xs:string | | |
| facets | Kind | Value | Annotation |
| | enumeration | 0071001 | documentation Implantat |
| | enumeration | 0071002 | documentation Explantat |
| | enumeration | 0071003 | documentation Degeneriertes/defektes Produkt, das funktionslos im Körper verbleibt |
| annotation | documentation Kat ArtikelArtFunktion | | |
| source | <pre> <simpleType name="enum_0071"> <annotation> <documentation>Kat_ArtikelArtFunktion</documentation> </annotation> <restriction base="xs:string"> <enumeration value="0071001"> <annotation> <documentation>Implantat</documentation> </annotation> </enumeration> <enumeration value="0071002"> <annotation> <documentation>Explantat</documentation> </annotation> </enumeration> <enumeration value="0071003"> <annotation> <documentation>Degeneriertes/defektes Produkt, das funktionslos im Körper verbleibt</documentation> </annotation> </enumeration> </restriction> </simpleType> </pre> | | |

```

</annotation>
</enumeration>
</restriction>
</simpleType>

```

simpleType enum_0075

| | | | |
|------------|---|---------|----------------------------|
| namespace | http://xml.ir-d.de/stn | | |
| type | restriction of string | | |
| properties | base xs:string | | |
| facets | Kind | Value | Annotation |
| | enumeration | 0075001 | documentation elektiv |
| | enumeration | 0075002 | documentation dringlich |
| | enumeration | 0075003 | documentation Notfall |
| annotation | documentation Kat_Dringlichkeit | | |
| source | <pre> <simpleType name="enum_0075"> <annotation> <documentation>Kat_Dringlichkeit</documentation> </annotation> <restriction base="xs:string"> <enumeration value="0075001"> <annotation> <documentation>elektiv</documentation> </annotation> </enumeration> <enumeration value="0075002"> <annotation> <documentation>dringlich</documentation> </annotation> </enumeration> <enumeration value="0075003"> <annotation> <documentation>Notfall</documentation> </annotation> </enumeration> </restriction> </simpleType> </pre> | | |

simpleType enum_0076

| | | | |
|------------|------------------------------|---------|----------------------------|
| namespace | http://xml.ir-d.de/stn | | |
| type | restriction of string | | |
| properties | base xs:string | | |
| facets | Kind | Value | Annotation |
| | enumeration | 0076001 | documentation elektiv |
| | enumeration | 0076002 | documentation dringlich |
| | enumeration | 0076003 | documentation Notfall |
| | enumeration | 0076004 | documentation |

| | |
|------------|---|
| | Notfall (Reanimation / ultima ratio) |
| annotation | documentation Kat Dringlichkeit Reanimation |
| source | <pre> <simpleType name="enum_0076"> <annotation> <documentation>Kat_Dringlichkeit_Reanimation</documentation> </annotation> <restriction base="xs:string"> <enumeration value="0076001"> <annotation> <documentation>elektiv</documentation> </annotation> </enumeration> <enumeration value="0076002"> <annotation> <documentation>dringlich</documentation> </annotation> </enumeration> <enumeration value="0076003"> <annotation> <documentation>Notfall</documentation> </annotation> </enumeration> <enumeration value="0076004"> <annotation> <documentation>Notfall (Reanimation / ultima ratio)</documentation> </annotation> </enumeration> </restriction> </simpleType> </pre> |

simpleType enum_0080

| | | | |
|------------|--|---------|--|
| namespace | http://xml.ir-d.de/stn | | |
| type | restriction of string | | |
| properties | base xs:string | | |
| facets | Kind | Value | Annotation |
| | enumeration | 0080001 | documentation Endoprothese Hüfte/Knie |
| | enumeration | 0080002 | documentation Brustimplantat |
| | enumeration | 0080003 | documentation Aortenklappenprothese |
| annotation | documentation Kat_Implantattyp | | |
| source | <pre> <simpleType name="enum_0080"> <annotation> <documentation>Kat_Implantattyp</documentation> </annotation> <restriction base="xs:string"> <enumeration value="0080001"> <annotation> <documentation>Endoprothese Hüfte/Knie</documentation> </annotation> </enumeration> <enumeration value="0080002"> <annotation> </pre> | | |

| | |
|--|---|
| | <pre> <documentation>Brustimplantat</documentation> </annotation> </enumeration> <enumeration value="0080003"> <annotation> <documentation>Aortenklappenprothese</documentation> </annotation> </enumeration> </restriction> </simpleType> </pre> |
|--|---|

simpleType enum_0100

| | | | |
|------------|--|---------|--|
| namespace | http://xml.ir-d.de/stn | | |
| type | restriction of string | | |
| properties | base xs:string | | |
| facets | Kind | Value | Annotation |
| | enumeration | 0100001 | documentation Primäreingriff |
| | enumeration | 0100002 | documentation Austausch Expander gegen dauerhaftes Brustimplantat |
| | enumeration | 0100003 | documentation Revision |
| | enumeration | 0100004 | documentation Nur Explantation |
| annotation | documentation Kat_BI_ArtEingriff | | |
| source | <pre> <simpleType name="enum_0100"> <annotation> <documentation>Kat_BI_ArtEingriff</documentation> </annotation> <restriction base="xs:string"> <enumeration value="0100001"> <annotation> <documentation>Primäreingriff</documentation> </annotation> </enumeration> <enumeration value="0100002"> <annotation> <documentation>Austausch Expander gegen dauerhaftes Brustimplantat</documentation> </annotation> </enumeration> <enumeration value="0100003"> <annotation> <documentation>Revision</documentation> </annotation> </enumeration> <enumeration value="0100004"> <annotation> <documentation>Nur Explantation</documentation> </annotation> </enumeration> </restriction> </simpleType> </pre> | | |

simpleType enum_0102

| | | | |
|------------|--|---------|---|
| namespace | http://xml.ir-d.de/stn | | |
| type | restriction of string | | |
| properties | base xs:string | | |
| facets | Kind | Value | Annotation |
| | enumeration | 0102001 | documentation kosmetische Augmentation |
| | enumeration | 0102002 | documentation Rekonstruktion, benigne |
| | enumeration | 0102003 | documentation Rekonstruktion nach Mastektomie aufgrund eines Karzinoms |
| | enumeration | 0102004 | documentation Rekonstruktion nach risikoreduzierender Mastektomie |
| annotation | documentation Kat_BI_GrundPrimaereingriff | | |
| source | <pre> <simpleType name="enum_0102"> <annotation> <documentation>Kat_BI_GrundPrimaereingriff</documentation> </annotation> <restriction base="xs:string"> <enumeration value="0102001"> <annotation> <documentation>kosmetische Augmentation</documentation> </annotation> </enumeration> <enumeration value="0102002"> <annotation> <documentation>Rekonstruktion, benigne</documentation> </annotation> </enumeration> <enumeration value="0102003"> <annotation> <documentation>Rekonstruktion nach Mastektomie aufgrund eines Karzinoms</documentation> </annotation> </enumeration> <enumeration value="0102004"> <annotation> <documentation>Rekonstruktion nach risikoreduzierender Mastektomie</documentation> </annotation> </enumeration> </restriction> </simpleType> </pre> | | |

simpleType enum_0103

| | | | |
|------------|------------------------------|---------|--|
| namespace | http://xml.ir-d.de/stn | | |
| type | restriction of string | | |
| properties | base xs:string | | |
| facets | Kind | Value | Annotation |
| | enumeration | 0103001 | documentation simultane Lappendeckung |
| | enumeration | 0103002 | documentation |

| | |
|------------|---|
| | <p>enumeration 0103003 simultane Eigenfetttransplantation documentation</p> <p>enumeration 0103005 simultane Mastopexie documentation</p> <p>enumeration 0103006 simultane Mastektomie, Ablatio / hautsparend documentation</p> <p>enumeration 0103007 simultane Mastektomie, nippelerhaltend documentation</p> <p>enumeration 0103008 Axilla-Dissektion documentation Drainage</p> |
| annotation | documentation Kat_BI_OperationsdetailPrimaereingriff |
| source | <pre> <simpleType name="enum_0103"> <annotation> <documentation>Kat_BI_OperationsdetailPrimaereingriff</documentation> </annotation> <restriction base="xs:string"> <enumeration value="0103001"> <annotation> <documentation>simultane Lappendeckung</documentation> </annotation> </enumeration> <enumeration value="0103002"> <annotation> <documentation>simultane Eigenfetttransplantation</documentation> </annotation> </enumeration> <enumeration value="0103003"> <annotation> <documentation>simultane Mastopexie</documentation> </annotation> </enumeration> <enumeration value="0103005"> <annotation> <documentation>simultane Mastektomie, Ablatio / hautsparend</documentation> </annotation> </enumeration> <enumeration value="0103006"> <annotation> <documentation>simultane Mastektomie, nippelerhaltend</documentation> </annotation> </enumeration> <enumeration value="0103007"> <annotation> <documentation>Axilla-Dissektion</documentation> </annotation> </enumeration> <enumeration value="0103008"> <annotation> <documentation>Drainage</documentation> </annotation> </enumeration> </restriction> </simpleType> </pre> |

simpleType enum_0104

| | | | |
|------------|---|---------|--|
| namespace | http://xml.ir-d.de/stn | | |
| type | restriction of string | | |
| properties | base xs:string | | |
| facets | Kind | Value | Annotation |
| | enumeration | 0104001 | documentation Austausch Expander gegen dauerhaftes Brustimplantat |
| annotation | documentation Kat_BI_GrundAustausch | | |
| source | <pre> <simpleType name="enum_0104"> <annotation> <documentation>Kat_BI_GrundAustausch</documentation> </annotation> <restriction base="xs:string"> <enumeration value="0104001"> <annotation> <documentation>Austausch Expander gegen dauerhaftes Brustimplantat</documentation> </annotation> </enumeration> </restriction> </simpleType> </pre> | | |

simpleType enum_0105

| | | | |
|------------|---|---------|---|
| namespace | http://xml.ir-d.de/stn | | |
| type | restriction of string | | |
| properties | base xs:string | | |
| facets | Kind | Value | Annotation |
| | enumeration | 0105001 | documentation simultane Lappendeckung |
| | enumeration | 0105002 | documentation simultane Eigenfetttransplantation |
| | enumeration | 0105003 | documentation simultane Mastopexie |
| | enumeration | 0105008 | documentation Drainage |
| | enumeration | 0105009 | documentation Kapsulektomie, komplett |
| | enumeration | 0105010 | documentation Kapsulektomie, partiell |
| | enumeration | 0105011 | documentation Neopocket |
| annotation | documentation Kat_BI_OperationsdetailAustausch | | |
| source | <pre> <simpleType name="enum_0105"> <annotation> <documentation>Kat_BI_OperationsdetailAustausch</documentation> </annotation> <restriction base="xs:string"> <enumeration value="0105001"> <annotation> <documentation>simultane Lappendeckung</documentation> </annotation> </enumeration> <enumeration value="0105002"> </pre> | | |

| | |
|--|--|
| | <pre> <annotation> <documentation>simultane Eigenfetttransplantation</documentation> </annotation> </enumeration> <enumeration value="0105003"> <annotation> <documentation>simultane Mastopexie</documentation> </annotation> </enumeration> <enumeration value="0105008"> <annotation> <documentation>Drainage</documentation> </annotation> </enumeration> <enumeration value="0105009"> <annotation> <documentation>Kapsulektomie, komplett</documentation> </annotation> </enumeration> <enumeration value="0105010"> <annotation> <documentation>Kapsulektomie, partiell</documentation> </annotation> </enumeration> <enumeration value="0105011"> <annotation> <documentation>Neopocket</documentation> </annotation> </enumeration> </restriction> </simpleType> </pre> |
|--|--|

simpleType enum_0106

| | | | |
|------------|---|---------|----------------------------------|
| namespace | http://xml.ir-d.de/stn | | |
| type | restriction of string | | |
| properties | base xs:string | | |
| facets | Kind | Value | Annotation |
| | enumeration | 0106001 | documentation Patientenwunsch |
| | enumeration | 0106002 | documentation asymptomatisch |
| | enumeration | 0106003 | documentation Komplikation |
| annotation | documentation Kat_BI_GrundRevisionExplantation | | |
| source | <pre> <simpleType name="enum_0106"> <annotation> <documentation>Kat_BI_GrundRevisionExplantation</documentation> </annotation> <restriction base="xs:string"> <enumeration value="0106001"> <annotation> <documentation>Patientenwunsch</documentation> </annotation> </enumeration> <enumeration value="0106002"> </pre> | | |

| | |
|--|---|
| | <pre> <annotation> <documentation>asymptomatisch</documentation> </annotation> </enumeration> <enumeration value="0106003"> <annotation> <documentation>Komplikation</documentation> </annotation> </enumeration> </restriction> </simpleType> </pre> |
|--|---|

simpleType enum_0107

| | | | |
|------------|---|---------|---|
| namespace | http://xml.ir-d.de/stn | | |
| type | restriction of string | | |
| properties | base xs:string | | |
| facets | Kind | Value | Annotation |
| | enumeration | 0107001 | documentation simultane Lappendeckung |
| | enumeration | 0107002 | documentation simultane Eigenfetttransplantation |
| | enumeration | 0107003 | documentation simultane Mastopexie |
| | enumeration | 0107005 | documentation simultane Mastektomie, Ablatio / hautsparend |
| | enumeration | 0107006 | documentation simultane Mastektomie, nippelerhaltend |
| | enumeration | 0107007 | documentation Axilla-Dissektion |
| | enumeration | 0107008 | documentation Drainage |
| | enumeration | 0107009 | documentation Kapsulektomie, komplett |
| | enumeration | 0107010 | documentation Kapsulektomie, partiell |
| | enumeration | 0107011 | documentation Neopocket |
| annotation | documentation Kat_BI_OperationsdetailRevision | | |
| source | <pre> <simpleType name="enum_0107"> <annotation> <documentation>Kat_BI_OperationsdetailRevision</documentation> </annotation> <restriction base="xs:string"> <enumeration value="0107001"> <annotation> <documentation>simultane Lappendeckung</documentation> </annotation> </enumeration> <enumeration value="0107002"> <annotation> <documentation>simultane Eigenfetttransplantation</documentation> </annotation> </enumeration> <enumeration value="0107003"> <annotation> <documentation>simultane Mastopexie</documentation> </pre> | | |

```

</annotation>
</enumeration>
<enumeration value="0107005">
  <annotation>
    <documentation>simultane Mastektomie, Ablatio /
hautsparend</documentation>
  </annotation>
</enumeration>
<enumeration value="0107006">
  <annotation>
    <documentation>simultane Mastektomie, nippelerhaltend</documentation>
  </annotation>
</enumeration>
<enumeration value="0107007">
  <annotation>
    <documentation>Axilla-Dissektion</documentation>
  </annotation>
</enumeration>
<enumeration value="0107008">
  <annotation>
    <documentation>Drainage</documentation>
  </annotation>
</enumeration>
<enumeration value="0107009">
  <annotation>
    <documentation>Kapsulektomie, komplett</documentation>
  </annotation>
</enumeration>
<enumeration value="0107010">
  <annotation>
    <documentation>Kapsulektomie, partiell</documentation>
  </annotation>
</enumeration>
<enumeration value="0107011">
  <annotation>
    <documentation>Neopocket</documentation>
  </annotation>
</enumeration>
</restriction>
</simpleType>

```

simpleType **enum_0110**

| | | | |
|------------|--|------------------|--|
| namespace | http://xml.ir-d.de/stn | | |
| type | restriction of string | | |
| properties | base xs:string | | |
| facets | Kind enumeration | Value 0110001 | Annotation documentation Bestrahlung |
| annotation | documentation Kat_BI_VorbehandlungLokal | | |
| source | <simpleType name="enum_0110"> <annotation> <documentation>Kat_BI_VorbehandlungLokal</documentation> </annotation> <restriction base="xs:string"> | | |

| | |
|--|--|
| | <pre> <enumeration value="0110001"> <annotation> <documentation>Bestrahlung</documentation> </annotation> </enumeration> </restriction> </simpleType> </pre> |
|--|--|

simpleType enum_0111

| | | | |
|------------|--|---------|---|
| namespace | http://xml.ir-d.de/stn | | |
| type | restriction of string | | |
| properties | base xs:string | | |
| facets | Kind | Value | Annotation |
| | enumeration | 0111001 | documentation nein |
| | enumeration | 0111002 | documentation Lipofilling |
| | enumeration | 0111003 | documentation Eigengewebstrekonstruktion |
| annotation | documentation Kat_BI_Verfahrenswechsel | | |
| source | <pre> <simpleType name="enum_0111"> <annotation> <documentation>Kat_BI_Verfahrenswechsel</documentation> </annotation> <restriction base="xs:string"> <enumeration value="0111001"> <annotation> <documentation>nein</documentation> </annotation> </enumeration> <enumeration value="0111002"> <annotation> <documentation>Lipofilling</documentation> </annotation> </enumeration> <enumeration value="0111003"> <annotation> <documentation>Eigengewebstrekonstruktion</documentation> </annotation> </enumeration> </restriction> </simpleType> </pre> | | |

simpleType enum_0112

| | | | |
|------------|------------------------------|---------|---|
| namespace | http://xml.ir-d.de/stn | | |
| type | restriction of string | | |
| properties | base xs:string | | |
| facets | Kind | Value | Annotation |
| | enumeration | 0112001 | documentation subglandulär / epipektoral |
| | enumeration | 0112002 | documentation |

| | |
|------------|--|
| | <p>enumeration 0112003 subpektoral documentation subfaszial</p> <p>enumeration 0112004 documentation sub-flap</p> <p>enumeration 0112005 documentation subkutan</p> <p>enumeration 0112006 documentation dual plane</p> <p>enumeration 0112042 documentation andere</p> |
| annotation | documentation Kat BI_LageImplantat |
| source | <pre> <simpleType name="enum_0112"> <annotation> <documentation>Kat_BI_LageImplantat</documentation> </annotation> <restriction base="xs:string"> <enumeration value="0112001"> <annotation> <documentation>subglandulär / epipektoral</documentation> </annotation> </enumeration> <enumeration value="0112002"> <annotation> <documentation>subpektoral</documentation> </annotation> </enumeration> <enumeration value="0112003"> <annotation> <documentation>subfaszial</documentation> </annotation> </enumeration> <enumeration value="0112004"> <annotation> <documentation>sub-flap</documentation> </annotation> </enumeration> <enumeration value="0112005"> <annotation> <documentation>subkutan</documentation> </annotation> </enumeration> <enumeration value="0112006"> <annotation> <documentation>dual plane</documentation> </annotation> </enumeration> <enumeration value="0112042"> <annotation> <documentation>andere</documentation> </annotation> </enumeration> </restriction> </simpleType> </pre> |

simpleType enum_0113

| | | | |
|------------|--|---------|--|
| namespace | http://xml.ir-d.de/stn | | |
| type | restriction of string | | |
| properties | base xs:string | | |
| facets | Kind | Value | Annotation |
| | enumeration | 0113001 | documentation Chemotherapie innerhalb der letzten drei Monate |
| annotation | documentation Kat_BI_VorbehandlungSystemisch | | |
| source | <pre><simpleType name="enum_0113"> <annotation> <documentation>Kat_BI_VorbehandlungSystemisch</documentation> </annotation> <restriction base="xs:string"> <enumeration value="0113001"> <annotation> <documentation>Chemotherapie innerhalb der letzten drei Monate</documentation> </annotation> </enumeration> </restriction> </simpleType></pre> | | |

simpleType enum_0114

| | | | |
|------------|---|---------|----------------------------------|
| namespace | http://xml.ir-d.de/stn | | |
| type | restriction of string | | |
| properties | base xs:string | | |
| facets | Kind | Value | Annotation |
| | enumeration | 0114001 | documentation vollständig |
| | enumeration | 0114002 | documentation nein |
| | enumeration | 0114003 | documentation teilweise |
| | enumeration | 0114004 | documentation nicht vorhanden |
| annotation | documentation Kat_BI_EntfernungADMNetz | | |
| source | <pre><simpleType name="enum_0114"> <annotation> <documentation>Kat_BI_EntfernungADMNetz</documentation> </annotation> <restriction base="xs:string"> <enumeration value="0114001"> <annotation> <documentation>vollständig</documentation> </annotation> </enumeration> <enumeration value="0114002"> <annotation> <documentation>nein</documentation> </annotation> </enumeration> <enumeration value="0114003"></pre> | | |

| | |
|--|---|
| | <pre> <annotation> <documentation>teilweise</documentation> </annotation> </enumeration> <enumeration value="0114004"> <annotation> <documentation>nicht vorhanden</documentation> </annotation> </enumeration> </restriction> </simpleType> </pre> |
|--|---|

simpleType enum_0116

| | | | |
|------------|---|---------|--|
| namespace | http://xml.ir-d.de/stn | | |
| type | restriction of string | | |
| properties | base xs:string | | |
| facets | Kind | Value | Annotation |
| | enumeration | 0116001 | documentation Spülung, antibiotisch |
| | enumeration | 0116002 | documentation Spülung, antiseptisch |
| | enumeration | 0116003 | documentation Spülung, wirkstofffrei |
| | enumeration | 0116004 | documentation Spülung, andere |
| | enumeration | 0116005 | documentation prä-/perioperative Antibiotika |
| | enumeration | 0116006 | documentation postoperative Antibiotika |
| | enumeration | 0116007 | documentation Handschuhwechsel vor Implantation |
| | enumeration | 0116008 | documentation Implantationshilfe |
| annotation | documentation Kat_BI_Operationsmassnahme | | |
| source | <pre> <simpleType name="enum_0116"> <annotation> <documentation>Kat_BI_Operationsmassnahme</documentation> </annotation> <restriction base="xs:string"> <enumeration value="0116001"> <annotation> <documentation>Spülung, antibiotisch</documentation> </annotation> </enumeration> <enumeration value="0116002"> <annotation> <documentation>Spülung, antiseptisch</documentation> </annotation> </enumeration> <enumeration value="0116003"> <annotation> <documentation>Spülung, wirkstofffrei</documentation> </annotation> </enumeration> <enumeration value="0116004"> <annotation> </pre> | | |

| | |
|--|---|
| | <pre> <documentation>Spülung, andere</documentation> </annotation> </enumeration> <enumeration value="0116005"> <annotation> <documentation>prä-/perioperative Antibiotika</documentation> </annotation> </enumeration> <enumeration value="0116006"> <annotation> <documentation>postoperative Antibiotika</documentation> </annotation> </enumeration> <enumeration value="0116007"> <annotation> <documentation>Handschuhwechsel vor Implantation</documentation> </annotation> </enumeration> <enumeration value="0116008"> <annotation> <documentation>Implantationshilfe</documentation> </annotation> </enumeration> </restriction> </simpleType> </pre> |
|--|---|

simpleType enum_0118

| | | | |
|------------|--|---------|-----------------------------------|
| namespace | http://xml.ir-d.de/stn | | |
| type | restriction of string | | |
| properties | base xs:string | | |
| facets | Kind | Value | Annotation |
| | enumeration | 0118001 | documentation axillär |
| | enumeration | 0118002 | documentation periareolär |
| | enumeration | 0118003 | documentation inframammär |
| | enumeration | 0118004 | documentation Mastektomienarbe |
| | enumeration | 0118042 | documentation anderer |
| annotation | documentation Kat_BI_Operationszugang | | |
| source | <pre> <simpleType name="enum_0118"> <annotation> <documentation>Kat_BI_Operationszugang</documentation> </annotation> <restriction base="xs:string"> <enumeration value="0118001"> <annotation> <documentation>axillär</documentation> </annotation> </enumeration> <enumeration value="0118002"> <annotation> <documentation>periareolär</documentation> </annotation> </enumeration> </restriction> </simpleType> </pre> | | |

| | |
|--|--|
| | <pre> </annotation> </enumeration> <enumeration value="0118003"> <annotation> <documentation>inframammär</documentation> </annotation> </enumeration> <enumeration value="0118004"> <annotation> <documentation>Mastektomienarbe</documentation> </annotation> </enumeration> <enumeration value="0118042"> <annotation> <documentation>anderer</documentation> </annotation> </enumeration> </restriction> </simpleType> </pre> |
|--|--|

simpleType enum_0120

| | | | |
|------------|--|---------|----------------------------------|
| namespace | http://xml.ir-d.de/stn | | |
| type | restriction of string | | |
| properties | base xs:string | | |
| facets | Kind | Value | Annotation |
| | enumeration | 0120001 | documentation Expander defekt |
| annotation | documentation Kat_BI_BefundAustausch | | |
| source | <pre> <simpleType name="enum_0120"> <annotation> <documentation>Kat_BI_BefundAustausch</documentation> </annotation> <restriction base="xs:string"> <enumeration value="0120001"> <annotation> <documentation>Expander defekt</documentation> </annotation> </enumeration> </restriction> </simpleType> </pre> | | |

simpleType enum_0121

| | | | |
|------------|------------------------------|---------|----------------------------|
| namespace | http://xml.ir-d.de/stn | | |
| type | restriction of string | | |
| properties | base xs:string | | |
| facets | Kind | Value | Annotation |
| | enumeration | 0121001 | documentation Infektion |
| | enumeration | 0121002 | documentation Serom |
| | enumeration | 0121003 | documentation |

| | |
|------------|---|
| | <p>enumeration 0121004 Hämatom documentation</p> <p>enumeration 0121005 Kapselfibrose documentation</p> <p>enumeration 0121006 Implantatruptur documentation</p> <p>enumeration 0121007 Fehlpositionierung/Rotation documentation</p> <p>enumeration 0121008 BIA-ALCL/-SCC, Verdacht documentation</p> <p>enumeration 0121009 BIA-ALCL/-SCC, pathologisch bestätigt documentation</p> <p>enumeration 0121010 Brustschmerzen documentation</p> <p>enumeration 0121011 Doppelkapsel documentation</p> <p>enumeration 0121012 Netz-/ADM-bedingte Komplikation, Non-Integration documentation</p> <p>enumeration 0121013 Netz-/ADM-bedingte Komplikation, andere documentation</p> <p>enumeration 0121014 Hautnekrose/exponiertes Implantat documentation</p> <p>enumeration 0121015 BII/ASIA (Brustimplantat assoziierte Symptome), Verdacht documentation</p> <p>enumeration 0121016 Lymphadenopathie documentation</p> <p>Brustkrebs, neu aufgetreten/Rezidiv</p> |
| annotation | documentation Kat BI BefundKomplett |
| source | <pre> <simpleType name="enum_0121"> <annotation> <documentation>Kat_BI_BefundKomplett</documentation> </annotation> <restriction base="xs:string"> <enumeration value="0121001"> <annotation> <documentation>Infektion</documentation> </annotation> </enumeration> <enumeration value="0121002"> <annotation> <documentation>Serom</documentation> </annotation> </enumeration> <enumeration value="0121003"> <annotation> <documentation>Hämatom</documentation> </annotation> </enumeration> <enumeration value="0121004"> <annotation> <documentation>Kapselfibrose</documentation> </annotation> </enumeration> <enumeration value="0121005"> <annotation> <documentation>Implantatruptur</documentation> </annotation> </enumeration> <enumeration value="0121006"> <annotation> </pre> |

```

    <documentation>Fehlpositionierung/Rotation</documentation>
  </annotation>
</enumeration>
<enumeration value="0121007">
  <annotation>
    <documentation>BIA-ALCL/-SCC, Verdacht</documentation>
  </annotation>
</enumeration>
<enumeration value="0121008">
  <annotation>
    <documentation>BIA-ALCL/-SCC, pathologisch bestätigt</documentation>
  </annotation>
</enumeration>
<enumeration value="0121009">
  <annotation>
    <documentation>Brustschmerzen</documentation>
  </annotation>
</enumeration>
<enumeration value="0121010">
  <annotation>
    <documentation>Doppelkapsel</documentation>
  </annotation>
</enumeration>
<enumeration value="0121011">
  <annotation>
    <documentation>Netz-/ADM-bedingte Komplikation,
Non-Integration</documentation>
  </annotation>
</enumeration>
<enumeration value="0121012">
  <annotation>
    <documentation>Netz-/ADM-bedingte Komplikation, andere</documentation>
  </annotation>
</enumeration>
<enumeration value="0121013">
  <annotation>
    <documentation>Hautnekrose/exponiertes Implantat</documentation>
  </annotation>
</enumeration>
<enumeration value="0121014">
  <annotation>
    <documentation>BII/ASIA (Brustimplantat assoziierte Symptome),
Verdacht</documentation>
  </annotation>
</enumeration>
<enumeration value="0121015">
  <annotation>
    <documentation>Lymphadenopathie</documentation>
  </annotation>
</enumeration>
<enumeration value="0121016">
  <annotation>
    <documentation>Brustkrebs, neu aufgetreten/Rezidiv</documentation>
  </annotation>
</enumeration>
</restriction>
</simpleType>

```

simpleType enum_0122

| | | | |
|------------|---|---------|--|
| namespace | http://xml.ir-d.de/stn | | |
| type | restriction of string | | |
| properties | base xs:string | | |
| facets | Kind | Value | Annotation |
| | enumeration | 0122001 | documentation ja, ärztlich nachgewiesen |
| | enumeration | 0122002 | documentation nein |
| | enumeration | 0122042 | documentation unbekannt |
| annotation | documentation Kat_BI_Autoimmunerkrankung | | |
| source | <pre> <simpleType name="enum_0122"> <annotation> <documentation>Kat_BI_Autoimmunerkrankung</documentation> </annotation> <restriction base="xs:string"> <enumeration value="0122001"> <annotation> <documentation>ja, ärztlich nachgewiesen</documentation> </annotation> </enumeration> <enumeration value="0122002"> <annotation> <documentation>nein</documentation> </annotation> </enumeration> <enumeration value="0122042"> <annotation> <documentation>unbekannt</documentation> </annotation> </enumeration> </restriction> </simpleType> </pre> | | |

simpleType enum_0123

| | | | |
|------------|--|---------|--|
| namespace | http://xml.ir-d.de/stn | | |
| type | restriction of string | | |
| properties | base xs:string | | |
| facets | Kind | Value | Annotation |
| | enumeration | 0123001 | documentation neu aufgetreten |
| | enumeration | 0123002 | documentation verschlechtert |
| | enumeration | 0123003 | documentation keine Veränderung |
| | enumeration | 0123004 | documentation nicht relevant, da Primäreingriff |
| | enumeration | 0123042 | documentation unbekannt |
| annotation | documentation Kat_BI_VerlaufAutoimmunerkrankung | | |

| | |
|--------|--|
| source | <pre> <simpleType name="enum_0123"> <annotation> <documentation>Kat_BI_VerlaufAutoimmunerkrankung</documentation> </annotation> <restriction base="xs:string"> <enumeration value="0123001"> <annotation> <documentation>neu aufgetreten</documentation> </annotation> </enumeration> <enumeration value="0123002"> <annotation> <documentation>verschlechtert</documentation> </annotation> </enumeration> <enumeration value="0123003"> <annotation> <documentation>keine Veränderung</documentation> </annotation> </enumeration> <enumeration value="0123004"> <annotation> <documentation>nicht relevant, da Primäreingriff</documentation> </annotation> </enumeration> <enumeration value="0123042"> <annotation> <documentation>unbekannt</documentation> </annotation> </enumeration> </restriction> </simpleType> </pre> |
|--------|--|

simpleType enum_0124

| | | | |
|------------|--|---------|--|
| namespace | http://xml.ir-d.de/stn | | |
| type | restriction of string | | |
| properties | base xs:string | | |
| facets | Kind | Value | Annotation |
| | enumeration | 0124001 | documentation Salzlösung |
| | enumeration | 0124002 | documentation Silikongel |
| | enumeration | 0124003 | documentation Kombination Silikongel und Salzlösung |
| | enumeration | 0124042 | documentation sonstige |
| annotation | documentation Kat_BI_Fuellung | | |
| source | <pre> <simpleType name="enum_0124"> <annotation> <documentation>Kat_BI_Fuellung</documentation> </annotation> <restriction base="xs:string"> <enumeration value="0124001"> <annotation> <documentation>Salzlösung</documentation> </pre> | | |

| | |
|--|---|
| | <pre> </annotation> </enumeration> <enumeration value="0124002"> <annotation> <documentation>Silikongel</documentation> </annotation> </enumeration> <enumeration value="0124003"> <annotation> <documentation>Kombination Silikongel und Salzlösung</documentation> </annotation> </enumeration> <enumeration value="0124042"> <annotation> <documentation>sonstige</documentation> </annotation> </enumeration> </restriction> </simpleType> </pre> |
|--|---|

simpleType enum 0126

| | | | |
|------------|---|---------|---|
| namespace | http://xml.ir-d.de/stn | | |
| type | restriction of string | | |
| properties | base xs:string | | |
| facets | Kind | Value | Annotation |
| | enumeration | 0126001 | documentation anatomisch (tropfenförmig) |
| | enumeration | 0126002 | documentation rund (punktsymmetrisch) |
| | enumeration | 0126042 | documentation sonstige |
| annotation | documentation Kat_BI_Form | | |
| source | <pre> <simpleType name="enum_0126"> <annotation> <documentation>Kat_BI_Form</documentation> </annotation> <restriction base="xs:string"> <enumeration value="0126001"> <annotation> <documentation>anatomisch (tropfenförmig)</documentation> </annotation> </enumeration> <enumeration value="0126002"> <annotation> <documentation>rund (punktsymmetrisch)</documentation> </annotation> </enumeration> <enumeration value="0126042"> <annotation> <documentation>sonstige</documentation> </annotation> </enumeration> </restriction> </simpleType> </pre> | | |

simpleType enum_0128

| | | | |
|------------|---|---------|------------------------------|
| namespace | http://xml.ir-d.de/stn | | |
| type | restriction of string | | |
| properties | base xs:string | | |
| facets | Kind | Value | Annotation |
| | enumeration | 0128001 | documentation glattwandig |
| | enumeration | 0128002 | documentation beschichtet |
| | enumeration | 0128003 | documentation texturiert |
| annotation | documentation Kat_BI_Oberflaeche | | |
| source | <pre> <simpleType name="enum_0128"> <annotation> <documentation>Kat_BI_Oberflaeche</documentation> </annotation> <restriction base="xs:string"> <enumeration value="0128001"> <annotation> <documentation>glattwandig</documentation> </annotation> </enumeration> <enumeration value="0128002"> <annotation> <documentation>beschichtet</documentation> </annotation> </enumeration> <enumeration value="0128003"> <annotation> <documentation>texturiert</documentation> </annotation> </enumeration> </restriction> </simpleType> </pre> | | |

simpleType enum_0130

| | | | |
|------------|------------------------------|---------|--|
| namespace | http://xml.ir-d.de/stn | | |
| type | restriction of string | | |
| properties | base xs:string | | |
| facets | Kind | Value | Annotation |
| | enumeration | 0130001 | documentation Allergan |
| | enumeration | 0130002 | documentation Cereplas |
| | enumeration | 0130003 | documentation CUI (Cox Uphoff Implants) |
| | enumeration | 0130004 | documentation EMSI Biomedical |
| | enumeration | 0130005 | documentation Establishment labs |
| | enumeration | 0130006 | documentation Eurosilicone |

| | |
|------------|--|
| | <p>enumeration 0130007 documentation Nagor</p> <p>enumeration 0130008 documentation Groupe Sebbin</p> <p>enumeration 0130009 documentation Laboratoires Arion</p> <p>enumeration 0130010 documentation Mentor</p> <p>enumeration 0130011 documentation Pérouse Plastie SAS</p> <p>enumeration 0130012 documentation PIP M-Implants</p> <p>enumeration 0130013 documentation Polytech Health & Aesthetics</p> <p>enumeration 0130014 documentation Silimed</p> <p>enumeration 0130015 documentation Surgitek</p> <p>enumeration 0130016 documentation G&G Biotechnology</p> <p>enumeration 0130017 documentation nicht belegter Wert</p> <p>enumeration 0130018 documentation nicht belegter Wert</p> <p>enumeration 0130019 documentation nicht belegter Wert</p> <p>enumeration 0130020 documentation nicht belegter Wert</p> <p>enumeration 0130021 documentation nicht belegter Wert</p> <p>enumeration 0130042 documentation sonstiger</p> |
| annotation | documentation Kat_BI_Hersteller |
| source | <pre> <simpleType name="enum_0130"> <annotation> <documentation>Kat_BI_Hersteller</documentation> </annotation> <restriction base="xs:string"> <enumeration value="0130001"> <annotation> <documentation>Allergan</documentation> </annotation> </enumeration> <enumeration value="0130002"> <annotation> <documentation>Cereplas</documentation> </annotation> </enumeration> <enumeration value="0130003"> <annotation> <documentation>CUI (Cox Uphoff Implants)</documentation> </annotation> </enumeration> <enumeration value="0130004"> <annotation> <documentation>EMSI Biomedical</documentation> </annotation> </enumeration> <enumeration value="0130005"> <annotation> <documentation>Establishment labs</documentation> </annotation> </enumeration> </restriction> </simpleType> </pre> |

```
</annotation>
</enumeration>
<enumeration value="0130006">
  <annotation>
    <documentation>Eurosilicone</documentation>
  </annotation>
</enumeration>
<enumeration value="0130007">
  <annotation>
    <documentation>Nagor</documentation>
  </annotation>
</enumeration>
<enumeration value="0130008">
  <annotation>
    <documentation>Groupe Sebbin</documentation>
  </annotation>
</enumeration>
<enumeration value="0130009">
  <annotation>
    <documentation>Laboratoires Arion</documentation>
  </annotation>
</enumeration>
<enumeration value="0130010">
  <annotation>
    <documentation>Mentor</documentation>
  </annotation>
</enumeration>
<enumeration value="0130011">
  <annotation>
    <documentation>Pérouse Plastie SAS</documentation>
  </annotation>
</enumeration>
<enumeration value="0130012">
  <annotation>
    <documentation>PIP M-Implants</documentation>
  </annotation>
</enumeration>
<enumeration value="0130013">
  <annotation>
    <documentation>Polytech Health & Aesthetics</documentation>
  </annotation>
</enumeration>
<enumeration value="0130014">
  <annotation>
    <documentation>Silimed</documentation>
  </annotation>
</enumeration>
<enumeration value="0130015">
  <annotation>
    <documentation>Surgitek</documentation>
  </annotation>
</enumeration>
<enumeration value="0130016">
  <annotation>
    <documentation>G&G Biotechnology</documentation>
  </annotation>
</enumeration>
<enumeration value="0130017">
  <annotation>
```

```

    <documentation>nicht belegter Wert</documentation>
  </annotation>
</enumeration>
<enumeration value="0130018">
  <annotation>
    <documentation>nicht belegter Wert</documentation>
  </annotation>
</enumeration>
<enumeration value="0130019">
  <annotation>
    <documentation>nicht belegter Wert</documentation>
  </annotation>
</enumeration>
<enumeration value="0130020">
  <annotation>
    <documentation>nicht belegter Wert</documentation>
  </annotation>
</enumeration>
<enumeration value="0130021">
  <annotation>
    <documentation>nicht belegter Wert</documentation>
  </annotation>
</enumeration>
<enumeration value="0130042">
  <annotation>
    <documentation>sonstiger</documentation>
  </annotation>
</enumeration>
</restriction>
</simpleType>

```

simpleType enum_0131

| | | | |
|------------|------------------------------|---------|---|
| namespace | http://xml.ir-d.de/stn | | |
| type | restriction of string | | |
| properties | base xs:string | | |
| facets | Kind | Value | Annotation |
| | enumeration | 0131001 | documentation Allergan |
| | enumeration | 0131002 | documentation Establishment labs |
| | enumeration | 0131003 | documentation Eurosilicone |
| | enumeration | 0131004 | documentation Galatea |
| | enumeration | 0131005 | documentation Integra |
| | enumeration | 0131006 | documentation Lifecell |
| | enumeration | 0131007 | documentation MBP (Medical Biomaterial Products) |
| | enumeration | 0131008 | documentation Mentor |
| | enumeration | 0131009 | documentation Novus Scientific |
| | enumeration | 0131042 | documentation sonstiger |
| annotation | documentation | | |

Kat_BI_ZubehoerHersteller

source

```
<simpleType name="enum_0131">
  <annotation>
    <documentation>Kat_BI_ZubehoerHersteller</documentation>
  </annotation>
  <restriction base="xs:string">
    <enumeration value="0131001">
      <annotation>
        <documentation>Allergan</documentation>
      </annotation>
    </enumeration>
    <enumeration value="0131002">
      <annotation>
        <documentation>Establishment labs</documentation>
      </annotation>
    </enumeration>
    <enumeration value="0131003">
      <annotation>
        <documentation>Eurosilicone</documentation>
      </annotation>
    </enumeration>
    <enumeration value="0131004">
      <annotation>
        <documentation>Galatea</documentation>
      </annotation>
    </enumeration>
    <enumeration value="0131005">
      <annotation>
        <documentation>Integra</documentation>
      </annotation>
    </enumeration>
    <enumeration value="0131006">
      <annotation>
        <documentation>Lifecell</documentation>
      </annotation>
    </enumeration>
    <enumeration value="0131007">
      <annotation>
        <documentation>MBP (Medical Biomaterial Products)</documentation>
      </annotation>
    </enumeration>
    <enumeration value="0131008">
      <annotation>
        <documentation>Mentor</documentation>
      </annotation>
    </enumeration>
    <enumeration value="0131009">
      <annotation>
        <documentation>Novus Scientific</documentation>
      </annotation>
    </enumeration>
    <enumeration value="0131042">
      <annotation>
        <documentation>sonstiger</documentation>
      </annotation>
    </enumeration>
  </restriction>
</simpleType>
```

simpleType enum_0190

| | | | |
|------------|---|---------|---------------------------------|
| namespace | http://xml.ir-d.de/stn | | |
| type | restriction of string | | |
| properties | base xs:string | | |
| facets | Kind | Value | Annotation |
| | enumeration | 0190001 | documentation Brustimplantat |
| | enumeration | 0190003 | documentation Brustexpander |
| annotation | documentation Kat_BI_Artikeltyp | | |
| source | <pre> <simpleType name="enum_0190"> <annotation> <documentation>Kat_BI_Artikeltyp</documentation> </annotation> <restriction base="xs:string"> <enumeration value="0190001"> <annotation> <documentation>Brustimplantat</documentation> </annotation> </enumeration> <enumeration value="0190003"> <annotation> <documentation>Brustexpander</documentation> </annotation> </enumeration> </restriction> </simpleType> </pre> | | |

simpleType enum_0191

| | | | |
|------------|--|---------|-----------------------|
| namespace | http://xml.ir-d.de/stn | | |
| type | restriction of string | | |
| properties | base xs:string | | |
| facets | Kind | Value | Annotation |
| | enumeration | 0191001 | documentation Netz |
| | enumeration | 0191002 | documentation ADM |
| annotation | documentation Kat_BI_ZubehoerTyp | | |
| source | <pre> <simpleType name="enum_0191"> <annotation> <documentation>Kat_BI_ZubehoerTyp</documentation> </annotation> <restriction base="xs:string"> <enumeration value="0191001"> <annotation> <documentation>Netz</documentation> </annotation> </enumeration> <enumeration value="0191002"> </pre> | | |

| | |
|--|--|
| | <pre> <annotation> <documentation>ADM</documentation> </annotation> </enumeration> </restriction> </simpleType> </pre> |
|--|--|

simpleType enum_0200

| | | | |
|------------|---|---------|--------------------------------|
| namespace | http://xml.ir-d.de/stn | | |
| type | restriction of string | | |
| properties | base xs:string | | |
| facets | Kind | Value | Annotation |
| | enumeration | 0200001 | documentation Erst-OP |
| | enumeration | 0200002 | documentation Folgeeingriff |
| annotation | documentation Kat_EP_ArtEingriff | | |
| source | <pre> <simpleType name="enum_0200"> <annotation> <documentation>Kat_EP_ArtEingriff</documentation> </annotation> <restriction base="xs:string"> <enumeration value="0200001"> <annotation> <documentation>Erst-OP</documentation> </annotation> </enumeration> <enumeration value="0200002"> <annotation> <documentation>Folgeeingriff</documentation> </annotation> </enumeration> </restriction> </simpleType> </pre> | | |

simpleType enum_0202

| | | | |
|------------|------------------------------|---------|--|
| namespace | http://xml.ir-d.de/stn | | |
| type | restriction of string | | |
| properties | base xs:string | | |
| facets | Kind | Value | Annotation |
| | enumeration | 0202001 | documentation Lockerung |
| | enumeration | 0202002 | documentation Infektion, Verdacht auf |
| | enumeration | 0202003 | documentation Infektion, gesichert |
| | enumeration | 0202004 | documentation Luxation, Inlay aus der Pfanne |
| | enumeration | 0202005 | documentation Luxation, Kopf aus Pfanne/Inlay |
| | enumeration | 0202006 | documentation Periprothetische Fraktur |

| | |
|------------|---|
| | <p>enumeration 0202007 documentation Verschleiß des PE-Inlays</p> <p>enumeration 0202008 documentation Implantatbruch</p> <p>enumeration 0202009 documentation Implantatfehlage/Malalignement</p> <p>enumeration 0202010 documentation Osteolysen bei festem Implantat</p> <p>enumeration 0202011 documentation Progression der Grunderkrankung</p> <p>enumeration 0202012 documentation ARM-D</p> <p>enumeration 0202013 documentation Verdacht auf allergische Reaktion</p> <p>enumeration 0202021 documentation Zustand nach Prothesenentfernung</p> <p>enumeration 0202042 documentation andere Gründe</p> |
| annotation | documentation Kat_EP_GrundWechselHuefte |
| source | <pre> <simpleType name="enum_0202"> <annotation> <documentation>Kat_EP_GrundWechselHuefte</documentation> </annotation> <restriction base="xs:string"> <enumeration value="0202001"> <annotation> <documentation>Lockerung</documentation> </annotation> </enumeration> <enumeration value="0202002"> <annotation> <documentation>Infektion, Verdacht auf</documentation> </annotation> </enumeration> <enumeration value="0202003"> <annotation> <documentation>Infektion, gesichert</documentation> </annotation> </enumeration> <enumeration value="0202004"> <annotation> <documentation>Luxation, Inlay aus der Pfanne</documentation> </annotation> </enumeration> <enumeration value="0202005"> <annotation> <documentation>Luxation, Kopf aus Pfanne/Inlay</documentation> </annotation> </enumeration> <enumeration value="0202006"> <annotation> <documentation>Periprothetische Fraktur</documentation> </annotation> </enumeration> <enumeration value="0202007"> <annotation> <documentation>Verschleiß des PE-Inlays</documentation> </annotation> </enumeration> </restriction> </simpleType> </pre> |

```

<enumeration value="0202008">
  <annotation>
    <documentation>Implantatbruch</documentation>
  </annotation>
</enumeration>
<enumeration value="0202009">
  <annotation>
    <documentation>Implantatfehllage/Malalignent</documentation>
  </annotation>
</enumeration>
<enumeration value="0202010">
  <annotation>
    <documentation>Osteolysen bei festem Implantat</documentation>
  </annotation>
</enumeration>
<enumeration value="0202011">
  <annotation>
    <documentation>Progression der Grunderkrankung</documentation>
  </annotation>
</enumeration>
<enumeration value="0202012">
  <annotation>
    <documentation>ARMD</documentation>
  </annotation>
</enumeration>
<enumeration value="0202013">
  <annotation>
    <documentation>Verdacht auf allergische Reaktion</documentation>
  </annotation>
</enumeration>
<enumeration value="0202021">
  <annotation>
    <documentation>Zustand nach Prothesenentfernung</documentation>
  </annotation>
</enumeration>
<enumeration value="0202042">
  <annotation>
    <documentation>andere Gründe</documentation>
  </annotation>
</enumeration>
</restriction>
</simpleType>

```

simpleType enum_0204

| | | | |
|------------|------------------------------|---------|---|
| namespace | http://xml.ir-d.de/stn | | |
| type | restriction of string | | |
| properties | base xs:string | | |
| facets | Kind | Value | Annotation |
| | enumeration | 0204001 | documentation Lockerung |
| | enumeration | 0204002 | documentation Infektion, Verdacht auf |
| | enumeration | 0204003 | documentation Infektion, gesichert |
| | enumeration | 0204006 | documentation Periprothetische Fraktur |

| | |
|------------|--|
| | <p>enumeration 0204007 documentation Verschleiß</p> <p>enumeration 0204008 documentation Implantatbruch</p> <p>enumeration 0204009 documentation Implantatfehlage/Malalignement</p> <p>enumeration 0204010 documentation Osteolysen bei festem Implantat</p> <p>enumeration 0204011 documentation Progression der Grunderkrankung</p> <p>enumeration 0204012 documentation ARM-D</p> <p>enumeration 0204013 documentation Verdacht auf allergische Reaktion</p> <p>enumeration 0204014 documentation Dislokation/Migration von Komponenten</p> <p>enumeration 0204015 documentation Bandinstabilität</p> <p>enumeration 0204016 documentation Bewegungseinschränkung</p> <p>enumeration 0204021 documentation Zustand nach Prothesenentfernung</p> <p>enumeration 0204042 documentation andere Gründe</p> |
| annotation | documentation Kat_EP_GrundWechselKnie |
| source | <pre> <simpleType name="enum_0204"> <annotation> <documentation>Kat_EP_GrundWechselKnie</documentation> </annotation> <restriction base="xs:string"> <enumeration value="0204001"> <annotation> <documentation>Lockerung</documentation> </annotation> </enumeration> <enumeration value="0204002"> <annotation> <documentation>Infektion, Verdacht auf</documentation> </annotation> </enumeration> <enumeration value="0204003"> <annotation> <documentation>Infektion, gesichert</documentation> </annotation> </enumeration> <enumeration value="0204006"> <annotation> <documentation>Periprothetische Fraktur</documentation> </annotation> </enumeration> <enumeration value="0204007"> <annotation> <documentation>Verschleiß</documentation> </annotation> </enumeration> <enumeration value="0204008"> <annotation> <documentation>Implantatbruch</documentation> </annotation> </enumeration> </restriction> </simpleType> </pre> |

```

<enumeration value="0204009">
  <annotation>
    <documentation>Implantatfehllage/Malalignent</documentation>
  </annotation>
</enumeration>
<enumeration value="0204010">
  <annotation>
    <documentation>Osteolysen bei festem Implantat</documentation>
  </annotation>
</enumeration>
<enumeration value="0204011">
  <annotation>
    <documentation>Progression der Grunderkrankung</documentation>
  </annotation>
</enumeration>
<enumeration value="0204012">
  <annotation>
    <documentation>ARMD</documentation>
  </annotation>
</enumeration>
<enumeration value="0204013">
  <annotation>
    <documentation>Verdacht auf allergische Reaktion</documentation>
  </annotation>
</enumeration>
<enumeration value="0204014">
  <annotation>
    <documentation>Dislokation/Migration von Komponenten</documentation>
  </annotation>
</enumeration>
<enumeration value="0204015">
  <annotation>
    <documentation>Bandinstabilität</documentation>
  </annotation>
</enumeration>
<enumeration value="0204016">
  <annotation>
    <documentation>Bewegungseinschränkung</documentation>
  </annotation>
</enumeration>
<enumeration value="0204021">
  <annotation>
    <documentation>Zustand nach Prothesenentfernung</documentation>
  </annotation>
</enumeration>
<enumeration value="0204042">
  <annotation>
    <documentation>andere Gründe</documentation>
  </annotation>
</enumeration>
</restriction>
</simpleType>

```

simpleType **enum_0206**

| | |
|-----------|------------------------------|
| namespace | http://xml.ir-d.de/stn |
| type | restriction of string |

| | | | |
|------------|---|-----------|--|
| properties | base | xs:string | |
| facets | Kind | Value | Annotation |
| | enumeration | 0206001 | documentation Lockerung |
| | enumeration | 0206002 | documentation Infektion, Verdacht auf |
| | enumeration | 0206003 | documentation Infektion, gesichert |
| | enumeration | 0206004 | documentation Luxation, Inlay aus der Pfanne |
| | enumeration | 0206005 | documentation Luxation, Kopf aus Pfanne/Inlay |
| | enumeration | 0206006 | documentation Periprothetische Fraktur |
| | enumeration | 0206007 | documentation Verschleiß |
| | enumeration | 0206008 | documentation Implantatbruch |
| | enumeration | 0206009 | documentation Implantatfehlage/Malalignement |
| | enumeration | 0206010 | documentation Osteolysen bei festem Implantat |
| | enumeration | 0206011 | documentation Progression der Grunderkrankung |
| | enumeration | 0206012 | documentation ARM-D |
| | enumeration | 0206013 | documentation Verdacht auf allergische Reaktion |
| | enumeration | 0206014 | documentation Dislokation/Migration von Komponenten |
| | enumeration | 0206015 | documentation Bandinstabilität |
| | enumeration | 0206016 | documentation Bewegungseinschränkung |
| | enumeration | 0206021 | documentation Zustand nach Prothesenentfernung |
| | enumeration | 0206042 | documentation andere Gründe |
| annotation | documentation | | Kat_EP_GrundWechselTFE |
| source | <pre> <simpleType name="enum_0206"> <annotation> <documentation>Kat_EP_GrundWechselTFE</documentation> </annotation> <restriction base="xs:string"> <enumeration value="0206001"> <annotation> <documentation>Lockerung</documentation> </annotation> </enumeration> <enumeration value="0206002"> <annotation> <documentation>Infektion, Verdacht auf</documentation> </annotation> </enumeration> <enumeration value="0206003"> <annotation> <documentation>Infektion, gesichert</documentation> </annotation> </enumeration> <enumeration value="0206004"> <annotation> </pre> | | |

```
<documentation>Luxation, Inlay aus der Pfanne</documentation>
</annotation>
</enumeration>
<enumeration value="0206005">
  <annotation>
    <documentation>Luxation, Kopf aus Pfanne/Inlay</documentation>
  </annotation>
</enumeration>
<enumeration value="0206006">
  <annotation>
    <documentation>Periprothetische Fraktur</documentation>
  </annotation>
</enumeration>
<enumeration value="0206007">
  <annotation>
    <documentation>Verschleiß</documentation>
  </annotation>
</enumeration>
<enumeration value="0206008">
  <annotation>
    <documentation>Implantatbruch</documentation>
  </annotation>
</enumeration>
<enumeration value="0206009">
  <annotation>
    <documentation>Implantatfehlage/Malalignent</documentation>
  </annotation>
</enumeration>
<enumeration value="0206010">
  <annotation>
    <documentation>Osteolysen bei festem Implantat</documentation>
  </annotation>
</enumeration>
<enumeration value="0206011">
  <annotation>
    <documentation>Progression der Grunderkrankung</documentation>
  </annotation>
</enumeration>
<enumeration value="0206012">
  <annotation>
    <documentation>ARMD</documentation>
  </annotation>
</enumeration>
<enumeration value="0206013">
  <annotation>
    <documentation>Verdacht auf allergische Reaktion</documentation>
  </annotation>
</enumeration>
<enumeration value="0206014">
  <annotation>
    <documentation>Dislokation/Migration von Komponenten</documentation>
  </annotation>
</enumeration>
<enumeration value="0206015">
  <annotation>
    <documentation>Bandinstabilität</documentation>
  </annotation>
</enumeration>
<enumeration value="0206016">
```

| | |
|--|--|
| | <pre> <annotation> <documentation>Bewegungseinschränkung</documentation> </annotation> </enumeration> <enumeration value="0206021"> <annotation> <documentation>Zustand nach Prothesenentfernung</documentation> </annotation> </enumeration> <enumeration value="0206042"> <annotation> <documentation>andere Gründe</documentation> </annotation> </enumeration> </restriction> </simpleType> </pre> |
|--|--|

simpleType enum_0210

| | | | |
|------------|---|---------|--|
| namespace | http://xml.ir-d.de/stn | | |
| type | restriction of string | | |
| properties | base xs:string | | |
| facets | Kind | Value | Annotation |
| | enumeration | 0210001 | documentation keine relevante Voroperation |
| | enumeration | 0210002 | documentation Osteosynthese/Osteotomie (Becken) |
| | enumeration | 0210003 | documentation Osteosynthese/Osteotomie (Femur) |
| | enumeration | 0210004 | documentation Osteosynthese/Osteotomie (beides) |
| | enumeration | 0210005 | documentation Operation bei Hüftkopfnekrose |
| | enumeration | 0210006 | documentation Arthrodese |
| | enumeration | 0210042 | documentation andere |
| annotation | documentation Kat_EP_VoroperationHuefte | | |
| source | <pre> <simpleType name="enum_0210"> <annotation> <documentation>Kat_EP_VoroperationHuefte</documentation> </annotation> <restriction base="xs:string"> <enumeration value="0210001"> <annotation> <documentation>keine relevante Voroperation</documentation> </annotation> </enumeration> <enumeration value="0210002"> <annotation> <documentation>Osteosynthese/Osteotomie (Becken)</documentation> </annotation> </enumeration> <enumeration value="0210003"> <annotation> <documentation>Osteosynthese/Osteotomie (Femur)</documentation> </annotation> </enumeration> </restriction> </simpleType> </pre> | | |

| | |
|--|--|
| | <pre> </annotation> </enumeration> <enumeration value="0210004"> <annotation> <documentation>Osteosynthese/Osteotomie (beides)</documentation> </annotation> </enumeration> <enumeration value="0210005"> <annotation> <documentation>Operation bei Hüftkopfnekrose</documentation> </annotation> </enumeration> <enumeration value="0210006"> <annotation> <documentation>Arthrodese</documentation> </annotation> </enumeration> <enumeration value="0210042"> <annotation> <documentation>andere</documentation> </annotation> </enumeration> </restriction> </simpleType> </pre> |
|--|--|

simpleType enum_0211

| | | | |
|------------|--|---------|---|
| namespace | http://xml.ir-d.de/stn | | |
| type | restriction of string | | |
| properties | base xs:string | | |
| facets | Kind | Value | Annotation |
| | enumeration | 0211001 | documentation keine relevante Voroperation |
| | enumeration | 0211002 | documentation Osteosynthese/Osteotomie (Femur) |
| | enumeration | 0211003 | documentation Osteosynthese/Osteotomie (Tibia) |
| | enumeration | 0211004 | documentation Osteosynthese/Osteotomie (Patella) |
| | enumeration | 0211005 | documentation Osteosynthese/Osteotomie (mehrere) |
| | enumeration | 0211006 | documentation Kapsel-/Bandapparat |
| | enumeration | 0211007 | documentation Arthrodese |
| | enumeration | 0211042 | documentation andere |
| annotation | documentation Kat_EP_VoroperationKnie | | |
| source | <pre> <simpleType name="enum_0211"> <annotation> <documentation>Kat_EP_VoroperationKnie</documentation> </annotation> <restriction base="xs:string"> <enumeration value="0211001"> <annotation> <documentation>keine relevante Voroperation</documentation> </annotation> </pre> | | |

```

</enumeration>
<enumeration value="0211002">
  <annotation>
    <documentation>Osteosynthese/Osteotomie (Femur)</documentation>
  </annotation>
</enumeration>
<enumeration value="0211003">
  <annotation>
    <documentation>Osteosynthese/Osteotomie (Tibia)</documentation>
  </annotation>
</enumeration>
<enumeration value="0211004">
  <annotation>
    <documentation>Osteosynthese/Osteotomie (Patella)</documentation>
  </annotation>
</enumeration>
<enumeration value="0211005">
  <annotation>
    <documentation>Osteosynthese/Osteotomie (mehrere)</documentation>
  </annotation>
</enumeration>
<enumeration value="0211006">
  <annotation>
    <documentation>Kapsel-/Bandapparat</documentation>
  </annotation>
</enumeration>
<enumeration value="0211007">
  <annotation>
    <documentation>Arthrodesse</documentation>
  </annotation>
</enumeration>
<enumeration value="0211042">
  <annotation>
    <documentation>andere</documentation>
  </annotation>
</enumeration>
</restriction>
</simpleType>

```

simpleType **enum_0212**

| | | | |
|------------|---|---------|--|
| namespace | http://xml.ir-d.de/stn | | |
| type | restriction of string | | |
| properties | base xs:string | | |
| facets | Kind | Value | Annotation |
| | enumeration | 0212001 | documentation Hüfte |
| | enumeration | 0212002 | documentation Knie |
| | enumeration | 0212003 | documentation Totaler Femurersatz inkl. Durchsteck-Prothese |
| annotation | documentation Kat_EP_Gelenk | | |
| source | <simpleType name="enum_0212"> <annotation> <documentation>Kat_EP_Gelenk</documentation> </annotation> | | |

| | |
|--|--|
| | <pre> <restriction base="xs:string"> <enumeration value="0212001"> <annotation> <documentation>Hüfte</documentation> </annotation> </enumeration> <enumeration value="0212002"> <annotation> <documentation>Knie</documentation> </annotation> </enumeration> <enumeration value="0212003"> <annotation> <documentation>Totaler Femurersatz inkl. Durchsteck-Prothese</documentation> </annotation> </enumeration> </restriction> </simpleType> </pre> |
|--|--|

simpleType enum 0220

| | | | |
|------------|--|---------|--------------------------------------|
| namespace | http://xml.ir-d.de/stn | | |
| type | restriction of string | | |
| properties | base xs:string | | |
| facets | Kind | Value | Annotation |
| | enumeration | 0220001 | documentation anterior |
| | enumeration | 0220002 | documentation anterolateral |
| | enumeration | 0220003 | documentation lateral |
| | enumeration | 0220004 | documentation posterior |
| | enumeration | 0220005 | documentation posterolateral |
| | enumeration | 0220006 | documentation 2-Inzisionen-Zugang |
| | enumeration | 0220042 | documentation sonstiges/unbekannt |
| annotation | documentation Kat_EP_Operationszugang | | |
| source | <pre> <simpleType name="enum_0220"> <annotation> <documentation>Kat_EP_Operationszugang</documentation> </annotation> <restriction base="xs:string"> <enumeration value="0220001"> <annotation> <documentation>anterior</documentation> </annotation> </enumeration> <enumeration value="0220002"> <annotation> <documentation>anterolateral</documentation> </annotation> </enumeration> </pre> | | |

| | |
|--|---|
| | <pre> <enumeration value="0220003"> <annotation> <documentation>lateral</documentation> </annotation> </enumeration> <enumeration value="0220004"> <annotation> <documentation>posterior</documentation> </annotation> </enumeration> <enumeration value="0220005"> <annotation> <documentation>posterolateral</documentation> </annotation> </enumeration> <enumeration value="0220006"> <annotation> <documentation>2-Inzisionen-Zugang</documentation> </annotation> </enumeration> <enumeration value="0220042"> <annotation> <documentation>sonstiges/unbekannt</documentation> </annotation> </enumeration> </restriction> </simpleType> </pre> |
|--|---|

simpleType enum_0222

| | | | |
|------------|---|---------|-----------------------------|
| namespace | http://xml.ir-d.de/strn | | |
| type | restriction of string | | |
| properties | base xs:string | | |
| facets | Kind | Value | Annotation |
| | enumeration | 0222001 | documentation nein |
| | enumeration | 0222002 | documentation ja- Ausbau |
| | enumeration | 0222003 | documentation ja- Einbau |
| annotation | documentation Kat_EP_Zweizeitwechsel | | |
| source | <pre> <simpleType name="enum_0222"> <annotation> <documentation>Kat_EP_Zweizeitwechsel</documentation> </annotation> <restriction base="xs:string"> <enumeration value="0222001"> <annotation> <documentation>nein</documentation> </annotation> </enumeration> <enumeration value="0222002"> <annotation> <documentation>ja- Ausbau</documentation> </annotation> </enumeration> </restriction> </simpleType> </pre> | | |

```

<enumeration value="0222003">
  <annotation>
    <documentation>ja- Einbau</documentation>
  </annotation>
</enumeration>
</restriction>
</simpleType>

```

simpleType enum_0230

| | | | |
|------------|------------------------------|---------|---|
| namespace | http://xml.ir-d.de/stn | | |
| type | restriction of string | | |
| properties | base xs:string | | |
| facets | Kind | Value | Annotation |
| | enumeration | 0230001 | documentation Smith & Nephew GmbH |
| | enumeration | 0230002 | documentation Mathys Orthopädie GmbH |
| | enumeration | 0230003 | documentation Ceramtec AG |
| | enumeration | 0230004 | documentation Biomet |
| | enumeration | 0230005 | documentation Peter Brehm GmbH |
| | enumeration | 0230006 | documentation Amplitude GmbH |
| | enumeration | 0230007 | documentation Exactech Deutschland |
| | enumeration | 0230008 | documentation Globus Medical |
| | enumeration | 0230009 | documentation Implantcast GmbH |
| | enumeration | 0230010 | documentation DePuy Orthopädie GmbH |
| | enumeration | 0230011 | documentation IO-International Orthopaedics |
| | enumeration | 0230012 | documentation Joint Replacement Ltd. Instrumentation |
| | enumeration | 0230013 | documentation Merete |
| | enumeration | 0230014 | documentation S&G Implants GmbH |
| | enumeration | 0230015 | documentation Speetec Implantate GmbH |
| | enumeration | 0230016 | documentation Stemcup Medical Products GmbH |
| | enumeration | 0230017 | documentation Symbios Deutschland GmbH |
| | enumeration | 0230018 | documentation Tantum AG |
| | enumeration | 0230019 | documentation Tornier GmbH |
| | enumeration | 0230020 | documentation MicroPort Orthopedics GmbH |
| | enumeration | 0230021 | documentation aap Implanate AG |
| | enumeration | 0230022 | documentation AQImplants |
| | enumeration | 0230023 | documentation ESKA Orthodynamics GmbH |
| | enumeration | 0230024 | documentation |

| | |
|------------|---|
| | <p>enumeration 0230025 Atesos medical AG documentation Chiropro GmbH</p> <p>enumeration 0230026 documentation Medacta</p> <p>enumeration 0230027 documentation OHST Medizintechnik AG</p> <p>enumeration 0230028 documentation Lima Deutschland GmbH</p> <p>enumeration 0230029 documentation alloPlus GmbH</p> <p>enumeration 0230030 documentation Heraeus Medical GmbH</p> <p>enumeration 0230031 documentation ImplanTec Deutschland GmbH</p> <p>enumeration 0230032 documentation Falcon Medical GmbH</p> <p>enumeration 0230033 documentation Meril GmbH</p> <p>enumeration 0230034 documentation Zimmer Germany GmbH</p> <p>enumeration 0230035 documentation Stryker GmbH & Co. KG</p> <p>enumeration 0230036 documentation Aesculap AG</p> <p>enumeration 0230037 documentation Waldemar Link GmbH & Co. KG</p> <p>enumeration 0230038 documentation Corin Germany GmbH</p> <p>enumeration 0230039 documentation nicht belegter Wert</p> <p>enumeration 0230040 documentation nicht belegter Wert</p> <p>enumeration 0230041 documentation nicht belegter Wert</p> <p>enumeration 0230042 documentation sonstige</p> <p>enumeration 0230043 documentation nicht belegter Wert</p> <p>enumeration 0230044 documentation nicht belegter Wert</p> |
| annotation | documentation Kat_EP_Hersteller |
| source | <pre> <simpleType name="enum_0230"> <annotation> <documentation>Kat_EP_Hersteller</documentation> </annotation> <restriction base="xs:string"> <enumeration value="0230001"> <annotation> <documentation>Smith & Nephew GmbH</documentation> </annotation> </enumeration> <enumeration value="0230002"> <annotation> <documentation>Mathys Orthopädie GmbH</documentation> </annotation> </enumeration> <enumeration value="0230003"> <annotation> <documentation>Ceramtec AG</documentation> </annotation> </enumeration> </restriction> </simpleType> </pre> |

```
<enumeration value="0230004">
  <annotation>
    <documentation>Biomet</documentation>
  </annotation>
</enumeration>
<enumeration value="0230005">
  <annotation>
    <documentation>Peter Brehm GmbH</documentation>
  </annotation>
</enumeration>
<enumeration value="0230006">
  <annotation>
    <documentation>Amplitude GmbH</documentation>
  </annotation>
</enumeration>
<enumeration value="0230007">
  <annotation>
    <documentation>Exactech Deutschland</documentation>
  </annotation>
</enumeration>
<enumeration value="0230008">
  <annotation>
    <documentation>Globus Medical</documentation>
  </annotation>
</enumeration>
<enumeration value="0230009">
  <annotation>
    <documentation>Implantcast GmbH</documentation>
  </annotation>
</enumeration>
<enumeration value="0230010">
  <annotation>
    <documentation>DePuy Orthopädie GmbH</documentation>
  </annotation>
</enumeration>
<enumeration value="0230011">
  <annotation>
    <documentation>IO-International Orthopaedics</documentation>
  </annotation>
</enumeration>
<enumeration value="0230012">
  <annotation>
    <documentation>Joint Replacement Ltd. Instrumentation</documentation>
  </annotation>
</enumeration>
<enumeration value="0230013">
  <annotation>
    <documentation>Merete</documentation>
  </annotation>
</enumeration>
<enumeration value="0230014">
  <annotation>
    <documentation>S&G Implants GmbH</documentation>
  </annotation>
</enumeration>
<enumeration value="0230015">
  <annotation>
    <documentation>Speetec Implantate GmbH</documentation>
  </annotation>
</enumeration>
```



```
</enumeration>
<enumeration value="0230016">
  <annotation>
    <documentation>Stemcup Medical Products GmbH</documentation>
  </annotation>
</enumeration>
<enumeration value="0230017">
  <annotation>
    <documentation>Symbios Deutschland GmbH</documentation>
  </annotation>
</enumeration>
<enumeration value="0230018">
  <annotation>
    <documentation>Tantum AG</documentation>
  </annotation>
</enumeration>
<enumeration value="0230019">
  <annotation>
    <documentation>Tornier GmbH</documentation>
  </annotation>
</enumeration>
<enumeration value="0230020">
  <annotation>
    <documentation>MicroPort Orthopedics GmbH</documentation>
  </annotation>
</enumeration>
<enumeration value="0230021">
  <annotation>
    <documentation>aap Implanate AG</documentation>
  </annotation>
</enumeration>
<enumeration value="0230022">
  <annotation>
    <documentation>AQImplants</documentation>
  </annotation>
</enumeration>
<enumeration value="0230023">
  <annotation>
    <documentation>ESKA Orthodynamics GmbH</documentation>
  </annotation>
</enumeration>
<enumeration value="0230024">
  <annotation>
    <documentation>Ateos medical AG</documentation>
  </annotation>
</enumeration>
<enumeration value="0230025">
  <annotation>
    <documentation>Chiropro GmbH</documentation>
  </annotation>
</enumeration>
<enumeration value="0230026">
  <annotation>
    <documentation>Medacta</documentation>
  </annotation>
</enumeration>
<enumeration value="0230027">
  <annotation>
    <documentation>OHST Medizintechnik AG</documentation>
  </annotation>
</enumeration>
```

```
</annotation>
</enumeration>
<enumeration value="0230028">
  <annotation>
    <documentation>Lima Deutschland GmbH</documentation>
  </annotation>
</enumeration>
<enumeration value="0230029">
  <annotation>
    <documentation>alloPlus GmbH</documentation>
  </annotation>
</enumeration>
<enumeration value="0230030">
  <annotation>
    <documentation>Heraeus Medical GmbH</documentation>
  </annotation>
</enumeration>
<enumeration value="0230031">
  <annotation>
    <documentation>ImplanTec Deutschland GmbH</documentation>
  </annotation>
</enumeration>
<enumeration value="0230032">
  <annotation>
    <documentation>Falcon Medical GmbH</documentation>
  </annotation>
</enumeration>
<enumeration value="0230033">
  <annotation>
    <documentation>Meril GmbH</documentation>
  </annotation>
</enumeration>
<enumeration value="0230034">
  <annotation>
    <documentation>Zimmer Germany GmbH</documentation>
  </annotation>
</enumeration>
<enumeration value="0230035">
  <annotation>
    <documentation>Stryker GmbH & Co. KG</documentation>
  </annotation>
</enumeration>
<enumeration value="0230036">
  <annotation>
    <documentation>Aesculap AG</documentation>
  </annotation>
</enumeration>
<enumeration value="0230037">
  <annotation>
    <documentation>Waldemar Link GmbH & Co. KG</documentation>
  </annotation>
</enumeration>
<enumeration value="0230038">
  <annotation>
    <documentation>Corin Germany GmbH</documentation>
  </annotation>
</enumeration>
<enumeration value="0230039">
  <annotation>
```

| | |
|--|---|
| | <pre> <documentation>nicht belegter Wert</documentation> </annotation> </enumeration> <enumeration value="0230040"> <annotation> <documentation>nicht belegter Wert</documentation> </annotation> </enumeration> <enumeration value="0230041"> <annotation> <documentation>nicht belegter Wert</documentation> </annotation> </enumeration> <enumeration value="0230042"> <annotation> <documentation>sonstige</documentation> </annotation> </enumeration> <enumeration value="0230043"> <annotation> <documentation>nicht belegter Wert</documentation> </annotation> </enumeration> <enumeration value="0230044"> <annotation> <documentation>nicht belegter Wert</documentation> </annotation> </enumeration> </restriction> </simpleType> </pre> |
|--|---|

simpleType enum_0252

| | | | |
|------------|--|---------|-------------------------|
| namespace | http://xml.ir-d.de/stn | | |
| type | restriction of string | | |
| properties | base xs:string | | |
| facets | Kind | Value | Annotation |
| | enumeration | 0252001 | documentation Pfanne |
| | enumeration | 0252002 | documentation Schaft |
| | enumeration | 0252003 | documentation beides |
| annotation | documentation Kat_EP_KomponenteHuefte | | |
| source | <pre> <simpleType name="enum_0252"> <annotation> <documentation>Kat_EP_KomponenteHuefte</documentation> </annotation> <restriction base="xs:string"> <enumeration value="0252001"> <annotation> <documentation>Pfanne</documentation> </annotation> </enumeration> <enumeration value="0252002"> <annotation> </pre> | | |

| | |
|--|--|
| | <pre> <documentation>Schaft</documentation> </annotation> </enumeration> <enumeration value="0252003"> <annotation> <documentation>beides</documentation> </annotation> </enumeration> </restriction> </simpleType> </pre> |
|--|--|

simpleType enum_0254

| | | | |
|------------|--|---------|--------------------------|
| namespace | http://xml.ir-d.de/stn | | |
| type | restriction of string | | |
| properties | base xs:string | | |
| facets | Kind | Value | Annotation |
| | enumeration | 0254001 | documentation Femur |
| | enumeration | 0254002 | documentation Tibia |
| | enumeration | 0254003 | documentation Patella |
| | enumeration | 0254004 | documentation mehrere |
| annotation | documentation Kat_EP_KomponenteKnie | | |
| source | <pre> <simpleType name="enum_0254"> <annotation> <documentation>Kat_EP_KomponenteKnie</documentation> </annotation> <restriction base="xs:string"> <enumeration value="0254001"> <annotation> <documentation>Femur</documentation> </annotation> </enumeration> <enumeration value="0254002"> <annotation> <documentation>Tibia</documentation> </annotation> </enumeration> <enumeration value="0254003"> <annotation> <documentation>Patella</documentation> </annotation> </enumeration> <enumeration value="0254004"> <annotation> <documentation>mehrere</documentation> </annotation> </enumeration> </restriction> </simpleType> </pre> | | |

simpleType enum_0256

| | | | |
|------------|---|---------|------------------------------------|
| namespace | http://xml.ir-d.de/stn | | |
| type | restriction of string | | |
| properties | base xs:string | | |
| facets | Kind | Value | Annotation |
| | enumeration | 0256001 | documentation Pfanne |
| | enumeration | 0256002 | documentation Schaft |
| | enumeration | 0256003 | documentation Pfanne und Schaft |
| | enumeration | 0256004 | documentation Femur |
| | enumeration | 0256005 | documentation Tibia |
| | enumeration | 0256006 | documentation Patella |
| | enumeration | 0256007 | documentation mehrere |
| annotation | documentation Kat_EP_KomponenteTFE | | |
| source | <pre> <simpleType name="enum_0256"> <annotation> <documentation>Kat_EP_KomponenteTFE</documentation> </annotation> <restriction base="xs:string"> <enumeration value="0256001"> <annotation> <documentation>Pfanne</documentation> </annotation> </enumeration> <enumeration value="0256002"> <annotation> <documentation>Schaft</documentation> </annotation> </enumeration> <enumeration value="0256003"> <annotation> <documentation>Pfanne und Schaft</documentation> </annotation> </enumeration> <enumeration value="0256004"> <annotation> <documentation>Femur</documentation> </annotation> </enumeration> <enumeration value="0256005"> <annotation> <documentation>Tibia</documentation> </annotation> </enumeration> <enumeration value="0256006"> <annotation> <documentation>Patella</documentation> </annotation> </enumeration> <enumeration value="0256007"> <annotation> </pre> | | |

| | |
|--|---|
| | <pre> <documentation>mehrere</documentation> </annotation> </enumeration> </restriction> </simpleType> </pre> |
|--|---|

simpleType enum_0262

| | | | |
|------------|---|---------|--------------------------|
| namespace | http://xml.ir-d.de/stn | | |
| type | restriction of string | | |
| properties | base xs:string | | |
| facets | Kind | Value | Annotation |
| | enumeration | 0262001 | documentation Pfanne |
| | enumeration | 0262002 | documentation Schaft |
| | enumeration | 0262003 | documentation Kopf |
| | enumeration | 0262004 | documentation Inlay |
| | enumeration | 0262005 | documentation Adapter |
| | enumeration | 0262006 | documentation mehrere |
| annotation | documentation Kat_EP_ImplantatbruchHuefte | | |
| source | <pre> <simpleType name="enum_0262"> <annotation> <documentation>Kat_EP_ImplantatbruchHuefte</documentation> </annotation> <restriction base="xs:string"> <enumeration value="0262001"> <annotation> <documentation>Pfanne</documentation> </annotation> </enumeration> <enumeration value="0262002"> <annotation> <documentation>Schaft</documentation> </annotation> </enumeration> <enumeration value="0262003"> <annotation> <documentation>Kopf</documentation> </annotation> </enumeration> <enumeration value="0262004"> <annotation> <documentation>Inlay</documentation> </annotation> </enumeration> <enumeration value="0262005"> <annotation> <documentation>Adapter</documentation> </annotation> </enumeration> <enumeration value="0262006"> </pre> | | |

| | |
|--|--|
| | <pre> <annotation> <documentation>mehrere</documentation> </annotation> </enumeration> </restriction> </simpleType> </pre> |
|--|--|

simpleType enum_0264

| | | | |
|------------|--|---------|-------------------------------|
| namespace | http://xml.ir-d.de/stn | | |
| type | restriction of string | | |
| properties | base xs:string | | |
| facets | Kind | Value | Annotation |
| | enumeration | 0264001 | documentation Femur |
| | enumeration | 0264002 | documentation Tibia |
| | enumeration | 0264003 | documentation Inlay |
| | enumeration | 0264004 | documentation Adapter |
| | enumeration | 0264005 | documentation Verlängerung |
| | enumeration | 0264006 | documentation Schrauben |
| | enumeration | 0264007 | documentation mehrere |
| | enumeration | 0264042 | documentation andere |
| annotation | documentation Kat_EP_ImplantatbruchKnie | | |
| source | <pre> <simpleType name="enum_0264"> <annotation> <documentation>Kat_EP_ImplantatbruchKnie</documentation> </annotation> <restriction base="xs:string"> <enumeration value="0264001"> <annotation> <documentation>Femur</documentation> </annotation> </enumeration> <enumeration value="0264002"> <annotation> <documentation>Tibia</documentation> </annotation> </enumeration> <enumeration value="0264003"> <annotation> <documentation>Inlay</documentation> </annotation> </enumeration> <enumeration value="0264004"> <annotation> <documentation>Adapter</documentation> </annotation> </enumeration> <enumeration value="0264005"> <annotation> </pre> | | |

```

        <documentation>Verlängerung</documentation>
    </annotation>
</enumeration>
<enumeration value="0264006">
    <annotation>
        <documentation>Schrauben</documentation>
    </annotation>
</enumeration>
<enumeration value="0264007">
    <annotation>
        <documentation>mehrere</documentation>
    </annotation>
</enumeration>
<enumeration value="0264042">
    <annotation>
        <documentation>andere</documentation>
    </annotation>
</enumeration>
</restriction>
</simpleType>

```

simpleType **enum_0266**

| | | | |
|------------|---|---------|-------------------------------|
| namespace | http://xml.ir-d.de/stn | | |
| type | restriction of string | | |
| properties | base xs:string | | |
| facets | Kind | Value | Annotation |
| | enumeration | 0266001 | documentation Pfanne |
| | enumeration | 0266002 | documentation Schaft |
| | enumeration | 0266003 | documentation Kopf |
| | enumeration | 0266004 | documentation Inlay |
| | enumeration | 0266005 | documentation Adapter |
| | enumeration | 0266006 | documentation Femur |
| | enumeration | 0266007 | documentation Tibia |
| | enumeration | 0266008 | documentation Verlängerung |
| | enumeration | 0266009 | documentation Schrauben |
| | enumeration | 0266010 | documentation mehrere |
| | enumeration | 0266042 | documentation andere |
| annotation | documentation Kat_EP_ImplantatbruchTFE | | |
| source | <pre> <simpleType name="enum_0266"> <annotation> <documentation>Kat_EP_ImplantatbruchTFE</documentation> </annotation> <restriction base="xs:string"> <enumeration value="0266001"> <annotation> </pre> | | |

```
<documentation>Pfanne</documentation>
</annotation>
</enumeration>
<enumeration value="0266002">
  <annotation>
    <documentation>Schaft</documentation>
  </annotation>
</enumeration>
<enumeration value="0266003">
  <annotation>
    <documentation>Kopf</documentation>
  </annotation>
</enumeration>
<enumeration value="0266004">
  <annotation>
    <documentation>Inlay</documentation>
  </annotation>
</enumeration>
<enumeration value="0266005">
  <annotation>
    <documentation>Adapter</documentation>
  </annotation>
</enumeration>
<enumeration value="0266006">
  <annotation>
    <documentation>Femur</documentation>
  </annotation>
</enumeration>
<enumeration value="0266007">
  <annotation>
    <documentation>Tibia</documentation>
  </annotation>
</enumeration>
<enumeration value="0266008">
  <annotation>
    <documentation>Verlängerung</documentation>
  </annotation>
</enumeration>
<enumeration value="0266009">
  <annotation>
    <documentation>Schrauben</documentation>
  </annotation>
</enumeration>
<enumeration value="0266010">
  <annotation>
    <documentation>mehrere</documentation>
  </annotation>
</enumeration>
<enumeration value="0266042">
  <annotation>
    <documentation>andere</documentation>
  </annotation>
</enumeration>
</restriction>
</simpleType>
```

simpleType enum_0270

| | | | |
|------------|---|---------|---------------------------------------|
| namespace | http://xml.ir-d.de/stn | | |
| type | restriction of string | | |
| properties | base xs:string | | |
| facets | Kind | Value | Annotation |
| | enumeration | 0270001 | documentation PE-Inlay |
| | enumeration | 0270002 | documentation patellare Komponente |
| | enumeration | 0270003 | documentation beides |
| annotation | documentation Kat_EP_VerschleissKnie | | |
| source | <pre> <simpleType name="enum_0270"> <annotation> <documentation>Kat_EP_VerschleissKnie</documentation> </annotation> <restriction base="xs:string"> <enumeration value="0270001"> <annotation> <documentation>PE-Inlay</documentation> </annotation> </enumeration> <enumeration value="0270002"> <annotation> <documentation>patellare Komponente</documentation> </annotation> </enumeration> <enumeration value="0270003"> <annotation> <documentation>beides</documentation> </annotation> </enumeration> </restriction> </simpleType> </pre> | | |

simpleType enum_0271

| | | | |
|------------|---------------------------------------|---------|---------------------------------------|
| namespace | http://xml.ir-d.de/stn | | |
| type | restriction of string | | |
| properties | base xs:string | | |
| facets | Kind | Value | Annotation |
| | enumeration | 0271001 | documentation Schraube |
| | enumeration | 0271002 | documentation Inlay |
| | enumeration | 0271003 | documentation patellare Komponente |
| | enumeration | 0271004 | documentation Kopplung |
| | enumeration | 0271005 | documentation mehrere |
| | enumeration | 0271042 | documentation andere |
| annotation | documentation Kat_EP_MigrationKnie | | |

| | |
|--------|---|
| source | <pre> <simpleType name="enum_0271"> <annotation> <documentation>Kat_EP_MigrationKnie</documentation> </annotation> <restriction base="xs:string"> <enumeration value="0271001"> <annotation> <documentation>Schraube</documentation> </annotation> </enumeration> <enumeration value="0271002"> <annotation> <documentation>Inlay</documentation> </annotation> </enumeration> <enumeration value="0271003"> <annotation> <documentation>patellare Komponente</documentation> </annotation> </enumeration> <enumeration value="0271004"> <annotation> <documentation>Kopplung</documentation> </annotation> </enumeration> <enumeration value="0271005"> <annotation> <documentation>mehrere</documentation> </annotation> </enumeration> <enumeration value="0271042"> <annotation> <documentation>andere</documentation> </annotation> </enumeration> </restriction> </simpleType> </pre> |
|--------|---|

simpleType enum_0290

| | | | |
|------------|--|---------|---|
| namespace | http://xml.ir-d.de/stn | | |
| type | restriction of string | | |
| properties | base xs:string | | |
| facets | Kind | Value | Annotation |
| | enumeration | 0290001 | documentation Hüft-Komponente |
| | enumeration | 0290002 | documentation Knie-Komponente |
| | enumeration | 0290003 | documentation Modulare Komponente (Hüfte/Knie) |
| annotation | documentation Kat_EP_Artikeltyp | | |
| source | <pre> <simpleType name="enum_0290"> <annotation> <documentation>Kat_EP_Artikeltyp</documentation> </annotation> </pre> | | |

| | |
|--|--|
| | <pre> <restriction base="xs:string"> <enumeration value="0290001"> <annotation> <documentation>Hüft-Komponente</documentation> </annotation> </enumeration> <enumeration value="0290002"> <annotation> <documentation>Knie-Komponente</documentation> </annotation> </enumeration> <enumeration value="0290003"> <annotation> <documentation>Modulare Komponente (Hüfte/Knie)</documentation> </annotation> </enumeration> </restriction> </simpleType> </pre> |
|--|--|

simpleType enum_0291

| | | | |
|------------|--|---------|------------------------------------|
| namespace | http://xml.ir-d.de/stn | | |
| type | restriction of string | | |
| properties | base xs:string | | |
| facets | Kind | Value | Annotation |
| | enumeration | 0291001 | documentation Knochen-Zement |
| | enumeration | 0291002 | documentation sonstiges Zubehör |
| annotation | documentation Kat_EP_ZubehoerTyp | | |
| source | <pre> <simpleType name="enum_0291"> <annotation> <documentation>Kat_EP_ZubehoerTyp</documentation> </annotation> <restriction base="xs:string"> <enumeration value="0291001"> <annotation> <documentation>Knochen-Zement</documentation> </annotation> </enumeration> <enumeration value="0291002"> <annotation> <documentation>sonstiges Zubehör</documentation> </annotation> </enumeration> </restriction> </simpleType> </pre> | | |

simpleType enum_0300

| | | | |
|------------|------------------------------|--|--|
| namespace | http://xml.ir-d.de/stn | | |
| type | restriction of string | | |
| properties | base xs:string | | |

| facets | <table border="1"> <thead> <tr> <th>Kind</th> <th>Value</th> <th>Annotation</th> </tr> </thead> <tbody> <tr> <td>enumeration</td> <td>0300001</td> <td>documentation konventioneller Aortenklappenersatz</td> </tr> <tr> <td>enumeration</td> <td>0300002</td> <td>documentation kathetergestützte Aortenklappenimplantation (TAVI)</td> </tr> </tbody> </table> | Kind | Value | Annotation | enumeration | 0300001 | documentation konventioneller Aortenklappenersatz | enumeration | 0300002 | documentation kathetergestützte Aortenklappenimplantation (TAVI) |
|-------------|--|---|-------|------------|-------------|---------|--|-------------|---------|---|
| Kind | Value | Annotation | | | | | | | | |
| enumeration | 0300001 | documentation konventioneller Aortenklappenersatz | | | | | | | | |
| enumeration | 0300002 | documentation kathetergestützte Aortenklappenimplantation (TAVI) | | | | | | | | |
| annotation | documentation Kat_AK_ArtEingriff | | | | | | | | | |
| source | <pre> <simpleType name="enum_0300"> <annotation> <documentation>Kat_AK_ArtEingriff</documentation> </annotation> <restriction base="xs:string"> <enumeration value="0300001"> <annotation> <documentation>konventioneller Aortenklappenersatz</documentation> </annotation> </enumeration> <enumeration value="0300002"> <annotation> <documentation>kathetergestützte Aortenklappenimplantation (TAVI)</documentation> </annotation> </enumeration> </restriction> </simpleType> </pre> | | | | | | | | | |

simpleType enum 0302

| namespace | http://xml.ir-d.de/stn | | | | | | | | | | | | |
|-------------|--|---|-------|------------|-------------|---------|--------------------------|-------------|---------|-------------------------------|-------------|---------|---|
| type | restriction of string | | | | | | | | | | | | |
| properties | base xs:string | | | | | | | | | | | | |
| facets | <table border="1"> <thead> <tr> <th>Kind</th> <th>Value</th> <th>Annotation</th> </tr> </thead> <tbody> <tr> <td>enumeration</td> <td>0302001</td> <td>documentation Stenose</td> </tr> <tr> <td>enumeration</td> <td>0302002</td> <td>documentation Insuffizienz</td> </tr> <tr> <td>enumeration</td> <td>0302003</td> <td>documentation Stenose und Insuffizienz</td> </tr> </tbody> </table> | Kind | Value | Annotation | enumeration | 0302001 | documentation Stenose | enumeration | 0302002 | documentation Insuffizienz | enumeration | 0302003 | documentation Stenose und Insuffizienz |
| Kind | Value | Annotation | | | | | | | | | | | |
| enumeration | 0302001 | documentation Stenose | | | | | | | | | | | |
| enumeration | 0302002 | documentation Insuffizienz | | | | | | | | | | | |
| enumeration | 0302003 | documentation Stenose und Insuffizienz | | | | | | | | | | | |
| annotation | documentation Kat_AK_GrundEingriff | | | | | | | | | | | | |
| source | <pre> <simpleType name="enum_0302"> <annotation> <documentation>Kat_AK_GrundEingriff</documentation> </annotation> <restriction base="xs:string"> <enumeration value="0302001"> <annotation> <documentation>Stenose</documentation> </annotation> </enumeration> <enumeration value="0302002"> <annotation> <documentation>Insuffizienz</documentation> </annotation> </enumeration> <enumeration value="0302003"> <annotation> </pre> | | | | | | | | | | | | |

| | |
|--|--|
| | <pre> <documentation>Stenose und Insuffizienz</documentation> </annotation> </enumeration> </restriction> </simpleType> </pre> |
|--|--|

simpleType enum_0318

| | | | |
|------------|--|---------|-------------------------------------|
| namespace | http://xml.ir-d.de/stn | | |
| type | restriction of string | | |
| properties | base xs:string | | |
| facets | Kind | Value | Annotation |
| | enumeration | 0318001 | documentation transapikal |
| | enumeration | 0318002 | documentation transaortal |
| | enumeration | 0318003 | documentation transfemoral |
| | enumeration | 0318004 | documentation transaxillär |
| | enumeration | 0318042 | documentation anderer Zugangsweg |
| annotation | documentation Kat_AK_ZugangKatheter | | |
| source | <pre> <simpleType name="enum_0318"> <annotation> <documentation>Kat_AK_ZugangKatheter</documentation> </annotation> <restriction base="xs:string"> <enumeration value="0318001"> <annotation> <documentation>transapikal</documentation> </annotation> </enumeration> <enumeration value="0318002"> <annotation> <documentation>transaortal</documentation> </annotation> </enumeration> <enumeration value="0318003"> <annotation> <documentation>transfemoral</documentation> </annotation> </enumeration> <enumeration value="0318004"> <annotation> <documentation>transaxillär</documentation> </annotation> </enumeration> <enumeration value="0318042"> <annotation> <documentation>anderer Zugangsweg</documentation> </annotation> </enumeration> </restriction> </simpleType> </pre> | | |

simpleType enum_0320

| | | | |
|------------|--|---------|---|
| namespace | http://xml.ir-d.de/stn | | |
| type | restriction of string | | |
| properties | base xs:string | | |
| facets | Kind | Value | Annotation |
| | enumeration | 0320001 | documentation konventionelle Sternotomie |
| | enumeration | 0320002 | documentation partielle Sternotomie |
| | enumeration | 0320003 | documentation parasternaler Zugang |
| | enumeration | 0320042 | documentation anderer Zugangsweg |
| annotation | documentation Kat_AK_ZugangKonventionell | | |
| source | <pre> <simpleType name="enum_0320"> <annotation> <documentation>Kat_AK_ZugangKonventionell</documentation> </annotation> <restriction base="xs:string"> <enumeration value="0320001"> <annotation> <documentation>konventionelle Sternotomie</documentation> </annotation> </enumeration> <enumeration value="0320002"> <annotation> <documentation>partielle Sternotomie</documentation> </annotation> </enumeration> <enumeration value="0320003"> <annotation> <documentation>parasternaler Zugang</documentation> </annotation> </enumeration> <enumeration value="0320042"> <annotation> <documentation>anderer Zugangsweg</documentation> </annotation> </enumeration> </restriction> </simpleType> </pre> | | |

simpleType enum_0322

| | | | |
|------------|------------------------------|---------|---|
| namespace | http://xml.ir-d.de/stn | | |
| type | restriction of string | | |
| properties | base xs:string | | |
| facets | Kind | Value | Annotation |
| | enumeration | 0322001 | documentation nein |
| | enumeration | 0322002 | documentation ja, diätetisch behandelt |
| | enumeration | 0322003 | documentation |

| | |
|------------|---|
| | enumeration 0322004 ja, orale Medikation documentation enumeration 0322005 ja, mit Insulin behandelt documentation enumeration 0322099 ja, unbehandelt documentation unbekannt |
| annotation | documentation Kat_AK_Diabetes |
| source | <pre> <simpleType name="enum_0322"> <annotation> <documentation>Kat_AK_Diabetes</documentation> </annotation> <restriction base="xs:string"> <enumeration value="0322001"> <annotation> <documentation>nein</documentation> </annotation> </enumeration> <enumeration value="0322002"> <annotation> <documentation>ja, diätetisch behandelt</documentation> </annotation> </enumeration> <enumeration value="0322003"> <annotation> <documentation>ja, orale Medikation</documentation> </annotation> </enumeration> <enumeration value="0322004"> <annotation> <documentation>ja, mit Insulin behandelt</documentation> </annotation> </enumeration> <enumeration value="0322005"> <annotation> <documentation>ja, unbehandelt</documentation> </annotation> </enumeration> <enumeration value="0322099"> <annotation> <documentation>unbekannt</documentation> </annotation> </enumeration> </restriction> </simpleType> </pre> |

simpleType enum_0324

| | | | |
|------------|------------------------------|-----------|---|
| namespace | http://xml.ir-d.de/stn | | |
| type | restriction of string | | |
| properties | base | xs:string | |
| facets | Kind | Value | Annotation |
| | enumeration | 0324001 | documentation (I): Beschwerdefreiheit, normale körperliche Belastbarkeit |
| | enumeration | 0324002 | documentation (II): Beschwerden bei stärkerer körperlicher Belastung |

| | |
|------------|---|
| | enumeration 0324003 documentation (III): Beschwerden bei leichter körperlicher Belastung enumeration 0324004 documentation (IV): Beschwerden in Ruhe |
| annotation | documentation Kat_AK_NYHA |
| source | <pre> <simpleType name="enum_0324"> <annotation> <documentation>Kat_AK_NYHA</documentation> </annotation> <restriction base="xs:string"> <enumeration value="0324001"> <annotation> <documentation>(I): Beschwerdefreiheit, normale körperliche Belastbarkeit</documentation> </annotation> </enumeration> <enumeration value="0324002"> <annotation> <documentation>(II): Beschwerden bei stärkerer körperlicher Belastung</documentation> </annotation> </enumeration> <enumeration value="0324003"> <annotation> <documentation>(III): Beschwerden bei leichter körperlicher Belastung</documentation> </annotation> </enumeration> <enumeration value="0324004"> <annotation> <documentation>(IV): Beschwerden in Ruhe</documentation> </annotation> </enumeration> </restriction> </simpleType> </pre> |

simpleType enum_0330

| | | | |
|------------|------------------------------|---------|--|
| namespace | http://xml.ir-d.de/stn | | |
| type | restriction of string | | |
| properties | base xs:string | | |
| facets | Kind | Value | Annotation |
| | enumeration | 0330001 | documentation ATS Medical |
| | enumeration | 0330002 | documentation Edwards Lifesciences |
| | enumeration | 0330003 | documentation Medtronic |
| | enumeration | 0330004 | documentation JenaValve |
| | enumeration | 0330005 | documentation Corcym |
| | enumeration | 0330006 | documentation Abbott Medical / St. Jude |
| | enumeration | 0330007 | documentation Symetis |
| | enumeration | 0330008 | documentation |

| | |
|------------|---|
| | <p>enumeration 0330009 Direct Flow Medical documentation</p> <p>enumeration 0330010 Boston Scientific documentation</p> <p>enumeration 0330011 Artivion documentation</p> <p>enumeration 0330012 Biosensors documentation</p> <p>enumeration 0330013 LivaNova documentation</p> <p>enumeration 0330014 Meril documentation</p> <p>enumeration 0330015 nicht belegter Wert documentation</p> <p>enumeration 0330016 nicht belegter Wert documentation</p> <p>enumeration 0330017 nicht belegter Wert documentation</p> <p>enumeration 0330018 nicht belegter Wert documentation</p> <p>enumeration 0330042 nicht belegter Wert documentation sonstiger Hersteller</p> |
| annotation | documentation Kat_AK_Hersteller |
| source | <pre> <simpleType name="enum_0330"> <annotation> <documentation>Kat_AK_Hersteller</documentation> </annotation> <restriction base="xs:string"> <enumeration value="0330001"> <annotation> <documentation>ATS Medical</documentation> </annotation> </enumeration> <enumeration value="0330002"> <annotation> <documentation>Edwards Lifesciences</documentation> </annotation> </enumeration> <enumeration value="0330003"> <annotation> <documentation>Medtronic</documentation> </annotation> </enumeration> <enumeration value="0330004"> <annotation> <documentation>JenaValve</documentation> </annotation> </enumeration> <enumeration value="0330005"> <annotation> <documentation>Corcym</documentation> </annotation> </enumeration> <enumeration value="0330006"> <annotation> <documentation>Abbott Medical / St. Jude</documentation> </annotation> </enumeration> <enumeration value="0330007"> </pre> |

```
<annotation>
  <documentation>Symetis</documentation>
</annotation>
</enumeration>
<enumeration value="0330008">
  <annotation>
    <documentation>Direct Flow Medical</documentation>
  </annotation>
</enumeration>
<enumeration value="0330009">
  <annotation>
    <documentation>Boston Scientific</documentation>
  </annotation>
</enumeration>
<enumeration value="0330010">
  <annotation>
    <documentation>Artivion</documentation>
  </annotation>
</enumeration>
<enumeration value="0330011">
  <annotation>
    <documentation>Biosensors</documentation>
  </annotation>
</enumeration>
<enumeration value="0330012">
  <annotation>
    <documentation>LivaNova</documentation>
  </annotation>
</enumeration>
<enumeration value="0330013">
  <annotation>
    <documentation>Meril</documentation>
  </annotation>
</enumeration>
<enumeration value="0330014">
  <annotation>
    <documentation>nicht belegter Wert</documentation>
  </annotation>
</enumeration>
<enumeration value="0330015">
  <annotation>
    <documentation>nicht belegter Wert</documentation>
  </annotation>
</enumeration>
<enumeration value="0330016">
  <annotation>
    <documentation>nicht belegter Wert</documentation>
  </annotation>
</enumeration>
<enumeration value="0330017">
  <annotation>
    <documentation>nicht belegter Wert</documentation>
  </annotation>
</enumeration>
<enumeration value="0330018">
  <annotation>
    <documentation>nicht belegter Wert</documentation>
  </annotation>
</enumeration>
```

| | |
|--|---|
| | <pre> <enumeration value="0330042"> <annotation> <documentation>sonstiger Hersteller</documentation> </annotation> </enumeration> </restriction> </simpleType> </pre> |
|--|---|

simpleType enum_0338

| | | | |
|------------|--|---------|-----------------------------|
| namespace | http://xml.ir-d.de/stn | | |
| type | restriction of string | | |
| properties | base xs:string | | |
| facets | Kind | Value | Annotation |
| | enumeration | 0338001 | documentation LAD |
| | enumeration | 0338002 | documentation RCA |
| | enumeration | 0338003 | documentation RCX |
| | enumeration | 0338004 | documentation Hauptstamm |
| annotation | documentation Kat_AK_PCIArterien | | |
| source | <pre> <simpleType name="enum_0338"> <annotation> <documentation>Kat_AK_PCIArterien</documentation> </annotation> <restriction base="xs:string"> <enumeration value="0338001"> <annotation> <documentation>LAD</documentation> </annotation> </enumeration> <enumeration value="0338002"> <annotation> <documentation>RCA</documentation> </annotation> </enumeration> <enumeration value="0338003"> <annotation> <documentation>RCX</documentation> </annotation> </enumeration> <enumeration value="0338004"> <annotation> <documentation>Hauptstamm</documentation> </annotation> </enumeration> </restriction> </simpleType> </pre> | | |

simpleType enum_0339

| | |
|-----------|------------------------|
| namespace | http://xml.ir-d.de/stn |
|-----------|------------------------|

| type | restriction of string | | | | | | | | | | | | |
|-------------|---|-------------------------|-------|------------|-------------|---------|----------------------|-------------|---------|---------------------|-------------|---------|-------------------------|
| properties | base xs:string | | | | | | | | | | | | |
| facets | <table border="1"> <thead> <tr> <th>Kind</th> <th>Value</th> <th>Annotation</th> </tr> </thead> <tbody> <tr> <td>enumeration</td> <td>0339001</td> <td>documentation TEE</td> </tr> <tr> <td>enumeration</td> <td>0339002</td> <td>documentation CT</td> </tr> <tr> <td>enumeration</td> <td>0339042</td> <td>documentation andere</td> </tr> </tbody> </table> | Kind | Value | Annotation | enumeration | 0339001 | documentation TEE | enumeration | 0339002 | documentation CT | enumeration | 0339042 | documentation andere |
| Kind | Value | Annotation | | | | | | | | | | | |
| enumeration | 0339001 | documentation TEE | | | | | | | | | | | |
| enumeration | 0339002 | documentation CT | | | | | | | | | | | |
| enumeration | 0339042 | documentation andere | | | | | | | | | | | |
| annotation | documentation Kat_AK_AnnulusMessmethode | | | | | | | | | | | | |
| source | <pre> <simpleType name="enum_0339"> <annotation> <documentation>Kat_AK_AnnulusMessmethode</documentation> </annotation> <restriction base="xs:string"> <enumeration value="0339001"> <annotation> <documentation>TEE</documentation> </annotation> </enumeration> <enumeration value="0339002"> <annotation> <documentation>CT</documentation> </annotation> </enumeration> <enumeration value="0339042"> <annotation> <documentation>andere</documentation> </annotation> </enumeration> </restriction> </simpleType> </pre> | | | | | | | | | | | | |

simpleType enum_0341

| namespace | http://xml.ir-d.de/stn | | | | | | | | | | | | | | | | | | |
|-------------|--|--|-------|------------|-------------|---------|---|-------------|---------|---|-------------|---------|---|-------------|---------|--|-------------|---------|--|
| type | restriction of string | | | | | | | | | | | | | | | | | | |
| properties | base xs:string | | | | | | | | | | | | | | | | | | |
| facets | <table border="1"> <thead> <tr> <th>Kind</th> <th>Value</th> <th>Annotation</th> </tr> </thead> <tbody> <tr> <td>enumeration</td> <td>0341001</td> <td>documentation intraprozedural verstorben</td> </tr> <tr> <td>enumeration</td> <td>0341002</td> <td>documentation Implantation von mehr als einer Prothese</td> </tr> <tr> <td>enumeration</td> <td>0341003</td> <td>documentation gravierende Gefäß- oder Zugangskomplikation (gemäß VARC-3)</td> </tr> <tr> <td>enumeration</td> <td>0341004</td> <td>documentation erforderlicher chirurgischer oder interventioneller Eingriff wegen einer Klappenfehlfunktion (gemäß VARC-3)</td> </tr> <tr> <td>enumeration</td> <td>0341005</td> <td>documentation &gt;= große strukturelle kardiale Komplikation (gemäß VARC-3)</td> </tr> </tbody> </table> | Kind | Value | Annotation | enumeration | 0341001 | documentation intraprozedural verstorben | enumeration | 0341002 | documentation Implantation von mehr als einer Prothese | enumeration | 0341003 | documentation gravierende Gefäß- oder Zugangskomplikation (gemäß VARC-3) | enumeration | 0341004 | documentation erforderlicher chirurgischer oder interventioneller Eingriff wegen einer Klappenfehlfunktion (gemäß VARC-3) | enumeration | 0341005 | documentation >= große strukturelle kardiale Komplikation (gemäß VARC-3) |
| Kind | Value | Annotation | | | | | | | | | | | | | | | | | |
| enumeration | 0341001 | documentation intraprozedural verstorben | | | | | | | | | | | | | | | | | |
| enumeration | 0341002 | documentation Implantation von mehr als einer Prothese | | | | | | | | | | | | | | | | | |
| enumeration | 0341003 | documentation gravierende Gefäß- oder Zugangskomplikation (gemäß VARC-3) | | | | | | | | | | | | | | | | | |
| enumeration | 0341004 | documentation erforderlicher chirurgischer oder interventioneller Eingriff wegen einer Klappenfehlfunktion (gemäß VARC-3) | | | | | | | | | | | | | | | | | |
| enumeration | 0341005 | documentation >= große strukturelle kardiale Komplikation (gemäß VARC-3) | | | | | | | | | | | | | | | | | |
| annotation | documentation Kat_AK_FailureGrund | | | | | | | | | | | | | | | | | | |
| source | <pre> <simpleType name="enum_0341"> <annotation> <documentation>Kat AK FailureGrund</documentation> </annotation> </pre> | | | | | | | | | | | | | | | | | | |

```

</annotation>
<restriction base="xs:string">
  <enumeration value="0341001">
    <annotation>
      <documentation>intraprozedural verstorben</documentation>
    </annotation>
  </enumeration>
  <enumeration value="0341002">
    <annotation>
      <documentation>Implantation von mehr als einer Prothese</documentation>
    </annotation>
  </enumeration>
  <enumeration value="0341003">
    <annotation>
      <documentation>gravierende Gefäß- oder Zugangskomplikation (gemäß
VARC-3)</documentation>
    </annotation>
  </enumeration>
  <enumeration value="0341004">
    <annotation>
      <documentation>erforderlicher chirurgischer oder interventioneller
Eingriff wegen einer Klappenfehlfunktion (gemäß VARC-3)</documentation>
    </annotation>
  </enumeration>
  <enumeration value="0341005">
    <annotation>
      <documentation>&gt;= große strukturelle kardiale Komplikation (gemäß
VARC-3)</documentation>
    </annotation>
  </enumeration>
</restriction>
</simpleType>

```

simpleType **enum_0342**

| | | | |
|------------|---|---------|--|
| namespace | http://xml.ir-d.de/stn | | |
| type | restriction of string | | |
| properties | base xs:string | | |
| facets | Kind | Value | Annotation |
| | enumeration | 0342001 | documentation Alter |
| | enumeration | 0342002 | documentation Frailty |
| | enumeration | 0342003 | documentation Hochrisiko |
| | enumeration | 0342004 | documentation Prognose-limitierende Zweiterkrankung |
| | enumeration | 0342005 | documentation Porzellan-Aorta |
| | enumeration | 0342042 | documentation Sonstige |
| annotation | documentation Kat_AK_Tavi | | |
| source | <simpleType name="enum_0342"> <annotation> <documentation>Kat_AK_Tavi</documentation> </annotation> | | |

```

<restriction base="xs:string">
  <enumeration value="0342001">
    <annotation>
      <documentation>Alter</documentation>
    </annotation>
  </enumeration>
  <enumeration value="0342002">
    <annotation>
      <documentation>Frailty</documentation>
    </annotation>
  </enumeration>
  <enumeration value="0342003">
    <annotation>
      <documentation>Hochrisiko</documentation>
    </annotation>
  </enumeration>
  <enumeration value="0342004">
    <annotation>
      <documentation>Prognose-limitierende Zweiterkrankung</documentation>
    </annotation>
  </enumeration>
  <enumeration value="0342005">
    <annotation>
      <documentation>Porzellan-Aorta</documentation>
    </annotation>
  </enumeration>
  <enumeration value="0342042">
    <annotation>
      <documentation>Sonstige</documentation>
    </annotation>
  </enumeration>
</restriction>
</simpleType>

```

simpleType enum_0343

| | | | |
|------------|------------------------------|---------|--|
| namespace | http://xml.ir-d.de/stn | | |
| type | restriction of string | | |
| properties | base xs:string | | |
| facets | Kind | Value | Annotation |
| | enumeration | 0343001 | documentation Device-Fehlpositionierung |
| | enumeration | 0343002 | documentation Koronarostienverschluss |
| | enumeration | 0343003 | documentation Aortendissektion |
| | enumeration | 0343004 | documentation Aortenregurgitation > = 2. Grades |
| | enumeration | 0343005 | documentation Annulus-Ruptur |
| | enumeration | 0343006 | documentation Ruptur-/Perforation einer Herzhöhle ohne Therapiebedarf |
| | enumeration | 0343007 | documentation Ruptur-/Perforation einer Herzhöhle mit Therapiebedarf |
| | enumeration | 0343008 | documentation Perikardtamponade |
| | enumeration | 0343009 | documentation kardiale Dekompensation |

| | |
|------------|--|
| | <p>enumeration 0343010 documentation Himembolie</p> <p>enumeration 0343011 documentation Rhythmusstörungen</p> <p>enumeration 0343012 documentation Device-Embolisation</p> <p>enumeration 0343013 documentation vaskuläre Komplikation</p> <p>enumeration 0343014 documentation Low Cardiac Output</p> <p>enumeration 0343015 documentation schwerwiegende Blutungen (intraprozedural)</p> <p>enumeration 0343016 documentation lebensbedrohliche Blutungen (intraprozedural)</p> <p>enumeration 0343017 documentation Patient verstarb im OP/Katheterlabor</p> <p>enumeration 0343042 documentation sonstige intraprozedurale Komplikationen</p> |
| annotation | documentation Kat_AK_KomplikationTyp |
| source | <pre> <simpleType name="enum_0343"> <annotation> <documentation>Kat_AK_KomplikationTyp</documentation> </annotation> <restriction base="xs:string"> <enumeration value="0343001"> <annotation> <documentation>Device-Fehlpositionierung</documentation> </annotation> </enumeration> <enumeration value="0343002"> <annotation> <documentation>Koronarostienverschluss</documentation> </annotation> </enumeration> <enumeration value="0343003"> <annotation> <documentation>Aortendissektion</documentation> </annotation> </enumeration> <enumeration value="0343004"> <annotation> <documentation>Aortenregurgitation &gt; = 2. Grades</documentation> </annotation> </enumeration> <enumeration value="0343005"> <annotation> <documentation>Annulus-Ruptur</documentation> </annotation> </enumeration> <enumeration value="0343006"> <annotation> <documentation>Ruptur-/Perforation einer Herzhöhle ohne Therapiebedarf</documentation> </annotation> </enumeration> <enumeration value="0343007"> <annotation> <documentation>Ruptur-/Perforation einer Herzhöhle mit Therapiebedarf</documentation> </annotation> </enumeration> </restriction> </simpleType> </pre> |

```

</annotation>
</enumeration>
<enumeration value="0343008">
  <annotation>
    <documentation>Perikardtamponade</documentation>
  </annotation>
</enumeration>
<enumeration value="0343009">
  <annotation>
    <documentation>kardiale Dekompensation</documentation>
  </annotation>
</enumeration>
<enumeration value="0343010">
  <annotation>
    <documentation>Hirnembolie</documentation>
  </annotation>
</enumeration>
<enumeration value="0343011">
  <annotation>
    <documentation>Rhythmusstörungen</documentation>
  </annotation>
</enumeration>
<enumeration value="0343012">
  <annotation>
    <documentation>Device-Embolisation</documentation>
  </annotation>
</enumeration>
<enumeration value="0343013">
  <annotation>
    <documentation>vaskuläre Komplikation</documentation>
  </annotation>
</enumeration>
<enumeration value="0343014">
  <annotation>
    <documentation>Low Cardiac Output</documentation>
  </annotation>
</enumeration>
<enumeration value="0343015">
  <annotation>
    <documentation>schwerwiegende Blutungen
(intraprozedural)</documentation>
  </annotation>
</enumeration>
<enumeration value="0343016">
  <annotation>
    <documentation>lebensbedrohliche Blutungen
(intraprozedural)</documentation>
  </annotation>
</enumeration>
<enumeration value="0343017">
  <annotation>
    <documentation>Patient verstarb im OP/Katheterlabor</documentation>
  </annotation>
</enumeration>
<enumeration value="0343042">
  <annotation>
    <documentation>sonstige intraprozedurale
Komplikationen</documentation>
  </annotation>

```

```

</enumeration>
</restriction>
</simpleType>

```

simpleType enum_0346

| | | | |
|------------|---|---------|--|
| namespace | http://xml.ir-d.de/stn | | |
| type | restriction of string | | |
| properties | base xs:string | | |
| facets | Kind | Value | Annotation |
| | enumeration | 0346001 | documentation keine Therapie erforderlich |
| | enumeration | 0346002 | documentation medikamentös |
| | enumeration | 0346003 | documentation IABP |
| | enumeration | 0346004 | documentation VAD |
| | enumeration | 0346005 | documentation ECMO |
| | enumeration | 0346042 | documentation sonstige |
| annotation | documentation Kat AK TherapieLCO | | |
| source | <pre> <simpleType name="enum_0346"> <annotation> <documentation>Kat_AK_TherapieLCO</documentation> </annotation> <restriction base="xs:string"> <enumeration value="0346001"> <annotation> <documentation>keine Therapie erforderlich</documentation> </annotation> </enumeration> <enumeration value="0346002"> <annotation> <documentation>medikamentös</documentation> </annotation> </enumeration> <enumeration value="0346003"> <annotation> <documentation>IABP</documentation> </annotation> </enumeration> <enumeration value="0346004"> <annotation> <documentation>VAD</documentation> </annotation> </enumeration> <enumeration value="0346005"> <annotation> <documentation>ECMO</documentation> </annotation> </enumeration> <enumeration value="0346042"> <annotation> <documentation>sonstige</documentation> </annotation> </enumeration> </restriction> </simpleType> </pre> | | |

| | |
|--|--|
| | <pre> </annotation> </enumeration> </restriction> </simpleType> </pre> |
|--|--|

simpleType enum_0347

| namespace | http://xml.ir-d.de/stn | | | | | | | | | |
|-------------|---|---|-------|------------|-------------|---------|---------------------------------|-------------|---------|---|
| type | restriction of string | | | | | | | | | |
| properties | base xs:string | | | | | | | | | |
| facets | <table border="1"> <thead> <tr> <th>Kind</th> <th>Value</th> <th>Annotation</th> </tr> </thead> <tbody> <tr> <td>enumeration</td> <td>0347001</td> <td>documentation Einzeleingriff</td> </tr> <tr> <td>enumeration</td> <td>0347002</td> <td>documentation Kombinationseingriff mit mehreren Prozeduren</td> </tr> </tbody> </table> | Kind | Value | Annotation | enumeration | 0347001 | documentation Einzeleingriff | enumeration | 0347002 | documentation Kombinationseingriff mit mehreren Prozeduren |
| Kind | Value | Annotation | | | | | | | | |
| enumeration | 0347001 | documentation Einzeleingriff | | | | | | | | |
| enumeration | 0347002 | documentation Kombinationseingriff mit mehreren Prozeduren | | | | | | | | |
| annotation | documentation Kat_AK_Eingriffsumfang | | | | | | | | | |
| source | <pre> <simpleType name="enum_0347"> <annotation> <documentation>Kat_AK_Eingriffsumfang</documentation> </annotation> <restriction base="xs:string"> <enumeration value="0347001"> <annotation> <documentation>Einzeleingriff</documentation> </annotation> </enumeration> <enumeration value="0347002"> <annotation> <documentation>Kombinationseingriff mit mehreren Prozeduren</documentation> </annotation> </enumeration> </restriction> </simpleType> </pre> | | | | | | | | | |

simpleType enum_0348

| namespace | http://xml.ir-d.de/stn | | | | | | | | | | | | |
|-------------|---|---|-------|------------|-------------|---------|--------------------------|-------------|---------|---------------------------|-------------|---------|---|
| type | restriction of string | | | | | | | | | | | | |
| properties | base xs:string | | | | | | | | | | | | |
| facets | <table border="1"> <thead> <tr> <th>Kind</th> <th>Value</th> <th>Annotation</th> </tr> </thead> <tbody> <tr> <td>enumeration</td> <td>0348001</td> <td>documentation mit HLM</td> </tr> <tr> <td>enumeration</td> <td>0348002</td> <td>documentation ohne HLM</td> </tr> <tr> <td>enumeration</td> <td>0348003</td> <td>documentation Umstieg von OP ohne HLM auf OP mit HLM</td> </tr> </tbody> </table> | Kind | Value | Annotation | enumeration | 0348001 | documentation mit HLM | enumeration | 0348002 | documentation ohne HLM | enumeration | 0348003 | documentation Umstieg von OP ohne HLM auf OP mit HLM |
| Kind | Value | Annotation | | | | | | | | | | | |
| enumeration | 0348001 | documentation mit HLM | | | | | | | | | | | |
| enumeration | 0348002 | documentation ohne HLM | | | | | | | | | | | |
| enumeration | 0348003 | documentation Umstieg von OP ohne HLM auf OP mit HLM | | | | | | | | | | | |
| annotation | documentation Kat_AK_OPVorgehen | | | | | | | | | | | | |
| source | <pre> <simpleType name="enum_0348"> <annotation> <documentation>Kat_AK_OPVorgehen</documentation> </annotation> </pre> | | | | | | | | | | | | |

| | |
|--|---|
| | <pre> <restriction base="xs:string"> <enumeration value="0348001"> <annotation> <documentation>mit HLM</documentation> </annotation> </enumeration> <enumeration value="0348002"> <annotation> <documentation>ohne HLM</documentation> </annotation> </enumeration> <enumeration value="0348003"> <annotation> <documentation>Umstieg von OP ohne HLM auf OP mit HLM</documentation> </annotation> </enumeration> </restriction> </simpleType> </pre> |
|--|---|

simpleType enum_0350

| | | | |
|------------|---|---------|--------------------------|
| namespace | http://xml.ir-d.de/stn | | |
| type | restriction of string | | |
| properties | base xs:string | | |
| facets | Kind | Value | Annotation |
| | enumeration | 0350001 | documentation IABP |
| | enumeration | 0350002 | documentation Impella |
| | enumeration | 0350003 | documentation vv ECMO |
| | enumeration | 0350004 | documentation va ECMO |
| | enumeration | 0350042 | documentation andere |
| annotation | documentation Kat_AK_Methode | | |
| source | <pre> <simpleType name="enum_0350"> <annotation> <documentation>Kat_AK_Methode</documentation> </annotation> <restriction base="xs:string"> <enumeration value="0350001"> <annotation> <documentation>IABP</documentation> </annotation> </enumeration> <enumeration value="0350002"> <annotation> <documentation>Impella</documentation> </annotation> </enumeration> <enumeration value="0350003"> <annotation> <documentation>vv ECMO</documentation> </annotation> </enumeration> </restriction> </pre> | | |

| | |
|--|--|
| | <pre> <enumeration value="0350004"> <annotation> <documentation>va ECMO</documentation> </annotation> </enumeration> <enumeration value="0350042"> <annotation> <documentation>andere</documentation> </annotation> </enumeration> </restriction> </simpleType> </pre> |
|--|--|

simpleType enum_0351

| | | | |
|------------|---|---------|---|
| namespace | http://xml.ir-d.de/stn | | |
| type | restriction of string | | |
| properties | base xs:string | | |
| facets | Kind | Value | Annotation |
| | enumeration | 0351001 | documentation nein |
| | enumeration | 0351002 | documentation ja, zu Sternotomie |
| | enumeration | 0351003 | documentation ja, zu transapikal |
| | enumeration | 0351004 | documentation ja, zu transaortal |
| | enumeration | 0351005 | documentation ja, zu transfemoral |
| | enumeration | 0351006 | documentation ja, zu transaxillär |
| | enumeration | 0351007 | documentation ja, zu anderem endovaskulären Zugang |
| | enumeration | 0351042 | documentation ja, zu anderem Zugang |
| annotation | documentation Kat_AK_Konversion | | |
| source | <pre> <simpleType name="enum_0351"> <annotation> <documentation>Kat_AK_Konversion</documentation> </annotation> <restriction base="xs:string"> <enumeration value="0351001"> <annotation> <documentation>nein</documentation> </annotation> </enumeration> <enumeration value="0351002"> <annotation> <documentation>ja, zu Sternotomie</documentation> </annotation> </enumeration> <enumeration value="0351003"> <annotation> <documentation>ja, zu transapikal</documentation> </annotation> </enumeration> <enumeration value="0351004"> </pre> | | |

| | |
|--|--|
| | <pre> <annotation> <documentation>ja, zu transaortal</documentation> </annotation> </enumeration> <enumeration value="0351005"> <annotation> <documentation>ja, zu transfemoral</documentation> </annotation> </enumeration> <enumeration value="0351006"> <annotation> <documentation>ja, zu transaxillär</documentation> </annotation> </enumeration> <enumeration value="0351007"> <annotation> <documentation>ja, zu anderem endovaskulären Zugang</documentation> </annotation> </enumeration> <enumeration value="0351042"> <annotation> <documentation>ja, zu anderem Zugang</documentation> </annotation> </enumeration> </restriction> </simpleType> </pre> |
|--|--|

simpleType enum_0352

| | | | |
|------------|---|---------|---|
| namespace | http://xml.ir-d.de/stn | | |
| type | restriction of string | | |
| properties | base xs:string | | |
| facets | Kind | Value | Annotation |
| | enumeration | 0352001 | documentation nein |
| | enumeration | 0352002 | documentation ja, Intubationsnarkose |
| | enumeration | 0352003 | documentation ja, Maskenbeatmung, incl. LAMA |
| | enumeration | 0352042 | documentation ja, unbekannt welche |
| annotation | documentation Kat_AK_Anaesthesie | | |
| source | <pre> <simpleType name="enum_0352"> <annotation> <documentation>Kat_AK_Anaesthesie</documentation> </annotation> <restriction base="xs:string"> <enumeration value="0352001"> <annotation> <documentation>nein</documentation> </annotation> </enumeration> <enumeration value="0352002"> <annotation> <documentation>ja, Intubationsnarkose</documentation> </annotation> </enumeration> </restriction> </simpleType> </pre> | | |

| | |
|--|--|
| | <pre> </enumeration> <enumeration value="0352003"> <annotation> <documentation>ja, Maskenbeatmung, incl. LAMA</documentation> </annotation> </enumeration> <enumeration value="0352042"> <annotation> <documentation>ja, unbekannt welche</documentation> </annotation> </enumeration> </restriction> </simpleType> </pre> |
|--|--|

simpleType enum_0353

| | | | |
|------------|---|---------|-----------------------------------|
| namespace | http://xml.ir-d.de/stn | | |
| type | restriction of string | | |
| properties | base xs:string | | |
| facets | Kind | Value | Annotation |
| | enumeration | 0353001 | documentation keine |
| | enumeration | 0353002 | documentation leichtgradig |
| | enumeration | 0353003 | documentation mittelgradig |
| | enumeration | 0353004 | documentation hochgradig |
| | enumeration | 0353099 | documentation nicht bestimmbar |
| annotation | documentation Kat_AK_ResidualeArteninsuffizienz | | |
| source | <pre> <simpleType name="enum_0353"> <annotation> <documentation>Kat_AK_ResidualeArteninsuffizienz</documentation> </annotation> <restriction base="xs:string"> <enumeration value="0353001"> <annotation> <documentation>keine</documentation> </annotation> </enumeration> <enumeration value="0353002"> <annotation> <documentation>leichtgradig</documentation> </annotation> </enumeration> <enumeration value="0353003"> <annotation> <documentation>mittelgradig</documentation> </annotation> </enumeration> <enumeration value="0353004"> <annotation> <documentation>hochgradig</documentation> </annotation> </enumeration> </restriction> </simpleType> </pre> | | |

| | |
|--|---|
| | <pre> <enumeration value="0353099"> <annotation> <documentation>nicht bestimmbar</documentation> </annotation> </enumeration> </restriction> </simpleType> </pre> |
|--|---|

simpleType enum_0354

| | | | |
|------------|--|---------|------------------------------------|
| namespace | http://xml.ir-d.de/stn | | |
| type | restriction of string | | |
| properties | base xs:string | | |
| facets | Kind | Value | Annotation |
| | enumeration | 0354001 | documentation chirurgisch-offen |
| | enumeration | 0354002 | documentation Verschluss-System |
| | enumeration | 0354042 | documentation sonstige |
| annotation | documentation Kat_AK_Zugangswegverschluss | | |
| source | <pre> <simpleType name="enum_0354"> <annotation> <documentation>Kat_AK_Zugangswegverschluss</documentation> </annotation> <restriction base="xs:string"> <enumeration value="0354001"> <annotation> <documentation>chirurgisch-offen</documentation> </annotation> </enumeration> <enumeration value="0354002"> <annotation> <documentation>Verschluss-System</documentation> </annotation> </enumeration> <enumeration value="0354042"> <annotation> <documentation>sonstige</documentation> </annotation> </enumeration> </restriction> </simpleType> </pre> | | |

simpleType enum_0357

| | | | |
|------------|------------------------------|---------|----------------------------|
| namespace | http://xml.ir-d.de/stn | | |
| type | restriction of string | | |
| properties | base xs:string | | |
| facets | Kind | Value | Annotation |
| | enumeration | 0357001 | documentation keine KHK |
| | enumeration | 0357002 | documentation |

| | |
|------------|---|
| | enumeration 0357003 1-Gefäßerkrankung documentation enumeration 0357004 2-Gefäßerkrankung documentation enumeration 0357005 3-Gefäßerkrankung documentation keine koronare Bildgebung |
| annotation | documentation Kat_AK_BefundBildgebung |
| source | <pre> <simpleType name="enum_0357"> <annotation> <documentation>Kat_AK_BefundBildgebung</documentation> </annotation> <restriction base="xs:string"> <enumeration value="0357001"> <annotation> <documentation>keine KHK</documentation> </annotation> </enumeration> <enumeration value="0357002"> <annotation> <documentation>1-Gefäßerkrankung</documentation> </annotation> </enumeration> <enumeration value="0357003"> <annotation> <documentation>2-Gefäßerkrankung</documentation> </annotation> </enumeration> <enumeration value="0357004"> <annotation> <documentation>3-Gefäßerkrankung</documentation> </annotation> </enumeration> <enumeration value="0357005"> <annotation> <documentation>keine koronare Bildgebung</documentation> </annotation> </enumeration> </restriction> </simpleType> </pre> |

simpleType enum 0358

| | | | |
|------------|------------------------------|---------|--------------------|
| namespace | http://xml.ir-d.de/stn | | |
| type | restriction of string | | |
| properties | base xs:string | | |
| facets | Kind | Value | Annotation |
| | enumeration | 0358001 | documentation 0 |
| | enumeration | 0358002 | documentation 1 |
| | enumeration | 0358003 | documentation 2 |
| | enumeration | 0358004 | documentation 3 |
| | enumeration | 0358005 | documentation 4 |

| | |
|------------|--|
| | enumeration 0358006 documentation 5 oder mehr enumeration 0358098 documentation genaue Anzahl unbekannt (aber mind. 1) enumeration 0358099 documentation unbekannt |
| annotation | documentation Kat_AK_AnzahlVorOP |
| source | <pre> <simpleType name="enum_0358"> <annotation> <documentation>Kat_AK_AnzahlVorOP</documentation> </annotation> <restriction base="xs:string"> <enumeration value="0358001"> <annotation> <documentation>0</documentation> </annotation> </enumeration> <enumeration value="0358002"> <annotation> <documentation>1</documentation> </annotation> </enumeration> <enumeration value="0358003"> <annotation> <documentation>2</documentation> </annotation> </enumeration> <enumeration value="0358004"> <annotation> <documentation>3</documentation> </annotation> </enumeration> <enumeration value="0358005"> <annotation> <documentation>4</documentation> </annotation> </enumeration> <enumeration value="0358006"> <annotation> <documentation>5 oder mehr</documentation> </annotation> </enumeration> <enumeration value="0358098"> <annotation> <documentation>genaue Anzahl unbekannt (aber mind. 1)</documentation> </annotation> </enumeration> <enumeration value="0358099"> <annotation> <documentation>unbekannt</documentation> </annotation> </enumeration> </restriction> </simpleType> </pre> |

simpleType enum_0359

| | | | |
|------------|--|---------|----------------------------------|
| namespace | http://xml.ir-d.de/stn | | |
| type | restriction of string | | |
| properties | base xs:string | | |
| facets | Kind | Value | Annotation |
| | enumeration | 0359001 | documentation nein |
| | enumeration | 0359002 | documentation ja - einseitig |
| | enumeration | 0359003 | documentation ja - beidseitig |
| | enumeration | 0359042 | documentation unbekannt |
| annotation | documentation Kat_AK_LVOT | | |
| source | <pre> <simpleType name="enum_0359"> <annotation> <documentation>Kat_AK_LVOT</documentation> </annotation> <restriction base="xs:string"> <enumeration value="0359001"> <annotation> <documentation>nein</documentation> </annotation> </enumeration> <enumeration value="0359002"> <annotation> <documentation>ja - einseitig</documentation> </annotation> </enumeration> <enumeration value="0359003"> <annotation> <documentation>ja - beidseitig</documentation> </annotation> </enumeration> <enumeration value="0359042"> <annotation> <documentation>unbekannt</documentation> </annotation> </enumeration> </restriction> </simpleType> </pre> | | |

simpleType enum_0360

| | | | |
|------------|------------------------------|---------|-------------------------------|
| namespace | http://xml.ir-d.de/stn | | |
| type | restriction of string | | |
| properties | base xs:string | | |
| facets | Kind | Value | Annotation |
| | enumeration | 0360001 | documentation keine |
| | enumeration | 0360002 | documentation leichtgradig |
| | enumeration | 0360003 | documentation mittelgradig |
| | enumeration | 0360004 | documentation |

| | |
|------------|--|
| | <p>enumeration 0360005 hochgradig documentation massive</p> <p>enumeration 0360006 documentation torrential</p> <p>enumeration 0360099 documentation unbekannt</p> |
| annotation | documentation Kat_AK_TriskupidalInsuffizienz |
| source | <pre> <simpleType name="enum_0360"> <annotation> <documentation>Kat_AK_TriskupidalInsuffizienz</documentation> </annotation> <restriction base="xs:string"> <enumeration value="0360001"> <annotation> <documentation>keine</documentation> </annotation> </enumeration> <enumeration value="0360002"> <annotation> <documentation>leichtgradig</documentation> </annotation> </enumeration> <enumeration value="0360003"> <annotation> <documentation>mittelgradig</documentation> </annotation> </enumeration> <enumeration value="0360004"> <annotation> <documentation>hochgradig</documentation> </annotation> </enumeration> <enumeration value="0360005"> <annotation> <documentation>massive</documentation> </annotation> </enumeration> <enumeration value="0360006"> <annotation> <documentation>torrential</documentation> </annotation> </enumeration> <enumeration value="0360099"> <annotation> <documentation>unbekannt</documentation> </annotation> </enumeration> </restriction> </simpleType> </pre> |

simpleType enum_0361

| | |
|------------|------------------------------|
| namespace | http://xml.ir-d.de/stn |
| type | restriction of string |
| properties | base xs:string |

| facets | <table border="1"> <thead> <tr> <th>Kind</th> <th>Value</th> <th>Annotation</th> </tr> </thead> <tbody> <tr> <td>enumeration</td> <td>0361001</td> <td>documentation nein</td> </tr> <tr> <td>enumeration</td> <td>0361002</td> <td>documentation ja, letzte(r) innerhalb der letzten 48 Stunden</td> </tr> <tr> <td>enumeration</td> <td>0361003</td> <td>documentation ja, letzte(r) innerhalb der letzten 21 Tage</td> </tr> <tr> <td>enumeration</td> <td>0361004</td> <td>documentation ja, letzte(r) länger als 21 Tage</td> </tr> <tr> <td>enumeration</td> <td>0361098</td> <td>documentation ja, letzter Zeitpunkt unbekannt</td> </tr> <tr> <td>enumeration</td> <td>0361099</td> <td>documentation unbekannt</td> </tr> </tbody> </table> | Kind | Value | Annotation | enumeration | 0361001 | documentation nein | enumeration | 0361002 | documentation ja, letzte(r) innerhalb der letzten 48 Stunden | enumeration | 0361003 | documentation ja, letzte(r) innerhalb der letzten 21 Tage | enumeration | 0361004 | documentation ja, letzte(r) länger als 21 Tage | enumeration | 0361098 | documentation ja, letzter Zeitpunkt unbekannt | enumeration | 0361099 | documentation unbekannt |
|-------------|--|---|-------|------------|-------------|---------|-----------------------|-------------|---------|---|-------------|---------|--|-------------|---------|---|-------------|---------|--|-------------|---------|----------------------------|
| Kind | Value | Annotation | | | | | | | | | | | | | | | | | | | | |
| enumeration | 0361001 | documentation nein | | | | | | | | | | | | | | | | | | | | |
| enumeration | 0361002 | documentation ja, letzte(r) innerhalb der letzten 48 Stunden | | | | | | | | | | | | | | | | | | | | |
| enumeration | 0361003 | documentation ja, letzte(r) innerhalb der letzten 21 Tage | | | | | | | | | | | | | | | | | | | | |
| enumeration | 0361004 | documentation ja, letzte(r) länger als 21 Tage | | | | | | | | | | | | | | | | | | | | |
| enumeration | 0361098 | documentation ja, letzter Zeitpunkt unbekannt | | | | | | | | | | | | | | | | | | | | |
| enumeration | 0361099 | documentation unbekannt | | | | | | | | | | | | | | | | | | | | |
| annotation | documentation Kat_AK_SchockReanimation | | | | | | | | | | | | | | | | | | | | | |
| source | <pre> <simpleType name="enum_0361"> <annotation> <documentation>Kat_AK_SchockReanimation</documentation> </annotation> <restriction base="xs:string"> <enumeration value="0361001"> <annotation> <documentation>nein</documentation> </annotation> </enumeration> <enumeration value="0361002"> <annotation> <documentation>ja, letzte(r) innerhalb der letzten 48 Stunden</documentation> </annotation> </enumeration> <enumeration value="0361003"> <annotation> <documentation>ja, letzte(r) innerhalb der letzten 21 Tage</documentation> </annotation> </enumeration> <enumeration value="0361004"> <annotation> <documentation>ja, letzte(r) länger als 21 Tage</documentation> </annotation> </enumeration> <enumeration value="0361098"> <annotation> <documentation>ja, letzter Zeitpunkt unbekannt</documentation> </annotation> </enumeration> <enumeration value="0361099"> <annotation> <documentation>unbekannt</documentation> </annotation> </enumeration> </restriction> </simpleType> </pre> | | | | | | | | | | | | | | | | | | | | | |

simpleType **enum_0362**

| | |
|-----------|------------------------|
| namespace | http://xml.ir-d.de/stn |
|-----------|------------------------|

| type | restriction of string | | | | | | | | | | | | |
|-------------|---|---------------------------------------|-------|------------|-------------|---------|--------------------------------|-------------|---------|---------------------------------|-------------|---------|---------------------------------------|
| properties | base xs:string | | | | | | | | | | | | |
| facets | <table border="1"> <thead> <tr> <th>Kind</th> <th>Value</th> <th>Annotation</th> </tr> </thead> <tbody> <tr> <td>enumeration</td> <td>0362001</td> <td>documentation Sinusrhythmus</td> </tr> <tr> <td>enumeration</td> <td>0362002</td> <td>documentation Vorhofflimmern</td> </tr> <tr> <td>enumeration</td> <td>0362042</td> <td>documentation anderer Herzrhythmus</td> </tr> </tbody> </table> | Kind | Value | Annotation | enumeration | 0362001 | documentation Sinusrhythmus | enumeration | 0362002 | documentation Vorhofflimmern | enumeration | 0362042 | documentation anderer Herzrhythmus |
| Kind | Value | Annotation | | | | | | | | | | | |
| enumeration | 0362001 | documentation Sinusrhythmus | | | | | | | | | | | |
| enumeration | 0362002 | documentation Vorhofflimmern | | | | | | | | | | | |
| enumeration | 0362042 | documentation anderer Herzrhythmus | | | | | | | | | | | |
| annotation | documentation Kat_AK_Herzrhythmus | | | | | | | | | | | | |
| source | <pre> <simpleType name="enum_0362"> <annotation> <documentation>Kat_AK_Herzrhythmus</documentation> </annotation> <restriction base="xs:string"> <enumeration value="0362001"> <annotation> <documentation>Sinusrhythmus</documentation> </annotation> </enumeration> <enumeration value="0362002"> <annotation> <documentation>Vorhofflimmern</documentation> </annotation> </enumeration> <enumeration value="0362042"> <annotation> <documentation>anderer Herzrhythmus</documentation> </annotation> </enumeration> </restriction> </simpleType> </pre> | | | | | | | | | | | | |

simpleType **enum_0363**

| namespace | http://xml.ir-d.de/stn | | | | | | | | | | | | | | | |
|-------------|---|--------------------------------|-------|------------|-------------|---------|-----------------------|-------------|---------|-----------------------------|-------------|---------|--------------------------------|-------------|---------|----------------------------|
| type | restriction of string | | | | | | | | | | | | | | | |
| properties | base xs:string | | | | | | | | | | | | | | | |
| facets | <table border="1"> <thead> <tr> <th>Kind</th> <th>Value</th> <th>Annotation</th> </tr> </thead> <tbody> <tr> <td>enumeration</td> <td>0363001</td> <td>documentation nein</td> </tr> <tr> <td>enumeration</td> <td>0363002</td> <td>documentation paroxysmal</td> </tr> <tr> <td>enumeration</td> <td>0363003</td> <td>documentation persistierend</td> </tr> <tr> <td>enumeration</td> <td>0363004</td> <td>documentation permanent</td> </tr> </tbody> </table> | Kind | Value | Annotation | enumeration | 0363001 | documentation nein | enumeration | 0363002 | documentation paroxysmal | enumeration | 0363003 | documentation persistierend | enumeration | 0363004 | documentation permanent |
| Kind | Value | Annotation | | | | | | | | | | | | | | |
| enumeration | 0363001 | documentation nein | | | | | | | | | | | | | | |
| enumeration | 0363002 | documentation paroxysmal | | | | | | | | | | | | | | |
| enumeration | 0363003 | documentation persistierend | | | | | | | | | | | | | | |
| enumeration | 0363004 | documentation permanent | | | | | | | | | | | | | | |
| annotation | documentation Kat_AK_Vorhofflimmern | | | | | | | | | | | | | | | |
| source | <pre> <simpleType name="enum_0363"> <annotation> <documentation>Kat_AK_Vorhofflimmern</documentation> </annotation> <restriction base="xs:string"> <enumeration value="0363001"> </pre> | | | | | | | | | | | | | | | |

| | |
|--|---|
| | <pre> <annotation> <documentation>nein</documentation> </annotation> </enumeration> <enumeration value="0363002"> <annotation> <documentation>paroxysmal</documentation> </annotation> </enumeration> <enumeration value="0363003"> <annotation> <documentation>persistierend</documentation> </annotation> </enumeration> <enumeration value="0363004"> <annotation> <documentation>permanent</documentation> </annotation> </enumeration> </restriction> </simpleType> </pre> |
|--|---|

simpleType enum 0364

| | | | |
|------------|--|---------|--|
| namespace | http://xml.ir-d.de/stn | | |
| type | restriction of string | | |
| properties | base xs:string | | |
| facets | Kind | Value | Annotation |
| | enumeration | 0364001 | documentation nein |
| | enumeration | 0364002 | documentation Schrittmacher ohne CRT-System |
| | enumeration | 0364003 | documentation Schrittmacher mit CRT-System |
| | enumeration | 0364004 | documentation Defibrillator ohne CRT-System |
| | enumeration | 0364005 | documentation Defibrillator mit CRT-System |
| annotation | documentation Kat_AK_SchrittmacherDefi | | |
| source | <pre> <simpleType name="enum_0364"> <annotation> <documentation>Kat_AK_SchrittmacherDefi</documentation> </annotation> <restriction base="xs:string"> <enumeration value="0364001"> <annotation> <documentation>nein</documentation> </annotation> </enumeration> <enumeration value="0364002"> <annotation> <documentation>Schrittmacher ohne CRT-System</documentation> </annotation> </enumeration> <enumeration value="0364003"> <annotation> </pre> | | |

| | |
|--|---|
| | <pre> <documentation>Schrittmacher mit CRT-System</documentation> </annotation> </enumeration> <enumeration value="0364004"> <annotation> <documentation>Defibrillator ohne CRT-System</documentation> </annotation> </enumeration> <enumeration value="0364005"> <annotation> <documentation>Defibrillator mit CRT-System</documentation> </annotation> </enumeration> </restriction> </simpleType> </pre> |
|--|---|

simpleType enum 0365

| | | | |
|------------|---|---------|--------------------------------------|
| namespace | http://xml.ir-d.de/stn | | |
| type | restriction of string | | |
| properties | base xs:string | | |
| facets | Kind | Value | Annotation |
| | enumeration | 0365001 | documentation nein |
| | enumeration | 0365002 | documentation ja, operativ |
| | enumeration | 0365003 | documentation ja, interventionell |
| annotation | documentation Kat_AK_MyokardRevaskularisation | | |
| source | <pre> <simpleType name="enum_0365"> <annotation> <documentation>Kat_AK_MyokardRevaskularisation</documentation> </annotation> <restriction base="xs:string"> <enumeration value="0365001"> <annotation> <documentation>nein</documentation> </annotation> </enumeration> <enumeration value="0365002"> <annotation> <documentation>ja, operativ</documentation> </annotation> </enumeration> <enumeration value="0365003"> <annotation> <documentation>ja, interventionell</documentation> </annotation> </enumeration> </restriction> </simpleType> </pre> | | |

simpleType enum_0366

| | | | |
|------------|---|---------|--|
| namespace | http://xml.ir-d.de/stn | | |
| type | restriction of string | | |
| properties | base xs:string | | |
| facets | Kind | Value | Annotation |
| | enumeration | 0366001 | documentation nein |
| | enumeration | 0366002 | documentation ja, <= 6 Stunden |
| | enumeration | 0366003 | documentation ja, > 6 Stunden bis <= 3 Monate |
| | enumeration | 0366004 | documentation ja, > 3 Monate |
| | enumeration | 0366099 | documentation unbekannt |
| annotation | documentation Kat_AK_PCI | | |
| source | <pre> <simpleType name="enum_0366"> <annotation> <documentation>Kat_AK_PCI</documentation> </annotation> <restriction base="xs:string"> <enumeration value="0366001"> <annotation> <documentation>nein</documentation> </annotation> </enumeration> <enumeration value="0366002"> <annotation> <documentation>ja, &lt;= 6 Stunden</documentation> </annotation> </enumeration> <enumeration value="0366003"> <annotation> <documentation>ja, &gt; 6 Stunden bis &lt;= 3 Monate</documentation> </annotation> </enumeration> <enumeration value="0366004"> <annotation> <documentation>ja, &gt; 3 Monate</documentation> </annotation> </enumeration> <enumeration value="0366099"> <annotation> <documentation>unbekannt</documentation> </annotation> </enumeration> </restriction> </simpleType> </pre> | | |

simpleType enum_0367

| | | | |
|------------|------------------------------|--|--|
| namespace | http://xml.ir-d.de/stn | | |
| type | restriction of string | | |
| properties | base xs:string | | |

| facets | <table border="1"> <thead> <tr> <th data-bbox="293 199 432 226">Kind</th> <th data-bbox="432 199 555 226">Value</th> <th data-bbox="555 199 1434 226">Annotation</th> </tr> </thead> <tbody> <tr> <td data-bbox="293 226 432 277">enumeration</td> <td data-bbox="432 226 555 277">0367001</td> <td data-bbox="555 226 1434 277">documentation keine</td> </tr> <tr> <td data-bbox="293 277 432 329">enumeration</td> <td data-bbox="432 277 555 329">0367002</td> <td data-bbox="555 277 1434 329">documentation Mediastinitis</td> </tr> <tr> <td data-bbox="293 329 432 380">enumeration</td> <td data-bbox="432 329 555 380">0367003</td> <td data-bbox="555 329 1434 380">documentation Sepsis</td> </tr> <tr> <td data-bbox="293 380 432 432">enumeration</td> <td data-bbox="432 380 555 432">0367004</td> <td data-bbox="555 380 1434 432">documentation broncho-pulmonale Infektion</td> </tr> <tr> <td data-bbox="293 432 432 483">enumeration</td> <td data-bbox="432 432 555 483">0367005</td> <td data-bbox="555 432 1434 483">documentation oto-laryngologische Infektion</td> </tr> <tr> <td data-bbox="293 483 432 535">enumeration</td> <td data-bbox="432 483 555 535">0367006</td> <td data-bbox="555 483 1434 535">documentation floride Endokarditis</td> </tr> <tr> <td data-bbox="293 535 432 586">enumeration</td> <td data-bbox="432 535 555 586">0367007</td> <td data-bbox="555 535 1434 586">documentation Peritonitis</td> </tr> <tr> <td data-bbox="293 586 432 638">enumeration</td> <td data-bbox="432 586 555 638">0367008</td> <td data-bbox="555 586 1434 638">documentation Wundinfektion Thorax</td> </tr> <tr> <td data-bbox="293 638 432 689">enumeration</td> <td data-bbox="432 638 555 689">0367009</td> <td data-bbox="555 638 1434 689">documentation Pleuraempyem</td> </tr> <tr> <td data-bbox="293 689 432 741">enumeration</td> <td data-bbox="432 689 555 741">0367010</td> <td data-bbox="555 689 1434 741">documentation Venenkatheterinfektion</td> </tr> <tr> <td data-bbox="293 741 432 792">enumeration</td> <td data-bbox="432 741 555 792">0367011</td> <td data-bbox="555 741 1434 792">documentation Harnwegsinfektion</td> </tr> <tr> <td data-bbox="293 792 432 844">enumeration</td> <td data-bbox="432 792 555 844">0367012</td> <td data-bbox="555 792 1434 844">documentation Wundinfektion untere Extremitäten</td> </tr> <tr> <td data-bbox="293 844 432 896">enumeration</td> <td data-bbox="432 844 555 896">0367013</td> <td data-bbox="555 844 1434 896">documentation HIV-Infektion</td> </tr> <tr> <td data-bbox="293 896 432 947">enumeration</td> <td data-bbox="432 896 555 947">0367014</td> <td data-bbox="555 896 1434 947">documentation Hepatitis B oder C</td> </tr> <tr> <td data-bbox="293 947 432 999">enumeration</td> <td data-bbox="432 947 555 999">0367015</td> <td data-bbox="555 947 1434 999">documentation andere Wundinfektion</td> </tr> <tr> <td data-bbox="293 999 432 1050">enumeration</td> <td data-bbox="432 999 555 1050">0367042</td> <td data-bbox="555 999 1434 1050">documentation sonstige Infektion</td> </tr> </tbody> </table> | Kind | Value | Annotation | enumeration | 0367001 | documentation keine | enumeration | 0367002 | documentation Mediastinitis | enumeration | 0367003 | documentation Sepsis | enumeration | 0367004 | documentation broncho-pulmonale Infektion | enumeration | 0367005 | documentation oto-laryngologische Infektion | enumeration | 0367006 | documentation floride Endokarditis | enumeration | 0367007 | documentation Peritonitis | enumeration | 0367008 | documentation Wundinfektion Thorax | enumeration | 0367009 | documentation Pleuraempyem | enumeration | 0367010 | documentation Venenkatheterinfektion | enumeration | 0367011 | documentation Harnwegsinfektion | enumeration | 0367012 | documentation Wundinfektion untere Extremitäten | enumeration | 0367013 | documentation HIV-Infektion | enumeration | 0367014 | documentation Hepatitis B oder C | enumeration | 0367015 | documentation andere Wundinfektion | enumeration | 0367042 | documentation sonstige Infektion |
|-------------|---|--|-------|------------|-------------|---------|------------------------|-------------|---------|--------------------------------|-------------|---------|-------------------------|-------------|---------|--|-------------|---------|--|-------------|---------|---------------------------------------|-------------|---------|------------------------------|-------------|---------|---------------------------------------|-------------|---------|-------------------------------|-------------|---------|---|-------------|---------|------------------------------------|-------------|---------|--|-------------|---------|--------------------------------|-------------|---------|-------------------------------------|-------------|---------|---------------------------------------|-------------|---------|-------------------------------------|
| Kind | Value | Annotation | | | | | | | | | | | | | | | | | | | | | | | | | | | | | | | | | | | | | | | | | | | | | | | | | | |
| enumeration | 0367001 | documentation keine | | | | | | | | | | | | | | | | | | | | | | | | | | | | | | | | | | | | | | | | | | | | | | | | | | |
| enumeration | 0367002 | documentation Mediastinitis | | | | | | | | | | | | | | | | | | | | | | | | | | | | | | | | | | | | | | | | | | | | | | | | | | |
| enumeration | 0367003 | documentation Sepsis | | | | | | | | | | | | | | | | | | | | | | | | | | | | | | | | | | | | | | | | | | | | | | | | | | |
| enumeration | 0367004 | documentation broncho-pulmonale Infektion | | | | | | | | | | | | | | | | | | | | | | | | | | | | | | | | | | | | | | | | | | | | | | | | | | |
| enumeration | 0367005 | documentation oto-laryngologische Infektion | | | | | | | | | | | | | | | | | | | | | | | | | | | | | | | | | | | | | | | | | | | | | | | | | | |
| enumeration | 0367006 | documentation floride Endokarditis | | | | | | | | | | | | | | | | | | | | | | | | | | | | | | | | | | | | | | | | | | | | | | | | | | |
| enumeration | 0367007 | documentation Peritonitis | | | | | | | | | | | | | | | | | | | | | | | | | | | | | | | | | | | | | | | | | | | | | | | | | | |
| enumeration | 0367008 | documentation Wundinfektion Thorax | | | | | | | | | | | | | | | | | | | | | | | | | | | | | | | | | | | | | | | | | | | | | | | | | | |
| enumeration | 0367009 | documentation Pleuraempyem | | | | | | | | | | | | | | | | | | | | | | | | | | | | | | | | | | | | | | | | | | | | | | | | | | |
| enumeration | 0367010 | documentation Venenkatheterinfektion | | | | | | | | | | | | | | | | | | | | | | | | | | | | | | | | | | | | | | | | | | | | | | | | | | |
| enumeration | 0367011 | documentation Harnwegsinfektion | | | | | | | | | | | | | | | | | | | | | | | | | | | | | | | | | | | | | | | | | | | | | | | | | | |
| enumeration | 0367012 | documentation Wundinfektion untere Extremitäten | | | | | | | | | | | | | | | | | | | | | | | | | | | | | | | | | | | | | | | | | | | | | | | | | | |
| enumeration | 0367013 | documentation HIV-Infektion | | | | | | | | | | | | | | | | | | | | | | | | | | | | | | | | | | | | | | | | | | | | | | | | | | |
| enumeration | 0367014 | documentation Hepatitis B oder C | | | | | | | | | | | | | | | | | | | | | | | | | | | | | | | | | | | | | | | | | | | | | | | | | | |
| enumeration | 0367015 | documentation andere Wundinfektion | | | | | | | | | | | | | | | | | | | | | | | | | | | | | | | | | | | | | | | | | | | | | | | | | | |
| enumeration | 0367042 | documentation sonstige Infektion | | | | | | | | | | | | | | | | | | | | | | | | | | | | | | | | | | | | | | | | | | | | | | | | | | |
| annotation | documentation Kat_AK_Infektion | | | | | | | | | | | | | | | | | | | | | | | | | | | | | | | | | | | | | | | | | | | | | | | | | | | |
| source | <pre data-bbox="280 1200 1434 2033"> <simpleType name="enum_0367"> <annotation> <documentation>Kat_AK_Infektion</documentation> </annotation> <restriction base="xs:string"> <enumeration value="0367001"> <annotation> <documentation>keine</documentation> </annotation> </enumeration> <enumeration value="0367002"> <annotation> <documentation>Mediastinitis</documentation> </annotation> </enumeration> <enumeration value="0367003"> <annotation> <documentation>Sepsis</documentation> </annotation> </enumeration> <enumeration value="0367004"> <annotation> <documentation>broncho-pulmonale Infektion</documentation> </annotation> </enumeration> <enumeration value="0367005"> <annotation> <documentation> </pre> | | | | | | | | | | | | | | | | | | | | | | | | | | | | | | | | | | | | | | | | | | | | | | | | | | | |

```
<documentation>oto-laryngologische Infektion</documentation>
</annotation>
</enumeration>
<enumeration value="0367006">
  <annotation>
    <documentation>floride Endokarditis</documentation>
  </annotation>
</enumeration>
<enumeration value="0367007">
  <annotation>
    <documentation>Peritonitis</documentation>
  </annotation>
</enumeration>
<enumeration value="0367008">
  <annotation>
    <documentation>Wundinfektion Thorax</documentation>
  </annotation>
</enumeration>
<enumeration value="0367009">
  <annotation>
    <documentation>Pleuraempyem</documentation>
  </annotation>
</enumeration>
<enumeration value="0367010">
  <annotation>
    <documentation>Venenkatheterinfektion</documentation>
  </annotation>
</enumeration>
<enumeration value="0367011">
  <annotation>
    <documentation>Harnwegsinfektion</documentation>
  </annotation>
</enumeration>
<enumeration value="0367012">
  <annotation>
    <documentation>Wundinfektion untere Extremitäten</documentation>
  </annotation>
</enumeration>
<enumeration value="0367013">
  <annotation>
    <documentation>HIV-Infektion</documentation>
  </annotation>
</enumeration>
<enumeration value="0367014">
  <annotation>
    <documentation>Hepatitis B oder C</documentation>
  </annotation>
</enumeration>
<enumeration value="0367015">
  <annotation>
    <documentation>andere Wundinfektion</documentation>
  </annotation>
</enumeration>
<enumeration value="0367042">
  <annotation>
    <documentation>sonstige Infektion</documentation>
  </annotation>
</enumeration>
</restriction>
```

| | |
|--|----------------------------------|
| | <code></simpleType></code> |
|--|----------------------------------|

simpleType enum_0368

| namespace | http://xml.ir-d.de/stn | | | | | | | | | | | | | | | | | | |
|-------------|---|--|-------|------------|-------------|---------|-----------------------|-------------|---------|---|-------------|---------|--|-------------|---------|--|-------------|---------|----------------------------|
| type | restriction of string | | | | | | | | | | | | | | | | | | |
| properties | base xs:string | | | | | | | | | | | | | | | | | | |
| facets | <table><thead><tr><th>Kind</th><th>Value</th><th>Annotation</th></tr></thead><tbody><tr><td>enumeration</td><td>0368001</td><td>documentation nein</td></tr><tr><td>enumeration</td><td>0368002</td><td>documentation ja, COPD mit Dauermedikation</td></tr><tr><td>enumeration</td><td>0368003</td><td>documentation ja, COPD ohne Dauermedikation</td></tr><tr><td>enumeration</td><td>0368004</td><td>documentation ja, andere Lungenerkrankungen</td></tr><tr><td>enumeration</td><td>0368099</td><td>documentation unbekannt</td></tr></tbody></table> | Kind | Value | Annotation | enumeration | 0368001 | documentation nein | enumeration | 0368002 | documentation ja, COPD mit Dauermedikation | enumeration | 0368003 | documentation ja, COPD ohne Dauermedikation | enumeration | 0368004 | documentation ja, andere Lungenerkrankungen | enumeration | 0368099 | documentation unbekannt |
| Kind | Value | Annotation | | | | | | | | | | | | | | | | | |
| enumeration | 0368001 | documentation nein | | | | | | | | | | | | | | | | | |
| enumeration | 0368002 | documentation ja, COPD mit Dauermedikation | | | | | | | | | | | | | | | | | |
| enumeration | 0368003 | documentation ja, COPD ohne Dauermedikation | | | | | | | | | | | | | | | | | |
| enumeration | 0368004 | documentation ja, andere Lungenerkrankungen | | | | | | | | | | | | | | | | | |
| enumeration | 0368099 | documentation unbekannt | | | | | | | | | | | | | | | | | |
| annotation | documentation Kat_AK_Lungenerkrankung | | | | | | | | | | | | | | | | | | |
| source | <pre><simpleType name="enum_0368"> <annotation> <documentation>Kat_AK_Lungenerkrankung</documentation> </annotation> <restriction base="xs:string"> <enumeration value="0368001"> <annotation> <documentation>nein</documentation> </annotation> </enumeration> <enumeration value="0368002"> <annotation> <documentation>ja, COPD mit Dauermedikation</documentation> </annotation> </enumeration> <enumeration value="0368003"> <annotation> <documentation>ja, COPD ohne Dauermedikation</documentation> </annotation> </enumeration> <enumeration value="0368004"> <annotation> <documentation>ja, andere Lungenerkrankungen</documentation> </annotation> </enumeration> <enumeration value="0368099"> <annotation> <documentation>unbekannt</documentation> </annotation> </enumeration> </restriction> </simpleType></pre> | | | | | | | | | | | | | | | | | | |

simpleType enum_0369

| | |
|-----------|------------------------|
| namespace | http://xml.ir-d.de/stn |
|-----------|------------------------|

| type | restriction of string | | | | | | | | | | | | |
|-------------|---|----------------------------|-------|------------|-------------|---------|-----------------------|-------------|---------|-----------------------|-------------|---------|----------------------------|
| properties | base xs:string | | | | | | | | | | | | |
| facets | <table border="1"> <thead> <tr> <th>Kind</th> <th>Value</th> <th>Annotation</th> </tr> </thead> <tbody> <tr> <td>enumeration</td> <td>0369001</td> <td>documentation nein</td> </tr> <tr> <td>enumeration</td> <td>0369002</td> <td>documentation akut</td> </tr> <tr> <td>enumeration</td> <td>0369003</td> <td>documentation chronisch</td> </tr> </tbody> </table> | Kind | Value | Annotation | enumeration | 0369001 | documentation nein | enumeration | 0369002 | documentation akut | enumeration | 0369003 | documentation chronisch |
| Kind | Value | Annotation | | | | | | | | | | | |
| enumeration | 0369001 | documentation nein | | | | | | | | | | | |
| enumeration | 0369002 | documentation akut | | | | | | | | | | | |
| enumeration | 0369003 | documentation chronisch | | | | | | | | | | | |
| annotation | documentation Kat_AK_Nierenersatztherapie | | | | | | | | | | | | |
| source | <pre> <simpleType name="enum_0369"> <annotation> <documentation>Kat_AK_Nierenersatztherapie</documentation> </annotation> <restriction base="xs:string"> <enumeration value="0369001"> <annotation> <documentation>nein</documentation> </annotation> </enumeration> <enumeration value="0369002"> <annotation> <documentation>akut</documentation> </annotation> </enumeration> <enumeration value="0369003"> <annotation> <documentation>chronisch</documentation> </annotation> </enumeration> </restriction> </simpleType> </pre> | | | | | | | | | | | | |

simpleType **enum_0370**

| namespace | http://xml.ir-d.de/stn | | | | | | | | | | | | |
|-------------|---|------------------------------------|-------|------------|-------------|---------|------------------------------------|-------------|---------|-------------------------------|-------------|---------|-------------------------|
| type | restriction of string | | | | | | | | | | | | |
| properties | base xs:string | | | | | | | | | | | | |
| facets | <table border="1"> <thead> <tr> <th>Kind</th> <th>Value</th> <th>Annotation</th> </tr> </thead> <tbody> <tr> <td>enumeration</td> <td>0370001</td> <td>documentation Echokardiographie</td> </tr> <tr> <td>enumeration</td> <td>0370002</td> <td>documentation Herzkatheter</td> </tr> <tr> <td>enumeration</td> <td>0370042</td> <td>documentation andere</td> </tr> </tbody> </table> | Kind | Value | Annotation | enumeration | 0370001 | documentation Echokardiographie | enumeration | 0370002 | documentation Herzkatheter | enumeration | 0370042 | documentation andere |
| Kind | Value | Annotation | | | | | | | | | | | |
| enumeration | 0370001 | documentation Echokardiographie | | | | | | | | | | | |
| enumeration | 0370002 | documentation Herzkatheter | | | | | | | | | | | |
| enumeration | 0370042 | documentation andere | | | | | | | | | | | |
| annotation | documentation Kat_AK_AKOEFMessmethode | | | | | | | | | | | | |
| source | <pre> <simpleType name="enum_0370"> <annotation> <documentation>Kat_AK_AKOEFMessmethode</documentation> </annotation> <restriction base="xs:string"> <enumeration value="0370001"> <annotation> <documentation>Echokardiographie</documentation> </annotation> </enumeration> </restriction> </simpleType> </pre> | | | | | | | | | | | | |

| | |
|--|--|
| | <pre> </annotation> </enumeration> <enumeration value="0370002"> <annotation> <documentation>Herzkatheter</documentation> </annotation> </enumeration> <enumeration value="0370042"> <annotation> <documentation>andere</documentation> </annotation> </enumeration> </restriction> </simpleType> </pre> |
|--|--|

simpleType enum_0371

| | | | |
|------------|--|---------|----------------------------|
| namespace | http://xml.lir-d.de/stn | | |
| type | restriction of string | | |
| properties | base xs:string | | |
| facets | Kind | Value | Annotation |
| | enumeration | 0371001 | documentation keine |
| | enumeration | 0371002 | documentation leicht |
| | enumeration | 0371003 | documentation mittel |
| | enumeration | 0371004 | documentation schwer |
| | enumeration | 0371099 | documentation unbekannt |
| annotation | documentation Kat_AK_Verkalkungsgrad | | |
| source | <pre> <simpleType name="enum_0371"> <annotation> <documentation>Kat_AK_Verkalkungsgrad</documentation> </annotation> <restriction base="xs:string"> <enumeration value="0371001"> <annotation> <documentation>keine</documentation> </annotation> </enumeration> <enumeration value="0371002"> <annotation> <documentation>leicht</documentation> </annotation> </enumeration> <enumeration value="0371003"> <annotation> <documentation>mittel</documentation> </annotation> </enumeration> <enumeration value="0371004"> <annotation> <documentation>schwer</documentation> </annotation> </enumeration> </restriction> </simpleType> </pre> | | |

| | |
|--|---|
| | <pre> </enumeration> <enumeration value="0371099"> <annotation> <documentation>unbekannt</documentation> </annotation> </enumeration> </restriction> </simpleType> </pre> |
|--|---|

simpleType enum_0372

| | | | |
|------------|--|---------|---------------------------------|
| namespace | http://xml.ir-d.de/strn | | |
| type | restriction of string | | |
| properties | base xs:string | | |
| facets | Kind | Value | Annotation |
| | enumeration | 0372001 | documentation nein |
| | enumeration | 0372002 | documentation ja, bicuspide |
| | enumeration | 0372003 | documentation ja, unicuspide |
| | enumeration | 0372099 | documentation unbekannt |
| annotation | documentation Kat_AK_BiUnicuspideKlappe | | |
| source | <pre> <simpleType name="enum_0372"> <annotation> <documentation>Kat_AK_BiUnicuspideKlappe</documentation> </annotation> <restriction base="xs:string"> <enumeration value="0372001"> <annotation> <documentation>nein</documentation> </annotation> </enumeration> <enumeration value="0372002"> <annotation> <documentation>ja, bicuspide</documentation> </annotation> </enumeration> <enumeration value="0372003"> <annotation> <documentation>ja, unicuspide</documentation> </annotation> </enumeration> <enumeration value="0372099"> <annotation> <documentation>unbekannt</documentation> </annotation> </enumeration> </restriction> </simpleType> </pre> | | |

simpleType enum_0373

| | | | |
|------------|--|---------|-------------------------------|
| namespace | http://xml.ir-d.de/stn | | |
| type | restriction of string | | |
| properties | base xs:string | | |
| facets | Kind | Value | Annotation |
| | enumeration | 0373001 | documentation keine |
| | enumeration | 0373002 | documentation leichtgradig |
| | enumeration | 0373003 | documentation mittelgradig |
| | enumeration | 0373004 | documentation hochgradig |
| | enumeration | 0373099 | documentation unbekannt |
| annotation | documentation Kat_AK_Grad | | |
| source | <pre> <simpleType name="enum_0373"> <annotation> <documentation>Kat_AK_Grad</documentation> </annotation> <restriction base="xs:string"> <enumeration value="0373001"> <annotation> <documentation>keine</documentation> </annotation> </enumeration> <enumeration value="0373002"> <annotation> <documentation>leichtgradig</documentation> </annotation> </enumeration> <enumeration value="0373003"> <annotation> <documentation>mittelgradig</documentation> </annotation> </enumeration> <enumeration value="0373004"> <annotation> <documentation>hochgradig</documentation> </annotation> </enumeration> <enumeration value="0373099"> <annotation> <documentation>unbekannt</documentation> </annotation> </enumeration> </restriction> </simpleType> </pre> | | |

simpleType enum_0374

| | | | |
|------------|------------------------------|--|--|
| namespace | http://xml.ir-d.de/stn | | |
| type | restriction of string | | |
| properties | base xs:string | | |

| facets | <table border="1"> <thead> <tr> <th data-bbox="292 203 440 226">Kind</th> <th data-bbox="440 203 555 226">Value</th> <th data-bbox="555 203 1434 226">Annotation</th> </tr> </thead> <tbody> <tr> <td data-bbox="292 226 440 282">enumeration</td> <td data-bbox="440 226 555 282">0374001</td> <td data-bbox="555 226 1434 282">documentation nein</td> </tr> <tr> <td data-bbox="292 282 440 338">enumeration</td> <td data-bbox="440 282 555 338">0374002</td> <td data-bbox="555 282 1434 338">documentation ja, &lt;= 6 Stunden</td> </tr> <tr> <td data-bbox="292 338 440 394">enumeration</td> <td data-bbox="440 338 555 394">0374003</td> <td data-bbox="555 338 1434 394">documentation ja, &gt; 6 Stunden bis &lt;= 24 Stunden</td> </tr> <tr> <td data-bbox="292 394 440 450">enumeration</td> <td data-bbox="440 394 555 450">0374004</td> <td data-bbox="555 394 1434 450">documentation ja, &gt; 1 bis 7 Tage</td> </tr> <tr> <td data-bbox="292 450 440 506">enumeration</td> <td data-bbox="440 450 555 506">0374005</td> <td data-bbox="555 450 1434 506">documentation ja, &gt; 7 bis 21 Tage</td> </tr> <tr> <td data-bbox="292 506 440 562">enumeration</td> <td data-bbox="440 506 555 562">0374006</td> <td data-bbox="555 506 1434 562">documentation ja, &gt; 21 Tage</td> </tr> <tr> <td data-bbox="292 562 440 618">enumeration</td> <td data-bbox="440 562 555 618">0374099</td> <td data-bbox="555 562 1434 618">documentation unbekannt</td> </tr> </tbody> </table> | Kind | Value | Annotation | enumeration | 0374001 | documentation nein | enumeration | 0374002 | documentation ja, <= 6 Stunden | enumeration | 0374003 | documentation ja, > 6 Stunden bis <= 24 Stunden | enumeration | 0374004 | documentation ja, > 1 bis 7 Tage | enumeration | 0374005 | documentation ja, > 7 bis 21 Tage | enumeration | 0374006 | documentation ja, > 21 Tage | enumeration | 0374099 | documentation unbekannt |
|-------------|---|--|-------|------------|-------------|---------|-----------------------|-------------|---------|--------------------------------------|-------------|---------|--|-------------|---------|--|-------------|---------|---|-------------|---------|-----------------------------------|-------------|---------|----------------------------|
| Kind | Value | Annotation | | | | | | | | | | | | | | | | | | | | | | | |
| enumeration | 0374001 | documentation nein | | | | | | | | | | | | | | | | | | | | | | | |
| enumeration | 0374002 | documentation ja, <= 6 Stunden | | | | | | | | | | | | | | | | | | | | | | | |
| enumeration | 0374003 | documentation ja, > 6 Stunden bis <= 24 Stunden | | | | | | | | | | | | | | | | | | | | | | | |
| enumeration | 0374004 | documentation ja, > 1 bis 7 Tage | | | | | | | | | | | | | | | | | | | | | | | |
| enumeration | 0374005 | documentation ja, > 7 bis 21 Tage | | | | | | | | | | | | | | | | | | | | | | | |
| enumeration | 0374006 | documentation ja, > 21 Tage | | | | | | | | | | | | | | | | | | | | | | | |
| enumeration | 0374099 | documentation unbekannt | | | | | | | | | | | | | | | | | | | | | | | |
| annotation | documentation Kat_AK_InfarktAnamnese | | | | | | | | | | | | | | | | | | | | | | | | |
| source | <pre data-bbox="280 685 1426 1991"> <simpleType name="enum_0374"> <annotation> <documentation>Kat_AK_InfarktAnamnese</documentation> </annotation> <restriction base="xs:string"> <enumeration value="0374001"> <annotation> <documentation>nein</documentation> </annotation> </enumeration> <enumeration value="0374002"> <annotation> <documentation>ja, &lt;= 6 Stunden</documentation> </annotation> </enumeration> <enumeration value="0374003"> <annotation> <documentation>ja, &gt; 6 Stunden bis &lt;= 24 Stunden</documentation> </annotation> </enumeration> <enumeration value="0374004"> <annotation> <documentation>ja, &gt; 1 bis 7 Tage</documentation> </annotation> </enumeration> <enumeration value="0374005"> <annotation> <documentation>ja, &gt; 7 bis 21 Tage</documentation> </annotation> </enumeration> <enumeration value="0374006"> <annotation> <documentation>ja, &gt; 21 Tage</documentation> </annotation> </enumeration> <enumeration value="0374099"> <annotation> <documentation>unbekannt</documentation> </annotation> </enumeration> </restriction> </simpleType> </pre> | | | | | | | | | | | | | | | | | | | | | | | | |

simpleType enum_0375

| | | | |
|------------|--|---------|---|
| namespace | http://xml.ir-d.de/stn | | |
| type | restriction of string | | |
| properties | base xs:string | | |
| facets | Kind | Value | Annotation |
| | enumeration | 0375001 | documentation keine Symptome oder Angina |
| | enumeration | 0375002 | documentation Symptome, aber keine Ischämiezeichen |
| | enumeration | 0375003 | documentation stabile Angina |
| | enumeration | 0375004 | documentation instabile Angina |
| | enumeration | 0375005 | documentation Infarkt ohne ST-Hebung (Non-STEMI) |
| | enumeration | 0375006 | documentation Infarkt mit ST-Hebung (STEMI) |
| | enumeration | 0375042 | documentation unbekannt |
| annotation | documentation Kat_AK_KardialeSymptome | | |
| source | <pre> <simpleType name="enum_0375"> <annotation> <documentation>Kat_AK_KardialeSymptome</documentation> </annotation> <restriction base="xs:string"> <enumeration value="0375001"> <annotation> <documentation>keine Symptome oder Angina</documentation> </annotation> </enumeration> <enumeration value="0375002"> <annotation> <documentation>Symptome, aber keine Ischämiezeichen</documentation> </annotation> </enumeration> <enumeration value="0375003"> <annotation> <documentation>stabile Angina</documentation> </annotation> </enumeration> <enumeration value="0375004"> <annotation> <documentation>instabile Angina</documentation> </annotation> </enumeration> <enumeration value="0375005"> <annotation> <documentation>Infarkt ohne ST-Hebung (Non-STEMI)</documentation> </annotation> </enumeration> <enumeration value="0375006"> <annotation> <documentation>Infarkt mit ST-Hebung (STEMI)</documentation> </annotation> </enumeration> <enumeration value="0375042"> </pre> | | |

| | |
|--|--|
| | <pre> <annotation> <documentation>unbekannt</documentation> </annotation> </enumeration> </restriction> </simpleType> </pre> |
|--|--|

simpleType enum_0376

| | | | |
|------------|--|---------|---|
| namespace | http://xml.ir-d.de/stn | | |
| type | restriction of string | | |
| properties | base xs:string | | |
| facets | Kind | Value | Annotation |
| | enumeration | 0376001 | documentation nein |
| | enumeration | 0376002 | documentation ja, ZNS, zerebrovaskuläre Blutung |
| | enumeration | 0376003 | documentation ja, ZNS, zerebrovaskuläre Ischämie |
| | enumeration | 0376042 | documentation ja, ZNS, andere |
| annotation | documentation Kat_AK_Schlaganfall | | |
| source | <pre> <simpleType name="enum_0376"> <annotation> <documentation>Kat_AK_Schlaganfall</documentation> </annotation> <restriction base="xs:string"> <enumeration value="0376001"> <annotation> <documentation>nein</documentation> </annotation> </enumeration> <enumeration value="0376002"> <annotation> <documentation>ja, ZNS, zerebrovaskuläre Blutung</documentation> </annotation> </enumeration> <enumeration value="0376003"> <annotation> <documentation>ja, ZNS, zerebrovaskuläre Ischämie</documentation> </annotation> </enumeration> <enumeration value="0376042"> <annotation> <documentation>ja, ZNS, andere</documentation> </annotation> </enumeration> </restriction> </simpleType> </pre> | | |

simpleType enum_0377

| | |
|-----------|------------------------------|
| namespace | http://xml.ir-d.de/stn |
| type | restriction of string |

| properties | base xs:string | | | | | | | | | | | | |
|-------------|---|---|-------|------------|-------------|---------|---|-------------|---------|--|-------------|---------|---|
| facets | <table border="1"> <thead> <tr> <th>Kind</th> <th>Value</th> <th>Annotation</th> </tr> </thead> <tbody> <tr> <td>enumeration</td> <td>0377001</td> <td>documentation ja, mild neurological dysfunction: NIHSS 0-5</td> </tr> <tr> <td>enumeration</td> <td>0377002</td> <td>documentation ja, moderate neurological dysfunction: NIHSS 6-14</td> </tr> <tr> <td>enumeration</td> <td>0377003</td> <td>documentation ja, severe neurological dysfunction: NIHSS &gt;=15</td> </tr> </tbody> </table> | Kind | Value | Annotation | enumeration | 0377001 | documentation ja, mild neurological dysfunction: NIHSS 0-5 | enumeration | 0377002 | documentation ja, moderate neurological dysfunction: NIHSS 6-14 | enumeration | 0377003 | documentation ja, severe neurological dysfunction: NIHSS >=15 |
| Kind | Value | Annotation | | | | | | | | | | | |
| enumeration | 0377001 | documentation ja, mild neurological dysfunction: NIHSS 0-5 | | | | | | | | | | | |
| enumeration | 0377002 | documentation ja, moderate neurological dysfunction: NIHSS 6-14 | | | | | | | | | | | |
| enumeration | 0377003 | documentation ja, severe neurological dysfunction: NIHSS >=15 | | | | | | | | | | | |
| annotation | documentation Kat AK Nihss | | | | | | | | | | | | |
| source | <pre> <simpleType name="enum_0377"> <annotation> <documentation>Kat_AK_Nihss</documentation> </annotation> <restriction base="xs:string"> <enumeration value="0377001"> <annotation> <documentation>ja, mild neurological dysfunction: NIHSS 0-5</documentation> </annotation> </enumeration> <enumeration value="0377002"> <annotation> <documentation>ja, moderate neurological dysfunction: NIHSS 6-14</documentation> </annotation> </enumeration> <enumeration value="0377003"> <annotation> <documentation> ja, severe neurological dysfunction: NIHSS &gt;=15</documentation> </annotation> </enumeration> </restriction> </simpleType> </pre> | | | | | | | | | | | | |

simpleType enum_0378

| namespace | http://xml.ir-d.de/strn | | | | | | | | | | | | | | | |
|-------------|--|--|-------|------------|-------------|---------|-----------------------|-------------|---------|--|-------------|---------|--|-------------|---------|--|
| type | restriction of string | | | | | | | | | | | | | | | |
| properties | base xs:string | | | | | | | | | | | | | | | |
| facets | <table border="1"> <thead> <tr> <th>Kind</th> <th>Value</th> <th>Annotation</th> </tr> </thead> <tbody> <tr> <td>enumeration</td> <td>0378001</td> <td>documentation nein</td> </tr> <tr> <td>enumeration</td> <td>0378002</td> <td>documentation ja, &lt; 48h gemäss VARC-3-Definition</td> </tr> <tr> <td>enumeration</td> <td>0378003</td> <td>documentation ja, &gt;= 48h - &lt;= 72h gemäß VARC-3-Definition</td> </tr> <tr> <td>enumeration</td> <td>0378004</td> <td>documentation ja, &gt; 72 h gemäß VARC-3 Definition</td> </tr> </tbody> </table> | Kind | Value | Annotation | enumeration | 0378001 | documentation nein | enumeration | 0378002 | documentation ja, < 48h gemäss VARC-3-Definition | enumeration | 0378003 | documentation ja, >= 48h - <= 72h gemäß VARC-3-Definition | enumeration | 0378004 | documentation ja, > 72 h gemäß VARC-3 Definition |
| Kind | Value | Annotation | | | | | | | | | | | | | | |
| enumeration | 0378001 | documentation nein | | | | | | | | | | | | | | |
| enumeration | 0378002 | documentation ja, < 48h gemäss VARC-3-Definition | | | | | | | | | | | | | | |
| enumeration | 0378003 | documentation ja, >= 48h - <= 72h gemäß VARC-3-Definition | | | | | | | | | | | | | | |
| enumeration | 0378004 | documentation ja, > 72 h gemäß VARC-3 Definition | | | | | | | | | | | | | | |
| annotation | documentation Kat_AK_Myokardinfarkt | | | | | | | | | | | | | | | |
| source | <pre> <simpleType name="enum_0378"> <annotation> <documentation>Kat_AK_Myokardinfarkt</documentation> </annotation> <restriction base="xs:string"> </pre> | | | | | | | | | | | | | | | |

| | |
|--|--|
| | <pre> <enumeration value="0378001"> <annotation> <documentation>nein</documentation> </annotation> </enumeration> <enumeration value="0378002"> <annotation> <documentation>ja, &lt; 48h gemäss VARC-3-Definition</documentation> </annotation> </enumeration> <enumeration value="0378003"> <annotation> <documentation>ja, &gt;= 48h - &lt;= 72h gemäß VARC-3-Definition</documentation> </annotation> </enumeration> <enumeration value="0378004"> <annotation> <documentation>ja, &gt; 72 h gemäß VARC-3 Definition</documentation> </annotation> </enumeration> </restriction> </simpleType> </pre> |
|--|--|

simpleType enum_0379

| | | | |
|------------|--|---------|--|
| namespace | http://xml.ir-d.de/stn | | |
| type | restriction of string | | |
| properties | base xs:string | | |
| facets | Kind | Value | Annotation |
| | enumeration | 0379001 | documentation Keine gefäss- oder zugangsassozierte Komplikationen |
| | enumeration | 0379002 | documentation Versagen des perkutanen Verschlusssystems |
| | enumeration | 0379003 | documentation Geringfügige Gefäßkomplikationen |
| | enumeration | 0379004 | documentation Erhebliche Gefäßkomplikationen |
| annotation | documentation Kat_AK_ZugangKomplikationen | | |
| source | <pre> <simpleType name="enum_0379"> <annotation> <documentation>Kat_AK_ZugangKomplikationen</documentation> </annotation> <restriction base="xs:string"> <enumeration value="0379001"> <annotation> <documentation>Keine gefäss- oder zugangsassozierte Komplikationen</documentation> </annotation> </enumeration> <enumeration value="0379002"> <annotation> <documentation>Versagen des perkutanen Verschlusssystems</documentation> </annotation> </enumeration> </restriction> </simpleType> </pre> | | |

| | |
|--|---|
| | <pre> <enumeration value="0379003"> <annotation> <documentation>Geringfügige Gefäßkomplikationen</documentation> </annotation> </enumeration> <enumeration value="0379004"> <annotation> <documentation>Erhebliche Gefäßkomplikationen</documentation> </annotation> </enumeration> </restriction> </simpleType> </pre> |
|--|---|

simpleType enum_0380

| | | | |
|------------|---|---------|--|
| namespace | http://xml.ir-d.de/stn | | |
| type | restriction of string | | |
| properties | base xs:string | | |
| facets | Kind | Value | Annotation |
| | enumeration | 0380001 | documentation nein |
| | enumeration | 0380002 | documentation ja, intraprozedural |
| | enumeration | 0380003 | documentation ja, postprozedural |
| | enumeration | 0380004 | documentation ja, Zeitpunkt nicht bekannt |
| annotation | documentation Kat_AK_Reanimation | | |
| source | <pre> <simpleType name="enum_0380"> <annotation> <documentation>Kat_AK_Reanimation</documentation> </annotation> <restriction base="xs:string"> <enumeration value="0380001"> <annotation> <documentation>nein</documentation> </annotation> </enumeration> <enumeration value="0380002"> <annotation> <documentation>ja, intraprozedural</documentation> </annotation> </enumeration> <enumeration value="0380003"> <annotation> <documentation>ja, postprozedural</documentation> </annotation> </enumeration> <enumeration value="0380004"> <annotation> <documentation>ja, Zeitpunkt nicht bekannt</documentation> </annotation> </enumeration> </restriction> </simpleType> </pre> | | |

simpleType enum 0381

| | | | |
|------------|---|---------|---|
| namespace | http://xml.ir-d.de/stn | | |
| type | restriction of string | | |
| properties | base xs:string | | |
| facets | Kind | Value | Annotation |
| | enumeration | 0381001 | documentation nein |
| | enumeration | 0381002 | documentation Thorakotomie/Rethorakotomie |
| | enumeration | 0381003 | documentation kathetergestützte Reintervention |
| | enumeration | 0381004 | documentation lokale Reinterventionen |
| | enumeration | 0381005 | documentation andere Reintervention |
| annotation | documentation Kat_AK_Massnahmen | | |
| source | <pre> <simpleType name="enum_0381"> <annotation> <documentation>Kat_AK_Massnahmen</documentation> </annotation> <restriction base="xs:string"> <enumeration value="0381001"> <annotation> <documentation>nein</documentation> </annotation> </enumeration> <enumeration value="0381002"> <annotation> <documentation>Thorakotomie/Rethorakotomie</documentation> </annotation> </enumeration> <enumeration value="0381003"> <annotation> <documentation>kathetergestützte Reintervention</documentation> </annotation> </enumeration> <enumeration value="0381004"> <annotation> <documentation>lokale Reinterventionen</documentation> </annotation> </enumeration> <enumeration value="0381005"> <annotation> <documentation>andere Reintervention</documentation> </annotation> </enumeration> </restriction> </simpleType> </pre> | | |

simpleType enum 0382

| | |
|-----------|------------------------|
| namespace | http://xml.ir-d.de/stn |
|-----------|------------------------|

| | | | |
|------------|---|---------|--|
| type | restriction of string | | |
| properties | base xs:string | | |
| facets | Kind | Value | Annotation |
| | enumeration | 0382001 | documentation keine Rethorakotomie / kein weiterer Grund |
| | enumeration | 0382002 | documentation Blutung/Hämatom |
| | enumeration | 0382003 | documentation Low Cardiac Output |
| | enumeration | 0382004 | documentation Tamponade |
| | enumeration | 0382005 | documentation Graftprobleme, Ischämie |
| | enumeration | 0382006 | documentation Wundinfektion, Mediastinitis |
| | enumeration | 0382007 | documentation Dissektion |
| | enumeration | 0382008 | documentation Prothesendysfunktion |
| | enumeration | 0382009 | documentation instabiles Sternum |
| | enumeration | 0382010 | documentation Chylothorax |
| | enumeration | 0382011 | documentation lokale Revision im Bereich des Zugangsweges |
| | enumeration | 0382042 | documentation anderer Grund |
| annotation | documentation Kat_AK_Komplikation | | |
| source | <pre> <simpleType name="enum_0382"> <annotation> <documentation>Kat_AK_Komplikation</documentation> </annotation> <restriction base="xs:string"> <enumeration value="0382001"> <annotation> <documentation>keine Rethorakotomie / kein weiterer Grund</documentation> </annotation> </enumeration> <enumeration value="0382002"> <annotation> <documentation>Blutung/Hämatom</documentation> </annotation> </enumeration> <enumeration value="0382003"> <annotation> <documentation>Low Cardiac Output</documentation> </annotation> </enumeration> <enumeration value="0382004"> <annotation> <documentation>Tamponade</documentation> </annotation> </enumeration> <enumeration value="0382005"> <annotation> <documentation>Graftprobleme, Ischämie</documentation> </annotation> </enumeration> </restriction> </pre> | | |

| | |
|--|--|
| | <pre> <enumeration value="0382006"> <annotation> <documentation>Wundinfektion, Mediastinitis</documentation> </annotation> </enumeration> <enumeration value="0382007"> <annotation> <documentation>Dissektion</documentation> </annotation> </enumeration> <enumeration value="0382008"> <annotation> <documentation>Prothesendysfunktion</documentation> </annotation> </enumeration> <enumeration value="0382009"> <annotation> <documentation>instabiles Sternum</documentation> </annotation> </enumeration> <enumeration value="0382010"> <annotation> <documentation>Chylothorax</documentation> </annotation> </enumeration> <enumeration value="0382011"> <annotation> <documentation>lokale Revision im Bereich des Zugangsweges</documentation> </annotation> </enumeration> <enumeration value="0382042"> <annotation> <documentation>anderer Grund</documentation> </annotation> </enumeration> </restriction> </simpleType> </pre> |
|--|--|

simpleType enum 0383

| | | | |
|------------|---|---------|--|
| namespace | http://xml.ir-d.de/stn | | |
| type | restriction of string | | |
| properties | base xs:string | | |
| facets | Kind | Value | Annotation |
| | enumeration | 0383001 | documentation nein |
| | enumeration | 0383002 | documentation ja, mit forcierter Atemtherapie |
| | enumeration | 0383003 | documentation ja, Reintubation oder längerfristige Beatmung |
| | enumeration | 0383004 | documentation ja, Tracheotomie |
| annotation | documentation Kat_AK_RespiratorischeInsuffizienz | | |
| source | <pre> <simpleType name="enum_0383"> <annotation> </pre> | | |

| | |
|--|--|
| | <pre> <documentation>Kat_AK_RespiratorischeInsuffizienz</documentation> </annotation> <restriction base="xs:string"> <enumeration value="0383001"> <annotation> <documentation>nein</documentation> </annotation> </enumeration> <enumeration value="0383002"> <annotation> <documentation>ja, mit forcierter Atemtherapie</documentation> </annotation> </enumeration> <enumeration value="0383003"> <annotation> <documentation>ja, Reintubation oder längerfristige Beatmung</documentation> </annotation> </enumeration> <enumeration value="0383004"> <annotation> <documentation>ja, Tracheotomie</documentation> </annotation> </enumeration> </restriction> </simpleType> </pre> |
|--|--|

simpleType enum_0384

| | | | |
|------------|---|---------|--|
| namespace | http://xml.ir-d.de/stn | | |
| type | restriction of string | | |
| properties | base xs:string | | |
| facets | Kind | Value | Annotation |
| | enumeration | 0384001 | documentation keine Blutungskomplikationen |
| | enumeration | 0384002 | documentation Geringfügige Blutung (Minor Bleeding - BARC type 2 or 3a) |
| | enumeration | 0384003 | documentation Starke Blutung (Major Bleeding - BARC type 3a) |
| | enumeration | 0384004 | documentation Lebensbedrohliche Blutung (Life-threatening or disabling bleeding - BARC type 3b or 3c or type 5) |
| annotation | documentation Kat_AK_Blutungskomplikation | | |
| source | <pre> <simpleType name="enum_0384"> <annotation> <documentation>Kat_AK_Blutungskomplikation</documentation> </annotation> <restriction base="xs:string"> <enumeration value="0384001"> <annotation> <documentation>keine Blutungskomplikationen</documentation> </annotation> </enumeration> <enumeration value="0384002"> <annotation> <documentation>Geringfügige Blutung (Minor Bleeding - BARC type 2 or </pre> | | |

| | |
|--|--|
| | <pre> 3a) </documentation> </annotation> </enumeration> <enumeration value="0384003"> <annotation> <documentation>Starke Blutung (Major Bleeding - BARC type 3a) </documentation> </annotation> </enumeration> <enumeration value="0384004"> <annotation> <documentation>Lebensbedrohliche Blutung (Life-threatening or disabling bleeding - BARC type 3b or 3c or type 5) </documentation> </annotation> </enumeration> </restriction> </simpleType> </pre> |
|--|--|

simpleType enum 0385

| | | | |
|------------|---|---------|---|
| namespace | http://xml.ir-d.de/stn | | |
| type | restriction of string | | |
| properties | base xs:string | | |
| facets | Kind | Value | Annotation |
| | enumeration | 0385001 | documentation Sinusrhythmus |
| | enumeration | 0385002 | documentation Vorhofflimmern |
| | enumeration | 0385003 | documentation Patient verstorben (kein Herzrhythmus) |
| | enumeration | 0385042 | documentation anderer Rhythmus |
| annotation | documentation Kat_AK_HerzrhythmusEntlassung | | |
| source | <pre> <simpleType name="enum_0385"> <annotation> <documentation>Kat_AK_HerzrhythmusEntlassung</documentation> </annotation> <restriction base="xs:string"> <enumeration value="0385001"> <annotation> <documentation>Sinusrhythmus</documentation> </annotation> </enumeration> <enumeration value="0385002"> <annotation> <documentation>Vorhofflimmern</documentation> </annotation> </enumeration> <enumeration value="0385003"> <annotation> <documentation>Patient verstorben (kein Herzrhythmus)</documentation> </annotation> </enumeration> <enumeration value="0385042"> <annotation> <documentation>anderer Rhythmus</documentation> </pre> | | |

```

</annotation>
</enumeration>
</restriction>
</simpleType>

```

simpleType enum_0388

| | | | |
|------------|--|---------|--|
| namespace | http://xml.ir-d.de/stn | | |
| type | restriction of string | | |
| properties | base xs:string | | |
| facets | Kind | Value | Annotation |
| | enumeration | 0388001 | documentation nein |
| | enumeration | 0388002 | documentation ASS |
| | enumeration | 0388003 | documentation ADP-Rezeptor-Antagonist |
| | enumeration | 0388004 | documentation Kombination ASS und ADP-Rezeptor-Antagonist |
| | enumeration | 0388042 | documentation ja, andere |
| | enumeration | 0388099 | documentation unbekannt |
| annotation | documentation Kat AK Plaettchenaggregationshemmer | | |
| source | <pre> <simpleType name="enum_0388"> <annotation> <documentation>Kat_AK_Plaettchenaggregationshemmer</documentation> </annotation> <restriction base="xs:string"> <enumeration value="0388001"> <annotation> <documentation>nein</documentation> </annotation> </enumeration> <enumeration value="0388002"> <annotation> <documentation>ASS</documentation> </annotation> </enumeration> <enumeration value="0388003"> <annotation> <documentation>ADP-Rezeptor-Antagonist</documentation> </annotation> </enumeration> <enumeration value="0388004"> <annotation> <documentation>Kombination ASS und ADP-Rezeptor-Antagonist</documentation> </annotation> </enumeration> <enumeration value="0388042"> <annotation> <documentation>ja, andere</documentation> </annotation> </enumeration> <enumeration value="0388099"> </pre> | | |

| | |
|--|--|
| | <pre> <annotation> <documentation>unbekannt</documentation> </annotation> </enumeration> </restriction> </simpleType> </pre> |
|--|--|

simpleType enum_0389

| | | | |
|------------|---|---------|---|
| namespace | http://xml.ir-d.de/stn | | |
| type | restriction of string | | |
| properties | base xs:string | | |
| facets | Kind | Value | Annotation |
| | enumeration | 0389001 | documentation nein |
| | enumeration | 0389002 | documentation Cumarin-Derivate |
| | enumeration | 0389003 | documentation Heparinoide |
| | enumeration | 0389004 | documentation orale Thrombinantagonisten |
| | enumeration | 0389005 | documentation Kombination Heparinoide und Cumarin-Derivate |
| | enumeration | 0389006 | documentation Direkte orale Antikoagulantien (DOAK / NOAK) |
| | enumeration | 0389042 | documentation ja, andere |
| | enumeration | 0389099 | documentation unbekannt |
| annotation | documentation Kat_AK_Antikoagulantien | | |
| source | <pre> <simpleType name="enum_0389"> <annotation> <documentation>Kat_AK_Antikoagulantien</documentation> </annotation> <restriction base="xs:string"> <enumeration value="0389001"> <annotation> <documentation>nein</documentation> </annotation> </enumeration> <enumeration value="0389002"> <annotation> <documentation>Cumarin-Derivate</documentation> </annotation> </enumeration> <enumeration value="0389003"> <annotation> <documentation>Heparinoide</documentation> </annotation> </enumeration> <enumeration value="0389004"> <annotation> <documentation>orale Thrombinantagonisten</documentation> </annotation> </enumeration> <enumeration value="0389005"> <annotation> </pre> | | |

| | |
|--|---|
| | <pre> <documentation>Kombination Heparinoide und Cumarin-Derivate</documentation> </annotation> </enumeration> <enumeration value="0389006"> <annotation> <documentation>Direkte orale Antikoagulantien (DOAK / NOAK)</documentation> </annotation> </enumeration> <enumeration value="0389042"> <annotation> <documentation>ja, andere</documentation> </annotation> </enumeration> <enumeration value="0389099"> <annotation> <documentation>unbekannt</documentation> </annotation> </enumeration> </restriction> </simpleType> </pre> |
|--|---|

simpleType enum_0390

| | | | |
|------------|--|---------|---|
| namespace | http://xml.ir-d.de/stn | | |
| type | restriction of string | | |
| properties | base xs:string | | |
| facets | Kind | Value | Annotation |
| | enumeration | 0390001 | documentation biologisches Klappenmodell |
| | enumeration | 0390002 | documentation mechanisches Klappenmodell |
| annotation | documentation Kat_AK_Artikeltyp | | |
| source | <pre> <simpleType name="enum_0390"> <annotation> <documentation>Kat_AK_Artikeltyp</documentation> </annotation> <restriction base="xs:string"> <enumeration value="0390001"> <annotation> <documentation>biologisches Klappenmodell</documentation> </annotation> </enumeration> <enumeration value="0390002"> <annotation> <documentation>mechanisches Klappenmodell</documentation> </annotation> </enumeration> </restriction> </simpleType> </pre> | | |

simpleType enum_0398

| | | | |
|------------|--|---------|--|
| namespace | http://xml.ir-d.de/stn | | |
| type | restriction of string | | |
| properties | base xs:string | | |
| facets | Kind | Value | Annotation |
| | enumeration | 0398001 | documentation kardiovaskuläre Ursache |
| | enumeration | 0398002 | documentation nicht-kardiovaskuläre Ursache |
| | enumeration | 0398099 | documentation Todesursache unbekannt |
| annotation | documentation Kat_AK_Todesursache | | |
| source | <pre> <simpleType name="enum_0398"> <annotation> <documentation>Kat_AK_Todesursache</documentation> </annotation> <restriction base="xs:string"> <enumeration value="0398001"> <annotation> <documentation>kardiovaskuläre Ursache</documentation> </annotation> </enumeration> <enumeration value="0398002"> <annotation> <documentation>nicht-kardiovaskuläre Ursache</documentation> </annotation> </enumeration> <enumeration value="0398099"> <annotation> <documentation>Todesursache unbekannt</documentation> </annotation> </enumeration> </restriction> </simpleType> </pre> | | |

simpleType enum_0399

| | | | |
|------------|---|---------|--|
| namespace | http://xml.ir-d.de/stn | | |
| type | restriction of string | | |
| properties | base xs:string | | |
| facets | Kind | Value | Annotation |
| | enumeration | 0399001 | documentation Patient lebt |
| | enumeration | 0399002 | documentation Patient im Krankenhaus verstorben |
| annotation | documentation Kat_AK_Vitalstatus | | |
| source | <pre> <simpleType name="enum_0399"> <annotation> <documentation>Kat_AK_Vitalstatus</documentation> </annotation> <restriction base="xs:string"> <enumeration value="0399001"> <annotation> </pre> | | |

| | |
|--|---|
| | <pre> <documentation>Patient lebt</documentation> </annotation> </enumeration> <enumeration value="0399002"> <annotation> <documentation>Patient im Krankenhaus verstorben</documentation> </annotation> </enumeration> </restriction> </simpleType> </pre> |
|--|---|

simpleType enum_0044

| | | | |
|------------|---|---------|---|
| namespace | http://xml.ir-d.de/irdma | | |
| type | restriction of string | | |
| properties | base xs:string | | |
| facets | Kind | Value | Annotation |
| | enumeration | 0044001 | documentation 1= normaler, sonst gesunder Patient |
| | enumeration | 0044002 | documentation 2= Patient mit leichter Allgemeinerkrankung |
| | enumeration | 0044003 | documentation 3= Patient mit schwerer Allgemeinerkrankung |
| | enumeration | 0044004 | documentation 4= Patient mit schwerer Allgemeinerkrankung, die eine ständige Lebensbedrohung darstellt |
| | enumeration | 0044005 | documentation 5= moribunder Patient, der ohne die Operation voraussichtlich nicht überleben wird |
| annotation | documentation Kat_ASA | | |
| source | <pre> <simpleType name="enum_0044"> <annotation> <documentation>Kat_ASA</documentation> </annotation> <restriction base="xs:string"> <enumeration value="0044001"> <annotation> <documentation>1= normaler, sonst gesunder Patient</documentation> </annotation> </enumeration> <enumeration value="0044002"> <annotation> <documentation>2= Patient mit leichter Allgemeinerkrankung</documentation> </annotation> </enumeration> <enumeration value="0044003"> <annotation> <documentation>3= Patient mit schwerer Allgemeinerkrankung</documentation> </annotation> </enumeration> <enumeration value="0044004"> <annotation> <documentation>4= Patient mit schwerer Allgemeinerkrankung, die eine ständige Lebensbedrohung darstellt</documentation> </annotation> </enumeration> <enumeration value="0044005"> <annotation> <documentation>5= moribunder Patient, der ohne die Operation voraussichtlich nicht überleben wird</documentation> </annotation> </enumeration> </restriction> </simpleType> </pre> | | |

| | |
|--|--|
| | <pre> </enumeration> <enumeration value="0044005"> <annotation> <documentation>5= moribunder Patient, der ohne die Operation voraussichtlich nicht überleben wird</documentation> </annotation> </enumeration> </restriction> </simpleType> </pre> |
|--|--|

simpleType enum_0050

| | | | |
|------------|---|---------|-------------------------|
| namespace | http://xml.ir-d.de/irdma | | |
| type | restriction of string | | |
| properties | base xs:string | | |
| facets | Kind | Value | Annotation |
| | enumeration | 0050001 | documentation rechts |
| | enumeration | 0050002 | documentation links |
| annotation | documentation Kat_RechtsLinks | | |
| source | <pre> <simpleType name="enum_0050"> <annotation> <documentation>Kat_RechtsLinks</documentation> </annotation> <restriction base="xs:string"> <enumeration value="0050001"> <annotation> <documentation>rechts</documentation> </annotation> </enumeration> <enumeration value="0050002"> <annotation> <documentation>links</documentation> </annotation> </enumeration> </restriction> </simpleType> </pre> | | |

simpleType enum_0060

| | | | |
|------------|---|---------|-----------------------|
| namespace | http://xml.ir-d.de/irdma | | |
| type | restriction of string | | |
| properties | base xs:string | | |
| facets | Kind | Value | Annotation |
| | enumeration | 0060001 | documentation ja |
| | enumeration | 0060002 | documentation nein |
| annotation | documentation Kat_JaNein | | |
| source | <pre> <simpleType name="enum_0060"> <annotation> </pre> | | |

| | |
|--|--|
| | <pre> <documentation>Kat_JaNein</documentation> </annotation> <restriction base="xs:string"> <enumeration value="0060001"> <annotation> <documentation>ja</documentation> </annotation> </enumeration> <enumeration value="0060002"> <annotation> <documentation>nein</documentation> </annotation> </enumeration> </restriction> </simpleType> </pre> |
|--|--|

simpleType enum_0061

| | | | |
|------------|---|---------|----------------------------|
| namespace | http://xml.lir-d.de/irdma | | |
| type | restriction of string | | |
| properties | base xs:string | | |
| facets | Kind | Value | Annotation |
| | enumeration | 0061001 | documentation ja |
| | enumeration | 0061002 | documentation nein |
| | enumeration | 0061099 | documentation unbekannt |
| annotation | documentation Kat_JaNeinUnbekannt | | |
| source | <pre> <simpleType name="enum_0061"> <annotation> <documentation>Kat_JaNeinUnbekannt</documentation> </annotation> <restriction base="xs:string"> <enumeration value="0061001"> <annotation> <documentation>ja</documentation> </annotation> </enumeration> <enumeration value="0061002"> <annotation> <documentation>nein</documentation> </annotation> </enumeration> <enumeration value="0061099"> <annotation> <documentation>unbekannt</documentation> </annotation> </enumeration> </restriction> </simpleType> </pre> | | |

simpleType enum_0062

| | | | |
|------------|---|---------|----------------------------------|
| namespace | http://xml.ir-d.de/irdma | | |
| type | restriction of string | | |
| properties | base xs:string | | |
| facets | Kind | Value | Annotation |
| | enumeration | 0062001 | documentation Stück |
| | enumeration | 0062002 | documentation g |
| | enumeration | 0062003 | documentation mg |
| | enumeration | 0062004 | documentation l |
| | enumeration | 0062005 | documentation ml |
| | enumeration | 0062006 | documentation cm ³ |
| | enumeration | 0062007 | documentation mm |
| | enumeration | 0062008 | documentation cm |
| | enumeration | 0062009 | documentation dm |
| | enumeration | 0062010 | documentation m |
| | enumeration | 0062042 | documentation andere |
| annotation | documentation Kat_Einheit | | |
| source | <pre> <simpleType name="enum_0062"> <annotation> <documentation>Kat_Einheit</documentation> </annotation> <restriction base="xs:string"> <enumeration value="0062001"> <annotation> <documentation>Stück</documentation> </annotation> </enumeration> <enumeration value="0062002"> <annotation> <documentation>g</documentation> </annotation> </enumeration> <enumeration value="0062003"> <annotation> <documentation>mg</documentation> </annotation> </enumeration> <enumeration value="0062004"> <annotation> <documentation>l</documentation> </annotation> </enumeration> <enumeration value="0062005"> <annotation> <documentation>ml</documentation> </annotation> </enumeration> </restriction> </simpleType> </pre> | | |

| | |
|--|--|
| | <pre> <enumeration value="0062006"> <annotation> <documentation>cm³</documentation> </annotation> </enumeration> <enumeration value="0062007"> <annotation> <documentation>mm</documentation> </annotation> </enumeration> <enumeration value="0062008"> <annotation> <documentation>cm</documentation> </annotation> </enumeration> <enumeration value="0062009"> <annotation> <documentation>dm</documentation> </annotation> </enumeration> <enumeration value="0062010"> <annotation> <documentation>m</documentation> </annotation> </enumeration> <enumeration value="0062042"> <annotation> <documentation>andere</documentation> </annotation> </enumeration> </restriction> </simpleType> </pre> |
|--|--|

simpleType enum_0065

| | | | |
|------------|--|---------|--------------------------------|
| namespace | http://xml.ir-d.de/irdma | | |
| type | restriction of string | | |
| properties | base xs:string | | |
| facets | Kind | Value | Annotation |
| | enumeration | 0065001 | documentation stationär |
| | enumeration | 0065002 | documentation teilstationär |
| | enumeration | 0065003 | documentation ambulant |
| annotation | documentation Kat_ArtAufenthalt | | |
| source | <pre> <simpleType name="enum_0065"> <annotation> <documentation>Kat_ArtAufenthalt</documentation> </annotation> <restriction base="xs:string"> <enumeration value="0065001"> <annotation> <documentation>stationär</documentation> </annotation> </enumeration> </pre> | | |

| | |
|--|--|
| | <pre> <enumeration value="0065002"> <annotation> <documentation>teilstationär</documentation> </annotation> </enumeration> <enumeration value="0065003"> <annotation> <documentation>ambulant</documentation> </annotation> </enumeration> </restriction> </simpleType> </pre> |
|--|--|

simpleType enum_0067

| | | | |
|------------|---|---------|----------------------------|
| namespace | http://xml.ir-d.de/irdma | | |
| type | restriction of string | | |
| properties | base xs:string | | |
| facets | Kind | Value | Annotation |
| | enumeration | 0067001 | documentation Implantat |
| | enumeration | 0067002 | documentation Explantat |
| annotation | documentation Kat_ArtArtikel | | |
| source | <pre> <simpleType name="enum_0067"> <annotation> <documentation>Kat_ArtArtikel</documentation> </annotation> <restriction base="xs:string"> <enumeration value="0067001"> <annotation> <documentation>Implantat</documentation> </annotation> </enumeration> <enumeration value="0067002"> <annotation> <documentation>Explantat</documentation> </annotation> </enumeration> </restriction> </simpleType> </pre> | | |

simpleType enum_0068

| | | | |
|------------|------------------------------|---------|---------------------------------|
| namespace | http://xml.ir-d.de/irdma | | |
| type | restriction of string | | |
| properties | base xs:string | | |
| facets | Kind | Value | Annotation |
| | enumeration | 0068001 | documentation UDI |
| | enumeration | 0068002 | documentation Referenz (REF) |
| | enumeration | 0068003 | documentation |

| | |
|------------|--|
| | enumeration 0068042 Katalognummer documentation sonstiger |
| annotation | documentation Kat_KennzeichenTyp |
| source | <pre> <simpleType name="enum_0068"> <annotation> <documentation>Kat_KennzeichenTyp</documentation> </annotation> <restriction base="xs:string"> <enumeration value="0068001"> <annotation> <documentation>UDI</documentation> </annotation> </enumeration> <enumeration value="0068002"> <annotation> <documentation>Referenz (REF)</documentation> </annotation> </enumeration> <enumeration value="0068003"> <annotation> <documentation>Katalognummer</documentation> </annotation> </enumeration> <enumeration value="0068042"> <annotation> <documentation>sonstiger</documentation> </annotation> </enumeration> </restriction> </simpleType> </pre> |

simpleType enum_0069

| | | | |
|------------|---|---------|----------------------------|
| namespace | http://xml.ir-d.de/irdma | | |
| type | restriction of string | | |
| properties | base xs:string | | |
| facets | Kind | Value | Annotation |
| | enumeration | 0069001 | documentation Implantat |
| | enumeration | 0069002 | documentation Explantat |
| annotation | documentation Kat_ArtZubehoer | | |
| source | <pre> <simpleType name="enum_0069"> <annotation> <documentation>Kat_ArtZubehoer</documentation> </annotation> <restriction base="xs:string"> <enumeration value="0069001"> <annotation> <documentation>Implantat</documentation> </annotation> </enumeration> <enumeration value="0069002"> <annotation> </pre> | | |

| | |
|--|---|
| | <pre> <documentation>Explantat</documentation> </annotation> </enumeration> </restriction> </simpleType> </pre> |
|--|---|

simpleType enum_0070

| | | | |
|------------|---|---------|--------------------------|
| namespace | http://xml.ir-d.de/irdma | | |
| type | restriction of string | | |
| properties | base xs:string | | |
| facets | Kind | Value | Annotation |
| | enumeration | 0070001 | documentation weiblich |
| | enumeration | 0070002 | documentation männlich |
| | enumeration | 0070003 | documentation divers |
| | enumeration | 0070042 | documentation unbestimmt |
| annotation | documentation Kat_Geschlecht | | |
| source | <pre> <simpleType name="enum_0070"> <annotation> <documentation>Kat_Geschlecht</documentation> </annotation> <restriction base="xs:string"> <enumeration value="0070001"> <annotation> <documentation>weiblich</documentation> </annotation> </enumeration> <enumeration value="0070002"> <annotation> <documentation>männlich</documentation> </annotation> </enumeration> <enumeration value="0070003"> <annotation> <documentation>divers</documentation> </annotation> </enumeration> <enumeration value="0070042"> <annotation> <documentation>unbestimmt</documentation> </annotation> </enumeration> </restriction> </simpleType> </pre> | | |

simpleType enum_0071

| | |
|-----------|------------------------------|
| namespace | http://xml.ir-d.de/irdma |
| type | restriction of string |

| properties | base xs:string | | | | | | | | | | | | |
|-------------|---|---|-------|------------|-------------|---------|----------------------------|-------------|---------|----------------------------|-------------|---------|---|
| facets | <table border="1"> <thead> <tr> <th>Kind</th> <th>Value</th> <th>Annotation</th> </tr> </thead> <tbody> <tr> <td>enumeration</td> <td>0071001</td> <td>documentation Implantat</td> </tr> <tr> <td>enumeration</td> <td>0071002</td> <td>documentation Explantat</td> </tr> <tr> <td>enumeration</td> <td>0071003</td> <td>documentation Degeneriertes/defektes Produkt, das funktionslos im Körper verbleibt</td> </tr> </tbody> </table> | Kind | Value | Annotation | enumeration | 0071001 | documentation Implantat | enumeration | 0071002 | documentation Explantat | enumeration | 0071003 | documentation Degeneriertes/defektes Produkt, das funktionslos im Körper verbleibt |
| Kind | Value | Annotation | | | | | | | | | | | |
| enumeration | 0071001 | documentation Implantat | | | | | | | | | | | |
| enumeration | 0071002 | documentation Explantat | | | | | | | | | | | |
| enumeration | 0071003 | documentation Degeneriertes/defektes Produkt, das funktionslos im Körper verbleibt | | | | | | | | | | | |
| annotation | documentation Kat ArtikelArtFunktion | | | | | | | | | | | | |
| source | <pre> <simpleType name="enum_0071"> <annotation> <documentation>Kat_ArtikelArtFunktion</documentation> </annotation> <restriction base="xs:string"> <enumeration value="0071001"> <annotation> <documentation>Implantat</documentation> </annotation> </enumeration> <enumeration value="0071002"> <annotation> <documentation>Explantat</documentation> </annotation> </enumeration> <enumeration value="0071003"> <annotation> <documentation>Degeneriertes/defektes Produkt, das funktionslos im Körper verbleibt</documentation> </annotation> </enumeration> </restriction> </simpleType> </pre> | | | | | | | | | | | | |

simpleType enum_0075

| namespace | http://xml.ir-d.de/irdma | | | | | | | | | | | | |
|-------------|---|----------------------------|-------|------------|-------------|---------|--------------------------|-------------|---------|----------------------------|-------------|---------|--------------------------|
| type | restriction of string | | | | | | | | | | | | |
| properties | base xs:string | | | | | | | | | | | | |
| facets | <table border="1"> <thead> <tr> <th>Kind</th> <th>Value</th> <th>Annotation</th> </tr> </thead> <tbody> <tr> <td>enumeration</td> <td>0075001</td> <td>documentation elektiv</td> </tr> <tr> <td>enumeration</td> <td>0075002</td> <td>documentation dringlich</td> </tr> <tr> <td>enumeration</td> <td>0075003</td> <td>documentation Notfall</td> </tr> </tbody> </table> | Kind | Value | Annotation | enumeration | 0075001 | documentation elektiv | enumeration | 0075002 | documentation dringlich | enumeration | 0075003 | documentation Notfall |
| Kind | Value | Annotation | | | | | | | | | | | |
| enumeration | 0075001 | documentation elektiv | | | | | | | | | | | |
| enumeration | 0075002 | documentation dringlich | | | | | | | | | | | |
| enumeration | 0075003 | documentation Notfall | | | | | | | | | | | |
| annotation | documentation Kat_Dringlichkeit | | | | | | | | | | | | |
| source | <pre> <simpleType name="enum_0075"> <annotation> <documentation>Kat_Dringlichkeit</documentation> </annotation> <restriction base="xs:string"> <enumeration value="0075001"> <annotation> <documentation>elektiv</documentation> </annotation> </enumeration> </restriction> </simpleType> </pre> | | | | | | | | | | | | |

| | |
|--|--|
| | <pre> </enumeration> <enumeration value="0075002"> <annotation> <documentation>dringlich</documentation> </annotation> </enumeration> <enumeration value="0075003"> <annotation> <documentation>Notfall</documentation> </annotation> </enumeration> </restriction> </simpleType> </pre> |
|--|--|

simpleType enum_0076

| | | | |
|------------|---|---------|---|
| namespace | http://xml.ir-d.de/irdma | | |
| type | restriction of string | | |
| properties | base xs:string | | |
| facets | Kind | Value | Annotation |
| | enumeration | 0076001 | documentation elektiv |
| | enumeration | 0076002 | documentation dringlich |
| | enumeration | 0076003 | documentation Notfall |
| | enumeration | 0076004 | documentation Notfall (Reanimation / ultima ratio) |
| annotation | documentation Kat_Dringlichkeit_Reanimation | | |
| source | <pre> <simpleType name="enum_0076"> <annotation> <documentation>Kat_Dringlichkeit_Reanimation</documentation> </annotation> <restriction base="xs:string"> <enumeration value="0076001"> <annotation> <documentation>elektiv</documentation> </annotation> </enumeration> <enumeration value="0076002"> <annotation> <documentation>dringlich</documentation> </annotation> </enumeration> <enumeration value="0076003"> <annotation> <documentation>Notfall</documentation> </annotation> </enumeration> <enumeration value="0076004"> <annotation> <documentation>Notfall (Reanimation / ultima ratio)</documentation> </annotation> </enumeration> </restriction> </simpleType> </pre> | | |

simpleType enum 0080

| | | | |
|------------|---|---------|--|
| namespace | http://xml.ir-d.de/irdma | | |
| type | restriction of string | | |
| properties | base xs:string | | |
| facets | Kind | Value | Annotation |
| | enumeration | 0080001 | documentation Endoprothese Hüfte/Knie |
| | enumeration | 0080002 | documentation Brustimplantat |
| | enumeration | 0080003 | documentation Aortenklappenprothese |
| annotation | documentation Kat_Implantattyp | | |
| source | <pre> <simpleType name="enum_0080"> <annotation> <documentation>Kat_Implantattyp</documentation> </annotation> <restriction base="xs:string"> <enumeration value="0080001"> <annotation> <documentation>Endoprothese Hüfte/Knie</documentation> </annotation> </enumeration> <enumeration value="0080002"> <annotation> <documentation>Brustimplantat</documentation> </annotation> </enumeration> <enumeration value="0080003"> <annotation> <documentation>Aortenklappenprothese</documentation> </annotation> </enumeration> </restriction> </simpleType> </pre> | | |

simpleType enum 0100

| | | | |
|------------|--|---------|--|
| namespace | http://xml.ir-d.de/irdma | | |
| type | restriction of string | | |
| properties | base xs:string | | |
| facets | Kind | Value | Annotation |
| | enumeration | 0100001 | documentation Primäreingriff |
| | enumeration | 0100002 | documentation Austausch Expander gegen dauerhaftes Brustimplantat |
| | enumeration | 0100003 | documentation Revision |
| | enumeration | 0100004 | documentation Nur Explantation |
| annotation | documentation Kat_Bl_ArtEingriff | | |
| source | <pre> <simpleType name="enum_0100"> </pre> | | |

| | |
|--|--|
| | <pre> <annotation> <documentation>Kat_BI_ArtEingriff</documentation> </annotation> <restriction base="xs:string"> <enumeration value="0100001"> <annotation> <documentation>Primäreingriff</documentation> </annotation> </enumeration> <enumeration value="0100002"> <annotation> <documentation>Austausch Expander gegen dauerhaftes Brustimplantat</documentation> </annotation> </enumeration> <enumeration value="0100003"> <annotation> <documentation>Revision</documentation> </annotation> </enumeration> <enumeration value="0100004"> <annotation> <documentation>Nur Explantation</documentation> </annotation> </enumeration> </restriction> </simpleType> </pre> |
|--|--|

simpleType enum_0102

| | | | |
|------------|---|---------|---|
| namespace | http://xml.ir-d.de/irdma | | |
| type | restriction of string | | |
| properties | base xs:string | | |
| facets | Kind | Value | Annotation |
| | enumeration | 0102001 | documentation kosmetische Augmentation |
| | enumeration | 0102002 | documentation Rekonstruktion, benigne |
| | enumeration | 0102003 | documentation Rekonstruktion nach Mastektomie aufgrund eines Karzinoms |
| | enumeration | 0102004 | documentation Rekonstruktion nach risikoreduzierender Mastektomie |
| annotation | documentation Kat_BI_GrundPrimaereingriff | | |
| source | <pre> <simpleType name="enum_0102"> <annotation> <documentation>Kat_BI_GrundPrimaereingriff</documentation> </annotation> <restriction base="xs:string"> <enumeration value="0102001"> <annotation> <documentation>kosmetische Augmentation</documentation> </annotation> </enumeration> <enumeration value="0102002"> <annotation> <documentation>Rekonstruktion, benigne</documentation> </annotation> </enumeration> </restriction> </simpleType> </pre> | | |

| | |
|--|---|
| | <pre> </annotation> </enumeration> <enumeration value="0102003"> <annotation> <documentation>Rekonstruktion nach Mastektomie aufgrund eines Karzinoms</documentation> </annotation> </enumeration> <enumeration value="0102004"> <annotation> <documentation>Rekonstruktion nach risikoreduzierender Mastektomie</documentation> </annotation> </enumeration> </restriction> </simpleType> </pre> |
|--|---|

simpleType enum_0103

| | | | |
|------------|--|---------|---|
| namespace | http://xml.ir-d.de/irdma | | |
| type | restriction of string | | |
| properties | base xs:string | | |
| facets | Kind | Value | Annotation |
| | enumeration | 0103001 | documentation simultane Lappendeckung |
| | enumeration | 0103002 | documentation simultane Eigenfetttransplantation |
| | enumeration | 0103003 | documentation simultane Mastopexie |
| | enumeration | 0103005 | documentation simultane Mastektomie, Ablatio / hautsparend |
| | enumeration | 0103006 | documentation simultane Mastektomie, nippelerhaltend |
| | enumeration | 0103007 | documentation Axilla-Dissektion |
| | enumeration | 0103008 | documentation Drainage |
| annotation | documentation Kat_BI_OperationsdetailPrimaereingriff | | |
| source | <pre> <simpleType name="enum_0103"> <annotation> <documentation>Kat_BI_OperationsdetailPrimaereingriff</documentation> </annotation> <restriction base="xs:string"> <enumeration value="0103001"> <annotation> <documentation>simultane Lappendeckung</documentation> </annotation> </enumeration> <enumeration value="0103002"> <annotation> <documentation>simultane Eigenfetttransplantation</documentation> </annotation> </enumeration> <enumeration value="0103003"> <annotation> <documentation>simultane Mastopexie</documentation> </pre> | | |

| | |
|--|---|
| | <pre> </annotation> </enumeration> <enumeration value="0103005"> <annotation> <documentation>simultane Mastektomie, Ablatio / hautsparend</documentation> </annotation> </enumeration> <enumeration value="0103006"> <annotation> <documentation>simultane Mastektomie, nippelerhaltend</documentation> </annotation> </enumeration> <enumeration value="0103007"> <annotation> <documentation>Axilla-Dissektion</documentation> </annotation> </enumeration> <enumeration value="0103008"> <annotation> <documentation>Drainage</documentation> </annotation> </enumeration> </restriction> </simpleType> </pre> |
|--|---|

simpleType enum_0104

| | | | |
|------------|---|---------|--|
| namespace | http://xml.ir-d.de/irdma | | |
| type | restriction of string | | |
| properties | base xs:string | | |
| facets | Kind | Value | Annotation |
| | enumeration | 0104001 | documentation Austausch Expander gegen dauerhaftes Brustimplantat |
| annotation | documentation Kat_BI_GrundAustausch | | |
| source | <pre> <simpleType name="enum_0104"> <annotation> <documentation>Kat_BI_GrundAustausch</documentation> </annotation> <restriction base="xs:string"> <enumeration value="0104001"> <annotation> <documentation>Austausch Expander gegen dauerhaftes Brustimplantat</documentation> </annotation> </enumeration> </restriction> </simpleType> </pre> | | |

simpleType enum_0105

| | |
|-----------|------------------------------|
| namespace | http://xml.ir-d.de/irdma |
| type | restriction of string |

| properties | base xs:string | | | | | | | | | | | | | | | | | | | | | | | | |
|-------------|---|---|-------|------------|-------------|---------|--|-------------|---------|---|-------------|---------|---------------------------------------|-------------|---------|---------------------------|-------------|---------|--|-------------|---------|--|-------------|---------|----------------------------|
| facets | <table border="1"> <thead> <tr> <th>Kind</th> <th>Value</th> <th>Annotation</th> </tr> </thead> <tbody> <tr> <td>enumeration</td> <td>0105001</td> <td>documentation simultane Lappendeckung</td> </tr> <tr> <td>enumeration</td> <td>0105002</td> <td>documentation simultane Eigenfetttransplantation</td> </tr> <tr> <td>enumeration</td> <td>0105003</td> <td>documentation simultane Mastopexie</td> </tr> <tr> <td>enumeration</td> <td>0105008</td> <td>documentation Drainage</td> </tr> <tr> <td>enumeration</td> <td>0105009</td> <td>documentation Kapsulektomie, komplett</td> </tr> <tr> <td>enumeration</td> <td>0105010</td> <td>documentation Kapsulektomie, partiell</td> </tr> <tr> <td>enumeration</td> <td>0105011</td> <td>documentation Neopocket</td> </tr> </tbody> </table> | Kind | Value | Annotation | enumeration | 0105001 | documentation simultane Lappendeckung | enumeration | 0105002 | documentation simultane Eigenfetttransplantation | enumeration | 0105003 | documentation simultane Mastopexie | enumeration | 0105008 | documentation Drainage | enumeration | 0105009 | documentation Kapsulektomie, komplett | enumeration | 0105010 | documentation Kapsulektomie, partiell | enumeration | 0105011 | documentation Neopocket |
| Kind | Value | Annotation | | | | | | | | | | | | | | | | | | | | | | | |
| enumeration | 0105001 | documentation simultane Lappendeckung | | | | | | | | | | | | | | | | | | | | | | | |
| enumeration | 0105002 | documentation simultane Eigenfetttransplantation | | | | | | | | | | | | | | | | | | | | | | | |
| enumeration | 0105003 | documentation simultane Mastopexie | | | | | | | | | | | | | | | | | | | | | | | |
| enumeration | 0105008 | documentation Drainage | | | | | | | | | | | | | | | | | | | | | | | |
| enumeration | 0105009 | documentation Kapsulektomie, komplett | | | | | | | | | | | | | | | | | | | | | | | |
| enumeration | 0105010 | documentation Kapsulektomie, partiell | | | | | | | | | | | | | | | | | | | | | | | |
| enumeration | 0105011 | documentation Neopocket | | | | | | | | | | | | | | | | | | | | | | | |
| annotation | documentation Kat_BI_OperationsdetailAustausch | | | | | | | | | | | | | | | | | | | | | | | | |
| source | <pre> <simpleType name="enum_0105"> <annotation> <documentation>Kat_BI_OperationsdetailAustausch</documentation> </annotation> <restriction base="xs:string"> <enumeration value="0105001"> <annotation> <documentation>simultane Lappendeckung</documentation> </annotation> </enumeration> <enumeration value="0105002"> <annotation> <documentation>simultane Eigenfetttransplantation</documentation> </annotation> </enumeration> <enumeration value="0105003"> <annotation> <documentation>simultane Mastopexie</documentation> </annotation> </enumeration> <enumeration value="0105008"> <annotation> <documentation>Drainage</documentation> </annotation> </enumeration> <enumeration value="0105009"> <annotation> <documentation>Kapsulektomie, komplett</documentation> </annotation> </enumeration> <enumeration value="0105010"> <annotation> <documentation>Kapsulektomie, partiell</documentation> </annotation> </enumeration> <enumeration value="0105011"> <annotation> <documentation>Neopocket</documentation> </annotation> </enumeration> </restriction> </pre> | | | | | | | | | | | | | | | | | | | | | | | | |

| | |
|--|----------------------------------|
| | <code></simpleType></code> |
|--|----------------------------------|

simpleType enum_0106

| | | | |
|------------|--|---------|----------------------------------|
| namespace | http://xml.ir-d.de/irdma | | |
| type | restriction of string | | |
| properties | base xs:string | | |
| facets | Kind | Value | Annotation |
| | enumeration | 0106001 | documentation Patientenwunsch |
| | enumeration | 0106002 | documentation asymptomatisch |
| | enumeration | 0106003 | documentation Komplikation |
| annotation | documentation Kat_BI_GrundRevisionExplantation | | |
| source | <pre> <simpleType name="enum_0106"> <annotation> <documentation>Kat_BI_GrundRevisionExplantation</documentation> </annotation> <restriction base="xs:string"> <enumeration value="0106001"> <annotation> <documentation>Patientenwunsch</documentation> </annotation> </enumeration> <enumeration value="0106002"> <annotation> <documentation>asymptomatisch</documentation> </annotation> </enumeration> <enumeration value="0106003"> <annotation> <documentation>Komplikation</documentation> </annotation> </enumeration> </restriction> </simpleType> </pre> | | |

simpleType enum_0107

| | | | |
|------------|------------------------------|---------|---|
| namespace | http://xml.ir-d.de/irdma | | |
| type | restriction of string | | |
| properties | base xs:string | | |
| facets | Kind | Value | Annotation |
| | enumeration | 0107001 | documentation simultane Lappendeckung |
| | enumeration | 0107002 | documentation simultane Eigenfetttransplantation |
| | enumeration | 0107003 | documentation simultane Mastopexie |
| | enumeration | 0107005 | documentation simultane Mastektomie, Ablatio / hautsparend |
| | enumeration | 0107006 | documentation simultane Mastektomie, nippelerhaltend |

| | |
|------------|---|
| | <p>enumeration 0107007 documentation Axilla-Dissektion</p> <p>enumeration 0107008 documentation Drainage</p> <p>enumeration 0107009 documentation Kapsulektomie, komplett</p> <p>enumeration 0107010 documentation Kapsulektomie, partiell</p> <p>enumeration 0107011 documentation Neopocket</p> |
| annotation | <p>documentation Kat_BI_OperationsdetailRevision</p> |
| source | <pre> <simpleType name="enum_0107"> <annotation> <documentation>Kat_BI_OperationsdetailRevision</documentation> </annotation> <restriction base="xs:string"> <enumeration value="0107001"> <annotation> <documentation>simultane Lappendeckung</documentation> </annotation> </enumeration> <enumeration value="0107002"> <annotation> <documentation>simultane Eigenfetttransplantation</documentation> </annotation> </enumeration> <enumeration value="0107003"> <annotation> <documentation>simultane Mastopexie</documentation> </annotation> </enumeration> <enumeration value="0107005"> <annotation> <documentation>simultane Mastektomie, Ablatio / hautsparend</documentation> </annotation> </enumeration> <enumeration value="0107006"> <annotation> <documentation>simultane Mastektomie, nippelerhaltend</documentation> </annotation> </enumeration> <enumeration value="0107007"> <annotation> <documentation>Axilla-Dissektion</documentation> </annotation> </enumeration> <enumeration value="0107008"> <annotation> <documentation>Drainage</documentation> </annotation> </enumeration> <enumeration value="0107009"> <annotation> <documentation>Kapsulektomie, komplett</documentation> </annotation> </enumeration> <enumeration value="0107010"> <annotation> </pre> |

| | |
|--|--|
| | <pre> <documentation>Kapsulektomie, partiell</documentation> </annotation> </enumeration> <enumeration value="0107011"> <annotation> <documentation>Neopocket</documentation> </annotation> </enumeration> </restriction> </simpleType> </pre> |
|--|--|

simpleType enum_0110

| | | | |
|------------|---|---------|------------------------------|
| namespace | http://xml.ir-d.de/irdma | | |
| type | restriction of string | | |
| properties | base xs:string | | |
| facets | Kind | Value | Annotation |
| | enumeration | 0110001 | documentation Bestrahlung |
| annotation | documentation Kat_BI_VorbehandlungLokal | | |
| source | <pre> <simpleType name="enum_0110"> <annotation> <documentation>Kat_BI_VorbehandlungLokal</documentation> </annotation> <restriction base="xs:string"> <enumeration value="0110001"> <annotation> <documentation>Bestrahlung</documentation> </annotation> </enumeration> </restriction> </simpleType> </pre> | | |

simpleType enum_0111

| | | | |
|------------|--|---------|--|
| namespace | http://xml.ir-d.de/irdma | | |
| type | restriction of string | | |
| properties | base xs:string | | |
| facets | Kind | Value | Annotation |
| | enumeration | 0111001 | documentation nein |
| | enumeration | 0111002 | documentation Lipofilling |
| | enumeration | 0111003 | documentation Eigengewebsrekonstruktion |
| annotation | documentation Kat_BI_Verfahrenswechsel | | |
| source | <pre> <simpleType name="enum_0111"> <annotation> <documentation>Kat_BI_Verfahrenswechsel</documentation> </annotation> <restriction base="xs:string"> <enumeration value="0111001"> </pre> | | |

| | |
|--|---|
| | <pre> <annotation> <documentation>nein</documentation> </annotation> </enumeration> <enumeration value="0111002"> <annotation> <documentation>Lipofilling</documentation> </annotation> </enumeration> <enumeration value="0111003"> <annotation> <documentation>Eigengewebsrekonstruktion</documentation> </annotation> </enumeration> </restriction> </simpleType> </pre> |
|--|---|

simpleType enum_0112

| | | | |
|------------|--|---------|---|
| namespace | http://xml.ir-d.de/irdma | | |
| type | restriction of string | | |
| properties | base xs:string | | |
| facets | Kind | Value | Annotation |
| | enumeration | 0112001 | documentation subglandulär / epipektoral |
| | enumeration | 0112002 | documentation subpektoral |
| | enumeration | 0112003 | documentation subfaszial |
| | enumeration | 0112004 | documentation sub-flap |
| | enumeration | 0112005 | documentation subkutan |
| | enumeration | 0112006 | documentation dual plane |
| | enumeration | 0112042 | documentation andere |
| annotation | documentation Kat_BI_LageImplantat | | |
| source | <pre> <simpleType name="enum_0112"> <annotation> <documentation>Kat_BI_LageImplantat</documentation> </annotation> <restriction base="xs:string"> <enumeration value="0112001"> <annotation> <documentation>subglandulär / epipektoral</documentation> </annotation> </enumeration> <enumeration value="0112002"> <annotation> <documentation>subpektoral</documentation> </annotation> </enumeration> <enumeration value="0112003"> <annotation> <documentation>subfaszial</documentation> </pre> | | |

| | |
|--|--|
| | <pre> </annotation> </enumeration> <enumeration value="0112004"> <annotation> <documentation>sub-flap</documentation> </annotation> </enumeration> <enumeration value="0112005"> <annotation> <documentation>subkutan</documentation> </annotation> </enumeration> <enumeration value="0112006"> <annotation> <documentation>dual plane</documentation> </annotation> </enumeration> <enumeration value="0112042"> <annotation> <documentation>andere</documentation> </annotation> </enumeration> </restriction> </simpleType> </pre> |
|--|--|

simpleType enum_0113

| | | | |
|------------|--|---------|--|
| namespace | http://xml.ir-d.de/irdma | | |
| type | restriction of string | | |
| properties | base xs:string | | |
| facets | Kind | Value | Annotation |
| | enumeration | 0113001 | documentation Chemotherapie innerhalb der letzten drei Monate |
| annotation | documentation Kat_BI_VorbehandlungSystemisch | | |
| source | <pre> <simpleType name="enum_0113"> <annotation> <documentation>Kat_BI_VorbehandlungSystemisch</documentation> </annotation> <restriction base="xs:string"> <enumeration value="0113001"> <annotation> <documentation>Chemotherapie innerhalb der letzten drei Monate</documentation> </annotation> </enumeration> </restriction> </simpleType> </pre> | | |

simpleType enum_0114

| | | | |
|------------|------------------------------|--|--|
| namespace | http://xml.ir-d.de/irdma | | |
| type | restriction of string | | |
| properties | base xs:string | | |

| facets | <table border="1"> <thead> <tr> <th>Kind</th> <th>Value</th> <th>Annotation</th> </tr> </thead> <tbody> <tr> <td>enumeration</td> <td>0114001</td> <td>documentation vollständig</td> </tr> <tr> <td>enumeration</td> <td>0114002</td> <td>documentation nein</td> </tr> <tr> <td>enumeration</td> <td>0114003</td> <td>documentation teilweise</td> </tr> <tr> <td>enumeration</td> <td>0114004</td> <td>documentation nicht vorhanden</td> </tr> </tbody> </table> | Kind | Value | Annotation | enumeration | 0114001 | documentation vollständig | enumeration | 0114002 | documentation nein | enumeration | 0114003 | documentation teilweise | enumeration | 0114004 | documentation nicht vorhanden |
|-------------|--|----------------------------------|-------|------------|-------------|---------|------------------------------|-------------|---------|-----------------------|-------------|---------|----------------------------|-------------|---------|----------------------------------|
| Kind | Value | Annotation | | | | | | | | | | | | | | |
| enumeration | 0114001 | documentation vollständig | | | | | | | | | | | | | | |
| enumeration | 0114002 | documentation nein | | | | | | | | | | | | | | |
| enumeration | 0114003 | documentation teilweise | | | | | | | | | | | | | | |
| enumeration | 0114004 | documentation nicht vorhanden | | | | | | | | | | | | | | |
| annotation | documentation Kat_BI_EntfernungADMNetz | | | | | | | | | | | | | | | |
| source | <pre> <simpleType name="enum_0114"> <annotation> <documentation>Kat_BI_EntfernungADMNetz</documentation> </annotation> <restriction base="xs:string"> <enumeration value="0114001"> <annotation> <documentation>vollständig</documentation> </annotation> </enumeration> <enumeration value="0114002"> <annotation> <documentation>nein</documentation> </annotation> </enumeration> <enumeration value="0114003"> <annotation> <documentation>teilweise</documentation> </annotation> </enumeration> <enumeration value="0114004"> <annotation> <documentation>nicht vorhanden</documentation> </annotation> </enumeration> </restriction> </simpleType> </pre> | | | | | | | | | | | | | | | |

simpleType enum_0116

| namespace | http://xml.ir-d.de/irdma | | | | | | | | | | | | | | | | | | | | | | | | |
|-------------|---|---|-------|------------|-------------|---------|--|-------------|---------|--|-------------|---------|---|-------------|---------|----------------------------------|-------------|---------|---|-------------|---------|--|-------------|---------|---------------|
| type | restriction of string | | | | | | | | | | | | | | | | | | | | | | | | |
| properties | base xs:string | | | | | | | | | | | | | | | | | | | | | | | | |
| facets | <table border="1"> <thead> <tr> <th>Kind</th> <th>Value</th> <th>Annotation</th> </tr> </thead> <tbody> <tr> <td>enumeration</td> <td>0116001</td> <td>documentation Spülung, antibiotisch</td> </tr> <tr> <td>enumeration</td> <td>0116002</td> <td>documentation Spülung, antiseptisch</td> </tr> <tr> <td>enumeration</td> <td>0116003</td> <td>documentation Spülung, wirkstofffrei</td> </tr> <tr> <td>enumeration</td> <td>0116004</td> <td>documentation Spülung, andere</td> </tr> <tr> <td>enumeration</td> <td>0116005</td> <td>documentation prä-/perioperative Antibiotika</td> </tr> <tr> <td>enumeration</td> <td>0116006</td> <td>documentation postoperative Antibiotika</td> </tr> <tr> <td>enumeration</td> <td>0116007</td> <td>documentation</td> </tr> </tbody> </table> | Kind | Value | Annotation | enumeration | 0116001 | documentation Spülung, antibiotisch | enumeration | 0116002 | documentation Spülung, antiseptisch | enumeration | 0116003 | documentation Spülung, wirkstofffrei | enumeration | 0116004 | documentation Spülung, andere | enumeration | 0116005 | documentation prä-/perioperative Antibiotika | enumeration | 0116006 | documentation postoperative Antibiotika | enumeration | 0116007 | documentation |
| Kind | Value | Annotation | | | | | | | | | | | | | | | | | | | | | | | |
| enumeration | 0116001 | documentation Spülung, antibiotisch | | | | | | | | | | | | | | | | | | | | | | | |
| enumeration | 0116002 | documentation Spülung, antiseptisch | | | | | | | | | | | | | | | | | | | | | | | |
| enumeration | 0116003 | documentation Spülung, wirkstofffrei | | | | | | | | | | | | | | | | | | | | | | | |
| enumeration | 0116004 | documentation Spülung, andere | | | | | | | | | | | | | | | | | | | | | | | |
| enumeration | 0116005 | documentation prä-/perioperative Antibiotika | | | | | | | | | | | | | | | | | | | | | | | |
| enumeration | 0116006 | documentation postoperative Antibiotika | | | | | | | | | | | | | | | | | | | | | | | |
| enumeration | 0116007 | documentation | | | | | | | | | | | | | | | | | | | | | | | |

| | |
|------------|--|
| | enumeration 0116008 Handschuhwechsel vor Implantation documentation Implantationshilfe |
| annotation | documentation Kat_BI_Operationsmassnahme |
| source | <pre> <simpleType name="enum_0116"> <annotation> <documentation>Kat_BI_Operationsmassnahme</documentation> </annotation> <restriction base="xs:string"> <enumeration value="0116001"> <annotation> <documentation>Spülung, antibiotisch</documentation> </annotation> </enumeration> <enumeration value="0116002"> <annotation> <documentation>Spülung, antiseptisch</documentation> </annotation> </enumeration> <enumeration value="0116003"> <annotation> <documentation>Spülung, wirkstofffrei</documentation> </annotation> </enumeration> <enumeration value="0116004"> <annotation> <documentation>Spülung, andere</documentation> </annotation> </enumeration> <enumeration value="0116005"> <annotation> <documentation>prä-/perioperative Antibiotika</documentation> </annotation> </enumeration> <enumeration value="0116006"> <annotation> <documentation>postoperative Antibiotika</documentation> </annotation> </enumeration> <enumeration value="0116007"> <annotation> <documentation>Handschuhwechsel vor Implantation</documentation> </annotation> </enumeration> <enumeration value="0116008"> <annotation> <documentation>Implantationshilfe</documentation> </annotation> </enumeration> </restriction> </simpleType> </pre> |

simpleType enum_0118

| | |
|-----------|------------------------------|
| namespace | http://xml.ir-d.de/irdma |
| type | restriction of string |

| properties | base xs:string | | | | | | | | | | | | | | | | | | |
|-------------|--|-----------------------------------|-------|------------|-------------|---------|--------------------------|-------------|---------|------------------------------|-------------|---------|------------------------------|-------------|---------|-----------------------------------|-------------|---------|--------------------------|
| facets | <table border="1"> <thead> <tr> <th>Kind</th> <th>Value</th> <th>Annotation</th> </tr> </thead> <tbody> <tr> <td>enumeration</td> <td>0118001</td> <td>documentation axillär</td> </tr> <tr> <td>enumeration</td> <td>0118002</td> <td>documentation periareolär</td> </tr> <tr> <td>enumeration</td> <td>0118003</td> <td>documentation inframammär</td> </tr> <tr> <td>enumeration</td> <td>0118004</td> <td>documentation Mastektomienarbe</td> </tr> <tr> <td>enumeration</td> <td>0118042</td> <td>documentation anderer</td> </tr> </tbody> </table> | Kind | Value | Annotation | enumeration | 0118001 | documentation axillär | enumeration | 0118002 | documentation periareolär | enumeration | 0118003 | documentation inframammär | enumeration | 0118004 | documentation Mastektomienarbe | enumeration | 0118042 | documentation anderer |
| Kind | Value | Annotation | | | | | | | | | | | | | | | | | |
| enumeration | 0118001 | documentation axillär | | | | | | | | | | | | | | | | | |
| enumeration | 0118002 | documentation periareolär | | | | | | | | | | | | | | | | | |
| enumeration | 0118003 | documentation inframammär | | | | | | | | | | | | | | | | | |
| enumeration | 0118004 | documentation Mastektomienarbe | | | | | | | | | | | | | | | | | |
| enumeration | 0118042 | documentation anderer | | | | | | | | | | | | | | | | | |
| annotation | documentation Kat_BI_Operationszugang | | | | | | | | | | | | | | | | | | |
| source | <pre> <simpleType name="enum_0118"> <annotation> <documentation>Kat_BI_Operationszugang</documentation> </annotation> <restriction base="xs:string"> <enumeration value="0118001"> <annotation> <documentation>axillär</documentation> </annotation> </enumeration> <enumeration value="0118002"> <annotation> <documentation>periareolär</documentation> </annotation> </enumeration> <enumeration value="0118003"> <annotation> <documentation>inframammär</documentation> </annotation> </enumeration> <enumeration value="0118004"> <annotation> <documentation>Mastektomienarbe</documentation> </annotation> </enumeration> <enumeration value="0118042"> <annotation> <documentation>anderer</documentation> </annotation> </enumeration> </restriction> </simpleType> </pre> | | | | | | | | | | | | | | | | | | |

simpleType enum_0120

| namespace | http://xml.ir-d.de/irdma | | | | | | |
|-------------|---|----------------------------------|-------|------------|-------------|---------|----------------------------------|
| type | restriction of string | | | | | | |
| properties | base xs:string | | | | | | |
| facets | <table border="1"> <thead> <tr> <th>Kind</th> <th>Value</th> <th>Annotation</th> </tr> </thead> <tbody> <tr> <td>enumeration</td> <td>0120001</td> <td>documentation Expander defekt</td> </tr> </tbody> </table> | Kind | Value | Annotation | enumeration | 0120001 | documentation Expander defekt |
| Kind | Value | Annotation | | | | | |
| enumeration | 0120001 | documentation Expander defekt | | | | | |
| annotation | documentation Kat BI BefundAustausch | | | | | | |

| | |
|--------|--|
| source | <pre> <simpleType name="enum_0120"> <annotation> <documentation>Kat_BI_BefundAustausch</documentation> </annotation> <restriction base="xs:string"> <enumeration value="0120001"> <annotation> <documentation>Expander defekt</documentation> </annotation> </enumeration> </restriction> </simpleType> </pre> |
|--------|--|

simpleType enum_0121

| | | | |
|------------|---|---------|---|
| namespace | http://xml.ir-d.de/irdma | | |
| type | restriction of string | | |
| properties | base xs:string | | |
| facets | Kind | Value | Annotation |
| | enumeration | 0121001 | documentation Infektion |
| | enumeration | 0121002 | documentation Serom |
| | enumeration | 0121003 | documentation Hämatom |
| | enumeration | 0121004 | documentation Kapsel fibrose |
| | enumeration | 0121005 | documentation Implantatruptur |
| | enumeration | 0121006 | documentation Fehlpositionierung/Rotation |
| | enumeration | 0121007 | documentation BIA-ALCL/-SCC, Verdacht |
| | enumeration | 0121008 | documentation BIA-ALCL/-SCC, pathologisch bestätigt |
| | enumeration | 0121009 | documentation Brustschmerzen |
| | enumeration | 0121010 | documentation Doppelkapsel |
| | enumeration | 0121011 | documentation Netz-/ADM-bedingte Komplikation, Non-Integration |
| | enumeration | 0121012 | documentation Netz-/ADM-bedingte Komplikation, andere |
| | enumeration | 0121013 | documentation Hautnekrose/exponiertes Implantat |
| | enumeration | 0121014 | documentation BII/ASIA (Brustimplantat assoziierte Symptome), Verdacht |
| | enumeration | 0121015 | documentation Lymphadenopathie |
| | enumeration | 0121016 | documentation Brustkrebs, neu aufgetreten/Rezidiv |
| annotation | documentation Kat_BI_BefundKomplett | | |
| source | <pre> <simpleType name="enum_0121"> <annotation> <documentation>Kat_BI_BefundKomplett</documentation> </annotation> <restriction base="xs:string"> <enumeration value="0121001"> </pre> | | |

```

    <annotation>
      <documentation>Infektion</documentation>
    </annotation>
  </enumeration>
  <enumeration value="0121002">
    <annotation>
      <documentation>Serom</documentation>
    </annotation>
  </enumeration>
  <enumeration value="0121003">
    <annotation>
      <documentation>Hämatom</documentation>
    </annotation>
  </enumeration>
  <enumeration value="0121004">
    <annotation>
      <documentation>Kapselfibrose</documentation>
    </annotation>
  </enumeration>
  <enumeration value="0121005">
    <annotation>
      <documentation>Implantatruptur</documentation>
    </annotation>
  </enumeration>
  <enumeration value="0121006">
    <annotation>
      <documentation>Fehlpositionierung/Rotation</documentation>
    </annotation>
  </enumeration>
  <enumeration value="0121007">
    <annotation>
      <documentation>BIA-ALCL/-SCC, Verdacht</documentation>
    </annotation>
  </enumeration>
  <enumeration value="0121008">
    <annotation>
      <documentation>BIA-ALCL/-SCC, pathologisch bestätigt</documentation>
    </annotation>
  </enumeration>
  <enumeration value="0121009">
    <annotation>
      <documentation>Brustschmerzen</documentation>
    </annotation>
  </enumeration>
  <enumeration value="0121010">
    <annotation>
      <documentation>Doppelkapsel</documentation>
    </annotation>
  </enumeration>
  <enumeration value="0121011">
    <annotation>
      <documentation>Netz-/ADM-bedingte Komplikation,
Non-Integration</documentation>
    </annotation>
  </enumeration>
  <enumeration value="0121012">
    <annotation>
      <documentation>Netz-/ADM-bedingte Komplikation, andere</documentation>
    </annotation>
  </enumeration>

```

| | |
|--|--|
| | <pre> </enumeration> <enumeration value="0121013"> <annotation> <documentation>Hautnekrose/exponiertes Implantat</documentation> </annotation> </enumeration> <enumeration value="0121014"> <annotation> <documentation>BII/ASIA (Brustimplantat assoziierte Symptome), Verdacht</documentation> </annotation> </enumeration> <enumeration value="0121015"> <annotation> <documentation>Lymphadenopathie</documentation> </annotation> </enumeration> <enumeration value="0121016"> <annotation> <documentation>Brustkrebs, neu aufgetreten/Rezidiv</documentation> </annotation> </enumeration> </restriction> </simpleType> </pre> |
|--|--|

simpleType enum_0122

| | | | |
|------------|---|---------|--|
| namespace | http://xml.ir-d.de/irdma | | |
| type | restriction of string | | |
| properties | base xs:string | | |
| facets | Kind | Value | Annotation |
| | enumeration | 0122001 | documentation ja, ärztlich nachgewiesen |
| | enumeration | 0122002 | documentation nein |
| | enumeration | 0122042 | documentation unbekannt |
| annotation | documentation Kat BI Autoimmunerkrankung | | |
| source | <pre> <simpleType name="enum_0122"> <annotation> <documentation>Kat_BI_Autoimmunerkrankung</documentation> </annotation> <restriction base="xs:string"> <enumeration value="0122001"> <annotation> <documentation>ja, ärztlich nachgewiesen</documentation> </annotation> </enumeration> <enumeration value="0122002"> <annotation> <documentation>nein</documentation> </annotation> </enumeration> <enumeration value="0122042"> <annotation> <documentation>unbekannt</documentation> </annotation> </enumeration> </restriction> </simpleType> </pre> | | |

```

    </annotation>
  </enumeration>
</restriction>
</simpleType>

```

simpleType enum_0123

| | | | |
|------------|--|---------|--|
| namespace | http://xml.ir-d.de/irdma | | |
| type | restriction of string | | |
| properties | base xs:string | | |
| facets | Kind | Value | Annotation |
| | enumeration | 0123001 | documentation neu aufgetreten |
| | enumeration | 0123002 | documentation verschlechtert |
| | enumeration | 0123003 | documentation keine Veränderung |
| | enumeration | 0123004 | documentation nicht relevant, da Primäreingriff |
| | enumeration | 0123042 | documentation unbekannt |
| annotation | documentation Kat_BI_VerlaufAutoimmunerkrankung | | |
| source | <pre> <simpleType name="enum_0123"> <annotation> <documentation>Kat_BI_VerlaufAutoimmunerkrankung</documentation> </annotation> <restriction base="xs:string"> <enumeration value="0123001"> <annotation> <documentation>neu aufgetreten</documentation> </annotation> </enumeration> <enumeration value="0123002"> <annotation> <documentation>verschlechtert</documentation> </annotation> </enumeration> <enumeration value="0123003"> <annotation> <documentation>keine Veränderung</documentation> </annotation> </enumeration> <enumeration value="0123004"> <annotation> <documentation>nicht relevant, da Primäreingriff</documentation> </annotation> </enumeration> <enumeration value="0123042"> <annotation> <documentation>unbekannt</documentation> </annotation> </enumeration> </restriction> </simpleType> </pre> | | |

simpleType enum_0124

| | | | |
|------------|---|---------|--|
| namespace | http://xml.ir-d.de/irdma | | |
| type | restriction of string | | |
| properties | base xs:string | | |
| facets | Kind | Value | Annotation |
| | enumeration | 0124001 | documentation Salzlösung |
| | enumeration | 0124002 | documentation Silikongel |
| | enumeration | 0124003 | documentation Kombination Silikongel und Salzlösung |
| | enumeration | 0124042 | documentation sonstige |
| annotation | documentation Kat_BI_Fuellung | | |
| source | <pre> <simpleType name="enum_0124"> <annotation> <documentation>Kat_BI_Fuellung</documentation> </annotation> <restriction base="xs:string"> <enumeration value="0124001"> <annotation> <documentation>Salzlösung</documentation> </annotation> </enumeration> <enumeration value="0124002"> <annotation> <documentation>Silikongel</documentation> </annotation> </enumeration> <enumeration value="0124003"> <annotation> <documentation>Kombination Silikongel und Salzlösung</documentation> </annotation> </enumeration> <enumeration value="0124042"> <annotation> <documentation>sonstige</documentation> </annotation> </enumeration> </restriction> </simpleType> </pre> | | |

simpleType enum_0126

| | | | |
|------------|------------------------------|---------|---|
| namespace | http://xml.ir-d.de/irdma | | |
| type | restriction of string | | |
| properties | base xs:string | | |
| facets | Kind | Value | Annotation |
| | enumeration | 0126001 | documentation anatomisch (tropfenförmig) |
| | enumeration | 0126002 | documentation rund (punktsymmetrisch) |
| | enumeration | 0126042 | documentation |

| | |
|------------|---|
| | sonstige |
| annotation | documentation Kat BI_Form |
| source | <pre> <simpleType name="enum_0126"> <annotation> <documentation>Kat_BI_Form</documentation> </annotation> <restriction base="xs:string"> <enumeration value="0126001"> <annotation> <documentation>anatomisch (tropfenförmig)</documentation> </annotation> </enumeration> <enumeration value="0126002"> <annotation> <documentation>rund (punktsymmetrisch)</documentation> </annotation> </enumeration> <enumeration value="0126042"> <annotation> <documentation>sonstige</documentation> </annotation> </enumeration> </restriction> </simpleType> </pre> |

simpleType **enum_0128**

| | | | |
|------------|---|---------|------------------------------|
| namespace | http://xml.ir-d.de/irdma | | |
| type | restriction of string | | |
| properties | base xs:string | | |
| facets | Kind | Value | Annotation |
| | enumeration | 0128001 | documentation glattwandig |
| | enumeration | 0128002 | documentation beschichtet |
| | enumeration | 0128003 | documentation texturiert |
| annotation | documentation Kat BI_Oberflaeche | | |
| source | <pre> <simpleType name="enum_0128"> <annotation> <documentation>Kat_BI_Oberflaeche</documentation> </annotation> <restriction base="xs:string"> <enumeration value="0128001"> <annotation> <documentation>glattwandig</documentation> </annotation> </enumeration> <enumeration value="0128002"> <annotation> <documentation>beschichtet</documentation> </annotation> </enumeration> <enumeration value="0128003"> <annotation> </pre> | | |

```

<documentation>texturiert</documentation>
</annotation>
</enumeration>
</restriction>
</simpleType>

```

simpleType enum_0130

| | | | |
|------------|---|---------|---|
| namespace | http://xml.ir-d.de/irdma | | |
| type | restriction of string | | |
| properties | base xs:string | | |
| facets | Kind | Value | Annotation |
| | enumeration | 0130001 | documentation Allergan |
| | enumeration | 0130002 | documentation Cereplas |
| | enumeration | 0130003 | documentation CUI (Cox Uphoff Implants) |
| | enumeration | 0130004 | documentation EMSI Biomedical |
| | enumeration | 0130005 | documentation Establishment labs |
| | enumeration | 0130006 | documentation Eurosilicone |
| | enumeration | 0130007 | documentation Nagor |
| | enumeration | 0130008 | documentation Groupe Sebbin |
| | enumeration | 0130009 | documentation Laboratoires Arion |
| | enumeration | 0130010 | documentation Mentor |
| | enumeration | 0130011 | documentation Pérouse Plastie SAS |
| | enumeration | 0130012 | documentation PIP M-Implants |
| | enumeration | 0130013 | documentation Polytech Health & Aesthetics |
| | enumeration | 0130014 | documentation Silimed |
| | enumeration | 0130015 | documentation Surgitek |
| | enumeration | 0130016 | documentation G&G Biotechnology |
| | enumeration | 0130017 | documentation nicht belegter Wert |
| | enumeration | 0130018 | documentation nicht belegter Wert |
| | enumeration | 0130019 | documentation nicht belegter Wert |
| | enumeration | 0130020 | documentation nicht belegter Wert |
| | enumeration | 0130021 | documentation nicht belegter Wert |
| | enumeration | 0130042 | documentation sonstiger |
| annotation | documentation Kat_BI_Hersteller | | |
| source | <simpleType name="enum_0130"> <annotation> | | |

```
<documentation>Kat_BI_Hersteller</documentation>
</annotation>
<restriction base="xs:string">
  <enumeration value="0130001">
    <annotation>
      <documentation>Allergan</documentation>
    </annotation>
  </enumeration>
  <enumeration value="0130002">
    <annotation>
      <documentation>Cereplas</documentation>
    </annotation>
  </enumeration>
  <enumeration value="0130003">
    <annotation>
      <documentation>CUI (Cox Uphoff Implants)</documentation>
    </annotation>
  </enumeration>
  <enumeration value="0130004">
    <annotation>
      <documentation>EMSI Biomedical</documentation>
    </annotation>
  </enumeration>
  <enumeration value="0130005">
    <annotation>
      <documentation>Establishment labs</documentation>
    </annotation>
  </enumeration>
  <enumeration value="0130006">
    <annotation>
      <documentation>Eurosilicone</documentation>
    </annotation>
  </enumeration>
  <enumeration value="0130007">
    <annotation>
      <documentation>Nagor</documentation>
    </annotation>
  </enumeration>
  <enumeration value="0130008">
    <annotation>
      <documentation>Groupe Sebbin</documentation>
    </annotation>
  </enumeration>
  <enumeration value="0130009">
    <annotation>
      <documentation>Laboratoires Arion</documentation>
    </annotation>
  </enumeration>
  <enumeration value="0130010">
    <annotation>
      <documentation>Mentor</documentation>
    </annotation>
  </enumeration>
  <enumeration value="0130011">
    <annotation>
      <documentation>Pérouse Plastie SAS</documentation>
    </annotation>
  </enumeration>
  <enumeration value="0130012">
```

```
<annotation>
  <documentation>PIP M-Implants</documentation>
</annotation>
</enumeration>
<enumeration value="0130013">
  <annotation>
    <documentation>Polytech Health & Aesthetics</documentation>
  </annotation>
</enumeration>
<enumeration value="0130014">
  <annotation>
    <documentation>Silimed</documentation>
  </annotation>
</enumeration>
<enumeration value="0130015">
  <annotation>
    <documentation>Surgitek</documentation>
  </annotation>
</enumeration>
<enumeration value="0130016">
  <annotation>
    <documentation>G&G Biotechnology</documentation>
  </annotation>
</enumeration>
<enumeration value="0130017">
  <annotation>
    <documentation>nicht belegter Wert</documentation>
  </annotation>
</enumeration>
<enumeration value="0130018">
  <annotation>
    <documentation>nicht belegter Wert</documentation>
  </annotation>
</enumeration>
<enumeration value="0130019">
  <annotation>
    <documentation>nicht belegter Wert</documentation>
  </annotation>
</enumeration>
<enumeration value="0130020">
  <annotation>
    <documentation>nicht belegter Wert</documentation>
  </annotation>
</enumeration>
<enumeration value="0130021">
  <annotation>
    <documentation>nicht belegter Wert</documentation>
  </annotation>
</enumeration>
<enumeration value="0130042">
  <annotation>
    <documentation>sonstiger</documentation>
  </annotation>
</enumeration>
</restriction>
</simpleType>
```

simpleType enum_0131

| | | | |
|------------|--|---------|---|
| namespace | http://xml.ir-d.de/irdma | | |
| type | restriction of string | | |
| properties | base xs:string | | |
| facets | Kind | Value | Annotation |
| | enumeration | 0131001 | documentation Allergan |
| | enumeration | 0131002 | documentation Establishment labs |
| | enumeration | 0131003 | documentation Eurosilicone |
| | enumeration | 0131004 | documentation Galatea |
| | enumeration | 0131005 | documentation Integra |
| | enumeration | 0131006 | documentation Lifecell |
| | enumeration | 0131007 | documentation MBP (Medical Biomaterial Products) |
| | enumeration | 0131008 | documentation Mentor |
| | enumeration | 0131009 | documentation Novus Scientific |
| | enumeration | 0131042 | documentation sonstiger |
| annotation | documentation Kat_BI_ZubehoerHersteller | | |
| source | <pre> <simpleType name="enum_0131"> <annotation> <documentation>Kat_BI_ZubehoerHersteller</documentation> </annotation> <restriction base="xs:string"> <enumeration value="0131001"> <annotation> <documentation>Allergan</documentation> </annotation> </enumeration> <enumeration value="0131002"> <annotation> <documentation>Establishment labs</documentation> </annotation> </enumeration> <enumeration value="0131003"> <annotation> <documentation>Eurosilicone</documentation> </annotation> </enumeration> <enumeration value="0131004"> <annotation> <documentation>Galatea</documentation> </annotation> </enumeration> <enumeration value="0131005"> <annotation> <documentation>Integra</documentation> </annotation> </enumeration> <enumeration value="0131006"> <annotation> </pre> | | |

| | |
|--|---|
| | <pre> <documentation>Lifecell</documentation> </annotation> </enumeration> <enumeration value="0131007"> <annotation> <documentation>MBP (Medical Biomaterial Products)</documentation> </annotation> </enumeration> <enumeration value="0131008"> <annotation> <documentation>Mentor</documentation> </annotation> </enumeration> <enumeration value="0131009"> <annotation> <documentation>Novus Scientific</documentation> </annotation> </enumeration> <enumeration value="0131042"> <annotation> <documentation>sonstiger</documentation> </annotation> </enumeration> </restriction> </simpleType> </pre> |
|--|---|

simpleType enum_0190

| | | | |
|------------|---|---------|---------------------------------|
| namespace | http://xml.ir-d.de/irdma | | |
| type | restriction of string | | |
| properties | base xs:string | | |
| facets | Kind | Value | Annotation |
| | enumeration | 0190001 | documentation Brustimplantat |
| | enumeration | 0190003 | documentation Brustexpander |
| annotation | documentation Kat_BI_Artikeltyp | | |
| source | <pre> <simpleType name="enum_0190"> <annotation> <documentation>Kat_BI_Artikeltyp</documentation> </annotation> <restriction base="xs:string"> <enumeration value="0190001"> <annotation> <documentation>Brustimplantat</documentation> </annotation> </enumeration> <enumeration value="0190003"> <annotation> <documentation>Brustexpander</documentation> </annotation> </enumeration> </restriction> </simpleType> </pre> | | |

simpleType enum_0191

| | | | |
|------------|--|---------|-----------------------|
| namespace | http://xml.ir-d.de/irdma | | |
| type | restriction of string | | |
| properties | base xs:string | | |
| facets | Kind | Value | Annotation |
| | enumeration | 0191001 | documentation Netz |
| | enumeration | 0191002 | documentation ADM |
| annotation | documentation Kat_BI_ZubehoerTyp | | |
| source | <pre> <simpleType name="enum_0191"> <annotation> <documentation>Kat_BI_ZubehoerTyp</documentation> </annotation> <restriction base="xs:string"> <enumeration value="0191001"> <annotation> <documentation>Netz</documentation> </annotation> </enumeration> <enumeration value="0191002"> <annotation> <documentation>ADM</documentation> </annotation> </enumeration> </restriction> </simpleType> </pre> | | |

simpleType enum_0200

| | | | |
|------------|---|---------|--------------------------------|
| namespace | http://xml.ir-d.de/irdma | | |
| type | restriction of string | | |
| properties | base xs:string | | |
| facets | Kind | Value | Annotation |
| | enumeration | 0200001 | documentation Erst-OP |
| | enumeration | 0200002 | documentation Folgeeingriff |
| annotation | documentation Kat_EP_ArtEingriff | | |
| source | <pre> <simpleType name="enum_0200"> <annotation> <documentation>Kat_EP_ArtEingriff</documentation> </annotation> <restriction base="xs:string"> <enumeration value="0200001"> <annotation> <documentation>Erst-OP</documentation> </annotation> </enumeration> <enumeration value="0200002"> <annotation> <documentation>Folgeeingriff</documentation> </annotation> </enumeration> </restriction> </simpleType> </pre> | | |

```

</annotation>
</enumeration>
</restriction>
</simpleType>

```

simpleType enum_0202

| | | | |
|------------|---|---------|--|
| namespace | http://xml.ir-d.de/irdma | | |
| type | restriction of string | | |
| properties | base xs:string | | |
| facets | Kind | Value | Annotation |
| | enumeration | 0202001 | documentation Lockerung |
| | enumeration | 0202002 | documentation Infektion, Verdacht auf |
| | enumeration | 0202003 | documentation Infektion, gesichert |
| | enumeration | 0202004 | documentation Luxation, Inlay aus der Pfanne |
| | enumeration | 0202005 | documentation Luxation, Kopf aus Pfanne/Inlay |
| | enumeration | 0202006 | documentation Periprothetische Fraktur |
| | enumeration | 0202007 | documentation Verschleiß des PE-Inlays |
| | enumeration | 0202008 | documentation Implantatbruch |
| | enumeration | 0202009 | documentation Implantatfehlage/Malalignent |
| | enumeration | 0202010 | documentation Osteolysen bei festem Implantat |
| | enumeration | 0202011 | documentation Progression der Grunderkrankung |
| | enumeration | 0202012 | documentation ARMD |
| | enumeration | 0202013 | documentation Verdacht auf allergische Reaktion |
| | enumeration | 0202021 | documentation Zustand nach Prothesenentfernung |
| | enumeration | 0202042 | documentation andere Gründe |
| annotation | documentation Kat_EP_GrundWechselHuefte | | |
| source | <pre> <simpleType name="enum_0202"> <annotation> <documentation>Kat_EP_GrundWechselHuefte</documentation> </annotation> <restriction base="xs:string"> <enumeration value="0202001"> <annotation> <documentation>Lockerung</documentation> </annotation> </enumeration> <enumeration value="0202002"> <annotation> <documentation>Infektion, Verdacht auf</documentation> </annotation> </enumeration> <enumeration value="0202003"> </pre> | | |

```
<annotation>
  <documentation>Infektion, gesichert</documentation>
</annotation>
</enumeration>
<enumeration value="0202004">
  <annotation>
    <documentation>Luxation, Inlay aus der Pfanne</documentation>
  </annotation>
</enumeration>
<enumeration value="0202005">
  <annotation>
    <documentation>Luxation, Kopf aus Pfanne/Inlay</documentation>
  </annotation>
</enumeration>
<enumeration value="0202006">
  <annotation>
    <documentation>Periprothetische Fraktur</documentation>
  </annotation>
</enumeration>
<enumeration value="0202007">
  <annotation>
    <documentation>Verschleiß des PE-Inlays</documentation>
  </annotation>
</enumeration>
<enumeration value="0202008">
  <annotation>
    <documentation>Implantatbruch</documentation>
  </annotation>
</enumeration>
<enumeration value="0202009">
  <annotation>
    <documentation>Implantatfehllage/Malalignent</documentation>
  </annotation>
</enumeration>
<enumeration value="0202010">
  <annotation>
    <documentation>Osteolysen bei festem Implantat</documentation>
  </annotation>
</enumeration>
<enumeration value="0202011">
  <annotation>
    <documentation>Progression der Grunderkrankung</documentation>
  </annotation>
</enumeration>
<enumeration value="0202012">
  <annotation>
    <documentation>ARMD</documentation>
  </annotation>
</enumeration>
<enumeration value="0202013">
  <annotation>
    <documentation>Verdacht auf allergische Reaktion</documentation>
  </annotation>
</enumeration>
<enumeration value="0202021">
  <annotation>
    <documentation>Zustand nach Prothesenentfernung</documentation>
  </annotation>
</enumeration>
```

| | |
|--|--|
| | <pre> <enumeration value="0202042"> <annotation> <documentation>andere Gründe</documentation> </annotation> </enumeration> </restriction> </simpleType> </pre> |
|--|--|

simpleType **enum_0204**

| | | | |
|------------|--|---------|--|
| namespace | http://xml.ir-d.de/irdma | | |
| type | restriction of string | | |
| properties | base xs:string | | |
| facets | Kind | Value | Annotation |
| | enumeration | 0204001 | documentation Lockerung |
| | enumeration | 0204002 | documentation Infektion, Verdacht auf |
| | enumeration | 0204003 | documentation Infektion, gesichert |
| | enumeration | 0204006 | documentation Periprothetische Fraktur |
| | enumeration | 0204007 | documentation Verschleiß |
| | enumeration | 0204008 | documentation Implantatbruch |
| | enumeration | 0204009 | documentation Implantatfehlage/Malalignent |
| | enumeration | 0204010 | documentation Osteolysen bei festem Implantat |
| | enumeration | 0204011 | documentation Progression der Grunderkrankung |
| | enumeration | 0204012 | documentation ARMD |
| | enumeration | 0204013 | documentation Verdacht auf allergische Reaktion |
| | enumeration | 0204014 | documentation Dislokation/Migration von Komponenten |
| | enumeration | 0204015 | documentation Bandinstabilität |
| | enumeration | 0204016 | documentation Bewegungseinschränkung |
| | enumeration | 0204021 | documentation Zustand nach Prothesenentfernung |
| | enumeration | 0204042 | documentation andere Gründe |
| annotation | documentation Kat_EP_GrundWechselKnie | | |
| source | <pre> <simpleType name="enum_0204"> <annotation> <documentation>Kat_EP_GrundWechselKnie</documentation> </annotation> <restriction base="xs:string"> <enumeration value="0204001"> <annotation> <documentation>Lockerung</documentation> </annotation> </enumeration> <enumeration value="0204002"> </pre> | | |

```
<annotation>
  <documentation>Infektion, Verdacht auf</documentation>
</annotation>
</enumeration>
<enumeration value="0204003">
  <annotation>
    <documentation>Infektion, gesichert</documentation>
  </annotation>
</enumeration>
<enumeration value="0204006">
  <annotation>
    <documentation>Periprothetische Fraktur</documentation>
  </annotation>
</enumeration>
<enumeration value="0204007">
  <annotation>
    <documentation>Verschleiß</documentation>
  </annotation>
</enumeration>
<enumeration value="0204008">
  <annotation>
    <documentation>Implantatbruch</documentation>
  </annotation>
</enumeration>
<enumeration value="0204009">
  <annotation>
    <documentation>Implantatfehlage/Malalignent</documentation>
  </annotation>
</enumeration>
<enumeration value="0204010">
  <annotation>
    <documentation>Osteolysen bei festem Implantat</documentation>
  </annotation>
</enumeration>
<enumeration value="0204011">
  <annotation>
    <documentation>Progression der Grunderkrankung</documentation>
  </annotation>
</enumeration>
<enumeration value="0204012">
  <annotation>
    <documentation>ARMD</documentation>
  </annotation>
</enumeration>
<enumeration value="0204013">
  <annotation>
    <documentation>Verdacht auf allergische Reaktion</documentation>
  </annotation>
</enumeration>
<enumeration value="0204014">
  <annotation>
    <documentation>Dislokation/Migration von Komponenten</documentation>
  </annotation>
</enumeration>
<enumeration value="0204015">
  <annotation>
    <documentation>Bandinstabilität</documentation>
  </annotation>
</enumeration>
```

```

<enumeration value="0204016">
  <annotation>
    <documentation>Bewegungseinschränkung</documentation>
  </annotation>
</enumeration>
<enumeration value="0204021">
  <annotation>
    <documentation>Zustand nach Prothesenentfernung</documentation>
  </annotation>
</enumeration>
<enumeration value="0204042">
  <annotation>
    <documentation>andere Gründe</documentation>
  </annotation>
</enumeration>
</restriction>
</simpleType>

```

simpleType enum_0206

| | | | |
|------------|------------------------------|---------|--|
| namespace | http://xml.ir-d.de/irdma | | |
| type | restriction of string | | |
| properties | base xs:string | | |
| facets | Kind | Value | Annotation |
| | enumeration | 0206001 | documentation Lockerung |
| | enumeration | 0206002 | documentation Infektion, Verdacht auf |
| | enumeration | 0206003 | documentation Infektion, gesichert |
| | enumeration | 0206004 | documentation Luxation, Inlay aus der Pfanne |
| | enumeration | 0206005 | documentation Luxation, Kopf aus Pfanne/Inlay |
| | enumeration | 0206006 | documentation Periprothetische Fraktur |
| | enumeration | 0206007 | documentation Verschleiß |
| | enumeration | 0206008 | documentation Implantatbruch |
| | enumeration | 0206009 | documentation Implantatfehlage/Malalignement |
| | enumeration | 0206010 | documentation Osteolysen bei festem Implantat |
| | enumeration | 0206011 | documentation Progression der Grunderkrankung |
| | enumeration | 0206012 | documentation ARM-D |
| | enumeration | 0206013 | documentation Verdacht auf allergische Reaktion |
| | enumeration | 0206014 | documentation Dislokation/Migration von Komponenten |
| | enumeration | 0206015 | documentation Bandinstabilität |
| | enumeration | 0206016 | documentation Bewegungseinschränkung |
| | enumeration | 0206021 | documentation Zustand nach Prothesenentfernung |
| | enumeration | 0206042 | documentation andere Gründe |

| | |
|------------|--|
| annotation | documentation Kat_EP_GrundWechselTFE |
| source | <pre> <simpleType name="enum_0206"> <annotation> <documentation>Kat_EP_GrundWechselTFE</documentation> </annotation> <restriction base="xs:string"> <enumeration value="0206001"> <annotation> <documentation>Lockerung</documentation> </annotation> </enumeration> <enumeration value="0206002"> <annotation> <documentation>Infektion, Verdacht auf</documentation> </annotation> </enumeration> <enumeration value="0206003"> <annotation> <documentation>Infektion, gesichert</documentation> </annotation> </enumeration> <enumeration value="0206004"> <annotation> <documentation>Luxation, Inlay aus der Pfanne</documentation> </annotation> </enumeration> <enumeration value="0206005"> <annotation> <documentation>Luxation, Kopf aus Pfanne/Inlay</documentation> </annotation> </enumeration> <enumeration value="0206006"> <annotation> <documentation>Periprothetische Fraktur</documentation> </annotation> </enumeration> <enumeration value="0206007"> <annotation> <documentation>Verschleiß</documentation> </annotation> </enumeration> <enumeration value="0206008"> <annotation> <documentation>Implantatbruch</documentation> </annotation> </enumeration> <enumeration value="0206009"> <annotation> <documentation>Implantatfehllage/Malalignent</documentation> </annotation> </enumeration> <enumeration value="0206010"> <annotation> <documentation>Osteolysen bei festem Implantat</documentation> </annotation> </enumeration> <enumeration value="0206011"> <annotation> </pre> |

```

    <documentation>Progression der Grunderkrankung</documentation>
  </annotation>
</enumeration>
<enumeration value="0206012">
  <annotation>
    <documentation>ARMD</documentation>
  </annotation>
</enumeration>
<enumeration value="0206013">
  <annotation>
    <documentation>Verdacht auf allergische Reaktion</documentation>
  </annotation>
</enumeration>
<enumeration value="0206014">
  <annotation>
    <documentation>Dislokation/Migration von Komponenten</documentation>
  </annotation>
</enumeration>
<enumeration value="0206015">
  <annotation>
    <documentation>Bandinstabilität</documentation>
  </annotation>
</enumeration>
<enumeration value="0206016">
  <annotation>
    <documentation>Bewegungseinschränkung</documentation>
  </annotation>
</enumeration>
<enumeration value="0206021">
  <annotation>
    <documentation>Zustand nach Prothesenentfernung</documentation>
  </annotation>
</enumeration>
<enumeration value="0206042">
  <annotation>
    <documentation>andere Gründe</documentation>
  </annotation>
</enumeration>
</restriction>
</simpleType>

```

simpleType enum_0210

| | | | |
|------------|------------------------------|---------|--|
| namespace | http://xml.ir-d.de/irdma | | |
| type | restriction of string | | |
| properties | base xs:string | | |
| facets | Kind | Value | Annotation |
| | enumeration | 0210001 | documentation keine relevante Voroperation |
| | enumeration | 0210002 | documentation Osteosynthese/Osteotomie (Becken) |
| | enumeration | 0210003 | documentation Osteosynthese/Osteotomie (Femur) |
| | enumeration | 0210004 | documentation Osteosynthese/Osteotomie (beides) |
| | enumeration | 0210005 | documentation Operation bei Hüftkopfnekrose |

| | |
|------------|---|
| | enumeration 0210006 documentation Arthrodese |
| | enumeration 0210042 documentation andere |
| annotation | documentation Kat_EP_VoroperationHuefte |
| source | <pre> <simpleType name="enum_0210"> <annotation> <documentation>Kat_EP_VoroperationHuefte</documentation> </annotation> <restriction base="xs:string"> <enumeration value="0210001"> <annotation> <documentation>keine relevante Voroperation</documentation> </annotation> </enumeration> <enumeration value="0210002"> <annotation> <documentation>Osteosynthese/Osteotomie (Becken)</documentation> </annotation> </enumeration> <enumeration value="0210003"> <annotation> <documentation>Osteosynthese/Osteotomie (Femur)</documentation> </annotation> </enumeration> <enumeration value="0210004"> <annotation> <documentation>Osteosynthese/Osteotomie (beides)</documentation> </annotation> </enumeration> <enumeration value="0210005"> <annotation> <documentation>Operation bei Hüftkopfnekrose</documentation> </annotation> </enumeration> <enumeration value="0210006"> <annotation> <documentation>Arthrodese</documentation> </annotation> </enumeration> <enumeration value="0210042"> <annotation> <documentation>andere</documentation> </annotation> </enumeration> </restriction> </simpleType> </pre> |

simpleType enum_0211

| | | | |
|------------|------------------------------|------------------|---|
| namespace | http://xml.ir-d.de/irdma | | |
| type | restriction of string | | |
| properties | base xs:string | | |
| facets | Kind enumeration | Value 0211001 | Annotation documentation keine relevante Voroperation |

| | |
|------------|---|
| | <p>enumeration 0211002 documentation Osteosynthese/Osteotomie (Femur)</p> <p>enumeration 0211003 documentation Osteosynthese/Osteotomie (Tibia)</p> <p>enumeration 0211004 documentation Osteosynthese/Osteotomie (Patella)</p> <p>enumeration 0211005 documentation Osteosynthese/Osteotomie (mehrere)</p> <p>enumeration 0211006 documentation Kapsel-/Bandapparat</p> <p>enumeration 0211007 documentation Arthrodese</p> <p>enumeration 0211042 documentation andere</p> |
| annotation | documentation Kat_EP_VoroperationKnie |
| source | <pre> <simpleType name="enum_0211"> <annotation> <documentation>Kat_EP_VoroperationKnie</documentation> </annotation> <restriction base="xs:string"> <enumeration value="0211001"> <annotation> <documentation>keine relevante Voroperation</documentation> </annotation> </enumeration> <enumeration value="0211002"> <annotation> <documentation>Osteosynthese/Osteotomie (Femur)</documentation> </annotation> </enumeration> <enumeration value="0211003"> <annotation> <documentation>Osteosynthese/Osteotomie (Tibia)</documentation> </annotation> </enumeration> <enumeration value="0211004"> <annotation> <documentation>Osteosynthese/Osteotomie (Patella)</documentation> </annotation> </enumeration> <enumeration value="0211005"> <annotation> <documentation>Osteosynthese/Osteotomie (mehrere)</documentation> </annotation> </enumeration> <enumeration value="0211006"> <annotation> <documentation>Kapsel-/Bandapparat</documentation> </annotation> </enumeration> <enumeration value="0211007"> <annotation> <documentation>Arthrodese</documentation> </annotation> </enumeration> <enumeration value="0211042"> <annotation> <documentation>andere</documentation> </annotation> </enumeration> </restriction> </simpleType> </pre> |

| | |
|--|--|
| | <pre> </enumeration> </restriction> </simpleType> </pre> |
|--|--|

simpleType enum_0212

| | | | |
|------------|--|---------|--|
| namespace | http://xml.ir-d.de/irdma | | |
| type | restriction of string | | |
| properties | base xs:string | | |
| facets | Kind | Value | Annotation |
| | enumeration | 0212001 | documentation Hüfte |
| | enumeration | 0212002 | documentation Knie |
| | enumeration | 0212003 | documentation Totaler Femurersatz inkl. Durchsteck-Prothese |
| annotation | documentation Kat_EP_Gelenk | | |
| source | <pre> <simpleType name="enum_0212"> <annotation> <documentation>Kat_EP_Gelenk</documentation> </annotation> <restriction base="xs:string"> <enumeration value="0212001"> <annotation> <documentation>Hüfte</documentation> </annotation> </enumeration> <enumeration value="0212002"> <annotation> <documentation>Knie</documentation> </annotation> </enumeration> <enumeration value="0212003"> <annotation> <documentation>Totaler Femurersatz inkl. Durchsteck-Prothese</documentation> </annotation> </enumeration> </restriction> </simpleType> </pre> | | |

simpleType enum_0220

| | | | |
|------------|------------------------------|---------|--------------------------------|
| namespace | http://xml.ir-d.de/irdma | | |
| type | restriction of string | | |
| properties | base xs:string | | |
| facets | Kind | Value | Annotation |
| | enumeration | 0220001 | documentation anterior |
| | enumeration | 0220002 | documentation anterolateral |
| | enumeration | 0220003 | documentation lateral |
| | enumeration | 0220004 | documentation |

| | |
|------------|---|
| | <p>enumeration 0220005 posterior documentation posterolateral</p> <p>enumeration 0220006 documentation 2-Inzisionen-Zugang</p> <p>enumeration 0220042 documentation sonstiges/unbekannt</p> |
| annotation | documentation Kat_EP_Operationszugang |
| source | <pre> <simpleType name="enum_0220"> <annotation> <documentation>Kat_EP_Operationszugang</documentation> </annotation> <restriction base="xs:string"> <enumeration value="0220001"> <annotation> <documentation>anterior</documentation> </annotation> </enumeration> <enumeration value="0220002"> <annotation> <documentation>anterolateral</documentation> </annotation> </enumeration> <enumeration value="0220003"> <annotation> <documentation>lateral</documentation> </annotation> </enumeration> <enumeration value="0220004"> <annotation> <documentation>posterior</documentation> </annotation> </enumeration> <enumeration value="0220005"> <annotation> <documentation>posterolateral</documentation> </annotation> </enumeration> <enumeration value="0220006"> <annotation> <documentation>2-Inzisionen-Zugang</documentation> </annotation> </enumeration> <enumeration value="0220042"> <annotation> <documentation>sonstiges/unbekannt</documentation> </annotation> </enumeration> </restriction> </simpleType> </pre> |

simpleType enum_0222

| | |
|------------|------------------------------|
| namespace | http://xml.ir-d.de/irdma |
| type | restriction of string |
| properties | base xs:string |

| facets | <table border="1"> <thead> <tr> <th>Kind</th> <th>Value</th> <th>Annotation</th> </tr> </thead> <tbody> <tr> <td>enumeration</td> <td>0222001</td> <td>documentation nein</td> </tr> <tr> <td>enumeration</td> <td>0222002</td> <td>documentation ja- Ausbau</td> </tr> <tr> <td>enumeration</td> <td>0222003</td> <td>documentation ja- Einbau</td> </tr> </tbody> </table> | Kind | Value | Annotation | enumeration | 0222001 | documentation nein | enumeration | 0222002 | documentation ja- Ausbau | enumeration | 0222003 | documentation ja- Einbau |
|-------------|---|-----------------------------|-------|------------|-------------|---------|-----------------------|-------------|---------|-----------------------------|-------------|---------|-----------------------------|
| Kind | Value | Annotation | | | | | | | | | | | |
| enumeration | 0222001 | documentation nein | | | | | | | | | | | |
| enumeration | 0222002 | documentation ja- Ausbau | | | | | | | | | | | |
| enumeration | 0222003 | documentation ja- Einbau | | | | | | | | | | | |
| annotation | documentation Kat_EP_Zweizeitwechsel | | | | | | | | | | | | |
| source | <pre> <simpleType name="enum_0222"> <annotation> <documentation>Kat_EP_Zweizeitwechsel</documentation> </annotation> <restriction base="xs:string"> <enumeration value="0222001"> <annotation> <documentation>nein</documentation> </annotation> </enumeration> <enumeration value="0222002"> <annotation> <documentation>ja- Ausbau</documentation> </annotation> </enumeration> <enumeration value="0222003"> <annotation> <documentation>ja- Einbau</documentation> </annotation> </enumeration> </restriction> </simpleType> </pre> | | | | | | | | | | | | |

simpleType enum_0230

| namespace | http://xml.ir-d.de/irdma | | | | | | | | | | | | | | | | | | | | | | | | | | | | | | | | | | | | |
|-------------|--|---|-------|------------|-------------|---------|--------------------------------------|-------------|---------|---|-------------|---------|------------------------------|-------------|---------|-------------------------|-------------|---------|-----------------------------------|-------------|---------|---------------------------------|-------------|---------|---------------------------------------|-------------|---------|---------------------------------|-------------|---------|-----------------------------------|-------------|---------|--|-------------|---------|---------------|
| type | restriction of string | | | | | | | | | | | | | | | | | | | | | | | | | | | | | | | | | | | | |
| properties | base xs:string | | | | | | | | | | | | | | | | | | | | | | | | | | | | | | | | | | | | |
| facets | <table border="1"> <thead> <tr> <th>Kind</th> <th>Value</th> <th>Annotation</th> </tr> </thead> <tbody> <tr> <td>enumeration</td> <td>0230001</td> <td>documentation Smith & Nephew GmbH</td> </tr> <tr> <td>enumeration</td> <td>0230002</td> <td>documentation Mathys Orthopädie GmbH</td> </tr> <tr> <td>enumeration</td> <td>0230003</td> <td>documentation Ceramtec AG</td> </tr> <tr> <td>enumeration</td> <td>0230004</td> <td>documentation Biomet</td> </tr> <tr> <td>enumeration</td> <td>0230005</td> <td>documentation Peter Brehm GmbH</td> </tr> <tr> <td>enumeration</td> <td>0230006</td> <td>documentation Amplitude GmbH</td> </tr> <tr> <td>enumeration</td> <td>0230007</td> <td>documentation Exactech Deutschland</td> </tr> <tr> <td>enumeration</td> <td>0230008</td> <td>documentation Globus Medical</td> </tr> <tr> <td>enumeration</td> <td>0230009</td> <td>documentation Implantcast GmbH</td> </tr> <tr> <td>enumeration</td> <td>0230010</td> <td>documentation DePuy Orthopädie GmbH</td> </tr> <tr> <td>enumeration</td> <td>0230011</td> <td>documentation</td> </tr> </tbody> </table> | Kind | Value | Annotation | enumeration | 0230001 | documentation Smith & Nephew GmbH | enumeration | 0230002 | documentation Mathys Orthopädie GmbH | enumeration | 0230003 | documentation Ceramtec AG | enumeration | 0230004 | documentation Biomet | enumeration | 0230005 | documentation Peter Brehm GmbH | enumeration | 0230006 | documentation Amplitude GmbH | enumeration | 0230007 | documentation Exactech Deutschland | enumeration | 0230008 | documentation Globus Medical | enumeration | 0230009 | documentation Implantcast GmbH | enumeration | 0230010 | documentation DePuy Orthopädie GmbH | enumeration | 0230011 | documentation |
| Kind | Value | Annotation | | | | | | | | | | | | | | | | | | | | | | | | | | | | | | | | | | | |
| enumeration | 0230001 | documentation Smith & Nephew GmbH | | | | | | | | | | | | | | | | | | | | | | | | | | | | | | | | | | | |
| enumeration | 0230002 | documentation Mathys Orthopädie GmbH | | | | | | | | | | | | | | | | | | | | | | | | | | | | | | | | | | | |
| enumeration | 0230003 | documentation Ceramtec AG | | | | | | | | | | | | | | | | | | | | | | | | | | | | | | | | | | | |
| enumeration | 0230004 | documentation Biomet | | | | | | | | | | | | | | | | | | | | | | | | | | | | | | | | | | | |
| enumeration | 0230005 | documentation Peter Brehm GmbH | | | | | | | | | | | | | | | | | | | | | | | | | | | | | | | | | | | |
| enumeration | 0230006 | documentation Amplitude GmbH | | | | | | | | | | | | | | | | | | | | | | | | | | | | | | | | | | | |
| enumeration | 0230007 | documentation Exactech Deutschland | | | | | | | | | | | | | | | | | | | | | | | | | | | | | | | | | | | |
| enumeration | 0230008 | documentation Globus Medical | | | | | | | | | | | | | | | | | | | | | | | | | | | | | | | | | | | |
| enumeration | 0230009 | documentation Implantcast GmbH | | | | | | | | | | | | | | | | | | | | | | | | | | | | | | | | | | | |
| enumeration | 0230010 | documentation DePuy Orthopädie GmbH | | | | | | | | | | | | | | | | | | | | | | | | | | | | | | | | | | | |
| enumeration | 0230011 | documentation | | | | | | | | | | | | | | | | | | | | | | | | | | | | | | | | | | | |

| | | | |
|--|-------------|---------|--|
| | enumeration | 0230012 | IO-International Orthopaedics documentation Joint Replacement Ltd. Instrumentation |
| | enumeration | 0230013 | documentation Merete |
| | enumeration | 0230014 | documentation S&G Implants GmbH |
| | enumeration | 0230015 | documentation Speetec Implantate GmbH |
| | enumeration | 0230016 | documentation Stemcup Medical Products GmbH |
| | enumeration | 0230017 | documentation Symbios Deutschland GmbH |
| | enumeration | 0230018 | documentation Tantum AG |
| | enumeration | 0230019 | documentation Tomier GmbH |
| | enumeration | 0230020 | documentation MicroPort Orthopedics GmbH |
| | enumeration | 0230021 | documentation aap Implanate AG |
| | enumeration | 0230022 | documentation AQImplants |
| | enumeration | 0230023 | documentation ESKA Orthodynamics GmbH |
| | enumeration | 0230024 | documentation Atecos medical AG |
| | enumeration | 0230025 | documentation Chiropro GmbH |
| | enumeration | 0230026 | documentation Medacta |
| | enumeration | 0230027 | documentation OHST Medizintechnik AG |
| | enumeration | 0230028 | documentation Lima Deutschland GmbH |
| | enumeration | 0230029 | documentation alloPlus GmbH |
| | enumeration | 0230030 | documentation Heraeus Medical GmbH |
| | enumeration | 0230031 | documentation ImplanTec Deutschland GmbH |
| | enumeration | 0230032 | documentation Falcon Medical GmbH |
| | enumeration | 0230033 | documentation Meril GmbH |
| | enumeration | 0230034 | documentation Zimmer Germany GmbH |
| | enumeration | 0230035 | documentation Stryker GmbH & Co. KG |
| | enumeration | 0230036 | documentation Aesculap AG |
| | enumeration | 0230037 | documentation Waldemar Link GmbH & Co. KG |
| | enumeration | 0230038 | documentation Corin Germany GmbH |
| | enumeration | 0230039 | documentation nicht belegter Wert |
| | enumeration | 0230040 | documentation nicht belegter Wert |
| | enumeration | 0230041 | documentation nicht belegter Wert |
| | enumeration | 0230042 | documentation sonstige |
| | enumeration | 0230043 | documentation nicht belegter Wert |

| | |
|------------|---|
| | enumeration 0230044 documentation nicht belegter Wert |
| annotation | documentation Kat_EP_Hersteller |
| source | <pre> <simpleType name="enum_0230"> <annotation> <documentation>Kat_EP_Hersteller</documentation> </annotation> <restriction base="xs:string"> <enumeration value="0230001"> <annotation> <documentation>Smith & Nephew GmbH</documentation> </annotation> </enumeration> <enumeration value="0230002"> <annotation> <documentation>Mathys Orthopädie GmbH</documentation> </annotation> </enumeration> <enumeration value="0230003"> <annotation> <documentation>Ceramtec AG</documentation> </annotation> </enumeration> <enumeration value="0230004"> <annotation> <documentation>Biomet</documentation> </annotation> </enumeration> <enumeration value="0230005"> <annotation> <documentation>Peter Brehm GmbH</documentation> </annotation> </enumeration> <enumeration value="0230006"> <annotation> <documentation>Amplitude GmbH</documentation> </annotation> </enumeration> <enumeration value="0230007"> <annotation> <documentation>Exactech Deutschland</documentation> </annotation> </enumeration> <enumeration value="0230008"> <annotation> <documentation>Globus Medical</documentation> </annotation> </enumeration> <enumeration value="0230009"> <annotation> <documentation>Implantcast GmbH</documentation> </annotation> </enumeration> <enumeration value="0230010"> <annotation> <documentation>DePuy Orthopädie GmbH</documentation> </annotation> </enumeration> </restriction> </simpleType> </pre> |

```
<enumeration value="0230011">
  <annotation>
    <documentation>IO-International Orthopaedics</documentation>
  </annotation>
</enumeration>
<enumeration value="0230012">
  <annotation>
    <documentation>Joint Replacement Ltd. Instrumentation</documentation>
  </annotation>
</enumeration>
<enumeration value="0230013">
  <annotation>
    <documentation>Merete</documentation>
  </annotation>
</enumeration>
<enumeration value="0230014">
  <annotation>
    <documentation>S&amp;G Implants GmbH</documentation>
  </annotation>
</enumeration>
<enumeration value="0230015">
  <annotation>
    <documentation>Speetec Implantate GmbH</documentation>
  </annotation>
</enumeration>
<enumeration value="0230016">
  <annotation>
    <documentation>Stemcup Medical Products GmbH</documentation>
  </annotation>
</enumeration>
<enumeration value="0230017">
  <annotation>
    <documentation>Symbios Deutschland GmbH</documentation>
  </annotation>
</enumeration>
<enumeration value="0230018">
  <annotation>
    <documentation>Tantum AG</documentation>
  </annotation>
</enumeration>
<enumeration value="0230019">
  <annotation>
    <documentation>Tornier GmbH</documentation>
  </annotation>
</enumeration>
<enumeration value="0230020">
  <annotation>
    <documentation>MicroPort Orthopedics GmbH</documentation>
  </annotation>
</enumeration>
<enumeration value="0230021">
  <annotation>
    <documentation>aap Implanate AG</documentation>
  </annotation>
</enumeration>
<enumeration value="0230022">
  <annotation>
    <documentation>AQImplants</documentation>
  </annotation>
</enumeration>
```

```
</enumeration>
<enumeration value="0230023">
  <annotation>
    <documentation>ESKA Orthodynamics GmbH</documentation>
  </annotation>
</enumeration>
<enumeration value="0230024">
  <annotation>
    <documentation>Atecos medical AG</documentation>
  </annotation>
</enumeration>
<enumeration value="0230025">
  <annotation>
    <documentation>Chiropro GmbH</documentation>
  </annotation>
</enumeration>
<enumeration value="0230026">
  <annotation>
    <documentation>Medacta</documentation>
  </annotation>
</enumeration>
<enumeration value="0230027">
  <annotation>
    <documentation>OHST Medizintechnik AG</documentation>
  </annotation>
</enumeration>
<enumeration value="0230028">
  <annotation>
    <documentation>Lima Deutschland GmbH</documentation>
  </annotation>
</enumeration>
<enumeration value="0230029">
  <annotation>
    <documentation>alloPlus GmbH</documentation>
  </annotation>
</enumeration>
<enumeration value="0230030">
  <annotation>
    <documentation>Heraeus Medical GmbH</documentation>
  </annotation>
</enumeration>
<enumeration value="0230031">
  <annotation>
    <documentation>ImplanTec Deutschland GmbH</documentation>
  </annotation>
</enumeration>
<enumeration value="0230032">
  <annotation>
    <documentation>Falcon Medical GmbH</documentation>
  </annotation>
</enumeration>
<enumeration value="0230033">
  <annotation>
    <documentation>Meril GmbH</documentation>
  </annotation>
</enumeration>
<enumeration value="0230034">
  <annotation>
    <documentation>Zimmer Germany GmbH</documentation>
  </annotation>
</enumeration>
```

```

</annotation>
</enumeration>
<enumeration value="0230035">
  <annotation>
    <documentation>Stryker GmbH & Co. KG</documentation>
  </annotation>
</enumeration>
<enumeration value="0230036">
  <annotation>
    <documentation>Aesculap AG</documentation>
  </annotation>
</enumeration>
<enumeration value="0230037">
  <annotation>
    <documentation>Waldemar Link GmbH & Co. KG</documentation>
  </annotation>
</enumeration>
<enumeration value="0230038">
  <annotation>
    <documentation>Corin Germany GmbH</documentation>
  </annotation>
</enumeration>
<enumeration value="0230039">
  <annotation>
    <documentation>nicht belegter Wert</documentation>
  </annotation>
</enumeration>
<enumeration value="0230040">
  <annotation>
    <documentation>nicht belegter Wert</documentation>
  </annotation>
</enumeration>
<enumeration value="0230041">
  <annotation>
    <documentation>nicht belegter Wert</documentation>
  </annotation>
</enumeration>
<enumeration value="0230042">
  <annotation>
    <documentation>sonstige</documentation>
  </annotation>
</enumeration>
<enumeration value="0230043">
  <annotation>
    <documentation>nicht belegter Wert</documentation>
  </annotation>
</enumeration>
<enumeration value="0230044">
  <annotation>
    <documentation>nicht belegter Wert</documentation>
  </annotation>
</enumeration>
</restriction>
</simpleType>

```

simpleType enum_0252

| | |
|-----------|--------------------------|
| namespace | http://xml.ir-d.de/irdma |
|-----------|--------------------------|

| type | restriction of string | | | | | | | | | | | | |
|-------------|--|-------------------------|-------|------------|-------------|---------|-------------------------|-------------|---------|-------------------------|-------------|---------|-------------------------|
| properties | base xs:string | | | | | | | | | | | | |
| facets | <table border="1"> <thead> <tr> <th>Kind</th> <th>Value</th> <th>Annotation</th> </tr> </thead> <tbody> <tr> <td>enumeration</td> <td>0252001</td> <td>documentation Pfanne</td> </tr> <tr> <td>enumeration</td> <td>0252002</td> <td>documentation Schaft</td> </tr> <tr> <td>enumeration</td> <td>0252003</td> <td>documentation beides</td> </tr> </tbody> </table> | Kind | Value | Annotation | enumeration | 0252001 | documentation Pfanne | enumeration | 0252002 | documentation Schaft | enumeration | 0252003 | documentation beides |
| Kind | Value | Annotation | | | | | | | | | | | |
| enumeration | 0252001 | documentation Pfanne | | | | | | | | | | | |
| enumeration | 0252002 | documentation Schaft | | | | | | | | | | | |
| enumeration | 0252003 | documentation beides | | | | | | | | | | | |
| annotation | documentation Kat_EP_KomponenteHuefte | | | | | | | | | | | | |
| source | <pre> <simpleType name="enum_0252"> <annotation> <documentation>Kat_EP_KomponenteHuefte</documentation> </annotation> <restriction base="xs:string"> <enumeration value="0252001"> <annotation> <documentation>Pfanne</documentation> </annotation> </enumeration> <enumeration value="0252002"> <annotation> <documentation>Schaft</documentation> </annotation> </enumeration> <enumeration value="0252003"> <annotation> <documentation>beides</documentation> </annotation> </enumeration> </restriction> </simpleType> </pre> | | | | | | | | | | | | |

simpleType **enum_0254**

| namespace | http://xml.ir-d.de/irdma | | | | | | | | | | | | | | | |
|-------------|---|--------------------------|-------|------------|-------------|---------|------------------------|-------------|---------|------------------------|-------------|---------|--------------------------|-------------|---------|--------------------------|
| type | restriction of string | | | | | | | | | | | | | | | |
| properties | base xs:string | | | | | | | | | | | | | | | |
| facets | <table border="1"> <thead> <tr> <th>Kind</th> <th>Value</th> <th>Annotation</th> </tr> </thead> <tbody> <tr> <td>enumeration</td> <td>0254001</td> <td>documentation Femur</td> </tr> <tr> <td>enumeration</td> <td>0254002</td> <td>documentation Tibia</td> </tr> <tr> <td>enumeration</td> <td>0254003</td> <td>documentation Patella</td> </tr> <tr> <td>enumeration</td> <td>0254004</td> <td>documentation mehrere</td> </tr> </tbody> </table> | Kind | Value | Annotation | enumeration | 0254001 | documentation Femur | enumeration | 0254002 | documentation Tibia | enumeration | 0254003 | documentation Patella | enumeration | 0254004 | documentation mehrere |
| Kind | Value | Annotation | | | | | | | | | | | | | | |
| enumeration | 0254001 | documentation Femur | | | | | | | | | | | | | | |
| enumeration | 0254002 | documentation Tibia | | | | | | | | | | | | | | |
| enumeration | 0254003 | documentation Patella | | | | | | | | | | | | | | |
| enumeration | 0254004 | documentation mehrere | | | | | | | | | | | | | | |
| annotation | documentation Kat_EP_KomponenteKnie | | | | | | | | | | | | | | | |
| source | <pre> <simpleType name="enum_0254"> <annotation> <documentation>Kat_EP_KomponenteKnie</documentation> </annotation> <restriction base="xs:string"> <enumeration value="0254001"> </pre> | | | | | | | | | | | | | | | |

| | |
|--|---|
| | <pre> <annotation> <documentation>Femur</documentation> </annotation> </enumeration> <enumeration value="0254002"> <annotation> <documentation>Tibia</documentation> </annotation> </enumeration> <enumeration value="0254003"> <annotation> <documentation>Patella</documentation> </annotation> </enumeration> <enumeration value="0254004"> <annotation> <documentation>mehrere</documentation> </annotation> </enumeration> </restriction> </simpleType> </pre> |
|--|---|

simpleType enum 0256

| | | | |
|------------|---|---------|------------------------------------|
| namespace | http://xml.ir-d.de/irdma | | |
| type | restriction of string | | |
| properties | base xs:string | | |
| facets | Kind | Value | Annotation |
| | enumeration | 0256001 | documentation Pfanne |
| | enumeration | 0256002 | documentation Schaft |
| | enumeration | 0256003 | documentation Pfanne und Schaft |
| | enumeration | 0256004 | documentation Femur |
| | enumeration | 0256005 | documentation Tibia |
| | enumeration | 0256006 | documentation Patella |
| | enumeration | 0256007 | documentation mehrere |
| annotation | documentation Kat_EP_KomponenteTFE | | |
| source | <pre> <simpleType name="enum_0256"> <annotation> <documentation>Kat_EP_KomponenteTFE</documentation> </annotation> <restriction base="xs:string"> <enumeration value="0256001"> <annotation> <documentation>Pfanne</documentation> </annotation> </enumeration> <enumeration value="0256002"> <annotation> <documentation>Schaft</documentation> </pre> | | |

```

</annotation>
</enumeration>
<enumeration value="0256003">
  <annotation>
    <documentation>Pfanne und Schaft</documentation>
  </annotation>
</enumeration>
<enumeration value="0256004">
  <annotation>
    <documentation>Femur</documentation>
  </annotation>
</enumeration>
<enumeration value="0256005">
  <annotation>
    <documentation>Tibia</documentation>
  </annotation>
</enumeration>
<enumeration value="0256006">
  <annotation>
    <documentation>Patella</documentation>
  </annotation>
</enumeration>
<enumeration value="0256007">
  <annotation>
    <documentation>mehrere</documentation>
  </annotation>
</enumeration>
</restriction>
</simpleType>

```

simpleType enum_0262

| | | | |
|------------|---|---------|--------------------------|
| namespace | http://xml.ir-d.de/irdma | | |
| type | restriction of string | | |
| properties | base xs:string | | |
| facets | Kind | Value | Annotation |
| | enumeration | 0262001 | documentation Pfanne |
| | enumeration | 0262002 | documentation Schaft |
| | enumeration | 0262003 | documentation Kopf |
| | enumeration | 0262004 | documentation Inlay |
| | enumeration | 0262005 | documentation Adapter |
| | enumeration | 0262006 | documentation mehrere |
| annotation | documentation Kat_EP_ImplantatbruchHuefte | | |
| source | <simpleType name="enum_0262"> <annotation> <documentation>Kat_EP_ImplantatbruchHuefte</documentation> </annotation> <restriction base="xs:string"> <enumeration value="0262001"> <annotation> | | |

```

        <documentation>Pfanne</documentation>
    </annotation>
</enumeration>
<enumeration value="0262002">
    <annotation>
        <documentation>Schaft</documentation>
    </annotation>
</enumeration>
<enumeration value="0262003">
    <annotation>
        <documentation>Kopf</documentation>
    </annotation>
</enumeration>
<enumeration value="0262004">
    <annotation>
        <documentation>Inlay</documentation>
    </annotation>
</enumeration>
<enumeration value="0262005">
    <annotation>
        <documentation>Adapter</documentation>
    </annotation>
</enumeration>
<enumeration value="0262006">
    <annotation>
        <documentation>mehrere</documentation>
    </annotation>
</enumeration>
</restriction>
</simpleType>

```

simpleType enum_0264

| | | | |
|------------|--|---------|-------------------------------|
| namespace | http://xml.ir-d.de/irdma | | |
| type | restriction of string | | |
| properties | base xs:string | | |
| facets | Kind | Value | Annotation |
| | enumeration | 0264001 | documentation Femur |
| | enumeration | 0264002 | documentation Tibia |
| | enumeration | 0264003 | documentation Inlay |
| | enumeration | 0264004 | documentation Adapter |
| | enumeration | 0264005 | documentation Verlängerung |
| | enumeration | 0264006 | documentation Schrauben |
| | enumeration | 0264007 | documentation mehrere |
| | enumeration | 0264042 | documentation andere |
| annotation | documentation Kat_EP_ImplantatbruchKnie | | |
| source | <pre> <simpleType name="enum_0264"> <annotation> <documentation>Kat EP ImplantatbruchKnie</documentation> </pre> | | |

```

</annotation>
<restriction base="xs:string">
  <enumeration value="0264001">
    <annotation>
      <documentation>Femur</documentation>
    </annotation>
  </enumeration>
  <enumeration value="0264002">
    <annotation>
      <documentation>Tibia</documentation>
    </annotation>
  </enumeration>
  <enumeration value="0264003">
    <annotation>
      <documentation>Inlay</documentation>
    </annotation>
  </enumeration>
  <enumeration value="0264004">
    <annotation>
      <documentation>Adapter</documentation>
    </annotation>
  </enumeration>
  <enumeration value="0264005">
    <annotation>
      <documentation>Verlängerung</documentation>
    </annotation>
  </enumeration>
  <enumeration value="0264006">
    <annotation>
      <documentation>Schrauben</documentation>
    </annotation>
  </enumeration>
  <enumeration value="0264007">
    <annotation>
      <documentation>mehrere</documentation>
    </annotation>
  </enumeration>
  <enumeration value="0264042">
    <annotation>
      <documentation>andere</documentation>
    </annotation>
  </enumeration>
</restriction>
</simpleType>

```

simpleType enum_0266

| | | | |
|------------|------------------------------|---------|-------------------------|
| namespace | http://xml.ir-d.de/irdma | | |
| type | restriction of string | | |
| properties | base xs:string | | |
| facets | Kind | Value | Annotation |
| | enumeration | 0266001 | documentation Pfanne |
| | enumeration | 0266002 | documentation Schaft |
| | enumeration | 0266003 | documentation Kopf |

| | |
|------------|---|
| | <p>enumeration 0266004 documentation Inlay</p> <p>enumeration 0266005 documentation Adapter</p> <p>enumeration 0266006 documentation Femur</p> <p>enumeration 0266007 documentation Tibia</p> <p>enumeration 0266008 documentation Verlängerung</p> <p>enumeration 0266009 documentation Schrauben</p> <p>enumeration 0266010 documentation mehrere</p> <p>enumeration 0266042 documentation andere</p> |
| annotation | documentation Kat_EP_ImplantatbruchTFE |
| source | <pre> <simpleType name="enum_0266"> <annotation> <documentation>Kat_EP_ImplantatbruchTFE</documentation> </annotation> <restriction base="xs:string"> <enumeration value="0266001"> <annotation> <documentation>Pfanne</documentation> </annotation> </enumeration> <enumeration value="0266002"> <annotation> <documentation>Schaft</documentation> </annotation> </enumeration> <enumeration value="0266003"> <annotation> <documentation>Kopf</documentation> </annotation> </enumeration> <enumeration value="0266004"> <annotation> <documentation>Inlay</documentation> </annotation> </enumeration> <enumeration value="0266005"> <annotation> <documentation>Adapter</documentation> </annotation> </enumeration> <enumeration value="0266006"> <annotation> <documentation>Femur</documentation> </annotation> </enumeration> <enumeration value="0266007"> <annotation> <documentation>Tibia</documentation> </annotation> </enumeration> <enumeration value="0266008"> <annotation> </pre> |

| | |
|--|--|
| | <pre> <documentation>Verlängerung</documentation> </annotation> </enumeration> <enumeration value="0266009"> <annotation> <documentation>Schrauben</documentation> </annotation> </enumeration> <enumeration value="0266010"> <annotation> <documentation>mehrere</documentation> </annotation> </enumeration> <enumeration value="0266042"> <annotation> <documentation>andere</documentation> </annotation> </enumeration> </restriction> </simpleType> </pre> |
|--|--|

simpleType enum_0270

| | | | |
|------------|---|---------|---------------------------------------|
| namespace | http://xml.ir-d.de/irdma | | |
| type | restriction of string | | |
| properties | base xs:string | | |
| facets | Kind | Value | Annotation |
| | enumeration | 0270001 | documentation PE-Inlay |
| | enumeration | 0270002 | documentation patellare Komponente |
| | enumeration | 0270003 | documentation beides |
| annotation | documentation Kat_EP_VerschleissKnie | | |
| source | <pre> <simpleType name="enum_0270"> <annotation> <documentation>Kat_EP_VerschleissKnie</documentation> </annotation> <restriction base="xs:string"> <enumeration value="0270001"> <annotation> <documentation>PE-Inlay</documentation> </annotation> </enumeration> <enumeration value="0270002"> <annotation> <documentation>patellare Komponente</documentation> </annotation> </enumeration> <enumeration value="0270003"> <annotation> <documentation>beides</documentation> </annotation> </enumeration> </restriction> </pre> | | |

| | |
|--|----------------------------------|
| | <code></simpleType></code> |
|--|----------------------------------|

simpleType enum_0271

| namespace | http://xml.ir-d.de/irdma | | | | | | | | | | | | | | | | | | | | | |
|-------------|---|---------------------------------------|-------|------------|-------------|---------|---------------------------|-------------|---------|------------------------|-------------|---------|---------------------------------------|-------------|---------|---------------------------|-------------|---------|--------------------------|-------------|---------|-------------------------|
| type | restriction of string | | | | | | | | | | | | | | | | | | | | | |
| properties | base xs:string | | | | | | | | | | | | | | | | | | | | | |
| facets | <table><thead><tr><th>Kind</th><th>Value</th><th>Annotation</th></tr></thead><tbody><tr><td>enumeration</td><td>0271001</td><td>documentation Schraube</td></tr><tr><td>enumeration</td><td>0271002</td><td>documentation Inlay</td></tr><tr><td>enumeration</td><td>0271003</td><td>documentation patellare Komponente</td></tr><tr><td>enumeration</td><td>0271004</td><td>documentation Kopplung</td></tr><tr><td>enumeration</td><td>0271005</td><td>documentation mehrere</td></tr><tr><td>enumeration</td><td>0271042</td><td>documentation andere</td></tr></tbody></table> | Kind | Value | Annotation | enumeration | 0271001 | documentation Schraube | enumeration | 0271002 | documentation Inlay | enumeration | 0271003 | documentation patellare Komponente | enumeration | 0271004 | documentation Kopplung | enumeration | 0271005 | documentation mehrere | enumeration | 0271042 | documentation andere |
| Kind | Value | Annotation | | | | | | | | | | | | | | | | | | | | |
| enumeration | 0271001 | documentation Schraube | | | | | | | | | | | | | | | | | | | | |
| enumeration | 0271002 | documentation Inlay | | | | | | | | | | | | | | | | | | | | |
| enumeration | 0271003 | documentation patellare Komponente | | | | | | | | | | | | | | | | | | | | |
| enumeration | 0271004 | documentation Kopplung | | | | | | | | | | | | | | | | | | | | |
| enumeration | 0271005 | documentation mehrere | | | | | | | | | | | | | | | | | | | | |
| enumeration | 0271042 | documentation andere | | | | | | | | | | | | | | | | | | | | |
| annotation | documentation Kat_EP_MigrationKnie | | | | | | | | | | | | | | | | | | | | | |
| source | <pre><simpleType name="enum_0271"> <annotation> <documentation>Kat_EP_MigrationKnie</documentation> </annotation> <restriction base="xs:string"> <enumeration value="0271001"> <annotation> <documentation>Schraube</documentation> </annotation> </enumeration> <enumeration value="0271002"> <annotation> <documentation>Inlay</documentation> </annotation> </enumeration> <enumeration value="0271003"> <annotation> <documentation>patellare Komponente</documentation> </annotation> </enumeration> <enumeration value="0271004"> <annotation> <documentation>Kopplung</documentation> </annotation> </enumeration> <enumeration value="0271005"> <annotation> <documentation>mehrere</documentation> </annotation> </enumeration> <enumeration value="0271042"> <annotation> <documentation>andere</documentation> </annotation> </enumeration> </restriction> </simpleType></pre> | | | | | | | | | | | | | | | | | | | | | |

| | |
|--|---|
| | <pre> </restriction> </simpleType> </pre> |
|--|---|

simpleType enum_0290

| | | | |
|------------|--|---------|---|
| namespace | http://xml.ir-d.de/irdma | | |
| type | restriction of string | | |
| properties | base xs:string | | |
| facets | Kind | Value | Annotation |
| | enumeration | 0290001 | documentation Hüft-Komponente |
| | enumeration | 0290002 | documentation Knie-Komponente |
| | enumeration | 0290003 | documentation Modulare Komponente (Hüfte/Knie) |
| annotation | documentation Kat_EP_Artikeltyp | | |
| source | <pre> <simpleType name="enum_0290"> <annotation> <documentation>Kat_EP_Artikeltyp</documentation> </annotation> <restriction base="xs:string"> <enumeration value="0290001"> <annotation> <documentation>Hüft-Komponente</documentation> </annotation> </enumeration> <enumeration value="0290002"> <annotation> <documentation>Knie-Komponente</documentation> </annotation> </enumeration> <enumeration value="0290003"> <annotation> <documentation>Modulare Komponente (Hüfte/Knie)</documentation> </annotation> </enumeration> </restriction> </simpleType> </pre> | | |

simpleType enum_0291

| | | | |
|------------|---|---------|------------------------------------|
| namespace | http://xml.ir-d.de/irdma | | |
| type | restriction of string | | |
| properties | base xs:string | | |
| facets | Kind | Value | Annotation |
| | enumeration | 0291001 | documentation Knochen-Zement |
| | enumeration | 0291002 | documentation sonstiges Zubehör |
| annotation | documentation Kat_EP_ZubehoerTyp | | |
| source | <pre> <simpleType name="enum_0291"> <annotation> </pre> | | |

| | |
|--|---|
| | <pre> <documentation>Kat_EP_ZubehoerTyp</documentation> </annotation> <restriction base="xs:string"> <enumeration value="0291001"> <annotation> <documentation>Knochen-Zement</documentation> </annotation> </enumeration> <enumeration value="0291002"> <annotation> <documentation>sonstiges Zubehör</documentation> </annotation> </enumeration> </restriction> </simpleType> </pre> |
|--|---|

simpleType enum_0300

| | | | |
|------------|---|---------|---|
| namespace | http://xml.ir-d.de/irdma | | |
| type | restriction of string | | |
| properties | base xs:string | | |
| facets | Kind | Value | Annotation |
| | enumeration | 0300001 | documentation konventionieller Aortenklappenersatz |
| | enumeration | 0300002 | documentation kathetergestützte Aortenklappenimplantation (TAVI) |
| annotation | documentation Kat_AK_ArtEingriff | | |
| source | <pre> <simpleType name="enum_0300"> <annotation> <documentation>Kat_AK_ArtEingriff</documentation> </annotation> <restriction base="xs:string"> <enumeration value="0300001"> <annotation> <documentation>konventionieller Aortenklappenersatz</documentation> </annotation> </enumeration> <enumeration value="0300002"> <annotation> <documentation>kathetergestützte Aortenklappenimplantation (TAVI)</documentation> </annotation> </enumeration> </restriction> </simpleType> </pre> | | |

simpleType enum_0302

| | | | |
|------------|------------------------------|---------|---------------|
| namespace | http://xml.ir-d.de/irdma | | |
| type | restriction of string | | |
| properties | base xs:string | | |
| facets | Kind | Value | Annotation |
| | enumeration | 0302001 | documentation |

| | |
|------------|--|
| | enumeration 0302002 Stenose documentation Insuffizienz enumeration 0302003 documentation Stenose und Insuffizienz |
| annotation | documentation Kat_AK_GrundEingriff |
| source | <pre> <simpleType name="enum_0302"> <annotation> <documentation>Kat_AK_GrundEingriff</documentation> </annotation> <restriction base="xs:string"> <enumeration value="0302001"> <annotation> <documentation>Stenose</documentation> </annotation> </enumeration> <enumeration value="0302002"> <annotation> <documentation>Insuffizienz</documentation> </annotation> </enumeration> <enumeration value="0302003"> <annotation> <documentation>Stenose und Insuffizienz</documentation> </annotation> </enumeration> </restriction> </simpleType> </pre> |

simpleType enum 0318

| | | | |
|------------|---|---------|-------------------------------------|
| namespace | http://xml.ir-d.de/irdma | | |
| type | restriction of string | | |
| properties | base xs:string | | |
| facets | Kind | Value | Annotation |
| | enumeration | 0318001 | documentation transapikal |
| | enumeration | 0318002 | documentation transaortal |
| | enumeration | 0318003 | documentation transfemoral |
| | enumeration | 0318004 | documentation transaxillär |
| | enumeration | 0318042 | documentation anderer Zugangsweg |
| annotation | documentation Kat_AK_ZugangKatheter | | |
| source | <pre> <simpleType name="enum_0318"> <annotation> <documentation>Kat_AK_ZugangKatheter</documentation> </annotation> <restriction base="xs:string"> <enumeration value="0318001"> <annotation> <documentation>transapikal</documentation> </annotation> </pre> | | |

| | |
|--|---|
| | <pre> </enumeration> <enumeration value="0318002"> <annotation> <documentation>transaortal</documentation> </annotation> </enumeration> <enumeration value="0318003"> <annotation> <documentation>transfemoral</documentation> </annotation> </enumeration> <enumeration value="0318004"> <annotation> <documentation>transaxillär</documentation> </annotation> </enumeration> <enumeration value="0318042"> <annotation> <documentation>anderer Zugangsweg</documentation> </annotation> </enumeration> </restriction> </simpleType> </pre> |
|--|---|

simpleType enum_0320

| | | | |
|------------|--|---------|---|
| namespace | http://xml.ir-d.de/irdma | | |
| type | restriction of string | | |
| properties | base xs:string | | |
| facets | Kind | Value | Annotation |
| | enumeration | 0320001 | documentation konventionelle Sternotomie |
| | enumeration | 0320002 | documentation partielle Sternotomie |
| | enumeration | 0320003 | documentation parastemaler Zugang |
| | enumeration | 0320042 | documentation anderer Zugangsweg |
| annotation | documentation Kat_AK_ZugangKonventionell | | |
| source | <pre> <simpleType name="enum_0320"> <annotation> <documentation>Kat_AK_ZugangKonventionell</documentation> </annotation> <restriction base="xs:string"> <enumeration value="0320001"> <annotation> <documentation>konventionelle Sternotomie</documentation> </annotation> </enumeration> <enumeration value="0320002"> <annotation> <documentation>partielle Sternotomie</documentation> </annotation> </enumeration> <enumeration value="0320003"> <annotation> </pre> | | |

| | |
|--|---|
| | <pre> <documentation>parasternaler Zugang</documentation> </annotation> </enumeration> <enumeration value="032004"> <annotation> <documentation>anderer Zugangsweg</documentation> </annotation> </enumeration> </restriction> </simpleType> </pre> |
|--|---|

simpleType enum_0322

| | | | |
|------------|--|---------|--|
| namespace | http://xml.ir-d.de/irdma | | |
| type | restriction of string | | |
| properties | base xs:string | | |
| facets | Kind | Value | Annotation |
| | enumeration | 0322001 | documentation nein |
| | enumeration | 0322002 | documentation ja, diätetisch behandelt |
| | enumeration | 0322003 | documentation ja, orale Medikation |
| | enumeration | 0322004 | documentation ja, mit Insulin behandelt |
| | enumeration | 0322005 | documentation ja, unbehandelt |
| | enumeration | 0322099 | documentation unbekannt |
| annotation | documentation Kat_AK_Diabetes | | |
| source | <pre> <simpleType name="enum_0322"> <annotation> <documentation>Kat_AK_Diabetes</documentation> </annotation> <restriction base="xs:string"> <enumeration value="0322001"> <annotation> <documentation>nein</documentation> </annotation> </enumeration> <enumeration value="0322002"> <annotation> <documentation>ja, diätetisch behandelt</documentation> </annotation> </enumeration> <enumeration value="0322003"> <annotation> <documentation>ja, orale Medikation</documentation> </annotation> </enumeration> <enumeration value="0322004"> <annotation> <documentation>ja, mit Insulin behandelt</documentation> </annotation> </enumeration> <enumeration value="0322005"> </pre> | | |

| | |
|--|---|
| | <pre> <annotation> <documentation>ja, unbehandelt</documentation> </annotation> </enumeration> <enumeration value="0322099"> <annotation> <documentation>unbekannt</documentation> </annotation> </enumeration> </restriction> </simpleType> </pre> |
|--|---|

simpleType enum_0324

| | | | |
|------------|---|---------|---|
| namespace | http://xml.ir-d.de/irdma | | |
| type | restriction of string | | |
| properties | base xs:string | | |
| facets | Kind | Value | Annotation |
| | enumeration | 0324001 | documentation (I): Beschwerdefreiheit, normale körperliche Belastbarkeit |
| | enumeration | 0324002 | documentation (II): Beschwerden bei stärkerer körperlicher Belastung |
| | enumeration | 0324003 | documentation (III): Beschwerden bei leichter körperlicher Belastung |
| | enumeration | 0324004 | documentation (IV): Beschwerden in Ruhe |
| annotation | documentation Kat_AK_NYHA | | |
| source | <pre> <simpleType name="enum_0324"> <annotation> <documentation>Kat_AK_NYHA</documentation> </annotation> <restriction base="xs:string"> <enumeration value="0324001"> <annotation> <documentation>(I): Beschwerdefreiheit, normale körperliche Belastbarkeit</documentation> </annotation> </enumeration> <enumeration value="0324002"> <annotation> <documentation>(II): Beschwerden bei stärkerer körperlicher Belastung</documentation> </annotation> </enumeration> <enumeration value="0324003"> <annotation> <documentation>(III): Beschwerden bei leichter körperlicher Belastung</documentation> </annotation> </enumeration> <enumeration value="0324004"> <annotation> <documentation>(IV): Beschwerden in Ruhe</documentation> </annotation> </enumeration> </restriction> </pre> | | |

</simpleType>

simpleType enum_0330

| | | | |
|------------|---|---------|--|
| namespace | http://xml.ir-d.de/irdma | | |
| type | restriction of string | | |
| properties | base xs:string | | |
| facets | Kind | Value | Annotation |
| | enumeration | 0330001 | documentation ATS Medical |
| | enumeration | 0330002 | documentation Edwards Lifesciences |
| | enumeration | 0330003 | documentation Medtronic |
| | enumeration | 0330004 | documentation JenaValve |
| | enumeration | 0330005 | documentation Corcym |
| | enumeration | 0330006 | documentation Abbott Medical / St. Jude |
| | enumeration | 0330007 | documentation Symetis |
| | enumeration | 0330008 | documentation Direct Flow Medical |
| | enumeration | 0330009 | documentation Boston Scientific |
| | enumeration | 0330010 | documentation Artivion |
| | enumeration | 0330011 | documentation Biosensors |
| | enumeration | 0330012 | documentation LivaNova |
| | enumeration | 0330013 | documentation Meril |
| | enumeration | 0330014 | documentation nicht belegter Wert |
| | enumeration | 0330015 | documentation nicht belegter Wert |
| | enumeration | 0330016 | documentation nicht belegter Wert |
| | enumeration | 0330017 | documentation nicht belegter Wert |
| | enumeration | 0330018 | documentation nicht belegter Wert |
| | enumeration | 0330042 | documentation sonstiger Hersteller |
| annotation | documentation Kat_AK_Hersteller | | |
| source | <pre><simpleType name="enum_0330"> <annotation> <documentation>Kat_AK_Hersteller</documentation> </annotation> <restriction base="xs:string"> <enumeration value="0330001"> <annotation> <documentation>ATS Medical</documentation> </annotation> </enumeration> <enumeration value="0330002"> <annotation></pre> | | |

```
<documentation>Edwards Lifesciences</documentation>
</annotation>
</enumeration>
<enumeration value="0330003">
  <annotation>
    <documentation>Medtronic</documentation>
  </annotation>
</enumeration>
<enumeration value="0330004">
  <annotation>
    <documentation>JenaValve</documentation>
  </annotation>
</enumeration>
<enumeration value="0330005">
  <annotation>
    <documentation>Corcym</documentation>
  </annotation>
</enumeration>
<enumeration value="0330006">
  <annotation>
    <documentation>Abbott Medical / St. Jude</documentation>
  </annotation>
</enumeration>
<enumeration value="0330007">
  <annotation>
    <documentation>Symetis</documentation>
  </annotation>
</enumeration>
<enumeration value="0330008">
  <annotation>
    <documentation>Direct Flow Medical</documentation>
  </annotation>
</enumeration>
<enumeration value="0330009">
  <annotation>
    <documentation>Boston Scientific</documentation>
  </annotation>
</enumeration>
<enumeration value="0330010">
  <annotation>
    <documentation>Artivion</documentation>
  </annotation>
</enumeration>
<enumeration value="0330011">
  <annotation>
    <documentation>Biosensors</documentation>
  </annotation>
</enumeration>
<enumeration value="0330012">
  <annotation>
    <documentation>LivaNova</documentation>
  </annotation>
</enumeration>
<enumeration value="0330013">
  <annotation>
    <documentation>Meril</documentation>
  </annotation>
</enumeration>
<enumeration value="0330014">
```

| | |
|--|--|
| | <pre> <annotation> <documentation>nicht belegter Wert</documentation> </annotation> </enumeration> <enumeration value="0330015"> <annotation> <documentation>nicht belegter Wert</documentation> </annotation> </enumeration> <enumeration value="0330016"> <annotation> <documentation>nicht belegter Wert</documentation> </annotation> </enumeration> <enumeration value="0330017"> <annotation> <documentation>nicht belegter Wert</documentation> </annotation> </enumeration> <enumeration value="0330018"> <annotation> <documentation>nicht belegter Wert</documentation> </annotation> </enumeration> <enumeration value="0330042"> <annotation> <documentation>sonstiger Hersteller</documentation> </annotation> </enumeration> </restriction> </simpleType> </pre> |
|--|--|

simpleType enum_0338

| | | | |
|------------|--|---------|-----------------------------|
| namespace | http://xml.ir-d.de/irdma | | |
| type | restriction of string | | |
| properties | base xs:string | | |
| facets | Kind | Value | Annotation |
| | enumeration | 0338001 | documentation LAD |
| | enumeration | 0338002 | documentation RCA |
| | enumeration | 0338003 | documentation RCX |
| | enumeration | 0338004 | documentation Hauptstamm |
| annotation | documentation Kat_AK_PCIArterien | | |
| source | <pre> <simpleType name="enum_0338"> <annotation> <documentation>Kat_AK_PCIArterien</documentation> </annotation> <restriction base="xs:string"> <enumeration value="0338001"> <annotation> <documentation>LAD</documentation> </annotation> </pre> | | |

| | |
|--|--|
| | <pre> </enumeration> <enumeration value="0338002"> <annotation> <documentation>RCA</documentation> </annotation> </enumeration> <enumeration value="0338003"> <annotation> <documentation>RCX</documentation> </annotation> </enumeration> <enumeration value="0338004"> <annotation> <documentation>Hauptstamm</documentation> </annotation> </enumeration> </restriction> </simpleType> </pre> |
|--|--|

simpleType enum_0339

| | | | |
|------------|---|---------|-------------------------|
| namespace | http://xml.ir-d.de/irdma | | |
| type | restriction of string | | |
| properties | base xs:string | | |
| facets | Kind | Value | Annotation |
| | enumeration | 0339001 | documentation TEE |
| | enumeration | 0339002 | documentation CT |
| | enumeration | 0339042 | documentation andere |
| annotation | documentation Kat AK AnnulusMessmethode | | |
| source | <pre> <simpleType name="enum_0339"> <annotation> <documentation>Kat_AK_AnnulusMessmethode</documentation> </annotation> <restriction base="xs:string"> <enumeration value="0339001"> <annotation> <documentation>TEE</documentation> </annotation> </enumeration> <enumeration value="0339002"> <annotation> <documentation>CT</documentation> </annotation> </enumeration> <enumeration value="0339042"> <annotation> <documentation>andere</documentation> </annotation> </enumeration> </restriction> </simpleType> </pre> | | |

simpleType enum_0341

| | | | |
|------------|--|---------|--|
| namespace | http://xml.ir-d.de/irdma | | |
| type | restriction of string | | |
| properties | base xs:string | | |
| facets | Kind | Value | Annotation |
| | enumeration | 0341001 | documentation intraprozedural verstorben |
| | enumeration | 0341002 | documentation Implantation von mehr als einer Prothese |
| | enumeration | 0341003 | documentation gravierende Gefäß- oder Zugangskomplikation (gemäß VARC-3) |
| | enumeration | 0341004 | documentation erforderlicher chirurgischer oder interventioneller Eingriff wegen einer Klappenfehlfunktion (gemäß VARC-3) |
| | enumeration | 0341005 | documentation >= große strukturelle kardiale Komplikation (gemäß VARC-3) |
| annotation | documentation Kat_AK_FailureGrund | | |
| source | <pre> <simpleType name="enum_0341"> <annotation> <documentation>Kat_AK_FailureGrund</documentation> </annotation> <restriction base="xs:string"> <enumeration value="0341001"> <annotation> <documentation>intraprozedural verstorben</documentation> </annotation> </enumeration> <enumeration value="0341002"> <annotation> <documentation>Implantation von mehr als einer Prothese</documentation> </annotation> </enumeration> <enumeration value="0341003"> <annotation> <documentation>gravierende Gefäß- oder Zugangskomplikation (gemäß VARC-3)</documentation> </annotation> </enumeration> <enumeration value="0341004"> <annotation> <documentation>erforderlicher chirurgischer oder interventioneller Eingriff wegen einer Klappenfehlfunktion (gemäß VARC-3)</documentation> </annotation> </enumeration> <enumeration value="0341005"> <annotation> <documentation>&gt;= große strukturelle kardiale Komplikation (gemäß VARC-3)</documentation> </annotation> </enumeration> </restriction> </simpleType> </pre> | | |

simpleType enum_0342

| | | | |
|------------|--|---------|--|
| namespace | http://xml.ir-d.de/irdma | | |
| type | restriction of string | | |
| properties | base xs:string | | |
| facets | Kind | Value | Annotation |
| | enumeration | 0342001 | documentation Alter |
| | enumeration | 0342002 | documentation Frailty |
| | enumeration | 0342003 | documentation Hochrisiko |
| | enumeration | 0342004 | documentation Prognose-limitierende Zweiterkrankung |
| | enumeration | 0342005 | documentation Porzellan-Aorta |
| | enumeration | 0342042 | documentation Sonstige |
| annotation | documentation Kat_AK_Tavi | | |
| source | <pre> <simpleType name="enum_0342"> <annotation> <documentation>Kat_AK_Tavi</documentation> </annotation> <restriction base="xs:string"> <enumeration value="0342001"> <annotation> <documentation>Alter</documentation> </annotation> </enumeration> <enumeration value="0342002"> <annotation> <documentation>Frailty</documentation> </annotation> </enumeration> <enumeration value="0342003"> <annotation> <documentation>Hochrisiko</documentation> </annotation> </enumeration> <enumeration value="0342004"> <annotation> <documentation>Prognose-limitierende Zweiterkrankung</documentation> </annotation> </enumeration> <enumeration value="0342005"> <annotation> <documentation>Porzellan-Aorta</documentation> </annotation> </enumeration> <enumeration value="0342042"> <annotation> <documentation>Sonstige</documentation> </annotation> </enumeration> </restriction> </simpleType> </pre> | | |

simpleType enum_0343

| | | | |
|------------|--|---------|--|
| namespace | http://xml.ir-d.de/irdma | | |
| type | restriction of string | | |
| properties | base xs:string | | |
| facets | Kind | Value | Annotation |
| | enumeration | 0343001 | documentation Device-Fehlpositionierung |
| | enumeration | 0343002 | documentation Koronarostienverschluss |
| | enumeration | 0343003 | documentation Aortendissektion |
| | enumeration | 0343004 | documentation Aortenregurgitation > = 2. Grades |
| | enumeration | 0343005 | documentation Annulus-Ruptur |
| | enumeration | 0343006 | documentation Ruptur-/Perforation einer Herzhöhle ohne Therapiebedarf |
| | enumeration | 0343007 | documentation Ruptur-/Perforation einer Herzhöhle mit Therapiebedarf |
| | enumeration | 0343008 | documentation Perikardtamponade |
| | enumeration | 0343009 | documentation kardiale Dekompensation |
| | enumeration | 0343010 | documentation Himembolie |
| | enumeration | 0343011 | documentation Rhythmusstörungen |
| | enumeration | 0343012 | documentation Device-Embolisation |
| | enumeration | 0343013 | documentation vaskuläre Komplikation |
| | enumeration | 0343014 | documentation Low Cardiac Output |
| | enumeration | 0343015 | documentation schwerwiegende Blutungen (intraprozedural) |
| | enumeration | 0343016 | documentation lebensbedrohliche Blutungen (intraprozedural) |
| | enumeration | 0343017 | documentation Patient verstarb im OP/Katheterlabor |
| | enumeration | 0343042 | documentation sonstige intraprozedurale Komplikationen |
| annotation | documentation Kat_AK_KomplikationTyp | | |
| source | <pre> <simpleType name="enum_0343"> <annotation> <documentation>Kat_AK_KomplikationTyp</documentation> </annotation> <restriction base="xs:string"> <enumeration value="0343001"> <annotation> <documentation>Device-Fehlpositionierung</documentation> </annotation> </enumeration> <enumeration value="0343002"> <annotation> <documentation>Koronarostienverschluss</documentation> </annotation> </enumeration> <enumeration value="0343003"> </pre> | | |

```

    <annotation>
      <documentation>Aortendissektion</documentation>
    </annotation>
  </enumeration>
  <enumeration value="0343004">
    <annotation>
      <documentation>Aortenregurgitation &gt; = 2. Grades</documentation>
    </annotation>
  </enumeration>
  <enumeration value="0343005">
    <annotation>
      <documentation>Annulus-Ruptur</documentation>
    </annotation>
  </enumeration>
  <enumeration value="0343006">
    <annotation>
      <documentation>Ruptur-/Perforation einer Herzhöhle ohne
Therapiebedarf</documentation>
    </annotation>
  </enumeration>
  <enumeration value="0343007">
    <annotation>
      <documentation>Ruptur-/Perforation einer Herzhöhle mit
Therapiebedarf</documentation>
    </annotation>
  </enumeration>
  <enumeration value="0343008">
    <annotation>
      <documentation>Perikardtamponade</documentation>
    </annotation>
  </enumeration>
  <enumeration value="0343009">
    <annotation>
      <documentation>kardiale Dekompensation</documentation>
    </annotation>
  </enumeration>
  <enumeration value="0343010">
    <annotation>
      <documentation>Hirnembolie</documentation>
    </annotation>
  </enumeration>
  <enumeration value="0343011">
    <annotation>
      <documentation>Rhythmusstörungen</documentation>
    </annotation>
  </enumeration>
  <enumeration value="0343012">
    <annotation>
      <documentation>Device-Embolisation</documentation>
    </annotation>
  </enumeration>
  <enumeration value="0343013">
    <annotation>
      <documentation>vaskuläre Komplikation</documentation>
    </annotation>
  </enumeration>
  <enumeration value="0343014">
    <annotation>
      <documentation>Low Cardiac Output</documentation>
    </annotation>
  </enumeration>

```

| | |
|--|---|
| | <pre> </annotation> </enumeration> <enumeration value="0343015"> <annotation> <documentation>schwerwiegende Blutungen (intraprozedural)</documentation> </annotation> </enumeration> <enumeration value="0343016"> <annotation> <documentation>lebensbedrohliche Blutungen (intraprozedural)</documentation> </annotation> </enumeration> <enumeration value="0343017"> <annotation> <documentation>Patient verstarb im OP/Katheterlabor</documentation> </annotation> </enumeration> <enumeration value="0343042"> <annotation> <documentation>sonstige intraprozedurale Komplikationen</documentation> </annotation> </enumeration> </restriction> </simpleType> </pre> |
|--|---|

simpleType enum_0346

| | | | |
|------------|--|---------|--|
| namespace | http://xml.ir-d.de/irdma | | |
| type | restriction of string | | |
| properties | base xs:string | | |
| facets | Kind | Value | Annotation |
| | enumeration | 0346001 | documentation keine Therapie erforderlich |
| | enumeration | 0346002 | documentation medikamentös |
| | enumeration | 0346003 | documentation IABP |
| | enumeration | 0346004 | documentation VAD |
| | enumeration | 0346005 | documentation ECMO |
| | enumeration | 0346042 | documentation sonstige |
| annotation | documentation Kat_AK_TherapieLCO | | |
| source | <pre> <simpleType name="enum_0346"> <annotation> <documentation>Kat_AK_TherapieLCO</documentation> </annotation> <restriction base="xs:string"> <enumeration value="0346001"> <annotation> <documentation>keine Therapie erforderlich</documentation> </annotation> </enumeration> </restriction> </simpleType> </pre> | | |

| | |
|--|---|
| | <pre> </enumeration> <enumeration value="0346002"> <annotation> <documentation>medikamentös</documentation> </annotation> </enumeration> <enumeration value="0346003"> <annotation> <documentation>IABP</documentation> </annotation> </enumeration> <enumeration value="0346004"> <annotation> <documentation>VAD</documentation> </annotation> </enumeration> <enumeration value="0346005"> <annotation> <documentation>ECMO</documentation> </annotation> </enumeration> <enumeration value="0346042"> <annotation> <documentation>sonstige</documentation> </annotation> </enumeration> </restriction> </simpleType> </pre> |
|--|---|

simpleType enum_0347

| | | | |
|------------|---|---------|---|
| namespace | http://xml.ir-d.de/irdma | | |
| type | restriction of string | | |
| properties | base xs:string | | |
| facets | Kind | Value | Annotation |
| | enumeration | 0347001 | documentation Einzeleingriff |
| | enumeration | 0347002 | documentation Kombinationseingriff mit mehreren Prozeduren |
| annotation | documentation Kat_AK_Eingriffsumfang | | |
| source | <pre> <simpleType name="enum_0347"> <annotation> <documentation>Kat_AK_Eingriffsumfang</documentation> </annotation> <restriction base="xs:string"> <enumeration value="0347001"> <annotation> <documentation>Einzeleingriff</documentation> </annotation> </enumeration> <enumeration value="0347002"> <annotation> <documentation>Kombinationseingriff mit mehreren Prozeduren</documentation> </annotation> </enumeration> </restriction> </pre> | | |

| | |
|--|---|
| | <pre> </restriction> </simpleType> </pre> |
|--|---|

simpleType enum_0348

| | | | |
|------------|---|---------|---|
| namespace | http://xml.ir-d.de/irdma | | |
| type | restriction of string | | |
| properties | base xs:string | | |
| facets | Kind | Value | Annotation |
| | enumeration | 0348001 | documentation mit HLM |
| | enumeration | 0348002 | documentation ohne HLM |
| | enumeration | 0348003 | documentation Umstieg von OP ohne HLM auf OP mit HLM |
| annotation | documentation Kat_AK_OPVorgehen | | |
| source | <pre> <simpleType name="enum_0348"> <annotation> <documentation>Kat_AK_OPVorgehen</documentation> </annotation> <restriction base="xs:string"> <enumeration value="0348001"> <annotation> <documentation>mit HLM</documentation> </annotation> </enumeration> <enumeration value="0348002"> <annotation> <documentation>ohne HLM</documentation> </annotation> </enumeration> <enumeration value="0348003"> <annotation> <documentation>Umstieg von OP ohne HLM auf OP mit HLM</documentation> </annotation> </enumeration> </restriction> </simpleType> </pre> | | |

simpleType enum_0350

| | | | |
|------------|------------------------------|---------|--------------------------|
| namespace | http://xml.ir-d.de/irdma | | |
| type | restriction of string | | |
| properties | base xs:string | | |
| facets | Kind | Value | Annotation |
| | enumeration | 0350001 | documentation IABP |
| | enumeration | 0350002 | documentation Impella |
| | enumeration | 0350003 | documentation vv ECMO |
| | enumeration | 0350004 | documentation va ECMO |
| | enumeration | 0350042 | documentation |

| | |
|------------|--|
| | andere |
| annotation | documentation Kat AK Methode |
| source | <pre> <simpleType name="enum_0350"> <annotation> <documentation>Kat_AK_Methode</documentation> </annotation> <restriction base="xs:string"> <enumeration value="0350001"> <annotation> <documentation>IABP</documentation> </annotation> </enumeration> <enumeration value="0350002"> <annotation> <documentation>Impella</documentation> </annotation> </enumeration> <enumeration value="0350003"> <annotation> <documentation>vv ECMO</documentation> </annotation> </enumeration> <enumeration value="0350004"> <annotation> <documentation>va ECMO</documentation> </annotation> </enumeration> <enumeration value="0350042"> <annotation> <documentation>andere</documentation> </annotation> </enumeration> </restriction> </simpleType> </pre> |

simpleType enum_0351

| | | | |
|------------|------------------------------|---------|---|
| namespace | http://xml.ir-d.de/irdma | | |
| type | restriction of string | | |
| properties | base xs:string | | |
| facets | Kind | Value | Annotation |
| | enumeration | 0351001 | documentation nein |
| | enumeration | 0351002 | documentation ja, zu Stenotomie |
| | enumeration | 0351003 | documentation ja, zu transapikal |
| | enumeration | 0351004 | documentation ja, zu transaortal |
| | enumeration | 0351005 | documentation ja, zu transfemoral |
| | enumeration | 0351006 | documentation ja, zu transaxillär |
| | enumeration | 0351007 | documentation ja, zu anderem endovaskulären Zugang |
| | enumeration | 0351042 | documentation ja, zu anderem Zugang |

| | |
|------------|---|
| annotation | documentation Kat_AK_Konversion |
| source | <pre> <simpleType name="enum_0351"> <annotation> <documentation>Kat_AK_Konversion</documentation> </annotation> <restriction base="xs:string"> <enumeration value="0351001"> <annotation> <documentation>nein</documentation> </annotation> </enumeration> <enumeration value="0351002"> <annotation> <documentation>ja, zu Sternotomie</documentation> </annotation> </enumeration> <enumeration value="0351003"> <annotation> <documentation>ja, zu transapikal</documentation> </annotation> </enumeration> <enumeration value="0351004"> <annotation> <documentation>ja, zu transaortal</documentation> </annotation> </enumeration> <enumeration value="0351005"> <annotation> <documentation>ja, zu transfemoral</documentation> </annotation> </enumeration> <enumeration value="0351006"> <annotation> <documentation>ja, zu transaxillär</documentation> </annotation> </enumeration> <enumeration value="0351007"> <annotation> <documentation>ja, zu anderem endovaskulären Zugang</documentation> </annotation> </enumeration> <enumeration value="0351042"> <annotation> <documentation>ja, zu anderem Zugang</documentation> </annotation> </enumeration> </restriction> </simpleType> </pre> |

simpleType enum_0352

| | | | |
|------------|------------------------------|-----------|------------|
| namespace | http://xml.ir-d.de/irdma | | |
| type | restriction of string | | |
| properties | base | xs:string | |
| facets | Kind | Value | Annotation |

| | |
|------------|---|
| | enumeration 0352001 documentation nein enumeration 0352002 documentation ja, Intubationsnarkose enumeration 0352003 documentation ja, Maskenbeatmung, incl. LAMA enumeration 0352042 documentation ja, unbekannt welche |
| annotation | documentation Kat_AK_Anaesthesie |
| source | <pre> <simpleType name="enum_0352"> <annotation> <documentation>Kat_AK_Anaesthesie</documentation> </annotation> <restriction base="xs:string"> <enumeration value="0352001"> <annotation> <documentation>nein</documentation> </annotation> </enumeration> <enumeration value="0352002"> <annotation> <documentation>ja, Intubationsnarkose</documentation> </annotation> </enumeration> <enumeration value="0352003"> <annotation> <documentation>ja, Maskenbeatmung, incl. LAMA</documentation> </annotation> </enumeration> <enumeration value="0352042"> <annotation> <documentation>ja, unbekannt welche</documentation> </annotation> </enumeration> </restriction> </simpleType> </pre> |

simpleType enum 0353

| | | | |
|------------|---|---------|-----------------------------------|
| namespace | http://xml.ir-d.de/irdma | | |
| type | restriction of string | | |
| properties | base xs:string | | |
| facets | Kind | Value | Annotation |
| | enumeration | 0353001 | documentation keine |
| | enumeration | 0353002 | documentation leichtgradig |
| | enumeration | 0353003 | documentation mittelgradig |
| | enumeration | 0353004 | documentation hochgradig |
| | enumeration | 0353099 | documentation nicht bestimmbar |
| annotation | documentation Kat_AK_ResidualeAorteninsuffizienz | | |
| source | <pre> <simpleType name="enum_0353"> <annotation> </pre> | | |

| | |
|--|---|
| | <pre> <documentation>Kat_AK_ResidualeAorteninsuffizienz</documentation> </annotation> <restriction base="xs:string"> <enumeration value="0353001"> <annotation> <documentation>keine</documentation> </annotation> </enumeration> <enumeration value="0353002"> <annotation> <documentation>leichtgradig</documentation> </annotation> </enumeration> <enumeration value="0353003"> <annotation> <documentation>mittelgradig</documentation> </annotation> </enumeration> <enumeration value="0353004"> <annotation> <documentation>hochgradig</documentation> </annotation> </enumeration> <enumeration value="0353099"> <annotation> <documentation>nicht bestimmbar</documentation> </annotation> </enumeration> </restriction> </simpleType> </pre> |
|--|---|

simpleType enum_0354

| | | | |
|------------|---|---------|------------------------------------|
| namespace | http://xml.ir-d.de/irdma | | |
| type | restriction of string | | |
| properties | base xs:string | | |
| facets | Kind | Value | Annotation |
| | enumeration | 0354001 | documentation chirurgisch-offen |
| | enumeration | 0354002 | documentation Verschluss-System |
| | enumeration | 0354042 | documentation sonstige |
| annotation | documentation Kat_AK_Zugangswegverschluss | | |
| source | <pre> <simpleType name="enum_0354"> <annotation> <documentation>Kat_AK_Zugangswegverschluss</documentation> </annotation> <restriction base="xs:string"> <enumeration value="0354001"> <annotation> <documentation>chirurgisch-offen</documentation> </annotation> </enumeration> <enumeration value="0354002"> <annotation> </pre> | | |

| | |
|--|---|
| | <pre> <documentation>Verschluss-System</documentation> </annotation> </enumeration> <enumeration value="0354042"> <annotation> <documentation>sonstige</documentation> </annotation> </enumeration> </restriction> </simpleType> </pre> |
|--|---|

simpleType enum_0357

| | | | |
|------------|---|---------|--|
| namespace | http://xml.ir-d.de/irdma | | |
| type | restriction of string | | |
| properties | base xs:string | | |
| facets | Kind | Value | Annotation |
| | enumeration | 0357001 | documentation keine KHK |
| | enumeration | 0357002 | documentation 1-Gefäßerkrankung |
| | enumeration | 0357003 | documentation 2-Gefäßerkrankung |
| | enumeration | 0357004 | documentation 3-Gefäßerkrankung |
| | enumeration | 0357005 | documentation keine koronare Bildgebung |
| annotation | documentation Kat_AK_BefundBildgebung | | |
| source | <pre> <simpleType name="enum_0357"> <annotation> <documentation>Kat_AK_BefundBildgebung</documentation> </annotation> <restriction base="xs:string"> <enumeration value="0357001"> <annotation> <documentation>keine KHK</documentation> </annotation> </enumeration> <enumeration value="0357002"> <annotation> <documentation>1-Gefäßerkrankung</documentation> </annotation> </enumeration> <enumeration value="0357003"> <annotation> <documentation>2-Gefäßerkrankung</documentation> </annotation> </enumeration> <enumeration value="0357004"> <annotation> <documentation>3-Gefäßerkrankung</documentation> </annotation> </enumeration> <enumeration value="0357005"> <annotation> <documentation>keine koronare Bildgebung</documentation> </annotation> </enumeration> </restriction> </simpleType> </pre> | | |

```

</annotation>
</enumeration>
</restriction>
</simpleType>

```

simpleType enum_0358

| | | | |
|------------|--|---------|---|
| namespace | http://xml.ir-d.de/irdma | | |
| type | restriction of string | | |
| properties | base xs:string | | |
| facets | Kind | Value | Annotation |
| | enumeration | 0358001 | documentation 0 |
| | enumeration | 0358002 | documentation 1 |
| | enumeration | 0358003 | documentation 2 |
| | enumeration | 0358004 | documentation 3 |
| | enumeration | 0358005 | documentation 4 |
| | enumeration | 0358006 | documentation 5 oder mehr |
| | enumeration | 0358098 | documentation genaue Anzahl unbekannt (aber mind. 1) |
| | enumeration | 0358099 | documentation unbekannt |
| annotation | documentation Kat_AK_AnzahlVorOP | | |
| source | <pre> <simpleType name="enum_0358"> <annotation> <documentation>Kat_AK_AnzahlVorOP</documentation> </annotation> <restriction base="xs:string"> <enumeration value="0358001"> <annotation> <documentation>0</documentation> </annotation> </enumeration> <enumeration value="0358002"> <annotation> <documentation>1</documentation> </annotation> </enumeration> <enumeration value="0358003"> <annotation> <documentation>2</documentation> </annotation> </enumeration> <enumeration value="0358004"> <annotation> <documentation>3</documentation> </annotation> </enumeration> <enumeration value="0358005"> <annotation> <documentation>4</documentation> </annotation> </pre> | | |

| | |
|--|--|
| | <pre> </enumeration> <enumeration value="0358006"> <annotation> <documentation>5 oder mehr</documentation> </annotation> </enumeration> <enumeration value="0358098"> <annotation> <documentation>genaue Anzahl unbekannt (aber mind. 1)</documentation> </annotation> </enumeration> <enumeration value="0358099"> <annotation> <documentation>unbekannt</documentation> </annotation> </enumeration> </restriction> </simpleType> </pre> |
|--|--|

simpleType **enum_0359**

| | | | |
|------------|---|---------|----------------------------------|
| namespace | http://xml.ir-d.de/irdma | | |
| type | restriction of string | | |
| properties | base xs:string | | |
| facets | Kind | Value | Annotation |
| | enumeration | 0359001 | documentation nein |
| | enumeration | 0359002 | documentation ja - einseitig |
| | enumeration | 0359003 | documentation ja - beidseitig |
| | enumeration | 0359042 | documentation unbekannt |
| annotation | documentation Kat_AK_LVOT | | |
| source | <pre> <simpleType name="enum_0359"> <annotation> <documentation>Kat_AK_LVOT</documentation> </annotation> <restriction base="xs:string"> <enumeration value="0359001"> <annotation> <documentation>nein</documentation> </annotation> </enumeration> <enumeration value="0359002"> <annotation> <documentation>ja - einseitig</documentation> </annotation> </enumeration> <enumeration value="0359003"> <annotation> <documentation>ja - beidseitig</documentation> </annotation> </enumeration> <enumeration value="0359042"> <annotation> </pre> | | |

```

    <documentation>unbekannt</documentation>
  </annotation>
</enumeration>
</restriction>
</simpleType>

```

simpleType enum_0360

| | | | |
|------------|---|---------|-------------------------------|
| namespace | http://xml.ir-d.de/irdma | | |
| type | restriction of string | | |
| properties | base xs:string | | |
| facets | Kind | Value | Annotation |
| | enumeration | 0360001 | documentation keine |
| | enumeration | 0360002 | documentation leichtgradig |
| | enumeration | 0360003 | documentation mittelgradig |
| | enumeration | 0360004 | documentation hochgradig |
| | enumeration | 0360005 | documentation massive |
| | enumeration | 0360006 | documentation torrential |
| | enumeration | 0360099 | documentation unbekannt |
| annotation | documentation Kat_AK_TriskupidalInsuffizienz | | |
| source | <pre> <simpleType name="enum_0360"> <annotation> <documentation>Kat_AK_TriskupidalInsuffizienz</documentation> </annotation> <restriction base="xs:string"> <enumeration value="0360001"> <annotation> <documentation>keine</documentation> </annotation> </enumeration> <enumeration value="0360002"> <annotation> <documentation>leichtgradig</documentation> </annotation> </enumeration> <enumeration value="0360003"> <annotation> <documentation>mittelgradig</documentation> </annotation> </enumeration> <enumeration value="0360004"> <annotation> <documentation>hochgradig</documentation> </annotation> </enumeration> <enumeration value="0360005"> <annotation> <documentation>massive</documentation> </annotation> </enumeration> </restriction> </simpleType> </pre> | | |

| | |
|--|---|
| | <pre> </enumeration> <enumeration value="0360006"> <annotation> <documentation>torrential</documentation> </annotation> </enumeration> <enumeration value="0360099"> <annotation> <documentation>unbekannt</documentation> </annotation> </enumeration> </restriction> </simpleType> </pre> |
|--|---|

simpleType enum_0361

| | | | |
|------------|---|---------|---|
| namespace | http://xml.ir-d.de/irdma | | |
| type | restriction of string | | |
| properties | base xs:string | | |
| facets | Kind | Value | Annotation |
| | enumeration | 0361001 | documentation nein |
| | enumeration | 0361002 | documentation ja, letzte(r) innerhalb der letzten 48 Stunden |
| | enumeration | 0361003 | documentation ja, letzte(r) innerhalb der letzten 21 Tage |
| | enumeration | 0361004 | documentation ja, letzte(r) länger als 21 Tage |
| | enumeration | 0361098 | documentation ja, letzter Zeitpunkt unbekannt |
| | enumeration | 0361099 | documentation unbekannt |
| annotation | documentation Kat_AK_SchockReanimation | | |
| source | <pre> <simpleType name="enum_0361"> <annotation> <documentation>Kat_AK_SchockReanimation</documentation> </annotation> <restriction base="xs:string"> <enumeration value="0361001"> <annotation> <documentation>nein</documentation> </annotation> </enumeration> <enumeration value="0361002"> <annotation> <documentation>ja, letzte(r) innerhalb der letzten 48 Stunden</documentation> </annotation> </enumeration> <enumeration value="0361003"> <annotation> <documentation>ja, letzte(r) innerhalb der letzten 21 Tage</documentation> </annotation> </enumeration> <enumeration value="0361004"> </pre> | | |

| | |
|--|---|
| | <pre> <annotation> <documentation>ja, letzte(r) länger als 21 Tage</documentation> </annotation> </enumeration> <enumeration value="0361098"> <annotation> <documentation>ja, letzter Zeitpunkt unbekannt</documentation> </annotation> </enumeration> <enumeration value="0361099"> <annotation> <documentation>unbekannt</documentation> </annotation> </enumeration> </restriction> </simpleType> </pre> |
|--|---|

simpleType enum 0362

| | | | |
|------------|---|---------|---------------------------------------|
| namespace | http://xml.ir-d.de/irdma | | |
| type | restriction of string | | |
| properties | base xs:string | | |
| facets | Kind | Value | Annotation |
| | enumeration | 0362001 | documentation Sinusrhythmus |
| | enumeration | 0362002 | documentation Vorhofflimmern |
| | enumeration | 0362042 | documentation anderer Herzrhythmus |
| annotation | documentation Kat_AK_Herzrhythmus | | |
| source | <pre> <simpleType name="enum_0362"> <annotation> <documentation>Kat_AK_Herzrhythmus</documentation> </annotation> <restriction base="xs:string"> <enumeration value="0362001"> <annotation> <documentation>Sinusrhythmus</documentation> </annotation> </enumeration> <enumeration value="0362002"> <annotation> <documentation>Vorhofflimmern</documentation> </annotation> </enumeration> <enumeration value="0362042"> <annotation> <documentation>anderer Herzrhythmus</documentation> </annotation> </enumeration> </restriction> </simpleType> </pre> | | |

simpleType enum_0363

| | | | |
|------------|--|---------|--------------------------------|
| namespace | http://xml.ir-d.de/irdma | | |
| type | restriction of string | | |
| properties | base xs:string | | |
| facets | Kind | Value | Annotation |
| | enumeration | 0363001 | documentation nein |
| | enumeration | 0363002 | documentation paroxysmal |
| | enumeration | 0363003 | documentation persistierend |
| | enumeration | 0363004 | documentation permanent |
| annotation | documentation Kat_AK_Vorhofflimmern | | |
| source | <pre> <simpleType name="enum_0363"> <annotation> <documentation>Kat_AK_Vorhofflimmern</documentation> </annotation> <restriction base="xs:string"> <enumeration value="0363001"> <annotation> <documentation>nein</documentation> </annotation> </enumeration> <enumeration value="0363002"> <annotation> <documentation>paroxysmal</documentation> </annotation> </enumeration> <enumeration value="0363003"> <annotation> <documentation>persistierend</documentation> </annotation> </enumeration> <enumeration value="0363004"> <annotation> <documentation>permanent</documentation> </annotation> </enumeration> </restriction> </simpleType> </pre> | | |

simpleType enum_0364

| | | | |
|------------|------------------------------|---------|--|
| namespace | http://xml.ir-d.de/irdma | | |
| type | restriction of string | | |
| properties | base xs:string | | |
| facets | Kind | Value | Annotation |
| | enumeration | 0364001 | documentation nein |
| | enumeration | 0364002 | documentation Schrittmacher ohne CRT-System |
| | enumeration | 0364003 | documentation Schrittmacher mit CRT-System |
| | enumeration | 0364004 | documentation |

| | |
|------------|---|
| | enumeration 0364005 Defibrillator ohne CRT-System documentation Defibrillator mit CRT-System |
| annotation | documentation Kat_AK_SchrittmacherDefi |
| source | <pre> <simpleType name="enum_0364"> <annotation> <documentation>Kat_AK_SchrittmacherDefi</documentation> </annotation> <restriction base="xs:string"> <enumeration value="0364001"> <annotation> <documentation>nein</documentation> </annotation> </enumeration> <enumeration value="0364002"> <annotation> <documentation>Schrittmacher ohne CRT-System</documentation> </annotation> </enumeration> <enumeration value="0364003"> <annotation> <documentation>Schrittmacher mit CRT-System</documentation> </annotation> </enumeration> <enumeration value="0364004"> <annotation> <documentation>Defibrillator ohne CRT-System</documentation> </annotation> </enumeration> <enumeration value="0364005"> <annotation> <documentation>Defibrillator mit CRT-System</documentation> </annotation> </enumeration> </restriction> </simpleType> </pre> |

simpleType enum_0365

| | | | |
|------------|---|---------|--------------------------------------|
| namespace | http://xml.ir-d.de/irdma | | |
| type | restriction of string | | |
| properties | base xs:string | | |
| facets | Kind | Value | Annotation |
| | enumeration | 0365001 | documentation nein |
| | enumeration | 0365002 | documentation ja, operativ |
| | enumeration | 0365003 | documentation ja, interventionell |
| annotation | documentation Kat_AK_MyokardRevaskularisation | | |
| source | <pre> <simpleType name="enum_0365"> <annotation> <documentation>Kat_AK_MyokardRevaskularisation</documentation> </annotation> <restriction base="xs:string"> </pre> | | |

| | |
|--|--|
| | <pre> <enumeration value="0365001"> <annotation> <documentation>nein</documentation> </annotation> </enumeration> <enumeration value="0365002"> <annotation> <documentation>ja, operativ</documentation> </annotation> </enumeration> <enumeration value="0365003"> <annotation> <documentation>ja, interventionell</documentation> </annotation> </enumeration> </restriction> </simpleType> </pre> |
|--|--|

simpleType enum 0366

| | | | |
|------------|--|---------|--|
| namespace | http://xml.ir-d.de/irdma | | |
| type | restriction of string | | |
| properties | base xs:string | | |
| facets | Kind | Value | Annotation |
| | enumeration | 0366001 | documentation nein |
| | enumeration | 0366002 | documentation ja, <= 6 Stunden |
| | enumeration | 0366003 | documentation ja, > 6 Stunden bis <= 3 Monate |
| | enumeration | 0366004 | documentation ja, > 3 Monate |
| | enumeration | 0366099 | documentation unbekannt |
| annotation | documentation Kat_AK_PCI | | |
| source | <pre> <simpleType name="enum_0366"> <annotation> <documentation>Kat_AK_PCI</documentation> </annotation> <restriction base="xs:string"> <enumeration value="0366001"> <annotation> <documentation>nein</documentation> </annotation> </enumeration> <enumeration value="0366002"> <annotation> <documentation>ja, &lt;= 6 Stunden</documentation> </annotation> </enumeration> <enumeration value="0366003"> <annotation> <documentation>ja, &gt; 6 Stunden bis &lt;= 3 Monate</documentation> </annotation> </enumeration> <enumeration value="0366004"> </pre> | | |

| | |
|--|---|
| | <pre> <annotation> <documentation>ja, &gt; 3 Monate</documentation> </annotation> </enumeration> <enumeration value="0366099"> <annotation> <documentation>unbekannt</documentation> </annotation> </enumeration> </restriction> </simpleType> </pre> |
|--|---|

simpleType enum_0367

| | | | |
|------------|---|---------|--|
| namespace | http://xml.ir-d.de/irdma | | |
| type | restriction of string | | |
| properties | base xs:string | | |
| facets | Kind | Value | Annotation |
| | enumeration | 0367001 | documentation keine |
| | enumeration | 0367002 | documentation Mediastinitis |
| | enumeration | 0367003 | documentation Sepsis |
| | enumeration | 0367004 | documentation broncho-pulmonale Infektion |
| | enumeration | 0367005 | documentation oto-laryngologische Infektion |
| | enumeration | 0367006 | documentation floride Endokarditis |
| | enumeration | 0367007 | documentation Peritonitis |
| | enumeration | 0367008 | documentation Wundinfektion Thorax |
| | enumeration | 0367009 | documentation Pleuraempyem |
| | enumeration | 0367010 | documentation Venenkatheterinfektion |
| | enumeration | 0367011 | documentation Harnwegsinfektion |
| | enumeration | 0367012 | documentation Wundinfektion untere Extremitäten |
| | enumeration | 0367013 | documentation HIV-Infektion |
| | enumeration | 0367014 | documentation Hepatitis B oder C |
| | enumeration | 0367015 | documentation andere Wundinfektion |
| | enumeration | 0367042 | documentation sonstige Infektion |
| annotation | documentation Kat_AK_Infektion | | |
| source | <pre> <simpleType name="enum_0367"> <annotation> <documentation>Kat_AK_Infektion</documentation> </annotation> <restriction base="xs:string"> <enumeration value="0367001"> <annotation> </pre> | | |

```
<documentation>keine</documentation>
</annotation>
</enumeration>
<enumeration value="0367002">
  <annotation>
    <documentation>Mediastinitis</documentation>
  </annotation>
</enumeration>
<enumeration value="0367003">
  <annotation>
    <documentation>Sepsis</documentation>
  </annotation>
</enumeration>
<enumeration value="0367004">
  <annotation>
    <documentation>broncho-pulmonale Infektion</documentation>
  </annotation>
</enumeration>
<enumeration value="0367005">
  <annotation>
    <documentation>oto-laryngologische Infektion</documentation>
  </annotation>
</enumeration>
<enumeration value="0367006">
  <annotation>
    <documentation>floride Endokarditis</documentation>
  </annotation>
</enumeration>
<enumeration value="0367007">
  <annotation>
    <documentation>Peritonitis</documentation>
  </annotation>
</enumeration>
<enumeration value="0367008">
  <annotation>
    <documentation>Wundinfektion Thorax</documentation>
  </annotation>
</enumeration>
<enumeration value="0367009">
  <annotation>
    <documentation>Pleuraempyem</documentation>
  </annotation>
</enumeration>
<enumeration value="0367010">
  <annotation>
    <documentation>Venenkatheterinfektion</documentation>
  </annotation>
</enumeration>
<enumeration value="0367011">
  <annotation>
    <documentation>Harnwegsinfektion</documentation>
  </annotation>
</enumeration>
<enumeration value="0367012">
  <annotation>
    <documentation>Wundinfektion untere Extremitäten</documentation>
  </annotation>
</enumeration>
<enumeration value="0367013">
```

| | |
|--|--|
| | <pre> <annotation> <documentation>HIV-Infektion</documentation> </annotation> </enumeration> <enumeration value="0367014"> <annotation> <documentation>Hepatitis B oder C</documentation> </annotation> </enumeration> <enumeration value="0367015"> <annotation> <documentation>andere Wundinfektion</documentation> </annotation> </enumeration> <enumeration value="0367042"> <annotation> <documentation>sonstige Infektion</documentation> </annotation> </enumeration> </restriction> </simpleType> </pre> |
|--|--|

simpleType enum 0368

| | | | |
|------------|--|---------|--|
| namespace | http://xml.ir-d.de/irdma | | |
| type | restriction of string | | |
| properties | base xs:string | | |
| facets | Kind | Value | Annotation |
| | enumeration | 0368001 | documentation nein |
| | enumeration | 0368002 | documentation ja, COPD mit Dauermedikation |
| | enumeration | 0368003 | documentation ja, COPD ohne Dauermedikation |
| | enumeration | 0368004 | documentation ja, andere Lungenerkrankungen |
| | enumeration | 0368099 | documentation unbekannt |
| annotation | documentation Kat_AK_Lungenerkrankung | | |
| source | <pre> <simpleType name="enum_0368"> <annotation> <documentation>Kat_AK_Lungenerkrankung</documentation> </annotation> <restriction base="xs:string"> <enumeration value="0368001"> <annotation> <documentation>nein</documentation> </annotation> </enumeration> <enumeration value="0368002"> <annotation> <documentation>ja, COPD mit Dauermedikation</documentation> </annotation> </enumeration> <enumeration value="0368003"> <annotation> </pre> | | |

| | |
|--|---|
| | <pre> <documentation>ja, COPD ohne Dauermedikation</documentation> </annotation> </enumeration> <enumeration value="0368004"> <annotation> <documentation>ja, andere Lungenerkrankungen</documentation> </annotation> </enumeration> <enumeration value="0368099"> <annotation> <documentation>unbekannt</documentation> </annotation> </enumeration> </restriction> </simpleType> </pre> |
|--|---|

simpleType enum 0369

| | | | |
|------------|---|---------|----------------------------|
| namespace | http://xml.ir-d.de/irdma | | |
| type | restriction of string | | |
| properties | base xs:string | | |
| facets | Kind | Value | Annotation |
| | enumeration | 0369001 | documentation nein |
| | enumeration | 0369002 | documentation akut |
| | enumeration | 0369003 | documentation chronisch |
| annotation | documentation Kat_AK_Nierenersatztherapie | | |
| source | <pre> <simpleType name="enum_0369"> <annotation> <documentation>Kat_AK_Nierenersatztherapie</documentation> </annotation> <restriction base="xs:string"> <enumeration value="0369001"> <annotation> <documentation>nein</documentation> </annotation> </enumeration> <enumeration value="0369002"> <annotation> <documentation>akut</documentation> </annotation> </enumeration> <enumeration value="0369003"> <annotation> <documentation>chronisch</documentation> </annotation> </enumeration> </restriction> </simpleType> </pre> | | |

simpleType enum_0370

| | | | |
|------------|---|---------|------------------------------------|
| namespace | http://xml.ir-d.de/irdma | | |
| type | restriction of string | | |
| properties | base xs:string | | |
| facets | Kind | Value | Annotation |
| | enumeration | 0370001 | documentation Echokardiographie |
| | enumeration | 0370002 | documentation Herzkatheter |
| | enumeration | 0370042 | documentation andere |
| annotation | documentation Kat_AK_AKOEFMessmethode | | |
| source | <pre> <simpleType name="enum_0370"> <annotation> <documentation>Kat_AK_AKOEFMessmethode</documentation> </annotation> <restriction base="xs:string"> <enumeration value="0370001"> <annotation> <documentation>Echokardiographie</documentation> </annotation> </enumeration> <enumeration value="0370002"> <annotation> <documentation>Herzkatheter</documentation> </annotation> </enumeration> <enumeration value="0370042"> <annotation> <documentation>andere</documentation> </annotation> </enumeration> </restriction> </simpleType> </pre> | | |

simpleType enum_0371

| | | | |
|------------|---|---------|----------------------------|
| namespace | http://xml.ir-d.de/irdma | | |
| type | restriction of string | | |
| properties | base xs:string | | |
| facets | Kind | Value | Annotation |
| | enumeration | 0371001 | documentation keine |
| | enumeration | 0371002 | documentation leicht |
| | enumeration | 0371003 | documentation mittel |
| | enumeration | 0371004 | documentation schwer |
| | enumeration | 0371099 | documentation unbekannt |
| annotation | documentation Kat_AK_Verkalkungsgrad | | |
| source | <pre> <simpleType name="enum_0371"> <annotation> </pre> | | |

| | |
|--|--|
| | <pre> <documentation>Kat_AK_Verkalkungsgrad</documentation> </annotation> <restriction base="xs:string"> <enumeration value="0371001"> <annotation> <documentation>keine</documentation> </annotation> </enumeration> <enumeration value="0371002"> <annotation> <documentation>leicht</documentation> </annotation> </enumeration> <enumeration value="0371003"> <annotation> <documentation>mittel</documentation> </annotation> </enumeration> <enumeration value="0371004"> <annotation> <documentation>schwer</documentation> </annotation> </enumeration> <enumeration value="0371099"> <annotation> <documentation>unbekannt</documentation> </annotation> </enumeration> </restriction> </simpleType> </pre> |
|--|--|

simpleType enum_0372

| | | | |
|------------|---|---------|---------------------------------|
| namespace | http://xml.ir-d.de/irdma | | |
| type | restriction of string | | |
| properties | base xs:string | | |
| facets | Kind | Value | Annotation |
| | enumeration | 0372001 | documentation nein |
| | enumeration | 0372002 | documentation ja, bicuspide |
| | enumeration | 0372003 | documentation ja, unicuspide |
| | enumeration | 0372099 | documentation unbekannt |
| annotation | documentation Kat_AK_BiUnicuspideKlappe | | |
| source | <pre> <simpleType name="enum_0372"> <annotation> <documentation>Kat_AK_BiUnicuspideKlappe</documentation> </annotation> <restriction base="xs:string"> <enumeration value="0372001"> <annotation> <documentation>nein</documentation> </annotation> </enumeration> </pre> | | |

| | |
|--|---|
| | <pre> <enumeration value="0372002"> <annotation> <documentation>ja, bicuspide</documentation> </annotation> </enumeration> <enumeration value="0372003"> <annotation> <documentation>ja, unicuspide</documentation> </annotation> </enumeration> <enumeration value="0372099"> <annotation> <documentation>unbekannt</documentation> </annotation> </enumeration> </restriction> </simpleType> </pre> |
|--|---|

simpleType enum 0373

| | | | |
|------------|--|---------|-------------------------------|
| namespace | http://xml.ir-d.de/irdma | | |
| type | restriction of string | | |
| properties | base xs:string | | |
| facets | Kind | Value | Annotation |
| | enumeration | 0373001 | documentation keine |
| | enumeration | 0373002 | documentation leichtgradig |
| | enumeration | 0373003 | documentation mittelgradig |
| | enumeration | 0373004 | documentation hochgradig |
| | enumeration | 0373099 | documentation unbekannt |
| annotation | documentation Kat_AK_Grad | | |
| source | <pre> <simpleType name="enum_0373"> <annotation> <documentation>Kat_AK_Grad</documentation> </annotation> <restriction base="xs:string"> <enumeration value="0373001"> <annotation> <documentation>keine</documentation> </annotation> </enumeration> <enumeration value="0373002"> <annotation> <documentation>leichtgradig</documentation> </annotation> </enumeration> <enumeration value="0373003"> <annotation> <documentation>mittelgradig</documentation> </annotation> </enumeration> <enumeration value="0373004"> </pre> | | |

| | |
|--|--|
| | <pre> <annotation> <documentation>hochgradig</documentation> </annotation> </enumeration> <enumeration value="0373099"> <annotation> <documentation>unbekannt</documentation> </annotation> </enumeration> </restriction> </simpleType> </pre> |
|--|--|

simpleType enum_0374

| | | | |
|------------|--|---------|--|
| namespace | http://xml.ir-d.de/irdma | | |
| type | restriction of string | | |
| properties | base xs:string | | |
| facets | Kind | Value | Annotation |
| | enumeration | 0374001 | documentation nein |
| | enumeration | 0374002 | documentation ja, <= 6 Stunden |
| | enumeration | 0374003 | documentation ja, > 6 Stunden bis <= 24 Stunden |
| | enumeration | 0374004 | documentation ja, > 1 bis 7 Tage |
| | enumeration | 0374005 | documentation ja, > 7 bis 21 Tage |
| | enumeration | 0374006 | documentation ja, > 21 Tage |
| | enumeration | 0374099 | documentation unbekannt |
| annotation | documentation Kat_AK_InfarktAnamnese | | |
| source | <pre> <simpleType name="enum_0374"> <annotation> <documentation>Kat_AK_InfarktAnamnese</documentation> </annotation> <restriction base="xs:string"> <enumeration value="0374001"> <annotation> <documentation>nein</documentation> </annotation> </enumeration> <enumeration value="0374002"> <annotation> <documentation>ja, &lt;= 6 Stunden</documentation> </annotation> </enumeration> <enumeration value="0374003"> <annotation> <documentation>ja, &gt; 6 Stunden bis &lt;= 24 Stunden</documentation> </annotation> </enumeration> <enumeration value="0374004"> <annotation> <documentation>ja, &gt; 1 bis 7 Tage</documentation> </pre> | | |

```

</annotation>
</enumeration>
<enumeration value="0374005">
  <annotation>
    <documentation>ja, &gt; 7 bis 21 Tage</documentation>
  </annotation>
</enumeration>
<enumeration value="0374006">
  <annotation>
    <documentation>ja, &gt; 21 Tage</documentation>
  </annotation>
</enumeration>
<enumeration value="0374099">
  <annotation>
    <documentation>unbekannt</documentation>
  </annotation>
</enumeration>
</restriction>
</simpleType>

```

simpleType enum 0375

| | | | |
|------------|--|---------|---|
| namespace | http://xml.ir-d.de/irdma | | |
| type | restriction of string | | |
| properties | base xs:string | | |
| facets | Kind | Value | Annotation |
| | enumeration | 0375001 | documentation keine Symptome oder Angina |
| | enumeration | 0375002 | documentation Symptome, aber keine Ischämiezeichen |
| | enumeration | 0375003 | documentation stabile Angina |
| | enumeration | 0375004 | documentation instabile Angina |
| | enumeration | 0375005 | documentation Infarkt ohne ST-Hebung (Non-STEMI) |
| | enumeration | 0375006 | documentation Infarkt mit ST-Hebung (STEMI) |
| | enumeration | 0375042 | documentation unbekannt |
| annotation | documentation Kat_AK_KardialeSymptome | | |
| source | <pre> <simpleType name="enum_0375"> <annotation> <documentation>Kat_AK_KardialeSymptome</documentation> </annotation> <restriction base="xs:string"> <enumeration value="0375001"> <annotation> <documentation>keine Symptome oder Angina</documentation> </annotation> </enumeration> <enumeration value="0375002"> <annotation> <documentation>Symptome, aber keine Ischämiezeichen</documentation> </annotation> </enumeration> </restriction> </pre> | | |

| | |
|--|---|
| | <pre> <enumeration value="0375003"> <annotation> <documentation>stabile Angina</documentation> </annotation> </enumeration> <enumeration value="0375004"> <annotation> <documentation>instabile Angina</documentation> </annotation> </enumeration> <enumeration value="0375005"> <annotation> <documentation>Infarkt ohne ST-Hebung (Non-STEMI)</documentation> </annotation> </enumeration> <enumeration value="0375006"> <annotation> <documentation>Infarkt mit ST-Hebung (STEMI)</documentation> </annotation> </enumeration> <enumeration value="0375042"> <annotation> <documentation>unbekannt</documentation> </annotation> </enumeration> </restriction> </simpleType> </pre> |
|--|---|

simpleType enum_0376

| | | | |
|------------|---|---------|---|
| namespace | http://xml.ir-d.de/irdma | | |
| type | restriction of string | | |
| properties | base xs:string | | |
| facets | Kind | Value | Annotation |
| | enumeration | 0376001 | documentation nein |
| | enumeration | 0376002 | documentation ja, ZNS, zerebrovaskuläre Blutung |
| | enumeration | 0376003 | documentation ja, ZNS, zerebrovaskuläre Ischämie |
| | enumeration | 0376042 | documentation ja, ZNS, andere |
| annotation | documentation Kat_AK_Schlaganfall | | |
| source | <pre> <simpleType name="enum_0376"> <annotation> <documentation>Kat_AK_Schlaganfall</documentation> </annotation> <restriction base="xs:string"> <enumeration value="0376001"> <annotation> <documentation>nein</documentation> </annotation> </enumeration> <enumeration value="0376002"> <annotation> <documentation>ja, ZNS, zerebrovaskuläre Blutung</documentation> </pre> | | |

| | |
|--|---|
| | <pre> </annotation> </enumeration> <enumeration value="0376003"> <annotation> <documentation>ja, ZNS, zerebrovaskuläre Ischämie</documentation> </annotation> </enumeration> <enumeration value="0376042"> <annotation> <documentation>ja, ZNS, andere</documentation> </annotation> </enumeration> </restriction> </simpleType> </pre> |
|--|---|

simpleType enum_0377

| | | | |
|------------|---|---------|---|
| namespace | http://xml.lir-d.de/irdma | | |
| type | restriction of string | | |
| properties | base xs:string | | |
| facets | Kind | Value | Annotation |
| | enumeration | 0377001 | documentation ja, mild neurological dysfunction: NIHSS 0-5 |
| | enumeration | 0377002 | documentation ja, moderate neurological dysfunction: NIHSS 6-14 |
| | enumeration | 0377003 | documentation ja, severe neurological dysfunction: NIHSS >=15 |
| annotation | documentation Kat_AK_Nihss | | |
| source | <pre> <simpleType name="enum_0377"> <annotation> <documentation>Kat_AK_Nihss</documentation> </annotation> <restriction base="xs:string"> <enumeration value="0377001"> <annotation> <documentation>ja, mild neurological dysfunction: NIHSS 0-5</documentation> </annotation> </enumeration> <enumeration value="0377002"> <annotation> <documentation>ja, moderate neurological dysfunction: NIHSS 6-14</documentation> </annotation> </enumeration> <enumeration value="0377003"> <annotation> <documentation> ja, severe neurological dysfunction: NIHSS &gt;=15</documentation> </annotation> </enumeration> </restriction> </simpleType> </pre> | | |

simpleType enum_0378

| | | | |
|------------|---|---------|--|
| namespace | http://xml.ir-d.de/irdma | | |
| type | restriction of string | | |
| properties | base xs:string | | |
| facets | Kind | Value | Annotation |
| | enumeration | 0378001 | documentation nein |
| | enumeration | 0378002 | documentation ja, < 48h gemäss VARC-3-Definition |
| | enumeration | 0378003 | documentation ja, >= 48h - <= 72h gemäß VARC-3-Definition |
| | enumeration | 0378004 | documentation ja, > 72 h gemäß VARC-3 Definition |
| annotation | documentation Kat_AK_Myokardinfarkt | | |
| source | <pre> <simpleType name="enum_0378"> <annotation> <documentation>Kat_AK_Myokardinfarkt</documentation> </annotation> <restriction base="xs:string"> <enumeration value="0378001"> <annotation> <documentation>nein</documentation> </annotation> </enumeration> <enumeration value="0378002"> <annotation> <documentation>ja, &lt; 48h gemäss VARC-3-Definition</documentation> </annotation> </enumeration> <enumeration value="0378003"> <annotation> <documentation>ja, &gt;= 48h - &lt;= 72h gemäß VARC-3-Definition</documentation> </annotation> </enumeration> <enumeration value="0378004"> <annotation> <documentation>ja, &gt; 72 h gemäß VARC-3 Definition</documentation> </annotation> </enumeration> </restriction> </simpleType> </pre> | | |

simpleType enum_0379

| | | | |
|------------|------------------------------|---------|--|
| namespace | http://xml.ir-d.de/irdma | | |
| type | restriction of string | | |
| properties | base xs:string | | |
| facets | Kind | Value | Annotation |
| | enumeration | 0379001 | documentation Keine gefäss- oder zugangsassozierte Komplikationen |
| | enumeration | 0379002 | documentation Versagen des perkutanen Verschlusssystems |
| | enumeration | 0379003 | documentation Geringfügige Gefäßkomplikationen |

| | |
|------------|--|
| | enumeration 0379004 documentation Erhebliche Gefäßkomplikationen |
| annotation | documentation Kat_AK_ZugangKomplikationen |
| source | <pre> <simpleType name="enum_0379"> <annotation> <documentation>Kat_AK_ZugangKomplikationen</documentation> </annotation> <restriction base="xs:string"> <enumeration value="0379001"> <annotation> <documentation>Keine gefäss- oder zugangsassoziierte Komplikationen</documentation> </annotation> </enumeration> <enumeration value="0379002"> <annotation> <documentation>Versagen des perkutanen Verschlussystems</documentation> </annotation> </enumeration> <enumeration value="0379003"> <annotation> <documentation>Geringfügige Gefäßkomplikationen</documentation> </annotation> </enumeration> <enumeration value="0379004"> <annotation> <documentation>Erhebliche Gefäßkomplikationen</documentation> </annotation> </enumeration> </restriction> </simpleType> </pre> |

simpleType enum_0380

| | | | |
|------------|---|---------|--|
| namespace | http://xml.ir-d.de/irdma | | |
| type | restriction of string | | |
| properties | base xs:string | | |
| facets | Kind | Value | Annotation |
| | enumeration | 0380001 | documentation nein |
| | enumeration | 0380002 | documentation ja, intraprozedural |
| | enumeration | 0380003 | documentation ja, postprozedural |
| | enumeration | 0380004 | documentation ja, Zeitpunkt nicht bekannt |
| annotation | documentation Kat_AK_Reanimation | | |
| source | <pre> <simpleType name="enum_0380"> <annotation> <documentation>Kat_AK_Reanimation</documentation> </annotation> <restriction base="xs:string"> <enumeration value="0380001"> <annotation> </pre> | | |

| | |
|--|--|
| | <pre> <documentation>nein</documentation> </annotation> </enumeration> <enumeration value="0380002"> <annotation> <documentation>ja, intraprozedural</documentation> </annotation> </enumeration> <enumeration value="0380003"> <annotation> <documentation>ja, postprozedural</documentation> </annotation> </enumeration> <enumeration value="0380004"> <annotation> <documentation>ja, Zeitpunkt nicht bekannt</documentation> </annotation> </enumeration> </restriction> </simpleType> </pre> |
|--|--|

simpleType enum_0381

| | | | |
|------------|---|---------|---|
| namespace | http://xml.ir-d.de/irdma | | |
| type | restriction of string | | |
| properties | base xs:string | | |
| facets | Kind | Value | Annotation |
| | enumeration | 0381001 | documentation nein |
| | enumeration | 0381002 | documentation Thorakotomie/Rethorakotomie |
| | enumeration | 0381003 | documentation kathetergestützte Reintervention |
| | enumeration | 0381004 | documentation lokale Reinterventionen |
| | enumeration | 0381005 | documentation andere Reintervention |
| annotation | documentation Kat_AK_Massnahmen | | |
| source | <pre> <simpleType name="enum_0381"> <annotation> <documentation>Kat_AK_Massnahmen</documentation> </annotation> <restriction base="xs:string"> <enumeration value="0381001"> <annotation> <documentation>nein</documentation> </annotation> </enumeration> <enumeration value="0381002"> <annotation> <documentation>Thorakotomie/Rethorakotomie</documentation> </annotation> </enumeration> <enumeration value="0381003"> <annotation> <documentation>kathetergestützte Reintervention</documentation> </pre> | | |

| | |
|--|--|
| | <pre> </annotation> </enumeration> <enumeration value="0381004"> <annotation> <documentation>lokale Reinterventionen</documentation> </annotation> </enumeration> <enumeration value="0381005"> <annotation> <documentation>andere Reintervention</documentation> </annotation> </enumeration> </restriction> </simpleType> </pre> |
|--|--|

simpleType enum_0382

| | | | |
|------------|---|---------|--|
| namespace | http://xml.lir-d.de/irdma | | |
| type | restriction of string | | |
| properties | base xs:string | | |
| facets | Kind | Value | Annotation |
| | enumeration | 0382001 | documentation keine Rethorakotomie / kein weiterer Grund |
| | enumeration | 0382002 | documentation Blutung/Hämatom |
| | enumeration | 0382003 | documentation Low Cardiac Output |
| | enumeration | 0382004 | documentation Tamponade |
| | enumeration | 0382005 | documentation Graftprobleme, Ischämie |
| | enumeration | 0382006 | documentation Wundinfektion, Mediastinitis |
| | enumeration | 0382007 | documentation Dissektion |
| | enumeration | 0382008 | documentation Prothesendysfunktion |
| | enumeration | 0382009 | documentation instabiles Sternum |
| | enumeration | 0382010 | documentation Chylothorax |
| | enumeration | 0382011 | documentation lokale Revision im Bereich des Zugangsweges |
| | enumeration | 0382042 | documentation anderer Grund |
| annotation | documentation Kat_AK_Komplikation | | |
| source | <pre> <simpleType name="enum_0382"> <annotation> <documentation>Kat_AK_Komplikation</documentation> </annotation> <restriction base="xs:string"> <enumeration value="0382001"> <annotation> <documentation>keine Rethorakotomie / kein weiterer Grund</documentation> </annotation> </enumeration> </pre> | | |

```

<enumeration value="0382002">
  <annotation>
    <documentation>Blutung/Hämatom</documentation>
  </annotation>
</enumeration>
<enumeration value="0382003">
  <annotation>
    <documentation>Low Cardiac Output</documentation>
  </annotation>
</enumeration>
<enumeration value="0382004">
  <annotation>
    <documentation>Tamponade</documentation>
  </annotation>
</enumeration>
<enumeration value="0382005">
  <annotation>
    <documentation>Graftprobleme, Ischämie</documentation>
  </annotation>
</enumeration>
<enumeration value="0382006">
  <annotation>
    <documentation>Wundinfektion, Mediastinitis</documentation>
  </annotation>
</enumeration>
<enumeration value="0382007">
  <annotation>
    <documentation>Dissektion</documentation>
  </annotation>
</enumeration>
<enumeration value="0382008">
  <annotation>
    <documentation>Prothesendysfunktion</documentation>
  </annotation>
</enumeration>
<enumeration value="0382009">
  <annotation>
    <documentation>instabiles Sternum</documentation>
  </annotation>
</enumeration>
<enumeration value="0382010">
  <annotation>
    <documentation>Chylothorax</documentation>
  </annotation>
</enumeration>
<enumeration value="0382011">
  <annotation>
    <documentation>lokale Revision im Bereich des
Zugangsweges</documentation>
  </annotation>
</enumeration>
<enumeration value="0382042">
  <annotation>
    <documentation>anderer Grund</documentation>
  </annotation>
</enumeration>
</restriction>
</simpleType>

```

simpleType enum_0383

| | | | |
|------------|---|---------|--|
| namespace | http://xml.ir-d.de/irdma | | |
| type | restriction of string | | |
| properties | base xs:string | | |
| facets | Kind | Value | Annotation |
| | enumeration | 0383001 | documentation nein |
| | enumeration | 0383002 | documentation ja, mit forcierter Atemtherapie |
| | enumeration | 0383003 | documentation ja, Reintubation oder längerfristige Beatmung |
| | enumeration | 0383004 | documentation ja, Tracheotomie |
| annotation | documentation Kat_AK_RespiratorischeInsuffizienz | | |
| source | <pre> <simpleType name="enum_0383"> <annotation> <documentation>Kat_AK_RespiratorischeInsuffizienz</documentation> </annotation> <restriction base="xs:string"> <enumeration value="0383001"> <annotation> <documentation>nein</documentation> </annotation> </enumeration> <enumeration value="0383002"> <annotation> <documentation>ja, mit forcierter Atemtherapie</documentation> </annotation> </enumeration> <enumeration value="0383003"> <annotation> <documentation>ja, Reintubation oder längerfristige Beatmung</documentation> </annotation> </enumeration> <enumeration value="0383004"> <annotation> <documentation>ja, Tracheotomie</documentation> </annotation> </enumeration> </restriction> </simpleType> </pre> | | |

simpleType enum_0384

| | | | |
|------------|------------------------------|---------|--|
| namespace | http://xml.ir-d.de/irdma | | |
| type | restriction of string | | |
| properties | base xs:string | | |
| facets | Kind | Value | Annotation |
| | enumeration | 0384001 | documentation keine Blutungskomplikationen |
| | enumeration | 0384002 | documentation Geringfügige Blutung (Minor Bleeding - BARC type 2 or 3a) |

| | |
|------------|--|
| | enumeration 0384003 documentation Starke Blutung (Major Bleeding - BARC type 3a) enumeration 0384004 documentation Lebensbedrohliche Blutung (Life-threatening or disabling bleeding - BARC type 3b or 3c or type 5) |
| annotation | documentation Kat_AK_Blutungskomplikation |
| source | <pre> <simpleType name="enum_0384"> <annotation> <documentation>Kat_AK_Blutungskomplikation</documentation> </annotation> <restriction base="xs:string"> <enumeration value="0384001"> <annotation> <documentation>keine Blutungskomplikationen</documentation> </annotation> </enumeration> <enumeration value="0384002"> <annotation> <documentation>Geringfügige Blutung (Minor Bleeding - BARC type 2 or 3a)</documentation> </annotation> </enumeration> <enumeration value="0384003"> <annotation> <documentation>Starke Blutung (Major Bleeding - BARC type 3a)</documentation> </annotation> </enumeration> <enumeration value="0384004"> <annotation> <documentation>Lebensbedrohliche Blutung (Life-threatening or disabling bleeding - BARC type 3b or 3c or type 5)</documentation> </annotation> </enumeration> </restriction> </simpleType> </pre> |

simpleType enum_0385

| | | | |
|------------|--|---------|---|
| namespace | http://xml.ir-d.de/irdma | | |
| type | restriction of string | | |
| properties | base xs:string | | |
| facets | Kind | Value | Annotation |
| | enumeration | 0385001 | documentation Sinusrhythmus |
| | enumeration | 0385002 | documentation Vorhofflimmern |
| | enumeration | 0385003 | documentation Patient verstorben (kein Herzrhythmus) |
| | enumeration | 0385042 | documentation anderer Rhythmus |
| annotation | documentation Kat_AK_HerzrhythmusEntlassung | | |
| source | <pre> <simpleType name="enum_0385"> <annotation> <documentation>Kat_AK_HerzrhythmusEntlassung</documentation> </pre> | | |

| | |
|--|---|
| | <pre> </annotation> <restriction base="xs:string"> <enumeration value="0385001"> <annotation> <documentation>Sinusrhythmus</documentation> </annotation> </enumeration> <enumeration value="0385002"> <annotation> <documentation>Vorhofflimmern</documentation> </annotation> </enumeration> <enumeration value="0385003"> <annotation> <documentation>Patient verstorben (kein Herzrhythmus)</documentation> </annotation> </enumeration> <enumeration value="0385042"> <annotation> <documentation>anderer Rhythmus</documentation> </annotation> </enumeration> </restriction> </simpleType> </pre> |
|--|---|

simpleType **enum_0388**

| | | | |
|------------|--|---------|--|
| namespace | http://xml.ir-d.de/irdma | | |
| type | restriction of string | | |
| properties | base xs:string | | |
| facets | Kind | Value | Annotation |
| | enumeration | 0388001 | documentation nein |
| | enumeration | 0388002 | documentation ASS |
| | enumeration | 0388003 | documentation ADP-Rezeptor-Antagonist |
| | enumeration | 0388004 | documentation Kombination ASS und ADP-Rezeptor-Antagonist |
| | enumeration | 0388042 | documentation ja, andere |
| | enumeration | 0388099 | documentation unbekannt |
| annotation | documentation Kat_AK_Plaettchenaggregationshemmer | | |
| source | <pre> <simpleType name="enum_0388"> <annotation> <documentation>Kat_AK_Plaettchenaggregationshemmer</documentation> </annotation> <restriction base="xs:string"> <enumeration value="0388001"> <annotation> <documentation>nein</documentation> </annotation> </enumeration> <enumeration value="0388002"> <annotation> </pre> | | |

| | |
|--|--|
| | <pre> <documentation>ASS</documentation> </annotation> </enumeration> <enumeration value="0388003"> <annotation> <documentation>ADP-Rezeptor-Antagonist</documentation> </annotation> </enumeration> <enumeration value="0388004"> <annotation> <documentation>Kombination ASS und ADP-Rezeptor-Antagonist</documentation> </annotation> </enumeration> <enumeration value="0388042"> <annotation> <documentation>ja, andere</documentation> </annotation> </enumeration> <enumeration value="0388099"> <annotation> <documentation>unbekannt</documentation> </annotation> </enumeration> </restriction> </simpleType> </pre> |
|--|--|

simpleType enum_0389

| | | | |
|------------|--|---------|---|
| namespace | http://xml.ir-d.de/irdma | | |
| type | restriction of string | | |
| properties | base xs:string | | |
| facets | Kind | Value | Annotation |
| | enumeration | 0389001 | documentation nein |
| | enumeration | 0389002 | documentation Cumarin-Derivate |
| | enumeration | 0389003 | documentation Heparinoide |
| | enumeration | 0389004 | documentation orale Thrombinantagonisten |
| | enumeration | 0389005 | documentation Kombination Heparinoide und Cumarin-Derivate |
| | enumeration | 0389006 | documentation Direkte orale Antikoagulantien (DOAK / NOAK) |
| | enumeration | 0389042 | documentation ja, andere |
| | enumeration | 0389099 | documentation unbekannt |
| annotation | documentation Kat AK Antikoagulantien | | |
| source | <pre> <simpleType name="enum_0389"> <annotation> <documentation>Kat_AK_Antikoagulantien</documentation> </annotation> <restriction base="xs:string"> <enumeration value="0389001"> <annotation> </pre> | | |

```

        <documentation>nein</documentation>
    </annotation>
</enumeration>
<enumeration value="0389002">
    <annotation>
        <documentation>Cumarin-Derivate</documentation>
    </annotation>
</enumeration>
<enumeration value="0389003">
    <annotation>
        <documentation>Heparinoide</documentation>
    </annotation>
</enumeration>
<enumeration value="0389004">
    <annotation>
        <documentation>orale Thrombinantagonisten</documentation>
    </annotation>
</enumeration>
<enumeration value="0389005">
    <annotation>
        <documentation>Kombination Heparinoide und
Cumarin-Derivate</documentation>
    </annotation>
</enumeration>
<enumeration value="0389006">
    <annotation>
        <documentation>Direkte orale Antikoagulantien (DOAK /
NOAK)</documentation>
    </annotation>
</enumeration>
<enumeration value="0389042">
    <annotation>
        <documentation>ja, andere</documentation>
    </annotation>
</enumeration>
<enumeration value="0389099">
    <annotation>
        <documentation>unbekannt</documentation>
    </annotation>
</enumeration>
</restriction>
</simpleType>

```

simpleType **enum_0390**

| | | | |
|------------|---|---------|---|
| namespace | http://xml.ir-d.de/irdma | | |
| type | restriction of string | | |
| properties | base xs:string | | |
| facets | Kind | Value | Annotation |
| | enumeration | 0390001 | documentation biologisches Klappenmodell |
| | enumeration | 0390002 | documentation mechanisches Klappenmodell |
| annotation | documentation Kat_AK_Artikeltyp | | |
| source | <simpleType name="enum_0390"> <annotation> | | |

| | |
|--|---|
| | <pre> <documentation>Kat_AK_Artikeltyp</documentation> </annotation> <restriction base="xs:string"> <enumeration value="0390001"> <annotation> <documentation>biologisches Klappenmodell</documentation> </annotation> </enumeration> <enumeration value="0390002"> <annotation> <documentation>mechanisches Klappenmodell</documentation> </annotation> </enumeration> </restriction> </simpleType> </pre> |
|--|---|

simpleType enum 0398

| | | | |
|------------|--|---------|--|
| namespace | http://xml.ir-d.de/irdma | | |
| type | restriction of string | | |
| properties | base xs:string | | |
| facets | Kind | Value | Annotation |
| | enumeration | 0398001 | documentation kardiovaskuläre Ursache |
| | enumeration | 0398002 | documentation nicht-kardiovaskuläre Ursache |
| | enumeration | 0398099 | documentation Todesursache unbekannt |
| annotation | documentation Kat_AK_Todesursache | | |
| source | <pre> <simpleType name="enum_0398"> <annotation> <documentation>Kat_AK_Todesursache</documentation> </annotation> <restriction base="xs:string"> <enumeration value="0398001"> <annotation> <documentation>kardiovaskuläre Ursache</documentation> </annotation> </enumeration> <enumeration value="0398002"> <annotation> <documentation>nicht-kardiovaskuläre Ursache</documentation> </annotation> </enumeration> <enumeration value="0398099"> <annotation> <documentation>Todesursache unbekannt</documentation> </annotation> </enumeration> </restriction> </simpleType> </pre> | | |

simpleType enum_0399

| | | | |
|------------|--|---------|--|
| namespace | http://xml.ir-d.de/irdma | | |
| type | restriction of string | | |
| properties | base xs:string | | |
| facets | Kind | Value | Annotation |
| | enumeration | 0399001 | documentation Patient lebt |
| | enumeration | 0399002 | documentation Patient im Krankenhaus verstorben |
| annotation | documentation Kat_AK_Vitalstatus | | |
| source | <pre> <simpleType name="enum_0399"> <annotation> <documentation>Kat_AK_Vitalstatus</documentation> </annotation> <restriction base="xs:string"> <enumeration value="0399001"> <annotation> <documentation>Patient lebt</documentation> </annotation> </enumeration> <enumeration value="0399002"> <annotation> <documentation>Patient im Krankenhaus verstorben</documentation> </annotation> </enumeration> </restriction> </simpleType> </pre> | | |

simpleType enum_0044

| | | | |
|------------|--|---------|---|
| namespace | http://xml.ir-d.de/irdsa | | |
| type | restriction of string | | |
| properties | base xs:string | | |
| facets | Kind | Value | Annotation |
| | enumeration | 0044001 | documentation 1= normaler, sonst gesunder Patient |
| | enumeration | 0044002 | documentation 2= Patient mit leichter Allgemeinerkrankung |
| | enumeration | 0044003 | documentation 3= Patient mit schwerer Allgemeinerkrankung |
| | enumeration | 0044004 | documentation 4= Patient mit schwerer Allgemeinerkrankung, die eine ständige Lebensbedrohung darstellt |
| | enumeration | 0044005 | documentation 5= moribunder Patient, der ohne die Operation voraussichtlich nicht überleben wird |
| annotation | documentation Kat_ASA | | |
| source | <pre> <simpleType name="enum_0044"> <annotation> <documentation>Kat_ASA</documentation> </annotation> <restriction base="xs:string"> <enumeration value="0044001"> <annotation> </pre> | | |

| | |
|--|---|
| | <pre> <documentation>1= normaler, sonst gesunder Patient</documentation> </annotation> </enumeration> <enumeration value="0044002"> <annotation> <documentation>2= Patient mit leichter Allgemeinerkrankung</documentation> </annotation> </enumeration> <enumeration value="0044003"> <annotation> <documentation>3= Patient mit schwerer Allgemeinerkrankung</documentation> </annotation> </enumeration> <enumeration value="0044004"> <annotation> <documentation>4= Patient mit schwerer Allgemeinerkrankung, die eine ständige Lebensbedrohung darstellt</documentation> </annotation> </enumeration> <enumeration value="0044005"> <annotation> <documentation>5= moribunder Patient, der ohne die Operation voraussichtlich nicht überleben wird</documentation> </annotation> </enumeration> </restriction> </simpleType> </pre> |
|--|---|

simpleType enum_0050

| | | | |
|------------|---|---------|-------------------------|
| namespace | http://xml.ir-d.de/irdsa | | |
| type | restriction of string | | |
| properties | base xs:string | | |
| facets | Kind | Value | Annotation |
| | enumeration | 0050001 | documentation rechts |
| | enumeration | 0050002 | documentation links |
| annotation | documentation Kat_RechtsLinks | | |
| source | <pre> <simpleType name="enum_0050"> <annotation> <documentation>Kat_RechtsLinks</documentation> </annotation> <restriction base="xs:string"> <enumeration value="0050001"> <annotation> <documentation>rechts</documentation> </annotation> </enumeration> <enumeration value="0050002"> <annotation> <documentation>links</documentation> </annotation> </enumeration> </restriction> </simpleType> </pre> | | |

| | |
|--|---|
| | <pre> </restriction> </simpleType> </pre> |
|--|---|

simpleType enum_0060

| | | | |
|------------|---|---------|-----------------------|
| namespace | http://xml.ir-d.de/irdsa | | |
| type | restriction of string | | |
| properties | base xs:string | | |
| facets | Kind | Value | Annotation |
| | enumeration | 0060001 | documentation ja |
| | enumeration | 0060002 | documentation nein |
| annotation | documentation Kat_JaNein | | |
| source | <pre> <simpleType name="enum_0060"> <annotation> <documentation>Kat_JaNein</documentation> </annotation> <restriction base="xs:string"> <enumeration value="0060001"> <annotation> <documentation>ja</documentation> </annotation> </enumeration> <enumeration value="0060002"> <annotation> <documentation>nein</documentation> </annotation> </enumeration> </restriction> </simpleType> </pre> | | |

simpleType enum_0061

| | | | |
|------------|--|---------|----------------------------|
| namespace | http://xml.ir-d.de/irdsa | | |
| type | restriction of string | | |
| properties | base xs:string | | |
| facets | Kind | Value | Annotation |
| | enumeration | 0061001 | documentation ja |
| | enumeration | 0061002 | documentation nein |
| | enumeration | 0061099 | documentation unbekannt |
| annotation | documentation Kat_JaNeinUnbekannt | | |
| source | <pre> <simpleType name="enum_0061"> <annotation> <documentation>Kat_JaNeinUnbekannt</documentation> </annotation> <restriction base="xs:string"> <enumeration value="0061001"> <annotation> </pre> | | |

| | |
|--|---|
| | <pre> <documentation>ja</documentation> </annotation> </enumeration> <enumeration value="0061002"> <annotation> <documentation>nein</documentation> </annotation> </enumeration> <enumeration value="0061099"> <annotation> <documentation>unbekannt</documentation> </annotation> </enumeration> </restriction> </simpleType> </pre> |
|--|---|

simpleType enum_0062

| | | | |
|------------|---|---------|----------------------------------|
| namespace | http://xml.ir-d.de/irdsa | | |
| type | restriction of string | | |
| properties | base xs:string | | |
| facets | Kind | Value | Annotation |
| | enumeration | 0062001 | documentation Stück |
| | enumeration | 0062002 | documentation g |
| | enumeration | 0062003 | documentation mg |
| | enumeration | 0062004 | documentation l |
| | enumeration | 0062005 | documentation ml |
| | enumeration | 0062006 | documentation cm ³ |
| | enumeration | 0062007 | documentation mm |
| | enumeration | 0062008 | documentation cm |
| | enumeration | 0062009 | documentation dm |
| | enumeration | 0062010 | documentation m |
| | enumeration | 0062042 | documentation andere |
| annotation | documentation Kat Einheit | | |
| source | <pre> <simpleType name="enum_0062"> <annotation> <documentation>Kat_Einheit</documentation> </annotation> <restriction base="xs:string"> <enumeration value="0062001"> <annotation> <documentation>Stück</documentation> </annotation> </enumeration> <enumeration value="0062002"> <annotation> </pre> | | |

```

    <documentation>g</documentation>
  </annotation>
</enumeration>
<enumeration value="0062003">
  <annotation>
    <documentation>mg</documentation>
  </annotation>
</enumeration>
<enumeration value="0062004">
  <annotation>
    <documentation>l</documentation>
  </annotation>
</enumeration>
<enumeration value="0062005">
  <annotation>
    <documentation>ml</documentation>
  </annotation>
</enumeration>
<enumeration value="0062006">
  <annotation>
    <documentation>cm3</documentation>
  </annotation>
</enumeration>
<enumeration value="0062007">
  <annotation>
    <documentation>mm</documentation>
  </annotation>
</enumeration>
<enumeration value="0062008">
  <annotation>
    <documentation>cm</documentation>
  </annotation>
</enumeration>
<enumeration value="0062009">
  <annotation>
    <documentation>dm</documentation>
  </annotation>
</enumeration>
<enumeration value="0062010">
  <annotation>
    <documentation>m</documentation>
  </annotation>
</enumeration>
<enumeration value="0062042">
  <annotation>
    <documentation>andere</documentation>
  </annotation>
</enumeration>
</restriction>
</simpleType>

```

simpleType enum_0065

| | |
|------------|------------------------------|
| namespace | http://xml.ir-d.de/irdsa |
| type | restriction of string |
| properties | base xs:string |

| facets | <table border="1"> <thead> <tr> <th>Kind</th> <th>Value</th> <th>Annotation</th> </tr> </thead> <tbody> <tr> <td>enumeration</td> <td>0065001</td> <td>documentation stationär</td> </tr> <tr> <td>enumeration</td> <td>0065002</td> <td>documentation teilstationär</td> </tr> <tr> <td>enumeration</td> <td>0065003</td> <td>documentation ambulant</td> </tr> </tbody> </table> | Kind | Value | Annotation | enumeration | 0065001 | documentation stationär | enumeration | 0065002 | documentation teilstationär | enumeration | 0065003 | documentation ambulant |
|-------------|--|--------------------------------|-------|------------|-------------|---------|----------------------------|-------------|---------|--------------------------------|-------------|---------|---------------------------|
| Kind | Value | Annotation | | | | | | | | | | | |
| enumeration | 0065001 | documentation stationär | | | | | | | | | | | |
| enumeration | 0065002 | documentation teilstationär | | | | | | | | | | | |
| enumeration | 0065003 | documentation ambulant | | | | | | | | | | | |
| annotation | documentation Kat_ArtAufenthalt | | | | | | | | | | | | |
| source | <pre><simpleType name="enum_0065"> <annotation> <documentation>Kat_ArtAufenthalt</documentation> </annotation> <restriction base="xs:string"> <enumeration value="0065001"> <annotation> <documentation>stationär</documentation> </annotation> </enumeration> <enumeration value="0065002"> <annotation> <documentation>teilstationär</documentation> </annotation> </enumeration> <enumeration value="0065003"> <annotation> <documentation>ambulant</documentation> </annotation> </enumeration> </restriction> </simpleType></pre> | | | | | | | | | | | | |

simpleType enum_0067

| namespace | http://xml.ir-d.de/irdsa | | | | | | | | | |
|-------------|---|----------------------------|-------|------------|-------------|---------|----------------------------|-------------|---------|----------------------------|
| type | restriction of string | | | | | | | | | |
| properties | base xs:string | | | | | | | | | |
| facets | <table border="1"> <thead> <tr> <th>Kind</th> <th>Value</th> <th>Annotation</th> </tr> </thead> <tbody> <tr> <td>enumeration</td> <td>0067001</td> <td>documentation Implantat</td> </tr> <tr> <td>enumeration</td> <td>0067002</td> <td>documentation Explantat</td> </tr> </tbody> </table> | Kind | Value | Annotation | enumeration | 0067001 | documentation Implantat | enumeration | 0067002 | documentation Explantat |
| Kind | Value | Annotation | | | | | | | | |
| enumeration | 0067001 | documentation Implantat | | | | | | | | |
| enumeration | 0067002 | documentation Explantat | | | | | | | | |
| annotation | documentation Kat_ArtArtikel | | | | | | | | | |
| source | <pre><simpleType name="enum_0067"> <annotation> <documentation>Kat_ArtArtikel</documentation> </annotation> <restriction base="xs:string"> <enumeration value="0067001"> <annotation> <documentation>Implantat</documentation> </annotation> </enumeration> <enumeration value="0067002"> <annotation> <documentation>Explantat</documentation> </annotation> </enumeration> </restriction> </simpleType></pre> | | | | | | | | | |

| | |
|--|--|
| | <pre> </annotation> </enumeration> </restriction> </simpleType> </pre> |
|--|--|

simpleType enum_0068

| namespace | http://xml.ir-d.de/irdsa | | | | | | | | | | | | | | | |
|-------------|--|---------------------------------|-------|------------|-------------|---------|----------------------|-------------|---------|---------------------------------|-------------|---------|--------------------------------|-------------|---------|----------------------------|
| type | restriction of string | | | | | | | | | | | | | | | |
| properties | base xs:string | | | | | | | | | | | | | | | |
| facets | <table border="1"> <thead> <tr> <th>Kind</th> <th>Value</th> <th>Annotation</th> </tr> </thead> <tbody> <tr> <td>enumeration</td> <td>0068001</td> <td>documentation UDI</td> </tr> <tr> <td>enumeration</td> <td>0068002</td> <td>documentation Referenz (REF)</td> </tr> <tr> <td>enumeration</td> <td>0068003</td> <td>documentation Katalognummer</td> </tr> <tr> <td>enumeration</td> <td>0068042</td> <td>documentation sonstiger</td> </tr> </tbody> </table> | Kind | Value | Annotation | enumeration | 0068001 | documentation UDI | enumeration | 0068002 | documentation Referenz (REF) | enumeration | 0068003 | documentation Katalognummer | enumeration | 0068042 | documentation sonstiger |
| Kind | Value | Annotation | | | | | | | | | | | | | | |
| enumeration | 0068001 | documentation UDI | | | | | | | | | | | | | | |
| enumeration | 0068002 | documentation Referenz (REF) | | | | | | | | | | | | | | |
| enumeration | 0068003 | documentation Katalognummer | | | | | | | | | | | | | | |
| enumeration | 0068042 | documentation sonstiger | | | | | | | | | | | | | | |
| annotation | documentation Kat_KennzeichenTyp | | | | | | | | | | | | | | | |
| source | <pre> <simpleType name="enum_0068"> <annotation> <documentation>Kat_KennzeichenTyp</documentation> </annotation> <restriction base="xs:string"> <enumeration value="0068001"> <annotation> <documentation>UDI</documentation> </annotation> </enumeration> <enumeration value="0068002"> <annotation> <documentation>Referenz (REF)</documentation> </annotation> </enumeration> <enumeration value="0068003"> <annotation> <documentation>Katalognummer</documentation> </annotation> </enumeration> <enumeration value="0068042"> <annotation> <documentation>sonstiger</documentation> </annotation> </enumeration> </restriction> </simpleType> </pre> | | | | | | | | | | | | | | | |

simpleType enum_0069

| | |
|------------|------------------------------|
| namespace | http://xml.ir-d.de/irdsa |
| type | restriction of string |
| properties | base xs:string |

| facets | <table border="1"> <thead> <tr> <th>Kind</th> <th>Value</th> <th>Annotation</th> </tr> </thead> <tbody> <tr> <td>enumeration</td> <td>0069001</td> <td>documentation Implantat</td> </tr> <tr> <td>enumeration</td> <td>0069002</td> <td>documentation Explantat</td> </tr> </tbody> </table> | Kind | Value | Annotation | enumeration | 0069001 | documentation Implantat | enumeration | 0069002 | documentation Explantat |
|-------------|--|----------------------------|-------|------------|-------------|---------|----------------------------|-------------|---------|----------------------------|
| Kind | Value | Annotation | | | | | | | | |
| enumeration | 0069001 | documentation Implantat | | | | | | | | |
| enumeration | 0069002 | documentation Explantat | | | | | | | | |
| annotation | documentation Kat_ArtZubehoer | | | | | | | | | |
| source | <pre><simpleType name="enum_0069"> <annotation> <documentation>Kat_ArtZubehoer</documentation> </annotation> <restriction base="xs:string"> <enumeration value="0069001"> <annotation> <documentation>Implantat</documentation> </annotation> </enumeration> <enumeration value="0069002"> <annotation> <documentation>Explantat</documentation> </annotation> </enumeration> </restriction> </simpleType></pre> | | | | | | | | | |

simpleType enum_0070

| namespace | http://xml.ir-d.de/irdsa | | | | | | | | | | | | | | | |
|-------------|--|-----------------------------|-------|------------|-------------|---------|---------------------------|-------------|---------|---------------------------|-------------|---------|-------------------------|-------------|---------|-----------------------------|
| type | restriction of string | | | | | | | | | | | | | | | |
| properties | base xs:string | | | | | | | | | | | | | | | |
| facets | <table border="1"> <thead> <tr> <th>Kind</th> <th>Value</th> <th>Annotation</th> </tr> </thead> <tbody> <tr> <td>enumeration</td> <td>0070001</td> <td>documentation weiblich</td> </tr> <tr> <td>enumeration</td> <td>0070002</td> <td>documentation männlich</td> </tr> <tr> <td>enumeration</td> <td>0070003</td> <td>documentation divers</td> </tr> <tr> <td>enumeration</td> <td>0070042</td> <td>documentation unbestimmt</td> </tr> </tbody> </table> | Kind | Value | Annotation | enumeration | 0070001 | documentation weiblich | enumeration | 0070002 | documentation männlich | enumeration | 0070003 | documentation divers | enumeration | 0070042 | documentation unbestimmt |
| Kind | Value | Annotation | | | | | | | | | | | | | | |
| enumeration | 0070001 | documentation weiblich | | | | | | | | | | | | | | |
| enumeration | 0070002 | documentation männlich | | | | | | | | | | | | | | |
| enumeration | 0070003 | documentation divers | | | | | | | | | | | | | | |
| enumeration | 0070042 | documentation unbestimmt | | | | | | | | | | | | | | |
| annotation | documentation Kat_Geschlecht | | | | | | | | | | | | | | | |
| source | <pre><simpleType name="enum_0070"> <annotation> <documentation>Kat_Geschlecht</documentation> </annotation> <restriction base="xs:string"> <enumeration value="0070001"> <annotation> <documentation>weiblich</documentation> </annotation> </enumeration> <enumeration value="0070002"> <annotation> <documentation>männlich</documentation> </annotation> </enumeration> <enumeration value="0070003"> <documentation></documentation> </enumeration> </restriction> </simpleType></pre> | | | | | | | | | | | | | | | |

| | |
|--|---|
| | <pre> <annotation> <documentation>divers</documentation> </annotation> </enumeration> <enumeration value="0070042"> <annotation> <documentation>unbestimmt</documentation> </annotation> </enumeration> </restriction> </simpleType> </pre> |
|--|---|

simpleType enum_0071

| | | | |
|------------|---|---------|---|
| namespace | http://xml.ir-d.de/irdsa | | |
| type | restriction of string | | |
| properties | base xs:string | | |
| facets | Kind | Value | Annotation |
| | enumeration | 0071001 | documentation Implantat |
| | enumeration | 0071002 | documentation Explantat |
| | enumeration | 0071003 | documentation Degeneriertes/defektes Produkt, das funktionslos im Körper verbleibt |
| annotation | documentation Kat_ArtikelArtFunktion | | |
| source | <pre> <simpleType name="enum_0071"> <annotation> <documentation>Kat_ArtikelArtFunktion</documentation> </annotation> <restriction base="xs:string"> <enumeration value="0071001"> <annotation> <documentation>Implantat</documentation> </annotation> </enumeration> <enumeration value="0071002"> <annotation> <documentation>Explantat</documentation> </annotation> </enumeration> <enumeration value="0071003"> <annotation> <documentation>Degeneriertes/defektes Produkt, das funktionslos im Körper verbleibt</documentation> </annotation> </enumeration> </restriction> </simpleType> </pre> | | |

simpleType enum_0075

| | |
|-----------|------------------------------|
| namespace | http://xml.ir-d.de/irdsa |
| type | restriction of string |

| properties | base xs:string | | | | | | | | | | | | |
|-------------|---|----------------------------|-------|------------|-------------|---------|--------------------------|-------------|---------|----------------------------|-------------|---------|--------------------------|
| facets | <table border="1"> <thead> <tr> <th>Kind</th> <th>Value</th> <th>Annotation</th> </tr> </thead> <tbody> <tr> <td>enumeration</td> <td>0075001</td> <td>documentation elektiv</td> </tr> <tr> <td>enumeration</td> <td>0075002</td> <td>documentation dringlich</td> </tr> <tr> <td>enumeration</td> <td>0075003</td> <td>documentation Notfall</td> </tr> </tbody> </table> | Kind | Value | Annotation | enumeration | 0075001 | documentation elektiv | enumeration | 0075002 | documentation dringlich | enumeration | 0075003 | documentation Notfall |
| Kind | Value | Annotation | | | | | | | | | | | |
| enumeration | 0075001 | documentation elektiv | | | | | | | | | | | |
| enumeration | 0075002 | documentation dringlich | | | | | | | | | | | |
| enumeration | 0075003 | documentation Notfall | | | | | | | | | | | |
| annotation | documentation Kat_Dringlichkeit | | | | | | | | | | | | |
| source | <pre> <simpleType name="enum_0075"> <annotation> <documentation>Kat_Dringlichkeit</documentation> </annotation> <restriction base="xs:string"> <enumeration value="0075001"> <annotation> <documentation>elektiv</documentation> </annotation> </enumeration> <enumeration value="0075002"> <annotation> <documentation>dringlich</documentation> </annotation> </enumeration> <enumeration value="0075003"> <annotation> <documentation>Notfall</documentation> </annotation> </enumeration> </restriction> </simpleType> </pre> | | | | | | | | | | | | |

simpleType enum_0076

| namespace | http://xml.ir-d.de/irdsa | | | | | | | | | | | | | | | |
|-------------|--|---|-------|------------|-------------|---------|--------------------------|-------------|---------|----------------------------|-------------|---------|--------------------------|-------------|---------|---|
| type | restriction of string | | | | | | | | | | | | | | | |
| properties | base xs:string | | | | | | | | | | | | | | | |
| facets | <table border="1"> <thead> <tr> <th>Kind</th> <th>Value</th> <th>Annotation</th> </tr> </thead> <tbody> <tr> <td>enumeration</td> <td>0076001</td> <td>documentation elektiv</td> </tr> <tr> <td>enumeration</td> <td>0076002</td> <td>documentation dringlich</td> </tr> <tr> <td>enumeration</td> <td>0076003</td> <td>documentation Notfall</td> </tr> <tr> <td>enumeration</td> <td>0076004</td> <td>documentation Notfall (Reanimation / ultima ratio)</td> </tr> </tbody> </table> | Kind | Value | Annotation | enumeration | 0076001 | documentation elektiv | enumeration | 0076002 | documentation dringlich | enumeration | 0076003 | documentation Notfall | enumeration | 0076004 | documentation Notfall (Reanimation / ultima ratio) |
| Kind | Value | Annotation | | | | | | | | | | | | | | |
| enumeration | 0076001 | documentation elektiv | | | | | | | | | | | | | | |
| enumeration | 0076002 | documentation dringlich | | | | | | | | | | | | | | |
| enumeration | 0076003 | documentation Notfall | | | | | | | | | | | | | | |
| enumeration | 0076004 | documentation Notfall (Reanimation / ultima ratio) | | | | | | | | | | | | | | |
| annotation | documentation Kat_Dringlichkeit_Reanimation | | | | | | | | | | | | | | | |
| source | <pre> <simpleType name="enum_0076"> <annotation> <documentation>Kat_Dringlichkeit_Reanimation</documentation> </annotation> <restriction base="xs:string"> <enumeration value="0076001"> <annotation> <documentation>elektiv</documentation> </annotation> </enumeration> </restriction> </simpleType> </pre> | | | | | | | | | | | | | | | |

| | |
|--|--|
| | <pre> </annotation> </enumeration> <enumeration value="0076002"> <annotation> <documentation>dringlich</documentation> </annotation> </enumeration> <enumeration value="0076003"> <annotation> <documentation>Notfall</documentation> </annotation> </enumeration> <enumeration value="0076004"> <annotation> <documentation>Notfall (Reanimation / ultima ratio)</documentation> </annotation> </enumeration> </restriction> </simpleType> </pre> |
|--|--|

simpleType enum_0080

| | | | |
|------------|---|---------|--|
| namespace | http://xml.ir-d.de/irdsa | | |
| type | restriction of string | | |
| properties | base xs:string | | |
| facets | Kind | Value | Annotation |
| | enumeration | 0080001 | documentation Endoprothese Hüfte/Knie |
| | enumeration | 0080002 | documentation Brustimplantat |
| | enumeration | 0080003 | documentation Aortenklappenprothese |
| annotation | documentation Kat_Implantattyp | | |
| source | <pre> <simpleType name="enum_0080"> <annotation> <documentation>Kat_Implantattyp</documentation> </annotation> <restriction base="xs:string"> <enumeration value="0080001"> <annotation> <documentation>Endoprothese Hüfte/Knie</documentation> </annotation> </enumeration> <enumeration value="0080002"> <annotation> <documentation>Brustimplantat</documentation> </annotation> </enumeration> <enumeration value="0080003"> <annotation> <documentation>Aortenklappenprothese</documentation> </annotation> </enumeration> </restriction> </simpleType> </pre> | | |

simpleType enum_0100

| | | | |
|------------|--|---------|--|
| namespace | http://xml.ir-d.de/irdsa | | |
| type | restriction of string | | |
| properties | base xs:string | | |
| facets | Kind | Value | Annotation |
| | enumeration | 0100001 | documentation Primäreingriff |
| | enumeration | 0100002 | documentation Austausch Expander gegen dauerhaftes Brustimplantat |
| | enumeration | 0100003 | documentation Revision |
| | enumeration | 0100004 | documentation Nur Explantation |
| annotation | documentation Kat BI_ArtEingriff | | |
| source | <pre> <simpleType name="enum_0100"> <annotation> <documentation>Kat BI_ArtEingriff</documentation> </annotation> <restriction base="xs:string"> <enumeration value="0100001"> <annotation> <documentation>Primäreingriff</documentation> </annotation> </enumeration> <enumeration value="0100002"> <annotation> <documentation>Austausch Expander gegen dauerhaftes Brustimplantat</documentation> </annotation> </enumeration> <enumeration value="0100003"> <annotation> <documentation>Revision</documentation> </annotation> </enumeration> <enumeration value="0100004"> <annotation> <documentation>Nur Explantation</documentation> </annotation> </enumeration> </restriction> </simpleType> </pre> | | |

simpleType enum_0102

| | | | |
|------------|------------------------------|---------|---|
| namespace | http://xml.ir-d.de/irdsa | | |
| type | restriction of string | | |
| properties | base xs:string | | |
| facets | Kind | Value | Annotation |
| | enumeration | 0102001 | documentation kosmetische Augmentation |
| | enumeration | 0102002 | documentation |

| | | |
|------------|--|--|
| | enumeration 0102003 enumeration 0102004 | Rekonstruktion, benigne documentation Rekonstruktion nach Mastektomie aufgrund eines Karzinoms documentation Rekonstruktion nach risikoreduzierender Mastektomie |
| annotation | documentation Kat_BI_GrundPrimaereingriff | |
| source | <pre> <simpleType name="enum_0102"> <annotation> <documentation>Kat_BI_GrundPrimaereingriff</documentation> </annotation> <restriction base="xs:string"> <enumeration value="0102001"> <annotation> <documentation>kosmetische Augmentation</documentation> </annotation> </enumeration> <enumeration value="0102002"> <annotation> <documentation>Rekonstruktion, benigne</documentation> </annotation> </enumeration> <enumeration value="0102003"> <annotation> <documentation>Rekonstruktion nach Mastektomie aufgrund eines Karzinoms</documentation> </annotation> </enumeration> <enumeration value="0102004"> <annotation> <documentation>Rekonstruktion nach risikoreduzierender Mastektomie</documentation> </annotation> </enumeration> </restriction> </simpleType> </pre> | |

simpleType enum_0103

| | | | |
|------------|------------------------------|-----------|---|
| namespace | http://xml.ir-d.de/irdsa | | |
| type | restriction of string | | |
| properties | base | xs:string | |
| facets | Kind | Value | Annotation |
| | enumeration | 0103001 | documentation simultane Lappendeckung |
| | enumeration | 0103002 | documentation simultane Eigenfetttransplantation |
| | enumeration | 0103003 | documentation simultane Mastopexie |
| | enumeration | 0103005 | documentation simultane Mastektomie, Ablatio / hautsparend |
| | enumeration | 0103006 | documentation simultane Mastektomie, nippelerhaltend |
| | enumeration | 0103007 | documentation Axilla-Dissektion |
| | enumeration | 0103008 | documentation Drainage |

| | |
|------------|---|
| annotation | documentation Kat_BI_OperationsdetailPrimaereingriff |
| source | <pre> <simpleType name="enum_0103"> <annotation> <documentation>Kat_BI_OperationsdetailPrimaereingriff</documentation> </annotation> <restriction base="xs:string"> <enumeration value="0103001"> <annotation> <documentation>simultane Lappendeckung</documentation> </annotation> </enumeration> <enumeration value="0103002"> <annotation> <documentation>simultane Eigenfetttransplantation</documentation> </annotation> </enumeration> <enumeration value="0103003"> <annotation> <documentation>simultane Mastopexie</documentation> </annotation> </enumeration> <enumeration value="0103005"> <annotation> <documentation>simultane Mastektomie, Ablatio / hautsparend</documentation> </annotation> </enumeration> <enumeration value="0103006"> <annotation> <documentation>simultane Mastektomie, nippelerhaltend</documentation> </annotation> </enumeration> <enumeration value="0103007"> <annotation> <documentation>Axilla-Dissektion</documentation> </annotation> </enumeration> <enumeration value="0103008"> <annotation> <documentation>Drainage</documentation> </annotation> </enumeration> </restriction> </simpleType> </pre> |

simpleType enum_0104

| | | | |
|------------|--|---------|--|
| namespace | http://xml.ir-d.de/irdsa | | |
| type | restriction of string | | |
| properties | base xs:string | | |
| facets | Kind | Value | Annotation |
| | enumeration | 0104001 | documentation Austausch Expander gegen dauerhaftes Brustimplantat |
| annotation | documentation Kat_BI_GrundAustausch | | |

| | |
|--------|---|
| source | <pre> <simpleType name="enum_0104"> <annotation> <documentation>Kat_BI_GrundAustausch</documentation> </annotation> <restriction base="xs:string"> <enumeration value="0104001"> <annotation> <documentation>Austausch Expander gegen dauerhaftes Brustimplantat</documentation> </annotation> </enumeration> </restriction> </simpleType> </pre> |
|--------|---|

simpleType enum_0105

| namespace | http://xml.ir-d.de/irdsa | | | | | | | | | | | | | | | | | | | | | | | | |
|-------------|---|---|-------|------------|-------------|---------|--|-------------|---------|---|-------------|---------|---------------------------------------|-------------|---------|---------------------------|-------------|---------|--|-------------|---------|--|-------------|---------|----------------------------|
| type | restriction of string | | | | | | | | | | | | | | | | | | | | | | | | |
| properties | base xs:string | | | | | | | | | | | | | | | | | | | | | | | | |
| facets | <table border="1"> <thead> <tr> <th>Kind</th> <th>Value</th> <th>Annotation</th> </tr> </thead> <tbody> <tr> <td>enumeration</td> <td>0105001</td> <td>documentation simultane Lappendeckung</td> </tr> <tr> <td>enumeration</td> <td>0105002</td> <td>documentation simultane Eigenfetttransplantation</td> </tr> <tr> <td>enumeration</td> <td>0105003</td> <td>documentation simultane Mastopexie</td> </tr> <tr> <td>enumeration</td> <td>0105008</td> <td>documentation Drainage</td> </tr> <tr> <td>enumeration</td> <td>0105009</td> <td>documentation Kapsulektomie, komplett</td> </tr> <tr> <td>enumeration</td> <td>0105010</td> <td>documentation Kapsulektomie, partiell</td> </tr> <tr> <td>enumeration</td> <td>0105011</td> <td>documentation Neopocket</td> </tr> </tbody> </table> | Kind | Value | Annotation | enumeration | 0105001 | documentation simultane Lappendeckung | enumeration | 0105002 | documentation simultane Eigenfetttransplantation | enumeration | 0105003 | documentation simultane Mastopexie | enumeration | 0105008 | documentation Drainage | enumeration | 0105009 | documentation Kapsulektomie, komplett | enumeration | 0105010 | documentation Kapsulektomie, partiell | enumeration | 0105011 | documentation Neopocket |
| Kind | Value | Annotation | | | | | | | | | | | | | | | | | | | | | | | |
| enumeration | 0105001 | documentation simultane Lappendeckung | | | | | | | | | | | | | | | | | | | | | | | |
| enumeration | 0105002 | documentation simultane Eigenfetttransplantation | | | | | | | | | | | | | | | | | | | | | | | |
| enumeration | 0105003 | documentation simultane Mastopexie | | | | | | | | | | | | | | | | | | | | | | | |
| enumeration | 0105008 | documentation Drainage | | | | | | | | | | | | | | | | | | | | | | | |
| enumeration | 0105009 | documentation Kapsulektomie, komplett | | | | | | | | | | | | | | | | | | | | | | | |
| enumeration | 0105010 | documentation Kapsulektomie, partiell | | | | | | | | | | | | | | | | | | | | | | | |
| enumeration | 0105011 | documentation Neopocket | | | | | | | | | | | | | | | | | | | | | | | |
| annotation | documentation Kat_BI_OperationsdetailAustausch | | | | | | | | | | | | | | | | | | | | | | | | |
| source | <pre> <simpleType name="enum_0105"> <annotation> <documentation>Kat_BI_OperationsdetailAustausch</documentation> </annotation> <restriction base="xs:string"> <enumeration value="0105001"> <annotation> <documentation>simultane Lappendeckung</documentation> </annotation> </enumeration> <enumeration value="0105002"> <annotation> <documentation>simultane Eigenfetttransplantation</documentation> </annotation> </enumeration> <enumeration value="0105003"> <annotation> <documentation>simultane Mastopexie</documentation> </annotation> </enumeration> <enumeration value="0105008"> </pre> | | | | | | | | | | | | | | | | | | | | | | | | |

| | |
|--|--|
| | <pre> <annotation> <documentation>Drainage</documentation> </annotation> </enumeration> <enumeration value="0105009"> <annotation> <documentation>Kapsulektomie, komplett</documentation> </annotation> </enumeration> <enumeration value="0105010"> <annotation> <documentation>Kapsulektomie, partiell</documentation> </annotation> </enumeration> <enumeration value="0105011"> <annotation> <documentation>Neopocket</documentation> </annotation> </enumeration> </restriction> </simpleType> </pre> |
|--|--|

simpleType enum_0106

| | | | |
|------------|--|---------|----------------------------------|
| namespace | http://xml.ir-d.de/irdsa | | |
| type | restriction of string | | |
| properties | base xs:string | | |
| facets | Kind | Value | Annotation |
| | enumeration | 0106001 | documentation Patientenwunsch |
| | enumeration | 0106002 | documentation asymptomatisch |
| | enumeration | 0106003 | documentation Komplikation |
| annotation | documentation Kat_BI_GrundRevisionExplantation | | |
| source | <pre> <simpleType name="enum_0106"> <annotation> <documentation>Kat_BI_GrundRevisionExplantation</documentation> </annotation> <restriction base="xs:string"> <enumeration value="0106001"> <annotation> <documentation>Patientenwunsch</documentation> </annotation> </enumeration> <enumeration value="0106002"> <annotation> <documentation>asymptomatisch</documentation> </annotation> </enumeration> <enumeration value="0106003"> <annotation> <documentation>Komplikation</documentation> </annotation> </enumeration> </restriction> </pre> | | |

| | |
|--|----------------------------------|
| | <code></simpleType></code> |
|--|----------------------------------|

simpleType enum_0107

| namespace | http://xml.ir-d.de/irdsa | | | | | | | | | | | | | | | | | | | | | | | | | | | | | | | | | |
|-------------|---|---|-------|------------|-------------|---------|--|-------------|---------|---|-------------|---------|---------------------------------------|-------------|---------|---|-------------|---------|---|-------------|---------|------------------------------------|-------------|---------|---------------------------|-------------|---------|--|-------------|---------|--|-------------|---------|----------------------------|
| type | restriction of string | | | | | | | | | | | | | | | | | | | | | | | | | | | | | | | | | |
| properties | base xs:string | | | | | | | | | | | | | | | | | | | | | | | | | | | | | | | | | |
| facets | <table><thead><tr><th>Kind</th><th>Value</th><th>Annotation</th></tr></thead><tbody><tr><td>enumeration</td><td>0107001</td><td>documentation simultane Lappendeckung</td></tr><tr><td>enumeration</td><td>0107002</td><td>documentation simultane Eigenfetttransplantation</td></tr><tr><td>enumeration</td><td>0107003</td><td>documentation simultane Mastopexie</td></tr><tr><td>enumeration</td><td>0107005</td><td>documentation simultane Mastektomie, Ablatio / hautsparend</td></tr><tr><td>enumeration</td><td>0107006</td><td>documentation simultane Mastektomie, nippelerhaltend</td></tr><tr><td>enumeration</td><td>0107007</td><td>documentation Axilla-Dissektion</td></tr><tr><td>enumeration</td><td>0107008</td><td>documentation Drainage</td></tr><tr><td>enumeration</td><td>0107009</td><td>documentation Kapsulektomie, komplett</td></tr><tr><td>enumeration</td><td>0107010</td><td>documentation Kapsulektomie, partiell</td></tr><tr><td>enumeration</td><td>0107011</td><td>documentation Neopocket</td></tr></tbody></table> | Kind | Value | Annotation | enumeration | 0107001 | documentation simultane Lappendeckung | enumeration | 0107002 | documentation simultane Eigenfetttransplantation | enumeration | 0107003 | documentation simultane Mastopexie | enumeration | 0107005 | documentation simultane Mastektomie, Ablatio / hautsparend | enumeration | 0107006 | documentation simultane Mastektomie, nippelerhaltend | enumeration | 0107007 | documentation Axilla-Dissektion | enumeration | 0107008 | documentation Drainage | enumeration | 0107009 | documentation Kapsulektomie, komplett | enumeration | 0107010 | documentation Kapsulektomie, partiell | enumeration | 0107011 | documentation Neopocket |
| Kind | Value | Annotation | | | | | | | | | | | | | | | | | | | | | | | | | | | | | | | | |
| enumeration | 0107001 | documentation simultane Lappendeckung | | | | | | | | | | | | | | | | | | | | | | | | | | | | | | | | |
| enumeration | 0107002 | documentation simultane Eigenfetttransplantation | | | | | | | | | | | | | | | | | | | | | | | | | | | | | | | | |
| enumeration | 0107003 | documentation simultane Mastopexie | | | | | | | | | | | | | | | | | | | | | | | | | | | | | | | | |
| enumeration | 0107005 | documentation simultane Mastektomie, Ablatio / hautsparend | | | | | | | | | | | | | | | | | | | | | | | | | | | | | | | | |
| enumeration | 0107006 | documentation simultane Mastektomie, nippelerhaltend | | | | | | | | | | | | | | | | | | | | | | | | | | | | | | | | |
| enumeration | 0107007 | documentation Axilla-Dissektion | | | | | | | | | | | | | | | | | | | | | | | | | | | | | | | | |
| enumeration | 0107008 | documentation Drainage | | | | | | | | | | | | | | | | | | | | | | | | | | | | | | | | |
| enumeration | 0107009 | documentation Kapsulektomie, komplett | | | | | | | | | | | | | | | | | | | | | | | | | | | | | | | | |
| enumeration | 0107010 | documentation Kapsulektomie, partiell | | | | | | | | | | | | | | | | | | | | | | | | | | | | | | | | |
| enumeration | 0107011 | documentation Neopocket | | | | | | | | | | | | | | | | | | | | | | | | | | | | | | | | |
| annotation | documentation Kat_BI_OperationsdetailRevision | | | | | | | | | | | | | | | | | | | | | | | | | | | | | | | | | |
| source | <pre><simpleType name="enum_0107"> <annotation> <documentation>Kat_BI_OperationsdetailRevision</documentation> </annotation> <restriction base="xs:string"> <enumeration value="0107001"> <annotation> <documentation>simultane Lappendeckung</documentation> </annotation> </enumeration> <enumeration value="0107002"> <annotation> <documentation>simultane Eigenfetttransplantation</documentation> </annotation> </enumeration> <enumeration value="0107003"> <annotation> <documentation>simultane Mastopexie</documentation> </annotation> </enumeration> <enumeration value="0107005"> <annotation> <documentation>simultane Mastektomie, Ablatio / hautsparend</documentation> </annotation> </enumeration> <enumeration value="0107006"> <annotation></pre> | | | | | | | | | | | | | | | | | | | | | | | | | | | | | | | | | |

| | |
|--|--|
| | <pre> <documentation>simultane Mastektomie, nippelerhaltend</documentation> </annotation> </enumeration> <enumeration value="0107007"> <annotation> <documentation>Axilla-Dissektion</documentation> </annotation> </enumeration> <enumeration value="0107008"> <annotation> <documentation>Drainage</documentation> </annotation> </enumeration> <enumeration value="0107009"> <annotation> <documentation>Kapsulektomie, komplett</documentation> </annotation> </enumeration> <enumeration value="0107010"> <annotation> <documentation>Kapsulektomie, partiell</documentation> </annotation> </enumeration> <enumeration value="0107011"> <annotation> <documentation>Neopocket</documentation> </annotation> </enumeration> </restriction> </simpleType> </pre> |
|--|--|

simpleType enum_0110

| namespace | http://xml.ir-d.de/irdsa | | | | | | |
|-------------|---|------------------------------|-------|------------|-------------|---------|------------------------------|
| type | restriction of string | | | | | | |
| properties | base xs:string | | | | | | |
| facets | <table border="1"> <thead> <tr> <th>Kind</th> <th>Value</th> <th>Annotation</th> </tr> </thead> <tbody> <tr> <td>enumeration</td> <td>0110001</td> <td>documentation Bestrahlung</td> </tr> </tbody> </table> | Kind | Value | Annotation | enumeration | 0110001 | documentation Bestrahlung |
| Kind | Value | Annotation | | | | | |
| enumeration | 0110001 | documentation Bestrahlung | | | | | |
| annotation | documentation Kat_BI_VorbehandlungLokal | | | | | | |
| source | <pre> <simpleType name="enum_0110"> <annotation> <documentation>Kat_BI_VorbehandlungLokal</documentation> </annotation> <restriction base="xs:string"> <enumeration value="0110001"> <annotation> <documentation>Bestrahlung</documentation> </annotation> </enumeration> </restriction> </simpleType> </pre> | | | | | | |

simpleType enum_0111

| | | | |
|------------|---|---------|--|
| namespace | http://xml.ir-d.de/irdsa | | |
| type | restriction of string | | |
| properties | base xs:string | | |
| facets | Kind | Value | Annotation |
| | enumeration | 0111001 | documentation nein |
| | enumeration | 0111002 | documentation Lipofilling |
| | enumeration | 0111003 | documentation Eigengewebsrekonstruktion |
| annotation | documentation Kat_BI_Verfahrenswechsel | | |
| source | <pre> <simpleType name="enum_0111"> <annotation> <documentation>Kat_BI_Verfahrenswechsel</documentation> </annotation> <restriction base="xs:string"> <enumeration value="0111001"> <annotation> <documentation>nein</documentation> </annotation> </enumeration> <enumeration value="0111002"> <annotation> <documentation>Lipofilling</documentation> </annotation> </enumeration> <enumeration value="0111003"> <annotation> <documentation>Eigengewebsrekonstruktion</documentation> </annotation> </enumeration> </restriction> </simpleType> </pre> | | |

simpleType enum_0112

| | | | |
|------------|------------------------------|---------|---|
| namespace | http://xml.ir-d.de/irdsa | | |
| type | restriction of string | | |
| properties | base xs:string | | |
| facets | Kind | Value | Annotation |
| | enumeration | 0112001 | documentation subglandulär / epipektoral |
| | enumeration | 0112002 | documentation subpektoral |
| | enumeration | 0112003 | documentation subfaszial |
| | enumeration | 0112004 | documentation sub-flap |
| | enumeration | 0112005 | documentation subkutan |
| | enumeration | 0112006 | documentation dual plane |
| | enumeration | 0112042 | documentation andere |

| | |
|------------|--|
| annotation | documentation Kat_BI_LageImplantat |
| source | <pre> <simpleType name="enum_0112"> <annotation> <documentation>Kat_BI_LageImplantat</documentation> </annotation> <restriction base="xs:string"> <enumeration value="0112001"> <annotation> <documentation>subglandulär / epipektoral</documentation> </annotation> </enumeration> <enumeration value="0112002"> <annotation> <documentation>subpektoral</documentation> </annotation> </enumeration> <enumeration value="0112003"> <annotation> <documentation>subfaszial</documentation> </annotation> </enumeration> <enumeration value="0112004"> <annotation> <documentation>sub-flap</documentation> </annotation> </enumeration> <enumeration value="0112005"> <annotation> <documentation>subkutan</documentation> </annotation> </enumeration> <enumeration value="0112006"> <annotation> <documentation>dual plane</documentation> </annotation> </enumeration> <enumeration value="0112042"> <annotation> <documentation>andere</documentation> </annotation> </enumeration> </restriction> </simpleType> </pre> |

simpleType enum_0113

| | | | |
|------------|---|---------|--|
| namespace | http://xml.ir-d.de/irdsa | | |
| type | restriction of string | | |
| properties | base xs:string | | |
| facets | Kind | Value | Annotation |
| | enumeration | 0113001 | documentation Chemotherapie innerhalb der letzten drei Monate |
| annotation | documentation Kat_BI_VorbehandlungSystemisch | | |
| source | <simpleType name="enum_0113"> | | |

| | |
|--|--|
| | <pre> <annotation> <documentation>Kat_BI_VorbehandlungSystemisch</documentation> </annotation> <restriction base="xs:string"> <enumeration value="0113001"> <annotation> <documentation>Chemotherapie innerhalb der letzten drei Monate</documentation> </annotation> </enumeration> </restriction> </simpleType> </pre> |
|--|--|

simpleType enum_0114

| | | | |
|------------|--|---------|----------------------------------|
| namespace | http://xml.ir-d.de/irdsa | | |
| type | restriction of string | | |
| properties | base xs:string | | |
| facets | Kind | Value | Annotation |
| | enumeration | 0114001 | documentation vollständig |
| | enumeration | 0114002 | documentation nein |
| | enumeration | 0114003 | documentation teilweise |
| | enumeration | 0114004 | documentation nicht vorhanden |
| annotation | documentation Kat_BI_EntfernungADMNetz | | |
| source | <pre> <simpleType name="enum_0114"> <annotation> <documentation>Kat_BI_EntfernungADMNetz</documentation> </annotation> <restriction base="xs:string"> <enumeration value="0114001"> <annotation> <documentation>vollständig</documentation> </annotation> </enumeration> <enumeration value="0114002"> <annotation> <documentation>nein</documentation> </annotation> </enumeration> <enumeration value="0114003"> <annotation> <documentation>teilweise</documentation> </annotation> </enumeration> <enumeration value="0114004"> <annotation> <documentation>nicht vorhanden</documentation> </annotation> </enumeration> </restriction> </simpleType> </pre> | | |

simpleType enum 0116

| | | | |
|------------|---|---------|--|
| namespace | http://xml.ir-d.de/irdsa | | |
| type | restriction of string | | |
| properties | base xs:string | | |
| facets | Kind | Value | Annotation |
| | enumeration | 0116001 | documentation Spülung, antibiotisch |
| | enumeration | 0116002 | documentation Spülung, antiseptisch |
| | enumeration | 0116003 | documentation Spülung, wirkstofffrei |
| | enumeration | 0116004 | documentation Spülung, andere |
| | enumeration | 0116005 | documentation prä-/perioperative Antibiotika |
| | enumeration | 0116006 | documentation postoperative Antibiotika |
| | enumeration | 0116007 | documentation Handschuhwechsel vor Implantation |
| | enumeration | 0116008 | documentation Implantationshilfe |
| annotation | documentation Kat_BI_Operationsmassnahme | | |
| source | <pre> <simpleType name="enum_0116"> <annotation> <documentation>Kat_BI_Operationsmassnahme</documentation> </annotation> <restriction base="xs:string"> <enumeration value="0116001"> <annotation> <documentation>Spülung, antibiotisch</documentation> </annotation> </enumeration> <enumeration value="0116002"> <annotation> <documentation>Spülung, antiseptisch</documentation> </annotation> </enumeration> <enumeration value="0116003"> <annotation> <documentation>Spülung, wirkstofffrei</documentation> </annotation> </enumeration> <enumeration value="0116004"> <annotation> <documentation>Spülung, andere</documentation> </annotation> </enumeration> <enumeration value="0116005"> <annotation> <documentation>prä-/perioperative Antibiotika</documentation> </annotation> </enumeration> <enumeration value="0116006"> <annotation> <documentation>postoperative Antibiotika</documentation> </annotation> </enumeration> </restriction> </simpleType> </pre> | | |

| | |
|--|---|
| | <pre> </annotation> </enumeration> <enumeration value="0116007"> <annotation> <documentation>Handschuhwechsel vor Implantation</documentation> </annotation> </enumeration> <enumeration value="0116008"> <annotation> <documentation>Implantationshilfe</documentation> </annotation> </enumeration> </restriction> </simpleType> </pre> |
|--|---|

simpleType enum_0118

| | | | |
|------------|---|---------|-----------------------------------|
| namespace | http://xml.lir-d.de/irdsa | | |
| type | restriction of string | | |
| properties | base xs:string | | |
| facets | Kind | Value | Annotation |
| | enumeration | 0118001 | documentation axillär |
| | enumeration | 0118002 | documentation periareolär |
| | enumeration | 0118003 | documentation inframammär |
| | enumeration | 0118004 | documentation Mastektomienarbe |
| | enumeration | 0118042 | documentation anderer |
| annotation | documentation Kat_BI_Operationszugang | | |
| source | <pre> <simpleType name="enum_0118"> <annotation> <documentation>Kat_BI_Operationszugang</documentation> </annotation> <restriction base="xs:string"> <enumeration value="0118001"> <annotation> <documentation>axillär</documentation> </annotation> </enumeration> <enumeration value="0118002"> <annotation> <documentation>periareolär</documentation> </annotation> </enumeration> <enumeration value="0118003"> <annotation> <documentation>inframammär</documentation> </annotation> </enumeration> <enumeration value="0118004"> <annotation> <documentation>Mastektomienarbe</documentation> </annotation> </enumeration> </restriction> </simpleType> </pre> | | |

| | |
|--|---|
| | <pre> </enumeration> <enumeration value="0118042"> <annotation> <documentation>anderer</documentation> </annotation> </enumeration> </restriction> </simpleType> </pre> |
|--|---|

simpleType enum_0120

| | | | |
|------------|--|---------|----------------------------------|
| namespace | http://xml.ir-d.de/irdsa | | |
| type | restriction of string | | |
| properties | base xs:string | | |
| facets | Kind | Value | Annotation |
| | enumeration | 0120001 | documentation Expander defekt |
| annotation | documentation Kat_BI_BefundAustausch | | |
| source | <pre> <simpleType name="enum_0120"> <annotation> <documentation>Kat_BI_BefundAustausch</documentation> </annotation> <restriction base="xs:string"> <enumeration value="0120001"> <annotation> <documentation>Expander defekt</documentation> </annotation> </enumeration> </restriction> </simpleType> </pre> | | |

simpleType enum_0121

| | | | |
|------------|------------------------------|---------|--|
| namespace | http://xml.ir-d.de/irdsa | | |
| type | restriction of string | | |
| properties | base xs:string | | |
| facets | Kind | Value | Annotation |
| | enumeration | 0121001 | documentation Infektion |
| | enumeration | 0121002 | documentation Serom |
| | enumeration | 0121003 | documentation Hämatom |
| | enumeration | 0121004 | documentation Kapsel fibrose |
| | enumeration | 0121005 | documentation Implantatruptur |
| | enumeration | 0121006 | documentation Fehlpositionierung/Rotation |
| | enumeration | 0121007 | documentation BIA-ALCL/-SCC, Verdacht |
| | enumeration | 0121008 | documentation BIA-ALCL/-SCC, pathologisch bestätigt |
| | enumeration | 0121009 | documentation |

| | |
|------------|---|
| | <p>enumeration 0121010 Brustschmerzen documentation Doppelkapsel</p> <p>enumeration 0121011 documentation Netz-/ADM-bedingte Komplikation, Non-Integration</p> <p>enumeration 0121012 documentation Netz-/ADM-bedingte Komplikation, andere</p> <p>enumeration 0121013 documentation Hautnekrose/exponiertes Implantat</p> <p>enumeration 0121014 documentation BII/ASIA (Brustimplantat assoziierte Symptome), Verdacht</p> <p>enumeration 0121015 documentation Lymphadenopathie</p> <p>enumeration 0121016 documentation Brustkrebs, neu aufgetreten/Rezidiv</p> |
| annotation | documentation Kat_BI_BefundKomplett |
| source | <pre> <simpleType name="enum_0121"> <annotation> <documentation>Kat_BI_BefundKomplett</documentation> </annotation> <restriction base="xs:string"> <enumeration value="0121001"> <annotation> <documentation>Infektion</documentation> </annotation> </enumeration> <enumeration value="0121002"> <annotation> <documentation>Serom</documentation> </annotation> </enumeration> <enumeration value="0121003"> <annotation> <documentation>Hämatom</documentation> </annotation> </enumeration> <enumeration value="0121004"> <annotation> <documentation>Kapsel fibrose</documentation> </annotation> </enumeration> <enumeration value="0121005"> <annotation> <documentation>Implantatruptur</documentation> </annotation> </enumeration> <enumeration value="0121006"> <annotation> <documentation>Fehlpositionierung/Rotation</documentation> </annotation> </enumeration> <enumeration value="0121007"> <annotation> <documentation>BIA-ALCL/-SCC, Verdacht</documentation> </annotation> </enumeration> <enumeration value="0121008"> <annotation> <documentation>BIA-ALCL/-SCC, pathologisch bestätigt</documentation> </annotation> </enumeration> </restriction> </simpleType> </pre> |

```

</annotation>
</enumeration>
<enumeration value="0121009">
  <annotation>
    <documentation>Brustschmerzen</documentation>
  </annotation>
</enumeration>
<enumeration value="0121010">
  <annotation>
    <documentation>Doppelkapsel</documentation>
  </annotation>
</enumeration>
<enumeration value="0121011">
  <annotation>
    <documentation>Netz-/ADM-bedingte Komplikation,
Non-Integration</documentation>
  </annotation>
</enumeration>
<enumeration value="0121012">
  <annotation>
    <documentation>Netz-/ADM-bedingte Komplikation, andere</documentation>
  </annotation>
</enumeration>
<enumeration value="0121013">
  <annotation>
    <documentation>Hautnekrose/exponiertes Implantat</documentation>
  </annotation>
</enumeration>
<enumeration value="0121014">
  <annotation>
    <documentation>BII/ASIA (Brustimplantat assoziierte Symptome),
Verdacht</documentation>
  </annotation>
</enumeration>
<enumeration value="0121015">
  <annotation>
    <documentation>Lymphadenopathie</documentation>
  </annotation>
</enumeration>
<enumeration value="0121016">
  <annotation>
    <documentation>Brustkrebs, neu aufgetreten/Rezidiv</documentation>
  </annotation>
</enumeration>
</restriction>
</simpleType>

```

simpleType enum_0122

| | | | |
|------------|------------------------------|---------|--|
| namespace | http://xml.ir-d.de/irdsa | | |
| type | restriction of string | | |
| properties | base xs:string | | |
| facets | Kind | Value | Annotation |
| | enumeration | 0122001 | documentation ja, ärztlich nachgewiesen |
| | enumeration | 0122002 | documentation nein |

| | |
|------------|---|
| | enumeration 0122042 documentation unbekannt |
| annotation | documentation Kat_BI_Autoimmunerkrankung |
| source | <pre> <simpleType name="enum_0122"> <annotation> <documentation>Kat_BI_Autoimmunerkrankung</documentation> </annotation> <restriction base="xs:string"> <enumeration value="0122001"> <annotation> <documentation>ja, ärztlich nachgewiesen</documentation> </annotation> </enumeration> <enumeration value="0122002"> <annotation> <documentation>nein</documentation> </annotation> </enumeration> <enumeration value="0122042"> <annotation> <documentation>unbekannt</documentation> </annotation> </enumeration> </restriction> </simpleType> </pre> |

simpleType enum_0123

| | | | |
|------------|---|---------|--|
| namespace | http://xml.ir-d.de/irdsa | | |
| type | restriction of string | | |
| properties | base xs:string | | |
| facets | Kind | Value | Annotation |
| | enumeration | 0123001 | documentation neu aufgetreten |
| | enumeration | 0123002 | documentation verschlechtert |
| | enumeration | 0123003 | documentation keine Veränderung |
| | enumeration | 0123004 | documentation nicht relevant, da Primäreingriff |
| | enumeration | 0123042 | documentation unbekannt |
| annotation | documentation Kat_BI_VerlaufAutoimmunerkrankung | | |
| source | <pre> <simpleType name="enum_0123"> <annotation> <documentation>Kat_BI_VerlaufAutoimmunerkrankung</documentation> </annotation> <restriction base="xs:string"> <enumeration value="0123001"> <annotation> <documentation>neu aufgetreten</documentation> </annotation> </enumeration> <enumeration value="0123002"> <annotation> </pre> | | |

| | |
|--|---|
| | <pre> <documentation>verschlechtert</documentation> </annotation> </enumeration> <enumeration value="0123003"> <annotation> <documentation>keine Veränderung</documentation> </annotation> </enumeration> <enumeration value="0123004"> <annotation> <documentation>nicht relevant, da Primäreingriff</documentation> </annotation> </enumeration> <enumeration value="0123042"> <annotation> <documentation>unbekannt</documentation> </annotation> </enumeration> </restriction> </simpleType> </pre> |
|--|---|

simpleType enum_0124

| | | | |
|------------|---|---------|--|
| namespace | http://xml.ir-d.de/irdsa | | |
| type | restriction of string | | |
| properties | base xs:string | | |
| facets | Kind | Value | Annotation |
| | enumeration | 0124001 | documentation Salzlösung |
| | enumeration | 0124002 | documentation Silikongel |
| | enumeration | 0124003 | documentation Kombination Silikongel und Salzlösung |
| | enumeration | 0124042 | documentation sonstige |
| annotation | documentation Kat_BI_Fuellung | | |
| source | <pre> <simpleType name="enum_0124"> <annotation> <documentation>Kat_BI_Fuellung</documentation> </annotation> <restriction base="xs:string"> <enumeration value="0124001"> <annotation> <documentation>Salzlösung</documentation> </annotation> </enumeration> <enumeration value="0124002"> <annotation> <documentation>Silikongel</documentation> </annotation> </enumeration> <enumeration value="0124003"> <annotation> <documentation>Kombination Silikongel und Salzlösung</documentation> </annotation> </enumeration> </restriction> </simpleType> </pre> | | |

| | |
|--|---|
| | <pre> <enumeration value="0124042"> <annotation> <documentation>sonstige</documentation> </annotation> </enumeration> </restriction> </simpleType> </pre> |
|--|---|

simpleType enum_0126

| | | | |
|------------|---|---------|---|
| namespace | http://xml.ir-d.de/irdsa | | |
| type | restriction of string | | |
| properties | base xs:string | | |
| facets | Kind | Value | Annotation |
| | enumeration | 0126001 | documentation anatomisch (tropfenförmig) |
| | enumeration | 0126002 | documentation rund (punktsymmetrisch) |
| | enumeration | 0126042 | documentation sonstige |
| annotation | documentation Kat_BI_Form | | |
| source | <pre> <simpleType name="enum_0126"> <annotation> <documentation>Kat_BI_Form</documentation> </annotation> <restriction base="xs:string"> <enumeration value="0126001"> <annotation> <documentation>anatomisch (tropfenförmig)</documentation> </annotation> </enumeration> <enumeration value="0126002"> <annotation> <documentation>rund (punktsymmetrisch)</documentation> </annotation> </enumeration> <enumeration value="0126042"> <annotation> <documentation>sonstige</documentation> </annotation> </enumeration> </restriction> </simpleType> </pre> | | |

simpleType enum_0128

| | | | |
|------------|------------------------------|---------|------------------------------|
| namespace | http://xml.ir-d.de/irdsa | | |
| type | restriction of string | | |
| properties | base xs:string | | |
| facets | Kind | Value | Annotation |
| | enumeration | 0128001 | documentation glattwandig |
| | enumeration | 0128002 | documentation |

| | |
|------------|---|
| | enumeration 0128003 documentation beschichtet texturiert |
| annotation | documentation Kat_BI_Oberflaeche |
| source | <pre> <simpleType name="enum_0128"> <annotation> <documentation>Kat_BI_Oberflaeche</documentation> </annotation> <restriction base="xs:string"> <enumeration value="0128001"> <annotation> <documentation>glattwandig</documentation> </annotation> </enumeration> <enumeration value="0128002"> <annotation> <documentation>beschichtet</documentation> </annotation> </enumeration> <enumeration value="0128003"> <annotation> <documentation>texturiert</documentation> </annotation> </enumeration> </restriction> </simpleType> </pre> |

simpleType enum_0130

| | | | |
|------------|------------------------------|---------|--|
| namespace | http://xml.ir-d.de/irdsa | | |
| type | restriction of string | | |
| properties | base xs:string | | |
| facets | Kind | Value | Annotation |
| | enumeration | 0130001 | documentation Allergan |
| | enumeration | 0130002 | documentation Cereplas |
| | enumeration | 0130003 | documentation CUI (Cox Uphoff Implants) |
| | enumeration | 0130004 | documentation EMSI Biomedical |
| | enumeration | 0130005 | documentation Establishment labs |
| | enumeration | 0130006 | documentation Eurosilicone |
| | enumeration | 0130007 | documentation Nagor |
| | enumeration | 0130008 | documentation Groupe Sebbin |
| | enumeration | 0130009 | documentation Laboratoires Arion |
| | enumeration | 0130010 | documentation Mentor |
| | enumeration | 0130011 | documentation Pérouse Plastie SAS |
| | enumeration | 0130012 | documentation PIP M-Implants |
| | enumeration | 0130013 | documentation |

| | |
|------------|---|
| | <p>enumeration 0130014 Polytech Health & Aesthetics documentation Sillimed</p> <p>enumeration 0130015 documentation Surgitek</p> <p>enumeration 0130016 documentation G&G Biotechnology</p> <p>enumeration 0130017 documentation nicht belegter Wert</p> <p>enumeration 0130018 documentation nicht belegter Wert</p> <p>enumeration 0130019 documentation nicht belegter Wert</p> <p>enumeration 0130020 documentation nicht belegter Wert</p> <p>enumeration 0130021 documentation nicht belegter Wert</p> <p>enumeration 0130042 documentation sonstiger</p> |
| annotation | documentation Kat_BI_Hersteller |
| source | <pre> <simpleType name="enum_0130"> <annotation> <documentation>Kat_BI_Hersteller</documentation> </annotation> <restriction base="xs:string"> <enumeration value="0130001"> <annotation> <documentation>Allergan</documentation> </annotation> </enumeration> <enumeration value="0130002"> <annotation> <documentation>Cereplas</documentation> </annotation> </enumeration> <enumeration value="0130003"> <annotation> <documentation>CUI (Cox Uphoff Implants)</documentation> </annotation> </enumeration> <enumeration value="0130004"> <annotation> <documentation>EMSI Biomedical</documentation> </annotation> </enumeration> <enumeration value="0130005"> <annotation> <documentation>Establishment labs</documentation> </annotation> </enumeration> <enumeration value="0130006"> <annotation> <documentation>Eurosilicone</documentation> </annotation> </enumeration> <enumeration value="0130007"> <annotation> <documentation>Nagor</documentation> </annotation> </enumeration> </restriction> </simpleType> </pre> |

```
<enumeration value="0130008">
  <annotation>
    <documentation>Groupe Sebbin</documentation>
  </annotation>
</enumeration>
<enumeration value="0130009">
  <annotation>
    <documentation>Laboratoires Arion</documentation>
  </annotation>
</enumeration>
<enumeration value="0130010">
  <annotation>
    <documentation>Mentor</documentation>
  </annotation>
</enumeration>
<enumeration value="0130011">
  <annotation>
    <documentation>Pérouse Plastie SAS</documentation>
  </annotation>
</enumeration>
<enumeration value="0130012">
  <annotation>
    <documentation>PIP M-Implants</documentation>
  </annotation>
</enumeration>
<enumeration value="0130013">
  <annotation>
    <documentation>Polytech Health & Aesthetics</documentation>
  </annotation>
</enumeration>
<enumeration value="0130014">
  <annotation>
    <documentation>Silimed</documentation>
  </annotation>
</enumeration>
<enumeration value="0130015">
  <annotation>
    <documentation>Surgitek</documentation>
  </annotation>
</enumeration>
<enumeration value="0130016">
  <annotation>
    <documentation>G&G Biotechnology</documentation>
  </annotation>
</enumeration>
<enumeration value="0130017">
  <annotation>
    <documentation>nicht belegter Wert</documentation>
  </annotation>
</enumeration>
<enumeration value="0130018">
  <annotation>
    <documentation>nicht belegter Wert</documentation>
  </annotation>
</enumeration>
<enumeration value="0130019">
  <annotation>
    <documentation>nicht belegter Wert</documentation>
  </annotation>
</enumeration>
```

| | |
|--|---|
| | <pre> </enumeration> <enumeration value="0130020"> <annotation> <documentation>nicht belegter Wert</documentation> </annotation> </enumeration> <enumeration value="0130021"> <annotation> <documentation>nicht belegter Wert</documentation> </annotation> </enumeration> <enumeration value="0130042"> <annotation> <documentation>sonstiger</documentation> </annotation> </enumeration> </restriction> </simpleType> </pre> |
|--|---|

simpleType **enum_0131**

| | | | |
|------------|---|---------|---|
| namespace | http://xml.ir-d.de/irdsa | | |
| type | restriction of string | | |
| properties | base xs:string | | |
| facets | Kind | Value | Annotation |
| | enumeration | 0131001 | documentation Allergan |
| | enumeration | 0131002 | documentation Establishment labs |
| | enumeration | 0131003 | documentation Eurosilicone |
| | enumeration | 0131004 | documentation Galatea |
| | enumeration | 0131005 | documentation Integra |
| | enumeration | 0131006 | documentation Lifecell |
| | enumeration | 0131007 | documentation MBP (Medical Biomaterial Products) |
| | enumeration | 0131008 | documentation Mentor |
| | enumeration | 0131009 | documentation Novus Scientific |
| | enumeration | 0131042 | documentation sonstiger |
| annotation | documentation Kat_BI_ZubehoerHersteller | | |
| source | <pre> <simpleType name="enum_0131"> <annotation> <documentation>Kat_BI_ZubehoerHersteller</documentation> </annotation> <restriction base="xs:string"> <enumeration value="0131001"> <annotation> <documentation>Allergan</documentation> </annotation> </enumeration> <enumeration value="0131002"> </pre> | | |

```

    <annotation>
      <documentation>Establishment labs</documentation>
    </annotation>
  </enumeration>
  <enumeration value="0131003">
    <annotation>
      <documentation>Eurosilicone</documentation>
    </annotation>
  </enumeration>
  <enumeration value="0131004">
    <annotation>
      <documentation>Galatea</documentation>
    </annotation>
  </enumeration>
  <enumeration value="0131005">
    <annotation>
      <documentation>Integra</documentation>
    </annotation>
  </enumeration>
  <enumeration value="0131006">
    <annotation>
      <documentation>Lifecell</documentation>
    </annotation>
  </enumeration>
  <enumeration value="0131007">
    <annotation>
      <documentation>MBP (Medical Biomaterial Products)</documentation>
    </annotation>
  </enumeration>
  <enumeration value="0131008">
    <annotation>
      <documentation>Mentor</documentation>
    </annotation>
  </enumeration>
  <enumeration value="0131009">
    <annotation>
      <documentation>Novus Scientific</documentation>
    </annotation>
  </enumeration>
  <enumeration value="0131042">
    <annotation>
      <documentation>sonstiger</documentation>
    </annotation>
  </enumeration>
</restriction>
</simpleType>

```

simpleType enum_0190

| | | | |
|------------|------------------------------|---------|---------------------------------|
| namespace | http://xml.ir-d.de/irdsa | | |
| type | restriction of string | | |
| properties | base xs:string | | |
| facets | Kind | Value | Annotation |
| | enumeration | 0190001 | documentation Brustimplantat |
| | enumeration | 0190003 | documentation Brustexpander |

| | |
|------------|---|
| annotation | documentation Kat_BI_Artikeltyp |
| source | <pre> <simpleType name="enum_0190"> <annotation> <documentation>Kat_BI_Artikeltyp</documentation> </annotation> <restriction base="xs:string"> <enumeration value="0190001"> <annotation> <documentation>Brustimplantat</documentation> </annotation> </enumeration> <enumeration value="0190003"> <annotation> <documentation>Brustexpander</documentation> </annotation> </enumeration> </restriction> </simpleType> </pre> |

simpleType enum_0191

| | | | |
|------------|--|---------|-----------------------|
| namespace | http://xml.ir-d.de/irdsa | | |
| type | restriction of string | | |
| properties | base xs:string | | |
| facets | Kind | Value | Annotation |
| | enumeration | 0191001 | documentation Netz |
| | enumeration | 0191002 | documentation ADM |
| annotation | documentation Kat_BI_ZubehoerTyp | | |
| source | <pre> <simpleType name="enum_0191"> <annotation> <documentation>Kat_BI_ZubehoerTyp</documentation> </annotation> <restriction base="xs:string"> <enumeration value="0191001"> <annotation> <documentation>Netz</documentation> </annotation> </enumeration> <enumeration value="0191002"> <annotation> <documentation>ADM</documentation> </annotation> </enumeration> </restriction> </simpleType> </pre> | | |

simpleType enum_0200

| | |
|-----------|------------------------------|
| namespace | http://xml.ir-d.de/irdsa |
| type | restriction of string |

| properties | base xs:string | | | | | | | | | |
|-------------|---|--------------------------------|-------|------------|-------------|---------|--------------------------|-------------|---------|--------------------------------|
| facets | <table border="1"> <thead> <tr> <th>Kind</th> <th>Value</th> <th>Annotation</th> </tr> </thead> <tbody> <tr> <td>enumeration</td> <td>0200001</td> <td>documentation Erst-OP</td> </tr> <tr> <td>enumeration</td> <td>0200002</td> <td>documentation Folgeeingriff</td> </tr> </tbody> </table> | Kind | Value | Annotation | enumeration | 0200001 | documentation Erst-OP | enumeration | 0200002 | documentation Folgeeingriff |
| Kind | Value | Annotation | | | | | | | | |
| enumeration | 0200001 | documentation Erst-OP | | | | | | | | |
| enumeration | 0200002 | documentation Folgeeingriff | | | | | | | | |
| annotation | documentation Kat_EP_ArtEingriff | | | | | | | | | |
| source | <pre><simpleType name="enum_0200"> <annotation> <documentation>Kat_EP_ArtEingriff</documentation> </annotation> <restriction base="xs:string"> <enumeration value="0200001"> <annotation> <documentation>Erst-OP</documentation> </annotation> </enumeration> <enumeration value="0200002"> <annotation> <documentation>Folgeeingriff</documentation> </annotation> </enumeration> </restriction> </simpleType></pre> | | | | | | | | | |

simpleType enum_0202

| namespace | http://xml.ir-d.de/irdsa | | | | | | | | | | | | | | | | | | | | | | | | | | | | | | | | | | | | | | | | | | | | | |
|-------------|--|--|-------|------------|-------------|---------|----------------------------|-------------|---------|--|-------------|---------|---------------------------------------|-------------|---------|---|-------------|---------|--|-------------|---------|---|-------------|---------|---|-------------|---------|---------------------------------|-------------|---------|---|-------------|---------|--|-------------|---------|--|-------------|---------|-----------------------|-------------|---------|--|-------------|---------|---------------|
| type | restriction of string | | | | | | | | | | | | | | | | | | | | | | | | | | | | | | | | | | | | | | | | | | | | | |
| properties | base xs:string | | | | | | | | | | | | | | | | | | | | | | | | | | | | | | | | | | | | | | | | | | | | | |
| facets | <table border="1"> <thead> <tr> <th>Kind</th> <th>Value</th> <th>Annotation</th> </tr> </thead> <tbody> <tr> <td>enumeration</td> <td>0202001</td> <td>documentation Lockerung</td> </tr> <tr> <td>enumeration</td> <td>0202002</td> <td>documentation Infektion, Verdacht auf</td> </tr> <tr> <td>enumeration</td> <td>0202003</td> <td>documentation Infektion, gesichert</td> </tr> <tr> <td>enumeration</td> <td>0202004</td> <td>documentation Luxation, Inlay aus der Pfanne</td> </tr> <tr> <td>enumeration</td> <td>0202005</td> <td>documentation Luxation, Kopf aus Pfanne/Inlay</td> </tr> <tr> <td>enumeration</td> <td>0202006</td> <td>documentation Periprothetische Fraktur</td> </tr> <tr> <td>enumeration</td> <td>0202007</td> <td>documentation Verschleiß des PE-Inlays</td> </tr> <tr> <td>enumeration</td> <td>0202008</td> <td>documentation Implantatbruch</td> </tr> <tr> <td>enumeration</td> <td>0202009</td> <td>documentation Implantatfehlage/Malalignent</td> </tr> <tr> <td>enumeration</td> <td>0202010</td> <td>documentation Osteolysen bei festem Implantat</td> </tr> <tr> <td>enumeration</td> <td>0202011</td> <td>documentation Progression der Grunderkrankung</td> </tr> <tr> <td>enumeration</td> <td>0202012</td> <td>documentation ARMD</td> </tr> <tr> <td>enumeration</td> <td>0202013</td> <td>documentation Verdacht auf allergische Reaktion</td> </tr> <tr> <td>enumeration</td> <td>0202021</td> <td>documentation</td> </tr> </tbody> </table> | Kind | Value | Annotation | enumeration | 0202001 | documentation Lockerung | enumeration | 0202002 | documentation Infektion, Verdacht auf | enumeration | 0202003 | documentation Infektion, gesichert | enumeration | 0202004 | documentation Luxation, Inlay aus der Pfanne | enumeration | 0202005 | documentation Luxation, Kopf aus Pfanne/Inlay | enumeration | 0202006 | documentation Periprothetische Fraktur | enumeration | 0202007 | documentation Verschleiß des PE-Inlays | enumeration | 0202008 | documentation Implantatbruch | enumeration | 0202009 | documentation Implantatfehlage/Malalignent | enumeration | 0202010 | documentation Osteolysen bei festem Implantat | enumeration | 0202011 | documentation Progression der Grunderkrankung | enumeration | 0202012 | documentation ARMD | enumeration | 0202013 | documentation Verdacht auf allergische Reaktion | enumeration | 0202021 | documentation |
| Kind | Value | Annotation | | | | | | | | | | | | | | | | | | | | | | | | | | | | | | | | | | | | | | | | | | | | |
| enumeration | 0202001 | documentation Lockerung | | | | | | | | | | | | | | | | | | | | | | | | | | | | | | | | | | | | | | | | | | | | |
| enumeration | 0202002 | documentation Infektion, Verdacht auf | | | | | | | | | | | | | | | | | | | | | | | | | | | | | | | | | | | | | | | | | | | | |
| enumeration | 0202003 | documentation Infektion, gesichert | | | | | | | | | | | | | | | | | | | | | | | | | | | | | | | | | | | | | | | | | | | | |
| enumeration | 0202004 | documentation Luxation, Inlay aus der Pfanne | | | | | | | | | | | | | | | | | | | | | | | | | | | | | | | | | | | | | | | | | | | | |
| enumeration | 0202005 | documentation Luxation, Kopf aus Pfanne/Inlay | | | | | | | | | | | | | | | | | | | | | | | | | | | | | | | | | | | | | | | | | | | | |
| enumeration | 0202006 | documentation Periprothetische Fraktur | | | | | | | | | | | | | | | | | | | | | | | | | | | | | | | | | | | | | | | | | | | | |
| enumeration | 0202007 | documentation Verschleiß des PE-Inlays | | | | | | | | | | | | | | | | | | | | | | | | | | | | | | | | | | | | | | | | | | | | |
| enumeration | 0202008 | documentation Implantatbruch | | | | | | | | | | | | | | | | | | | | | | | | | | | | | | | | | | | | | | | | | | | | |
| enumeration | 0202009 | documentation Implantatfehlage/Malalignent | | | | | | | | | | | | | | | | | | | | | | | | | | | | | | | | | | | | | | | | | | | | |
| enumeration | 0202010 | documentation Osteolysen bei festem Implantat | | | | | | | | | | | | | | | | | | | | | | | | | | | | | | | | | | | | | | | | | | | | |
| enumeration | 0202011 | documentation Progression der Grunderkrankung | | | | | | | | | | | | | | | | | | | | | | | | | | | | | | | | | | | | | | | | | | | | |
| enumeration | 0202012 | documentation ARMD | | | | | | | | | | | | | | | | | | | | | | | | | | | | | | | | | | | | | | | | | | | | |
| enumeration | 0202013 | documentation Verdacht auf allergische Reaktion | | | | | | | | | | | | | | | | | | | | | | | | | | | | | | | | | | | | | | | | | | | | |
| enumeration | 0202021 | documentation | | | | | | | | | | | | | | | | | | | | | | | | | | | | | | | | | | | | | | | | | | | | |

| | |
|------------|---|
| | enumeration 0202042 Zustand nach Prothesenentfernung documentation andere Gründe |
| annotation | documentation Kat_EP_GrundWechselHuefte |
| source | <pre> <simpleType name="enum_0202"> <annotation> <documentation>Kat_EP_GrundWechselHuefte</documentation> </annotation> <restriction base="xs:string"> <enumeration value="0202001"> <annotation> <documentation>Lockerung</documentation> </annotation> </enumeration> <enumeration value="0202002"> <annotation> <documentation>Infektion, Verdacht auf</documentation> </annotation> </enumeration> <enumeration value="0202003"> <annotation> <documentation>Infektion, gesichert</documentation> </annotation> </enumeration> <enumeration value="0202004"> <annotation> <documentation>Luxation, Inlay aus der Pfanne</documentation> </annotation> </enumeration> <enumeration value="0202005"> <annotation> <documentation>Luxation, Kopf aus Pfanne/Inlay</documentation> </annotation> </enumeration> <enumeration value="0202006"> <annotation> <documentation>Periprothetische Fraktur</documentation> </annotation> </enumeration> <enumeration value="0202007"> <annotation> <documentation>Verschleiß des PE-Inlays</documentation> </annotation> </enumeration> <enumeration value="0202008"> <annotation> <documentation>Implantatbruch</documentation> </annotation> </enumeration> <enumeration value="0202009"> <annotation> <documentation>Implantatfehllage/Malalignent</documentation> </annotation> </enumeration> <enumeration value="0202010"> <annotation> <documentation>Osteolysen bei festem Implantat</documentation> </annotation> </enumeration> </restriction> </simpleType> </pre> |

```

</enumeration>
<enumeration value="0202011">
  <annotation>
    <documentation>Progression der Grunderkrankung</documentation>
  </annotation>
</enumeration>
<enumeration value="0202012">
  <annotation>
    <documentation>ARMD</documentation>
  </annotation>
</enumeration>
<enumeration value="0202013">
  <annotation>
    <documentation>Verdacht auf allergische Reaktion</documentation>
  </annotation>
</enumeration>
<enumeration value="0202021">
  <annotation>
    <documentation>Zustand nach Prothesenentfernung</documentation>
  </annotation>
</enumeration>
<enumeration value="0202042">
  <annotation>
    <documentation>andere Gründe</documentation>
  </annotation>
</enumeration>
</restriction>
</simpleType>

```

simpleType enum_0204

| | | | |
|------------|------------------------------|---------|--|
| namespace | http://xml.ir-d.de/irdsa | | |
| type | restriction of string | | |
| properties | base xs:string | | |
| facets | Kind | Value | Annotation |
| | enumeration | 0204001 | documentation Lockerung |
| | enumeration | 0204002 | documentation Infektion, Verdacht auf |
| | enumeration | 0204003 | documentation Infektion, gesichert |
| | enumeration | 0204006 | documentation Periprothetische Fraktur |
| | enumeration | 0204007 | documentation Verschleiß |
| | enumeration | 0204008 | documentation Implantatbruch |
| | enumeration | 0204009 | documentation Implantatfehlage/Malalignent |
| | enumeration | 0204010 | documentation Osteolysen bei festem Implantat |
| | enumeration | 0204011 | documentation Progression der Grunderkrankung |
| | enumeration | 0204012 | documentation ARMD |
| | enumeration | 0204013 | documentation Verdacht auf allergische Reaktion |
| | enumeration | 0204014 | documentation Dislokation/Migration von Komponenten |

| | |
|------------|--|
| | <p>enumeration 0204015 documentation Bandinstabilität</p> <p>enumeration 0204016 documentation Bewegungseinschränkung</p> <p>enumeration 0204021 documentation Zustand nach Prothesenentfernung</p> <p>enumeration 0204042 documentation andere Gründe</p> |
| annotation | documentation Kat_EP_GrundWechselKnie |
| source | <pre> <simpleType name="enum_0204"> <annotation> <documentation>Kat_EP_GrundWechselKnie</documentation> </annotation> <restriction base="xs:string"> <enumeration value="0204001"> <annotation> <documentation>Lockerung</documentation> </annotation> </enumeration> <enumeration value="0204002"> <annotation> <documentation>Infektion, Verdacht auf</documentation> </annotation> </enumeration> <enumeration value="0204003"> <annotation> <documentation>Infektion, gesichert</documentation> </annotation> </enumeration> <enumeration value="0204006"> <annotation> <documentation>Periprothetische Fraktur</documentation> </annotation> </enumeration> <enumeration value="0204007"> <annotation> <documentation>Verschleiß</documentation> </annotation> </enumeration> <enumeration value="0204008"> <annotation> <documentation>Implantatbruch</documentation> </annotation> </enumeration> <enumeration value="0204009"> <annotation> <documentation>Implantatfehlage/Malalignent</documentation> </annotation> </enumeration> <enumeration value="0204010"> <annotation> <documentation>Osteolysen bei festem Implantat</documentation> </annotation> </enumeration> <enumeration value="0204011"> <annotation> <documentation>Progression der Grunderkrankung</documentation> </annotation> </enumeration> </restriction> </simpleType> </pre> |

```

<enumeration value="0204012">
  <annotation>
    <documentation>ARMD</documentation>
  </annotation>
</enumeration>
<enumeration value="0204013">
  <annotation>
    <documentation>Verdacht auf allergische Reaktion</documentation>
  </annotation>
</enumeration>
<enumeration value="0204014">
  <annotation>
    <documentation>Dislokation/Migration von Komponenten</documentation>
  </annotation>
</enumeration>
<enumeration value="0204015">
  <annotation>
    <documentation>Bandinstabilität</documentation>
  </annotation>
</enumeration>
<enumeration value="0204016">
  <annotation>
    <documentation>Bewegungseinschränkung</documentation>
  </annotation>
</enumeration>
<enumeration value="0204021">
  <annotation>
    <documentation>Zustand nach Prothesenentfernung</documentation>
  </annotation>
</enumeration>
<enumeration value="0204042">
  <annotation>
    <documentation>andere Gründe</documentation>
  </annotation>
</enumeration>
</restriction>
</simpleType>

```

simpleType enum 0206

| | | | |
|------------|------------------------------|---------|--|
| namespace | http://xml.ir-d.de/irdsa | | |
| type | restriction of string | | |
| properties | base xs:string | | |
| facets | Kind | Value | Annotation |
| | enumeration | 0206001 | documentation Lockerung |
| | enumeration | 0206002 | documentation Infektion, Verdacht auf |
| | enumeration | 0206003 | documentation Infektion, gesichert |
| | enumeration | 0206004 | documentation Luxation, Inlay aus der Pfanne |
| | enumeration | 0206005 | documentation Luxation, Kopf aus Pfanne/Inlay |
| | enumeration | 0206006 | documentation Periprothetische Fraktur |
| | enumeration | 0206007 | documentation Verschleiß |

| | |
|------------|--|
| | <p>enumeration 0206008 documentation Implantatbruch</p> <p>enumeration 0206009 documentation Implantatfehlage/Malalignent</p> <p>enumeration 0206010 documentation Osteolysen bei festem Implantat</p> <p>enumeration 0206011 documentation Progression der Grunderkrankung</p> <p>enumeration 0206012 documentation ARM-D</p> <p>enumeration 0206013 documentation Verdacht auf allergische Reaktion</p> <p>enumeration 0206014 documentation Dislokation/Migration von Komponenten</p> <p>enumeration 0206015 documentation Bandinstabilität</p> <p>enumeration 0206016 documentation Bewegungseinschränkung</p> <p>enumeration 0206021 documentation Zustand nach Prothesenentfernung</p> <p>enumeration 0206042 documentation andere Gründe</p> |
| annotation | documentation Kat_EP_GrundWechselTFE |
| source | <pre> <simpleType name="enum_0206"> <annotation> <documentation>Kat_EP_GrundWechselTFE</documentation> </annotation> <restriction base="xs:string"> <enumeration value="0206001"> <annotation> <documentation>Lockerung</documentation> </annotation> </enumeration> <enumeration value="0206002"> <annotation> <documentation>Infektion, Verdacht auf</documentation> </annotation> </enumeration> <enumeration value="0206003"> <annotation> <documentation>Infektion, gesichert</documentation> </annotation> </enumeration> <enumeration value="0206004"> <annotation> <documentation>Luxation, Inlay aus der Pfanne</documentation> </annotation> </enumeration> <enumeration value="0206005"> <annotation> <documentation>Luxation, Kopf aus Pfanne/Inlay</documentation> </annotation> </enumeration> <enumeration value="0206006"> <annotation> <documentation>Periprothetische Fraktur</documentation> </annotation> </enumeration> <enumeration value="0206007"> <annotation> </pre> |

```
<documentation>Verschleiß</documentation>
</annotation>
</enumeration>
<enumeration value="0206008">
  <annotation>
    <documentation>Implantatbruch</documentation>
  </annotation>
</enumeration>
<enumeration value="0206009">
  <annotation>
    <documentation>Implantatfehllage/Malalignent</documentation>
  </annotation>
</enumeration>
<enumeration value="0206010">
  <annotation>
    <documentation>Osteolysen bei festem Implantat</documentation>
  </annotation>
</enumeration>
<enumeration value="0206011">
  <annotation>
    <documentation>Progression der Grunderkrankung</documentation>
  </annotation>
</enumeration>
<enumeration value="0206012">
  <annotation>
    <documentation>ARMD</documentation>
  </annotation>
</enumeration>
<enumeration value="0206013">
  <annotation>
    <documentation>Verdacht auf allergische Reaktion</documentation>
  </annotation>
</enumeration>
<enumeration value="0206014">
  <annotation>
    <documentation>Dislokation/Migration von Komponenten</documentation>
  </annotation>
</enumeration>
<enumeration value="0206015">
  <annotation>
    <documentation>Bandinstabilität</documentation>
  </annotation>
</enumeration>
<enumeration value="0206016">
  <annotation>
    <documentation>Bewegungseinschränkung</documentation>
  </annotation>
</enumeration>
<enumeration value="0206021">
  <annotation>
    <documentation>Zustand nach Prothesenentfernung</documentation>
  </annotation>
</enumeration>
<enumeration value="0206042">
  <annotation>
    <documentation>andere Gründe</documentation>
  </annotation>
</enumeration>
</restriction>
```

| | |
|--|----------------------------------|
| | <code></simpleType></code> |
|--|----------------------------------|

simpleType enum_0210

| namespace | http://xml.ir-d.de/irdsa | | | | | | | | | | | | | | | | | | | | | | | | |
|-------------|---|--|-------|------------|-------------|---------|---|-------------|---------|--|-------------|---------|---|-------------|---------|--|-------------|---------|--|-------------|---------|-----------------------------|-------------|---------|-------------------------|
| type | restriction of string | | | | | | | | | | | | | | | | | | | | | | | | |
| properties | base xs:string | | | | | | | | | | | | | | | | | | | | | | | | |
| facets | <table><thead><tr><th>Kind</th><th>Value</th><th>Annotation</th></tr></thead><tbody><tr><td>enumeration</td><td>0210001</td><td>documentation keine relevante Voroperation</td></tr><tr><td>enumeration</td><td>0210002</td><td>documentation Osteosynthese/Osteotomie (Becken)</td></tr><tr><td>enumeration</td><td>0210003</td><td>documentation Osteosynthese/Osteotomie (Femur)</td></tr><tr><td>enumeration</td><td>0210004</td><td>documentation Osteosynthese/Osteotomie (beides)</td></tr><tr><td>enumeration</td><td>0210005</td><td>documentation Operation bei Hüftkopfnekrose</td></tr><tr><td>enumeration</td><td>0210006</td><td>documentation Arthrodese</td></tr><tr><td>enumeration</td><td>0210042</td><td>documentation andere</td></tr></tbody></table> | Kind | Value | Annotation | enumeration | 0210001 | documentation keine relevante Voroperation | enumeration | 0210002 | documentation Osteosynthese/Osteotomie (Becken) | enumeration | 0210003 | documentation Osteosynthese/Osteotomie (Femur) | enumeration | 0210004 | documentation Osteosynthese/Osteotomie (beides) | enumeration | 0210005 | documentation Operation bei Hüftkopfnekrose | enumeration | 0210006 | documentation Arthrodese | enumeration | 0210042 | documentation andere |
| Kind | Value | Annotation | | | | | | | | | | | | | | | | | | | | | | | |
| enumeration | 0210001 | documentation keine relevante Voroperation | | | | | | | | | | | | | | | | | | | | | | | |
| enumeration | 0210002 | documentation Osteosynthese/Osteotomie (Becken) | | | | | | | | | | | | | | | | | | | | | | | |
| enumeration | 0210003 | documentation Osteosynthese/Osteotomie (Femur) | | | | | | | | | | | | | | | | | | | | | | | |
| enumeration | 0210004 | documentation Osteosynthese/Osteotomie (beides) | | | | | | | | | | | | | | | | | | | | | | | |
| enumeration | 0210005 | documentation Operation bei Hüftkopfnekrose | | | | | | | | | | | | | | | | | | | | | | | |
| enumeration | 0210006 | documentation Arthrodese | | | | | | | | | | | | | | | | | | | | | | | |
| enumeration | 0210042 | documentation andere | | | | | | | | | | | | | | | | | | | | | | | |
| annotation | documentation Kat_EP_VoroperationHuefte | | | | | | | | | | | | | | | | | | | | | | | | |
| source | <pre><simpleType name="enum_0210"> <annotation> <documentation>Kat_EP_VoroperationHuefte</documentation> </annotation> <restriction base="xs:string"> <enumeration value="0210001"> <annotation> <documentation>keine relevante Voroperation</documentation> </annotation> </enumeration> <enumeration value="0210002"> <annotation> <documentation>Osteosynthese/Osteotomie (Becken)</documentation> </annotation> </enumeration> <enumeration value="0210003"> <annotation> <documentation>Osteosynthese/Osteotomie (Femur)</documentation> </annotation> </enumeration> <enumeration value="0210004"> <annotation> <documentation>Osteosynthese/Osteotomie (beides)</documentation> </annotation> </enumeration> <enumeration value="0210005"> <annotation> <documentation>Operation bei Hüftkopfnekrose</documentation> </annotation> </enumeration> <enumeration value="0210006"> <annotation> <documentation>Arthrodese</documentation> </annotation> </enumeration> </restriction> </simpleType></pre> | | | | | | | | | | | | | | | | | | | | | | | | |

| | |
|--|--|
| | <pre> </annotation> </enumeration> <enumeration value="0210042"> <annotation> <documentation>andere</documentation> </annotation> </enumeration> </restriction> </simpleType> </pre> |
|--|--|

simpleType enum_0211

| | | | |
|------------|--|---------|---|
| namespace | http://xml.ir-d.de/irdsa | | |
| type | restriction of string | | |
| properties | base xs:string | | |
| facets | Kind | Value | Annotation |
| | enumeration | 0211001 | documentation keine relevante Voroperation |
| | enumeration | 0211002 | documentation Osteosynthese/Osteotomie (Femur) |
| | enumeration | 0211003 | documentation Osteosynthese/Osteotomie (Tibia) |
| | enumeration | 0211004 | documentation Osteosynthese/Osteotomie (Patella) |
| | enumeration | 0211005 | documentation Osteosynthese/Osteotomie (mehrere) |
| | enumeration | 0211006 | documentation Kapsel-/Bandapparat |
| | enumeration | 0211007 | documentation Arthrodese |
| | enumeration | 0211042 | documentation andere |
| annotation | documentation Kat_EP_VoroperationKnie | | |
| source | <pre> <simpleType name="enum_0211"> <annotation> <documentation>Kat_EP_VoroperationKnie</documentation> </annotation> <restriction base="xs:string"> <enumeration value="0211001"> <annotation> <documentation>keine relevante Voroperation</documentation> </annotation> </enumeration> <enumeration value="0211002"> <annotation> <documentation>Osteosynthese/Osteotomie (Femur)</documentation> </annotation> </enumeration> <enumeration value="0211003"> <annotation> <documentation>Osteosynthese/Osteotomie (Tibia)</documentation> </annotation> </enumeration> <enumeration value="0211004"> <annotation> <documentation>Osteosynthese/Osteotomie (Patella)</documentation> </annotation> </pre> | | |

| | |
|--|---|
| | <pre> </enumeration> <enumeration value="0211005"> <annotation> <documentation>Osteosynthese/Osteotomie (mehrere)</documentation> </annotation> </enumeration> <enumeration value="0211006"> <annotation> <documentation>Kapsel-/Bandapparat</documentation> </annotation> </enumeration> <enumeration value="0211007"> <annotation> <documentation>Arthrodese</documentation> </annotation> </enumeration> <enumeration value="0211042"> <annotation> <documentation>andere</documentation> </annotation> </enumeration> </restriction> </simpleType> </pre> |
|--|---|

simpleType enum_0212

| | | | |
|------------|--|---------|--|
| namespace | http://xml.ir-d.de/irdsa | | |
| type | restriction of string | | |
| properties | base xs:string | | |
| facets | Kind | Value | Annotation |
| | enumeration | 0212001 | documentation Hüfte |
| | enumeration | 0212002 | documentation Knie |
| | enumeration | 0212003 | documentation Totaler Femurersatz inkl. Durchsteck-Prothese |
| annotation | documentation Kat EP Gelenk | | |
| source | <pre> <simpleType name="enum_0212"> <annotation> <documentation>Kat_EP_Gelenk</documentation> </annotation> <restriction base="xs:string"> <enumeration value="0212001"> <annotation> <documentation>Hüfte</documentation> </annotation> </enumeration> <enumeration value="0212002"> <annotation> <documentation>Knie</documentation> </annotation> </enumeration> <enumeration value="0212003"> <annotation> <documentation>Totaler Femurersatz inkl. Durchsteck-Prothese</documentation> </pre> | | |

```

</annotation>
</enumeration>
</restriction>
</simpleType>

```

simpleType enum_0220

| | | | |
|------------|---|---------|--------------------------------------|
| namespace | http://xml.ir-d.de/irdsa | | |
| type | restriction of string | | |
| properties | base xs:string | | |
| facets | Kind | Value | Annotation |
| | enumeration | 0220001 | documentation anterior |
| | enumeration | 0220002 | documentation anterolateral |
| | enumeration | 0220003 | documentation lateral |
| | enumeration | 0220004 | documentation posterior |
| | enumeration | 0220005 | documentation posterolateral |
| | enumeration | 0220006 | documentation 2-Inzisionen-Zugang |
| | enumeration | 0220042 | documentation sonstiges/unbekannt |
| annotation | documentation Kat_EP_Operationszugang | | |
| source | <pre> <simpleType name="enum_0220"> <annotation> <documentation>Kat_EP_Operationszugang</documentation> </annotation> <restriction base="xs:string"> <enumeration value="0220001"> <annotation> <documentation>anterior</documentation> </annotation> </enumeration> <enumeration value="0220002"> <annotation> <documentation>anterolateral</documentation> </annotation> </enumeration> <enumeration value="0220003"> <annotation> <documentation>lateral</documentation> </annotation> </enumeration> <enumeration value="0220004"> <annotation> <documentation>posterior</documentation> </annotation> </enumeration> <enumeration value="0220005"> <annotation> <documentation>posterolateral</documentation> </annotation> </enumeration> </restriction> </simpleType> </pre> | | |

| | |
|--|---|
| | <pre> <enumeration value="0220006"> <annotation> <documentation>2-Inzisionen-Zugang</documentation> </annotation> </enumeration> <enumeration value="0220042"> <annotation> <documentation>sonstiges/unbekannt</documentation> </annotation> </enumeration> </restriction> </simpleType> </pre> |
|--|---|

simpleType enum_0222

| | | | |
|------------|---|---------|-----------------------------|
| namespace | http://xml.ir-d.de/irdsa | | |
| type | restriction of string | | |
| properties | base xs:string | | |
| facets | Kind | Value | Annotation |
| | enumeration | 0222001 | documentation nein |
| | enumeration | 0222002 | documentation ja- Ausbau |
| | enumeration | 0222003 | documentation ja- Einbau |
| annotation | documentation Kat_EP_Zweizeitwechsel | | |
| source | <pre> <simpleType name="enum_0222"> <annotation> <documentation>Kat_EP_Zweizeitwechsel</documentation> </annotation> <restriction base="xs:string"> <enumeration value="0222001"> <annotation> <documentation>nein</documentation> </annotation> </enumeration> <enumeration value="0222002"> <annotation> <documentation>ja- Ausbau</documentation> </annotation> </enumeration> <enumeration value="0222003"> <annotation> <documentation>ja- Einbau</documentation> </annotation> </enumeration> </restriction> </simpleType> </pre> | | |

simpleType enum_0230

| | |
|-----------|------------------------------|
| namespace | http://xml.ir-d.de/irdsa |
| type | restriction of string |

| properties | base | xs:string | |
|------------|-------------|-----------|---|
| facets | Kind | Value | Annotation |
| | enumeration | 0230001 | documentation Smith & Nephew GmbH |
| | enumeration | 0230002 | documentation Mathys Orthopädie GmbH |
| | enumeration | 0230003 | documentation Ceramtec AG |
| | enumeration | 0230004 | documentation Biomet |
| | enumeration | 0230005 | documentation Peter Brehm GmbH |
| | enumeration | 0230006 | documentation Amplitude GmbH |
| | enumeration | 0230007 | documentation Exactech Deutschland |
| | enumeration | 0230008 | documentation Globus Medical |
| | enumeration | 0230009 | documentation Implantcast GmbH |
| | enumeration | 0230010 | documentation DePuy Orthopädie GmbH |
| | enumeration | 0230011 | documentation IO-International Orthopaedics |
| | enumeration | 0230012 | documentation Joint Replacement Ltd. Instrumentation |
| | enumeration | 0230013 | documentation Merete |
| | enumeration | 0230014 | documentation S&G Implants GmbH |
| | enumeration | 0230015 | documentation Speetec Implantate GmbH |
| | enumeration | 0230016 | documentation Stemcup Medical Products GmbH |
| | enumeration | 0230017 | documentation Symbios Deutschland GmbH |
| | enumeration | 0230018 | documentation Tantum AG |
| | enumeration | 0230019 | documentation Tomier GmbH |
| | enumeration | 0230020 | documentation MicroPort Orthopedics GmbH |
| | enumeration | 0230021 | documentation aap Implanate AG |
| | enumeration | 0230022 | documentation AQImplants |
| | enumeration | 0230023 | documentation ESKA Orthodynamics GmbH |
| | enumeration | 0230024 | documentation Ateos medical AG |
| | enumeration | 0230025 | documentation Chiropro GmbH |
| | enumeration | 0230026 | documentation Medacta |
| | enumeration | 0230027 | documentation OHST Medizintechnik AG |
| | enumeration | 0230028 | documentation Lima Deutschland GmbH |
| | enumeration | 0230029 | documentation alloPlus GmbH |
| | enumeration | 0230030 | documentation Heraeus Medical GmbH |
| | enumeration | 0230031 | documentation ImplanTec Deutschland GmbH |

| | |
|------------|--|
| | <p>enumeration 0230032 documentation Falcon Medical GmbH</p> <p>enumeration 0230033 documentation Meril GmbH</p> <p>enumeration 0230034 documentation Zimmer Germany GmbH</p> <p>enumeration 0230035 documentation Stryker GmbH & Co. KG</p> <p>enumeration 0230036 documentation Aesculap AG</p> <p>enumeration 0230037 documentation Waldemar Link GmbH & Co. KG</p> <p>enumeration 0230038 documentation Corin Germany GmbH</p> <p>enumeration 0230039 documentation nicht belegter Wert</p> <p>enumeration 0230040 documentation nicht belegter Wert</p> <p>enumeration 0230041 documentation nicht belegter Wert</p> <p>enumeration 0230042 documentation sonstige</p> <p>enumeration 0230043 documentation nicht belegter Wert</p> <p>enumeration 0230044 documentation nicht belegter Wert</p> |
| annotation | documentation Kat_EP_Hersteller |
| source | <pre> <simpleType name="enum_0230"> <annotation> <documentation>Kat_EP_Hersteller</documentation> </annotation> <restriction base="xs:string"> <enumeration value="0230001"> <annotation> <documentation>Smith & Nephew GmbH</documentation> </annotation> </enumeration> <enumeration value="0230002"> <annotation> <documentation>Mathys Orthopädie GmbH</documentation> </annotation> </enumeration> <enumeration value="0230003"> <annotation> <documentation>Ceramtec AG</documentation> </annotation> </enumeration> <enumeration value="0230004"> <annotation> <documentation>Biomet</documentation> </annotation> </enumeration> <enumeration value="0230005"> <annotation> <documentation>Peter Brehm GmbH</documentation> </annotation> </enumeration> <enumeration value="0230006"> <annotation> <documentation>Amplitude GmbH</documentation> </annotation> </enumeration> </restriction> </simpleType> </pre> |

```
</annotation>
</enumeration>
<enumeration value="0230007">
  <annotation>
    <documentation>Exactech Deutschland</documentation>
  </annotation>
</enumeration>
<enumeration value="0230008">
  <annotation>
    <documentation>Globus Medical</documentation>
  </annotation>
</enumeration>
<enumeration value="0230009">
  <annotation>
    <documentation>Implantcast GmbH</documentation>
  </annotation>
</enumeration>
<enumeration value="0230010">
  <annotation>
    <documentation>DePuy Orthopädie GmbH</documentation>
  </annotation>
</enumeration>
<enumeration value="0230011">
  <annotation>
    <documentation>IO-International Orthopaedics</documentation>
  </annotation>
</enumeration>
<enumeration value="0230012">
  <annotation>
    <documentation>Joint Replacement Ltd. Instrumentation</documentation>
  </annotation>
</enumeration>
<enumeration value="0230013">
  <annotation>
    <documentation>Merete</documentation>
  </annotation>
</enumeration>
<enumeration value="0230014">
  <annotation>
    <documentation>S&G Implants GmbH</documentation>
  </annotation>
</enumeration>
<enumeration value="0230015">
  <annotation>
    <documentation>Speetec Implantate GmbH</documentation>
  </annotation>
</enumeration>
<enumeration value="0230016">
  <annotation>
    <documentation>Stemcup Medical Products GmbH</documentation>
  </annotation>
</enumeration>
<enumeration value="0230017">
  <annotation>
    <documentation>Symbios Deutschland GmbH</documentation>
  </annotation>
</enumeration>
<enumeration value="0230018">
  <annotation>
```

```
<documentation>Tantum AG</documentation>
</annotation>
</enumeration>
<enumeration value="0230019">
  <annotation>
    <documentation>Tornier GmbH</documentation>
  </annotation>
</enumeration>
<enumeration value="0230020">
  <annotation>
    <documentation>MicroPort Orthopedics GmbH</documentation>
  </annotation>
</enumeration>
<enumeration value="0230021">
  <annotation>
    <documentation>aap Implanate AG</documentation>
  </annotation>
</enumeration>
<enumeration value="0230022">
  <annotation>
    <documentation>AQImplants</documentation>
  </annotation>
</enumeration>
<enumeration value="0230023">
  <annotation>
    <documentation>ESKA Orthodynamics GmbH</documentation>
  </annotation>
</enumeration>
<enumeration value="0230024">
  <annotation>
    <documentation>Atecos medical AG</documentation>
  </annotation>
</enumeration>
<enumeration value="0230025">
  <annotation>
    <documentation>Chiropro GmbH</documentation>
  </annotation>
</enumeration>
<enumeration value="0230026">
  <annotation>
    <documentation>Medacta</documentation>
  </annotation>
</enumeration>
<enumeration value="0230027">
  <annotation>
    <documentation>OHST Medizintechnik AG</documentation>
  </annotation>
</enumeration>
<enumeration value="0230028">
  <annotation>
    <documentation>Lima Deutschland GmbH</documentation>
  </annotation>
</enumeration>
<enumeration value="0230029">
  <annotation>
    <documentation>alloPlus GmbH</documentation>
  </annotation>
</enumeration>
<enumeration value="0230030">
```

```
<annotation>
  <documentation>Heraeus Medical GmbH</documentation>
</annotation>
</enumeration>
<enumeration value="0230031">
  <annotation>
    <documentation>ImplanTec Deutschland GmbH</documentation>
  </annotation>
</enumeration>
<enumeration value="0230032">
  <annotation>
    <documentation>Falcon Medical GmbH</documentation>
  </annotation>
</enumeration>
<enumeration value="0230033">
  <annotation>
    <documentation>Meril GmbH</documentation>
  </annotation>
</enumeration>
<enumeration value="0230034">
  <annotation>
    <documentation>Zimmer Germany GmbH</documentation>
  </annotation>
</enumeration>
<enumeration value="0230035">
  <annotation>
    <documentation>Stryker GmbH & Co. KG</documentation>
  </annotation>
</enumeration>
<enumeration value="0230036">
  <annotation>
    <documentation>Aesculap AG</documentation>
  </annotation>
</enumeration>
<enumeration value="0230037">
  <annotation>
    <documentation>Waldemar Link GmbH & Co. KG</documentation>
  </annotation>
</enumeration>
<enumeration value="0230038">
  <annotation>
    <documentation>Corin Germany GmbH</documentation>
  </annotation>
</enumeration>
<enumeration value="0230039">
  <annotation>
    <documentation>nicht belegter Wert</documentation>
  </annotation>
</enumeration>
<enumeration value="0230040">
  <annotation>
    <documentation>nicht belegter Wert</documentation>
  </annotation>
</enumeration>
<enumeration value="0230041">
  <annotation>
    <documentation>nicht belegter Wert</documentation>
  </annotation>
</enumeration>
```

| | |
|--|---|
| | <pre> <enumeration value="0230042"> <annotation> <documentation>sonstige</documentation> </annotation> </enumeration> <enumeration value="0230043"> <annotation> <documentation>nicht belegter Wert</documentation> </annotation> </enumeration> <enumeration value="0230044"> <annotation> <documentation>nicht belegter Wert</documentation> </annotation> </enumeration> </restriction> </simpleType> </pre> |
|--|---|

simpleType enum 0252

| | | | |
|------------|--|---------|-------------------------|
| namespace | http://xml.ir-d.de/irdsa | | |
| type | restriction of string | | |
| properties | base xs:string | | |
| facets | Kind | Value | Annotation |
| | enumeration | 0252001 | documentation Pfanne |
| | enumeration | 0252002 | documentation Schaft |
| | enumeration | 0252003 | documentation beides |
| annotation | documentation Kat EP KomponenteHuefte | | |
| source | <pre> <simpleType name="enum_0252"> <annotation> <documentation>Kat_EP_KomponenteHuefte</documentation> </annotation> <restriction base="xs:string"> <enumeration value="0252001"> <annotation> <documentation>Pfanne</documentation> </annotation> </enumeration> <enumeration value="0252002"> <annotation> <documentation>Schaft</documentation> </annotation> </enumeration> <enumeration value="0252003"> <annotation> <documentation>beides</documentation> </annotation> </enumeration> </restriction> </simpleType> </pre> | | |

simpleType enum_0254

| | | | |
|------------|--|---------|--------------------------|
| namespace | http://xml.ir-d.de/irdsa | | |
| type | restriction of string | | |
| properties | base xs:string | | |
| facets | Kind | Value | Annotation |
| | enumeration | 0254001 | documentation Femur |
| | enumeration | 0254002 | documentation Tibia |
| | enumeration | 0254003 | documentation Patella |
| | enumeration | 0254004 | documentation mehrere |
| annotation | documentation Kat_EP_KomponenteKnie | | |
| source | <pre> <simpleType name="enum_0254"> <annotation> <documentation>Kat_EP_KomponenteKnie</documentation> </annotation> <restriction base="xs:string"> <enumeration value="0254001"> <annotation> <documentation>Femur</documentation> </annotation> </enumeration> <enumeration value="0254002"> <annotation> <documentation>Tibia</documentation> </annotation> </enumeration> <enumeration value="0254003"> <annotation> <documentation>Patella</documentation> </annotation> </enumeration> <enumeration value="0254004"> <annotation> <documentation>mehrere</documentation> </annotation> </enumeration> </restriction> </simpleType> </pre> | | |

simpleType enum_0256

| | | | |
|------------|------------------------------|---------|------------------------------------|
| namespace | http://xml.ir-d.de/irdsa | | |
| type | restriction of string | | |
| properties | base xs:string | | |
| facets | Kind | Value | Annotation |
| | enumeration | 0256001 | documentation Pfanne |
| | enumeration | 0256002 | documentation Schaft |
| | enumeration | 0256003 | documentation Pfanne und Schaft |
| | enumeration | 0256004 | documentation |

| | |
|------------|--|
| | <p>enumeration 0256005 Femur documentation Tibia</p> <p>enumeration 0256006 documentation Patella</p> <p>enumeration 0256007 documentation mehrere</p> |
| annotation | documentation Kat_EP_KomponenteTFE |
| source | <pre> <simpleType name="enum_0256"> <annotation> <documentation>Kat_EP_KomponenteTFE</documentation> </annotation> <restriction base="xs:string"> <enumeration value="0256001"> <annotation> <documentation>Pfanne</documentation> </annotation> </enumeration> <enumeration value="0256002"> <annotation> <documentation>Schaft</documentation> </annotation> </enumeration> <enumeration value="0256003"> <annotation> <documentation>Pfanne und Schaft</documentation> </annotation> </enumeration> <enumeration value="0256004"> <annotation> <documentation>Femur</documentation> </annotation> </enumeration> <enumeration value="0256005"> <annotation> <documentation>Tibia</documentation> </annotation> </enumeration> <enumeration value="0256006"> <annotation> <documentation>Patella</documentation> </annotation> </enumeration> <enumeration value="0256007"> <annotation> <documentation>mehrere</documentation> </annotation> </enumeration> </restriction> </simpleType> </pre> |

simpleType enum_0262

| | |
|------------|------------------------------|
| namespace | http://xml.ir-d.de/irdsa |
| type | restriction of string |
| properties | base xs:string |

| facets | <table border="1"> <thead> <tr> <th>Kind</th> <th>Value</th> <th>Annotation</th> </tr> </thead> <tbody> <tr> <td>enumeration</td> <td>0262001</td> <td>documentation Pfanne</td> </tr> <tr> <td>enumeration</td> <td>0262002</td> <td>documentation Schaft</td> </tr> <tr> <td>enumeration</td> <td>0262003</td> <td>documentation Kopf</td> </tr> <tr> <td>enumeration</td> <td>0262004</td> <td>documentation Inlay</td> </tr> <tr> <td>enumeration</td> <td>0262005</td> <td>documentation Adapter</td> </tr> <tr> <td>enumeration</td> <td>0262006</td> <td>documentation mehrere</td> </tr> </tbody> </table> | Kind | Value | Annotation | enumeration | 0262001 | documentation Pfanne | enumeration | 0262002 | documentation Schaft | enumeration | 0262003 | documentation Kopf | enumeration | 0262004 | documentation Inlay | enumeration | 0262005 | documentation Adapter | enumeration | 0262006 | documentation mehrere |
|-------------|---|--------------------------|-------|------------|-------------|---------|-------------------------|-------------|---------|-------------------------|-------------|---------|-----------------------|-------------|---------|------------------------|-------------|---------|--------------------------|-------------|---------|--------------------------|
| Kind | Value | Annotation | | | | | | | | | | | | | | | | | | | | |
| enumeration | 0262001 | documentation Pfanne | | | | | | | | | | | | | | | | | | | | |
| enumeration | 0262002 | documentation Schaft | | | | | | | | | | | | | | | | | | | | |
| enumeration | 0262003 | documentation Kopf | | | | | | | | | | | | | | | | | | | | |
| enumeration | 0262004 | documentation Inlay | | | | | | | | | | | | | | | | | | | | |
| enumeration | 0262005 | documentation Adapter | | | | | | | | | | | | | | | | | | | | |
| enumeration | 0262006 | documentation mehrere | | | | | | | | | | | | | | | | | | | | |
| annotation | documentation Kat_EP_ImplantatbruchHuefte | | | | | | | | | | | | | | | | | | | | | |
| source | <pre> <simpleType name="enum_0262"> <annotation> <documentation>Kat_EP_ImplantatbruchHuefte</documentation> </annotation> <restriction base="xs:string"> <enumeration value="0262001"> <annotation> <documentation>Pfanne</documentation> </annotation> </enumeration> <enumeration value="0262002"> <annotation> <documentation>Schaft</documentation> </annotation> </enumeration> <enumeration value="0262003"> <annotation> <documentation>Kopf</documentation> </annotation> </enumeration> <enumeration value="0262004"> <annotation> <documentation>Inlay</documentation> </annotation> </enumeration> <enumeration value="0262005"> <annotation> <documentation>Adapter</documentation> </annotation> </enumeration> <enumeration value="0262006"> <annotation> <documentation>mehrere</documentation> </annotation> </enumeration> </restriction> </simpleType> </pre> | | | | | | | | | | | | | | | | | | | | | |

simpleType enum_0264

| | |
|-----------|------------------------------|
| namespace | http://xml.ir-d.de/irdsa |
| type | restriction of string |

| properties | base xs:string | | | | | | | | | | | | | | | | | | | | | | | | | | | |
|-------------|--|-------------------------------|-------|------------|-------------|---------|------------------------|-------------|---------|------------------------|-------------|---------|------------------------|-------------|---------|--------------------------|-------------|---------|-------------------------------|-------------|---------|----------------------------|-------------|---------|--------------------------|-------------|---------|-------------------------|
| facets | <table border="1"> <thead> <tr> <th>Kind</th> <th>Value</th> <th>Annotation</th> </tr> </thead> <tbody> <tr> <td>enumeration</td> <td>0264001</td> <td>documentation Femur</td> </tr> <tr> <td>enumeration</td> <td>0264002</td> <td>documentation Tibia</td> </tr> <tr> <td>enumeration</td> <td>0264003</td> <td>documentation Inlay</td> </tr> <tr> <td>enumeration</td> <td>0264004</td> <td>documentation Adapter</td> </tr> <tr> <td>enumeration</td> <td>0264005</td> <td>documentation Verlängerung</td> </tr> <tr> <td>enumeration</td> <td>0264006</td> <td>documentation Schrauben</td> </tr> <tr> <td>enumeration</td> <td>0264007</td> <td>documentation mehrere</td> </tr> <tr> <td>enumeration</td> <td>0264042</td> <td>documentation andere</td> </tr> </tbody> </table> | Kind | Value | Annotation | enumeration | 0264001 | documentation Femur | enumeration | 0264002 | documentation Tibia | enumeration | 0264003 | documentation Inlay | enumeration | 0264004 | documentation Adapter | enumeration | 0264005 | documentation Verlängerung | enumeration | 0264006 | documentation Schrauben | enumeration | 0264007 | documentation mehrere | enumeration | 0264042 | documentation andere |
| Kind | Value | Annotation | | | | | | | | | | | | | | | | | | | | | | | | | | |
| enumeration | 0264001 | documentation Femur | | | | | | | | | | | | | | | | | | | | | | | | | | |
| enumeration | 0264002 | documentation Tibia | | | | | | | | | | | | | | | | | | | | | | | | | | |
| enumeration | 0264003 | documentation Inlay | | | | | | | | | | | | | | | | | | | | | | | | | | |
| enumeration | 0264004 | documentation Adapter | | | | | | | | | | | | | | | | | | | | | | | | | | |
| enumeration | 0264005 | documentation Verlängerung | | | | | | | | | | | | | | | | | | | | | | | | | | |
| enumeration | 0264006 | documentation Schrauben | | | | | | | | | | | | | | | | | | | | | | | | | | |
| enumeration | 0264007 | documentation mehrere | | | | | | | | | | | | | | | | | | | | | | | | | | |
| enumeration | 0264042 | documentation andere | | | | | | | | | | | | | | | | | | | | | | | | | | |
| annotation | documentation Kat_EP_ImplantatbruchKnie | | | | | | | | | | | | | | | | | | | | | | | | | | | |
| source | <pre> <simpleType name="enum_0264"> <annotation> <documentation>Kat_EP_ImplantatbruchKnie</documentation> </annotation> <restriction base="xs:string"> <enumeration value="0264001"> <annotation> <documentation>Femur</documentation> </annotation> </enumeration> <enumeration value="0264002"> <annotation> <documentation>Tibia</documentation> </annotation> </enumeration> <enumeration value="0264003"> <annotation> <documentation>Inlay</documentation> </annotation> </enumeration> <enumeration value="0264004"> <annotation> <documentation>Adapter</documentation> </annotation> </enumeration> <enumeration value="0264005"> <annotation> <documentation>Verlängerung</documentation> </annotation> </enumeration> <enumeration value="0264006"> <annotation> <documentation>Schrauben</documentation> </annotation> </enumeration> <enumeration value="0264007"> <annotation> <documentation>mehrere</documentation> </annotation> </enumeration> </restriction> </simpleType> </pre> | | | | | | | | | | | | | | | | | | | | | | | | | | | |

| | |
|--|---|
| | <pre> <enumeration value="0264042"> <annotation> <documentation>andere</documentation> </annotation> </enumeration> </restriction> </simpleType> </pre> |
|--|---|

simpleType enum_0266

| | | | |
|------------|---|---------|-------------------------------|
| namespace | http://xml.ir-d.de/irdsa | | |
| type | restriction of string | | |
| properties | base xs:string | | |
| facets | Kind | Value | Annotation |
| | enumeration | 0266001 | documentation Pfanne |
| | enumeration | 0266002 | documentation Schaft |
| | enumeration | 0266003 | documentation Kopf |
| | enumeration | 0266004 | documentation Inlay |
| | enumeration | 0266005 | documentation Adapter |
| | enumeration | 0266006 | documentation Femur |
| | enumeration | 0266007 | documentation Tibia |
| | enumeration | 0266008 | documentation Verlängerung |
| | enumeration | 0266009 | documentation Schrauben |
| | enumeration | 0266010 | documentation mehrere |
| | enumeration | 0266042 | documentation andere |
| annotation | documentation Kat_EP_ImplantatbruchTFE | | |
| source | <pre> <simpleType name="enum_0266"> <annotation> <documentation>Kat_EP_ImplantatbruchTFE</documentation> </annotation> <restriction base="xs:string"> <enumeration value="0266001"> <annotation> <documentation>Pfanne</documentation> </annotation> </enumeration> <enumeration value="0266002"> <annotation> <documentation>Schaft</documentation> </annotation> </enumeration> <enumeration value="0266003"> <annotation> <documentation>Kopf</documentation> </annotation> </enumeration> </restriction> </simpleType> </pre> | | |

```

<enumeration value="0266004">
  <annotation>
    <documentation>Inlay</documentation>
  </annotation>
</enumeration>
<enumeration value="0266005">
  <annotation>
    <documentation>Adapter</documentation>
  </annotation>
</enumeration>
<enumeration value="0266006">
  <annotation>
    <documentation>Femur</documentation>
  </annotation>
</enumeration>
<enumeration value="0266007">
  <annotation>
    <documentation>Tibia</documentation>
  </annotation>
</enumeration>
<enumeration value="0266008">
  <annotation>
    <documentation>Verlängerung</documentation>
  </annotation>
</enumeration>
<enumeration value="0266009">
  <annotation>
    <documentation>Schrauben</documentation>
  </annotation>
</enumeration>
<enumeration value="0266010">
  <annotation>
    <documentation>mehrere</documentation>
  </annotation>
</enumeration>
<enumeration value="0266042">
  <annotation>
    <documentation>andere</documentation>
  </annotation>
</enumeration>
</restriction>
</simpleType>

```

simpleType enum_0270

| | | | |
|------------|---|---------|---------------------------------------|
| namespace | http://xml.ir-d.de/irdsa | | |
| type | restriction of string | | |
| properties | base xs:string | | |
| facets | Kind | Value | Annotation |
| | enumeration | 0270001 | documentation PE-Inlay |
| | enumeration | 0270002 | documentation patellare Komponente |
| | enumeration | 0270003 | documentation beides |
| annotation | documentation Kat_EP_VerschleissKnie | | |

| | |
|--------|---|
| source | <pre> <simpleType name="enum_0270"> <annotation> <documentation>Kat_EP_VerschleissKnie</documentation> </annotation> <restriction base="xs:string"> <enumeration value="0270001"> <annotation> <documentation>PE-Inlay</documentation> </annotation> </enumeration> <enumeration value="0270002"> <annotation> <documentation>patellare Komponente</documentation> </annotation> </enumeration> <enumeration value="0270003"> <annotation> <documentation>beides</documentation> </annotation> </enumeration> </restriction> </simpleType> </pre> |
|--------|---|

simpleType enum_0271

| | | | |
|------------|--|---------|---------------------------------------|
| namespace | http://xml.ir-d.de/irdsa | | |
| type | restriction of string | | |
| properties | base xs:string | | |
| facets | Kind | Value | Annotation |
| | enumeration | 0271001 | documentation Schraube |
| | enumeration | 0271002 | documentation Inlay |
| | enumeration | 0271003 | documentation patellare Komponente |
| | enumeration | 0271004 | documentation Kopplung |
| | enumeration | 0271005 | documentation mehrere |
| | enumeration | 0271042 | documentation andere |
| annotation | documentation Kat_EP_MigrationKnie | | |
| source | <pre> <simpleType name="enum_0271"> <annotation> <documentation>Kat_EP_MigrationKnie</documentation> </annotation> <restriction base="xs:string"> <enumeration value="0271001"> <annotation> <documentation>Schraube</documentation> </annotation> </enumeration> <enumeration value="0271002"> <annotation> <documentation>Inlay</documentation> </annotation> </enumeration> </restriction> </simpleType> </pre> | | |

| | |
|--|---|
| | <pre> </enumeration> <enumeration value="0271003"> <annotation> <documentation>patellare Komponente</documentation> </annotation> </enumeration> <enumeration value="0271004"> <annotation> <documentation>Kopplung</documentation> </annotation> </enumeration> <enumeration value="0271005"> <annotation> <documentation>mehrere</documentation> </annotation> </enumeration> <enumeration value="0271042"> <annotation> <documentation>andere</documentation> </annotation> </enumeration> </restriction> </simpleType> </pre> |
|--|---|

simpleType enum_0290

| | | | |
|------------|--|---------|---|
| namespace | http://xml.ir-d.de/irdsa | | |
| type | restriction of string | | |
| properties | base xs:string | | |
| facets | Kind | Value | Annotation |
| | enumeration | 0290001 | documentation Hüft-Komponente |
| | enumeration | 0290002 | documentation Knie-Komponente |
| | enumeration | 0290003 | documentation Modulare Komponente (Hüfte/Knie) |
| annotation | documentation Kat EP Artikeltyp | | |
| source | <pre> <simpleType name="enum_0290"> <annotation> <documentation>Kat_EP_Artikeltyp</documentation> </annotation> <restriction base="xs:string"> <enumeration value="0290001"> <annotation> <documentation>Hüft-Komponente</documentation> </annotation> </enumeration> <enumeration value="0290002"> <annotation> <documentation>Knie-Komponente</documentation> </annotation> </enumeration> <enumeration value="0290003"> <annotation> <documentation>Modulare Komponente (Hüfte/Knie)</documentation> </annotation> </enumeration> </restriction> </simpleType> </pre> | | |

| | |
|--|--|
| | <pre> </enumeration> </restriction> </simpleType> </pre> |
|--|--|

simpleType enum_0291

| | | | |
|------------|--|---------|------------------------------------|
| namespace | http://xml.ir-d.de/irdsa | | |
| type | restriction of string | | |
| properties | base xs:string | | |
| facets | Kind | Value | Annotation |
| | enumeration | 0291001 | documentation Knochen-Zement |
| | enumeration | 0291002 | documentation sonstiges Zubehör |
| annotation | documentation Kat_EP_ZubehoerTyp | | |
| source | <pre> <simpleType name="enum_0291"> <annotation> <documentation>Kat_EP_ZubehoerTyp</documentation> </annotation> <restriction base="xs:string"> <enumeration value="0291001"> <annotation> <documentation>Knochen-Zement</documentation> </annotation> </enumeration> <enumeration value="0291002"> <annotation> <documentation>sonstiges Zubehör</documentation> </annotation> </enumeration> </restriction> </simpleType> </pre> | | |

simpleType enum_0300

| | | | |
|------------|---|---------|---|
| namespace | http://xml.ir-d.de/irdsa | | |
| type | restriction of string | | |
| properties | base xs:string | | |
| facets | Kind | Value | Annotation |
| | enumeration | 0300001 | documentation konventionieller Aortenklappenersatz |
| | enumeration | 0300002 | documentation kathetergestützte Aortenklappenimplantation (TAVI) |
| annotation | documentation Kat_AK_ArtEingriff | | |
| source | <pre> <simpleType name="enum_0300"> <annotation> <documentation>Kat_AK_ArtEingriff</documentation> </annotation> <restriction base="xs:string"> <enumeration value="0300001"> <annotation> <documentation>konventionieller Aortenklappenersatz</documentation> </annotation> </enumeration> </restriction> </simpleType> </pre> | | |

| | |
|--|--|
| | <pre> </annotation> </enumeration> <enumeration value="0300002"> <annotation> <documentation>kathetergestützte Aortenklappenimplantation (TAVI)</documentation> </annotation> </enumeration> </restriction> </simpleType> </pre> |
|--|--|

simpleType enum_0302

| | | | |
|------------|--|---------|---|
| namespace | http://xml.ir-d.de/irdsa | | |
| type | restriction of string | | |
| properties | base xs:string | | |
| facets | Kind | Value | Annotation |
| | enumeration | 0302001 | documentation Stenose |
| | enumeration | 0302002 | documentation Insuffizienz |
| | enumeration | 0302003 | documentation Stenose und Insuffizienz |
| annotation | documentation Kat_AK_GrundEingriff | | |
| source | <pre> <simpleType name="enum_0302"> <annotation> <documentation>Kat_AK_GrundEingriff</documentation> </annotation> <restriction base="xs:string"> <enumeration value="0302001"> <annotation> <documentation>Stenose</documentation> </annotation> </enumeration> <enumeration value="0302002"> <annotation> <documentation>Insuffizienz</documentation> </annotation> </enumeration> <enumeration value="0302003"> <annotation> <documentation>Stenose und Insuffizienz</documentation> </annotation> </enumeration> </restriction> </simpleType> </pre> | | |

simpleType enum_0318

| | | | |
|------------|------------------------------|--|--|
| namespace | http://xml.ir-d.de/irdsa | | |
| type | restriction of string | | |
| properties | base xs:string | | |

| facets | <table border="1"> <thead> <tr> <th>Kind</th> <th>Value</th> <th>Annotation</th> </tr> </thead> <tbody> <tr> <td>enumeration</td> <td>0318001</td> <td>documentation transapikal</td> </tr> <tr> <td>enumeration</td> <td>0318002</td> <td>documentation transaortal</td> </tr> <tr> <td>enumeration</td> <td>0318003</td> <td>documentation transfemorale</td> </tr> <tr> <td>enumeration</td> <td>0318004</td> <td>documentation transaxillär</td> </tr> <tr> <td>enumeration</td> <td>0318042</td> <td>documentation anderer Zugangsweg</td> </tr> </tbody> </table> | Kind | Value | Annotation | enumeration | 0318001 | documentation transapikal | enumeration | 0318002 | documentation transaortal | enumeration | 0318003 | documentation transfemorale | enumeration | 0318004 | documentation transaxillär | enumeration | 0318042 | documentation anderer Zugangsweg |
|-------------|---|-------------------------------------|-------|------------|-------------|---------|------------------------------|-------------|---------|------------------------------|-------------|---------|--------------------------------|-------------|---------|-------------------------------|-------------|---------|-------------------------------------|
| Kind | Value | Annotation | | | | | | | | | | | | | | | | | |
| enumeration | 0318001 | documentation transapikal | | | | | | | | | | | | | | | | | |
| enumeration | 0318002 | documentation transaortal | | | | | | | | | | | | | | | | | |
| enumeration | 0318003 | documentation transfemorale | | | | | | | | | | | | | | | | | |
| enumeration | 0318004 | documentation transaxillär | | | | | | | | | | | | | | | | | |
| enumeration | 0318042 | documentation anderer Zugangsweg | | | | | | | | | | | | | | | | | |
| annotation | documentation Kat AK ZugangKatheter | | | | | | | | | | | | | | | | | | |
| source | <pre> <simpleType name="enum_0318"> <annotation> <documentation>Kat_AK_ZugangKatheter</documentation> </annotation> <restriction base="xs:string"> <enumeration value="0318001"> <annotation> <documentation>transapikal</documentation> </annotation> </enumeration> <enumeration value="0318002"> <annotation> <documentation>transaortal</documentation> </annotation> </enumeration> <enumeration value="0318003"> <annotation> <documentation>transfemorale</documentation> </annotation> </enumeration> <enumeration value="0318004"> <annotation> <documentation>transaxillär</documentation> </annotation> </enumeration> <enumeration value="0318042"> <annotation> <documentation>anderer Zugangsweg</documentation> </annotation> </enumeration> </restriction> </simpleType> </pre> | | | | | | | | | | | | | | | | | | |

simpleType enum_0320

| namespace | http://xml.ir-d.de/irdsa | | | | | | | | | | | | |
|-------------|---|---|-------|------------|-------------|---------|---|-------------|---------|--|-------------|---------|---------------------------------------|
| type | restriction of string | | | | | | | | | | | | |
| properties | base xs:string | | | | | | | | | | | | |
| facets | <table border="1"> <thead> <tr> <th>Kind</th> <th>Value</th> <th>Annotation</th> </tr> </thead> <tbody> <tr> <td>enumeration</td> <td>0320001</td> <td>documentation konventionelle Sternotomie</td> </tr> <tr> <td>enumeration</td> <td>0320002</td> <td>documentation partielle Sternotomie</td> </tr> <tr> <td>enumeration</td> <td>0320003</td> <td>documentation parasternaler Zugang</td> </tr> </tbody> </table> | Kind | Value | Annotation | enumeration | 0320001 | documentation konventionelle Sternotomie | enumeration | 0320002 | documentation partielle Sternotomie | enumeration | 0320003 | documentation parasternaler Zugang |
| Kind | Value | Annotation | | | | | | | | | | | |
| enumeration | 0320001 | documentation konventionelle Sternotomie | | | | | | | | | | | |
| enumeration | 0320002 | documentation partielle Sternotomie | | | | | | | | | | | |
| enumeration | 0320003 | documentation parasternaler Zugang | | | | | | | | | | | |

| | |
|------------|--|
| | enumeration 0320042 documentation anderer Zugangsweg |
| annotation | documentation Kat_AK_ZugangKonventionell |
| source | <pre> <simpleType name="enum_0320"> <annotation> <documentation>Kat_AK_ZugangKonventionell</documentation> </annotation> <restriction base="xs:string"> <enumeration value="0320001"> <annotation> <documentation>konventionelle Sternotomie</documentation> </annotation> </enumeration> <enumeration value="0320002"> <annotation> <documentation>partielle Sternotomie</documentation> </annotation> </enumeration> <enumeration value="0320003"> <annotation> <documentation>parasternaler Zugang</documentation> </annotation> </enumeration> <enumeration value="0320042"> <annotation> <documentation>anderer Zugangsweg</documentation> </annotation> </enumeration> </restriction> </simpleType> </pre> |

simpleType enum_0322

| | | | |
|------------|---|---------|--|
| namespace | http://xml.ir-d.de/irdsa | | |
| type | restriction of string | | |
| properties | base xs:string | | |
| facets | Kind | Value | Annotation |
| | enumeration | 0322001 | documentation nein |
| | enumeration | 0322002 | documentation ja, diätetisch behandelt |
| | enumeration | 0322003 | documentation ja, orale Medikation |
| | enumeration | 0322004 | documentation ja, mit Insulin behandelt |
| | enumeration | 0322005 | documentation ja, unbehandelt |
| | enumeration | 0322099 | documentation unbekannt |
| annotation | documentation Kat_AK_Diabetes | | |
| source | <pre> <simpleType name="enum_0322"> <annotation> <documentation>Kat_AK_Diabetes</documentation> </annotation> <restriction base="xs:string"> </pre> | | |

| | |
|--|--|
| | <pre> <enumeration value="0322001"> <annotation> <documentation>nein</documentation> </annotation> </enumeration> <enumeration value="0322002"> <annotation> <documentation>ja, diätetisch behandelt</documentation> </annotation> </enumeration> <enumeration value="0322003"> <annotation> <documentation>ja, orale Medikation</documentation> </annotation> </enumeration> <enumeration value="0322004"> <annotation> <documentation>ja, mit Insulin behandelt</documentation> </annotation> </enumeration> <enumeration value="0322005"> <annotation> <documentation>ja, unbehandelt</documentation> </annotation> </enumeration> <enumeration value="0322099"> <annotation> <documentation>unbekannt</documentation> </annotation> </enumeration> </restriction> </simpleType> </pre> |
|--|--|

simpleType enum_0324

| | | | |
|------------|--|---------|---|
| namespace | http://xml.ir-d.de/irdsa | | |
| type | restriction of string | | |
| properties | base xs:string | | |
| facets | Kind | Value | Annotation |
| | enumeration | 0324001 | documentation (I): Beschwerdefreiheit, normale körperliche Belastbarkeit |
| | enumeration | 0324002 | documentation (II): Beschwerden bei stärkerer körperlicher Belastung |
| | enumeration | 0324003 | documentation (III): Beschwerden bei leichter körperlicher Belastung |
| | enumeration | 0324004 | documentation (IV): Beschwerden in Ruhe |
| annotation | documentation Kat_AK_NYHA | | |
| source | <pre> <simpleType name="enum_0324"> <annotation> <documentation>Kat_AK_NYHA</documentation> </annotation> <restriction base="xs:string"> <enumeration value="0324001"> <annotation> <documentation>(I): Beschwerdefreiheit, normale körperliche </pre> | | |

```

Belastbarkeit</documentation>
  </annotation>
</enumeration>
<enumeration value="0324002">
  <annotation>
    <documentation>(II): Beschwerden bei stärkerer körperlicher
Belastung</documentation>
  </annotation>
</enumeration>
<enumeration value="0324003">
  <annotation>
    <documentation>(III): Beschwerden bei leichter körperlicher
Belastung</documentation>
  </annotation>
</enumeration>
<enumeration value="0324004">
  <annotation>
    <documentation>(IV): Beschwerden in Ruhe</documentation>
  </annotation>
</enumeration>
</restriction>
</simpleType>

```

simpleType **enum_0330**

| | | | |
|------------|------------------------------|---------|--|
| namespace | http://xml.ir-d.de/irdsa | | |
| type | restriction of string | | |
| properties | base xs:string | | |
| facets | Kind | Value | Annotation |
| | enumeration | 0330001 | documentation ATS Medical |
| | enumeration | 0330002 | documentation Edwards Lifesciences |
| | enumeration | 0330003 | documentation Medtronic |
| | enumeration | 0330004 | documentation JenaValve |
| | enumeration | 0330005 | documentation Corcym |
| | enumeration | 0330006 | documentation Abbott Medical / St. Jude |
| | enumeration | 0330007 | documentation Symetis |
| | enumeration | 0330008 | documentation Direct Flow Medical |
| | enumeration | 0330009 | documentation Boston Scientific |
| | enumeration | 0330010 | documentation Artivion |
| | enumeration | 0330011 | documentation Biosensors |
| | enumeration | 0330012 | documentation LivaNova |
| | enumeration | 0330013 | documentation Meril |
| | enumeration | 0330014 | documentation nicht belegter Wert |
| | enumeration | 0330015 | documentation nicht belegter Wert |

| | |
|------------|---|
| | <p>enumeration 0330016 documentation nicht belegter Wert</p> <p>enumeration 0330017 documentation nicht belegter Wert</p> <p>enumeration 0330018 documentation nicht belegter Wert</p> <p>enumeration 0330042 documentation sonstiger Hersteller</p> |
| annotation | documentation Kat_AK_Hersteller |
| source | <pre> <simpleType name="enum_0330"> <annotation> <documentation>Kat_AK_Hersteller</documentation> </annotation> <restriction base="xs:string"> <enumeration value="0330001"> <annotation> <documentation>ATS Medical</documentation> </annotation> </enumeration> <enumeration value="0330002"> <annotation> <documentation>Edwards Lifesciences</documentation> </annotation> </enumeration> <enumeration value="0330003"> <annotation> <documentation>Medtronic</documentation> </annotation> </enumeration> <enumeration value="0330004"> <annotation> <documentation>JenaValve</documentation> </annotation> </enumeration> <enumeration value="0330005"> <annotation> <documentation>Corcym</documentation> </annotation> </enumeration> <enumeration value="0330006"> <annotation> <documentation>Abbott Medical / St. Jude</documentation> </annotation> </enumeration> <enumeration value="0330007"> <annotation> <documentation>Symetis</documentation> </annotation> </enumeration> <enumeration value="0330008"> <annotation> <documentation>Direct Flow Medical</documentation> </annotation> </enumeration> <enumeration value="0330009"> <annotation> <documentation>Boston Scientific</documentation> </annotation> </enumeration> </restriction> </simpleType> </pre> |

```

<enumeration value="0330010">
  <annotation>
    <documentation>Artivion</documentation>
  </annotation>
</enumeration>
<enumeration value="0330011">
  <annotation>
    <documentation>Biosensors</documentation>
  </annotation>
</enumeration>
<enumeration value="0330012">
  <annotation>
    <documentation>LivaNova</documentation>
  </annotation>
</enumeration>
<enumeration value="0330013">
  <annotation>
    <documentation>Meril</documentation>
  </annotation>
</enumeration>
<enumeration value="0330014">
  <annotation>
    <documentation>nicht belegter Wert</documentation>
  </annotation>
</enumeration>
<enumeration value="0330015">
  <annotation>
    <documentation>nicht belegter Wert</documentation>
  </annotation>
</enumeration>
<enumeration value="0330016">
  <annotation>
    <documentation>nicht belegter Wert</documentation>
  </annotation>
</enumeration>
<enumeration value="0330017">
  <annotation>
    <documentation>nicht belegter Wert</documentation>
  </annotation>
</enumeration>
<enumeration value="0330018">
  <annotation>
    <documentation>nicht belegter Wert</documentation>
  </annotation>
</enumeration>
<enumeration value="0330042">
  <annotation>
    <documentation>sonstiger Hersteller</documentation>
  </annotation>
</enumeration>
</restriction>
</simpleType>

```

simpleType enum_0338

| | |
|-----------|------------------------------|
| namespace | http://xml.ir-d.de/irdsa |
| type | restriction of string |

| properties | base xs:string | | | | | | | | | | | | | | | |
|-------------|--|-----------------------------|-------|------------|-------------|---------|----------------------|-------------|---------|----------------------|-------------|---------|----------------------|-------------|---------|-----------------------------|
| facets | <table border="1"> <thead> <tr> <th>Kind</th> <th>Value</th> <th>Annotation</th> </tr> </thead> <tbody> <tr> <td>enumeration</td> <td>0338001</td> <td>documentation LAD</td> </tr> <tr> <td>enumeration</td> <td>0338002</td> <td>documentation RCA</td> </tr> <tr> <td>enumeration</td> <td>0338003</td> <td>documentation RCX</td> </tr> <tr> <td>enumeration</td> <td>0338004</td> <td>documentation Hauptstamm</td> </tr> </tbody> </table> | Kind | Value | Annotation | enumeration | 0338001 | documentation LAD | enumeration | 0338002 | documentation RCA | enumeration | 0338003 | documentation RCX | enumeration | 0338004 | documentation Hauptstamm |
| Kind | Value | Annotation | | | | | | | | | | | | | | |
| enumeration | 0338001 | documentation LAD | | | | | | | | | | | | | | |
| enumeration | 0338002 | documentation RCA | | | | | | | | | | | | | | |
| enumeration | 0338003 | documentation RCX | | | | | | | | | | | | | | |
| enumeration | 0338004 | documentation Hauptstamm | | | | | | | | | | | | | | |
| annotation | documentation Kat_AK_PCIArterien | | | | | | | | | | | | | | | |
| source | <pre><simpleType name="enum_0338"> <annotation> <documentation>Kat_AK_PCIArterien</documentation> </annotation> <restriction base="xs:string"> <enumeration value="0338001"> <annotation> <documentation>LAD</documentation> </annotation> </enumeration> <enumeration value="0338002"> <annotation> <documentation>RCA</documentation> </annotation> </enumeration> <enumeration value="0338003"> <annotation> <documentation>RCX</documentation> </annotation> </enumeration> <enumeration value="0338004"> <annotation> <documentation>Hauptstamm</documentation> </annotation> </enumeration> </restriction> </simpleType></pre> | | | | | | | | | | | | | | | |

simpleType enum_0339

| namespace | http://xml.ir-d.de/irdsa | | | | | | | | | | | | |
|-------------|---|-------------------------|-------|------------|-------------|---------|----------------------|-------------|---------|---------------------|-------------|---------|-------------------------|
| type | restriction of string | | | | | | | | | | | | |
| properties | base xs:string | | | | | | | | | | | | |
| facets | <table border="1"> <thead> <tr> <th>Kind</th> <th>Value</th> <th>Annotation</th> </tr> </thead> <tbody> <tr> <td>enumeration</td> <td>0339001</td> <td>documentation TEE</td> </tr> <tr> <td>enumeration</td> <td>0339002</td> <td>documentation CT</td> </tr> <tr> <td>enumeration</td> <td>0339042</td> <td>documentation andere</td> </tr> </tbody> </table> | Kind | Value | Annotation | enumeration | 0339001 | documentation TEE | enumeration | 0339002 | documentation CT | enumeration | 0339042 | documentation andere |
| Kind | Value | Annotation | | | | | | | | | | | |
| enumeration | 0339001 | documentation TEE | | | | | | | | | | | |
| enumeration | 0339002 | documentation CT | | | | | | | | | | | |
| enumeration | 0339042 | documentation andere | | | | | | | | | | | |
| annotation | documentation Kat_AK_AnnulusMessmethode | | | | | | | | | | | | |
| source | <pre><simpleType name="enum_0339"> <annotation> <documentation>Kat_AK_AnnulusMessmethode</documentation></pre> | | | | | | | | | | | | |

| | |
|--|---|
| | <pre> </annotation> <restriction base="xs:string"> <enumeration value="0339001"> <annotation> <documentation>TEE</documentation> </annotation> </enumeration> <enumeration value="0339002"> <annotation> <documentation>CT</documentation> </annotation> </enumeration> <enumeration value="0339042"> <annotation> <documentation>andere</documentation> </annotation> </enumeration> </restriction> </simpleType> </pre> |
|--|---|

simpleType enum 0341

| | | | |
|------------|--|---------|--|
| namespace | http://xml.ir-d.de/irdsa | | |
| type | restriction of string | | |
| properties | base xs:string | | |
| facets | Kind | Value | Annotation |
| | enumeration | 0341001 | documentation intraprozedural verstorben |
| | enumeration | 0341002 | documentation Implantation von mehr als einer Prothese |
| | enumeration | 0341003 | documentation gravierende Gefäß- oder Zugangskomplikation (gemäß VARC-3) |
| | enumeration | 0341004 | documentation erforderlicher chirurgischer oder interventioneller Eingriff wegen einer Klappenfehlfunktion (gemäß VARC-3) |
| | enumeration | 0341005 | documentation >= große strukturelle kardiale Komplikation (gemäß VARC-3) |
| annotation | documentation Kat_AK_FailureGrund | | |
| source | <pre> <simpleType name="enum_0341"> <annotation> <documentation>Kat_AK_FailureGrund</documentation> </annotation> <restriction base="xs:string"> <enumeration value="0341001"> <annotation> <documentation>intraprozedural verstorben</documentation> </annotation> </enumeration> <enumeration value="0341002"> <annotation> <documentation>Implantation von mehr als einer Prothese</documentation> </annotation> </enumeration> <enumeration value="0341003"> <annotation> <documentation>gravierende Gefäß- oder Zugangskomplikation (gemäß </pre> | | |

| | |
|--|--|
| | <pre> VARC-3)</documentation> </annotation> </enumeration> <enumeration value="0341004"> <annotation> <documentation>erforderlicher chirurgischer oder interventioneller Eingriff wegen einer Klappenfehlfunktion (gemäß VARC-3)</documentation> </annotation> </enumeration> <enumeration value="0341005"> <annotation> <documentation>&gt;= große strukturelle kardiale Komplikation (gemäß VARC-3)</documentation> </annotation> </enumeration> </restriction> </simpleType> </pre> |
|--|--|

simpleType enum_0342

| | | | |
|------------|--|---------|--|
| namespace | http://xml.ir-d.de/irdsa | | |
| type | restriction of string | | |
| properties | base xs:string | | |
| facets | Kind | Value | Annotation |
| | enumeration | 0342001 | documentation Alter |
| | enumeration | 0342002 | documentation Frailty |
| | enumeration | 0342003 | documentation Hochrisiko |
| | enumeration | 0342004 | documentation Prognose-limitierende Zweiterkrankung |
| | enumeration | 0342005 | documentation Porzellan-Aorta |
| | enumeration | 0342042 | documentation Sonstige |
| annotation | documentation Kat_AK_Tavi | | |
| source | <pre> <simpleType name="enum_0342"> <annotation> <documentation>Kat_AK_Tavi</documentation> </annotation> <restriction base="xs:string"> <enumeration value="0342001"> <annotation> <documentation>Alter</documentation> </annotation> </enumeration> <enumeration value="0342002"> <annotation> <documentation>Frailty</documentation> </annotation> </enumeration> <enumeration value="0342003"> <annotation> <documentation>Hochrisiko</documentation> </annotation> </pre> | | |

```

</enumeration>
<enumeration value="0342004">
  <annotation>
    <documentation>Prognose-limitierende Zweiterkrankung</documentation>
  </annotation>
</enumeration>
<enumeration value="0342005">
  <annotation>
    <documentation>Porzellan-Aorta</documentation>
  </annotation>
</enumeration>
<enumeration value="0342042">
  <annotation>
    <documentation>Sonstige</documentation>
  </annotation>
</enumeration>
</restriction>
</simpleType>

```

simpleType enum_0343

| | | | |
|------------|------------------------------|---------|--|
| namespace | http://xml.ir-d.de/irdsa | | |
| type | restriction of string | | |
| properties | base xs:string | | |
| facets | Kind | Value | Annotation |
| | enumeration | 0343001 | documentation Device-Fehlpositionierung |
| | enumeration | 0343002 | documentation Koronarostienverschluss |
| | enumeration | 0343003 | documentation Aortendissektion |
| | enumeration | 0343004 | documentation Aortenregurgitation > = 2. Grades |
| | enumeration | 0343005 | documentation Annulus-Ruptur |
| | enumeration | 0343006 | documentation Ruptur-/Perforation einer Herzhöhle ohne Therapiebedarf |
| | enumeration | 0343007 | documentation Ruptur-/Perforation einer Herzhöhle mit Therapiebedarf |
| | enumeration | 0343008 | documentation Perikardtamponade |
| | enumeration | 0343009 | documentation kardiale Dekompensation |
| | enumeration | 0343010 | documentation Hir Embolie |
| | enumeration | 0343011 | documentation Rhythmusstörungen |
| | enumeration | 0343012 | documentation Device-Embolisation |
| | enumeration | 0343013 | documentation vaskuläre Komplikation |
| | enumeration | 0343014 | documentation Low Cardiac Output |
| | enumeration | 0343015 | documentation schwerwiegende Blutungen (intraprozedural) |
| | enumeration | 0343016 | documentation lebensbedrohliche Blutungen (intraprozedural) |
| | enumeration | 0343017 | documentation Patient verstarb im OP/Katheterlabor |
| | enumeration | 0343042 | documentation |

| | sonstige intraprozedurale Komplikationen |
|------------|---|
| annotation | documentation Kat_AK_KomplikationTyp |
| source | <pre> <simpleType name="enum_0343"> <annotation> <documentation>Kat_AK_KomplikationTyp</documentation> </annotation> <restriction base="xs:string"> <enumeration value="0343001"> <annotation> <documentation>Device-Fehlpositionierung</documentation> </annotation> </enumeration> <enumeration value="0343002"> <annotation> <documentation>Koronarostienverschluss</documentation> </annotation> </enumeration> <enumeration value="0343003"> <annotation> <documentation>Aortendissektion</documentation> </annotation> </enumeration> <enumeration value="0343004"> <annotation> <documentation>Aortenregurgitation &gt; = 2. Grades</documentation> </annotation> </enumeration> <enumeration value="0343005"> <annotation> <documentation>Annulus-Ruptur</documentation> </annotation> </enumeration> <enumeration value="0343006"> <annotation> <documentation>Ruptur-/Perforation einer Herzhöhle ohne Therapiebedarf</documentation> </annotation> </enumeration> <enumeration value="0343007"> <annotation> <documentation>Ruptur-/Perforation einer Herzhöhle mit Therapiebedarf</documentation> </annotation> </enumeration> <enumeration value="0343008"> <annotation> <documentation>Perikardtamponade</documentation> </annotation> </enumeration> <enumeration value="0343009"> <annotation> <documentation>kardiale Dekompensation</documentation> </annotation> </enumeration> <enumeration value="0343010"> <annotation> <documentation>Hirnembolie</documentation> </annotation> </enumeration> </restriction> </simpleType> </pre> |

```

</enumeration>
<enumeration value="0343011">
  <annotation>
    <documentation>Rhythmusstörungen</documentation>
  </annotation>
</enumeration>
<enumeration value="0343012">
  <annotation>
    <documentation>Device-Embolisation</documentation>
  </annotation>
</enumeration>
<enumeration value="0343013">
  <annotation>
    <documentation>vaskuläre Komplikation</documentation>
  </annotation>
</enumeration>
<enumeration value="0343014">
  <annotation>
    <documentation>Low Cardiac Output</documentation>
  </annotation>
</enumeration>
<enumeration value="0343015">
  <annotation>
    <documentation>schwerwiegende Blutungen
(intraprozedural)</documentation>
  </annotation>
</enumeration>
<enumeration value="0343016">
  <annotation>
    <documentation>lebensbedrohliche Blutungen
(intraprozedural)</documentation>
  </annotation>
</enumeration>
<enumeration value="0343017">
  <annotation>
    <documentation>Patient verstarb im OP/Katheterlabor</documentation>
  </annotation>
</enumeration>
<enumeration value="0343042">
  <annotation>
    <documentation>sonstige intraprozedurale
Komplikationen</documentation>
  </annotation>
</enumeration>
</restriction>
</simpleType>

```

simpleType enum_0346

| | | | |
|------------|------------------------------|---------|--|
| namespace | http://xml.ir-d.de/irdsa | | |
| type | restriction of string | | |
| properties | base xs:string | | |
| facets | Kind | Value | Annotation |
| | enumeration | 0346001 | documentation keine Therapie erforderlich |
| | enumeration | 0346002 | documentation medikamentös |

| | |
|------------|---|
| | enumeration 0346003 documentation IABP enumeration 0346004 documentation VAD enumeration 0346005 documentation ECMO enumeration 0346042 documentation sonstige |
| annotation | documentation Kat_AK_TherapieLCO |
| source | <pre> <simpleType name="enum_0346"> <annotation> <documentation>Kat_AK_TherapieLCO</documentation> </annotation> <restriction base="xs:string"> <enumeration value="0346001"> <annotation> <documentation>keine Therapie erforderlich</documentation> </annotation> </enumeration> <enumeration value="0346002"> <annotation> <documentation>medikamentös</documentation> </annotation> </enumeration> <enumeration value="0346003"> <annotation> <documentation>IABP</documentation> </annotation> </enumeration> <enumeration value="0346004"> <annotation> <documentation>VAD</documentation> </annotation> </enumeration> <enumeration value="0346005"> <annotation> <documentation>ECMO</documentation> </annotation> </enumeration> <enumeration value="0346042"> <annotation> <documentation>sonstige</documentation> </annotation> </enumeration> </restriction> </simpleType> </pre> |

simpleType enum_0347

| | | | |
|------------|------------------------------|---------|---------------------------------|
| namespace | http://xml.ir-d.de/irdsa | | |
| type | restriction of string | | |
| properties | base xs:string | | |
| facets | Kind | Value | Annotation |
| | enumeration | 0347001 | documentation Einzeleingriff |
| | enumeration | 0347002 | documentation |

| | |
|------------|---|
| | Kombinationseingriff mit mehreren Prozeduren |
| annotation | documentation Kat_AK_Eingriffsumfang |
| source | <pre> <simpleType name="enum_0347"> <annotation> <documentation>Kat_AK_Eingriffsumfang</documentation> </annotation> <restriction base="xs:string"> <enumeration value="0347001"> <annotation> <documentation>Einzeleingriff</documentation> </annotation> </enumeration> <enumeration value="0347002"> <annotation> <documentation>Kombinationseingriff mit mehreren Prozeduren</documentation> </annotation> </enumeration> </restriction> </simpleType> </pre> |

simpleType enum_0348

| | | | |
|------------|---|---------|---|
| namespace | http://xml.ir-d.de/irdsa | | |
| type | restriction of string | | |
| properties | base xs:string | | |
| facets | Kind | Value | Annotation |
| | enumeration | 0348001 | documentation mit HLM |
| | enumeration | 0348002 | documentation ohne HLM |
| | enumeration | 0348003 | documentation Umstieg von OP ohne HLM auf OP mit HLM |
| annotation | documentation Kat_AK_OPVorgehen | | |
| source | <pre> <simpleType name="enum_0348"> <annotation> <documentation>Kat_AK_OPVorgehen</documentation> </annotation> <restriction base="xs:string"> <enumeration value="0348001"> <annotation> <documentation>mit HLM</documentation> </annotation> </enumeration> <enumeration value="0348002"> <annotation> <documentation>ohne HLM</documentation> </annotation> </enumeration> <enumeration value="0348003"> <annotation> <documentation>Umstieg von OP ohne HLM auf OP mit HLM</documentation> </annotation> </enumeration> </restriction> </pre> | | |

| | |
|--|----------------------------------|
| | <code></simpleType></code> |
|--|----------------------------------|

simpleType enum_0350

| namespace | http://xml.ir-d.de/irdsa | | | | | | | | | | | | | | | | | | |
|-------------|--|--------------------------|-------|------------|-------------|---------|-----------------------|-------------|---------|--------------------------|-------------|---------|--------------------------|-------------|---------|--------------------------|-------------|---------|-------------------------|
| type | restriction of string | | | | | | | | | | | | | | | | | | |
| properties | base xs:string | | | | | | | | | | | | | | | | | | |
| facets | <table><thead><tr><th>Kind</th><th>Value</th><th>Annotation</th></tr></thead><tbody><tr><td>enumeration</td><td>0350001</td><td>documentation IABP</td></tr><tr><td>enumeration</td><td>0350002</td><td>documentation Impella</td></tr><tr><td>enumeration</td><td>0350003</td><td>documentation vv ECMO</td></tr><tr><td>enumeration</td><td>0350004</td><td>documentation va ECMO</td></tr><tr><td>enumeration</td><td>0350042</td><td>documentation andere</td></tr></tbody></table> | Kind | Value | Annotation | enumeration | 0350001 | documentation IABP | enumeration | 0350002 | documentation Impella | enumeration | 0350003 | documentation vv ECMO | enumeration | 0350004 | documentation va ECMO | enumeration | 0350042 | documentation andere |
| Kind | Value | Annotation | | | | | | | | | | | | | | | | | |
| enumeration | 0350001 | documentation IABP | | | | | | | | | | | | | | | | | |
| enumeration | 0350002 | documentation Impella | | | | | | | | | | | | | | | | | |
| enumeration | 0350003 | documentation vv ECMO | | | | | | | | | | | | | | | | | |
| enumeration | 0350004 | documentation va ECMO | | | | | | | | | | | | | | | | | |
| enumeration | 0350042 | documentation andere | | | | | | | | | | | | | | | | | |
| annotation | documentation Kat_AK_Methode | | | | | | | | | | | | | | | | | | |
| source | <pre><simpleType name="enum_0350"> <annotation> <documentation>Kat_AK_Methode</documentation> </annotation> <restriction base="xs:string"> <enumeration value="0350001"> <annotation> <documentation>IABP</documentation> </annotation> </enumeration> <enumeration value="0350002"> <annotation> <documentation>Impella</documentation> </annotation> </enumeration> <enumeration value="0350003"> <annotation> <documentation>vv ECMO</documentation> </annotation> </enumeration> <enumeration value="0350004"> <annotation> <documentation>va ECMO</documentation> </annotation> </enumeration> <enumeration value="0350042"> <annotation> <documentation>andere</documentation> </annotation> </enumeration> </restriction> </simpleType></pre> | | | | | | | | | | | | | | | | | | |

simpleType enum_0351

| | |
|-----------|--------------------------|
| namespace | http://xml.ir-d.de/irdsa |
|-----------|--------------------------|

| type | restriction of string | | | | | | | | | | | | | | | | | | | | | | | | | | | |
|-------------|--|---|-------|------------|-------------|---------|-----------------------|-------------|---------|-------------------------------------|-------------|---------|-------------------------------------|-------------|---------|-------------------------------------|-------------|---------|--------------------------------------|-------------|---------|--------------------------------------|-------------|---------|---|-------------|---------|--|
| properties | base xs:string | | | | | | | | | | | | | | | | | | | | | | | | | | | |
| facets | <table border="1"> <thead> <tr> <th>Kind</th> <th>Value</th> <th>Annotation</th> </tr> </thead> <tbody> <tr> <td>enumeration</td> <td>0351001</td> <td>documentation nein</td> </tr> <tr> <td>enumeration</td> <td>0351002</td> <td>documentation ja, zu Sternotomie</td> </tr> <tr> <td>enumeration</td> <td>0351003</td> <td>documentation ja, zu transapikal</td> </tr> <tr> <td>enumeration</td> <td>0351004</td> <td>documentation ja, zu transaortal</td> </tr> <tr> <td>enumeration</td> <td>0351005</td> <td>documentation ja, zu transfemoral</td> </tr> <tr> <td>enumeration</td> <td>0351006</td> <td>documentation ja, zu transaxillär</td> </tr> <tr> <td>enumeration</td> <td>0351007</td> <td>documentation ja, zu anderem endovaskulären Zugang</td> </tr> <tr> <td>enumeration</td> <td>0351042</td> <td>documentation ja, zu anderem Zugang</td> </tr> </tbody> </table> | Kind | Value | Annotation | enumeration | 0351001 | documentation nein | enumeration | 0351002 | documentation ja, zu Sternotomie | enumeration | 0351003 | documentation ja, zu transapikal | enumeration | 0351004 | documentation ja, zu transaortal | enumeration | 0351005 | documentation ja, zu transfemoral | enumeration | 0351006 | documentation ja, zu transaxillär | enumeration | 0351007 | documentation ja, zu anderem endovaskulären Zugang | enumeration | 0351042 | documentation ja, zu anderem Zugang |
| Kind | Value | Annotation | | | | | | | | | | | | | | | | | | | | | | | | | | |
| enumeration | 0351001 | documentation nein | | | | | | | | | | | | | | | | | | | | | | | | | | |
| enumeration | 0351002 | documentation ja, zu Sternotomie | | | | | | | | | | | | | | | | | | | | | | | | | | |
| enumeration | 0351003 | documentation ja, zu transapikal | | | | | | | | | | | | | | | | | | | | | | | | | | |
| enumeration | 0351004 | documentation ja, zu transaortal | | | | | | | | | | | | | | | | | | | | | | | | | | |
| enumeration | 0351005 | documentation ja, zu transfemoral | | | | | | | | | | | | | | | | | | | | | | | | | | |
| enumeration | 0351006 | documentation ja, zu transaxillär | | | | | | | | | | | | | | | | | | | | | | | | | | |
| enumeration | 0351007 | documentation ja, zu anderem endovaskulären Zugang | | | | | | | | | | | | | | | | | | | | | | | | | | |
| enumeration | 0351042 | documentation ja, zu anderem Zugang | | | | | | | | | | | | | | | | | | | | | | | | | | |
| annotation | documentation Kat_AK_Konversion | | | | | | | | | | | | | | | | | | | | | | | | | | | |
| source | <pre> <simpleType name="enum_0351"> <annotation> <documentation>Kat_AK_Konversion</documentation> </annotation> <restriction base="xs:string"> <enumeration value="0351001"> <annotation> <documentation>nein</documentation> </annotation> </enumeration> <enumeration value="0351002"> <annotation> <documentation>ja, zu Sternotomie</documentation> </annotation> </enumeration> <enumeration value="0351003"> <annotation> <documentation>ja, zu transapikal</documentation> </annotation> </enumeration> <enumeration value="0351004"> <annotation> <documentation>ja, zu transaortal</documentation> </annotation> </enumeration> <enumeration value="0351005"> <annotation> <documentation>ja, zu transfemoral</documentation> </annotation> </enumeration> <enumeration value="0351006"> <annotation> <documentation>ja, zu transaxillär</documentation> </annotation> </enumeration> <enumeration value="0351007"> <annotation> <documentation>ja, zu anderem endovaskulären Zugang</documentation> </annotation> </enumeration> </restriction> </simpleType> </pre> | | | | | | | | | | | | | | | | | | | | | | | | | | | |

| | |
|--|---|
| | <pre> </annotation> </enumeration> <enumeration value="0351042"> <annotation> <documentation>ja, zu anderem Zugang</documentation> </annotation> </enumeration> </restriction> </simpleType> </pre> |
|--|---|

simpleType enum_0352

| | | | |
|------------|---|---------|---|
| namespace | http://xml.ir-d.de/irdsa | | |
| type | restriction of string | | |
| properties | base xs:string | | |
| facets | Kind | Value | Annotation |
| | enumeration | 0352001 | documentation nein |
| | enumeration | 0352002 | documentation ja, Intubationsnarkose |
| | enumeration | 0352003 | documentation ja, Maskenbeatmung, incl. LAMA |
| | enumeration | 0352042 | documentation ja, unbekannt welche |
| annotation | documentation Kat_AK_Anaesthesie | | |
| source | <pre> <simpleType name="enum_0352"> <annotation> <documentation>Kat_AK_Anaesthesie</documentation> </annotation> <restriction base="xs:string"> <enumeration value="0352001"> <annotation> <documentation>nein</documentation> </annotation> </enumeration> <enumeration value="0352002"> <annotation> <documentation>ja, Intubationsnarkose</documentation> </annotation> </enumeration> <enumeration value="0352003"> <annotation> <documentation>ja, Maskenbeatmung, incl. LAMA</documentation> </annotation> </enumeration> <enumeration value="0352042"> <annotation> <documentation>ja, unbekannt welche</documentation> </annotation> </enumeration> </restriction> </simpleType> </pre> | | |

simpleType enum_0353

| | | | |
|------------|---|---------|-----------------------------------|
| namespace | http://xml.ir-d.de/irdsa | | |
| type | restriction of string | | |
| properties | base xs:string | | |
| facets | Kind | Value | Annotation |
| | enumeration | 0353001 | documentation keine |
| | enumeration | 0353002 | documentation leichtgradig |
| | enumeration | 0353003 | documentation mittelgradig |
| | enumeration | 0353004 | documentation hochgradig |
| | enumeration | 0353099 | documentation nicht bestimmbar |
| annotation | documentation Kat_AK_ResidualeArteninsuffizienz | | |
| source | <pre> <simpleType name="enum_0353"> <annotation> <documentation>Kat_AK_ResidualeArteninsuffizienz</documentation> </annotation> <restriction base="xs:string"> <enumeration value="0353001"> <annotation> <documentation>keine</documentation> </annotation> </enumeration> <enumeration value="0353002"> <annotation> <documentation>leichtgradig</documentation> </annotation> </enumeration> <enumeration value="0353003"> <annotation> <documentation>mittelgradig</documentation> </annotation> </enumeration> <enumeration value="0353004"> <annotation> <documentation>hochgradig</documentation> </annotation> </enumeration> <enumeration value="0353099"> <annotation> <documentation>nicht bestimmbar</documentation> </annotation> </enumeration> </restriction> </simpleType> </pre> | | |

simpleType enum_0354

| | | | |
|------------|------------------------------|--|--|
| namespace | http://xml.ir-d.de/irdsa | | |
| type | restriction of string | | |
| properties | base xs:string | | |

| facets | <table border="1"> <thead> <tr> <th>Kind</th> <th>Value</th> <th>Annotation</th> </tr> </thead> <tbody> <tr> <td>enumeration</td> <td>0354001</td> <td>documentation chirurgisch-offen</td> </tr> <tr> <td>enumeration</td> <td>0354002</td> <td>documentation Verschluss-System</td> </tr> <tr> <td>enumeration</td> <td>0354042</td> <td>documentation sonstige</td> </tr> </tbody> </table> | Kind | Value | Annotation | enumeration | 0354001 | documentation chirurgisch-offen | enumeration | 0354002 | documentation Verschluss-System | enumeration | 0354042 | documentation sonstige |
|-------------|--|------------------------------------|-------|------------|-------------|---------|------------------------------------|-------------|---------|------------------------------------|-------------|---------|---------------------------|
| Kind | Value | Annotation | | | | | | | | | | | |
| enumeration | 0354001 | documentation chirurgisch-offen | | | | | | | | | | | |
| enumeration | 0354002 | documentation Verschluss-System | | | | | | | | | | | |
| enumeration | 0354042 | documentation sonstige | | | | | | | | | | | |
| annotation | documentation Kat_AK_Zugangswegverschluss | | | | | | | | | | | | |
| source | <pre> <simpleType name="enum_0354"> <annotation> <documentation>Kat_AK_Zugangswegverschluss</documentation> </annotation> <restriction base="xs:string"> <enumeration value="0354001"> <annotation> <documentation>chirurgisch-offen</documentation> </annotation> </enumeration> <enumeration value="0354002"> <annotation> <documentation>Verschluss-System</documentation> </annotation> </enumeration> <enumeration value="0354042"> <annotation> <documentation>sonstige</documentation> </annotation> </enumeration> </restriction> </simpleType> </pre> | | | | | | | | | | | | |

simpleType enum_0357

| namespace | http://xml.ir-d.de/irdsa | | | | | | | | | | | | | | | | | | |
|-------------|---|--|-------|------------|-------------|---------|----------------------------|-------------|---------|------------------------------------|-------------|---------|------------------------------------|-------------|---------|------------------------------------|-------------|---------|--|
| type | restriction of string | | | | | | | | | | | | | | | | | | |
| properties | base xs:string | | | | | | | | | | | | | | | | | | |
| facets | <table border="1"> <thead> <tr> <th>Kind</th> <th>Value</th> <th>Annotation</th> </tr> </thead> <tbody> <tr> <td>enumeration</td> <td>0357001</td> <td>documentation keine KHK</td> </tr> <tr> <td>enumeration</td> <td>0357002</td> <td>documentation 1-Gefäßerkrankung</td> </tr> <tr> <td>enumeration</td> <td>0357003</td> <td>documentation 2-Gefäßerkrankung</td> </tr> <tr> <td>enumeration</td> <td>0357004</td> <td>documentation 3-Gefäßerkrankung</td> </tr> <tr> <td>enumeration</td> <td>0357005</td> <td>documentation keine koronare Bildgebung</td> </tr> </tbody> </table> | Kind | Value | Annotation | enumeration | 0357001 | documentation keine KHK | enumeration | 0357002 | documentation 1-Gefäßerkrankung | enumeration | 0357003 | documentation 2-Gefäßerkrankung | enumeration | 0357004 | documentation 3-Gefäßerkrankung | enumeration | 0357005 | documentation keine koronare Bildgebung |
| Kind | Value | Annotation | | | | | | | | | | | | | | | | | |
| enumeration | 0357001 | documentation keine KHK | | | | | | | | | | | | | | | | | |
| enumeration | 0357002 | documentation 1-Gefäßerkrankung | | | | | | | | | | | | | | | | | |
| enumeration | 0357003 | documentation 2-Gefäßerkrankung | | | | | | | | | | | | | | | | | |
| enumeration | 0357004 | documentation 3-Gefäßerkrankung | | | | | | | | | | | | | | | | | |
| enumeration | 0357005 | documentation keine koronare Bildgebung | | | | | | | | | | | | | | | | | |
| annotation | documentation Kat_AK_BefundBildgebung | | | | | | | | | | | | | | | | | | |
| source | <pre> <simpleType name="enum_0357"> <annotation> <documentation>Kat_AK_BefundBildgebung</documentation> </annotation> <restriction base="xs:string"> <enumeration value="0357001"> <annotation> <documentation>keine KHK</documentation> </annotation> </enumeration> </restriction> </simpleType> </pre> | | | | | | | | | | | | | | | | | | |

| | |
|--|--|
| | <pre> </annotation> </enumeration> <enumeration value="0357002"> <annotation> <documentation>1-Gefäßerkrankung</documentation> </annotation> </enumeration> <enumeration value="0357003"> <annotation> <documentation>2-Gefäßerkrankung</documentation> </annotation> </enumeration> <enumeration value="0357004"> <annotation> <documentation>3-Gefäßerkrankung</documentation> </annotation> </enumeration> <enumeration value="0357005"> <annotation> <documentation>keine koronare Bildgebung</documentation> </annotation> </enumeration> </restriction> </simpleType> </pre> |
|--|--|

simpleType enum_0358

| | | | |
|------------|--|---------|---|
| namespace | http://xml.ir-d.de/irdsa | | |
| type | restriction of string | | |
| properties | base xs:string | | |
| facets | Kind | Value | Annotation |
| | enumeration | 0358001 | documentation 0 |
| | enumeration | 0358002 | documentation 1 |
| | enumeration | 0358003 | documentation 2 |
| | enumeration | 0358004 | documentation 3 |
| | enumeration | 0358005 | documentation 4 |
| | enumeration | 0358006 | documentation 5 oder mehr |
| | enumeration | 0358098 | documentation genaue Anzahl unbekannt (aber mind. 1) |
| | enumeration | 0358099 | documentation unbekannt |
| annotation | documentation Kat_AK_AnzahlVorOP | | |
| source | <pre> <simpleType name="enum_0358"> <annotation> <documentation>Kat_AK_AnzahlVorOP</documentation> </annotation> <restriction base="xs:string"> <enumeration value="0358001"> <annotation> <documentation>0</documentation> </annotation> </pre> | | |

```

</enumeration>
<enumeration value="0358002">
  <annotation>
    <documentation>1</documentation>
  </annotation>
</enumeration>
<enumeration value="0358003">
  <annotation>
    <documentation>2</documentation>
  </annotation>
</enumeration>
<enumeration value="0358004">
  <annotation>
    <documentation>3</documentation>
  </annotation>
</enumeration>
<enumeration value="0358005">
  <annotation>
    <documentation>4</documentation>
  </annotation>
</enumeration>
<enumeration value="0358006">
  <annotation>
    <documentation>5 oder mehr</documentation>
  </annotation>
</enumeration>
<enumeration value="0358098">
  <annotation>
    <documentation>genaue Anzahl unbekannt (aber mind. 1)</documentation>
  </annotation>
</enumeration>
<enumeration value="0358099">
  <annotation>
    <documentation>unbekannt</documentation>
  </annotation>
</enumeration>
</restriction>
</simpleType>

```

simpleType enum 0359

| | | | |
|------------|---|---------|----------------------------------|
| namespace | http://xml.ir-d.de/irdsa | | |
| type | restriction of string | | |
| properties | base xs:string | | |
| facets | Kind | Value | Annotation |
| | enumeration | 0359001 | documentation nein |
| | enumeration | 0359002 | documentation ja - einseitig |
| | enumeration | 0359003 | documentation ja - beidseitig |
| | enumeration | 0359042 | documentation unbekannt |
| annotation | documentation Kat_AK_LVOT | | |
| source | <simpleType name="enum_0359"> <annotation> | | |

| | |
|--|---|
| | <pre> <documentation>Kat_AK_LVOT</documentation> </annotation> <restriction base="xs:string"> <enumeration value="0359001"> <annotation> <documentation>nein</documentation> </annotation> </enumeration> <enumeration value="0359002"> <annotation> <documentation>ja - einseitig</documentation> </annotation> </enumeration> <enumeration value="0359003"> <annotation> <documentation>ja - beidseitig</documentation> </annotation> </enumeration> <enumeration value="0359042"> <annotation> <documentation>unbekannt</documentation> </annotation> </enumeration> </restriction> </simpleType> </pre> |
|--|---|

simpleType enum_0360

| | | | |
|------------|--|---------|-------------------------------|
| namespace | http://xml.ir-d.de/irdsa | | |
| type | restriction of string | | |
| properties | base xs:string | | |
| facets | Kind | Value | Annotation |
| | enumeration | 0360001 | documentation keine |
| | enumeration | 0360002 | documentation leichtgradig |
| | enumeration | 0360003 | documentation mittelgradig |
| | enumeration | 0360004 | documentation hochgradig |
| | enumeration | 0360005 | documentation massive |
| | enumeration | 0360006 | documentation torrential |
| | enumeration | 0360099 | documentation unbekannt |
| annotation | documentation Kat_AK_TriskupidalInsuffizienz | | |
| source | <pre> <simpleType name="enum_0360"> <annotation> <documentation>Kat_AK_TriskupidalInsuffizienz</documentation> </annotation> <restriction base="xs:string"> <enumeration value="0360001"> <annotation> <documentation>keine</documentation> </annotation> </pre> | | |

```

</enumeration>
<enumeration value="0360002">
  <annotation>
    <documentation>leichtgradig</documentation>
  </annotation>
</enumeration>
<enumeration value="0360003">
  <annotation>
    <documentation>mittelgradig</documentation>
  </annotation>
</enumeration>
<enumeration value="0360004">
  <annotation>
    <documentation>hochgradig</documentation>
  </annotation>
</enumeration>
<enumeration value="0360005">
  <annotation>
    <documentation>massive</documentation>
  </annotation>
</enumeration>
<enumeration value="0360006">
  <annotation>
    <documentation>torrential</documentation>
  </annotation>
</enumeration>
<enumeration value="0360099">
  <annotation>
    <documentation>unbekannt</documentation>
  </annotation>
</enumeration>
</restriction>
</simpleType>

```

simpleType enum_0361

| | | | |
|------------|--|---------|---|
| namespace | http://xml.ir-d.de/irdsa | | |
| type | restriction of string | | |
| properties | base xs:string | | |
| facets | Kind | Value | Annotation |
| | enumeration | 0361001 | documentation nein |
| | enumeration | 0361002 | documentation ja, letzte(r) innerhalb der letzten 48 Stunden |
| | enumeration | 0361003 | documentation ja, letzte(r) innerhalb der letzten 21 Tage |
| | enumeration | 0361004 | documentation ja, letzte(r) länger als 21 Tage |
| | enumeration | 0361098 | documentation ja, letzter Zeitpunkt unbekannt |
| | enumeration | 0361099 | documentation unbekannt |
| annotation | documentation Kat_AK_SchockReanimation | | |
| source | <simpleType name="enum_0361"> <annotation> <documentation>Kat AK SchockReanimation</documentation> | | |

```

</annotation>
<restriction base="xs:string">
  <enumeration value="0361001">
    <annotation>
      <documentation>nein</documentation>
    </annotation>
  </enumeration>
  <enumeration value="0361002">
    <annotation>
      <documentation>ja, letzte(r) innerhalb der letzten 48
Stunden</documentation>
    </annotation>
  </enumeration>
  <enumeration value="0361003">
    <annotation>
      <documentation>ja, letzte(r) innerhalb der letzten 21
Tage</documentation>
    </annotation>
  </enumeration>
  <enumeration value="0361004">
    <annotation>
      <documentation>ja, letzte(r) länger als 21 Tage</documentation>
    </annotation>
  </enumeration>
  <enumeration value="0361098">
    <annotation>
      <documentation>ja, letzter Zeitpunkt unbekannt</documentation>
    </annotation>
  </enumeration>
  <enumeration value="0361099">
    <annotation>
      <documentation>unbekannt</documentation>
    </annotation>
  </enumeration>
</restriction>
</simpleType>

```

simpleType enum_0362

| | | | |
|------------|---|---------|---------------------------------------|
| namespace | http://xml.ir-d.de/irdsa | | |
| type | restriction of string | | |
| properties | base xs:string | | |
| facets | Kind | Value | Annotation |
| | enumeration | 0362001 | documentation Sinusrhythmus |
| | enumeration | 0362002 | documentation Vorhofflimmern |
| | enumeration | 0362042 | documentation anderer Herzrhythmus |
| annotation | documentation Kat_AK_Herzrhythmus | | |
| source | <pre> <simpleType name="enum_0362"> <annotation> <documentation>Kat_AK_Herzrhythmus</documentation> </annotation> <restriction base="xs:string"> <enumeration value="0362001"> </pre> | | |

| | |
|--|--|
| | <pre> <annotation> <documentation>Sinusrhythmus</documentation> </annotation> </enumeration> <enumeration value="0362002"> <annotation> <documentation>Vorhofflimmern</documentation> </annotation> </enumeration> <enumeration value="0362042"> <annotation> <documentation>anderer Herzrhythmus</documentation> </annotation> </enumeration> </restriction> </simpleType> </pre> |
|--|--|

simpleType enum_0363

| | | | |
|------------|--|---------|--------------------------------|
| namespace | http://xml.ir-d.de/irdsa | | |
| type | restriction of string | | |
| properties | base xs:string | | |
| facets | Kind | Value | Annotation |
| | enumeration | 0363001 | documentation nein |
| | enumeration | 0363002 | documentation paroxysmal |
| | enumeration | 0363003 | documentation persistierend |
| | enumeration | 0363004 | documentation permanent |
| annotation | documentation Kat_AK_Vorhofflimmern | | |
| source | <pre> <simpleType name="enum_0363"> <annotation> <documentation>Kat_AK_Vorhofflimmern</documentation> </annotation> <restriction base="xs:string"> <enumeration value="0363001"> <annotation> <documentation>nein</documentation> </annotation> </enumeration> <enumeration value="0363002"> <annotation> <documentation>paroxysmal</documentation> </annotation> </enumeration> <enumeration value="0363003"> <annotation> <documentation>persistierend</documentation> </annotation> </enumeration> <enumeration value="0363004"> <annotation> <documentation>permanent</documentation> </annotation> </enumeration> </restriction> </simpleType> </pre> | | |

| | |
|--|--|
| | <pre> </enumeration> </restriction> </simpleType> </pre> |
|--|--|

simpleType enum_0364

| | | | |
|------------|---|---------|--|
| namespace | http://xml.ir-d.de/irdsa | | |
| type | restriction of string | | |
| properties | base xs:string | | |
| facets | Kind | Value | Annotation |
| | enumeration | 0364001 | documentation nein |
| | enumeration | 0364002 | documentation Schrittmacher ohne CRT-System |
| | enumeration | 0364003 | documentation Schrittmacher mit CRT-System |
| | enumeration | 0364004 | documentation Defibrillator ohne CRT-System |
| | enumeration | 0364005 | documentation Defibrillator mit CRT-System |
| annotation | documentation Kat_AK_SchrittmacherDefi | | |
| source | <pre> <simpleType name="enum_0364"> <annotation> <documentation>Kat_AK_SchrittmacherDefi</documentation> </annotation> <restriction base="xs:string"> <enumeration value="0364001"> <annotation> <documentation>nein</documentation> </annotation> </enumeration> <enumeration value="0364002"> <annotation> <documentation>Schrittmacher ohne CRT-System</documentation> </annotation> </enumeration> <enumeration value="0364003"> <annotation> <documentation>Schrittmacher mit CRT-System</documentation> </annotation> </enumeration> <enumeration value="0364004"> <annotation> <documentation>Defibrillator ohne CRT-System</documentation> </annotation> </enumeration> <enumeration value="0364005"> <annotation> <documentation>Defibrillator mit CRT-System</documentation> </annotation> </enumeration> </restriction> </simpleType> </pre> | | |

simpleType enum_0365

| | | | |
|------------|---|---------|--------------------------------------|
| namespace | http://xml.ir-d.de/irdsa | | |
| type | restriction of string | | |
| properties | base xs:string | | |
| facets | Kind | Value | Annotation |
| | enumeration | 0365001 | documentation nein |
| | enumeration | 0365002 | documentation ja, operativ |
| | enumeration | 0365003 | documentation ja, interventionell |
| annotation | documentation Kat_AK_MyokardRevaskularisation | | |
| source | <pre> <simpleType name="enum_0365"> <annotation> <documentation>Kat_AK_MyokardRevaskularisation</documentation> </annotation> <restriction base="xs:string"> <enumeration value="0365001"> <annotation> <documentation>nein</documentation> </annotation> </enumeration> <enumeration value="0365002"> <annotation> <documentation>ja, operativ</documentation> </annotation> </enumeration> <enumeration value="0365003"> <annotation> <documentation>ja, interventionell</documentation> </annotation> </enumeration> </restriction> </simpleType> </pre> | | |

simpleType enum_0366

| | | | |
|------------|---|---------|--|
| namespace | http://xml.ir-d.de/irdsa | | |
| type | restriction of string | | |
| properties | base xs:string | | |
| facets | Kind | Value | Annotation |
| | enumeration | 0366001 | documentation nein |
| | enumeration | 0366002 | documentation ja, <= 6 Stunden |
| | enumeration | 0366003 | documentation ja, > 6 Stunden bis <= 3 Monate |
| | enumeration | 0366004 | documentation ja, > 3 Monate |
| | enumeration | 0366099 | documentation unbekannt |
| annotation | documentation Kat_AK_PCI | | |
| source | <pre> <simpleType name="enum_0366"> <annotation> </pre> | | |

```

<documentation>Kat_AK_PCI</documentation>
</annotation>
<restriction base="xs:string">
  <enumeration value="0366001">
    <annotation>
      <documentation>nein</documentation>
    </annotation>
  </enumeration>
  <enumeration value="0366002">
    <annotation>
      <documentation>ja, &lt;= 6 Stunden</documentation>
    </annotation>
  </enumeration>
  <enumeration value="0366003">
    <annotation>
      <documentation>ja, &gt; 6 Stunden bis &lt;= 3 Monate</documentation>
    </annotation>
  </enumeration>
  <enumeration value="0366004">
    <annotation>
      <documentation>ja, &gt; 3 Monate</documentation>
    </annotation>
  </enumeration>
  <enumeration value="0366099">
    <annotation>
      <documentation>unbekannt</documentation>
    </annotation>
  </enumeration>
</restriction>
</simpleType>

```

simpleType enum_0367

| | | | |
|------------|------------------------------|---------|--|
| namespace | http://xml.ir-d.de/irdsa | | |
| type | restriction of string | | |
| properties | base xs:string | | |
| facets | Kind | Value | Annotation |
| | enumeration | 0367001 | documentation keine |
| | enumeration | 0367002 | documentation Mediastinitis |
| | enumeration | 0367003 | documentation Sepsis |
| | enumeration | 0367004 | documentation broncho-pulmonale Infektion |
| | enumeration | 0367005 | documentation oto-laryngologische Infektion |
| | enumeration | 0367006 | documentation floride Endokarditis |
| | enumeration | 0367007 | documentation Peritonitis |
| | enumeration | 0367008 | documentation Wundinfektion Thorax |
| | enumeration | 0367009 | documentation Pleuraempyem |
| | enumeration | 0367010 | documentation Venenkatheterinfektion |
| | enumeration | 0367011 | documentation |

| | |
|------------|--|
| | <p>enumeration 0367012 Harnwegsinfektion documentation Wundinfektion untere Extremitäten</p> <p>enumeration 0367013 documentation HIV-Infektion</p> <p>enumeration 0367014 documentation Hepatitis B oder C</p> <p>enumeration 0367015 documentation andere Wundinfektion</p> <p>enumeration 0367042 documentation sonstige Infektion</p> |
| annotation | documentation Kat AK Infektion |
| source | <pre> <simpleType name="enum_0367"> <annotation> <documentation>Kat_AK_Infektion</documentation> </annotation> <restriction base="xs:string"> <enumeration value="0367001"> <annotation> <documentation>keine</documentation> </annotation> </enumeration> <enumeration value="0367002"> <annotation> <documentation>Mediastinitis</documentation> </annotation> </enumeration> <enumeration value="0367003"> <annotation> <documentation>Sepsis</documentation> </annotation> </enumeration> <enumeration value="0367004"> <annotation> <documentation>broncho-pulmonale Infektion</documentation> </annotation> </enumeration> <enumeration value="0367005"> <annotation> <documentation>oto-laryngologische Infektion</documentation> </annotation> </enumeration> <enumeration value="0367006"> <annotation> <documentation>floride Endokarditis</documentation> </annotation> </enumeration> <enumeration value="0367007"> <annotation> <documentation>Peritonitis</documentation> </annotation> </enumeration> <enumeration value="0367008"> <annotation> <documentation>Wundinfektion Thorax</documentation> </annotation> </enumeration> <enumeration value="0367009"> <annotation> </pre> |

```

    <documentation>Pleuraempyem</documentation>
  </annotation>
</enumeration>
<enumeration value="0367010">
  <annotation>
    <documentation>Venenkatheterinfektion</documentation>
  </annotation>
</enumeration>
<enumeration value="0367011">
  <annotation>
    <documentation>Harnwegsinfektion</documentation>
  </annotation>
</enumeration>
<enumeration value="0367012">
  <annotation>
    <documentation>Wundinfektion untere Extremitäten</documentation>
  </annotation>
</enumeration>
<enumeration value="0367013">
  <annotation>
    <documentation>HIV-Infektion</documentation>
  </annotation>
</enumeration>
<enumeration value="0367014">
  <annotation>
    <documentation>Hepatitis B oder C</documentation>
  </annotation>
</enumeration>
<enumeration value="0367015">
  <annotation>
    <documentation>andere Wundinfektion</documentation>
  </annotation>
</enumeration>
<enumeration value="0367042">
  <annotation>
    <documentation>sonstige Infektion</documentation>
  </annotation>
</enumeration>
</restriction>
</simpleType>

```

simpleType enum_0368

| | | | |
|------------|------------------------------|---------|--|
| namespace | http://xml.ir-d.de/irdsa | | |
| type | restriction of string | | |
| properties | base xs:string | | |
| facets | Kind | Value | Annotation |
| | enumeration | 0368001 | documentation nein |
| | enumeration | 0368002 | documentation ja, COPD mit Dauermedikation |
| | enumeration | 0368003 | documentation ja, COPD ohne Dauermedikation |
| | enumeration | 0368004 | documentation ja, andere Lungenerkrankungen |
| | enumeration | 0368099 | documentation unbekannt |

| | |
|------------|---|
| annotation | documentation Kat_AK_Lungenerkrankung |
| source | <pre> <simpleType name="enum_0368"> <annotation> <documentation>Kat_AK_Lungenerkrankung</documentation> </annotation> <restriction base="xs:string"> <enumeration value="0368001"> <annotation> <documentation>nein</documentation> </annotation> </enumeration> <enumeration value="0368002"> <annotation> <documentation>ja, COPD mit Dauermedikation</documentation> </annotation> </enumeration> <enumeration value="0368003"> <annotation> <documentation>ja, COPD ohne Dauermedikation</documentation> </annotation> </enumeration> <enumeration value="0368004"> <annotation> <documentation>ja, andere Lungenerkrankungen</documentation> </annotation> </enumeration> <enumeration value="0368099"> <annotation> <documentation>unbekannt</documentation> </annotation> </enumeration> </restriction> </simpleType> </pre> |

simpleType enum_0369

| | | | |
|------------|--|---------|----------------------------|
| namespace | http://xml.ir-d.de/irdsa | | |
| type | restriction of string | | |
| properties | base xs:string | | |
| facets | Kind | Value | Annotation |
| | enumeration | 0369001 | documentation nein |
| | enumeration | 0369002 | documentation akut |
| | enumeration | 0369003 | documentation chronisch |
| annotation | documentation Kat_AK_Nierenersatztherapie | | |
| source | <pre> <simpleType name="enum_0369"> <annotation> <documentation>Kat_AK_Nierenersatztherapie</documentation> </annotation> <restriction base="xs:string"> <enumeration value="0369001"> <annotation> <documentation>nein</documentation> </annotation> </enumeration> </restriction> </simpleType> </pre> | | |

| | |
|--|---|
| | <pre> </annotation> </enumeration> <enumeration value="0369002"> <annotation> <documentation>akut</documentation> </annotation> </enumeration> <enumeration value="0369003"> <annotation> <documentation>chronisch</documentation> </annotation> </enumeration> </restriction> </simpleType> </pre> |
|--|---|

simpleType enum_0370

| | | | |
|------------|---|---------|------------------------------------|
| namespace | http://xml.ir-d.de/irdsa | | |
| type | restriction of string | | |
| properties | base xs:string | | |
| facets | Kind | Value | Annotation |
| | enumeration | 0370001 | documentation Echokardiographie |
| | enumeration | 0370002 | documentation Herzkatheter |
| | enumeration | 0370042 | documentation andere |
| annotation | documentation Kat_AK_AKOEFMessmethode | | |
| source | <pre> <simpleType name="enum_0370"> <annotation> <documentation>Kat_AK_AKOEFMessmethode</documentation> </annotation> <restriction base="xs:string"> <enumeration value="0370001"> <annotation> <documentation>Echokardiographie</documentation> </annotation> </enumeration> <enumeration value="0370002"> <annotation> <documentation>Herzkatheter</documentation> </annotation> </enumeration> <enumeration value="0370042"> <annotation> <documentation>andere</documentation> </annotation> </enumeration> </restriction> </simpleType> </pre> | | |

simpleType enum_0371

| | |
|-----------|--------------------------|
| namespace | http://xml.ir-d.de/irdsa |
|-----------|--------------------------|

| | | | |
|------------|---|---------|----------------------------|
| type | restriction of string | | |
| properties | base xs:string | | |
| facets | Kind | Value | Annotation |
| | enumeration | 0371001 | documentation keine |
| | enumeration | 0371002 | documentation leicht |
| | enumeration | 0371003 | documentation mittel |
| | enumeration | 0371004 | documentation schwer |
| | enumeration | 0371099 | documentation unbekannt |
| annotation | documentation Kat_AK_Verkalkungsgrad | | |
| source | <pre> <simpleType name="enum_0371"> <annotation> <documentation>Kat_AK_Verkalkungsgrad</documentation> </annotation> <restriction base="xs:string"> <enumeration value="0371001"> <annotation> <documentation>keine</documentation> </annotation> </enumeration> <enumeration value="0371002"> <annotation> <documentation>leicht</documentation> </annotation> </enumeration> <enumeration value="0371003"> <annotation> <documentation>mittel</documentation> </annotation> </enumeration> <enumeration value="0371004"> <annotation> <documentation>schwer</documentation> </annotation> </enumeration> <enumeration value="0371099"> <annotation> <documentation>unbekannt</documentation> </annotation> </enumeration> </restriction> </simpleType> </pre> | | |

simpleType **enum_0372**

| | | | |
|------------|------------------------------|---------|-----------------------|
| namespace | http://xml.ir-d.de/irdsa | | |
| type | restriction of string | | |
| properties | base xs:string | | |
| facets | Kind | Value | Annotation |
| | enumeration | 0372001 | documentation nein |

| | |
|------------|--|
| | enumeration 0372002 documentation ja, bicuspide enumeration 0372003 documentation ja, unicuspide enumeration 0372099 documentation unbekannt |
| annotation | documentation Kat_AK_BiUnicuspideKlappe |
| source | <pre> <simpleType name="enum_0372"> <annotation> <documentation>Kat_AK_BiUnicuspideKlappe</documentation> </annotation> <restriction base="xs:string"> <enumeration value="0372001"> <annotation> <documentation>nein</documentation> </annotation> </enumeration> <enumeration value="0372002"> <annotation> <documentation>ja, bicuspide</documentation> </annotation> </enumeration> <enumeration value="0372003"> <annotation> <documentation>ja, unicuspide</documentation> </annotation> </enumeration> <enumeration value="0372099"> <annotation> <documentation>unbekannt</documentation> </annotation> </enumeration> </restriction> </simpleType> </pre> |

simpleType enum_0373

| | | | |
|------------|--|---------|-------------------------------|
| namespace | http://xml.ir-d.de/irdsa | | |
| type | restriction of string | | |
| properties | base xs:string | | |
| facets | Kind | Value | Annotation |
| | enumeration | 0373001 | documentation keine |
| | enumeration | 0373002 | documentation leichtgradig |
| | enumeration | 0373003 | documentation mittelgradig |
| | enumeration | 0373004 | documentation hochgradig |
| | enumeration | 0373099 | documentation unbekannt |
| annotation | documentation Kat_AK_Grad | | |
| source | <pre> <simpleType name="enum_0373"> <annotation> <documentation>Kat_AK_Grad</documentation> </pre> | | |

```

</annotation>
<restriction base="xs:string">
  <enumeration value="0373001">
    <annotation>
      <documentation>keine</documentation>
    </annotation>
  </enumeration>
  <enumeration value="0373002">
    <annotation>
      <documentation>leichtgradig</documentation>
    </annotation>
  </enumeration>
  <enumeration value="0373003">
    <annotation>
      <documentation>mittelgradig</documentation>
    </annotation>
  </enumeration>
  <enumeration value="0373004">
    <annotation>
      <documentation>hochgradig</documentation>
    </annotation>
  </enumeration>
  <enumeration value="0373099">
    <annotation>
      <documentation>unbekannt</documentation>
    </annotation>
  </enumeration>
</restriction>
</simpleType>

```

simpleType enum_0374

| | | | |
|------------|---|---------|--|
| namespace | http://xml.ir-d.de/irdsa | | |
| type | restriction of string | | |
| properties | base xs:string | | |
| facets | Kind | Value | Annotation |
| | enumeration | 0374001 | documentation nein |
| | enumeration | 0374002 | documentation ja, <= 6 Stunden |
| | enumeration | 0374003 | documentation ja, > 6 Stunden bis <= 24 Stunden |
| | enumeration | 0374004 | documentation ja, > 1 bis 7 Tage |
| | enumeration | 0374005 | documentation ja, > 7 bis 21 Tage |
| | enumeration | 0374006 | documentation ja, > 21 Tage |
| | enumeration | 0374099 | documentation unbekannt |
| annotation | documentation Kat_AK_InfarktAnamnese | | |
| source | <simpleType name="enum_0374"> <annotation> <documentation>Kat_AK_InfarktAnamnese</documentation> </annotation> <restriction base="xs:string"> | | |

```

<enumeration value="0374001">
  <annotation>
    <documentation>nein</documentation>
  </annotation>
</enumeration>
<enumeration value="0374002">
  <annotation>
    <documentation>ja, &lt;= 6 Stunden</documentation>
  </annotation>
</enumeration>
<enumeration value="0374003">
  <annotation>
    <documentation>ja, &gt; 6 Stunden bis &lt;= 24 Stunden</documentation>
  </annotation>
</enumeration>
<enumeration value="0374004">
  <annotation>
    <documentation>ja, &gt; 1 bis 7 Tage</documentation>
  </annotation>
</enumeration>
<enumeration value="0374005">
  <annotation>
    <documentation>ja, &gt; 7 bis 21 Tage</documentation>
  </annotation>
</enumeration>
<enumeration value="0374006">
  <annotation>
    <documentation>ja, &gt; 21 Tage</documentation>
  </annotation>
</enumeration>
<enumeration value="0374099">
  <annotation>
    <documentation>unbekannt</documentation>
  </annotation>
</enumeration>
</restriction>
</simpleType>

```

simpleType enum 0375

| | | | |
|------------|------------------------------|---------|---|
| namespace | http://xml.ir-d.de/irdsa | | |
| type | restriction of string | | |
| properties | base xs:string | | |
| facets | Kind | Value | Annotation |
| | enumeration | 0375001 | documentation keine Symptome oder Angina |
| | enumeration | 0375002 | documentation Symptome, aber keine Ischämiezeichen |
| | enumeration | 0375003 | documentation stabile Angina |
| | enumeration | 0375004 | documentation instabile Angina |
| | enumeration | 0375005 | documentation Infarkt ohne ST-Hebung (Non-STEMI) |
| | enumeration | 0375006 | documentation Infarkt mit ST-Hebung (STEMI) |
| | enumeration | 0375042 | documentation unbekannt |

| | |
|------------|--|
| annotation | documentation Kat_AK_KardialeSymptome |
| source | <pre> <simpleType name="enum_0375"> <annotation> <documentation>Kat_AK_KardialeSymptome</documentation> </annotation> <restriction base="xs:string"> <enumeration value="0375001"> <annotation> <documentation>keine Symptome oder Angina</documentation> </annotation> </enumeration> <enumeration value="0375002"> <annotation> <documentation>Symptome, aber keine Ischämiezeichen</documentation> </annotation> </enumeration> <enumeration value="0375003"> <annotation> <documentation>stabile Angina</documentation> </annotation> </enumeration> <enumeration value="0375004"> <annotation> <documentation>instabile Angina</documentation> </annotation> </enumeration> <enumeration value="0375005"> <annotation> <documentation>Infarkt ohne ST-Hebung (Non-STEMI)</documentation> </annotation> </enumeration> <enumeration value="0375006"> <annotation> <documentation>Infarkt mit ST-Hebung (STEMI)</documentation> </annotation> </enumeration> <enumeration value="0375042"> <annotation> <documentation>unbekannt</documentation> </annotation> </enumeration> </restriction> </simpleType> </pre> |

simpleType enum 0376

| | | | |
|------------|------------------------------|---------|---|
| namespace | http://xml.ir-d.de/irdsa | | |
| type | restriction of string | | |
| properties | base xs:string | | |
| facets | Kind | Value | Annotation |
| | enumeration | 0376001 | documentation nein |
| | enumeration | 0376002 | documentation ja, ZNS, zerebrovaskuläre Blutung |
| | enumeration | 0376003 | documentation ja, ZNS, zerebrovaskuläre Ischämie |

| | |
|------------|--|
| | enumeration 0376042 documentation ja, ZNS, andere |
| annotation | documentation Kat_AK_Schlaganfall |
| source | <pre> <simpleType name="enum_0376"> <annotation> <documentation>Kat_AK_Schlaganfall</documentation> </annotation> <restriction base="xs:string"> <enumeration value="0376001"> <annotation> <documentation>nein</documentation> </annotation> </enumeration> <enumeration value="0376002"> <annotation> <documentation>ja, ZNS, zerebrovaskuläre Blutung</documentation> </annotation> </enumeration> <enumeration value="0376003"> <annotation> <documentation>ja, ZNS, zerebrovaskuläre Ischämie</documentation> </annotation> </enumeration> <enumeration value="0376042"> <annotation> <documentation>ja, ZNS, andere</documentation> </annotation> </enumeration> </restriction> </simpleType> </pre> |

simpleType enum_0377

| | | | |
|------------|--|---------|--|
| namespace | http://xml.ir-d.de/irdsa | | |
| type | restriction of string | | |
| properties | base xs:string | | |
| facets | Kind | Value | Annotation |
| | enumeration | 0377001 | documentation ja, mild neurological dysfunction: NIHSS 0-5 |
| | enumeration | 0377002 | documentation ja, moderate neurological dysfunction: NIHSS 6-14 |
| | enumeration | 0377003 | documentation ja, severe neurological dysfunction: NIHSS >=15 |
| annotation | documentation Kat_AK_Nihss | | |
| source | <pre> <simpleType name="enum_0377"> <annotation> <documentation>Kat_AK_Nihss</documentation> </annotation> <restriction base="xs:string"> <enumeration value="0377001"> <annotation> <documentation>ja, mild neurological dysfunction: NIHSS 0-5</documentation> </annotation> </enumeration> </pre> | | |

| | |
|--|---|
| | <pre> <enumeration value="0377002"> <annotation> <documentation>ja, moderate neurological dysfunction: NIHSS 6-14</documentation> </annotation> </enumeration> <enumeration value="0377003"> <annotation> <documentation> ja, severe neurological dysfunction: NIHSS &gt;=15</documentation> </annotation> </enumeration> </restriction> </simpleType> </pre> |
|--|---|

simpleType enum_0378

| | | | |
|------------|---|---------|--|
| namespace | http://xml.lir-d.de/irdsa | | |
| type | restriction of string | | |
| properties | base xs:string | | |
| facets | Kind | Value | Annotation |
| | enumeration | 0378001 | documentation nein |
| | enumeration | 0378002 | documentation ja, < 48h gemäss VARC-3-Definition |
| | enumeration | 0378003 | documentation ja, >= 48h - <= 72h gemäß VARC-3-Definition |
| | enumeration | 0378004 | documentation ja, > 72 h gemäß VARC-3 Definition |
| annotation | documentation Kat_AK_Myokardinfarkt | | |
| source | <pre> <simpleType name="enum_0378"> <annotation> <documentation>Kat_AK_Myokardinfarkt</documentation> </annotation> <restriction base="xs:string"> <enumeration value="0378001"> <annotation> <documentation>nein</documentation> </annotation> </enumeration> <enumeration value="0378002"> <annotation> <documentation>ja, &lt; 48h gemäss VARC-3-Definition</documentation> </annotation> </enumeration> <enumeration value="0378003"> <annotation> <documentation>ja, &gt;= 48h - &lt;= 72h gemäß VARC-3-Definition</documentation> </annotation> </enumeration> <enumeration value="0378004"> <annotation> <documentation>ja, &gt; 72 h gemäß VARC-3 Definition</documentation> </annotation> </enumeration> </restriction> </simpleType> </pre> | | |

| | |
|--|---|
| | <pre> </restriction> </simpleType> </pre> |
|--|---|

simpleType enum_0379

| | | | |
|------------|---|---------|---|
| namespace | http://xml.ir-d.de/irdsa | | |
| type | restriction of string | | |
| properties | base xs:string | | |
| facets | Kind | Value | Annotation |
| | enumeration | 0379001 | documentation Keine gefäss- oder zugangsassoziierte Komplikationen |
| | enumeration | 0379002 | documentation Versagen des perkutanen Verschlusssystems |
| | enumeration | 0379003 | documentation Geringfügige Gefäßkomplikationen |
| | enumeration | 0379004 | documentation Erhebliche Gefäßkomplikationen |
| annotation | documentation Kat_AK_ZugangKomplikationen | | |
| source | <pre> <simpleType name="enum_0379"> <annotation> <documentation>Kat_AK_ZugangKomplikationen</documentation> </annotation> <restriction base="xs:string"> <enumeration value="0379001"> <annotation> <documentation>Keine gefäss- oder zugangsassoziierte Komplikationen</documentation> </annotation> </enumeration> <enumeration value="0379002"> <annotation> <documentation>Versagen des perkutanen Verschlusssystems</documentation> </annotation> </enumeration> <enumeration value="0379003"> <annotation> <documentation>Geringfügige Gefäßkomplikationen</documentation> </annotation> </enumeration> <enumeration value="0379004"> <annotation> <documentation>Erhebliche Gefäßkomplikationen</documentation> </annotation> </enumeration> </restriction> </simpleType> </pre> | | |

simpleType enum_0380

| | | | |
|------------|------------------------------|--|--|
| namespace | http://xml.ir-d.de/irdsa | | |
| type | restriction of string | | |
| properties | base xs:string | | |

| | | | |
|------------|---|------------------|--|
| facets | Kind enumeration | Value 0380001 | Annotation documentation nein |
| | enumeration | 0380002 | documentation ja, intraprozedural |
| | enumeration | 0380003 | documentation ja, postprozedural |
| | enumeration | 0380004 | documentation ja, Zeitpunkt nicht bekannt |
| annotation | documentation Kat_AK_Reanimation | | |
| source | <pre> <simpleType name="enum_0380"> <annotation> <documentation>Kat_AK_Reanimation</documentation> </annotation> <restriction base="xs:string"> <enumeration value="0380001"> <annotation> <documentation>nein</documentation> </annotation> </enumeration> <enumeration value="0380002"> <annotation> <documentation>ja, intraprozedural</documentation> </annotation> </enumeration> <enumeration value="0380003"> <annotation> <documentation>ja, postprozedural</documentation> </annotation> </enumeration> <enumeration value="0380004"> <annotation> <documentation>ja, Zeitpunkt nicht bekannt</documentation> </annotation> </enumeration> </restriction> </simpleType> </pre> | | |

simpleType enum_0381

| | | | |
|------------|------------------------------------|------------------|---|
| namespace | http://xml.ir-d.de/irdsa | | |
| type | restriction of string | | |
| properties | base xs:string | | |
| facets | Kind enumeration | Value 0381001 | Annotation documentation nein |
| | enumeration | 0381002 | documentation Thorakotomie/Rethorakotomie |
| | enumeration | 0381003 | documentation kathetergestützte Reintervention |
| | enumeration | 0381004 | documentation lokale Reinterventionen |
| | enumeration | 0381005 | documentation andere Reintervention |
| annotation | documentation Kat_AK_Massnahmen | | |

| | |
|--------|---|
| source | <pre> <simpleType name="enum_0381"> <annotation> <documentation>Kat_AK_Massnahmen</documentation> </annotation> <restriction base="xs:string"> <enumeration value="0381001"> <annotation> <documentation>nein</documentation> </annotation> </enumeration> <enumeration value="0381002"> <annotation> <documentation>Thorakotomie/Rethorakotomie</documentation> </annotation> </enumeration> <enumeration value="0381003"> <annotation> <documentation>kathetergestützte Reintervention</documentation> </annotation> </enumeration> <enumeration value="0381004"> <annotation> <documentation>lokale Reinterventionen</documentation> </annotation> </enumeration> <enumeration value="0381005"> <annotation> <documentation>andere Reintervention</documentation> </annotation> </enumeration> </restriction> </simpleType> </pre> |
|--------|---|

simpleType enum_0382

| | | | |
|------------|------------------------------|-----------|---|
| namespace | http://xml.ir-d.de/irdsa | | |
| type | restriction of string | | |
| properties | base | xs:string | |
| facets | Kind | Value | Annotation |
| | enumeration | 0382001 | documentation keine Rethorakotomie / kein weiterer Grund |
| | enumeration | 0382002 | documentation Blutung/Hämatom |
| | enumeration | 0382003 | documentation Low Cardiac Output |
| | enumeration | 0382004 | documentation Tamponade |
| | enumeration | 0382005 | documentation Graftprobleme, Ischämie |
| | enumeration | 0382006 | documentation Wundinfektion, Mediastinitis |
| | enumeration | 0382007 | documentation Dissektion |
| | enumeration | 0382008 | documentation Prothesendysfunktion |
| | enumeration | 0382009 | documentation instabiles Sternum |
| | enumeration | 0382010 | documentation |

| | |
|------------|--|
| | <p>enumeration 0382011 Chylothorax documentation lokale Revision im Bereich des Zugangsweges</p> <p>enumeration 0382042 documentation anderer Grund</p> |
| annotation | documentation Kat_AK_Komplikation |
| source | <pre> <simpleType name="enum_0382"> <annotation> <documentation>Kat_AK_Komplikation</documentation> </annotation> <restriction base="xs:string"> <enumeration value="0382001"> <annotation> <documentation>keine Rethorakotomie / kein weiterer Grund</documentation> </annotation> </enumeration> <enumeration value="0382002"> <annotation> <documentation>Blutung/Hämatom</documentation> </annotation> </enumeration> <enumeration value="0382003"> <annotation> <documentation>Low Cardiac Output</documentation> </annotation> </enumeration> <enumeration value="0382004"> <annotation> <documentation>Tamponade</documentation> </annotation> </enumeration> <enumeration value="0382005"> <annotation> <documentation>Graftprobleme, Ischämie</documentation> </annotation> </enumeration> <enumeration value="0382006"> <annotation> <documentation>Wundinfektion, Mediastinitis</documentation> </annotation> </enumeration> <enumeration value="0382007"> <annotation> <documentation>Dissektion</documentation> </annotation> </enumeration> <enumeration value="0382008"> <annotation> <documentation>Prothesendysfunktion</documentation> </annotation> </enumeration> <enumeration value="0382009"> <annotation> <documentation>instabiles Sternum</documentation> </annotation> </enumeration> <enumeration value="0382010"> </pre> |

| | |
|--|--|
| | <pre> <annotation> <documentation>Chylothorax</documentation> </annotation> </enumeration> <enumeration value="0382011"> <annotation> <documentation>lokale Revision im Bereich des Zugangsweges</documentation> </annotation> </enumeration> <enumeration value="0382042"> <annotation> <documentation>anderer Grund</documentation> </annotation> </enumeration> </restriction> </simpleType> </pre> |
|--|--|

simpleType enum 0383

| | | | |
|------------|---|---------|--|
| namespace | http://xml.ir-d.de/irdsa | | |
| type | restriction of string | | |
| properties | base xs:string | | |
| facets | Kind | Value | Annotation |
| | enumeration | 0383001 | documentation nein |
| | enumeration | 0383002 | documentation ja, mit forcierter Atemtherapie |
| | enumeration | 0383003 | documentation ja, Reintubation oder längerfristige Beatmung |
| | enumeration | 0383004 | documentation ja, Tracheotomie |
| annotation | documentation Kat_AK_RespiratorischeInsuffizienz | | |
| source | <pre> <simpleType name="enum_0383"> <annotation> <documentation>Kat_AK_RespiratorischeInsuffizienz</documentation> </annotation> <restriction base="xs:string"> <enumeration value="0383001"> <annotation> <documentation>nein</documentation> </annotation> </enumeration> <enumeration value="0383002"> <annotation> <documentation>ja, mit forcierter Atemtherapie</documentation> </annotation> </enumeration> <enumeration value="0383003"> <annotation> <documentation>ja, Reintubation oder längerfristige Beatmung</documentation> </annotation> </enumeration> <enumeration value="0383004"> <annotation> </pre> | | |

| | |
|--|--|
| | <pre> <documentation>ja, Tracheotomie</documentation> </annotation> </enumeration> </restriction> </simpleType> </pre> |
|--|--|

simpleType enum_0384

| | | | |
|------------|--|---------|--|
| namespace | http://xml.ir-d.de/irdsa | | |
| type | restriction of string | | |
| properties | base xs:string | | |
| facets | Kind | Value | Annotation |
| | enumeration | 0384001 | documentation keine Blutungskomplikationen |
| | enumeration | 0384002 | documentation Geringfügige Blutung (Minor Bleeding - BARC type 2 or 3a) |
| | enumeration | 0384003 | documentation Starke Blutung (Major Bleeding - BARC type 3a) |
| | enumeration | 0384004 | documentation Lebensbedrohliche Blutung (Life-threatening or disabling bleeding - BARC type 3b or 3c or type 5) |
| annotation | documentation Kat_AK_Blutungskomplikation | | |
| source | <pre> <simpleType name="enum_0384"> <annotation> <documentation>Kat_AK_Blutungskomplikation</documentation> </annotation> <restriction base="xs:string"> <enumeration value="0384001"> <annotation> <documentation>keine Blutungskomplikationen</documentation> </annotation> </enumeration> <enumeration value="0384002"> <annotation> <documentation>Geringfügige Blutung (Minor Bleeding - BARC type 2 or 3a)</documentation> </annotation> </enumeration> <enumeration value="0384003"> <annotation> <documentation>Starke Blutung (Major Bleeding - BARC type 3a)</documentation> </annotation> </enumeration> <enumeration value="0384004"> <annotation> <documentation>Lebensbedrohliche Blutung (Life-threatening or disabling bleeding - BARC type 3b or 3c or type 5)</documentation> </annotation> </enumeration> </restriction> </simpleType> </pre> | | |

simpleType enum_0385

| | | | |
|------------|---|---------|---|
| namespace | http://xml.ir-d.de/irdsa | | |
| type | restriction of string | | |
| properties | base xs:string | | |
| facets | Kind | Value | Annotation |
| | enumeration | 0385001 | documentation Sinusrhythmus |
| | enumeration | 0385002 | documentation Vorhofflimmern |
| | enumeration | 0385003 | documentation Patient verstorben (kein Herzrhythmus) |
| | enumeration | 0385042 | documentation anderer Rhythmus |
| annotation | documentation Kat_AK_HerzrhythmusEntlassung | | |
| source | <pre> <simpleType name="enum_0385"> <annotation> <documentation>Kat_AK_HerzrhythmusEntlassung</documentation> </annotation> <restriction base="xs:string"> <enumeration value="0385001"> <annotation> <documentation>Sinusrhythmus</documentation> </annotation> </enumeration> <enumeration value="0385002"> <annotation> <documentation>Vorhofflimmern</documentation> </annotation> </enumeration> <enumeration value="0385003"> <annotation> <documentation>Patient verstorben (kein Herzrhythmus)</documentation> </annotation> </enumeration> <enumeration value="0385042"> <annotation> <documentation>anderer Rhythmus</documentation> </annotation> </enumeration> </restriction> </simpleType> </pre> | | |

simpleType enum_0388

| | | | |
|------------|------------------------------|---------|--|
| namespace | http://xml.ir-d.de/irdsa | | |
| type | restriction of string | | |
| properties | base xs:string | | |
| facets | Kind | Value | Annotation |
| | enumeration | 0388001 | documentation nein |
| | enumeration | 0388002 | documentation ASS |
| | enumeration | 0388003 | documentation ADP-Rezeptor-Antagonist |
| | enumeration | 0388004 | documentation |

| | |
|------------|--|
| | <p>enumeration 0388042 Kombination ASS und ADP-Rezeptor-Antagonist documentation ja, andere</p> <p>enumeration 0388099 documentation unbekannt</p> |
| annotation | documentation Kat_AK_Plaettchenaggregationshemmer |
| source | <pre> <simpleType name="enum_0388"> <annotation> <documentation>Kat_AK_Plaettchenaggregationshemmer</documentation> </annotation> <restriction base="xs:string"> <enumeration value="0388001"> <annotation> <documentation>nein</documentation> </annotation> </enumeration> <enumeration value="0388002"> <annotation> <documentation>ASS</documentation> </annotation> </enumeration> <enumeration value="0388003"> <annotation> <documentation>ADP-Rezeptor-Antagonist</documentation> </annotation> </enumeration> <enumeration value="0388004"> <annotation> <documentation>Kombination ASS und ADP-Rezeptor-Antagonist</documentation> </annotation> </enumeration> <enumeration value="0388042"> <annotation> <documentation>ja, andere</documentation> </annotation> </enumeration> <enumeration value="0388099"> <annotation> <documentation>unbekannt</documentation> </annotation> </enumeration> </restriction> </simpleType> </pre> |

simpleType enum_0389

| | | | |
|------------|------------------------------|-----------|-----------------------------------|
| namespace | http://xml.ir-d.de/irdsa | | |
| type | restriction of string | | |
| properties | base | xs:string | |
| facets | Kind | Value | Annotation |
| | enumeration | 0389001 | documentation nein |
| | enumeration | 0389002 | documentation Cumarin-Derivate |
| | enumeration | 0389003 | documentation |

| | |
|------------|--|
| | <p>enumeration 0389004 Heparinoide documentation orale Thrombinantagonisten</p> <p>enumeration 0389005 documentation Kombination Heparinoide und Cumarin-Derivate</p> <p>enumeration 0389006 documentation Direkte orale Antikoagulantien (DOAK / NOAK)</p> <p>enumeration 0389042 documentation ja, andere</p> <p>enumeration 0389099 documentation unbekannt</p> |
| annotation | documentation Kat AK Antikoagulantien |
| source | <pre> <simpleType name="enum_0389"> <annotation> <documentation>Kat_AK_Antikoagulantien</documentation> </annotation> <restriction base="xs:string"> <enumeration value="0389001"> <annotation> <documentation>nein</documentation> </annotation> </enumeration> <enumeration value="0389002"> <annotation> <documentation>Cumarin-Derivate</documentation> </annotation> </enumeration> <enumeration value="0389003"> <annotation> <documentation>Heparinoide</documentation> </annotation> </enumeration> <enumeration value="0389004"> <annotation> <documentation>orale Thrombinantagonisten</documentation> </annotation> </enumeration> <enumeration value="0389005"> <annotation> <documentation>Kombination Heparinoide und Cumarin-Derivate</documentation> </annotation> </enumeration> <enumeration value="0389006"> <annotation> <documentation>Direkte orale Antikoagulantien (DOAK / NOAK)</documentation> </annotation> </enumeration> <enumeration value="0389042"> <annotation> <documentation>ja, andere</documentation> </annotation> </enumeration> <enumeration value="0389099"> <annotation> <documentation>unbekannt</documentation> </annotation> </enumeration> </restriction> </simpleType> </pre> |

| | |
|--|---|
| | <pre> </restriction> </simpleType> </pre> |
|--|---|

simpleType enum_0390

| | | | |
|------------|--|---------|---|
| namespace | http://xml.ir-d.de/irdsa | | |
| type | restriction of string | | |
| properties | base xs:string | | |
| facets | Kind | Value | Annotation |
| | enumeration | 0390001 | documentation biologisches Klappenmodell |
| | enumeration | 0390002 | documentation mechanisches Klappenmodell |
| annotation | documentation Kat_AK_Artikeltyp | | |
| source | <pre> <simpleType name="enum_0390"> <annotation> <documentation>Kat_AK_Artikeltyp</documentation> </annotation> <restriction base="xs:string"> <enumeration value="0390001"> <annotation> <documentation>biologisches Klappenmodell</documentation> </annotation> </enumeration> <enumeration value="0390002"> <annotation> <documentation>mechanisches Klappenmodell</documentation> </annotation> </enumeration> </restriction> </simpleType> </pre> | | |

simpleType enum_0398

| | | | |
|------------|--|---------|--|
| namespace | http://xml.ir-d.de/irdsa | | |
| type | restriction of string | | |
| properties | base xs:string | | |
| facets | Kind | Value | Annotation |
| | enumeration | 0398001 | documentation kardiovaskuläre Ursache |
| | enumeration | 0398002 | documentation nicht-kardiovaskuläre Ursache |
| | enumeration | 0398099 | documentation Todesursache unbekannt |
| annotation | documentation Kat_AK_Todesursache | | |
| source | <pre> <simpleType name="enum_0398"> <annotation> <documentation>Kat_AK_Todesursache</documentation> </annotation> <restriction base="xs:string"> <enumeration value="0398001"> <annotation> </pre> | | |

| | |
|--|--|
| | <pre> <documentation>kardiovaskuläre Ursache</documentation> </annotation> </enumeration> <enumeration value="0398002"> <annotation> <documentation>nicht-kardiovaskuläre Ursache</documentation> </annotation> </enumeration> <enumeration value="0398099"> <annotation> <documentation>Todesursache unbekannt</documentation> </annotation> </enumeration> </restriction> </simpleType> </pre> |
|--|--|

simpleType enum_0399

| | | | |
|------------|--|---------|--|
| namespace | http://xml.ir-d.de/irdsa | | |
| type | restriction of string | | |
| properties | base xs:string | | |
| facets | Kind | Value | Annotation |
| | enumeration | 0399001 | documentation Patient lebt |
| | enumeration | 0399002 | documentation Patient im Krankenhaus verstorben |
| annotation | documentation Kat_AK_Vitalstatus | | |
| source | <pre> <simpleType name="enum_0399"> <annotation> <documentation>Kat_AK_Vitalstatus</documentation> </annotation> <restriction base="xs:string"> <enumeration value="0399001"> <annotation> <documentation>Patient lebt</documentation> </annotation> </enumeration> <enumeration value="0399002"> <annotation> <documentation>Patient im Krankenhaus verstorben</documentation> </annotation> </enumeration> </restriction> </simpleType> </pre> | | |

simpleType enum_0044

| | | | |
|------------|------------------------------|---------|--|
| namespace | http://xml.ir-d.de/sak | | |
| type | restriction of string | | |
| properties | base xs:string | | |
| facets | Kind | Value | Annotation |
| | enumeration | 0044001 | documentation 1= normaler, sonst gesunder Patient |

| | |
|------------|---|
| | <p>enumeration 0044002 documentation 2= Patient mit leichter Allgemeinerkrankung</p> <p>enumeration 0044003 documentation 3= Patient mit schwerer Allgemeinerkrankung</p> <p>enumeration 0044004 documentation 4= Patient mit schwerer Allgemeinerkrankung, die eine ständige Lebensbedrohung darstellt</p> <p>enumeration 0044005 documentation 5= moribunder Patient, der ohne die Operation voraussichtlich nicht überleben wird</p> |
| annotation | documentation Kat_ASA |
| source | <pre> <simpleType name="enum_0044"> <annotation> <documentation>Kat_ASA</documentation> </annotation> <restriction base="xs:string"> <enumeration value="0044001"> <annotation> <documentation>1= normaler, sonst gesunder Patient</documentation> </annotation> </enumeration> <enumeration value="0044002"> <annotation> <documentation>2= Patient mit leichter Allgemeinerkrankung</documentation> </annotation> </enumeration> <enumeration value="0044003"> <annotation> <documentation>3= Patient mit schwerer Allgemeinerkrankung</documentation> </annotation> </enumeration> <enumeration value="0044004"> <annotation> <documentation>4= Patient mit schwerer Allgemeinerkrankung, die eine ständige Lebensbedrohung darstellt</documentation> </annotation> </enumeration> <enumeration value="0044005"> <annotation> <documentation>5= moribunder Patient, der ohne die Operation voraussichtlich nicht überleben wird</documentation> </annotation> </enumeration> </restriction> </simpleType> </pre> |

simpleType enum_0050

| | | | |
|------------|------------------------------|---------|-------------------------|
| namespace | http://xml.ir-d.de/sak | | |
| type | restriction of string | | |
| properties | base xs:string | | |
| facets | Kind | Value | Annotation |
| | enumeration | 0050001 | documentation rechts |
| | enumeration | 0050002 | documentation |

| | |
|------------|---|
| | links |
| annotation | documentation Kat_RechtsLinks |
| source | <pre> <simpleType name="enum_0050"> <annotation> <documentation>Kat_RechtsLinks</documentation> </annotation> <restriction base="xs:string"> <enumeration value="0050001"> <annotation> <documentation>rechts</documentation> </annotation> </enumeration> <enumeration value="0050002"> <annotation> <documentation>links</documentation> </annotation> </enumeration> </restriction> </simpleType> </pre> |

simpleType enum_0060

| | | | |
|------------|---|---------|-----------------------|
| namespace | http://xml.ir-d.de/sak | | |
| type | restriction of string | | |
| properties | base xs:string | | |
| facets | Kind | Value | Annotation |
| | enumeration | 0060001 | documentation ja |
| | enumeration | 0060002 | documentation nein |
| annotation | documentation Kat_JaNein | | |
| source | <pre> <simpleType name="enum_0060"> <annotation> <documentation>Kat_JaNein</documentation> </annotation> <restriction base="xs:string"> <enumeration value="0060001"> <annotation> <documentation>ja</documentation> </annotation> </enumeration> <enumeration value="0060002"> <annotation> <documentation>nein</documentation> </annotation> </enumeration> </restriction> </simpleType> </pre> | | |

simpleType enum_0061

| | |
|-----------|------------------------|
| namespace | http://xml.ir-d.de/sak |
|-----------|------------------------|

| | | | |
|------------|---|---------|----------------------------|
| type | restriction of string | | |
| properties | base xs:string | | |
| facets | Kind | Value | Annotation |
| | enumeration | 0061001 | documentation ja |
| | enumeration | 0061002 | documentation nein |
| | enumeration | 0061099 | documentation unbekannt |
| annotation | documentation Kat_JaNeinUnbekannt | | |
| source | <pre> <simpleType name="enum_0061"> <annotation> <documentation>Kat_JaNeinUnbekannt</documentation> </annotation> <restriction base="xs:string"> <enumeration value="0061001"> <annotation> <documentation>ja</documentation> </annotation> </enumeration> <enumeration value="0061002"> <annotation> <documentation>nein</documentation> </annotation> </enumeration> <enumeration value="0061099"> <annotation> <documentation>unbekannt</documentation> </annotation> </enumeration> </restriction> </simpleType> </pre> | | |

simpleType **enum_0062**

| | | | |
|------------|------------------------------|---------|----------------------------------|
| namespace | http://xml.ir-d.de/sak | | |
| type | restriction of string | | |
| properties | base xs:string | | |
| facets | Kind | Value | Annotation |
| | enumeration | 0062001 | documentation Stück |
| | enumeration | 0062002 | documentation g |
| | enumeration | 0062003 | documentation mg |
| | enumeration | 0062004 | documentation l |
| | enumeration | 0062005 | documentation ml |
| | enumeration | 0062006 | documentation cm ³ |
| | enumeration | 0062007 | documentation mm |
| | enumeration | 0062008 | documentation cm |
| | enumeration | 0062009 | documentation |

| | |
|------------|---|
| | <p>enumeration 0062010 dm documentation</p> <p>enumeration 0062042 m documentation andere</p> |
| annotation | documentation Kat_Einheit |
| source | <pre> <simpleType name="enum_0062"> <annotation> <documentation>Kat_Einheit</documentation> </annotation> <restriction base="xs:string"> <enumeration value="0062001"> <annotation> <documentation>Stück</documentation> </annotation> </enumeration> <enumeration value="0062002"> <annotation> <documentation>g</documentation> </annotation> </enumeration> <enumeration value="0062003"> <annotation> <documentation>mg</documentation> </annotation> </enumeration> <enumeration value="0062004"> <annotation> <documentation>l</documentation> </annotation> </enumeration> <enumeration value="0062005"> <annotation> <documentation>ml</documentation> </annotation> </enumeration> <enumeration value="0062006"> <annotation> <documentation>cm³</documentation> </annotation> </enumeration> <enumeration value="0062007"> <annotation> <documentation>mm</documentation> </annotation> </enumeration> <enumeration value="0062008"> <annotation> <documentation>cm</documentation> </annotation> </enumeration> <enumeration value="0062009"> <annotation> <documentation>dm</documentation> </annotation> </enumeration> <enumeration value="0062010"> <annotation> </pre> |

| | |
|--|---|
| | <pre> <documentation>m</documentation> </annotation> </enumeration> <enumeration value="0062042"> <annotation> <documentation>andere</documentation> </annotation> </enumeration> </restriction> </simpleType> </pre> |
|--|---|

simpleType enum_0065

| | | | |
|------------|--|---------|--------------------------------|
| namespace | http://xml.ir-d.de/sak | | |
| type | restriction of string | | |
| properties | base xs:string | | |
| facets | Kind | Value | Annotation |
| | enumeration | 0065001 | documentation stationär |
| | enumeration | 0065002 | documentation teilstationär |
| | enumeration | 0065003 | documentation ambulant |
| annotation | documentation Kat_ArtAufenthalt | | |
| source | <pre> <simpleType name="enum_0065"> <annotation> <documentation>Kat_ArtAufenthalt</documentation> </annotation> <restriction base="xs:string"> <enumeration value="0065001"> <annotation> <documentation>stationär</documentation> </annotation> </enumeration> <enumeration value="0065002"> <annotation> <documentation>teilstationär</documentation> </annotation> </enumeration> <enumeration value="0065003"> <annotation> <documentation>ambulant</documentation> </annotation> </enumeration> </restriction> </simpleType> </pre> | | |

simpleType enum_0067

| | | | |
|------------|------------------------------|--|--|
| namespace | http://xml.ir-d.de/sak | | |
| type | restriction of string | | |
| properties | base xs:string | | |

| facets | <table border="1"> <thead> <tr> <th>Kind</th> <th>Value</th> <th>Annotation</th> </tr> </thead> <tbody> <tr> <td>enumeration</td> <td>0067001</td> <td>documentation Implantat</td> </tr> <tr> <td>enumeration</td> <td>0067002</td> <td>documentation Explantat</td> </tr> </tbody> </table> | Kind | Value | Annotation | enumeration | 0067001 | documentation Implantat | enumeration | 0067002 | documentation Explantat |
|-------------|---|----------------------------|-------|------------|-------------|---------|----------------------------|-------------|---------|----------------------------|
| Kind | Value | Annotation | | | | | | | | |
| enumeration | 0067001 | documentation Implantat | | | | | | | | |
| enumeration | 0067002 | documentation Explantat | | | | | | | | |
| annotation | documentation Kat_ArtArtikel | | | | | | | | | |
| source | <pre><simpleType name="enum_0067"> <annotation> <documentation>Kat_ArtArtikel</documentation> </annotation> <restriction base="xs:string"> <enumeration value="0067001"> <annotation> <documentation>Implantat</documentation> </annotation> </enumeration> <enumeration value="0067002"> <annotation> <documentation>Explantat</documentation> </annotation> </enumeration> </restriction> </simpleType></pre> | | | | | | | | | |

simpleType enum_0068

| namespace | http://xml.ir-d.de/sak | | | | | | | | | | | | | | | |
|-------------|--|---------------------------------|-------|------------|-------------|---------|----------------------|-------------|---------|---------------------------------|-------------|---------|--------------------------------|-------------|---------|----------------------------|
| type | restriction of string | | | | | | | | | | | | | | | |
| properties | base xs:string | | | | | | | | | | | | | | | |
| facets | <table border="1"> <thead> <tr> <th>Kind</th> <th>Value</th> <th>Annotation</th> </tr> </thead> <tbody> <tr> <td>enumeration</td> <td>0068001</td> <td>documentation UDI</td> </tr> <tr> <td>enumeration</td> <td>0068002</td> <td>documentation Referenz (REF)</td> </tr> <tr> <td>enumeration</td> <td>0068003</td> <td>documentation Katalognummer</td> </tr> <tr> <td>enumeration</td> <td>0068042</td> <td>documentation sonstiger</td> </tr> </tbody> </table> | Kind | Value | Annotation | enumeration | 0068001 | documentation UDI | enumeration | 0068002 | documentation Referenz (REF) | enumeration | 0068003 | documentation Katalognummer | enumeration | 0068042 | documentation sonstiger |
| Kind | Value | Annotation | | | | | | | | | | | | | | |
| enumeration | 0068001 | documentation UDI | | | | | | | | | | | | | | |
| enumeration | 0068002 | documentation Referenz (REF) | | | | | | | | | | | | | | |
| enumeration | 0068003 | documentation Katalognummer | | | | | | | | | | | | | | |
| enumeration | 0068042 | documentation sonstiger | | | | | | | | | | | | | | |
| annotation | documentation Kat_KennzeichenTyp | | | | | | | | | | | | | | | |
| source | <pre><simpleType name="enum_0068"> <annotation> <documentation>Kat_KennzeichenTyp</documentation> </annotation> <restriction base="xs:string"> <enumeration value="0068001"> <annotation> <documentation>UDI</documentation> </annotation> </enumeration> <enumeration value="0068002"> <annotation> <documentation>Referenz (REF)</documentation> </annotation> </enumeration> <enumeration value="0068003"> </pre> | | | | | | | | | | | | | | | |

| | |
|--|---|
| | <pre> <annotation> <documentation>Katalognummer</documentation> </annotation> </enumeration> <enumeration value="0068042"> <annotation> <documentation>sonstiger</documentation> </annotation> </enumeration> </restriction> </simpleType> </pre> |
|--|---|

simpleType enum_0069

| | | | |
|------------|--|---------|----------------------------|
| namespace | http://xml.ir-d.de/sak | | |
| type | restriction of string | | |
| properties | base xs:string | | |
| facets | Kind | Value | Annotation |
| | enumeration | 0069001 | documentation Implantat |
| | enumeration | 0069002 | documentation Explantat |
| annotation | documentation Kat_ArtZubehoer | | |
| source | <pre> <simpleType name="enum_0069"> <annotation> <documentation>Kat_ArtZubehoer</documentation> </annotation> <restriction base="xs:string"> <enumeration value="0069001"> <annotation> <documentation>Implantat</documentation> </annotation> </enumeration> <enumeration value="0069002"> <annotation> <documentation>Explantat</documentation> </annotation> </enumeration> </restriction> </simpleType> </pre> | | |

simpleType enum_0070

| | | | |
|------------|------------------------------|---------|---------------------------|
| namespace | http://xml.ir-d.de/sak | | |
| type | restriction of string | | |
| properties | base xs:string | | |
| facets | Kind | Value | Annotation |
| | enumeration | 0070001 | documentation weiblich |
| | enumeration | 0070002 | documentation männlich |
| | enumeration | 0070003 | documentation divers |
| | enumeration | 0070042 | documentation |

| | |
|------------|---|
| | unbestimmt |
| annotation | documentation Kat Geschlecht |
| source | <pre> <simpleType name="enum_0070"> <annotation> <documentation>Kat_Geschlecht</documentation> </annotation> <restriction base="xs:string"> <enumeration value="0070001"> <annotation> <documentation>weiblich</documentation> </annotation> </enumeration> <enumeration value="0070002"> <annotation> <documentation>männlich</documentation> </annotation> </enumeration> <enumeration value="0070003"> <annotation> <documentation>divers</documentation> </annotation> </enumeration> <enumeration value="0070042"> <annotation> <documentation>unbestimmt</documentation> </annotation> </enumeration> </restriction> </simpleType> </pre> |

simpleType enum_0071

| | | | |
|------------|--|---------|---|
| namespace | http://xml.ir-d.de/sak | | |
| type | restriction of string | | |
| properties | base xs:string | | |
| facets | Kind | Value | Annotation |
| | enumeration | 0071001 | documentation Implantat |
| | enumeration | 0071002 | documentation Explantat |
| | enumeration | 0071003 | documentation Degeneriertes/defektes Produkt, das funktionslos im Körper verbleibt |
| annotation | documentation Kat_ArtikelArtFunktion | | |
| source | <pre> <simpleType name="enum_0071"> <annotation> <documentation>Kat_ArtikelArtFunktion</documentation> </annotation> <restriction base="xs:string"> <enumeration value="0071001"> <annotation> <documentation>Implantat</documentation> </annotation> </enumeration> <enumeration value="0071002"> <annotation> </pre> | | |

| | |
|--|---|
| | <pre> <documentation>Explantat</documentation> </annotation> </enumeration> <enumeration value="0071003"> <annotation> <documentation>Degeneriertes/defektes Produkt, das funktionslos im Körper verbleibt</documentation> </annotation> </enumeration> </restriction> </simpleType> </pre> |
|--|---|

simpleType enum_0075

| | | | |
|------------|---|---------|----------------------------|
| namespace | http://xml.ir-d.de/sak | | |
| type | restriction of string | | |
| properties | base xs:string | | |
| facets | Kind | Value | Annotation |
| | enumeration | 0075001 | documentation elektiv |
| | enumeration | 0075002 | documentation dringlich |
| | enumeration | 0075003 | documentation Notfall |
| annotation | documentation Kat_Dringlichkeit | | |
| source | <pre> <simpleType name="enum_0075"> <annotation> <documentation>Kat_Dringlichkeit</documentation> </annotation> <restriction base="xs:string"> <enumeration value="0075001"> <annotation> <documentation>elektiv</documentation> </annotation> </enumeration> <enumeration value="0075002"> <annotation> <documentation>dringlich</documentation> </annotation> </enumeration> <enumeration value="0075003"> <annotation> <documentation>Notfall</documentation> </annotation> </enumeration> </restriction> </simpleType> </pre> | | |

simpleType enum_0076

| | | | |
|------------|------------------------------|--|--|
| namespace | http://xml.ir-d.de/sak | | |
| type | restriction of string | | |
| properties | base xs:string | | |

| facets | <table border="1"> <thead> <tr> <th>Kind</th> <th>Value</th> <th>Annotation</th> </tr> </thead> <tbody> <tr> <td>enumeration</td> <td>0076001</td> <td>documentation elektiv</td> </tr> <tr> <td>enumeration</td> <td>0076002</td> <td>documentation dringlich</td> </tr> <tr> <td>enumeration</td> <td>0076003</td> <td>documentation Notfall</td> </tr> <tr> <td>enumeration</td> <td>0076004</td> <td>documentation Notfall (Reanimation / ultima ratio)</td> </tr> </tbody> </table> | Kind | Value | Annotation | enumeration | 0076001 | documentation elektiv | enumeration | 0076002 | documentation dringlich | enumeration | 0076003 | documentation Notfall | enumeration | 0076004 | documentation Notfall (Reanimation / ultima ratio) |
|-------------|---|---|-------|------------|-------------|---------|--------------------------|-------------|---------|----------------------------|-------------|---------|--------------------------|-------------|---------|---|
| Kind | Value | Annotation | | | | | | | | | | | | | | |
| enumeration | 0076001 | documentation elektiv | | | | | | | | | | | | | | |
| enumeration | 0076002 | documentation dringlich | | | | | | | | | | | | | | |
| enumeration | 0076003 | documentation Notfall | | | | | | | | | | | | | | |
| enumeration | 0076004 | documentation Notfall (Reanimation / ultima ratio) | | | | | | | | | | | | | | |
| annotation | documentation Kat_Dringlichkeit_Reanimation | | | | | | | | | | | | | | | |
| source | <pre> <simpleType name="enum_0076"> <annotation> <documentation>Kat_Dringlichkeit_Reanimation</documentation> </annotation> <restriction base="xs:string"> <enumeration value="0076001"> <annotation> <documentation>elektiv</documentation> </annotation> </enumeration> <enumeration value="0076002"> <annotation> <documentation>dringlich</documentation> </annotation> </enumeration> <enumeration value="0076003"> <annotation> <documentation>Notfall</documentation> </annotation> </enumeration> <enumeration value="0076004"> <annotation> <documentation>Notfall (Reanimation / ultima ratio)</documentation> </annotation> </enumeration> </restriction> </simpleType> </pre> | | | | | | | | | | | | | | | |

simpleType enum_0080

| namespace | http://xml.ir-d.de/sak | | | | | | | | | | | | |
|-------------|--|--|-------|------------|-------------|---------|--|-------------|---------|---------------------------------|-------------|---------|--|
| type | restriction of string | | | | | | | | | | | | |
| properties | base xs:string | | | | | | | | | | | | |
| facets | <table border="1"> <thead> <tr> <th>Kind</th> <th>Value</th> <th>Annotation</th> </tr> </thead> <tbody> <tr> <td>enumeration</td> <td>0080001</td> <td>documentation Endoprothese Hüfte/Knie</td> </tr> <tr> <td>enumeration</td> <td>0080002</td> <td>documentation Brustimplantat</td> </tr> <tr> <td>enumeration</td> <td>0080003</td> <td>documentation Aortenklappenprothese</td> </tr> </tbody> </table> | Kind | Value | Annotation | enumeration | 0080001 | documentation Endoprothese Hüfte/Knie | enumeration | 0080002 | documentation Brustimplantat | enumeration | 0080003 | documentation Aortenklappenprothese |
| Kind | Value | Annotation | | | | | | | | | | | |
| enumeration | 0080001 | documentation Endoprothese Hüfte/Knie | | | | | | | | | | | |
| enumeration | 0080002 | documentation Brustimplantat | | | | | | | | | | | |
| enumeration | 0080003 | documentation Aortenklappenprothese | | | | | | | | | | | |
| annotation | documentation Kat_Implantattyp | | | | | | | | | | | | |
| source | <pre> <simpleType name="enum_0080"> <annotation> <documentation>Kat_Implantattyp</documentation> </annotation> </pre> | | | | | | | | | | | | |

| | |
|--|--|
| | <pre> <restriction base="xs:string"> <enumeration value="0080001"> <annotation> <documentation>Endoprothese Hüfte/Knie</documentation> </annotation> </enumeration> <enumeration value="0080002"> <annotation> <documentation>Brustimplantat</documentation> </annotation> </enumeration> <enumeration value="0080003"> <annotation> <documentation>Aortenklappenprothese</documentation> </annotation> </enumeration> </restriction> </simpleType> </pre> |
|--|--|

simpleType enum_0100

| | | | |
|------------|---|---------|--|
| namespace | http://xml.ir-d.de/sak | | |
| type | restriction of string | | |
| properties | base xs:string | | |
| facets | Kind | Value | Annotation |
| | enumeration | 0100001 | documentation Primäreingriff |
| | enumeration | 0100002 | documentation Austausch Expander gegen dauerhaftes Brustimplantat |
| | enumeration | 0100003 | documentation Revision |
| | enumeration | 0100004 | documentation Nur Explantation |
| annotation | documentation Kat_BI_ArtEingriff | | |
| source | <pre> <simpleType name="enum_0100"> <annotation> <documentation>Kat_BI_ArtEingriff</documentation> </annotation> <restriction base="xs:string"> <enumeration value="0100001"> <annotation> <documentation>Primäreingriff</documentation> </annotation> </enumeration> <enumeration value="0100002"> <annotation> <documentation>Austausch Expander gegen dauerhaftes Brustimplantat</documentation> </annotation> </enumeration> <enumeration value="0100003"> <annotation> <documentation>Revision</documentation> </annotation> </enumeration> <enumeration value="0100004"> </pre> | | |

| | |
|--|---|
| | <pre> <annotation> <documentation>Nur Explantation</documentation> </annotation> </enumeration> </restriction> </simpleType> </pre> |
|--|---|

simpleType enum_0102

| | | | |
|------------|--|---------|---|
| namespace | http://xml.ir-d.de/sak | | |
| type | restriction of string | | |
| properties | base xs:string | | |
| facets | Kind | Value | Annotation |
| | enumeration | 0102001 | documentation kosmetische Augmentation |
| | enumeration | 0102002 | documentation Rekonstruktion, benigne |
| | enumeration | 0102003 | documentation Rekonstruktion nach Mastektomie aufgrund eines Karzinoms |
| | enumeration | 0102004 | documentation Rekonstruktion nach risikoreduzierender Mastektomie |
| annotation | documentation Kat_BI_GrundPrimaereingriff | | |
| source | <pre> <simpleType name="enum_0102"> <annotation> <documentation>Kat_BI_GrundPrimaereingriff</documentation> </annotation> <restriction base="xs:string"> <enumeration value="0102001"> <annotation> <documentation>kosmetische Augmentation</documentation> </annotation> </enumeration> <enumeration value="0102002"> <annotation> <documentation>Rekonstruktion, benigne</documentation> </annotation> </enumeration> <enumeration value="0102003"> <annotation> <documentation>Rekonstruktion nach Mastektomie aufgrund eines Karzinoms</documentation> </annotation> </enumeration> <enumeration value="0102004"> <annotation> <documentation>Rekonstruktion nach risikoreduzierender Mastektomie</documentation> </annotation> </enumeration> </restriction> </simpleType> </pre> | | |

simpleType enum_0103

| | | | |
|------------|--|---------|---|
| namespace | http://xml.ir-d.de/sak | | |
| type | restriction of string | | |
| properties | base xs:string | | |
| facets | Kind | Value | Annotation |
| | enumeration | 0103001 | documentation simultane Lappendeckung |
| | enumeration | 0103002 | documentation simultane Eigenfetttransplantation |
| | enumeration | 0103003 | documentation simultane Mastopexie |
| | enumeration | 0103005 | documentation simultane Mastektomie, Ablatio / hautsparend |
| | enumeration | 0103006 | documentation simultane Mastektomie, nippelerhaltend |
| | enumeration | 0103007 | documentation Axilla-Dissektion |
| | enumeration | 0103008 | documentation Drainage |
| annotation | documentation Kat_BI_OperationsdetailPrimaereingriff | | |
| source | <pre> <simpleType name="enum_0103"> <annotation> <documentation>Kat_BI_OperationsdetailPrimaereingriff</documentation> </annotation> <restriction base="xs:string"> <enumeration value="0103001"> <annotation> <documentation>simultane Lappendeckung</documentation> </annotation> </enumeration> <enumeration value="0103002"> <annotation> <documentation>simultane Eigenfetttransplantation</documentation> </annotation> </enumeration> <enumeration value="0103003"> <annotation> <documentation>simultane Mastopexie</documentation> </annotation> </enumeration> <enumeration value="0103005"> <annotation> <documentation>simultane Mastektomie, Ablatio / hautsparend</documentation> </annotation> </enumeration> <enumeration value="0103006"> <annotation> <documentation>simultane Mastektomie, nippelerhaltend</documentation> </annotation> </enumeration> <enumeration value="0103007"> <annotation> <documentation>Axilla-Dissektion</documentation> </annotation> </enumeration> <enumeration value="0103008"> </pre> | | |

| | |
|--|---|
| | <pre> <annotation> <documentation>Drainage</documentation> </annotation> </enumeration> </restriction> </simpleType> </pre> |
|--|---|

simpleType enum_0104

| | | | |
|------------|---|---------|--|
| namespace | http://xml.ir-d.de/sak | | |
| type | restriction of string | | |
| properties | base xs:string | | |
| facets | Kind | Value | Annotation |
| | enumeration | 0104001 | documentation Austausch Expander gegen dauerhaftes Brustimplantat |
| annotation | documentation Kat_BI_GrundAustausch | | |
| source | <pre> <simpleType name="enum_0104"> <annotation> <documentation>Kat_BI_GrundAustausch</documentation> </annotation> <restriction base="xs:string"> <enumeration value="0104001"> <annotation> <documentation>Austausch Expander gegen dauerhaftes Brustimplantat</documentation> </annotation> </enumeration> </restriction> </simpleType> </pre> | | |

simpleType enum_0105

| | | | |
|------------|---|---------|---|
| namespace | http://xml.ir-d.de/sak | | |
| type | restriction of string | | |
| properties | base xs:string | | |
| facets | Kind | Value | Annotation |
| | enumeration | 0105001 | documentation simultane Lappendeckung |
| | enumeration | 0105002 | documentation simultane Eigenfetttransplantation |
| | enumeration | 0105003 | documentation simultane Mastopexie |
| | enumeration | 0105008 | documentation Drainage |
| | enumeration | 0105009 | documentation Kapsulektomie, komplett |
| | enumeration | 0105010 | documentation Kapsulektomie, partiell |
| | enumeration | 0105011 | documentation Neopocket |
| annotation | documentation Kat_BI_OperationsdetailAustausch | | |
| source | <pre> <simpleType name="enum_0105"> <annotation> </pre> | | |

```

<documentation>Kat_BI_OperationsdetailAustausch</documentation>
</annotation>
<restriction base="xs:string">
  <enumeration value="0105001">
    <annotation>
      <documentation>simultane Lappendeckung</documentation>
    </annotation>
  </enumeration>
  <enumeration value="0105002">
    <annotation>
      <documentation>simultane Eigenfetttransplantation</documentation>
    </annotation>
  </enumeration>
  <enumeration value="0105003">
    <annotation>
      <documentation>simultane Mastopexie</documentation>
    </annotation>
  </enumeration>
  <enumeration value="0105008">
    <annotation>
      <documentation>Drainage</documentation>
    </annotation>
  </enumeration>
  <enumeration value="0105009">
    <annotation>
      <documentation>Kapsulektomie, komplett</documentation>
    </annotation>
  </enumeration>
  <enumeration value="0105010">
    <annotation>
      <documentation>Kapsulektomie, partiell</documentation>
    </annotation>
  </enumeration>
  <enumeration value="0105011">
    <annotation>
      <documentation>Neopocket</documentation>
    </annotation>
  </enumeration>
</restriction>
</simpleType>

```

simpleType enum_0106

| | | | |
|------------|---|---------|----------------------------------|
| namespace | http://xml.ir-d.de/sak | | |
| type | restriction of string | | |
| properties | base xs:string | | |
| facets | Kind | Value | Annotation |
| | enumeration | 0106001 | documentation Patientenwunsch |
| | enumeration | 0106002 | documentation asymptomatisch |
| | enumeration | 0106003 | documentation Komplikation |
| annotation | documentation Kat_BI_GrundRevisionExplantation | | |
| source | <simpleType name="enum_0106"> <annotation> | | |

| | |
|--|---|
| | <pre> <documentation>Kat_BI_GrundRevisionExplantation</documentation> </annotation> <restriction base="xs:string"> <enumeration value="0106001"> <annotation> <documentation>Patientenwunsch</documentation> </annotation> </enumeration> <enumeration value="0106002"> <annotation> <documentation>asymptomatisch</documentation> </annotation> </enumeration> <enumeration value="0106003"> <annotation> <documentation>Komplikation</documentation> </annotation> </enumeration> </restriction> </simpleType> </pre> |
|--|---|

simpleType enum_0107

| | | | |
|------------|---|---------|---|
| namespace | http://xml.ir-d.de/sak | | |
| type | restriction of string | | |
| properties | base xs:string | | |
| facets | Kind | Value | Annotation |
| | enumeration | 0107001 | documentation simultane Lappendeckung |
| | enumeration | 0107002 | documentation simultane Eigenfettransplantation |
| | enumeration | 0107003 | documentation simultane Mastopexie |
| | enumeration | 0107005 | documentation simultane Mastektomie, Ablatio / hautsparend |
| | enumeration | 0107006 | documentation simultane Mastektomie, nippelerhaltend |
| | enumeration | 0107007 | documentation Axilla-Dissektion |
| | enumeration | 0107008 | documentation Drainage |
| | enumeration | 0107009 | documentation Kapsulektomie, komplett |
| | enumeration | 0107010 | documentation Kapsulektomie, partiell |
| | enumeration | 0107011 | documentation Neopocket |
| annotation | documentation Kat_BI_OperationsdetailRevision | | |
| source | <pre> <simpleType name="enum_0107"> <annotation> <documentation>Kat_BI_OperationsdetailRevision</documentation> </annotation> <restriction base="xs:string"> <enumeration value="0107001"> <annotation> <documentation>simultane Lappendeckung</documentation> </annotation> </pre> | | |

```

</enumeration>
<enumeration value="0107002">
  <annotation>
    <documentation>simultane Eigenfetttransplantation</documentation>
  </annotation>
</enumeration>
<enumeration value="0107003">
  <annotation>
    <documentation>simultane Mastopexie</documentation>
  </annotation>
</enumeration>
<enumeration value="0107005">
  <annotation>
    <documentation>simultane Mastektomie, Ablatio /
hautsparend</documentation>
  </annotation>
</enumeration>
<enumeration value="0107006">
  <annotation>
    <documentation>simultane Mastektomie, nippelerhaltend</documentation>
  </annotation>
</enumeration>
<enumeration value="0107007">
  <annotation>
    <documentation>Axilla-Dissektion</documentation>
  </annotation>
</enumeration>
<enumeration value="0107008">
  <annotation>
    <documentation>Drainage</documentation>
  </annotation>
</enumeration>
<enumeration value="0107009">
  <annotation>
    <documentation>Kapsulektomie, komplett</documentation>
  </annotation>
</enumeration>
<enumeration value="0107010">
  <annotation>
    <documentation>Kapsulektomie, partiell</documentation>
  </annotation>
</enumeration>
<enumeration value="0107011">
  <annotation>
    <documentation>Neopocket</documentation>
  </annotation>
</enumeration>
</restriction>
</simpleType>

```

simpleType enum_0110

| | |
|------------|------------------------------|
| namespace | http://xml.ir-d.de/sak |
| type | restriction of string |
| properties | base xs:string |
| facets | Kind Value Annotation |

| | |
|------------|--|
| | enumeration 011001 documentation Bestrahlung |
| annotation | documentation Kat_BI_VorbehandlungLokal |
| source | <pre> <simpleType name="enum_0110"> <annotation> <documentation>Kat_BI_VorbehandlungLokal</documentation> </annotation> <restriction base="xs:string"> <enumeration value="011001"> <annotation> <documentation>Bestrahlung</documentation> </annotation> </enumeration> </restriction> </simpleType> </pre> |

simpleType enum_0111

| | | | |
|------------|---|---------|--|
| namespace | http://xml.ir-d.de/sak | | |
| type | restriction of string | | |
| properties | base xs:string | | |
| facets | Kind | Value | Annotation |
| | enumeration | 0111001 | documentation nein |
| | enumeration | 0111002 | documentation Lipofilling |
| | enumeration | 0111003 | documentation Eigengewebsrekonstruktion |
| annotation | documentation Kat_BI_Verfahrenswechsel | | |
| source | <pre> <simpleType name="enum_0111"> <annotation> <documentation>Kat_BI_Verfahrenswechsel</documentation> </annotation> <restriction base="xs:string"> <enumeration value="0111001"> <annotation> <documentation>nein</documentation> </annotation> </enumeration> <enumeration value="0111002"> <annotation> <documentation>Lipofilling</documentation> </annotation> </enumeration> <enumeration value="0111003"> <annotation> <documentation>Eigengewebsrekonstruktion</documentation> </annotation> </enumeration> </restriction> </simpleType> </pre> | | |

simpleType enum_0112

| | | | |
|------------|--|---------|---|
| namespace | http://xml.ir-d.de/sak | | |
| type | restriction of string | | |
| properties | base xs:string | | |
| facets | Kind | Value | Annotation |
| | enumeration | 0112001 | documentation subglandulär / epipektoral |
| | enumeration | 0112002 | documentation subpektoral |
| | enumeration | 0112003 | documentation subfaszial |
| | enumeration | 0112004 | documentation sub-flap |
| | enumeration | 0112005 | documentation subkutan |
| | enumeration | 0112006 | documentation dual plane |
| | enumeration | 0112042 | documentation andere |
| annotation | documentation Kat_BI_LageImplantat | | |
| source | <pre> <simpleType name="enum_0112"> <annotation> <documentation>Kat_BI_LageImplantat</documentation> </annotation> <restriction base="xs:string"> <enumeration value="0112001"> <annotation> <documentation>subglandulär / epipektoral</documentation> </annotation> </enumeration> <enumeration value="0112002"> <annotation> <documentation>subpektoral</documentation> </annotation> </enumeration> <enumeration value="0112003"> <annotation> <documentation>subfaszial</documentation> </annotation> </enumeration> <enumeration value="0112004"> <annotation> <documentation>sub-flap</documentation> </annotation> </enumeration> <enumeration value="0112005"> <annotation> <documentation>subkutan</documentation> </annotation> </enumeration> <enumeration value="0112006"> <annotation> <documentation>dual plane</documentation> </annotation> </enumeration> <enumeration value="0112042"> <annotation> </pre> | | |

| | |
|--|--|
| | <pre> <documentation>andere</documentation> </annotation> </enumeration> </restriction> </simpleType> </pre> |
|--|--|

simpleType enum_0113

| | | | |
|------------|--|---------|--|
| namespace | http://xml.ir-d.de/sak | | |
| type | restriction of string | | |
| properties | base xs:string | | |
| facets | Kind | Value | Annotation |
| | enumeration | 0113001 | documentation Chemotherapie innerhalb der letzten drei Monate |
| annotation | documentation Kat_BI_VorbehandlungSystemisch | | |
| source | <pre> <simpleType name="enum_0113"> <annotation> <documentation>Kat_BI_VorbehandlungSystemisch</documentation> </annotation> <restriction base="xs:string"> <enumeration value="0113001"> <annotation> <documentation>Chemotherapie innerhalb der letzten drei Monate</documentation> </annotation> </enumeration> </restriction> </simpleType> </pre> | | |

simpleType enum_0114

| | | | |
|------------|--|---------|----------------------------------|
| namespace | http://xml.ir-d.de/sak | | |
| type | restriction of string | | |
| properties | base xs:string | | |
| facets | Kind | Value | Annotation |
| | enumeration | 0114001 | documentation vollständig |
| | enumeration | 0114002 | documentation nein |
| | enumeration | 0114003 | documentation teilweise |
| | enumeration | 0114004 | documentation nicht vorhanden |
| annotation | documentation Kat_BI_EntfernungADMNetz | | |
| source | <pre> <simpleType name="enum_0114"> <annotation> <documentation>Kat_BI_EntfernungADMNetz</documentation> </annotation> <restriction base="xs:string"> <enumeration value="0114001"> <annotation> <documentation>vollständig</documentation> </pre> | | |

| | |
|--|--|
| | <pre> </annotation> </enumeration> <enumeration value="0114002"> <annotation> <documentation>nein</documentation> </annotation> </enumeration> <enumeration value="0114003"> <annotation> <documentation>teilweise</documentation> </annotation> </enumeration> <enumeration value="0114004"> <annotation> <documentation>nicht vorhanden</documentation> </annotation> </enumeration> </restriction> </simpleType> </pre> |
|--|--|

simpleType enum_0116

| | | | |
|------------|---|---------|--|
| namespace | http://xml.ir-d.de/sak | | |
| type | restriction of string | | |
| properties | base xs:string | | |
| facets | Kind | Value | Annotation |
| | enumeration | 0116001 | documentation Spülung, antibiotisch |
| | enumeration | 0116002 | documentation Spülung, antiseptisch |
| | enumeration | 0116003 | documentation Spülung, wirkstofffrei |
| | enumeration | 0116004 | documentation Spülung, andere |
| | enumeration | 0116005 | documentation prä-/perioperative Antibiotika |
| | enumeration | 0116006 | documentation postoperative Antibiotika |
| | enumeration | 0116007 | documentation Handschuhwechsel vor Implantation |
| | enumeration | 0116008 | documentation Implantationshilfe |
| annotation | documentation Kat_BI_Operationsmassnahme | | |
| source | <pre> <simpleType name="enum_0116"> <annotation> <documentation>Kat_BI_Operationsmassnahme</documentation> </annotation> <restriction base="xs:string"> <enumeration value="0116001"> <annotation> <documentation>Spülung, antibiotisch</documentation> </annotation> </enumeration> <enumeration value="0116002"> <annotation> <documentation>Spülung, antiseptisch</documentation> </annotation> </enumeration> </restriction> </simpleType> </pre> | | |

| | |
|--|---|
| | <pre> </enumeration> <enumeration value="0116003"> <annotation> <documentation>Spülung, wirkstofffrei</documentation> </annotation> </enumeration> <enumeration value="0116004"> <annotation> <documentation>Spülung, andere</documentation> </annotation> </enumeration> <enumeration value="0116005"> <annotation> <documentation>prä-/perioperative Antibiotika</documentation> </annotation> </enumeration> <enumeration value="0116006"> <annotation> <documentation>postoperative Antibiotika</documentation> </annotation> </enumeration> <enumeration value="0116007"> <annotation> <documentation>Handschuhwechsel vor Implantation</documentation> </annotation> </enumeration> <enumeration value="0116008"> <annotation> <documentation>Implantationshilfe</documentation> </annotation> </enumeration> </restriction> </simpleType> </pre> |
|--|---|

simpleType enum_0118

| | | | |
|------------|---|---------|-----------------------------------|
| namespace | http://xml.lir-d.de/sak | | |
| type | restriction of string | | |
| properties | base xs:string | | |
| facets | Kind | Value | Annotation |
| | enumeration | 0118001 | documentation axillär |
| | enumeration | 0118002 | documentation periareolär |
| | enumeration | 0118003 | documentation inframammär |
| | enumeration | 0118004 | documentation Mastektomienarbe |
| | enumeration | 0118042 | documentation anderer |
| annotation | documentation Kat_BI_Operationszugang | | |
| source | <pre> <simpleType name="enum_0118"> <annotation> <documentation>Kat_BI_Operationszugang</documentation> </annotation> <restriction base="xs:string"> </pre> | | |

| | |
|--|---|
| | <pre> <enumeration value="0118001"> <annotation> <documentation>axillär</documentation> </annotation> </enumeration> <enumeration value="0118002"> <annotation> <documentation>periareolär</documentation> </annotation> </enumeration> <enumeration value="0118003"> <annotation> <documentation>inframammär</documentation> </annotation> </enumeration> <enumeration value="0118004"> <annotation> <documentation>Mastektomienarbe</documentation> </annotation> </enumeration> <enumeration value="0118042"> <annotation> <documentation>anderer</documentation> </annotation> </enumeration> </restriction> </simpleType> </pre> |
|--|---|

simpleType enum_0120

| | | | |
|------------|--|---------|----------------------------------|
| namespace | http://xml.ir-d.de/sak | | |
| type | restriction of string | | |
| properties | base xs:string | | |
| facets | Kind | Value | Annotation |
| | enumeration | 0120001 | documentation Expander defekt |
| annotation | documentation Kat_BI_BefundAustausch | | |
| source | <pre> <simpleType name="enum_0120"> <annotation> <documentation>Kat_BI_BefundAustausch</documentation> </annotation> <restriction base="xs:string"> <enumeration value="0120001"> <annotation> <documentation>Expander defekt</documentation> </annotation> </enumeration> </restriction> </simpleType> </pre> | | |

simpleType enum_0121

| | |
|-----------|------------------------|
| namespace | http://xml.ir-d.de/sak |
|-----------|------------------------|

| | | | |
|------------|---|---------|---|
| type | restriction of string | | |
| properties | base xs:string | | |
| facets | Kind | Value | Annotation |
| | enumeration | 0121001 | documentation Infektion |
| | enumeration | 0121002 | documentation Serom |
| | enumeration | 0121003 | documentation Hämatom |
| | enumeration | 0121004 | documentation Kapsel­fibrose |
| | enumeration | 0121005 | documentation Implantat­ruptur |
| | enumeration | 0121006 | documentation Fehl­positionierung/Rotation |
| | enumeration | 0121007 | documentation BIA-ALCL/-SCC, Verdacht |
| | enumeration | 0121008 | documentation BIA-ALCL/-SCC, pathologisch bestätigt |
| | enumeration | 0121009 | documentation Brustschmerzen |
| | enumeration | 0121010 | documentation Doppelkapsel |
| | enumeration | 0121011 | documentation Netz-/ADM-bedingte Komplikation, Non-Integration |
| | enumeration | 0121012 | documentation Netz-/ADM-bedingte Komplikation, andere |
| | enumeration | 0121013 | documentation Hautnekrose/exponiertes Implantat |
| | enumeration | 0121014 | documentation BII/ASIA (Brustimplantat assoziierte Symptome), Verdacht |
| | enumeration | 0121015 | documentation Lymphadenopathie |
| | enumeration | 0121016 | documentation Brustkrebs, neu aufgetreten/Rezidiv |
| annotation | documentation Kat_BI_BefundKomplett | | |
| source | <pre> <simpleType name="enum_0121"> <annotation> <documentation>Kat_BI_BefundKomplett</documentation> </annotation> <restriction base="xs:string"> <enumeration value="0121001"> <annotation> <documentation>Infektion</documentation> </annotation> </enumeration> <enumeration value="0121002"> <annotation> <documentation>Serom</documentation> </annotation> </enumeration> <enumeration value="0121003"> <annotation> <documentation>Hämatom</documentation> </annotation> </enumeration> <enumeration value="0121004"> <annotation> <documentation>Kapsel­fibrose</documentation> </annotation> </enumeration> </restriction> </pre> | | |

```

</enumeration>
<enumeration value="0121005">
  <annotation>
    <documentation>Implantatruptur</documentation>
  </annotation>
</enumeration>
<enumeration value="0121006">
  <annotation>
    <documentation>Fehlpositionierung/Rotation</documentation>
  </annotation>
</enumeration>
<enumeration value="0121007">
  <annotation>
    <documentation>BIA-ALCL/-SCC, Verdacht</documentation>
  </annotation>
</enumeration>
<enumeration value="0121008">
  <annotation>
    <documentation>BIA-ALCL/-SCC, pathologisch bestätigt</documentation>
  </annotation>
</enumeration>
<enumeration value="0121009">
  <annotation>
    <documentation>Brustschmerzen</documentation>
  </annotation>
</enumeration>
<enumeration value="0121010">
  <annotation>
    <documentation>Doppelkapsel</documentation>
  </annotation>
</enumeration>
<enumeration value="0121011">
  <annotation>
    <documentation>Netz-/ADM-bedingte Komplikation,
Non-Integration</documentation>
  </annotation>
</enumeration>
<enumeration value="0121012">
  <annotation>
    <documentation>Netz-/ADM-bedingte Komplikation, andere</documentation>
  </annotation>
</enumeration>
<enumeration value="0121013">
  <annotation>
    <documentation>Hautnekrose/exponiertes Implantat</documentation>
  </annotation>
</enumeration>
<enumeration value="0121014">
  <annotation>
    <documentation>BII/ASIA (Brustimplantat assoziierte Symptome),
Verdacht</documentation>
  </annotation>
</enumeration>
<enumeration value="0121015">
  <annotation>
    <documentation>Lymphadenopathie</documentation>
  </annotation>
</enumeration>
<enumeration value="0121016">

```

| | |
|--|--|
| | <pre> <annotation> <documentation>Brustkrebs, neu aufgetreten/Rezidiv</documentation> </annotation> </enumeration> </restriction> </simpleType> </pre> |
|--|--|

simpleType enum_0122

| | | | |
|------------|---|---------|--|
| namespace | http://xml.ir-d.de/sak | | |
| type | restriction of string | | |
| properties | base xs:string | | |
| facets | Kind | Value | Annotation |
| | enumeration | 0122001 | documentation ja, ärztlich nachgewiesen |
| | enumeration | 0122002 | documentation nein |
| | enumeration | 0122042 | documentation unbekannt |
| annotation | documentation Kat_BI_Autoimmunerkrankung | | |
| source | <pre> <simpleType name="enum_0122"> <annotation> <documentation>Kat_BI_Autoimmunerkrankung</documentation> </annotation> <restriction base="xs:string"> <enumeration value="0122001"> <annotation> <documentation>ja, ärztlich nachgewiesen</documentation> </annotation> </enumeration> <enumeration value="0122002"> <annotation> <documentation>nein</documentation> </annotation> </enumeration> <enumeration value="0122042"> <annotation> <documentation>unbekannt</documentation> </annotation> </enumeration> </restriction> </simpleType> </pre> | | |

simpleType enum_0123

| | | | |
|------------|------------------------------|---------|----------------------------------|
| namespace | http://xml.ir-d.de/sak | | |
| type | restriction of string | | |
| properties | base xs:string | | |
| facets | Kind | Value | Annotation |
| | enumeration | 0123001 | documentation neu aufgetreten |
| | enumeration | 0123002 | documentation verschlechtert |
| | enumeration | 0123003 | documentation |

| | |
|------------|--|
| | <p>enumeration 0123004 keine Veränderung documentation nicht relevant, da Primäreingriff</p> <p>enumeration 0123042 documentation unbekannt</p> |
| annotation | documentation Kat_BI_VerlaufAutoimmunerkrankung |
| source | <pre> <simpleType name="enum_0123"> <annotation> <documentation>Kat_BI_VerlaufAutoimmunerkrankung</documentation> </annotation> <restriction base="xs:string"> <enumeration value="0123001"> <annotation> <documentation>neu aufgetreten</documentation> </annotation> </enumeration> <enumeration value="0123002"> <annotation> <documentation>verschlechtert</documentation> </annotation> </enumeration> <enumeration value="0123003"> <annotation> <documentation>keine Veränderung</documentation> </annotation> </enumeration> <enumeration value="0123004"> <annotation> <documentation>nicht relevant, da Primäreingriff</documentation> </annotation> </enumeration> <enumeration value="0123042"> <annotation> <documentation>unbekannt</documentation> </annotation> </enumeration> </restriction> </simpleType> </pre> |

simpleType enum_0124

| | | | |
|------------|----------------------------------|---------|--|
| namespace | http://xml.ir-d.de/sak | | |
| type | restriction of string | | |
| properties | base xs:string | | |
| facets | Kind | Value | Annotation |
| | enumeration | 0124001 | documentation Salzlösung |
| | enumeration | 0124002 | documentation Silikongel |
| | enumeration | 0124003 | documentation Kombination Silikongel und Salzlösung |
| | enumeration | 0124042 | documentation sonstige |
| annotation | documentation Kat_BI_Fuellung | | |
| source | <simpleType name="enum_0124"> | | |

| | |
|--|---|
| | <pre> <annotation> <documentation>Kat_BI_Fuellung</documentation> </annotation> <restriction base="xs:string"> <enumeration value="0124001"> <annotation> <documentation>Salzlösung</documentation> </annotation> </enumeration> <enumeration value="0124002"> <annotation> <documentation>Silikongel</documentation> </annotation> </enumeration> <enumeration value="0124003"> <annotation> <documentation>Kombination Silikongel und Salzlösung</documentation> </annotation> </enumeration> <enumeration value="0124042"> <annotation> <documentation>sonstige</documentation> </annotation> </enumeration> </restriction> </simpleType> </pre> |
|--|---|

simpleType enum_0126

| | | | |
|------------|--|---------|---|
| namespace | http://xml.ir-d.de/sak | | |
| type | restriction of string | | |
| properties | base xs:string | | |
| facets | Kind | Value | Annotation |
| | enumeration | 0126001 | documentation anatomisch (tropfenförmig) |
| | enumeration | 0126002 | documentation rund (punktsymmetrisch) |
| | enumeration | 0126042 | documentation sonstige |
| annotation | documentation Kat BI Form | | |
| source | <pre> <simpleType name="enum_0126"> <annotation> <documentation>Kat_BI_Form</documentation> </annotation> <restriction base="xs:string"> <enumeration value="0126001"> <annotation> <documentation>anatomisch (tropfenförmig)</documentation> </annotation> </enumeration> <enumeration value="0126002"> <annotation> <documentation>rund (punktsymmetrisch)</documentation> </annotation> </enumeration> <enumeration value="0126042"> </pre> | | |

| | |
|--|---|
| | <pre> <annotation> <documentation>sonstige</documentation> </annotation> </enumeration> </restriction> </simpleType> </pre> |
|--|---|

simpleType enum_0128

| | | | |
|------------|---|---------|------------------------------|
| namespace | http://xml.ir-d.de/sak | | |
| type | restriction of string | | |
| properties | base xs:string | | |
| facets | Kind | Value | Annotation |
| | enumeration | 0128001 | documentation glattwandig |
| | enumeration | 0128002 | documentation beschichtet |
| | enumeration | 0128003 | documentation texturiert |
| annotation | documentation Kat_BI_Oberflaeche | | |
| source | <pre> <simpleType name="enum_0128"> <annotation> <documentation>Kat_BI_Oberflaeche</documentation> </annotation> <restriction base="xs:string"> <enumeration value="0128001"> <annotation> <documentation>glattwandig</documentation> </annotation> </enumeration> <enumeration value="0128002"> <annotation> <documentation>beschichtet</documentation> </annotation> </enumeration> <enumeration value="0128003"> <annotation> <documentation>texturiert</documentation> </annotation> </enumeration> </restriction> </simpleType> </pre> | | |

simpleType enum_0130

| | | | |
|------------|------------------------------|---------|---------------------------|
| namespace | http://xml.ir-d.de/sak | | |
| type | restriction of string | | |
| properties | base xs:string | | |
| facets | Kind | Value | Annotation |
| | enumeration | 0130001 | documentation Allergan |
| | enumeration | 0130002 | documentation Cereplas |
| | enumeration | 0130003 | documentation |

| | |
|------------|--|
| | <p>enumeration 0130004 CUI (Cox Uphoff Implants) documentation</p> <p>enumeration 0130005 EMSI Biomedical documentation</p> <p>enumeration 0130006 Establishment labs documentation</p> <p>enumeration 0130007 Eurosilicone documentation</p> <p>enumeration 0130008 Nagor documentation</p> <p>enumeration 0130008 Groupe Sebbin documentation</p> <p>enumeration 0130009 Laboratoires Arion documentation</p> <p>enumeration 0130010 Mentor documentation</p> <p>enumeration 0130011 Pérouse Plastie SAS documentation</p> <p>enumeration 0130012 PIP M-Implants documentation</p> <p>enumeration 0130013 Polytech Health & Aesthetics documentation</p> <p>enumeration 0130014 Silimed documentation</p> <p>enumeration 0130015 Surgitek documentation</p> <p>enumeration 0130016 G&G Biotechnology documentation</p> <p>enumeration 0130017 nicht belegter Wert documentation</p> <p>enumeration 0130018 nicht belegter Wert documentation</p> <p>enumeration 0130019 nicht belegter Wert documentation</p> <p>enumeration 0130020 nicht belegter Wert documentation</p> <p>enumeration 0130021 nicht belegter Wert documentation</p> <p>enumeration 0130042 nicht belegter Wert documentation sonstiger</p> |
| annotation | documentation Kat_BI_Hersteller |
| source | <pre> <simpleType name="enum_0130"> <annotation> <documentation>Kat_BI_Hersteller</documentation> </annotation> <restriction base="xs:string"> <enumeration value="0130001"> <annotation> <documentation>Allergan</documentation> </annotation> </enumeration> <enumeration value="0130002"> <annotation> <documentation>Cereplas</documentation> </annotation> </enumeration> <enumeration value="0130003"> <annotation> <documentation>CUI (Cox Uphoff Implants)</documentation> </annotation> </enumeration> <enumeration value="0130004"> </pre> |

```
<annotation>
  <documentation>EMSI Biomedical</documentation>
</annotation>
</enumeration>
<enumeration value="0130005">
  <annotation>
    <documentation>Establishment labs</documentation>
  </annotation>
</enumeration>
<enumeration value="0130006">
  <annotation>
    <documentation>Eurosilicone</documentation>
  </annotation>
</enumeration>
<enumeration value="0130007">
  <annotation>
    <documentation>Nagor</documentation>
  </annotation>
</enumeration>
<enumeration value="0130008">
  <annotation>
    <documentation>Groupe Sebbin</documentation>
  </annotation>
</enumeration>
<enumeration value="0130009">
  <annotation>
    <documentation>Laboratoires Arion</documentation>
  </annotation>
</enumeration>
<enumeration value="0130010">
  <annotation>
    <documentation>Mentor</documentation>
  </annotation>
</enumeration>
<enumeration value="0130011">
  <annotation>
    <documentation>Pérouse Plastie SAS</documentation>
  </annotation>
</enumeration>
<enumeration value="0130012">
  <annotation>
    <documentation>PIP M-Implants</documentation>
  </annotation>
</enumeration>
<enumeration value="0130013">
  <annotation>
    <documentation>Polytech Health & Aesthetics</documentation>
  </annotation>
</enumeration>
<enumeration value="0130014">
  <annotation>
    <documentation>Silimed</documentation>
  </annotation>
</enumeration>
<enumeration value="0130015">
  <annotation>
    <documentation>Surgitek</documentation>
  </annotation>
</enumeration>
```

```

<enumeration value="0130016">
  <annotation>
    <documentation>G&G Biotechnology</documentation>
  </annotation>
</enumeration>
<enumeration value="0130017">
  <annotation>
    <documentation>nicht belegter Wert</documentation>
  </annotation>
</enumeration>
<enumeration value="0130018">
  <annotation>
    <documentation>nicht belegter Wert</documentation>
  </annotation>
</enumeration>
<enumeration value="0130019">
  <annotation>
    <documentation>nicht belegter Wert</documentation>
  </annotation>
</enumeration>
<enumeration value="0130020">
  <annotation>
    <documentation>nicht belegter Wert</documentation>
  </annotation>
</enumeration>
<enumeration value="0130021">
  <annotation>
    <documentation>nicht belegter Wert</documentation>
  </annotation>
</enumeration>
<enumeration value="0130042">
  <annotation>
    <documentation>sonstiger</documentation>
  </annotation>
</enumeration>
</restriction>
</simpleType>

```

simpleType enum 0131

| | | | |
|------------|------------------------------|---------|---|
| namespace | http://xml.ir-d.de/sak | | |
| type | restriction of string | | |
| properties | base xs:string | | |
| facets | Kind | Value | Annotation |
| | enumeration | 0131001 | documentation Allergan |
| | enumeration | 0131002 | documentation Establishment labs |
| | enumeration | 0131003 | documentation Eurosilicone |
| | enumeration | 0131004 | documentation Galatea |
| | enumeration | 0131005 | documentation Integra |
| | enumeration | 0131006 | documentation Lifecell |
| | enumeration | 0131007 | documentation MBP (Medical Biomaterial Products) |

| | |
|------------|---|
| | enumeration 0131008 documentation Mentor enumeration 0131009 documentation Novus Scientific enumeration 0131042 documentation sonstiger |
| annotation | documentation Kat_BI_ZubehoerHersteller |
| source | <pre> <simpleType name="enum_0131"> <annotation> <documentation>Kat_BI_ZubehoerHersteller</documentation> </annotation> <restriction base="xs:string"> <enumeration value="0131001"> <annotation> <documentation>Allergan</documentation> </annotation> </enumeration> <enumeration value="0131002"> <annotation> <documentation>Establishment labs</documentation> </annotation> </enumeration> <enumeration value="0131003"> <annotation> <documentation>Eurosilicone</documentation> </annotation> </enumeration> <enumeration value="0131004"> <annotation> <documentation>Galatea</documentation> </annotation> </enumeration> <enumeration value="0131005"> <annotation> <documentation>Integra</documentation> </annotation> </enumeration> <enumeration value="0131006"> <annotation> <documentation>Lifecell</documentation> </annotation> </enumeration> <enumeration value="0131007"> <annotation> <documentation>MBP (Medical Biomaterial Products)</documentation> </annotation> </enumeration> <enumeration value="0131008"> <annotation> <documentation>Mentor</documentation> </annotation> </enumeration> <enumeration value="0131009"> <annotation> <documentation>Novus Scientific</documentation> </annotation> </enumeration> <enumeration value="0131042"> </pre> |

| | |
|--|--|
| | <pre> <annotation> <documentation>sonstiger</documentation> </annotation> </enumeration> </restriction> </simpleType> </pre> |
|--|--|

simpleType enum_0190

| | | | |
|------------|---|---------|---------------------------------|
| namespace | http://xml.ir-d.de/sak | | |
| type | restriction of string | | |
| properties | base xs:string | | |
| facets | Kind | Value | Annotation |
| | enumeration | 0190001 | documentation Brustimplantat |
| | enumeration | 0190003 | documentation Brustexpander |
| annotation | documentation Kat_BI_Artikeltyp | | |
| source | <pre> <simpleType name="enum_0190"> <annotation> <documentation>Kat_BI_Artikeltyp</documentation> </annotation> <restriction base="xs:string"> <enumeration value="0190001"> <annotation> <documentation>Brustimplantat</documentation> </annotation> </enumeration> <enumeration value="0190003"> <annotation> <documentation>Brustexpander</documentation> </annotation> </enumeration> </restriction> </simpleType> </pre> | | |

simpleType enum_0191

| | | | |
|------------|--|---------|-----------------------|
| namespace | http://xml.ir-d.de/sak | | |
| type | restriction of string | | |
| properties | base xs:string | | |
| facets | Kind | Value | Annotation |
| | enumeration | 0191001 | documentation Netz |
| | enumeration | 0191002 | documentation ADM |
| annotation | documentation Kat_BI_ZubehoerTyp | | |
| source | <pre> <simpleType name="enum_0191"> <annotation> <documentation>Kat_BI_ZubehoerTyp</documentation> </annotation> <restriction base="xs:string"> </pre> | | |

| | |
|--|--|
| | <pre> <enumeration value="0191001"> <annotation> <documentation>Netz</documentation> </annotation> </enumeration> <enumeration value="0191002"> <annotation> <documentation>ADM</documentation> </annotation> </enumeration> </restriction> </simpleType> </pre> |
|--|--|

simpleType enum_0200

| | | | |
|------------|---|---------|--------------------------------|
| namespace | http://xml.ir-d.de/sak | | |
| type | restriction of string | | |
| properties | base xs:string | | |
| facets | Kind | Value | Annotation |
| | enumeration | 0200001 | documentation Erst-OP |
| | enumeration | 0200002 | documentation Folgeeingriff |
| annotation | documentation Kat_EP_ArtEingriff | | |
| source | <pre> <simpleType name="enum_0200"> <annotation> <documentation>Kat_EP_ArtEingriff</documentation> </annotation> <restriction base="xs:string"> <enumeration value="0200001"> <annotation> <documentation>Erst-OP</documentation> </annotation> </enumeration> <enumeration value="0200002"> <annotation> <documentation>Folgeeingriff</documentation> </annotation> </enumeration> </restriction> </simpleType> </pre> | | |

simpleType enum_0202

| | | | |
|------------|------------------------------|---------|--|
| namespace | http://xml.ir-d.de/sak | | |
| type | restriction of string | | |
| properties | base xs:string | | |
| facets | Kind | Value | Annotation |
| | enumeration | 0202001 | documentation Lockerung |
| | enumeration | 0202002 | documentation Infektion, Verdacht auf |
| | enumeration | 0202003 | documentation |

| | |
|------------|---|
| | <p>enumeration 0202004 Infektion, gesichert documentation Luxation, Inlay aus der Pfanne</p> <p>enumeration 0202005 documentation Luxation, Kopf aus Pfanne/Inlay</p> <p>enumeration 0202006 documentation Periprothetische Fraktur</p> <p>enumeration 0202007 documentation Verschleiß des PE-Inlays</p> <p>enumeration 0202008 documentation Implantatbruch</p> <p>enumeration 0202009 documentation Implantatfehlage/Malalignent</p> <p>enumeration 0202010 documentation Osteolysen bei festem Implantat</p> <p>enumeration 0202011 documentation Progression der Grunderkrankung</p> <p>enumeration 0202012 documentation ARMD</p> <p>enumeration 0202013 documentation Verdacht auf allergische Reaktion</p> <p>enumeration 0202021 documentation Zustand nach Prothesenentfernung</p> <p>enumeration 0202042 documentation andere Gründe</p> |
| annotation | documentation Kat_EP_GrundWechselHuefte |
| source | <pre> <simpleType name="enum_0202"> <annotation> <documentation>Kat_EP_GrundWechselHuefte</documentation> </annotation> <restriction base="xs:string"> <enumeration value="0202001"> <annotation> <documentation>Lockerung</documentation> </annotation> </enumeration> <enumeration value="0202002"> <annotation> <documentation>Infektion, Verdacht auf</documentation> </annotation> </enumeration> <enumeration value="0202003"> <annotation> <documentation>Infektion, gesichert</documentation> </annotation> </enumeration> <enumeration value="0202004"> <annotation> <documentation>Luxation, Inlay aus der Pfanne</documentation> </annotation> </enumeration> <enumeration value="0202005"> <annotation> <documentation>Luxation, Kopf aus Pfanne/Inlay</documentation> </annotation> </enumeration> <enumeration value="0202006"> <annotation> <documentation>Periprothetische Fraktur</documentation> </annotation> </enumeration> </restriction> </simpleType> </pre> |

```

</enumeration>
<enumeration value="0202007">
  <annotation>
    <documentation>Verschleiß des PE-Inlays</documentation>
  </annotation>
</enumeration>
<enumeration value="0202008">
  <annotation>
    <documentation>Implantatbruch</documentation>
  </annotation>
</enumeration>
<enumeration value="0202009">
  <annotation>
    <documentation>Implantatfehllage/Malalignement</documentation>
  </annotation>
</enumeration>
<enumeration value="0202010">
  <annotation>
    <documentation>Osteolysen bei festem Implantat</documentation>
  </annotation>
</enumeration>
<enumeration value="0202011">
  <annotation>
    <documentation>Progression der Grunderkrankung</documentation>
  </annotation>
</enumeration>
<enumeration value="0202012">
  <annotation>
    <documentation>ARMD</documentation>
  </annotation>
</enumeration>
<enumeration value="0202013">
  <annotation>
    <documentation>Verdacht auf allergische Reaktion</documentation>
  </annotation>
</enumeration>
<enumeration value="0202021">
  <annotation>
    <documentation>Zustand nach Prothesenentfernung</documentation>
  </annotation>
</enumeration>
<enumeration value="0202042">
  <annotation>
    <documentation>andere Gründe</documentation>
  </annotation>
</enumeration>
</restriction>
</simpleType>

```

simpleType enum_0204

| | | | |
|------------|------------------------------|------------------|--|
| namespace | http://xml.ir-d.de/sak | | |
| type | restriction of string | | |
| properties | base xs:string | | |
| facets | Kind enumeration | Value 0204001 | Annotation documentation Lockerung |

| | |
|------------|--|
| | <p>enumeration 0204002 documentation Infektion, Verdacht auf</p> <p>enumeration 0204003 documentation Infektion, gesichert</p> <p>enumeration 0204006 documentation Periprothetische Fraktur</p> <p>enumeration 0204007 documentation Verschleiß</p> <p>enumeration 0204008 documentation Implantatbruch</p> <p>enumeration 0204009 documentation Implantatfehlage/Malalignement</p> <p>enumeration 0204010 documentation Osteolysen bei festem Implantat</p> <p>enumeration 0204011 documentation Progression der Grunderkrankung</p> <p>enumeration 0204012 documentation ARMD</p> <p>enumeration 0204013 documentation Verdacht auf allergische Reaktion</p> <p>enumeration 0204014 documentation Dislokation/Migration von Komponenten</p> <p>enumeration 0204015 documentation Bandinstabilität</p> <p>enumeration 0204016 documentation Bewegungseinschränkung</p> <p>enumeration 0204021 documentation Zustand nach Prothesenentfernung</p> <p>enumeration 0204042 documentation andere Gründe</p> |
| annotation | <p>documentation Kat_EP_GrundWechselKnie</p> |
| source | <pre> <simpleType name="enum_0204"> <annotation> <documentation>Kat_EP_GrundWechselKnie</documentation> </annotation> <restriction base="xs:string"> <enumeration value="0204001"> <annotation> <documentation>Lockerung</documentation> </annotation> </enumeration> <enumeration value="0204002"> <annotation> <documentation>Infektion, Verdacht auf</documentation> </annotation> </enumeration> <enumeration value="0204003"> <annotation> <documentation>Infektion, gesichert</documentation> </annotation> </enumeration> <enumeration value="0204006"> <annotation> <documentation>Periprothetische Fraktur</documentation> </annotation> </enumeration> <enumeration value="0204007"> <annotation> <documentation>Verschleiß</documentation> </annotation> </enumeration> </restriction> </simpleType> </pre> |

```
<enumeration value="0204008">
  <annotation>
    <documentation>Implantatbruch</documentation>
  </annotation>
</enumeration>
<enumeration value="0204009">
  <annotation>
    <documentation>Implantatfehllage/Malalignent</documentation>
  </annotation>
</enumeration>
<enumeration value="0204010">
  <annotation>
    <documentation>Osteolysen bei festem Implantat</documentation>
  </annotation>
</enumeration>
<enumeration value="0204011">
  <annotation>
    <documentation>Progression der Grunderkrankung</documentation>
  </annotation>
</enumeration>
<enumeration value="0204012">
  <annotation>
    <documentation>ARMD</documentation>
  </annotation>
</enumeration>
<enumeration value="0204013">
  <annotation>
    <documentation>Verdacht auf allergische Reaktion</documentation>
  </annotation>
</enumeration>
<enumeration value="0204014">
  <annotation>
    <documentation>Dislokation/Migration von Komponenten</documentation>
  </annotation>
</enumeration>
<enumeration value="0204015">
  <annotation>
    <documentation>Bandinstabilität</documentation>
  </annotation>
</enumeration>
<enumeration value="0204016">
  <annotation>
    <documentation>Bewegungseinschränkung</documentation>
  </annotation>
</enumeration>
<enumeration value="0204021">
  <annotation>
    <documentation>Zustand nach Prothesenentfernung</documentation>
  </annotation>
</enumeration>
<enumeration value="0204042">
  <annotation>
    <documentation>andere Gründe</documentation>
  </annotation>
</enumeration>
</restriction>
</simpleType>
```

simpleType enum_0206

| | | | |
|------------|--|---------|--|
| namespace | http://xml.ir-d.de/sak | | |
| type | restriction of string | | |
| properties | base xs:string | | |
| facets | Kind | Value | Annotation |
| | enumeration | 0206001 | documentation Lockerung |
| | enumeration | 0206002 | documentation Infektion, Verdacht auf |
| | enumeration | 0206003 | documentation Infektion, gesichert |
| | enumeration | 0206004 | documentation Luxation, Inlay aus der Pfanne |
| | enumeration | 0206005 | documentation Luxation, Kopf aus Pfanne/Inlay |
| | enumeration | 0206006 | documentation Periprothetische Fraktur |
| | enumeration | 0206007 | documentation Verschleiß |
| | enumeration | 0206008 | documentation Implantatbruch |
| | enumeration | 0206009 | documentation Implantatfehlage/Malalignement |
| | enumeration | 0206010 | documentation Osteolysen bei festem Implantat |
| | enumeration | 0206011 | documentation Progression der Grunderkrankung |
| | enumeration | 0206012 | documentation ARMD |
| | enumeration | 0206013 | documentation Verdacht auf allergische Reaktion |
| | enumeration | 0206014 | documentation Dislokation/Migration von Komponenten |
| | enumeration | 0206015 | documentation Bandinstabilität |
| | enumeration | 0206016 | documentation Bewegungseinschränkung |
| | enumeration | 0206021 | documentation Zustand nach Prothesenentfernung |
| | enumeration | 0206042 | documentation andere Gründe |
| annotation | documentation Kat_EP_GrundWechselTFE | | |
| source | <pre> <simpleType name="enum_0206"> <annotation> <documentation>Kat_EP_GrundWechselTFE</documentation> </annotation> <restriction base="xs:string"> <enumeration value="0206001"> <annotation> <documentation>Lockerung</documentation> </annotation> </enumeration> <enumeration value="0206002"> <annotation> <documentation>Infektion, Verdacht auf</documentation> </annotation> </enumeration> <enumeration value="0206003"> </pre> | | |

```
<annotation>
  <documentation>Infektion, gesichert</documentation>
</annotation>
</enumeration>
<enumeration value="0206004">
  <annotation>
    <documentation>Luxation, Inlay aus der Pfanne</documentation>
  </annotation>
</enumeration>
<enumeration value="0206005">
  <annotation>
    <documentation>Luxation, Kopf aus Pfanne/Inlay</documentation>
  </annotation>
</enumeration>
<enumeration value="0206006">
  <annotation>
    <documentation>Periprothetische Fraktur</documentation>
  </annotation>
</enumeration>
<enumeration value="0206007">
  <annotation>
    <documentation>Verschleiß</documentation>
  </annotation>
</enumeration>
<enumeration value="0206008">
  <annotation>
    <documentation>Implantatbruch</documentation>
  </annotation>
</enumeration>
<enumeration value="0206009">
  <annotation>
    <documentation>Implantatfehllage/Malalignent</documentation>
  </annotation>
</enumeration>
<enumeration value="0206010">
  <annotation>
    <documentation>Osteolysen bei festem Implantat</documentation>
  </annotation>
</enumeration>
<enumeration value="0206011">
  <annotation>
    <documentation>Progression der Grunderkrankung</documentation>
  </annotation>
</enumeration>
<enumeration value="0206012">
  <annotation>
    <documentation>ARMD</documentation>
  </annotation>
</enumeration>
<enumeration value="0206013">
  <annotation>
    <documentation>Verdacht auf allergische Reaktion</documentation>
  </annotation>
</enumeration>
<enumeration value="0206014">
  <annotation>
    <documentation>Dislokation/Migration von Komponenten</documentation>
  </annotation>
</enumeration>
```

| | |
|--|--|
| | <pre> <enumeration value="0206015"> <annotation> <documentation>Bandinstabilität</documentation> </annotation> </enumeration> <enumeration value="0206016"> <annotation> <documentation>Bewegungseinschränkung</documentation> </annotation> </enumeration> <enumeration value="0206021"> <annotation> <documentation>Zustand nach Prothesenentfernung</documentation> </annotation> </enumeration> <enumeration value="0206042"> <annotation> <documentation>andere Gründe</documentation> </annotation> </enumeration> </restriction> </simpleType> </pre> |
|--|--|

simpleType enum_0210

| | | | |
|------------|--|---------|--|
| namespace | http://xml.ir-d.de/sak | | |
| type | restriction of string | | |
| properties | base xs:string | | |
| facets | Kind | Value | Annotation |
| | enumeration | 0210001 | documentation keine relevante Voroperation |
| | enumeration | 0210002 | documentation Osteosynthese/Osteotomie (Becken) |
| | enumeration | 0210003 | documentation Osteosynthese/Osteotomie (Femur) |
| | enumeration | 0210004 | documentation Osteosynthese/Osteotomie (beides) |
| | enumeration | 0210005 | documentation Operation bei Hüftkopfnekrose |
| | enumeration | 0210006 | documentation Arthrodese |
| | enumeration | 0210042 | documentation andere |
| annotation | documentation Kat_EP_VoroperationHuefte | | |
| source | <pre> <simpleType name="enum_0210"> <annotation> <documentation>Kat_EP_VoroperationHuefte</documentation> </annotation> <restriction base="xs:string"> <enumeration value="0210001"> <annotation> <documentation>keine relevante Voroperation</documentation> </annotation> </enumeration> <enumeration value="0210002"> <annotation> </pre> | | |

| | |
|--|--|
| | <pre> <documentation>Osteosynthese/Osteotomie (Becken)</documentation> </annotation> </enumeration> <enumeration value="0210003"> <annotation> <documentation>Osteosynthese/Osteotomie (Femur)</documentation> </annotation> </enumeration> <enumeration value="0210004"> <annotation> <documentation>Osteosynthese/Osteotomie (beides)</documentation> </annotation> </enumeration> <enumeration value="0210005"> <annotation> <documentation>Operation bei Hüftkopfnekrose</documentation> </annotation> </enumeration> <enumeration value="0210006"> <annotation> <documentation>Arthrodesse</documentation> </annotation> </enumeration> <enumeration value="0210042"> <annotation> <documentation>andere</documentation> </annotation> </enumeration> </restriction> </simpleType> </pre> |
|--|--|

simpleType enum_0211

| | | | |
|------------|--|---------|---|
| namespace | http://xml.ir-d.de/sak | | |
| type | restriction of string | | |
| properties | base xs:string | | |
| facets | Kind | Value | Annotation |
| | enumeration | 0211001 | documentation keine relevante Voroperation |
| | enumeration | 0211002 | documentation Osteosynthese/Osteotomie (Femur) |
| | enumeration | 0211003 | documentation Osteosynthese/Osteotomie (Tibia) |
| | enumeration | 0211004 | documentation Osteosynthese/Osteotomie (Patella) |
| | enumeration | 0211005 | documentation Osteosynthese/Osteotomie (mehrere) |
| | enumeration | 0211006 | documentation Kapsel-/Bandapparat |
| | enumeration | 0211007 | documentation Arthrodesse |
| | enumeration | 0211042 | documentation andere |
| annotation | documentation Kat_EP_VoroperationKnie | | |
| source | <pre> <simpleType name="enum_0211"> <annotation> <documentation>Kat EP VoroperationKnie</documentation> </pre> | | |

```

</annotation>
<restriction base="xs:string">
  <enumeration value="0211001">
    <annotation>
      <documentation>keine relevante Voroperation</documentation>
    </annotation>
  </enumeration>
  <enumeration value="0211002">
    <annotation>
      <documentation>Osteosynthese/Osteotomie (Femur)</documentation>
    </annotation>
  </enumeration>
  <enumeration value="0211003">
    <annotation>
      <documentation>Osteosynthese/Osteotomie (Tibia)</documentation>
    </annotation>
  </enumeration>
  <enumeration value="0211004">
    <annotation>
      <documentation>Osteosynthese/Osteotomie (Patella)</documentation>
    </annotation>
  </enumeration>
  <enumeration value="0211005">
    <annotation>
      <documentation>Osteosynthese/Osteotomie (mehrere)</documentation>
    </annotation>
  </enumeration>
  <enumeration value="0211006">
    <annotation>
      <documentation>Kapsel-/Bandapparat</documentation>
    </annotation>
  </enumeration>
  <enumeration value="0211007">
    <annotation>
      <documentation>Arthrodese</documentation>
    </annotation>
  </enumeration>
  <enumeration value="0211042">
    <annotation>
      <documentation>andere</documentation>
    </annotation>
  </enumeration>
</restriction>
</simpleType>

```

simpleType enum_0212

| | | | |
|------------|------------------------------|---------|--|
| namespace | http://xml.ir-d.de/sak | | |
| type | restriction of string | | |
| properties | base xs:string | | |
| facets | Kind | Value | Annotation |
| | enumeration | 0212001 | documentation Hüfte |
| | enumeration | 0212002 | documentation Knie |
| | enumeration | 0212003 | documentation Totaler Femurersatz inkl. Durchsteck-Prothese |

| | |
|------------|--|
| annotation | documentation Kat_EP_Gelenk |
| source | <pre> <simpleType name="enum_0212"> <annotation> <documentation>Kat_EP_Gelenk</documentation> </annotation> <restriction base="xs:string"> <enumeration value="0212001"> <annotation> <documentation>Hüfte</documentation> </annotation> </enumeration> <enumeration value="0212002"> <annotation> <documentation>Knie</documentation> </annotation> </enumeration> <enumeration value="0212003"> <annotation> <documentation>Totaler Femurersatz inkl. Durchsteck-Prothese</documentation> </annotation> </enumeration> </restriction> </simpleType> </pre> |

simpleType enum_0220

| | | | |
|------------|--|---------|--------------------------------------|
| namespace | http://xml.ir-d.de/sak | | |
| type | restriction of string | | |
| properties | base xs:string | | |
| facets | Kind | Value | Annotation |
| | enumeration | 0220001 | documentation anterior |
| | enumeration | 0220002 | documentation anterolateral |
| | enumeration | 0220003 | documentation lateral |
| | enumeration | 0220004 | documentation posterior |
| | enumeration | 0220005 | documentation posterolateral |
| | enumeration | 0220006 | documentation 2-Inzisionen-Zugang |
| | enumeration | 0220042 | documentation sonstiges/unbekannt |
| annotation | documentation Kat_EP_Operationszugang | | |
| source | <pre> <simpleType name="enum_0220"> <annotation> <documentation>Kat_EP_Operationszugang</documentation> </annotation> <restriction base="xs:string"> <enumeration value="0220001"> <annotation> <documentation>anterior</documentation> </annotation> </enumeration> </restriction> </simpleType> </pre> | | |

| | |
|--|---|
| | <pre> </enumeration> <enumeration value="0220002"> <annotation> <documentation>anterolateral</documentation> </annotation> </enumeration> <enumeration value="0220003"> <annotation> <documentation>lateral</documentation> </annotation> </enumeration> <enumeration value="0220004"> <annotation> <documentation>posterior</documentation> </annotation> </enumeration> <enumeration value="0220005"> <annotation> <documentation>posterolateral</documentation> </annotation> </enumeration> <enumeration value="0220006"> <annotation> <documentation>2-Inzisionen-Zugang</documentation> </annotation> </enumeration> <enumeration value="0220042"> <annotation> <documentation>sonstiges/unbekannt</documentation> </annotation> </enumeration> </restriction> </simpleType> </pre> |
|--|---|

simpleType enum_0222

| | | | |
|------------|---|---------|-----------------------------|
| namespace | http://xml.lir-d.de/sak | | |
| type | restriction of string | | |
| properties | base xs:string | | |
| facets | Kind | Value | Annotation |
| | enumeration | 0222001 | documentation nein |
| | enumeration | 0222002 | documentation ja- Ausbau |
| | enumeration | 0222003 | documentation ja- Einbau |
| annotation | documentation Kat_EP_Zweizeitwechsel | | |
| source | <pre> <simpleType name="enum_0222"> <annotation> <documentation>Kat_EP_Zweizeitwechsel</documentation> </annotation> <restriction base="xs:string"> <enumeration value="0222001"> <annotation> <documentation>nein</documentation> </annotation> </pre> | | |

```

</enumeration>
<enumeration value="0222002">
  <annotation>
    <documentation>ja- Ausbau</documentation>
  </annotation>
</enumeration>
<enumeration value="0222003">
  <annotation>
    <documentation>ja- Einbau</documentation>
  </annotation>
</enumeration>
</restriction>
</simpleType>

```

simpleType enum_0230

| | | | |
|------------|------------------------------|---------|---|
| namespace | http://xml.ir-d.de/sak | | |
| type | restriction of string | | |
| properties | base xs:string | | |
| facets | Kind | Value | Annotation |
| | enumeration | 0230001 | documentation Smith & Nephew GmbH |
| | enumeration | 0230002 | documentation Mathys Orthopädie GmbH |
| | enumeration | 0230003 | documentation Ceramtec AG |
| | enumeration | 0230004 | documentation Biomet |
| | enumeration | 0230005 | documentation Peter Brehm GmbH |
| | enumeration | 0230006 | documentation Amplitude GmbH |
| | enumeration | 0230007 | documentation Exactech Deutschland |
| | enumeration | 0230008 | documentation Globus Medical |
| | enumeration | 0230009 | documentation Implantcast GmbH |
| | enumeration | 0230010 | documentation DePuy Orthopädie GmbH |
| | enumeration | 0230011 | documentation IO-International Orthopaedics |
| | enumeration | 0230012 | documentation Joint Replacement Ltd. Instrumentation |
| | enumeration | 0230013 | documentation Merete |
| | enumeration | 0230014 | documentation S&G Implants GmbH |
| | enumeration | 0230015 | documentation Speetec Implantate GmbH |
| | enumeration | 0230016 | documentation Stemcup Medical Products GmbH |
| | enumeration | 0230017 | documentation Symbios Deutschland GmbH |
| | enumeration | 0230018 | documentation Tantum AG |
| | enumeration | 0230019 | documentation Tornier GmbH |
| | enumeration | 0230020 | documentation MicroPort Orthopedics GmbH |

| | |
|------------|---|
| | <p>enumeration 0230021 documentation aap Implanate AG</p> <p>enumeration 0230022 documentation AQImplants</p> <p>enumeration 0230023 documentation ESKA Orthodynamics GmbH</p> <p>enumeration 0230024 documentation Atecos medical AG</p> <p>enumeration 0230025 documentation Chiropro GmbH</p> <p>enumeration 0230026 documentation Medacta</p> <p>enumeration 0230027 documentation OHST Medizintechnik AG</p> <p>enumeration 0230028 documentation Lima Deutschland GmbH</p> <p>enumeration 0230029 documentation alloPlus GmbH</p> <p>enumeration 0230030 documentation Heraeus Medical GmbH</p> <p>enumeration 0230031 documentation ImplanTec Deutschland GmbH</p> <p>enumeration 0230032 documentation Falcon Medical GmbH</p> <p>enumeration 0230033 documentation Meril GmbH</p> <p>enumeration 0230034 documentation Zimmer Germany GmbH</p> <p>enumeration 0230035 documentation Stryker GmbH & Co. KG</p> <p>enumeration 0230036 documentation Aesculap AG</p> <p>enumeration 0230037 documentation Waldemar Link GmbH & Co. KG</p> <p>enumeration 0230038 documentation Corin Germany GmbH</p> <p>enumeration 0230039 documentation nicht belegter Wert</p> <p>enumeration 0230040 documentation nicht belegter Wert</p> <p>enumeration 0230041 documentation nicht belegter Wert</p> <p>enumeration 0230042 documentation sonstige</p> <p>enumeration 0230043 documentation nicht belegter Wert</p> <p>enumeration 0230044 documentation nicht belegter Wert</p> |
| annotation | documentation Kat_EP_Hersteller |
| source | <pre> <simpleType name="enum_0230"> <annotation> <documentation>Kat_EP_Hersteller</documentation> </annotation> <restriction base="xs:string"> <enumeration value="0230001"> <annotation> <documentation>Smith & Nephew GmbH</documentation> </annotation> </enumeration> <enumeration value="0230002"> <annotation> <documentation>Mathys Orthopädie GmbH</documentation> </annotation> </enumeration> </restriction> </simpleType> </pre> |

```
</annotation>
</enumeration>
<enumeration value="0230003">
  <annotation>
    <documentation>Ceramtec AG</documentation>
  </annotation>
</enumeration>
<enumeration value="0230004">
  <annotation>
    <documentation>Biomet</documentation>
  </annotation>
</enumeration>
<enumeration value="0230005">
  <annotation>
    <documentation>Peter Brehm GmbH</documentation>
  </annotation>
</enumeration>
<enumeration value="0230006">
  <annotation>
    <documentation>Amplitude GmbH</documentation>
  </annotation>
</enumeration>
<enumeration value="0230007">
  <annotation>
    <documentation>Exactech Deutschland</documentation>
  </annotation>
</enumeration>
<enumeration value="0230008">
  <annotation>
    <documentation>Globus Medical</documentation>
  </annotation>
</enumeration>
<enumeration value="0230009">
  <annotation>
    <documentation>Implantcast GmbH</documentation>
  </annotation>
</enumeration>
<enumeration value="0230010">
  <annotation>
    <documentation>DePuy Orthopädie GmbH</documentation>
  </annotation>
</enumeration>
<enumeration value="0230011">
  <annotation>
    <documentation>IO-International Orthopaedics</documentation>
  </annotation>
</enumeration>
<enumeration value="0230012">
  <annotation>
    <documentation>Joint Replacement Ltd. Instrumentation</documentation>
  </annotation>
</enumeration>
<enumeration value="0230013">
  <annotation>
    <documentation>Merete</documentation>
  </annotation>
</enumeration>
<enumeration value="0230014">
  <annotation>
```

```
<documentation>S&G Implants GmbH</documentation>
</annotation>
</enumeration>
<enumeration value="0230015">
  <annotation>
    <documentation>Speetec Implantate GmbH</documentation>
  </annotation>
</enumeration>
<enumeration value="0230016">
  <annotation>
    <documentation>Stemcup Medical Products GmbH</documentation>
  </annotation>
</enumeration>
<enumeration value="0230017">
  <annotation>
    <documentation>Symbios Deutschland GmbH</documentation>
  </annotation>
</enumeration>
<enumeration value="0230018">
  <annotation>
    <documentation>Tantum AG</documentation>
  </annotation>
</enumeration>
<enumeration value="0230019">
  <annotation>
    <documentation>Tornier GmbH</documentation>
  </annotation>
</enumeration>
<enumeration value="0230020">
  <annotation>
    <documentation>MicroPort Orthopedics GmbH</documentation>
  </annotation>
</enumeration>
<enumeration value="0230021">
  <annotation>
    <documentation>aap Implanate AG</documentation>
  </annotation>
</enumeration>
<enumeration value="0230022">
  <annotation>
    <documentation>AQImplants</documentation>
  </annotation>
</enumeration>
<enumeration value="0230023">
  <annotation>
    <documentation>ESKA Orthodynamics GmbH</documentation>
  </annotation>
</enumeration>
<enumeration value="0230024">
  <annotation>
    <documentation>Ateos medical AG</documentation>
  </annotation>
</enumeration>
<enumeration value="0230025">
  <annotation>
    <documentation>Chiropro GmbH</documentation>
  </annotation>
</enumeration>
<enumeration value="0230026">
```

```
<annotation>
  <documentation>Medacta</documentation>
</annotation>
</enumeration>
<enumeration value="0230027">
  <annotation>
    <documentation>OHST Medizintechnik AG</documentation>
  </annotation>
</enumeration>
<enumeration value="0230028">
  <annotation>
    <documentation>Lima Deutschland GmbH</documentation>
  </annotation>
</enumeration>
<enumeration value="0230029">
  <annotation>
    <documentation>alloPlus GmbH</documentation>
  </annotation>
</enumeration>
<enumeration value="0230030">
  <annotation>
    <documentation>Heraeus Medical GmbH</documentation>
  </annotation>
</enumeration>
<enumeration value="0230031">
  <annotation>
    <documentation>ImplanTec Deutschland GmbH</documentation>
  </annotation>
</enumeration>
<enumeration value="0230032">
  <annotation>
    <documentation>Falcon Medical GmbH</documentation>
  </annotation>
</enumeration>
<enumeration value="0230033">
  <annotation>
    <documentation>Meril GmbH</documentation>
  </annotation>
</enumeration>
<enumeration value="0230034">
  <annotation>
    <documentation>Zimmer Germany GmbH</documentation>
  </annotation>
</enumeration>
<enumeration value="0230035">
  <annotation>
    <documentation>Stryker GmbH & Co. KG</documentation>
  </annotation>
</enumeration>
<enumeration value="0230036">
  <annotation>
    <documentation>Aesculap AG</documentation>
  </annotation>
</enumeration>
<enumeration value="0230037">
  <annotation>
    <documentation>Waldemar Link GmbH & Co. KG</documentation>
  </annotation>
</enumeration>
```

```

<enumeration value="0230038">
  <annotation>
    <documentation>Corin Germany GmbH</documentation>
  </annotation>
</enumeration>
<enumeration value="0230039">
  <annotation>
    <documentation>nicht belegter Wert</documentation>
  </annotation>
</enumeration>
<enumeration value="0230040">
  <annotation>
    <documentation>nicht belegter Wert</documentation>
  </annotation>
</enumeration>
<enumeration value="0230041">
  <annotation>
    <documentation>nicht belegter Wert</documentation>
  </annotation>
</enumeration>
<enumeration value="0230042">
  <annotation>
    <documentation>sonstige</documentation>
  </annotation>
</enumeration>
<enumeration value="0230043">
  <annotation>
    <documentation>nicht belegter Wert</documentation>
  </annotation>
</enumeration>
<enumeration value="0230044">
  <annotation>
    <documentation>nicht belegter Wert</documentation>
  </annotation>
</enumeration>
</restriction>
</simpleType>

```

simpleType enum 0252

| | | | |
|------------|---|---------|-------------------------|
| namespace | http://xml.ir-d.de/sak | | |
| type | restriction of string | | |
| properties | base xs:string | | |
| facets | Kind | Value | Annotation |
| | enumeration | 0252001 | documentation Pfanne |
| | enumeration | 0252002 | documentation Schaft |
| | enumeration | 0252003 | documentation beides |
| annotation | documentation Kat_EP_KomponenteHuefte | | |
| source | <pre> <simpleType name="enum_0252"> <annotation> <documentation>Kat_EP_KomponenteHuefte</documentation> </annotation> <restriction base="xs:string"> </pre> | | |

| | |
|--|---|
| | <pre> <enumeration value="0252001"> <annotation> <documentation>Pfanne</documentation> </annotation> </enumeration> <enumeration value="0252002"> <annotation> <documentation>Schaft</documentation> </annotation> </enumeration> <enumeration value="0252003"> <annotation> <documentation>beides</documentation> </annotation> </enumeration> </restriction> </simpleType> </pre> |
|--|---|

simpleType enum_0254

| | | | |
|------------|--|---------|--------------------------|
| namespace | http://xml.ir-d.de/sak | | |
| type | restriction of string | | |
| properties | base xs:string | | |
| facets | Kind | Value | Annotation |
| | enumeration | 0254001 | documentation Femur |
| | enumeration | 0254002 | documentation Tibia |
| | enumeration | 0254003 | documentation Patella |
| | enumeration | 0254004 | documentation mehrere |
| annotation | documentation Kat_EP_KomponenteKnie | | |
| source | <pre> <simpleType name="enum_0254"> <annotation> <documentation>Kat_EP_KomponenteKnie</documentation> </annotation> <restriction base="xs:string"> <enumeration value="0254001"> <annotation> <documentation>Femur</documentation> </annotation> </enumeration> <enumeration value="0254002"> <annotation> <documentation>Tibia</documentation> </annotation> </enumeration> <enumeration value="0254003"> <annotation> <documentation>Patella</documentation> </annotation> </enumeration> <enumeration value="0254004"> <annotation> <documentation>mehrere</documentation> </annotation> </enumeration> </restriction> </simpleType> </pre> | | |

```

</annotation>
</enumeration>
</restriction>
</simpleType>

```

simpleType enum_0256

| | | | |
|------------|--|---------|------------------------------------|
| namespace | http://xml.ir-d.de/sak | | |
| type | restriction of string | | |
| properties | base xs:string | | |
| facets | Kind | Value | Annotation |
| | enumeration | 0256001 | documentation Pfanne |
| | enumeration | 0256002 | documentation Schaft |
| | enumeration | 0256003 | documentation Pfanne und Schaft |
| | enumeration | 0256004 | documentation Femur |
| | enumeration | 0256005 | documentation Tibia |
| | enumeration | 0256006 | documentation Patella |
| | enumeration | 0256007 | documentation mehrere |
| annotation | documentation Kat_EP_KomponenteTFE | | |
| source | <pre> <simpleType name="enum_0256"> <annotation> <documentation>Kat_EP_KomponenteTFE</documentation> </annotation> <restriction base="xs:string"> <enumeration value="0256001"> <annotation> <documentation>Pfanne</documentation> </annotation> </enumeration> <enumeration value="0256002"> <annotation> <documentation>Schaft</documentation> </annotation> </enumeration> <enumeration value="0256003"> <annotation> <documentation>Pfanne und Schaft</documentation> </annotation> </enumeration> <enumeration value="0256004"> <annotation> <documentation>Femur</documentation> </annotation> </enumeration> <enumeration value="0256005"> <annotation> <documentation>Tibia</documentation> </annotation> </enumeration> </restriction> </simpleType> </pre> | | |

| | |
|--|---|
| | <pre> <enumeration value="0256006"> <annotation> <documentation>Patella</documentation> </annotation> </enumeration> <enumeration value="0256007"> <annotation> <documentation>mehrere</documentation> </annotation> </enumeration> </restriction> </simpleType> </pre> |
|--|---|

simpleType enum_0262

| | | | |
|------------|---|---------|--------------------------|
| namespace | http://xml.ir-d.de/sak | | |
| type | restriction of string | | |
| properties | base xs:string | | |
| facets | Kind | Value | Annotation |
| | enumeration | 0262001 | documentation Pfanne |
| | enumeration | 0262002 | documentation Schaft |
| | enumeration | 0262003 | documentation Kopf |
| | enumeration | 0262004 | documentation Inlay |
| | enumeration | 0262005 | documentation Adapter |
| | enumeration | 0262006 | documentation mehrere |
| annotation | documentation Kat_EP_ImplantatbruchHuefte | | |
| source | <pre> <simpleType name="enum_0262"> <annotation> <documentation>Kat_EP_ImplantatbruchHuefte</documentation> </annotation> <restriction base="xs:string"> <enumeration value="0262001"> <annotation> <documentation>Pfanne</documentation> </annotation> </enumeration> <enumeration value="0262002"> <annotation> <documentation>Schaft</documentation> </annotation> </enumeration> <enumeration value="0262003"> <annotation> <documentation>Kopf</documentation> </annotation> </enumeration> <enumeration value="0262004"> <annotation> <documentation>Inlay</documentation> </annotation> </enumeration> </restriction> </simpleType> </pre> | | |

| | |
|--|--|
| | <pre> </enumeration> <enumeration value="0262005"> <annotation> <documentation>Adapter</documentation> </annotation> </enumeration> <enumeration value="0262006"> <annotation> <documentation>mehrere</documentation> </annotation> </enumeration> </restriction> </simpleType> </pre> |
|--|--|

simpleType enum_0264

| | | | |
|------------|--|---------|-------------------------------|
| namespace | http://xml.ir-d.de/sak | | |
| type | restriction of string | | |
| properties | base xs:string | | |
| facets | Kind | Value | Annotation |
| | enumeration | 0264001 | documentation Femur |
| | enumeration | 0264002 | documentation Tibia |
| | enumeration | 0264003 | documentation Inlay |
| | enumeration | 0264004 | documentation Adapter |
| | enumeration | 0264005 | documentation Verlängerung |
| | enumeration | 0264006 | documentation Schrauben |
| | enumeration | 0264007 | documentation mehrere |
| | enumeration | 0264042 | documentation andere |
| annotation | documentation Kat_EP_ImplantatbruchKnie | | |
| source | <pre> <simpleType name="enum_0264"> <annotation> <documentation>Kat_EP_ImplantatbruchKnie</documentation> </annotation> <restriction base="xs:string"> <enumeration value="0264001"> <annotation> <documentation>Femur</documentation> </annotation> </enumeration> <enumeration value="0264002"> <annotation> <documentation>Tibia</documentation> </annotation> </enumeration> <enumeration value="0264003"> <annotation> <documentation>Inlay</documentation> </annotation> </enumeration> </pre> | | |

```

<enumeration value="0264004">
  <annotation>
    <documentation>Adapter</documentation>
  </annotation>
</enumeration>
<enumeration value="0264005">
  <annotation>
    <documentation>Verlängerung</documentation>
  </annotation>
</enumeration>
<enumeration value="0264006">
  <annotation>
    <documentation>Schrauben</documentation>
  </annotation>
</enumeration>
<enumeration value="0264007">
  <annotation>
    <documentation>mehrere</documentation>
  </annotation>
</enumeration>
<enumeration value="0264042">
  <annotation>
    <documentation>andere</documentation>
  </annotation>
</enumeration>
</restriction>
</simpleType>

```

simpleType enum_0266

| | | | |
|------------|---|---------|-------------------------------|
| namespace | http://xml.ir-d.de/sak | | |
| type | restriction of string | | |
| properties | base xs:string | | |
| facets | Kind | Value | Annotation |
| | enumeration | 0266001 | documentation Pfanne |
| | enumeration | 0266002 | documentation Schaft |
| | enumeration | 0266003 | documentation Kopf |
| | enumeration | 0266004 | documentation Inlay |
| | enumeration | 0266005 | documentation Adapter |
| | enumeration | 0266006 | documentation Femur |
| | enumeration | 0266007 | documentation Tibia |
| | enumeration | 0266008 | documentation Verlängerung |
| | enumeration | 0266009 | documentation Schrauben |
| | enumeration | 0266010 | documentation mehrere |
| | enumeration | 0266042 | documentation andere |
| annotation | documentation Kat_EP_ImplantatbruchTFE | | |

source

```
<simpleType name="enum_0266">
  <annotation>
    <documentation>Kat_EP_ImplantatbruchTFE</documentation>
  </annotation>
  <restriction base="xs:string">
    <enumeration value="0266001">
      <annotation>
        <documentation>Pfanne</documentation>
      </annotation>
    </enumeration>
    <enumeration value="0266002">
      <annotation>
        <documentation>Schaft</documentation>
      </annotation>
    </enumeration>
    <enumeration value="0266003">
      <annotation>
        <documentation>Kopf</documentation>
      </annotation>
    </enumeration>
    <enumeration value="0266004">
      <annotation>
        <documentation>Inlay</documentation>
      </annotation>
    </enumeration>
    <enumeration value="0266005">
      <annotation>
        <documentation>Adapter</documentation>
      </annotation>
    </enumeration>
    <enumeration value="0266006">
      <annotation>
        <documentation>Femur</documentation>
      </annotation>
    </enumeration>
    <enumeration value="0266007">
      <annotation>
        <documentation>Tibia</documentation>
      </annotation>
    </enumeration>
    <enumeration value="0266008">
      <annotation>
        <documentation>Verlängerung</documentation>
      </annotation>
    </enumeration>
    <enumeration value="0266009">
      <annotation>
        <documentation>Schrauben</documentation>
      </annotation>
    </enumeration>
    <enumeration value="0266010">
      <annotation>
        <documentation>mehrere</documentation>
      </annotation>
    </enumeration>
    <enumeration value="0266042">
      <annotation>
        <documentation>andere</documentation>
      </annotation>
    </enumeration>
  </restriction>
</simpleType>
```

| | |
|--|--|
| | <pre> </enumeration> </restriction> </simpleType> </pre> |
|--|--|

simpleType enum_0270

| | | | |
|------------|---|---------|---------------------------------------|
| namespace | http://xml.ir-d.de/sak | | |
| type | restriction of string | | |
| properties | base xs:string | | |
| facets | Kind | Value | Annotation |
| | enumeration | 0270001 | documentation PE-Inlay |
| | enumeration | 0270002 | documentation patellare Komponente |
| | enumeration | 0270003 | documentation beides |
| annotation | documentation Kat_EP_VerschleissKnie | | |
| source | <pre> <simpleType name="enum_0270"> <annotation> <documentation>Kat_EP_VerschleissKnie</documentation> </annotation> <restriction base="xs:string"> <enumeration value="0270001"> <annotation> <documentation>PE-Inlay</documentation> </annotation> </enumeration> <enumeration value="0270002"> <annotation> <documentation>patellare Komponente</documentation> </annotation> </enumeration> <enumeration value="0270003"> <annotation> <documentation>beides</documentation> </annotation> </enumeration> </restriction> </simpleType> </pre> | | |

simpleType enum_0271

| | | | |
|------------|------------------------------|---------|---------------------------------------|
| namespace | http://xml.ir-d.de/sak | | |
| type | restriction of string | | |
| properties | base xs:string | | |
| facets | Kind | Value | Annotation |
| | enumeration | 0271001 | documentation Schraube |
| | enumeration | 0271002 | documentation Inlay |
| | enumeration | 0271003 | documentation patellare Komponente |
| | enumeration | 0271004 | documentation Kopplung |

| | |
|------------|---|
| | enumeration 0271005 documentation mehrere |
| | enumeration 0271042 documentation andere |
| annotation | documentation Kat_EP_MigrationKnie |
| source | <pre> <simpleType name="enum_0271"> <annotation> <documentation>Kat_EP_MigrationKnie</documentation> </annotation> <restriction base="xs:string"> <enumeration value="0271001"> <annotation> <documentation>Schraube</documentation> </annotation> </enumeration> <enumeration value="0271002"> <annotation> <documentation>Inlay</documentation> </annotation> </enumeration> <enumeration value="0271003"> <annotation> <documentation>patellare Komponente</documentation> </annotation> </enumeration> <enumeration value="0271004"> <annotation> <documentation>Kopplung</documentation> </annotation> </enumeration> <enumeration value="0271005"> <annotation> <documentation>mehrere</documentation> </annotation> </enumeration> <enumeration value="0271042"> <annotation> <documentation>andere</documentation> </annotation> </enumeration> </restriction> </simpleType> </pre> |

simpleType enum_0290

| | | | |
|------------|------------------------------|---------|---|
| namespace | http://xml.ir-d.de/sak | | |
| type | restriction of string | | |
| properties | base xs:string | | |
| facets | Kind | Value | Annotation |
| | enumeration | 0290001 | documentation Hüft-Komponente |
| | enumeration | 0290002 | documentation Knie-Komponente |
| | enumeration | 0290003 | documentation Modulare Komponente (Hüfte/Knie) |

| | |
|------------|--|
| annotation | documentation Kat_EP_Artikeltyp |
| source | <pre> <simpleType name="enum_0290"> <annotation> <documentation>Kat_EP_Artikeltyp</documentation> </annotation> <restriction base="xs:string"> <enumeration value="0290001"> <annotation> <documentation>Hüft-Komponente</documentation> </annotation> </enumeration> <enumeration value="0290002"> <annotation> <documentation>Knie-Komponente</documentation> </annotation> </enumeration> <enumeration value="0290003"> <annotation> <documentation>Modulare Komponente (Hüfte/Knie)</documentation> </annotation> </enumeration> </restriction> </simpleType> </pre> |

simpleType **enum_0291**

| | | | |
|------------|--|---------|------------------------------------|
| namespace | http://xml.ir-d.de/sak | | |
| type | restriction of string | | |
| properties | base xs:string | | |
| facets | Kind | Value | Annotation |
| | enumeration | 0291001 | documentation Knochen-Zement |
| | enumeration | 0291002 | documentation sonstiges Zubehör |
| annotation | documentation Kat_EP_ZubehoerTyp | | |
| source | <pre> <simpleType name="enum_0291"> <annotation> <documentation>Kat_EP_ZubehoerTyp</documentation> </annotation> <restriction base="xs:string"> <enumeration value="0291001"> <annotation> <documentation>Knochen-Zement</documentation> </annotation> </enumeration> <enumeration value="0291002"> <annotation> <documentation>sonstiges Zubehör</documentation> </annotation> </enumeration> </restriction> </simpleType> </pre> | | |

simpleType enum_0300

| | | | |
|------------|---|---------|---|
| namespace | http://xml.ir-d.de/sak | | |
| type | restriction of string | | |
| properties | base xs:string | | |
| facets | Kind | Value | Annotation |
| | enumeration | 0300001 | documentation konventionieller Aortenklappenersatz |
| | enumeration | 0300002 | documentation kathetergestützte Aortenklappenimplantation (TAVI) |
| annotation | documentation Kat_AK_ArtEingriff | | |
| source | <pre> <simpleType name="enum_0300"> <annotation> <documentation>Kat_AK_ArtEingriff</documentation> </annotation> <restriction base="xs:string"> <enumeration value="0300001"> <annotation> <documentation>konventionieller Aortenklappenersatz</documentation> </annotation> </enumeration> <enumeration value="0300002"> <annotation> <documentation>kathetergestützte Aortenklappenimplantation (TAVI)</documentation> </annotation> </enumeration> </restriction> </simpleType> </pre> | | |

simpleType enum_0302

| | | | |
|------------|---|---------|---|
| namespace | http://xml.ir-d.de/sak | | |
| type | restriction of string | | |
| properties | base xs:string | | |
| facets | Kind | Value | Annotation |
| | enumeration | 0302001 | documentation Stenose |
| | enumeration | 0302002 | documentation Insuffizienz |
| | enumeration | 0302003 | documentation Stenose und Insuffizienz |
| annotation | documentation Kat_AK_GrundEingriff | | |
| source | <pre> <simpleType name="enum_0302"> <annotation> <documentation>Kat_AK_GrundEingriff</documentation> </annotation> <restriction base="xs:string"> <enumeration value="0302001"> <annotation> <documentation>Stenose</documentation> </annotation> </enumeration> <enumeration value="0302002"> </pre> | | |

| | |
|--|---|
| | <pre> <annotation> <documentation>Insuffizienz</documentation> </annotation> </enumeration> <enumeration value="0302003"> <annotation> <documentation>Stenose und Insuffizienz</documentation> </annotation> </enumeration> </restriction> </simpleType> </pre> |
|--|---|

simpleType enum_0318

| | | | |
|------------|--|---------|-------------------------------------|
| namespace | http://xml.ir-d.de/sak | | |
| type | restriction of string | | |
| properties | base xs:string | | |
| facets | Kind | Value | Annotation |
| | enumeration | 0318001 | documentation transapikal |
| | enumeration | 0318002 | documentation transaortal |
| | enumeration | 0318003 | documentation transfemoral |
| | enumeration | 0318004 | documentation transaxillär |
| | enumeration | 0318042 | documentation anderer Zugangsweg |
| annotation | documentation Kat_AK_ZugangKatheter | | |
| source | <pre> <simpleType name="enum_0318"> <annotation> <documentation>Kat_AK_ZugangKatheter</documentation> </annotation> <restriction base="xs:string"> <enumeration value="0318001"> <annotation> <documentation>transapikal</documentation> </annotation> </enumeration> <enumeration value="0318002"> <annotation> <documentation>transaortal</documentation> </annotation> </enumeration> <enumeration value="0318003"> <annotation> <documentation>transfemoral</documentation> </annotation> </enumeration> <enumeration value="0318004"> <annotation> <documentation>transaxillär</documentation> </annotation> </enumeration> <enumeration value="0318042"> <annotation> </pre> | | |

| | |
|--|--|
| | <pre> <documentation>anderer Zugangsweg</documentation> </annotation> </enumeration> </restriction> </simpleType> </pre> |
|--|--|

simpleType enum_0320

| | | | |
|------------|--|---------|---|
| namespace | http://xml.ir-d.de/sak | | |
| type | restriction of string | | |
| properties | base xs:string | | |
| facets | Kind | Value | Annotation |
| | enumeration | 0320001 | documentation konventionelle Sternotomie |
| | enumeration | 0320002 | documentation partielle Sternotomie |
| | enumeration | 0320003 | documentation parasternaler Zugang |
| | enumeration | 0320042 | documentation anderer Zugangsweg |
| annotation | documentation Kat_AK_ZugangKonventionell | | |
| source | <pre> <simpleType name="enum_0320"> <annotation> <documentation>Kat_AK_ZugangKonventionell</documentation> </annotation> <restriction base="xs:string"> <enumeration value="0320001"> <annotation> <documentation>konventionelle Sternotomie</documentation> </annotation> </enumeration> <enumeration value="0320002"> <annotation> <documentation>partielle Sternotomie</documentation> </annotation> </enumeration> <enumeration value="0320003"> <annotation> <documentation>parasternaler Zugang</documentation> </annotation> </enumeration> <enumeration value="0320042"> <annotation> <documentation>anderer Zugangsweg</documentation> </annotation> </enumeration> </restriction> </simpleType> </pre> | | |

simpleType enum_0322

| | | | |
|-----------|------------------------------|--|--|
| namespace | http://xml.ir-d.de/sak | | |
| type | restriction of string | | |

| properties | base xs:string | | | | | | | | | | | | | | | | | | | | | |
|-------------|---|--|-------|------------|-------------|---------|-----------------------|-------------|---------|---|-------------|---------|---------------------------------------|-------------|---------|--|-------------|---------|----------------------------------|-------------|---------|----------------------------|
| facets | <table border="1"> <thead> <tr> <th>Kind</th> <th>Value</th> <th>Annotation</th> </tr> </thead> <tbody> <tr> <td>enumeration</td> <td>0322001</td> <td>documentation nein</td> </tr> <tr> <td>enumeration</td> <td>0322002</td> <td>documentation ja, diätetisch behandelt</td> </tr> <tr> <td>enumeration</td> <td>0322003</td> <td>documentation ja, orale Medikation</td> </tr> <tr> <td>enumeration</td> <td>0322004</td> <td>documentation ja, mit Insulin behandelt</td> </tr> <tr> <td>enumeration</td> <td>0322005</td> <td>documentation ja, unbehandelt</td> </tr> <tr> <td>enumeration</td> <td>0322099</td> <td>documentation unbekannt</td> </tr> </tbody> </table> | Kind | Value | Annotation | enumeration | 0322001 | documentation nein | enumeration | 0322002 | documentation ja, diätetisch behandelt | enumeration | 0322003 | documentation ja, orale Medikation | enumeration | 0322004 | documentation ja, mit Insulin behandelt | enumeration | 0322005 | documentation ja, unbehandelt | enumeration | 0322099 | documentation unbekannt |
| Kind | Value | Annotation | | | | | | | | | | | | | | | | | | | | |
| enumeration | 0322001 | documentation nein | | | | | | | | | | | | | | | | | | | | |
| enumeration | 0322002 | documentation ja, diätetisch behandelt | | | | | | | | | | | | | | | | | | | | |
| enumeration | 0322003 | documentation ja, orale Medikation | | | | | | | | | | | | | | | | | | | | |
| enumeration | 0322004 | documentation ja, mit Insulin behandelt | | | | | | | | | | | | | | | | | | | | |
| enumeration | 0322005 | documentation ja, unbehandelt | | | | | | | | | | | | | | | | | | | | |
| enumeration | 0322099 | documentation unbekannt | | | | | | | | | | | | | | | | | | | | |
| annotation | documentation Kat_AK_Diabetes | | | | | | | | | | | | | | | | | | | | | |
| source | <pre> <simpleType name="enum_0322"> <annotation> <documentation>Kat_AK_Diabetes</documentation> </annotation> <restriction base="xs:string"> <enumeration value="0322001"> <annotation> <documentation>nein</documentation> </annotation> </enumeration> <enumeration value="0322002"> <annotation> <documentation>ja, diätetisch behandelt</documentation> </annotation> </enumeration> <enumeration value="0322003"> <annotation> <documentation>ja, orale Medikation</documentation> </annotation> </enumeration> <enumeration value="0322004"> <annotation> <documentation>ja, mit Insulin behandelt</documentation> </annotation> </enumeration> <enumeration value="0322005"> <annotation> <documentation>ja, unbehandelt</documentation> </annotation> </enumeration> <enumeration value="0322099"> <annotation> <documentation>unbekannt</documentation> </annotation> </enumeration> </restriction> </simpleType> </pre> | | | | | | | | | | | | | | | | | | | | | |

simpleType enum_0324

| | |
|-----------|------------------------|
| namespace | http://xml.ir-d.de/sak |
|-----------|------------------------|

| | | | |
|------------|---|---------|---|
| type | restriction of string | | |
| properties | base xs:string | | |
| facets | Kind | Value | Annotation |
| | enumeration | 0324001 | documentation (I): Beschwerdefreiheit, normale körperliche Belastbarkeit |
| | enumeration | 0324002 | documentation (II): Beschwerden bei stärkerer körperlicher Belastung |
| | enumeration | 0324003 | documentation (III): Beschwerden bei leichter körperlicher Belastung |
| | enumeration | 0324004 | documentation (IV): Beschwerden in Ruhe |
| annotation | documentation Kat_AK_NYHA | | |
| source | <pre> <simpleType name="enum_0324"> <annotation> <documentation>Kat_AK_NYHA</documentation> </annotation> <restriction base="xs:string"> <enumeration value="0324001"> <annotation> <documentation>(I): Beschwerdefreiheit, normale körperliche Belastbarkeit</documentation> </annotation> </enumeration> <enumeration value="0324002"> <annotation> <documentation>(II): Beschwerden bei stärkerer körperlicher Belastung</documentation> </annotation> </enumeration> <enumeration value="0324003"> <annotation> <documentation>(III): Beschwerden bei leichter körperlicher Belastung</documentation> </annotation> </enumeration> <enumeration value="0324004"> <annotation> <documentation>(IV): Beschwerden in Ruhe</documentation> </annotation> </enumeration> </restriction> </simpleType> </pre> | | |

simpleType **enum_0330**

| | | | |
|------------|------------------------------|---------|---------------------------------------|
| namespace | http://xml.ir-d.de/sak | | |
| type | restriction of string | | |
| properties | base xs:string | | |
| facets | Kind | Value | Annotation |
| | enumeration | 0330001 | documentation ATS Medical |
| | enumeration | 0330002 | documentation Edwards Lifesciences |
| | enumeration | 0330003 | documentation Medtronic |

| | |
|------------|---|
| | <p>enumeration 0330004 documentation JenaValve</p> <p>enumeration 0330005 documentation Corcym</p> <p>enumeration 0330006 documentation Abbott Medical / St. Jude</p> <p>enumeration 0330007 documentation Symetis</p> <p>enumeration 0330008 documentation Direct Flow Medical</p> <p>enumeration 0330009 documentation Boston Scientific</p> <p>enumeration 0330010 documentation Artivion</p> <p>enumeration 0330011 documentation Biosensors</p> <p>enumeration 0330012 documentation LivaNova</p> <p>enumeration 0330013 documentation Meril</p> <p>enumeration 0330014 documentation nicht belegter Wert</p> <p>enumeration 0330015 documentation nicht belegter Wert</p> <p>enumeration 0330016 documentation nicht belegter Wert</p> <p>enumeration 0330017 documentation nicht belegter Wert</p> <p>enumeration 0330018 documentation nicht belegter Wert</p> <p>enumeration 0330042 documentation sonstiger Hersteller</p> |
| annotation | documentation Kat_AK_Hersteller |
| source | <pre> <simpleType name="enum_0330"> <annotation> <documentation>Kat_AK_Hersteller</documentation> </annotation> <restriction base="xs:string"> <enumeration value="0330001"> <annotation> <documentation>ATS Medical</documentation> </annotation> </enumeration> <enumeration value="0330002"> <annotation> <documentation>Edwards Lifesciences</documentation> </annotation> </enumeration> <enumeration value="0330003"> <annotation> <documentation>Medtronic</documentation> </annotation> </enumeration> <enumeration value="0330004"> <annotation> <documentation>JenaValve</documentation> </annotation> </enumeration> <enumeration value="0330005"> <annotation> <documentation>Corcym</documentation> </annotation> </enumeration> </restriction> </simpleType> </pre> |

```
</annotation>
</enumeration>
<enumeration value="0330006">
  <annotation>
    <documentation>Abbott Medical / St. Jude</documentation>
  </annotation>
</enumeration>
<enumeration value="0330007">
  <annotation>
    <documentation>Symetis</documentation>
  </annotation>
</enumeration>
<enumeration value="0330008">
  <annotation>
    <documentation>Direct Flow Medical</documentation>
  </annotation>
</enumeration>
<enumeration value="0330009">
  <annotation>
    <documentation>Boston Scientific</documentation>
  </annotation>
</enumeration>
<enumeration value="0330010">
  <annotation>
    <documentation>Artivion</documentation>
  </annotation>
</enumeration>
<enumeration value="0330011">
  <annotation>
    <documentation>Biosensors</documentation>
  </annotation>
</enumeration>
<enumeration value="0330012">
  <annotation>
    <documentation>LivaNova</documentation>
  </annotation>
</enumeration>
<enumeration value="0330013">
  <annotation>
    <documentation>Meril</documentation>
  </annotation>
</enumeration>
<enumeration value="0330014">
  <annotation>
    <documentation>nicht belegter Wert</documentation>
  </annotation>
</enumeration>
<enumeration value="0330015">
  <annotation>
    <documentation>nicht belegter Wert</documentation>
  </annotation>
</enumeration>
<enumeration value="0330016">
  <annotation>
    <documentation>nicht belegter Wert</documentation>
  </annotation>
</enumeration>
<enumeration value="0330017">
  <annotation>
```

| | |
|--|--|
| | <pre> <documentation>nicht belegter Wert</documentation> </annotation> </enumeration> <enumeration value="0330018"> <annotation> <documentation>nicht belegter Wert</documentation> </annotation> </enumeration> <enumeration value="0330042"> <annotation> <documentation>sonstiger Hersteller</documentation> </annotation> </enumeration> </restriction> </simpleType> </pre> |
|--|--|

simpleType enum 0338

| | | | |
|------------|--|---------|-----------------------------|
| namespace | http://xml.ir-d.de/sak | | |
| type | restriction of string | | |
| properties | base xs:string | | |
| facets | Kind | Value | Annotation |
| | enumeration | 0338001 | documentation LAD |
| | enumeration | 0338002 | documentation RCA |
| | enumeration | 0338003 | documentation RCX |
| | enumeration | 0338004 | documentation Hauptstamm |
| annotation | documentation Kat_AK_PCIArterien | | |
| source | <pre> <simpleType name="enum_0338"> <annotation> <documentation>Kat_AK_PCIArterien</documentation> </annotation> <restriction base="xs:string"> <enumeration value="0338001"> <annotation> <documentation>LAD</documentation> </annotation> </enumeration> <enumeration value="0338002"> <annotation> <documentation>RCA</documentation> </annotation> </enumeration> <enumeration value="0338003"> <annotation> <documentation>RCX</documentation> </annotation> </enumeration> <enumeration value="0338004"> <annotation> <documentation>Hauptstamm</documentation> </annotation> </enumeration> </restriction> </simpleType> </pre> | | |

| | |
|--|---|
| | <pre> </restriction> </simpleType> </pre> |
|--|---|

simpleType enum_0339

| | | | |
|------------|---|---------|-------------------------|
| namespace | http://xml.ir-d.de/sak | | |
| type | restriction of string | | |
| properties | base xs:string | | |
| facets | Kind | Value | Annotation |
| | enumeration | 0339001 | documentation TEE |
| | enumeration | 0339002 | documentation CT |
| | enumeration | 0339042 | documentation andere |
| annotation | documentation Kat_AK_AnnulusMessmethode | | |
| source | <pre> <simpleType name="enum_0339"> <annotation> <documentation>Kat_AK_AnnulusMessmethode</documentation> </annotation> <restriction base="xs:string"> <enumeration value="0339001"> <annotation> <documentation>TEE</documentation> </annotation> </enumeration> <enumeration value="0339002"> <annotation> <documentation>CT</documentation> </annotation> </enumeration> <enumeration value="0339042"> <annotation> <documentation>andere</documentation> </annotation> </enumeration> </restriction> </simpleType> </pre> | | |

simpleType enum_0341

| | | | |
|------------|------------------------------|---------|--|
| namespace | http://xml.ir-d.de/sak | | |
| type | restriction of string | | |
| properties | base xs:string | | |
| facets | Kind | Value | Annotation |
| | enumeration | 0341001 | documentation intraprozedural verstorben |
| | enumeration | 0341002 | documentation Implantation von mehr als einer Prothese |
| | enumeration | 0341003 | documentation gravierende Gefäß- oder Zugangskomplikation (gemäß VARC-3) |
| | enumeration | 0341004 | documentation erforderlicher chirurgischer oder interventioneller Eingriff wegen einer Klappenfehlfunktion (gemäß VARC-3) |

| | |
|------------|--|
| | enumeration 0341005 documentation >= große strukturelle kardiale Komplikation (gemäß VARC-3) |
| annotation | documentation Kat_AK_FailureGrund |
| source | <pre> <simpleType name="enum_0341"> <annotation> <documentation>Kat_AK_FailureGrund</documentation> </annotation> <restriction base="xs:string"> <enumeration value="0341001"> <annotation> <documentation>intraprozedural verstorben</documentation> </annotation> </enumeration> <enumeration value="0341002"> <annotation> <documentation>Implantation von mehr als einer Prothese</documentation> </annotation> </enumeration> <enumeration value="0341003"> <annotation> <documentation>gravierende Gefäß- oder Zugangskomplikation (gemäß VARC-3)</documentation> </annotation> </enumeration> <enumeration value="0341004"> <annotation> <documentation>erforderlicher chirurgischer oder interventioneller Eingriff wegen einer Klappenfehlfunktion (gemäß VARC-3)</documentation> </annotation> </enumeration> <enumeration value="0341005"> <annotation> <documentation>&gt;= große strukturelle kardiale Komplikation (gemäß VARC-3)</documentation> </annotation> </enumeration> </restriction> </simpleType> </pre> |

simpleType **enum 0342**

| | | | |
|------------|------------------------------|---------|--|
| namespace | http://xml.ir-d.de/sak | | |
| type | restriction of string | | |
| properties | base xs:string | | |
| facets | Kind | Value | Annotation |
| | enumeration | 0342001 | documentation Alter |
| | enumeration | 0342002 | documentation Frailty |
| | enumeration | 0342003 | documentation Hochrisiko |
| | enumeration | 0342004 | documentation Prognose-limitierende Zweiterkrankung |
| | enumeration | 0342005 | documentation Porzellan-Aorta |
| | enumeration | 0342042 | documentation |

| | |
|------------|--|
| | Sonstige |
| annotation | documentation Kat AK Tavi |
| source | <pre> <simpleType name="enum_0342"> <annotation> <documentation>Kat_AK_Tavi</documentation> </annotation> <restriction base="xs:string"> <enumeration value="0342001"> <annotation> <documentation>Alter</documentation> </annotation> </enumeration> <enumeration value="0342002"> <annotation> <documentation>Frailty</documentation> </annotation> </enumeration> <enumeration value="0342003"> <annotation> <documentation>Hochrisiko</documentation> </annotation> </enumeration> <enumeration value="0342004"> <annotation> <documentation>Prognose-limitierende Zweiterkrankung</documentation> </annotation> </enumeration> <enumeration value="0342005"> <annotation> <documentation>Porzellan-Aorta</documentation> </annotation> </enumeration> <enumeration value="0342042"> <annotation> <documentation>Sonstige</documentation> </annotation> </enumeration> </restriction> </simpleType> </pre> |

simpleType enum_0343

| | | | |
|------------|------------------------------|---------|---|
| namespace | http://xml.ir-d.de/sak | | |
| type | restriction of string | | |
| properties | base xs:string | | |
| facets | Kind | Value | Annotation |
| | enumeration | 0343001 | documentation Device-Fehlpositionierung |
| | enumeration | 0343002 | documentation Koronarostienverschluss |
| | enumeration | 0343003 | documentation Aortendissektion |
| | enumeration | 0343004 | documentation Aortenregurgitation > = 2. Grades |
| | enumeration | 0343005 | documentation Annulus-Ruptur |

| | |
|------------|---|
| | <p>enumeration 0343006 documentation Ruptur-/Perforation einer Herzhöhle ohne Therapiebedarf</p> <p>enumeration 0343007 documentation Ruptur-/Perforation einer Herzhöhle mit Therapiebedarf</p> <p>enumeration 0343008 documentation Perikardtamponade</p> <p>enumeration 0343009 documentation kardiale Dekompensation</p> <p>enumeration 0343010 documentation Hirnembolie</p> <p>enumeration 0343011 documentation Rhythmusstörungen</p> <p>enumeration 0343012 documentation Device-Embolisation</p> <p>enumeration 0343013 documentation vaskuläre Komplikation</p> <p>enumeration 0343014 documentation Low Cardiac Output</p> <p>enumeration 0343015 documentation schwerwiegende Blutungen (intraprozedural)</p> <p>enumeration 0343016 documentation lebensbedrohliche Blutungen (intraprozedural)</p> <p>enumeration 0343017 documentation Patient verstarb im OP/Katheterlabor</p> <p>enumeration 0343042 documentation sonstige intraprozedurale Komplikationen</p> |
| annotation | documentation Kat_AK_KomplikationTyp |
| source | <pre> <simpleType name="enum_0343"> <annotation> <documentation>Kat_AK_KomplikationTyp</documentation> </annotation> <restriction base="xs:string"> <enumeration value="0343001"> <annotation> <documentation>Device-Fehlpositionierung</documentation> </annotation> </enumeration> <enumeration value="0343002"> <annotation> <documentation>Koronarostienverschluss</documentation> </annotation> </enumeration> <enumeration value="0343003"> <annotation> <documentation>Aortendissektion</documentation> </annotation> </enumeration> <enumeration value="0343004"> <annotation> <documentation>Aortenregurgitation &gt; = 2. Grades</documentation> </annotation> </enumeration> <enumeration value="0343005"> <annotation> <documentation>Annulus-Ruptur</documentation> </annotation> </enumeration> <enumeration value="0343006"> <annotation> <documentation>Ruptur-/Perforation einer Herzhöhle ohne </pre> |

```

Therapiebedarf</documentation>
  </annotation>
</enumeration>
<enumeration value="0343007">
  <annotation>
    <documentation>Ruptur-/Perforation einer Herzhöhle mit
Therapiebedarf</documentation>
  </annotation>
</enumeration>
<enumeration value="0343008">
  <annotation>
    <documentation>Perikardtamponade</documentation>
  </annotation>
</enumeration>
<enumeration value="0343009">
  <annotation>
    <documentation>kardiale Dekompensation</documentation>
  </annotation>
</enumeration>
<enumeration value="0343010">
  <annotation>
    <documentation>Hirnembolie</documentation>
  </annotation>
</enumeration>
<enumeration value="0343011">
  <annotation>
    <documentation>Rhythmusstörungen</documentation>
  </annotation>
</enumeration>
<enumeration value="0343012">
  <annotation>
    <documentation>Device-Embolisation</documentation>
  </annotation>
</enumeration>
<enumeration value="0343013">
  <annotation>
    <documentation>vaskuläre Komplikation</documentation>
  </annotation>
</enumeration>
<enumeration value="0343014">
  <annotation>
    <documentation>Low Cardiac Output</documentation>
  </annotation>
</enumeration>
<enumeration value="0343015">
  <annotation>
    <documentation>schwerwiegende Blutungen
(intraprozedural)</documentation>
  </annotation>
</enumeration>
<enumeration value="0343016">
  <annotation>
    <documentation>lebensbedrohliche Blutungen
(intraprozedural)</documentation>
  </annotation>
</enumeration>
<enumeration value="0343017">
  <annotation>
    <documentation>Patient verstarb im OP/Katheterlabor</documentation>

```

| | |
|--|--|
| | <pre> </annotation> </enumeration> <enumeration value="0343042"> <annotation> <documentation>sonstige intraprozedurale Komplikationen</documentation> </annotation> </enumeration> </restriction> </simpleType> </pre> |
|--|--|

simpleType enum_0346

| | | | |
|------------|--|---------|--|
| namespace | http://xml.ir-d.de/sak | | |
| type | restriction of string | | |
| properties | base xs:string | | |
| facets | Kind | Value | Annotation |
| | enumeration | 0346001 | documentation keine Therapie erforderlich |
| | enumeration | 0346002 | documentation medikamentös |
| | enumeration | 0346003 | documentation IABP |
| | enumeration | 0346004 | documentation VAD |
| | enumeration | 0346005 | documentation ECMO |
| | enumeration | 0346042 | documentation sonstige |
| annotation | documentation Kat_AK_TherapieLCO | | |
| source | <pre> <simpleType name="enum_0346"> <annotation> <documentation>Kat_AK_TherapieLCO</documentation> </annotation> <restriction base="xs:string"> <enumeration value="0346001"> <annotation> <documentation>keine Therapie erforderlich</documentation> </annotation> </enumeration> <enumeration value="0346002"> <annotation> <documentation>medikamentös</documentation> </annotation> </enumeration> <enumeration value="0346003"> <annotation> <documentation>IABP</documentation> </annotation> </enumeration> <enumeration value="0346004"> <annotation> <documentation>VAD</documentation> </annotation> </enumeration> <enumeration value="0346005"> </pre> | | |

| | |
|--|---|
| | <pre> <annotation> <documentation>ECMO</documentation> </annotation> </enumeration> <enumeration value="0346042"> <annotation> <documentation>sonstige</documentation> </annotation> </enumeration> </restriction> </simpleType> </pre> |
|--|---|

simpleType enum_0347

| | | | |
|------------|---|---------|---|
| namespace | http://xml.ir-d.de/sak | | |
| type | restriction of string | | |
| properties | base xs:string | | |
| facets | Kind | Value | Annotation |
| | enumeration | 0347001 | documentation Einzeleingriff |
| | enumeration | 0347002 | documentation Kombinationseingriff mit mehreren Prozeduren |
| annotation | documentation Kat_AK_Eingriffsumfang | | |
| source | <pre> <simpleType name="enum_0347"> <annotation> <documentation>Kat_AK_Eingriffsumfang</documentation> </annotation> <restriction base="xs:string"> <enumeration value="0347001"> <annotation> <documentation>Einzeleingriff</documentation> </annotation> </enumeration> <enumeration value="0347002"> <annotation> <documentation>Kombinationseingriff mit mehreren Prozeduren</documentation> </annotation> </enumeration> </restriction> </simpleType> </pre> | | |

simpleType enum_0348

| | | | |
|------------|------------------------------|---------|---------------------------|
| namespace | http://xml.ir-d.de/sak | | |
| type | restriction of string | | |
| properties | base xs:string | | |
| facets | Kind | Value | Annotation |
| | enumeration | 0348001 | documentation mit HLM |
| | enumeration | 0348002 | documentation ohne HLM |
| | enumeration | 0348003 | documentation |

| | |
|------------|---|
| | Umstieg von OP ohne HLM auf OP mit HLM |
| annotation | documentation Kat_AK_OPVorgehen |
| source | <pre> <simpleType name="enum_0348"> <annotation> <documentation>Kat_AK_OPVorgehen</documentation> </annotation> <restriction base="xs:string"> <enumeration value="0348001"> <annotation> <documentation>mit HLM</documentation> </annotation> </enumeration> <enumeration value="0348002"> <annotation> <documentation>ohne HLM</documentation> </annotation> </enumeration> <enumeration value="0348003"> <annotation> <documentation>Umstieg von OP ohne HLM auf OP mit HLM</documentation> </annotation> </enumeration> </restriction> </simpleType> </pre> |

simpleType enum_0350

| | | | |
|------------|--|---------|--------------------------|
| namespace | http://xml.ir-d.de/sak | | |
| type | restriction of string | | |
| properties | base xs:string | | |
| facets | Kind | Value | Annotation |
| | enumeration | 0350001 | documentation IABP |
| | enumeration | 0350002 | documentation Impella |
| | enumeration | 0350003 | documentation vv ECMO |
| | enumeration | 0350004 | documentation va ECMO |
| | enumeration | 0350042 | documentation andere |
| annotation | documentation Kat_AK_Methode | | |
| source | <pre> <simpleType name="enum_0350"> <annotation> <documentation>Kat_AK_Methode</documentation> </annotation> <restriction base="xs:string"> <enumeration value="0350001"> <annotation> <documentation>IABP</documentation> </annotation> </enumeration> <enumeration value="0350002"> <annotation> <documentation>Impella</documentation> </annotation> </enumeration> </restriction> </simpleType> </pre> | | |

| | |
|--|--|
| | <pre> </annotation> </enumeration> <enumeration value="0350003"> <annotation> <documentation>vv ECMO</documentation> </annotation> </enumeration> <enumeration value="0350004"> <annotation> <documentation>va ECMO</documentation> </annotation> </enumeration> <enumeration value="0350042"> <annotation> <documentation>andere</documentation> </annotation> </enumeration> </restriction> </simpleType> </pre> |
|--|--|

simpleType enum_0351

| | | | |
|------------|--|---------|---|
| namespace | http://xml.ir-d.de/sak | | |
| type | restriction of string | | |
| properties | base xs:string | | |
| facets | Kind | Value | Annotation |
| | enumeration | 0351001 | documentation nein |
| | enumeration | 0351002 | documentation ja, zu Sternotomie |
| | enumeration | 0351003 | documentation ja, zu transapikal |
| | enumeration | 0351004 | documentation ja, zu transaortal |
| | enumeration | 0351005 | documentation ja, zu transfemoral |
| | enumeration | 0351006 | documentation ja, zu transaxillär |
| | enumeration | 0351007 | documentation ja, zu anderem endovaskulären Zugang |
| | enumeration | 0351042 | documentation ja, zu anderem Zugang |
| annotation | documentation Kat_AK_Konversion | | |
| source | <pre> <simpleType name="enum_0351"> <annotation> <documentation>Kat_AK_Konversion</documentation> </annotation> <restriction base="xs:string"> <enumeration value="0351001"> <annotation> <documentation>nein</documentation> </annotation> </enumeration> <enumeration value="0351002"> <annotation> <documentation>ja, zu Sternotomie</documentation> </annotation> </enumeration> </restriction> </simpleType> </pre> | | |

```

</enumeration>
<enumeration value="0351003">
  <annotation>
    <documentation>ja, zu transapikal</documentation>
  </annotation>
</enumeration>
<enumeration value="0351004">
  <annotation>
    <documentation>ja, zu transaortal</documentation>
  </annotation>
</enumeration>
<enumeration value="0351005">
  <annotation>
    <documentation>ja, zu transfemoral</documentation>
  </annotation>
</enumeration>
<enumeration value="0351006">
  <annotation>
    <documentation>ja, zu transaxillär</documentation>
  </annotation>
</enumeration>
<enumeration value="0351007">
  <annotation>
    <documentation>ja, zu anderem endovaskulären Zugang</documentation>
  </annotation>
</enumeration>
<enumeration value="0351042">
  <annotation>
    <documentation>ja, zu anderem Zugang</documentation>
  </annotation>
</enumeration>
</restriction>
</simpleType>

```

simpleType enum_0352

| | | | |
|------------|---|---------|---|
| namespace | http://xml.lir-d.de/sak | | |
| type | restriction of string | | |
| properties | base xs:string | | |
| facets | Kind | Value | Annotation |
| | enumeration | 0352001 | documentation nein |
| | enumeration | 0352002 | documentation ja, Intubationsnarkose |
| | enumeration | 0352003 | documentation ja, Maskenbeatmung, incl. LAMA |
| | enumeration | 0352042 | documentation ja, unbekannt welche |
| annotation | documentation Kat_AK_Anaesthesie | | |
| source | <pre> <simpleType name="enum_0352"> <annotation> <documentation>Kat_AK_Anaesthesie</documentation> </annotation> <restriction base="xs:string"> <enumeration value="0352001"> <annotation> </pre> | | |

| | |
|--|--|
| | <pre> <documentation>nein</documentation> </annotation> </enumeration> <enumeration value="0352002"> <annotation> <documentation>ja, Intubationsnarkose</documentation> </annotation> </enumeration> <enumeration value="0352003"> <annotation> <documentation>ja, Maskenbeatmung, incl. LAMA</documentation> </annotation> </enumeration> <enumeration value="0352042"> <annotation> <documentation>ja, unbekannt welche</documentation> </annotation> </enumeration> </restriction> </simpleType> </pre> |
|--|--|

simpleType enum_0353

| | | | |
|------------|---|---------|-----------------------------------|
| namespace | http://xml.ir-d.de/sak | | |
| type | restriction of string | | |
| properties | base xs:string | | |
| facets | Kind | Value | Annotation |
| | enumeration | 0353001 | documentation keine |
| | enumeration | 0353002 | documentation leichtgradig |
| | enumeration | 0353003 | documentation mittelgradig |
| | enumeration | 0353004 | documentation hochgradig |
| | enumeration | 0353099 | documentation nicht bestimmbar |
| annotation | documentation Kat_AK_ResidualeArteninsuffizienz | | |
| source | <pre> <simpleType name="enum_0353"> <annotation> <documentation>Kat_AK_ResidualeArteninsuffizienz</documentation> </annotation> <restriction base="xs:string"> <enumeration value="0353001"> <annotation> <documentation>keine</documentation> </annotation> </enumeration> <enumeration value="0353002"> <annotation> <documentation>leichtgradig</documentation> </annotation> </enumeration> <enumeration value="0353003"> <annotation> <documentation>mittelgradig</documentation> </pre> | | |

| | |
|--|--|
| | <pre> </annotation> </enumeration> <enumeration value="0353004"> <annotation> <documentation>hochgradig</documentation> </annotation> </enumeration> <enumeration value="0353099"> <annotation> <documentation>nicht bestimmbar</documentation> </annotation> </enumeration> </restriction> </simpleType> </pre> |
|--|--|

simpleType enum_0354

| | | | |
|------------|--|---------|------------------------------------|
| namespace | http://xml.ir-d.de/sak | | |
| type | restriction of string | | |
| properties | base xs:string | | |
| facets | Kind | Value | Annotation |
| | enumeration | 0354001 | documentation chirurgisch-offen |
| | enumeration | 0354002 | documentation Verschluss-System |
| | enumeration | 0354042 | documentation sonstige |
| annotation | documentation Kat_AK_Zugangswegverschluss | | |
| source | <pre> <simpleType name="enum_0354"> <annotation> <documentation>Kat_AK_Zugangswegverschluss</documentation> </annotation> <restriction base="xs:string"> <enumeration value="0354001"> <annotation> <documentation>chirurgisch-offen</documentation> </annotation> </enumeration> <enumeration value="0354002"> <annotation> <documentation>Verschluss-System</documentation> </annotation> </enumeration> <enumeration value="0354042"> <annotation> <documentation>sonstige</documentation> </annotation> </enumeration> </restriction> </simpleType> </pre> | | |

simpleType enum_0357

| | |
|-----------|------------------------|
| namespace | http://xml.ir-d.de/sak |
|-----------|------------------------|

| | | | |
|------------|---|---------|--|
| type | restriction of string | | |
| properties | base xs:string | | |
| facets | Kind | Value | Annotation |
| | enumeration | 0357001 | documentation keine KHK |
| | enumeration | 0357002 | documentation 1-Gefäßerkrankung |
| | enumeration | 0357003 | documentation 2-Gefäßerkrankung |
| | enumeration | 0357004 | documentation 3-Gefäßerkrankung |
| | enumeration | 0357005 | documentation keine koronare Bildgebung |
| annotation | documentation Kat_AK_BefundBildgebung | | |
| source | <pre> <simpleType name="enum_0357"> <annotation> <documentation>Kat_AK_BefundBildgebung</documentation> </annotation> <restriction base="xs:string"> <enumeration value="0357001"> <annotation> <documentation>keine KHK</documentation> </annotation> </enumeration> <enumeration value="0357002"> <annotation> <documentation>1-Gefäßerkrankung</documentation> </annotation> </enumeration> <enumeration value="0357003"> <annotation> <documentation>2-Gefäßerkrankung</documentation> </annotation> </enumeration> <enumeration value="0357004"> <annotation> <documentation>3-Gefäßerkrankung</documentation> </annotation> </enumeration> <enumeration value="0357005"> <annotation> <documentation>keine koronare Bildgebung</documentation> </annotation> </enumeration> </restriction> </simpleType> </pre> | | |

simpleType **enum_0358**

| | | | |
|------------|------------------------------|---------|--------------------|
| namespace | http://xml.ir-d.de/sak | | |
| type | restriction of string | | |
| properties | base xs:string | | |
| facets | Kind | Value | Annotation |
| | enumeration | 0358001 | documentation 0 |

| | |
|------------|--|
| | <p>enumeration 0358002 documentation 1</p> <p>enumeration 0358003 documentation 2</p> <p>enumeration 0358004 documentation 3</p> <p>enumeration 0358005 documentation 4</p> <p>enumeration 0358006 documentation 5 oder mehr</p> <p>enumeration 0358098 documentation genaue Anzahl unbekannt (aber mind. 1)</p> <p>enumeration 0358099 documentation unbekannt</p> |
| annotation | documentation Kat_AK_AnzahlVorOP |
| source | <pre> <simpleType name="enum_0358"> <annotation> <documentation>Kat_AK_AnzahlVorOP</documentation> </annotation> <restriction base="xs:string"> <enumeration value="0358001"> <annotation> <documentation>0</documentation> </annotation> </enumeration> <enumeration value="0358002"> <annotation> <documentation>1</documentation> </annotation> </enumeration> <enumeration value="0358003"> <annotation> <documentation>2</documentation> </annotation> </enumeration> <enumeration value="0358004"> <annotation> <documentation>3</documentation> </annotation> </enumeration> <enumeration value="0358005"> <annotation> <documentation>4</documentation> </annotation> </enumeration> <enumeration value="0358006"> <annotation> <documentation>5 oder mehr</documentation> </annotation> </enumeration> <enumeration value="0358098"> <annotation> <documentation>genaue Anzahl unbekannt (aber mind. 1)</documentation> </annotation> </enumeration> <enumeration value="0358099"> <annotation> <documentation>unbekannt</documentation> </annotation> </enumeration> </restriction> </simpleType> </pre> |

| | |
|--|--|
| | <pre> </enumeration> </restriction> </simpleType> </pre> |
|--|--|

simpleType enum_0359

| | | | |
|------------|--|---------|----------------------------------|
| namespace | http://xml.ir-d.de/sak | | |
| type | restriction of string | | |
| properties | base xs:string | | |
| facets | Kind | Value | Annotation |
| | enumeration | 0359001 | documentation nein |
| | enumeration | 0359002 | documentation ja - einseitig |
| | enumeration | 0359003 | documentation ja - beidseitig |
| | enumeration | 0359042 | documentation unbekannt |
| annotation | documentation Kat_AK_LVOT | | |
| source | <pre> <simpleType name="enum_0359"> <annotation> <documentation>Kat_AK_LVOT</documentation> </annotation> <restriction base="xs:string"> <enumeration value="0359001"> <annotation> <documentation>nein</documentation> </annotation> </enumeration> <enumeration value="0359002"> <annotation> <documentation>ja - einseitig</documentation> </annotation> </enumeration> <enumeration value="0359003"> <annotation> <documentation>ja - beidseitig</documentation> </annotation> </enumeration> <enumeration value="0359042"> <annotation> <documentation>unbekannt</documentation> </annotation> </enumeration> </restriction> </simpleType> </pre> | | |

simpleType enum_0360

| | | | |
|------------|------------------------------|-------|------------|
| namespace | http://xml.ir-d.de/sak | | |
| type | restriction of string | | |
| properties | base xs:string | | |
| facets | Kind | Value | Annotation |

| | |
|------------|--|
| | <p>enumeration 0360001 documentation keine</p> <p>enumeration 0360002 documentation leichtgradig</p> <p>enumeration 0360003 documentation mittelgradig</p> <p>enumeration 0360004 documentation hochgradig</p> <p>enumeration 0360005 documentation massive</p> <p>enumeration 0360006 documentation torrential</p> <p>enumeration 0360099 documentation unbekannt</p> |
| annotation | documentation Kat_AK_TriskupidalInsuffizienz |
| source | <pre> <simpleType name="enum_0360"> <annotation> <documentation>Kat_AK_TriskupidalInsuffizienz</documentation> </annotation> <restriction base="xs:string"> <enumeration value="0360001"> <annotation> <documentation>keine</documentation> </annotation> </enumeration> <enumeration value="0360002"> <annotation> <documentation>leichtgradig</documentation> </annotation> </enumeration> <enumeration value="0360003"> <annotation> <documentation>mittelgradig</documentation> </annotation> </enumeration> <enumeration value="0360004"> <annotation> <documentation>hochgradig</documentation> </annotation> </enumeration> <enumeration value="0360005"> <annotation> <documentation>massive</documentation> </annotation> </enumeration> <enumeration value="0360006"> <annotation> <documentation>torrential</documentation> </annotation> </enumeration> <enumeration value="0360099"> <annotation> <documentation>unbekannt</documentation> </annotation> </enumeration> </restriction> </simpleType> </pre> |

simpleType enum_0361

| | | | |
|------------|--|---------|---|
| namespace | http://xml.ir-d.de/sak | | |
| type | restriction of string | | |
| properties | base xs:string | | |
| facets | Kind | Value | Annotation |
| | enumeration | 0361001 | documentation nein |
| | enumeration | 0361002 | documentation ja, letzte(r) innerhalb der letzten 48 Stunden |
| | enumeration | 0361003 | documentation ja, letzte(r) innerhalb der letzten 21 Tage |
| | enumeration | 0361004 | documentation ja, letzte(r) länger als 21 Tage |
| | enumeration | 0361098 | documentation ja, letzter Zeitpunkt unbekannt |
| | enumeration | 0361099 | documentation unbekannt |
| annotation | documentation Kat_AK_SchockReanimation | | |
| source | <pre> <simpleType name="enum_0361"> <annotation> <documentation>Kat_AK_SchockReanimation</documentation> </annotation> <restriction base="xs:string"> <enumeration value="0361001"> <annotation> <documentation>nein</documentation> </annotation> </enumeration> <enumeration value="0361002"> <annotation> <documentation>ja, letzte(r) innerhalb der letzten 48 Stunden</documentation> </annotation> </enumeration> <enumeration value="0361003"> <annotation> <documentation>ja, letzte(r) innerhalb der letzten 21 Tage</documentation> </annotation> </enumeration> <enumeration value="0361004"> <annotation> <documentation>ja, letzte(r) länger als 21 Tage</documentation> </annotation> </enumeration> <enumeration value="0361098"> <annotation> <documentation>ja, letzter Zeitpunkt unbekannt</documentation> </annotation> </enumeration> <enumeration value="0361099"> <annotation> <documentation>unbekannt</documentation> </annotation> </enumeration> </restriction> </pre> | | |

| | |
|--|----------------------------------|
| | <code></simpleType></code> |
|--|----------------------------------|

simpleType enum_0362

| namespace | http://xml.ir-d.de/sak | | | | | | | | | | | | |
|-------------|---|---------------------------------------|-------|------------|-------------|---------|--------------------------------|-------------|---------|---------------------------------|-------------|---------|---------------------------------------|
| type | restriction of string | | | | | | | | | | | | |
| properties | base xs:string | | | | | | | | | | | | |
| facets | <table><thead><tr><th>Kind</th><th>Value</th><th>Annotation</th></tr></thead><tbody><tr><td>enumeration</td><td>0362001</td><td>documentation Sinusrhythmus</td></tr><tr><td>enumeration</td><td>0362002</td><td>documentation Vorhofflimmern</td></tr><tr><td>enumeration</td><td>0362042</td><td>documentation anderer Herzrhythmus</td></tr></tbody></table> | Kind | Value | Annotation | enumeration | 0362001 | documentation Sinusrhythmus | enumeration | 0362002 | documentation Vorhofflimmern | enumeration | 0362042 | documentation anderer Herzrhythmus |
| Kind | Value | Annotation | | | | | | | | | | | |
| enumeration | 0362001 | documentation Sinusrhythmus | | | | | | | | | | | |
| enumeration | 0362002 | documentation Vorhofflimmern | | | | | | | | | | | |
| enumeration | 0362042 | documentation anderer Herzrhythmus | | | | | | | | | | | |
| annotation | documentation Kat_AK_Herzrhythmus | | | | | | | | | | | | |
| source | <pre><simpleType name="enum_0362"> <annotation> <documentation>Kat_AK_Herzrhythmus</documentation> </annotation> <restriction base="xs:string"> <enumeration value="0362001"> <annotation> <documentation>Sinusrhythmus</documentation> </annotation> </enumeration> <enumeration value="0362002"> <annotation> <documentation>Vorhofflimmern</documentation> </annotation> </enumeration> <enumeration value="0362042"> <annotation> <documentation>anderer Herzrhythmus</documentation> </annotation> </enumeration> </restriction> </simpleType></pre> | | | | | | | | | | | | |

simpleType enum_0363

| namespace | http://xml.ir-d.de/sak | | | | | | | | | | | | | | | |
|-------------|--|--------------------------------|-------|------------|-------------|---------|-----------------------|-------------|---------|-----------------------------|-------------|---------|--------------------------------|-------------|---------|----------------------------|
| type | restriction of string | | | | | | | | | | | | | | | |
| properties | base xs:string | | | | | | | | | | | | | | | |
| facets | <table><thead><tr><th>Kind</th><th>Value</th><th>Annotation</th></tr></thead><tbody><tr><td>enumeration</td><td>0363001</td><td>documentation nein</td></tr><tr><td>enumeration</td><td>0363002</td><td>documentation paroxysmal</td></tr><tr><td>enumeration</td><td>0363003</td><td>documentation persistierend</td></tr><tr><td>enumeration</td><td>0363004</td><td>documentation permanent</td></tr></tbody></table> | Kind | Value | Annotation | enumeration | 0363001 | documentation nein | enumeration | 0363002 | documentation paroxysmal | enumeration | 0363003 | documentation persistierend | enumeration | 0363004 | documentation permanent |
| Kind | Value | Annotation | | | | | | | | | | | | | | |
| enumeration | 0363001 | documentation nein | | | | | | | | | | | | | | |
| enumeration | 0363002 | documentation paroxysmal | | | | | | | | | | | | | | |
| enumeration | 0363003 | documentation persistierend | | | | | | | | | | | | | | |
| enumeration | 0363004 | documentation permanent | | | | | | | | | | | | | | |
| annotation | documentation Kat_AK_Vorhofflimmern | | | | | | | | | | | | | | | |

| | |
|--------|--|
| source | <pre> <simpleType name="enum_0363"> <annotation> <documentation>Kat_AK_Vorhofflimmern</documentation> </annotation> <restriction base="xs:string"> <enumeration value="0363001"> <annotation> <documentation>nein</documentation> </annotation> </enumeration> <enumeration value="0363002"> <annotation> <documentation>paroxysmal</documentation> </annotation> </enumeration> <enumeration value="0363003"> <annotation> <documentation>persistierend</documentation> </annotation> </enumeration> <enumeration value="0363004"> <annotation> <documentation>permanent</documentation> </annotation> </enumeration> </restriction> </simpleType> </pre> |
|--------|--|

simpleType enum 0364

| | | | |
|------------|--|---------|--|
| namespace | http://xml.lir-d.de/sak | | |
| type | restriction of string | | |
| properties | base xs:string | | |
| facets | Kind | Value | Annotation |
| | enumeration | 0364001 | documentation nein |
| | enumeration | 0364002 | documentation Schrittmacher ohne CRT-System |
| | enumeration | 0364003 | documentation Schrittmacher mit CRT-System |
| | enumeration | 0364004 | documentation Defibrillator ohne CRT-System |
| | enumeration | 0364005 | documentation Defibrillator mit CRT-System |
| annotation | documentation Kat_AK_SchrittmacherDefi | | |
| source | <pre> <simpleType name="enum_0364"> <annotation> <documentation>Kat_AK_SchrittmacherDefi</documentation> </annotation> <restriction base="xs:string"> <enumeration value="0364001"> <annotation> <documentation>nein</documentation> </annotation> </enumeration> <enumeration value="0364002"> </pre> | | |

| | |
|--|---|
| | <pre> <annotation> <documentation>Schrittmacher ohne CRT-System</documentation> </annotation> </enumeration> <enumeration value="0364003"> <annotation> <documentation>Schrittmacher mit CRT-System</documentation> </annotation> </enumeration> <enumeration value="0364004"> <annotation> <documentation>Defibrillator ohne CRT-System</documentation> </annotation> </enumeration> <enumeration value="0364005"> <annotation> <documentation>Defibrillator mit CRT-System</documentation> </annotation> </enumeration> </restriction> </simpleType> </pre> |
|--|---|

simpleType enum_0365

| | | | |
|------------|---|---------|--------------------------------------|
| namespace | http://xml.ir-d.de/sak | | |
| type | restriction of string | | |
| properties | base xs:string | | |
| facets | Kind | Value | Annotation |
| | enumeration | 0365001 | documentation nein |
| | enumeration | 0365002 | documentation ja, operativ |
| | enumeration | 0365003 | documentation ja, interventionell |
| annotation | documentation Kat_AK_MyokardRevaskularisation | | |
| source | <pre> <simpleType name="enum_0365"> <annotation> <documentation>Kat_AK_MyokardRevaskularisation</documentation> </annotation> <restriction base="xs:string"> <enumeration value="0365001"> <annotation> <documentation>nein</documentation> </annotation> </enumeration> <enumeration value="0365002"> <annotation> <documentation>ja, operativ</documentation> </annotation> </enumeration> <enumeration value="0365003"> <annotation> <documentation>ja, interventionell</documentation> </annotation> </enumeration> </restriction> </pre> | | |

| | |
|--|----------------------------------|
| | <code></simpleType></code> |
|--|----------------------------------|

simpleType enum_0366

| namespace | http://xml.ir-d.de/sak | | | | | | | | | | | | | | | | | | |
|-------------|---|--|-------|------------|-------------|---------|-----------------------|-------------|---------|--------------------------------------|-------------|---------|--|-------------|---------|------------------------------------|-------------|---------|----------------------------|
| type | restriction of string | | | | | | | | | | | | | | | | | | |
| properties | base xs:string | | | | | | | | | | | | | | | | | | |
| facets | <table><thead><tr><th>Kind</th><th>Value</th><th>Annotation</th></tr></thead><tbody><tr><td>enumeration</td><td>0366001</td><td>documentation nein</td></tr><tr><td>enumeration</td><td>0366002</td><td>documentation ja, &lt;= 6 Stunden</td></tr><tr><td>enumeration</td><td>0366003</td><td>documentation ja, &gt; 6 Stunden bis &lt;= 3 Monate</td></tr><tr><td>enumeration</td><td>0366004</td><td>documentation ja, &gt; 3 Monate</td></tr><tr><td>enumeration</td><td>0366099</td><td>documentation unbekannt</td></tr></tbody></table> | Kind | Value | Annotation | enumeration | 0366001 | documentation nein | enumeration | 0366002 | documentation ja, <= 6 Stunden | enumeration | 0366003 | documentation ja, > 6 Stunden bis <= 3 Monate | enumeration | 0366004 | documentation ja, > 3 Monate | enumeration | 0366099 | documentation unbekannt |
| Kind | Value | Annotation | | | | | | | | | | | | | | | | | |
| enumeration | 0366001 | documentation nein | | | | | | | | | | | | | | | | | |
| enumeration | 0366002 | documentation ja, <= 6 Stunden | | | | | | | | | | | | | | | | | |
| enumeration | 0366003 | documentation ja, > 6 Stunden bis <= 3 Monate | | | | | | | | | | | | | | | | | |
| enumeration | 0366004 | documentation ja, > 3 Monate | | | | | | | | | | | | | | | | | |
| enumeration | 0366099 | documentation unbekannt | | | | | | | | | | | | | | | | | |
| annotation | documentation Kat_AK_PCI | | | | | | | | | | | | | | | | | | |
| source | <pre><simpleType name="enum_0366"> <annotation> <documentation>Kat_AK_PCI</documentation> </annotation> <restriction base="xs:string"> <enumeration value="0366001"> <annotation> <documentation>nein</documentation> </annotation> </enumeration> <enumeration value="0366002"> <annotation> <documentation>ja, &lt;= 6 Stunden</documentation> </annotation> </enumeration> <enumeration value="0366003"> <annotation> <documentation>ja, &gt; 6 Stunden bis &lt;= 3 Monate</documentation> </annotation> </enumeration> <enumeration value="0366004"> <annotation> <documentation>ja, &gt; 3 Monate</documentation> </annotation> </enumeration> <enumeration value="0366099"> <annotation> <documentation>unbekannt</documentation> </annotation> </enumeration> </restriction> </simpleType></pre> | | | | | | | | | | | | | | | | | | |

simpleType enum_0367

| | |
|-----------|------------------------|
| namespace | http://xml.ir-d.de/sak |
|-----------|------------------------|

| | | | |
|------------|--|---------|--|
| type | restriction of string | | |
| properties | base xs:string | | |
| facets | Kind | Value | Annotation |
| | enumeration | 0367001 | documentation keine |
| | enumeration | 0367002 | documentation Mediastinitis |
| | enumeration | 0367003 | documentation Sepsis |
| | enumeration | 0367004 | documentation broncho-pulmonale Infektion |
| | enumeration | 0367005 | documentation oto-laryngologische Infektion |
| | enumeration | 0367006 | documentation floride Endokarditis |
| | enumeration | 0367007 | documentation Peritonitis |
| | enumeration | 0367008 | documentation Wundinfektion Thorax |
| | enumeration | 0367009 | documentation Pleuraempyem |
| | enumeration | 0367010 | documentation Venenkatheterinfektion |
| | enumeration | 0367011 | documentation Harnwegsinfektion |
| | enumeration | 0367012 | documentation Wundinfektion untere Extremitäten |
| | enumeration | 0367013 | documentation HIV-Infektion |
| | enumeration | 0367014 | documentation Hepatitis B oder C |
| | enumeration | 0367015 | documentation andere Wundinfektion |
| | enumeration | 0367042 | documentation sonstige Infektion |
| annotation | documentation Kat_AK_Infektion | | |
| source | <pre> <simpleType name="enum_0367"> <annotation> <documentation>Kat_AK_Infektion</documentation> </annotation> <restriction base="xs:string"> <enumeration value="0367001"> <annotation> <documentation>keine</documentation> </annotation> </enumeration> <enumeration value="0367002"> <annotation> <documentation>Mediastinitis</documentation> </annotation> </enumeration> <enumeration value="0367003"> <annotation> <documentation>Sepsis</documentation> </annotation> </enumeration> <enumeration value="0367004"> <annotation> <documentation>broncho-pulmonale Infektion</documentation> </annotation> </enumeration> </restriction> </simpleType> </pre> | | |

```
</enumeration>
<enumeration value="0367005">
  <annotation>
    <documentation>oto-laryngologische Infektion</documentation>
  </annotation>
</enumeration>
<enumeration value="0367006">
  <annotation>
    <documentation>floride Endokarditis</documentation>
  </annotation>
</enumeration>
<enumeration value="0367007">
  <annotation>
    <documentation>Peritonitis</documentation>
  </annotation>
</enumeration>
<enumeration value="0367008">
  <annotation>
    <documentation>Wundinfektion Thorax</documentation>
  </annotation>
</enumeration>
<enumeration value="0367009">
  <annotation>
    <documentation>Pleuraempyem</documentation>
  </annotation>
</enumeration>
<enumeration value="0367010">
  <annotation>
    <documentation>Venenkatheterinfektion</documentation>
  </annotation>
</enumeration>
<enumeration value="0367011">
  <annotation>
    <documentation>Harnwegsinfektion</documentation>
  </annotation>
</enumeration>
<enumeration value="0367012">
  <annotation>
    <documentation>Wundinfektion untere Extremitäten</documentation>
  </annotation>
</enumeration>
<enumeration value="0367013">
  <annotation>
    <documentation>HIV-Infektion</documentation>
  </annotation>
</enumeration>
<enumeration value="0367014">
  <annotation>
    <documentation>Hepatitis B oder C</documentation>
  </annotation>
</enumeration>
<enumeration value="0367015">
  <annotation>
    <documentation>andere Wundinfektion</documentation>
  </annotation>
</enumeration>
<enumeration value="0367042">
  <annotation>
    <documentation>sonstige Infektion</documentation>
  </annotation>
</enumeration>
```

```

    </annotation>
  </enumeration>
</restriction>
</simpleType>

```

simpleType enum_0368

| | | | |
|------------|---|---------|--|
| namespace | http://xml.ir-d.de/sak | | |
| type | restriction of string | | |
| properties | base xs:string | | |
| facets | Kind | Value | Annotation |
| | enumeration | 0368001 | documentation nein |
| | enumeration | 0368002 | documentation ja, COPD mit Dauermedikation |
| | enumeration | 0368003 | documentation ja, COPD ohne Dauermedikation |
| | enumeration | 0368004 | documentation ja, andere Lungenerkrankungen |
| | enumeration | 0368099 | documentation unbekannt |
| annotation | documentation Kat_AK_Lungenerkrankung | | |
| source | <pre> <simpleType name="enum_0368"> <annotation> <documentation>Kat_AK_Lungenerkrankung</documentation> </annotation> <restriction base="xs:string"> <enumeration value="0368001"> <annotation> <documentation>nein</documentation> </annotation> </enumeration> <enumeration value="0368002"> <annotation> <documentation>ja, COPD mit Dauermedikation</documentation> </annotation> </enumeration> <enumeration value="0368003"> <annotation> <documentation>ja, COPD ohne Dauermedikation</documentation> </annotation> </enumeration> <enumeration value="0368004"> <annotation> <documentation>ja, andere Lungenerkrankungen</documentation> </annotation> </enumeration> <enumeration value="0368099"> <annotation> <documentation>unbekannt</documentation> </annotation> </enumeration> </restriction> </simpleType> </pre> | | |

simpleType enum_0369

| | | | |
|------------|---|---------|----------------------------|
| namespace | http://xml.ir-d.de/sak | | |
| type | restriction of string | | |
| properties | base xs:string | | |
| facets | Kind | Value | Annotation |
| | enumeration | 0369001 | documentation nein |
| | enumeration | 0369002 | documentation akut |
| | enumeration | 0369003 | documentation chronisch |
| annotation | documentation Kat_AK_Nierenersatztherapie | | |
| source | <pre> <simpleType name="enum_0369"> <annotation> <documentation>Kat_AK_Nierenersatztherapie</documentation> </annotation> <restriction base="xs:string"> <enumeration value="0369001"> <annotation> <documentation>nein</documentation> </annotation> </enumeration> <enumeration value="0369002"> <annotation> <documentation>akut</documentation> </annotation> </enumeration> <enumeration value="0369003"> <annotation> <documentation>chronisch</documentation> </annotation> </enumeration> </restriction> </simpleType> </pre> | | |

simpleType enum_0370

| | | | |
|------------|--|---------|------------------------------------|
| namespace | http://xml.ir-d.de/sak | | |
| type | restriction of string | | |
| properties | base xs:string | | |
| facets | Kind | Value | Annotation |
| | enumeration | 0370001 | documentation Echokardiographie |
| | enumeration | 0370002 | documentation Herzkatheter |
| | enumeration | 0370042 | documentation andere |
| annotation | documentation Kat_AK_AKOEFMessmethode | | |
| source | <pre> <simpleType name="enum_0370"> <annotation> <documentation>Kat_AK_AKOEFMessmethode</documentation> </annotation> </pre> | | |

| | |
|--|---|
| | <pre> <restriction base="xs:string"> <enumeration value="0370001"> <annotation> <documentation>Echokardiographie</documentation> </annotation> </enumeration> <enumeration value="0370002"> <annotation> <documentation>Herzkatheter</documentation> </annotation> </enumeration> <enumeration value="0370042"> <annotation> <documentation>andere</documentation> </annotation> </enumeration> </restriction> </simpleType> </pre> |
|--|---|

simpleType enum_0371

| | | | |
|------------|--|---------|----------------------------|
| namespace | http://xml.ir-d.de/sak | | |
| type | restriction of string | | |
| properties | base xs:string | | |
| facets | Kind | Value | Annotation |
| | enumeration | 0371001 | documentation keine |
| | enumeration | 0371002 | documentation leicht |
| | enumeration | 0371003 | documentation mittel |
| | enumeration | 0371004 | documentation schwer |
| | enumeration | 0371099 | documentation unbekannt |
| annotation | documentation Kat_AK_Verkalkungsgrad | | |
| source | <pre> <simpleType name="enum_0371"> <annotation> <documentation>Kat_AK_Verkalkungsgrad</documentation> </annotation> <restriction base="xs:string"> <enumeration value="0371001"> <annotation> <documentation>keine</documentation> </annotation> </enumeration> <enumeration value="0371002"> <annotation> <documentation>leicht</documentation> </annotation> </enumeration> <enumeration value="0371003"> <annotation> <documentation>mittel</documentation> </annotation> </enumeration> </restriction> </pre> | | |

| | |
|--|--|
| | <pre> <enumeration value="0371004"> <annotation> <documentation>schwer</documentation> </annotation> </enumeration> <enumeration value="0371099"> <annotation> <documentation>unbekannt</documentation> </annotation> </enumeration> </restriction> </simpleType> </pre> |
|--|--|

simpleType enum_0372

| | | | |
|------------|--|---------|---------------------------------|
| namespace | http://xml.ir-d.de/sak | | |
| type | restriction of string | | |
| properties | base xs:string | | |
| facets | Kind | Value | Annotation |
| | enumeration | 0372001 | documentation nein |
| | enumeration | 0372002 | documentation ja, bicuspide |
| | enumeration | 0372003 | documentation ja, unicuspide |
| | enumeration | 0372099 | documentation unbekannt |
| annotation | documentation Kat_AK_BiUnicuspideKlappe | | |
| source | <pre> <simpleType name="enum_0372"> <annotation> <documentation>Kat_AK_BiUnicuspideKlappe</documentation> </annotation> <restriction base="xs:string"> <enumeration value="0372001"> <annotation> <documentation>nein</documentation> </annotation> </enumeration> <enumeration value="0372002"> <annotation> <documentation>ja, bicuspide</documentation> </annotation> </enumeration> <enumeration value="0372003"> <annotation> <documentation>ja, unicuspide</documentation> </annotation> </enumeration> <enumeration value="0372099"> <annotation> <documentation>unbekannt</documentation> </annotation> </enumeration> </restriction> </simpleType> </pre> | | |

simpleType enum 0373

| | | | |
|------------|--|---------|-------------------------------|
| namespace | http://xml.ir-d.de/sak | | |
| type | restriction of string | | |
| properties | base xs:string | | |
| facets | Kind | Value | Annotation |
| | enumeration | 0373001 | documentation keine |
| | enumeration | 0373002 | documentation leichtgradig |
| | enumeration | 0373003 | documentation mittelgradig |
| | enumeration | 0373004 | documentation hochgradig |
| | enumeration | 0373099 | documentation unbekannt |
| annotation | documentation Kat_AK_Grad | | |
| source | <pre> <simpleType name="enum_0373"> <annotation> <documentation>Kat_AK_Grad</documentation> </annotation> <restriction base="xs:string"> <enumeration value="0373001"> <annotation> <documentation>keine</documentation> </annotation> </enumeration> <enumeration value="0373002"> <annotation> <documentation>leichtgradig</documentation> </annotation> </enumeration> <enumeration value="0373003"> <annotation> <documentation>mittelgradig</documentation> </annotation> </enumeration> <enumeration value="0373004"> <annotation> <documentation>hochgradig</documentation> </annotation> </enumeration> <enumeration value="0373099"> <annotation> <documentation>unbekannt</documentation> </annotation> </enumeration> </restriction> </simpleType> </pre> | | |

simpleType enum 0374

| | |
|-----------|------------------------|
| namespace | http://xml.ir-d.de/sak |
|-----------|------------------------|

| | | | |
|------------|---|---------|--|
| type | restriction of string | | |
| properties | base xs:string | | |
| facets | Kind | Value | Annotation |
| | enumeration | 0374001 | documentation nein |
| | enumeration | 0374002 | documentation ja, <= 6 Stunden |
| | enumeration | 0374003 | documentation ja, > 6 Stunden bis <= 24 Stunden |
| | enumeration | 0374004 | documentation ja, > 1 bis 7 Tage |
| | enumeration | 0374005 | documentation ja, > 7 bis 21 Tage |
| | enumeration | 0374006 | documentation ja, > 21 Tage |
| | enumeration | 0374099 | documentation unbekannt |
| annotation | documentation Kat_AK_InfarktAnamnese | | |
| source | <pre> <simpleType name="enum_0374"> <annotation> <documentation>Kat_AK_InfarktAnamnese</documentation> </annotation> <restriction base="xs:string"> <enumeration value="0374001"> <annotation> <documentation>nein</documentation> </annotation> </enumeration> <enumeration value="0374002"> <annotation> <documentation>ja, &lt;= 6 Stunden</documentation> </annotation> </enumeration> <enumeration value="0374003"> <annotation> <documentation>ja, &gt; 6 Stunden bis &lt;= 24 Stunden</documentation> </annotation> </enumeration> <enumeration value="0374004"> <annotation> <documentation>ja, &gt; 1 bis 7 Tage</documentation> </annotation> </enumeration> <enumeration value="0374005"> <annotation> <documentation>ja, &gt; 7 bis 21 Tage</documentation> </annotation> </enumeration> <enumeration value="0374006"> <annotation> <documentation>ja, &gt; 21 Tage</documentation> </annotation> </enumeration> <enumeration value="0374099"> <annotation> <documentation>unbekannt</documentation> </annotation> </enumeration> </restriction> </pre> | | |

```

</restriction>
</simpleType>

```

simpleType enum_0375

| | | | |
|------------|--|---------|---|
| namespace | http://xml.ir-d.de/sak | | |
| type | restriction of string | | |
| properties | base xs:string | | |
| facets | Kind | Value | Annotation |
| | enumeration | 0375001 | documentation keine Symptome oder Angina |
| | enumeration | 0375002 | documentation Symptome, aber keine Ischämiezeichen |
| | enumeration | 0375003 | documentation stabile Angina |
| | enumeration | 0375004 | documentation instabile Angina |
| | enumeration | 0375005 | documentation Infarkt ohne ST-Hebung (Non-STEMI) |
| | enumeration | 0375006 | documentation Infarkt mit ST-Hebung (STEMI) |
| | enumeration | 0375042 | documentation unbekannt |
| annotation | documentation Kat_AK_KardialeSymptome | | |
| source | <pre> <simpleType name="enum_0375"> <annotation> <documentation>Kat_AK_KardialeSymptome</documentation> </annotation> <restriction base="xs:string"> <enumeration value="0375001"> <annotation> <documentation>keine Symptome oder Angina</documentation> </annotation> </enumeration> <enumeration value="0375002"> <annotation> <documentation>Symptome, aber keine Ischämiezeichen</documentation> </annotation> </enumeration> <enumeration value="0375003"> <annotation> <documentation>stabile Angina</documentation> </annotation> </enumeration> <enumeration value="0375004"> <annotation> <documentation>instabile Angina</documentation> </annotation> </enumeration> <enumeration value="0375005"> <annotation> <documentation>Infarkt ohne ST-Hebung (Non-STEMI)</documentation> </annotation> </enumeration> <enumeration value="0375006"> <annotation> </pre> | | |

| | |
|--|--|
| | <pre> <documentation>Infarkt mit ST-Hebung (STEMI)</documentation> </annotation> </enumeration> <enumeration value="0375042"> <annotation> <documentation>unbekannt</documentation> </annotation> </enumeration> </restriction> </simpleType> </pre> |
|--|--|

simpleType enum_0376

| | | | |
|------------|--|---------|---|
| namespace | http://xml.ir-d.de/sak | | |
| type | restriction of string | | |
| properties | base xs:string | | |
| facets | Kind | Value | Annotation |
| | enumeration | 0376001 | documentation nein |
| | enumeration | 0376002 | documentation ja, ZNS, zerebrovaskuläre Blutung |
| | enumeration | 0376003 | documentation ja, ZNS, zerebrovaskuläre Ischämie |
| | enumeration | 0376042 | documentation ja, ZNS, andere |
| annotation | documentation Kat_AK_Schlaganfall | | |
| source | <pre> <simpleType name="enum_0376"> <annotation> <documentation>Kat_AK_Schlaganfall</documentation> </annotation> <restriction base="xs:string"> <enumeration value="0376001"> <annotation> <documentation>nein</documentation> </annotation> </enumeration> <enumeration value="0376002"> <annotation> <documentation>ja, ZNS, zerebrovaskuläre Blutung</documentation> </annotation> </enumeration> <enumeration value="0376003"> <annotation> <documentation>ja, ZNS, zerebrovaskuläre Ischämie</documentation> </annotation> </enumeration> <enumeration value="0376042"> <annotation> <documentation>ja, ZNS, andere</documentation> </annotation> </enumeration> </restriction> </simpleType> </pre> | | |

simpleType enum_0377

| | | | |
|------------|---|---------|---|
| namespace | http://xml.ir-d.de/sak | | |
| type | restriction of string | | |
| properties | base xs:string | | |
| facets | Kind | Value | Annotation |
| | enumeration | 0377001 | documentation ja, mild neurological dysfunction: NIHSS 0-5 |
| | enumeration | 0377002 | documentation ja, moderate neurological dysfunction: NIHSS 6-14 |
| | enumeration | 0377003 | documentation ja, severe neurological dysfunction: NIHSS >=15 |
| annotation | documentation Kat_AK_Nihss | | |
| source | <pre> <simpleType name="enum_0377"> <annotation> <documentation>Kat_AK_Nihss</documentation> </annotation> <restriction base="xs:string"> <enumeration value="0377001"> <annotation> <documentation>ja, mild neurological dysfunction: NIHSS 0-5</documentation> </annotation> </enumeration> <enumeration value="0377002"> <annotation> <documentation>ja, moderate neurological dysfunction: NIHSS 6-14</documentation> </annotation> </enumeration> <enumeration value="0377003"> <annotation> <documentation> ja, severe neurological dysfunction: NIHSS &gt;=15</documentation> </annotation> </enumeration> </restriction> </simpleType> </pre> | | |

simpleType enum_0378

| | | | |
|------------|--|---------|--|
| namespace | http://xml.ir-d.de/sak | | |
| type | restriction of string | | |
| properties | base xs:string | | |
| facets | Kind | Value | Annotation |
| | enumeration | 0378001 | documentation nein |
| | enumeration | 0378002 | documentation ja, < 48h gemäss VARC-3-Definition |
| | enumeration | 0378003 | documentation ja, >= 48h - <= 72h gemäß VARC-3-Definition |
| | enumeration | 0378004 | documentation ja, > 72 h gemäß VARC-3 Definition |
| annotation | documentation Kat_AK_Myokardinfarkt | | |

| | |
|--------|---|
| source | <pre> <simpleType name="enum_0378"> <annotation> <documentation>Kat_AK_Myokardinfarkt</documentation> </annotation> <restriction base="xs:string"> <enumeration value="0378001"> <annotation> <documentation>nein</documentation> </annotation> </enumeration> <enumeration value="0378002"> <annotation> <documentation>ja, &lt; 48h gemäss VARC-3-Definition</documentation> </annotation> </enumeration> <enumeration value="0378003"> <annotation> <documentation>ja, &gt;= 48h - &lt;= 72h gemäß VARC-3-Definition</documentation> </annotation> </enumeration> <enumeration value="0378004"> <annotation> <documentation>ja, &gt; 72 h gemäß VARC-3 Definition</documentation> </annotation> </enumeration> </restriction> </simpleType> </pre> |
|--------|---|

simpleType enum_0379

| | | | |
|------------|--|---------|--|
| namespace | http://xml.ir-d.de/sak | | |
| type | restriction of string | | |
| properties | base xs:string | | |
| facets | Kind | Value | Annotation |
| | enumeration | 0379001 | documentation Keine gefäss- oder zugangsassozierte Komplikationen |
| | enumeration | 0379002 | documentation Versagen des perkutanen Verschlusssystems |
| | enumeration | 0379003 | documentation Geringfügige Gefäßkomplikationen |
| | enumeration | 0379004 | documentation Erhebliche Gefäßkomplikationen |
| annotation | documentation Kat_AK_ZugangKomplikationen | | |
| source | <pre> <simpleType name="enum_0379"> <annotation> <documentation>Kat_AK_ZugangKomplikationen</documentation> </annotation> <restriction base="xs:string"> <enumeration value="0379001"> <annotation> <documentation>Keine gefäss- oder zugangsassozierte Komplikationen</documentation> </annotation> </enumeration> <enumeration value="0379002"> </pre> | | |

| | |
|--|---|
| | <pre> <annotation> <documentation>Versagen des perkutanen Verschlussystems</documentation> </annotation> </enumeration> <enumeration value="0379003"> <annotation> <documentation>Geringfügige Gefäßkomplikationen</documentation> </annotation> </enumeration> <enumeration value="0379004"> <annotation> <documentation>Erhebliche Gefäßkomplikationen</documentation> </annotation> </enumeration> </restriction> </simpleType> </pre> |
|--|---|

simpleType enum_0380

| | | | |
|------------|---|---------|--|
| namespace | http://xml.ir-d.de/sak | | |
| type | restriction of string | | |
| properties | base xs:string | | |
| facets | Kind | Value | Annotation |
| | enumeration | 0380001 | documentation nein |
| | enumeration | 0380002 | documentation ja, intraprozedural |
| | enumeration | 0380003 | documentation ja, postprozedural |
| | enumeration | 0380004 | documentation ja, Zeitpunkt nicht bekannt |
| annotation | documentation Kat_AK_Reanimation | | |
| source | <pre> <simpleType name="enum_0380"> <annotation> <documentation>Kat_AK_Reanimation</documentation> </annotation> <restriction base="xs:string"> <enumeration value="0380001"> <annotation> <documentation>nein</documentation> </annotation> </enumeration> <enumeration value="0380002"> <annotation> <documentation>ja, intraprozedural</documentation> </annotation> </enumeration> <enumeration value="0380003"> <annotation> <documentation>ja, postprozedural</documentation> </annotation> </enumeration> <enumeration value="0380004"> <annotation> <documentation>ja, Zeitpunkt nicht bekannt</documentation> </annotation> </enumeration> </restriction> </simpleType> </pre> | | |

```

    </annotation>
  </enumeration>
</restriction>
</simpleType>

```

simpleType enum_0381

| | | | |
|------------|---|---------|---|
| namespace | http://xml.ir-d.de/sak | | |
| type | restriction of string | | |
| properties | base xs:string | | |
| facets | Kind | Value | Annotation |
| | enumeration | 0381001 | documentation nein |
| | enumeration | 0381002 | documentation Thorakotomie/Rethorakotomie |
| | enumeration | 0381003 | documentation kathetergestützte Reintervention |
| | enumeration | 0381004 | documentation lokale Reinterventionen |
| | enumeration | 0381005 | documentation andere Reintervention |
| annotation | documentation Kat_AK_Massnahmen | | |
| source | <pre> <simpleType name="enum_0381"> <annotation> <documentation>Kat_AK_Massnahmen</documentation> </annotation> <restriction base="xs:string"> <enumeration value="0381001"> <annotation> <documentation>nein</documentation> </annotation> </enumeration> <enumeration value="0381002"> <annotation> <documentation>Thorakotomie/Rethorakotomie</documentation> </annotation> </enumeration> <enumeration value="0381003"> <annotation> <documentation>kathetergestützte Reintervention</documentation> </annotation> </enumeration> <enumeration value="0381004"> <annotation> <documentation>lokale Reinterventionen</documentation> </annotation> </enumeration> <enumeration value="0381005"> <annotation> <documentation>andere Reintervention</documentation> </annotation> </enumeration> </restriction> </simpleType> </pre> | | |

simpleType enum_0382

| | | | |
|------------|---|---------|--|
| namespace | http://xml.ir-d.de/sak | | |
| type | restriction of string | | |
| properties | base xs:string | | |
| facets | Kind | Value | Annotation |
| | enumeration | 0382001 | documentation keine Rethorakotomie / kein weiterer Grund |
| | enumeration | 0382002 | documentation Blutung/Hämatom |
| | enumeration | 0382003 | documentation Low Cardiac Output |
| | enumeration | 0382004 | documentation Tamponade |
| | enumeration | 0382005 | documentation Graftprobleme, Ischämie |
| | enumeration | 0382006 | documentation Wundinfektion, Mediastinitis |
| | enumeration | 0382007 | documentation Dissektion |
| | enumeration | 0382008 | documentation Prothesendysfunktion |
| | enumeration | 0382009 | documentation instabiles Sternum |
| | enumeration | 0382010 | documentation Chylothorax |
| | enumeration | 0382011 | documentation lokale Revision im Bereich des Zugangsweges |
| | enumeration | 0382042 | documentation anderer Grund |
| annotation | documentation Kat_AK_Komplikation | | |
| source | <pre> <simpleType name="enum_0382"> <annotation> <documentation>Kat_AK_Komplikation</documentation> </annotation> <restriction base="xs:string"> <enumeration value="0382001"> <annotation> <documentation>keine Rethorakotomie / kein weiterer Grund</documentation> </annotation> </enumeration> <enumeration value="0382002"> <annotation> <documentation>Blutung/Hämatom</documentation> </annotation> </enumeration> <enumeration value="0382003"> <annotation> <documentation>Low Cardiac Output</documentation> </annotation> </enumeration> <enumeration value="0382004"> <annotation> <documentation>Tamponade</documentation> </annotation> </enumeration> <enumeration value="0382005"> </pre> | | |

```

    <annotation>
      <documentation>Graftprobleme, Ischämie</documentation>
    </annotation>
  </enumeration>
  <enumeration value="0382006">
    <annotation>
      <documentation>Wundinfektion, Mediastinitis</documentation>
    </annotation>
  </enumeration>
  <enumeration value="0382007">
    <annotation>
      <documentation>Dissektion</documentation>
    </annotation>
  </enumeration>
  <enumeration value="0382008">
    <annotation>
      <documentation>Prothesendysfunktion</documentation>
    </annotation>
  </enumeration>
  <enumeration value="0382009">
    <annotation>
      <documentation>instabiles Sternum</documentation>
    </annotation>
  </enumeration>
  <enumeration value="0382010">
    <annotation>
      <documentation>Chylothorax</documentation>
    </annotation>
  </enumeration>
  <enumeration value="0382011">
    <annotation>
      <documentation>lokale Revision im Bereich des
Zugangsweges</documentation>
    </annotation>
  </enumeration>
  <enumeration value="0382042">
    <annotation>
      <documentation>anderer Grund</documentation>
    </annotation>
  </enumeration>
</restriction>
</simpleType>

```

simpleType enum_0383

| | | | |
|------------|------------------------------|---------|--|
| namespace | http://xml.ir-d.de/sak | | |
| type | restriction of string | | |
| properties | base xs:string | | |
| facets | Kind | Value | Annotation |
| | enumeration | 0383001 | documentation nein |
| | enumeration | 0383002 | documentation ja, mit forcierter Atemtherapie |
| | enumeration | 0383003 | documentation ja, Reintubation oder längerfristige Beatmung |
| | enumeration | 0383004 | documentation ja, Tracheotomie |

| | |
|------------|---|
| annotation | documentation Kat_AK_RespiratorischeInsuffizienz |
| source | <pre> <simpleType name="enum_0383"> <annotation> <documentation>Kat_AK_RespiratorischeInsuffizienz</documentation> </annotation> <restriction base="xs:string"> <enumeration value="0383001"> <annotation> <documentation>nein</documentation> </annotation> </enumeration> <enumeration value="0383002"> <annotation> <documentation>ja, mit forcierter Atemtherapie</documentation> </annotation> </enumeration> <enumeration value="0383003"> <annotation> <documentation>ja, Reintubation oder längerfristige Beatmung</documentation> </annotation> </enumeration> <enumeration value="0383004"> <annotation> <documentation>ja, Tracheotomie</documentation> </annotation> </enumeration> </restriction> </simpleType> </pre> |

simpleType enum_0384

| | | | |
|------------|--|---------|--|
| namespace | http://xml.ir-d.de/sak | | |
| type | restriction of string | | |
| properties | base xs:string | | |
| facets | Kind | Value | Annotation |
| | enumeration | 0384001 | documentation keine Blutungskomplikationen |
| | enumeration | 0384002 | documentation Geringfügige Blutung (Minor Bleeding - BARC type 2 or 3a) |
| | enumeration | 0384003 | documentation Starke Blutung (Major Bleeding - BARC type 3a) |
| | enumeration | 0384004 | documentation Lebensbedrohliche Blutung (Life-threatening or disabling bleeding - BARC type 3b or 3c or type 5) |
| annotation | documentation Kat_AK_Blutungskomplikation | | |
| source | <pre> <simpleType name="enum_0384"> <annotation> <documentation>Kat_AK_Blutungskomplikation</documentation> </annotation> <restriction base="xs:string"> <enumeration value="0384001"> <annotation> <documentation>keine Blutungskomplikationen</documentation> </annotation> </pre> | | |

| | |
|--|--|
| | <pre> </enumeration> <enumeration value="0384002"> <annotation> <documentation>Geringfügige Blutung (Minor Bleeding - BARC type 2 or 3a)</documentation> </annotation> </enumeration> <enumeration value="0384003"> <annotation> <documentation>Starke Blutung (Major Bleeding - BARC type 3a)</documentation> </annotation> </enumeration> <enumeration value="0384004"> <annotation> <documentation>Lebensbedrohliche Blutung (Life-threatening or disabling bleeding - BARC type 3b or 3c or type 5)</documentation> </annotation> </enumeration> </restriction> </simpleType> </pre> |
|--|--|

simpleType enum_0385

| | | | |
|------------|---|---------|---|
| namespace | http://xml.ir-d.de/sak | | |
| type | restriction of string | | |
| properties | base xs:string | | |
| facets | Kind | Value | Annotation |
| | enumeration | 0385001 | documentation Sinusrhythmus |
| | enumeration | 0385002 | documentation Vorhofflimmern |
| | enumeration | 0385003 | documentation Patient verstorben (kein Herzrhythmus) |
| | enumeration | 0385042 | documentation anderer Rhythmus |
| annotation | documentation Kat_AK_HerzrhythmusEntlassung | | |
| source | <pre> <simpleType name="enum_0385"> <annotation> <documentation>Kat_AK_HerzrhythmusEntlassung</documentation> </annotation> <restriction base="xs:string"> <enumeration value="0385001"> <annotation> <documentation>Sinusrhythmus</documentation> </annotation> </enumeration> <enumeration value="0385002"> <annotation> <documentation>Vorhofflimmern</documentation> </annotation> </enumeration> <enumeration value="0385003"> <annotation> <documentation>Patient verstorben (kein Herzrhythmus)</documentation> </annotation> </enumeration> </restriction> </simpleType> </pre> | | |

| | |
|--|--|
| | <pre> </enumeration> <enumeration value="0385042"> <annotation> <documentation>anderer Rhythmus</documentation> </annotation> </enumeration> </restriction> </simpleType> </pre> |
|--|--|

simpleType enum_0388

| | | | |
|------------|---|---------|--|
| namespace | http://xml.ir-d.de/sak | | |
| type | restriction of string | | |
| properties | base xs:string | | |
| facets | Kind | Value | Annotation |
| | enumeration | 0388001 | documentation nein |
| | enumeration | 0388002 | documentation ASS |
| | enumeration | 0388003 | documentation ADP-Rezeptor-Antagonist |
| | enumeration | 0388004 | documentation Kombination ASS und ADP-Rezeptor-Antagonist |
| | enumeration | 0388042 | documentation ja, andere |
| | enumeration | 0388099 | documentation unbekannt |
| annotation | documentation Kat_AK_Plaettchenaggregationshemmer | | |
| source | <pre> <simpleType name="enum_0388"> <annotation> <documentation>Kat_AK_Plaettchenaggregationshemmer</documentation> </annotation> <restriction base="xs:string"> <enumeration value="0388001"> <annotation> <documentation>nein</documentation> </annotation> </enumeration> <enumeration value="0388002"> <annotation> <documentation>ASS</documentation> </annotation> </enumeration> <enumeration value="0388003"> <annotation> <documentation>ADP-Rezeptor-Antagonist</documentation> </annotation> </enumeration> <enumeration value="0388004"> <annotation> <documentation>Kombination ASS und ADP-Rezeptor-Antagonist</documentation> </annotation> </enumeration> <enumeration value="0388042"> <annotation> </pre> | | |

| | |
|--|---|
| | <pre> <documentation>ja, andere</documentation> </annotation> </enumeration> <enumeration value="0388099"> <annotation> <documentation>unbekannt</documentation> </annotation> </enumeration> </restriction> </simpleType> </pre> |
|--|---|

simpleType enum_0389

| | | | |
|------------|---|---------|---|
| namespace | http://xml.ir-d.de/sak | | |
| type | restriction of string | | |
| properties | base xs:string | | |
| facets | Kind | Value | Annotation |
| | enumeration | 0389001 | documentation nein |
| | enumeration | 0389002 | documentation Cumarin-Derivate |
| | enumeration | 0389003 | documentation Heparinoide |
| | enumeration | 0389004 | documentation orale Thrombinantagonisten |
| | enumeration | 0389005 | documentation Kombination Heparinoide und Cumarin-Derivate |
| | enumeration | 0389006 | documentation Direkte orale Antikoagulantien (DOAK / NOAK) |
| | enumeration | 0389042 | documentation ja, andere |
| | enumeration | 0389099 | documentation unbekannt |
| annotation | documentation Kat_AK_Antikoagulantien | | |
| source | <pre> <simpleType name="enum_0389"> <annotation> <documentation>Kat_AK_Antikoagulantien</documentation> </annotation> <restriction base="xs:string"> <enumeration value="0389001"> <annotation> <documentation>nein</documentation> </annotation> </enumeration> <enumeration value="0389002"> <annotation> <documentation>Cumarin-Derivate</documentation> </annotation> </enumeration> <enumeration value="0389003"> <annotation> <documentation>Heparinoide</documentation> </annotation> </enumeration> <enumeration value="0389004"> <annotation> <documentation>orale Thrombinantagonisten</documentation> </pre> | | |

| | |
|--|---|
| | <pre> </annotation> </enumeration> <enumeration value="0389005"> <annotation> <documentation>Kombination Heparinoide und Cumarin-Derivate</documentation> </annotation> </enumeration> <enumeration value="0389006"> <annotation> <documentation>Direkte orale Antikoagulantien (DOAK / NOAK)</documentation> </annotation> </enumeration> <enumeration value="0389042"> <annotation> <documentation>ja, andere</documentation> </annotation> </enumeration> <enumeration value="0389099"> <annotation> <documentation>unbekannt</documentation> </annotation> </enumeration> </restriction> </simpleType> </pre> |
|--|---|

simpleType enum_0390

| | | | |
|------------|--|---------|---|
| namespace | http://xml.ir-d.de/sak | | |
| type | restriction of string | | |
| properties | base xs:string | | |
| facets | Kind | Value | Annotation |
| | enumeration | 0390001 | documentation biologisches Klappenmodell |
| | enumeration | 0390002 | documentation mechanisches Klappenmodell |
| annotation | documentation Kat_AK_Artikeltyp | | |
| source | <pre> <simpleType name="enum_0390"> <annotation> <documentation>Kat_AK_Artikeltyp</documentation> </annotation> <restriction base="xs:string"> <enumeration value="0390001"> <annotation> <documentation>biologisches Klappenmodell</documentation> </annotation> </enumeration> <enumeration value="0390002"> <annotation> <documentation>mechanisches Klappenmodell</documentation> </annotation> </enumeration> </restriction> </simpleType> </pre> | | |

simpleType enum 0398

| | | | |
|------------|--|---------|--|
| namespace | http://xml.ir-d.de/sak | | |
| type | restriction of string | | |
| properties | base xs:string | | |
| facets | Kind | Value | Annotation |
| | enumeration | 0398001 | documentation kardiovaskuläre Ursache |
| | enumeration | 0398002 | documentation nicht-kardiovaskuläre Ursache |
| | enumeration | 0398099 | documentation Todesursache unbekannt |
| annotation | documentation Kat_AK_Todesursache | | |
| source | <pre> <simpleType name="enum_0398"> <annotation> <documentation>Kat_AK_Todesursache</documentation> </annotation> <restriction base="xs:string"> <enumeration value="0398001"> <annotation> <documentation>kardiovaskuläre Ursache</documentation> </annotation> </enumeration> <enumeration value="0398002"> <annotation> <documentation>nicht-kardiovaskuläre Ursache</documentation> </annotation> </enumeration> <enumeration value="0398099"> <annotation> <documentation>Todesursache unbekannt</documentation> </annotation> </enumeration> </restriction> </simpleType> </pre> | | |

simpleType enum 0399

| | | | |
|------------|--|---------|--|
| namespace | http://xml.ir-d.de/sak | | |
| type | restriction of string | | |
| properties | base xs:string | | |
| facets | Kind | Value | Annotation |
| | enumeration | 0399001 | documentation Patient lebt |
| | enumeration | 0399002 | documentation Patient im Krankenhaus verstorben |
| annotation | documentation Kat_AK_Vitalstatus | | |
| source | <pre> <simpleType name="enum_0399"> <annotation> <documentation>Kat_AK_Vitalstatus</documentation> </annotation> <restriction base="xs:string"> </pre> | | |

| | |
|--|--|
| | <pre> <enumeration value="0399001"> <annotation> <documentation>Patient lebt</documentation> </annotation> </enumeration> <enumeration value="0399002"> <annotation> <documentation>Patient im Krankenhaus verstorben</documentation> </annotation> </enumeration> </restriction> </simpleType> </pre> |
|--|--|

simpleType enum_0044

| | | | |
|------------|--|---------|---|
| namespace | http://xml.ir-d.de/irdsaa | | |
| type | restriction of string | | |
| properties | base xs:string | | |
| facets | Kind | Value | Annotation |
| | enumeration | 0044001 | documentation 1= normaler, sonst gesunder Patient |
| | enumeration | 0044002 | documentation 2= Patient mit leichter Allgemeinerkrankung |
| | enumeration | 0044003 | documentation 3= Patient mit schwerer Allgemeinerkrankung |
| | enumeration | 0044004 | documentation 4= Patient mit schwerer Allgemeinerkrankung, die eine ständige Lebensbedrohung darstellt |
| | enumeration | 0044005 | documentation 5= moribunder Patient, der ohne die Operation voraussichtlich nicht überleben wird |
| annotation | documentation Kat_ASA | | |
| source | <pre> <simpleType name="enum_0044"> <annotation> <documentation>Kat_ASA</documentation> </annotation> <restriction base="xs:string"> <enumeration value="0044001"> <annotation> <documentation>1= normaler, sonst gesunder Patient</documentation> </annotation> </enumeration> <enumeration value="0044002"> <annotation> <documentation>2= Patient mit leichter Allgemeinerkrankung</documentation> </annotation> </enumeration> <enumeration value="0044003"> <annotation> <documentation>3= Patient mit schwerer Allgemeinerkrankung</documentation> </annotation> </enumeration> <enumeration value="0044004"> <annotation> <documentation>4= Patient mit schwerer Allgemeinerkrankung, die eine </pre> | | |

| | |
|--|---|
| | <pre>ständige Lebensbedrohung darstellt</documentation> </annotation> </enumeration> <enumeration value="0044005"> <annotation> <documentation>5= moribunder Patient, der ohne die Operation voraussichtlich nicht überleben wird</documentation> </annotation> </enumeration> </restriction> </simpleType></pre> |
|--|---|

simpleType enum_0050

| | | | |
|------------|---|---------|-------------------------|
| namespace | http://xml.ir-d.de/irdsaa | | |
| type | restriction of string | | |
| properties | base xs:string | | |
| facets | Kind | Value | Annotation |
| | enumeration | 0050001 | documentation rechts |
| | enumeration | 0050002 | documentation links |
| annotation | documentation Kat_RechtsLinks | | |
| source | <pre><simpleType name="enum_0050"> <annotation> <documentation>Kat_RechtsLinks</documentation> </annotation> <restriction base="xs:string"> <enumeration value="0050001"> <annotation> <documentation>rechts</documentation> </annotation> </enumeration> <enumeration value="0050002"> <annotation> <documentation>links</documentation> </annotation> </enumeration> </restriction> </simpleType></pre> | | |

simpleType enum_0060

| | | | |
|------------|------------------------------|---------|-----------------------|
| namespace | http://xml.ir-d.de/irdsaa | | |
| type | restriction of string | | |
| properties | base xs:string | | |
| facets | Kind | Value | Annotation |
| | enumeration | 0060001 | documentation ja |
| | enumeration | 0060002 | documentation nein |
| annotation | documentation Kat_JaNein | | |

| | |
|--------|---|
| source | <pre> <simpleType name="enum_0060"> <annotation> <documentation>Kat_JaNein</documentation> </annotation> <restriction base="xs:string"> <enumeration value="0060001"> <annotation> <documentation>ja</documentation> </annotation> </enumeration> <enumeration value="0060002"> <annotation> <documentation>nein</documentation> </annotation> </enumeration> </restriction> </simpleType> </pre> |
|--------|---|

simpleType enum_0061

| | | | |
|------------|---|---------|----------------------------|
| namespace | http://xml.ir-d.de/irdsaa | | |
| type | restriction of string | | |
| properties | base xs:string | | |
| facets | Kind | Value | Annotation |
| | enumeration | 0061001 | documentation ja |
| | enumeration | 0061002 | documentation nein |
| | enumeration | 0061099 | documentation unbekannt |
| annotation | documentation Kat_JaNeinUnbekannt | | |
| source | <pre> <simpleType name="enum_0061"> <annotation> <documentation>Kat_JaNeinUnbekannt</documentation> </annotation> <restriction base="xs:string"> <enumeration value="0061001"> <annotation> <documentation>ja</documentation> </annotation> </enumeration> <enumeration value="0061002"> <annotation> <documentation>nein</documentation> </annotation> </enumeration> <enumeration value="0061099"> <annotation> <documentation>unbekannt</documentation> </annotation> </enumeration> </restriction> </simpleType> </pre> | | |

simpleType enum_0062

| | | | |
|------------|---|---------|----------------------------------|
| namespace | http://xml.ir-d.de/irdsaa | | |
| type | restriction of string | | |
| properties | base xs:string | | |
| facets | Kind | Value | Annotation |
| | enumeration | 0062001 | documentation Stück |
| | enumeration | 0062002 | documentation g |
| | enumeration | 0062003 | documentation mg |
| | enumeration | 0062004 | documentation l |
| | enumeration | 0062005 | documentation ml |
| | enumeration | 0062006 | documentation cm ³ |
| | enumeration | 0062007 | documentation mm |
| | enumeration | 0062008 | documentation cm |
| | enumeration | 0062009 | documentation dm |
| | enumeration | 0062010 | documentation m |
| | enumeration | 0062042 | documentation andere |
| annotation | documentation Kat_Einheit | | |
| source | <pre> <simpleType name="enum_0062"> <annotation> <documentation>Kat_Einheit</documentation> </annotation> <restriction base="xs:string"> <enumeration value="0062001"> <annotation> <documentation>Stück</documentation> </annotation> </enumeration> <enumeration value="0062002"> <annotation> <documentation>g</documentation> </annotation> </enumeration> <enumeration value="0062003"> <annotation> <documentation>mg</documentation> </annotation> </enumeration> <enumeration value="0062004"> <annotation> <documentation>l</documentation> </annotation> </enumeration> <enumeration value="0062005"> <annotation> <documentation>ml</documentation> </annotation> </enumeration> </restriction> </simpleType> </pre> | | |

| | |
|--|--|
| | <pre> <enumeration value="0062006"> <annotation> <documentation>cm³</documentation> </annotation> </enumeration> <enumeration value="0062007"> <annotation> <documentation>mm</documentation> </annotation> </enumeration> <enumeration value="0062008"> <annotation> <documentation>cm</documentation> </annotation> </enumeration> <enumeration value="0062009"> <annotation> <documentation>dm</documentation> </annotation> </enumeration> <enumeration value="0062010"> <annotation> <documentation>m</documentation> </annotation> </enumeration> <enumeration value="0062042"> <annotation> <documentation>andere</documentation> </annotation> </enumeration> </restriction> </simpleType> </pre> |
|--|--|

simpleType enum_0065

| | | | |
|------------|--|---------|--------------------------------|
| namespace | http://xml.ir-d.de/irdsaa | | |
| type | restriction of string | | |
| properties | base xs:string | | |
| facets | Kind | Value | Annotation |
| | enumeration | 0065001 | documentation stationär |
| | enumeration | 0065002 | documentation teilstationär |
| | enumeration | 0065003 | documentation ambulant |
| annotation | documentation Kat_ArtAufenthalt | | |
| source | <pre> <simpleType name="enum_0065"> <annotation> <documentation>Kat_ArtAufenthalt</documentation> </annotation> <restriction base="xs:string"> <enumeration value="0065001"> <annotation> <documentation>stationär</documentation> </annotation> </enumeration> </pre> | | |

| | |
|--|--|
| | <pre> <enumeration value="0065002"> <annotation> <documentation>teilstationär</documentation> </annotation> </enumeration> <enumeration value="0065003"> <annotation> <documentation>ambulant</documentation> </annotation> </enumeration> </restriction> </simpleType> </pre> |
|--|--|

simpleType enum_0067

| | | | |
|------------|---|---------|----------------------------|
| namespace | http://xml.ir-d.de/irdsaa | | |
| type | restriction of string | | |
| properties | base xs:string | | |
| facets | Kind | Value | Annotation |
| | enumeration | 0067001 | documentation Implantat |
| | enumeration | 0067002 | documentation Explantat |
| annotation | documentation Kat_ArtArtikel | | |
| source | <pre> <simpleType name="enum_0067"> <annotation> <documentation>Kat_ArtArtikel</documentation> </annotation> <restriction base="xs:string"> <enumeration value="0067001"> <annotation> <documentation>Implantat</documentation> </annotation> </enumeration> <enumeration value="0067002"> <annotation> <documentation>Explantat</documentation> </annotation> </enumeration> </restriction> </simpleType> </pre> | | |

simpleType enum_0068

| | | | |
|------------|------------------------------|---------|---------------------------------|
| namespace | http://xml.ir-d.de/irdsaa | | |
| type | restriction of string | | |
| properties | base xs:string | | |
| facets | Kind | Value | Annotation |
| | enumeration | 0068001 | documentation UDI |
| | enumeration | 0068002 | documentation Referenz (REF) |
| | enumeration | 0068003 | documentation |

| | |
|------------|--|
| | enumeration 0068042 Katalognummer documentation sonstiger |
| annotation | documentation Kat_KennzeichenTyp |
| source | <pre> <simpleType name="enum_0068"> <annotation> <documentation>Kat_KennzeichenTyp</documentation> </annotation> <restriction base="xs:string"> <enumeration value="0068001"> <annotation> <documentation>UDI</documentation> </annotation> </enumeration> <enumeration value="0068002"> <annotation> <documentation>Referenz (REF)</documentation> </annotation> </enumeration> <enumeration value="0068003"> <annotation> <documentation>Katalognummer</documentation> </annotation> </enumeration> <enumeration value="0068042"> <annotation> <documentation>sonstiger</documentation> </annotation> </enumeration> </restriction> </simpleType> </pre> |

simpleType enum_0069

| | | | |
|------------|---|---------|----------------------------|
| namespace | http://xml.ir-d.de/irdsaa | | |
| type | restriction of string | | |
| properties | base xs:string | | |
| facets | Kind | Value | Annotation |
| | enumeration | 0069001 | documentation Implantat |
| | enumeration | 0069002 | documentation Explantat |
| annotation | documentation Kat_ArtZubehoer | | |
| source | <pre> <simpleType name="enum_0069"> <annotation> <documentation>Kat_ArtZubehoer</documentation> </annotation> <restriction base="xs:string"> <enumeration value="0069001"> <annotation> <documentation>Implantat</documentation> </annotation> </enumeration> <enumeration value="0069002"> <annotation> </pre> | | |

| | |
|--|---|
| | <pre> <documentation>Explantat</documentation> </annotation> </enumeration> </restriction> </simpleType> </pre> |
|--|---|

simpleType enum_0070

| | | | |
|------------|---|---------|--------------------------|
| namespace | http://xml.ir-d.de/irdsaa | | |
| type | restriction of string | | |
| properties | base xs:string | | |
| facets | Kind | Value | Annotation |
| | enumeration | 0070001 | documentation weiblich |
| | enumeration | 0070002 | documentation männlich |
| | enumeration | 0070003 | documentation divers |
| | enumeration | 0070042 | documentation unbestimmt |
| annotation | documentation Kat_Geschlecht | | |
| source | <pre> <simpleType name="enum_0070"> <annotation> <documentation>Kat_Geschlecht</documentation> </annotation> <restriction base="xs:string"> <enumeration value="0070001"> <annotation> <documentation>weiblich</documentation> </annotation> </enumeration> <enumeration value="0070002"> <annotation> <documentation>männlich</documentation> </annotation> </enumeration> <enumeration value="0070003"> <annotation> <documentation>divers</documentation> </annotation> </enumeration> <enumeration value="0070042"> <annotation> <documentation>unbestimmt</documentation> </annotation> </enumeration> </restriction> </simpleType> </pre> | | |

simpleType enum_0071

| | |
|-----------|------------------------------|
| namespace | http://xml.ir-d.de/irdsaa |
| type | restriction of string |

| properties | base xs:string | | | | | | | | | | | | |
|-------------|---|---|-------|------------|-------------|---------|----------------------------|-------------|---------|----------------------------|-------------|---------|---|
| facets | <table border="1"> <thead> <tr> <th>Kind</th> <th>Value</th> <th>Annotation</th> </tr> </thead> <tbody> <tr> <td>enumeration</td> <td>0071001</td> <td>documentation Implantat</td> </tr> <tr> <td>enumeration</td> <td>0071002</td> <td>documentation Explantat</td> </tr> <tr> <td>enumeration</td> <td>0071003</td> <td>documentation Degeneriertes/defektes Produkt, das funktionslos im Körper verbleibt</td> </tr> </tbody> </table> | Kind | Value | Annotation | enumeration | 0071001 | documentation Implantat | enumeration | 0071002 | documentation Explantat | enumeration | 0071003 | documentation Degeneriertes/defektes Produkt, das funktionslos im Körper verbleibt |
| Kind | Value | Annotation | | | | | | | | | | | |
| enumeration | 0071001 | documentation Implantat | | | | | | | | | | | |
| enumeration | 0071002 | documentation Explantat | | | | | | | | | | | |
| enumeration | 0071003 | documentation Degeneriertes/defektes Produkt, das funktionslos im Körper verbleibt | | | | | | | | | | | |
| annotation | documentation Kat ArtikelArtFunktion | | | | | | | | | | | | |
| source | <pre> <simpleType name="enum_0071"> <annotation> <documentation>Kat_ArtikelArtFunktion</documentation> </annotation> <restriction base="xs:string"> <enumeration value="0071001"> <annotation> <documentation>Implantat</documentation> </annotation> </enumeration> <enumeration value="0071002"> <annotation> <documentation>Explantat</documentation> </annotation> </enumeration> <enumeration value="0071003"> <annotation> <documentation>Degeneriertes/defektes Produkt, das funktionslos im Körper verbleibt</documentation> </annotation> </enumeration> </restriction> </simpleType> </pre> | | | | | | | | | | | | |

simpleType enum_0075

| namespace | http://xml.ir-d.de/irdsaa | | | | | | | | | | | | |
|-------------|---|----------------------------|-------|------------|-------------|---------|--------------------------|-------------|---------|----------------------------|-------------|---------|--------------------------|
| type | restriction of string | | | | | | | | | | | | |
| properties | base xs:string | | | | | | | | | | | | |
| facets | <table border="1"> <thead> <tr> <th>Kind</th> <th>Value</th> <th>Annotation</th> </tr> </thead> <tbody> <tr> <td>enumeration</td> <td>0075001</td> <td>documentation elektiv</td> </tr> <tr> <td>enumeration</td> <td>0075002</td> <td>documentation dringlich</td> </tr> <tr> <td>enumeration</td> <td>0075003</td> <td>documentation Notfall</td> </tr> </tbody> </table> | Kind | Value | Annotation | enumeration | 0075001 | documentation elektiv | enumeration | 0075002 | documentation dringlich | enumeration | 0075003 | documentation Notfall |
| Kind | Value | Annotation | | | | | | | | | | | |
| enumeration | 0075001 | documentation elektiv | | | | | | | | | | | |
| enumeration | 0075002 | documentation dringlich | | | | | | | | | | | |
| enumeration | 0075003 | documentation Notfall | | | | | | | | | | | |
| annotation | documentation Kat_Dringlichkeit | | | | | | | | | | | | |
| source | <pre> <simpleType name="enum_0075"> <annotation> <documentation>Kat_Dringlichkeit</documentation> </annotation> <restriction base="xs:string"> <enumeration value="0075001"> <annotation> <documentation>elektiv</documentation> </annotation> </enumeration> </restriction> </simpleType> </pre> | | | | | | | | | | | | |

| | |
|--|--|
| | <pre> </enumeration> <enumeration value="0075002"> <annotation> <documentation>dringlich</documentation> </annotation> </enumeration> <enumeration value="0075003"> <annotation> <documentation>Notfall</documentation> </annotation> </enumeration> </restriction> </simpleType> </pre> |
|--|--|

simpleType enum_0076

| | | | |
|------------|---|---------|---|
| namespace | http://xml.ir-d.de/irdsaa | | |
| type | restriction of string | | |
| properties | base xs:string | | |
| facets | Kind | Value | Annotation |
| | enumeration | 0076001 | documentation elektiv |
| | enumeration | 0076002 | documentation dringlich |
| | enumeration | 0076003 | documentation Notfall |
| | enumeration | 0076004 | documentation Notfall (Reanimation / ultima ratio) |
| annotation | documentation Kat_Dringlichkeit_Reanimation | | |
| source | <pre> <simpleType name="enum_0076"> <annotation> <documentation>Kat_Dringlichkeit_Reanimation</documentation> </annotation> <restriction base="xs:string"> <enumeration value="0076001"> <annotation> <documentation>elektiv</documentation> </annotation> </enumeration> <enumeration value="0076002"> <annotation> <documentation>dringlich</documentation> </annotation> </enumeration> <enumeration value="0076003"> <annotation> <documentation>Notfall</documentation> </annotation> </enumeration> <enumeration value="0076004"> <annotation> <documentation>Notfall (Reanimation / ultima ratio)</documentation> </annotation> </enumeration> </restriction> </simpleType> </pre> | | |

simpleType enum 0080

| | | | |
|------------|---|---------|--|
| namespace | http://xml.ir-d.de/irdsaa | | |
| type | restriction of string | | |
| properties | base xs:string | | |
| facets | Kind | Value | Annotation |
| | enumeration | 0080001 | documentation Endoprothese Hüfte/Knie |
| | enumeration | 0080002 | documentation Brustimplantat |
| | enumeration | 0080003 | documentation Aortenklappenprothese |
| annotation | documentation Kat_Implantattyp | | |
| source | <pre> <simpleType name="enum_0080"> <annotation> <documentation>Kat_Implantattyp</documentation> </annotation> <restriction base="xs:string"> <enumeration value="0080001"> <annotation> <documentation>Endoprothese Hüfte/Knie</documentation> </annotation> </enumeration> <enumeration value="0080002"> <annotation> <documentation>Brustimplantat</documentation> </annotation> </enumeration> <enumeration value="0080003"> <annotation> <documentation>Aortenklappenprothese</documentation> </annotation> </enumeration> </restriction> </simpleType> </pre> | | |

simpleType enum 0100

| | | | |
|------------|--|---------|--|
| namespace | http://xml.ir-d.de/irdsaa | | |
| type | restriction of string | | |
| properties | base xs:string | | |
| facets | Kind | Value | Annotation |
| | enumeration | 0100001 | documentation Primäreingriff |
| | enumeration | 0100002 | documentation Austausch Expander gegen dauerhaftes Brustimplantat |
| | enumeration | 0100003 | documentation Revision |
| | enumeration | 0100004 | documentation Nur Explantation |
| annotation | documentation Kat_Bl_ArtEingriff | | |
| source | <pre> <simpleType name="enum_0100"> </pre> | | |

| | |
|--|--|
| | <pre> <annotation> <documentation>Kat_BI_ArtEingriff</documentation> </annotation> <restriction base="xs:string"> <enumeration value="0100001"> <annotation> <documentation>Primäreingriff</documentation> </annotation> </enumeration> <enumeration value="0100002"> <annotation> <documentation>Austausch Expander gegen dauerhaftes Brustimplantat</documentation> </annotation> </enumeration> <enumeration value="0100003"> <annotation> <documentation>Revision</documentation> </annotation> </enumeration> <enumeration value="0100004"> <annotation> <documentation>Nur Explantation</documentation> </annotation> </enumeration> </restriction> </simpleType> </pre> |
|--|--|

simpleType enum_0102

| | | | |
|------------|---|---------|---|
| namespace | http://xml.ir-d.de/irdsaa | | |
| type | restriction of string | | |
| properties | base xs:string | | |
| facets | Kind | Value | Annotation |
| | enumeration | 0102001 | documentation kosmetische Augmentation |
| | enumeration | 0102002 | documentation Rekonstruktion, benigne |
| | enumeration | 0102003 | documentation Rekonstruktion nach Mastektomie aufgrund eines Karzinoms |
| | enumeration | 0102004 | documentation Rekonstruktion nach risikoreduzierender Mastektomie |
| annotation | documentation Kat_BI_GrundPrimaereingriff | | |
| source | <pre> <simpleType name="enum_0102"> <annotation> <documentation>Kat_BI_GrundPrimaereingriff</documentation> </annotation> <restriction base="xs:string"> <enumeration value="0102001"> <annotation> <documentation>kosmetische Augmentation</documentation> </annotation> </enumeration> <enumeration value="0102002"> <annotation> <documentation>Rekonstruktion, benigne</documentation> </annotation> </enumeration> </restriction> </simpleType> </pre> | | |

| | |
|--|---|
| | <pre> </annotation> </enumeration> <enumeration value="0102003"> <annotation> <documentation>Rekonstruktion nach Mastektomie aufgrund eines Karzinoms</documentation> </annotation> </enumeration> <enumeration value="0102004"> <annotation> <documentation>Rekonstruktion nach risikoreduzierender Mastektomie</documentation> </annotation> </enumeration> </restriction> </simpleType> </pre> |
|--|---|

simpleType enum_0103

| | | | |
|------------|--|---------|---|
| namespace | http://xml.ir-d.de/irdsaa | | |
| type | restriction of string | | |
| properties | base xs:string | | |
| facets | Kind | Value | Annotation |
| | enumeration | 0103001 | documentation simultane Lappendeckung |
| | enumeration | 0103002 | documentation simultane Eigenfetttransplantation |
| | enumeration | 0103003 | documentation simultane Mastopexie |
| | enumeration | 0103005 | documentation simultane Mastektomie, Ablatio / hautsparend |
| | enumeration | 0103006 | documentation simultane Mastektomie, nippelerhaltend |
| | enumeration | 0103007 | documentation Axilla-Dissektion |
| | enumeration | 0103008 | documentation Drainage |
| annotation | documentation Kat_BI_OperationsdetailPrimaereingriff | | |
| source | <pre> <simpleType name="enum_0103"> <annotation> <documentation>Kat_BI_OperationsdetailPrimaereingriff</documentation> </annotation> <restriction base="xs:string"> <enumeration value="0103001"> <annotation> <documentation>simultane Lappendeckung</documentation> </annotation> </enumeration> <enumeration value="0103002"> <annotation> <documentation>simultane Eigenfetttransplantation</documentation> </annotation> </enumeration> <enumeration value="0103003"> <annotation> <documentation>simultane Mastopexie</documentation> </pre> | | |

| | |
|--|---|
| | <pre> </annotation> </enumeration> <enumeration value="0103005"> <annotation> <documentation>simultane Mastektomie, Ablatio / hautsparend</documentation> </annotation> </enumeration> <enumeration value="0103006"> <annotation> <documentation>simultane Mastektomie, nippelerhaltend</documentation> </annotation> </enumeration> <enumeration value="0103007"> <annotation> <documentation>Axilla-Dissektion</documentation> </annotation> </enumeration> <enumeration value="0103008"> <annotation> <documentation>Drainage</documentation> </annotation> </enumeration> </restriction> </simpleType> </pre> |
|--|---|

simpleType enum_0104

| | | | |
|------------|---|---------|--|
| namespace | http://xml.ir-d.de/irdsaa | | |
| type | restriction of string | | |
| properties | base xs:string | | |
| facets | Kind | Value | Annotation |
| | enumeration | 0104001 | documentation Austausch Expander gegen dauerhaftes Brustimplantat |
| annotation | documentation Kat_BI_GrundAustausch | | |
| source | <pre> <simpleType name="enum_0104"> <annotation> <documentation>Kat_BI_GrundAustausch</documentation> </annotation> <restriction base="xs:string"> <enumeration value="0104001"> <annotation> <documentation>Austausch Expander gegen dauerhaftes Brustimplantat</documentation> </annotation> </enumeration> </restriction> </simpleType> </pre> | | |

simpleType enum_0105

| | | | |
|-----------|------------------------------|--|--|
| namespace | http://xml.ir-d.de/irdsaa | | |
| type | restriction of string | | |

| properties | base xs:string | | | | | | | | | | | | | | | | | | | | | | | | |
|-------------|---|---|-------|------------|-------------|---------|--|-------------|---------|---|-------------|---------|---------------------------------------|-------------|---------|---------------------------|-------------|---------|--|-------------|---------|--|-------------|---------|----------------------------|
| facets | <table border="1"> <thead> <tr> <th>Kind</th> <th>Value</th> <th>Annotation</th> </tr> </thead> <tbody> <tr> <td>enumeration</td> <td>0105001</td> <td>documentation simultane Lappendeckung</td> </tr> <tr> <td>enumeration</td> <td>0105002</td> <td>documentation simultane Eigenfetttransplantation</td> </tr> <tr> <td>enumeration</td> <td>0105003</td> <td>documentation simultane Mastopexie</td> </tr> <tr> <td>enumeration</td> <td>0105008</td> <td>documentation Drainage</td> </tr> <tr> <td>enumeration</td> <td>0105009</td> <td>documentation Kapsulektomie, komplett</td> </tr> <tr> <td>enumeration</td> <td>0105010</td> <td>documentation Kapsulektomie, partiell</td> </tr> <tr> <td>enumeration</td> <td>0105011</td> <td>documentation Neopocket</td> </tr> </tbody> </table> | Kind | Value | Annotation | enumeration | 0105001 | documentation simultane Lappendeckung | enumeration | 0105002 | documentation simultane Eigenfetttransplantation | enumeration | 0105003 | documentation simultane Mastopexie | enumeration | 0105008 | documentation Drainage | enumeration | 0105009 | documentation Kapsulektomie, komplett | enumeration | 0105010 | documentation Kapsulektomie, partiell | enumeration | 0105011 | documentation Neopocket |
| Kind | Value | Annotation | | | | | | | | | | | | | | | | | | | | | | | |
| enumeration | 0105001 | documentation simultane Lappendeckung | | | | | | | | | | | | | | | | | | | | | | | |
| enumeration | 0105002 | documentation simultane Eigenfetttransplantation | | | | | | | | | | | | | | | | | | | | | | | |
| enumeration | 0105003 | documentation simultane Mastopexie | | | | | | | | | | | | | | | | | | | | | | | |
| enumeration | 0105008 | documentation Drainage | | | | | | | | | | | | | | | | | | | | | | | |
| enumeration | 0105009 | documentation Kapsulektomie, komplett | | | | | | | | | | | | | | | | | | | | | | | |
| enumeration | 0105010 | documentation Kapsulektomie, partiell | | | | | | | | | | | | | | | | | | | | | | | |
| enumeration | 0105011 | documentation Neopocket | | | | | | | | | | | | | | | | | | | | | | | |
| annotation | documentation Kat_BI_OperationsdetailAustausch | | | | | | | | | | | | | | | | | | | | | | | | |
| source | <pre> <simpleType name="enum_0105"> <annotation> <documentation>Kat_BI_OperationsdetailAustausch</documentation> </annotation> <restriction base="xs:string"> <enumeration value="0105001"> <annotation> <documentation>simultane Lappendeckung</documentation> </annotation> </enumeration> <enumeration value="0105002"> <annotation> <documentation>simultane Eigenfetttransplantation</documentation> </annotation> </enumeration> <enumeration value="0105003"> <annotation> <documentation>simultane Mastopexie</documentation> </annotation> </enumeration> <enumeration value="0105008"> <annotation> <documentation>Drainage</documentation> </annotation> </enumeration> <enumeration value="0105009"> <annotation> <documentation>Kapsulektomie, komplett</documentation> </annotation> </enumeration> <enumeration value="0105010"> <annotation> <documentation>Kapsulektomie, partiell</documentation> </annotation> </enumeration> <enumeration value="0105011"> <annotation> <documentation>Neopocket</documentation> </annotation> </enumeration> </restriction> </pre> | | | | | | | | | | | | | | | | | | | | | | | | |

| | |
|--|----------------------------------|
| | <code></simpleType></code> |
|--|----------------------------------|

simpleType enum_0106

| | | | |
|------------|--|---------|----------------------------------|
| namespace | http://xml.ir-d.de/irdsaa | | |
| type | restriction of string | | |
| properties | base xs:string | | |
| facets | Kind | Value | Annotation |
| | enumeration | 0106001 | documentation Patientenwunsch |
| | enumeration | 0106002 | documentation asymptomatisch |
| | enumeration | 0106003 | documentation Komplikation |
| annotation | documentation Kat_BI_GrundRevisionExplantation | | |
| source | <pre> <simpleType name="enum_0106"> <annotation> <documentation>Kat_BI_GrundRevisionExplantation</documentation> </annotation> <restriction base="xs:string"> <enumeration value="0106001"> <annotation> <documentation>Patientenwunsch</documentation> </annotation> </enumeration> <enumeration value="0106002"> <annotation> <documentation>asymptomatisch</documentation> </annotation> </enumeration> <enumeration value="0106003"> <annotation> <documentation>Komplikation</documentation> </annotation> </enumeration> </restriction> </simpleType> </pre> | | |

simpleType enum_0107

| | | | |
|------------|------------------------------|---------|---|
| namespace | http://xml.ir-d.de/irdsaa | | |
| type | restriction of string | | |
| properties | base xs:string | | |
| facets | Kind | Value | Annotation |
| | enumeration | 0107001 | documentation simultane Lappendeckung |
| | enumeration | 0107002 | documentation simultane Eigenfetttransplantation |
| | enumeration | 0107003 | documentation simultane Mastopexie |
| | enumeration | 0107005 | documentation simultane Mastektomie, Ablatio / hautsparend |
| | enumeration | 0107006 | documentation simultane Mastektomie, nippelerhaltend |

| | |
|------------|---|
| | <p>enumeration 0107007 documentation Axilla-Dissektion</p> <p>enumeration 0107008 documentation Drainage</p> <p>enumeration 0107009 documentation Kapsulektomie, komplett</p> <p>enumeration 0107010 documentation Kapsulektomie, partiell</p> <p>enumeration 0107011 documentation Neopocket</p> |
| annotation | <p>documentation Kat_BI_OperationsdetailRevision</p> |
| source | <pre> <simpleType name="enum_0107"> <annotation> <documentation>Kat_BI_OperationsdetailRevision</documentation> </annotation> <restriction base="xs:string"> <enumeration value="0107001"> <annotation> <documentation>simultane Lappendeckung</documentation> </annotation> </enumeration> <enumeration value="0107002"> <annotation> <documentation>simultane Eigenfetttransplantation</documentation> </annotation> </enumeration> <enumeration value="0107003"> <annotation> <documentation>simultane Mastopexie</documentation> </annotation> </enumeration> <enumeration value="0107005"> <annotation> <documentation>simultane Mastektomie, Ablatio / hautsparend</documentation> </annotation> </enumeration> <enumeration value="0107006"> <annotation> <documentation>simultane Mastektomie, nippelerhaltend</documentation> </annotation> </enumeration> <enumeration value="0107007"> <annotation> <documentation>Axilla-Dissektion</documentation> </annotation> </enumeration> <enumeration value="0107008"> <annotation> <documentation>Drainage</documentation> </annotation> </enumeration> <enumeration value="0107009"> <annotation> <documentation>Kapsulektomie, komplett</documentation> </annotation> </enumeration> <enumeration value="0107010"> <annotation> </pre> |

| | |
|--|--|
| | <pre> <documentation>Kapsulektomie, partiell</documentation> </annotation> </enumeration> <enumeration value="0107011"> <annotation> <documentation>Neopocket</documentation> </annotation> </enumeration> </restriction> </simpleType> </pre> |
|--|--|

simpleType enum_0110

| | | | |
|------------|---|---------|------------------------------|
| namespace | http://xml.ir-d.de/irdsaa | | |
| type | restriction of string | | |
| properties | base xs:string | | |
| facets | Kind | Value | Annotation |
| | enumeration | 0110001 | documentation Bestrahlung |
| annotation | documentation Kat_BI_VorbehandlungLokal | | |
| source | <pre> <simpleType name="enum_0110"> <annotation> <documentation>Kat_BI_VorbehandlungLokal</documentation> </annotation> <restriction base="xs:string"> <enumeration value="0110001"> <annotation> <documentation>Bestrahlung</documentation> </annotation> </enumeration> </restriction> </simpleType> </pre> | | |

simpleType enum_0111

| | | | |
|------------|--|---------|--|
| namespace | http://xml.ir-d.de/irdsaa | | |
| type | restriction of string | | |
| properties | base xs:string | | |
| facets | Kind | Value | Annotation |
| | enumeration | 0111001 | documentation nein |
| | enumeration | 0111002 | documentation Lipofilling |
| | enumeration | 0111003 | documentation Eigengewebsrekonstruktion |
| annotation | documentation Kat_BI_Verfahrenswechsel | | |
| source | <pre> <simpleType name="enum_0111"> <annotation> <documentation>Kat_BI_Verfahrenswechsel</documentation> </annotation> <restriction base="xs:string"> <enumeration value="0111001"> </pre> | | |

| | |
|--|---|
| | <pre> <annotation> <documentation>nein</documentation> </annotation> </enumeration> <enumeration value="0111002"> <annotation> <documentation>Lipofilling</documentation> </annotation> </enumeration> <enumeration value="0111003"> <annotation> <documentation>Eigengewebsrekonstruktion</documentation> </annotation> </enumeration> </restriction> </simpleType> </pre> |
|--|---|

simpleType enum_0112

| | | | |
|------------|--|---------|---|
| namespace | http://xml.ir-d.de/irdsaa | | |
| type | restriction of string | | |
| properties | base xs:string | | |
| facets | Kind | Value | Annotation |
| | enumeration | 0112001 | documentation subglandulär / epipektoral |
| | enumeration | 0112002 | documentation subpektoral |
| | enumeration | 0112003 | documentation subfaszial |
| | enumeration | 0112004 | documentation sub-flap |
| | enumeration | 0112005 | documentation subkutan |
| | enumeration | 0112006 | documentation dual plane |
| | enumeration | 0112042 | documentation andere |
| annotation | documentation Kat_BI_LageImplantat | | |
| source | <pre> <simpleType name="enum_0112"> <annotation> <documentation>Kat_BI_LageImplantat</documentation> </annotation> <restriction base="xs:string"> <enumeration value="0112001"> <annotation> <documentation>subglandulär / epipektoral</documentation> </annotation> </enumeration> <enumeration value="0112002"> <annotation> <documentation>subpektoral</documentation> </annotation> </enumeration> <enumeration value="0112003"> <annotation> <documentation>subfaszial</documentation> </pre> | | |

| | |
|--|--|
| | <pre> </annotation> </enumeration> <enumeration value="0112004"> <annotation> <documentation>sub-flap</documentation> </annotation> </enumeration> <enumeration value="0112005"> <annotation> <documentation>subkutan</documentation> </annotation> </enumeration> <enumeration value="0112006"> <annotation> <documentation>dual plane</documentation> </annotation> </enumeration> <enumeration value="0112042"> <annotation> <documentation>andere</documentation> </annotation> </enumeration> </restriction> </simpleType> </pre> |
|--|--|

simpleType enum_0113

| | | | |
|------------|--|---------|--|
| namespace | http://xml.ir-d.de/irdsaa | | |
| type | restriction of string | | |
| properties | base xs:string | | |
| facets | Kind | Value | Annotation |
| | enumeration | 0113001 | documentation Chemotherapie innerhalb der letzten drei Monate |
| annotation | documentation Kat_BI_VorbehandlungSystemisch | | |
| source | <pre> <simpleType name="enum_0113"> <annotation> <documentation>Kat_BI_VorbehandlungSystemisch</documentation> </annotation> <restriction base="xs:string"> <enumeration value="0113001"> <annotation> <documentation>Chemotherapie innerhalb der letzten drei Monate</documentation> </annotation> </enumeration> </restriction> </simpleType> </pre> | | |

simpleType enum_0114

| | | | |
|------------|------------------------------|--|--|
| namespace | http://xml.ir-d.de/irdsaa | | |
| type | restriction of string | | |
| properties | base xs:string | | |

| facets | <table border="1"> <thead> <tr> <th>Kind</th> <th>Value</th> <th>Annotation</th> </tr> </thead> <tbody> <tr> <td>enumeration</td> <td>0114001</td> <td>documentation vollständig</td> </tr> <tr> <td>enumeration</td> <td>0114002</td> <td>documentation nein</td> </tr> <tr> <td>enumeration</td> <td>0114003</td> <td>documentation teilweise</td> </tr> <tr> <td>enumeration</td> <td>0114004</td> <td>documentation nicht vorhanden</td> </tr> </tbody> </table> | Kind | Value | Annotation | enumeration | 0114001 | documentation vollständig | enumeration | 0114002 | documentation nein | enumeration | 0114003 | documentation teilweise | enumeration | 0114004 | documentation nicht vorhanden |
|-------------|--|----------------------------------|-------|------------|-------------|---------|------------------------------|-------------|---------|-----------------------|-------------|---------|----------------------------|-------------|---------|----------------------------------|
| Kind | Value | Annotation | | | | | | | | | | | | | | |
| enumeration | 0114001 | documentation vollständig | | | | | | | | | | | | | | |
| enumeration | 0114002 | documentation nein | | | | | | | | | | | | | | |
| enumeration | 0114003 | documentation teilweise | | | | | | | | | | | | | | |
| enumeration | 0114004 | documentation nicht vorhanden | | | | | | | | | | | | | | |
| annotation | documentation Kat_BI_EntfernungADMNetz | | | | | | | | | | | | | | | |
| source | <pre> <simpleType name="enum_0114"> <annotation> <documentation>Kat_BI_EntfernungADMNetz</documentation> </annotation> <restriction base="xs:string"> <enumeration value="0114001"> <annotation> <documentation>vollständig</documentation> </annotation> </enumeration> <enumeration value="0114002"> <annotation> <documentation>nein</documentation> </annotation> </enumeration> <enumeration value="0114003"> <annotation> <documentation>teilweise</documentation> </annotation> </enumeration> <enumeration value="0114004"> <annotation> <documentation>nicht vorhanden</documentation> </annotation> </enumeration> </restriction> </simpleType> </pre> | | | | | | | | | | | | | | | |

simpleType enum_0116

| namespace | http://xml.ir-d.de/irdsaa | | | | | | | | | | | | | | | | | | | | | | | | |
|-------------|---|---|-------|------------|-------------|---------|--|-------------|---------|--|-------------|---------|---|-------------|---------|----------------------------------|-------------|---------|---|-------------|---------|--|-------------|---------|---------------|
| type | restriction of string | | | | | | | | | | | | | | | | | | | | | | | | |
| properties | base xs:string | | | | | | | | | | | | | | | | | | | | | | | | |
| facets | <table border="1"> <thead> <tr> <th>Kind</th> <th>Value</th> <th>Annotation</th> </tr> </thead> <tbody> <tr> <td>enumeration</td> <td>0116001</td> <td>documentation Spülung, antibiotisch</td> </tr> <tr> <td>enumeration</td> <td>0116002</td> <td>documentation Spülung, antiseptisch</td> </tr> <tr> <td>enumeration</td> <td>0116003</td> <td>documentation Spülung, wirkstofffrei</td> </tr> <tr> <td>enumeration</td> <td>0116004</td> <td>documentation Spülung, andere</td> </tr> <tr> <td>enumeration</td> <td>0116005</td> <td>documentation prä-/perioperative Antibiotika</td> </tr> <tr> <td>enumeration</td> <td>0116006</td> <td>documentation postoperative Antibiotika</td> </tr> <tr> <td>enumeration</td> <td>0116007</td> <td>documentation</td> </tr> </tbody> </table> | Kind | Value | Annotation | enumeration | 0116001 | documentation Spülung, antibiotisch | enumeration | 0116002 | documentation Spülung, antiseptisch | enumeration | 0116003 | documentation Spülung, wirkstofffrei | enumeration | 0116004 | documentation Spülung, andere | enumeration | 0116005 | documentation prä-/perioperative Antibiotika | enumeration | 0116006 | documentation postoperative Antibiotika | enumeration | 0116007 | documentation |
| Kind | Value | Annotation | | | | | | | | | | | | | | | | | | | | | | | |
| enumeration | 0116001 | documentation Spülung, antibiotisch | | | | | | | | | | | | | | | | | | | | | | | |
| enumeration | 0116002 | documentation Spülung, antiseptisch | | | | | | | | | | | | | | | | | | | | | | | |
| enumeration | 0116003 | documentation Spülung, wirkstofffrei | | | | | | | | | | | | | | | | | | | | | | | |
| enumeration | 0116004 | documentation Spülung, andere | | | | | | | | | | | | | | | | | | | | | | | |
| enumeration | 0116005 | documentation prä-/perioperative Antibiotika | | | | | | | | | | | | | | | | | | | | | | | |
| enumeration | 0116006 | documentation postoperative Antibiotika | | | | | | | | | | | | | | | | | | | | | | | |
| enumeration | 0116007 | documentation | | | | | | | | | | | | | | | | | | | | | | | |

| | |
|------------|--|
| | enumeration 0116008 Handschuhwechsel vor Implantation documentation Implantationshilfe |
| annotation | documentation Kat_BI_Operationsmassnahme |
| source | <pre> <simpleType name="enum_0116"> <annotation> <documentation>Kat_BI_Operationsmassnahme</documentation> </annotation> <restriction base="xs:string"> <enumeration value="0116001"> <annotation> <documentation>Spülung, antibiotisch</documentation> </annotation> </enumeration> <enumeration value="0116002"> <annotation> <documentation>Spülung, antiseptisch</documentation> </annotation> </enumeration> <enumeration value="0116003"> <annotation> <documentation>Spülung, wirkstofffrei</documentation> </annotation> </enumeration> <enumeration value="0116004"> <annotation> <documentation>Spülung, andere</documentation> </annotation> </enumeration> <enumeration value="0116005"> <annotation> <documentation>prä-/perioperative Antibiotika</documentation> </annotation> </enumeration> <enumeration value="0116006"> <annotation> <documentation>postoperative Antibiotika</documentation> </annotation> </enumeration> <enumeration value="0116007"> <annotation> <documentation>Handschuhwechsel vor Implantation</documentation> </annotation> </enumeration> <enumeration value="0116008"> <annotation> <documentation>Implantationshilfe</documentation> </annotation> </enumeration> </restriction> </simpleType> </pre> |

simpleType enum_0118

| | |
|-----------|------------------------------|
| namespace | http://xml.ir-d.de/irdsaa |
| type | restriction of string |

| properties | base xs:string | | | | | | | | | | | | | | | | | | |
|-------------|--|-----------------------------------|-------|------------|-------------|---------|--------------------------|-------------|---------|------------------------------|-------------|---------|------------------------------|-------------|---------|-----------------------------------|-------------|---------|--------------------------|
| facets | <table border="1"> <thead> <tr> <th>Kind</th> <th>Value</th> <th>Annotation</th> </tr> </thead> <tbody> <tr> <td>enumeration</td> <td>0118001</td> <td>documentation axillär</td> </tr> <tr> <td>enumeration</td> <td>0118002</td> <td>documentation periareolär</td> </tr> <tr> <td>enumeration</td> <td>0118003</td> <td>documentation inframammär</td> </tr> <tr> <td>enumeration</td> <td>0118004</td> <td>documentation Mastektomienarbe</td> </tr> <tr> <td>enumeration</td> <td>0118042</td> <td>documentation anderer</td> </tr> </tbody> </table> | Kind | Value | Annotation | enumeration | 0118001 | documentation axillär | enumeration | 0118002 | documentation periareolär | enumeration | 0118003 | documentation inframammär | enumeration | 0118004 | documentation Mastektomienarbe | enumeration | 0118042 | documentation anderer |
| Kind | Value | Annotation | | | | | | | | | | | | | | | | | |
| enumeration | 0118001 | documentation axillär | | | | | | | | | | | | | | | | | |
| enumeration | 0118002 | documentation periareolär | | | | | | | | | | | | | | | | | |
| enumeration | 0118003 | documentation inframammär | | | | | | | | | | | | | | | | | |
| enumeration | 0118004 | documentation Mastektomienarbe | | | | | | | | | | | | | | | | | |
| enumeration | 0118042 | documentation anderer | | | | | | | | | | | | | | | | | |
| annotation | documentation Kat_BI_Operationszugang | | | | | | | | | | | | | | | | | | |
| source | <pre> <simpleType name="enum_0118"> <annotation> <documentation>Kat_BI_Operationszugang</documentation> </annotation> <restriction base="xs:string"> <enumeration value="0118001"> <annotation> <documentation>axillär</documentation> </annotation> </enumeration> <enumeration value="0118002"> <annotation> <documentation>periareolär</documentation> </annotation> </enumeration> <enumeration value="0118003"> <annotation> <documentation>inframammär</documentation> </annotation> </enumeration> <enumeration value="0118004"> <annotation> <documentation>Mastektomienarbe</documentation> </annotation> </enumeration> <enumeration value="0118042"> <annotation> <documentation>anderer</documentation> </annotation> </enumeration> </restriction> </simpleType> </pre> | | | | | | | | | | | | | | | | | | |

simpleType enum_0120

| namespace | http://xml.ir-d.de/irdsaa | | | | | | |
|-------------|---|----------------------------------|-------|------------|-------------|---------|----------------------------------|
| type | restriction of string | | | | | | |
| properties | base xs:string | | | | | | |
| facets | <table border="1"> <thead> <tr> <th>Kind</th> <th>Value</th> <th>Annotation</th> </tr> </thead> <tbody> <tr> <td>enumeration</td> <td>0120001</td> <td>documentation Expander defekt</td> </tr> </tbody> </table> | Kind | Value | Annotation | enumeration | 0120001 | documentation Expander defekt |
| Kind | Value | Annotation | | | | | |
| enumeration | 0120001 | documentation Expander defekt | | | | | |
| annotation | documentation Kat BI BefundAustausch | | | | | | |

| | |
|--------|--|
| source | <pre> <simpleType name="enum_0120"> <annotation> <documentation>Kat_BI_BefundAustausch</documentation> </annotation> <restriction base="xs:string"> <enumeration value="0120001"> <annotation> <documentation>Expander defekt</documentation> </annotation> </enumeration> </restriction> </simpleType> </pre> |
|--------|--|

simpleType enum_0121

| | | | |
|------------|---|---------|---|
| namespace | http://xml.ir-d.de/irdsaa | | |
| type | restriction of string | | |
| properties | base xs:string | | |
| facets | Kind | Value | Annotation |
| | enumeration | 0121001 | documentation Infektion |
| | enumeration | 0121002 | documentation Serom |
| | enumeration | 0121003 | documentation Hämatom |
| | enumeration | 0121004 | documentation Kapsel fibrose |
| | enumeration | 0121005 | documentation Implantatruptur |
| | enumeration | 0121006 | documentation Fehlpositionierung/Rotation |
| | enumeration | 0121007 | documentation BIA-ALCL/-SCC, Verdacht |
| | enumeration | 0121008 | documentation BIA-ALCL/-SCC, pathologisch bestätigt |
| | enumeration | 0121009 | documentation Brustschmerzen |
| | enumeration | 0121010 | documentation Doppelkapsel |
| | enumeration | 0121011 | documentation Netz-/ADM-bedingte Komplikation, Non-Integration |
| | enumeration | 0121012 | documentation Netz-/ADM-bedingte Komplikation, andere |
| | enumeration | 0121013 | documentation Hautnekrose/exponiertes Implantat |
| | enumeration | 0121014 | documentation BII/ASIA (Brustimplantat assoziierte Symptome), Verdacht |
| | enumeration | 0121015 | documentation Lymphadenopathie |
| | enumeration | 0121016 | documentation Brustkrebs, neu aufgetreten/Rezidiv |
| annotation | documentation Kat_BI_BefundKomplett | | |
| source | <pre> <simpleType name="enum_0121"> <annotation> <documentation>Kat_BI_BefundKomplett</documentation> </annotation> <restriction base="xs:string"> <enumeration value="0121001"> </pre> | | |

```

    <annotation>
      <documentation>Infektion</documentation>
    </annotation>
  </enumeration>
  <enumeration value="0121002">
    <annotation>
      <documentation>Serom</documentation>
    </annotation>
  </enumeration>
  <enumeration value="0121003">
    <annotation>
      <documentation>Hämatom</documentation>
    </annotation>
  </enumeration>
  <enumeration value="0121004">
    <annotation>
      <documentation>Kapsel fibrose</documentation>
    </annotation>
  </enumeration>
  <enumeration value="0121005">
    <annotation>
      <documentation>Implantatruptur</documentation>
    </annotation>
  </enumeration>
  <enumeration value="0121006">
    <annotation>
      <documentation>Fehlpositionierung/Rotation</documentation>
    </annotation>
  </enumeration>
  <enumeration value="0121007">
    <annotation>
      <documentation>BIA-ALCL/-SCC, Verdacht</documentation>
    </annotation>
  </enumeration>
  <enumeration value="0121008">
    <annotation>
      <documentation>BIA-ALCL/-SCC, pathologisch bestätigt</documentation>
    </annotation>
  </enumeration>
  <enumeration value="0121009">
    <annotation>
      <documentation>Brustschmerzen</documentation>
    </annotation>
  </enumeration>
  <enumeration value="0121010">
    <annotation>
      <documentation>Doppelkapsel</documentation>
    </annotation>
  </enumeration>
  <enumeration value="0121011">
    <annotation>
      <documentation>Netz-/ADM-bedingte Komplikation,
Non-Integration</documentation>
    </annotation>
  </enumeration>
  <enumeration value="0121012">
    <annotation>
      <documentation>Netz-/ADM-bedingte Komplikation, andere</documentation>
    </annotation>
  </enumeration>

```

| | |
|--|--|
| | <pre> </enumeration> <enumeration value="0121013"> <annotation> <documentation>Hautnekrose/exponiertes Implantat</documentation> </annotation> </enumeration> <enumeration value="0121014"> <annotation> <documentation>BII/ASIA (Brustimplantat assoziierte Symptome), Verdacht</documentation> </annotation> </enumeration> <enumeration value="0121015"> <annotation> <documentation>Lymphadenopathie</documentation> </annotation> </enumeration> <enumeration value="0121016"> <annotation> <documentation>Brustkrebs, neu aufgetreten/Rezidiv</documentation> </annotation> </enumeration> </restriction> </simpleType> </pre> |
|--|--|

simpleType enum_0122

| | | | |
|------------|---|---------|--|
| namespace | http://xml.ir-d.de/irdsaa | | |
| type | restriction of string | | |
| properties | base xs:string | | |
| facets | Kind | Value | Annotation |
| | enumeration | 0122001 | documentation ja, ärztlich nachgewiesen |
| | enumeration | 0122002 | documentation nein |
| | enumeration | 0122042 | documentation unbekannt |
| annotation | documentation Kat BI Autoimmunerkrankung | | |
| source | <pre> <simpleType name="enum_0122"> <annotation> <documentation>Kat_BI_Autoimmunerkrankung</documentation> </annotation> <restriction base="xs:string"> <enumeration value="0122001"> <annotation> <documentation>ja, ärztlich nachgewiesen</documentation> </annotation> </enumeration> <enumeration value="0122002"> <annotation> <documentation>nein</documentation> </annotation> </enumeration> <enumeration value="0122042"> <annotation> <documentation>unbekannt</documentation> </annotation> </enumeration> </restriction> </simpleType> </pre> | | |

```

</annotation>
</enumeration>
</restriction>
</simpleType>

```

simpleType enum_0123

| | | | |
|------------|--|---------|--|
| namespace | http://xml.ir-d.de/irdsaa | | |
| type | restriction of string | | |
| properties | base xs:string | | |
| facets | Kind | Value | Annotation |
| | enumeration | 0123001 | documentation neu aufgetreten |
| | enumeration | 0123002 | documentation verschlechtert |
| | enumeration | 0123003 | documentation keine Veränderung |
| | enumeration | 0123004 | documentation nicht relevant, da Primäreingriff |
| | enumeration | 0123042 | documentation unbekannt |
| annotation | documentation Kat_BI_VerlaufAutoimmunerkrankung | | |
| source | <pre> <simpleType name="enum_0123"> <annotation> <documentation>Kat_BI_VerlaufAutoimmunerkrankung</documentation> </annotation> <restriction base="xs:string"> <enumeration value="0123001"> <annotation> <documentation>neu aufgetreten</documentation> </annotation> </enumeration> <enumeration value="0123002"> <annotation> <documentation>verschlechtert</documentation> </annotation> </enumeration> <enumeration value="0123003"> <annotation> <documentation>keine Veränderung</documentation> </annotation> </enumeration> <enumeration value="0123004"> <annotation> <documentation>nicht relevant, da Primäreingriff</documentation> </annotation> </enumeration> <enumeration value="0123042"> <annotation> <documentation>unbekannt</documentation> </annotation> </enumeration> </restriction> </simpleType> </pre> | | |

simpleType enum_0124

| | | | |
|------------|---|---------|--|
| namespace | http://xml.ir-d.de/irdsaa | | |
| type | restriction of string | | |
| properties | base xs:string | | |
| facets | Kind | Value | Annotation |
| | enumeration | 0124001 | documentation Salzlösung |
| | enumeration | 0124002 | documentation Silikongel |
| | enumeration | 0124003 | documentation Kombination Silikongel und Salzlösung |
| | enumeration | 0124042 | documentation sonstige |
| annotation | documentation Kat_BI_Fuellung | | |
| source | <pre> <simpleType name="enum_0124"> <annotation> <documentation>Kat_BI_Fuellung</documentation> </annotation> <restriction base="xs:string"> <enumeration value="0124001"> <annotation> <documentation>Salzlösung</documentation> </annotation> </enumeration> <enumeration value="0124002"> <annotation> <documentation>Silikongel</documentation> </annotation> </enumeration> <enumeration value="0124003"> <annotation> <documentation>Kombination Silikongel und Salzlösung</documentation> </annotation> </enumeration> <enumeration value="0124042"> <annotation> <documentation>sonstige</documentation> </annotation> </enumeration> </restriction> </simpleType> </pre> | | |

simpleType enum_0126

| | | | |
|------------|------------------------------|---------|---|
| namespace | http://xml.ir-d.de/irdsaa | | |
| type | restriction of string | | |
| properties | base xs:string | | |
| facets | Kind | Value | Annotation |
| | enumeration | 0126001 | documentation anatomisch (tropfenförmig) |
| | enumeration | 0126002 | documentation rund (punktsymmetrisch) |
| | enumeration | 0126042 | documentation |

| | |
|------------|---|
| | sonstige |
| annotation | documentation Kat BI_Form |
| source | <pre> <simpleType name="enum_0126"> <annotation> <documentation>Kat_BI_Form</documentation> </annotation> <restriction base="xs:string"> <enumeration value="0126001"> <annotation> <documentation>anatomisch (tropfenförmig)</documentation> </annotation> </enumeration> <enumeration value="0126002"> <annotation> <documentation>rund (punktsymmetrisch)</documentation> </annotation> </enumeration> <enumeration value="0126042"> <annotation> <documentation>sonstige</documentation> </annotation> </enumeration> </restriction> </simpleType> </pre> |

simpleType enum_0128

| | | | |
|------------|---|---------|------------------------------|
| namespace | http://xml.ir-d.de/irdsaa | | |
| type | restriction of string | | |
| properties | base xs:string | | |
| facets | Kind | Value | Annotation |
| | enumeration | 0128001 | documentation glattwandig |
| | enumeration | 0128002 | documentation beschichtet |
| | enumeration | 0128003 | documentation texturiert |
| annotation | documentation Kat BI_Oberflaeche | | |
| source | <pre> <simpleType name="enum_0128"> <annotation> <documentation>Kat_BI_Oberflaeche</documentation> </annotation> <restriction base="xs:string"> <enumeration value="0128001"> <annotation> <documentation>glattwandig</documentation> </annotation> </enumeration> <enumeration value="0128002"> <annotation> <documentation>beschichtet</documentation> </annotation> </enumeration> <enumeration value="0128003"> <annotation> </pre> | | |

```

<documentation>texturiert</documentation>
</annotation>
</enumeration>
</restriction>
</simpleType>

```

simpleType enum_0130

| | | | |
|------------|---|---------|---|
| namespace | http://xml.ir-d.de/irdsaa | | |
| type | restriction of string | | |
| properties | base xs:string | | |
| facets | Kind | Value | Annotation |
| | enumeration | 0130001 | documentation Allergan |
| | enumeration | 0130002 | documentation Cereplas |
| | enumeration | 0130003 | documentation CUI (Cox Uphoff Implants) |
| | enumeration | 0130004 | documentation EMSI Biomedical |
| | enumeration | 0130005 | documentation Establishment labs |
| | enumeration | 0130006 | documentation Eurosilicone |
| | enumeration | 0130007 | documentation Nagor |
| | enumeration | 0130008 | documentation Groupe Sebbin |
| | enumeration | 0130009 | documentation Laboratoires Arion |
| | enumeration | 0130010 | documentation Mentor |
| | enumeration | 0130011 | documentation Pérouse Plastie SAS |
| | enumeration | 0130012 | documentation PIP M-Implants |
| | enumeration | 0130013 | documentation Polytech Health & Aesthetics |
| | enumeration | 0130014 | documentation Silimed |
| | enumeration | 0130015 | documentation Surgitek |
| | enumeration | 0130016 | documentation G&G Biotechnology |
| | enumeration | 0130017 | documentation nicht belegter Wert |
| | enumeration | 0130018 | documentation nicht belegter Wert |
| | enumeration | 0130019 | documentation nicht belegter Wert |
| | enumeration | 0130020 | documentation nicht belegter Wert |
| | enumeration | 0130021 | documentation nicht belegter Wert |
| | enumeration | 0130042 | documentation sonstiger |
| annotation | documentation Kat_BI_Hersteller | | |
| source | <simpleType name="enum_0130"> <annotation> | | |

```
<documentation>Kat_BI_Hersteller</documentation>
</annotation>
<restriction base="xs:string">
  <enumeration value="0130001">
    <annotation>
      <documentation>Allergan</documentation>
    </annotation>
  </enumeration>
  <enumeration value="0130002">
    <annotation>
      <documentation>Cereplas</documentation>
    </annotation>
  </enumeration>
  <enumeration value="0130003">
    <annotation>
      <documentation>CUI (Cox Uphoff Implants)</documentation>
    </annotation>
  </enumeration>
  <enumeration value="0130004">
    <annotation>
      <documentation>EMSI Biomedical</documentation>
    </annotation>
  </enumeration>
  <enumeration value="0130005">
    <annotation>
      <documentation>Establishment labs</documentation>
    </annotation>
  </enumeration>
  <enumeration value="0130006">
    <annotation>
      <documentation>Eurosilicone</documentation>
    </annotation>
  </enumeration>
  <enumeration value="0130007">
    <annotation>
      <documentation>Nagor</documentation>
    </annotation>
  </enumeration>
  <enumeration value="0130008">
    <annotation>
      <documentation>Groupe Sebbin</documentation>
    </annotation>
  </enumeration>
  <enumeration value="0130009">
    <annotation>
      <documentation>Laboratoires Arion</documentation>
    </annotation>
  </enumeration>
  <enumeration value="0130010">
    <annotation>
      <documentation>Mentor</documentation>
    </annotation>
  </enumeration>
  <enumeration value="0130011">
    <annotation>
      <documentation>Pérouse Plastie SAS</documentation>
    </annotation>
  </enumeration>
  <enumeration value="0130012">
```

```
<annotation>
  <documentation>PIP M-Implants</documentation>
</annotation>
</enumeration>
<enumeration value="0130013">
  <annotation>
    <documentation>Polytech Health & Aesthetics</documentation>
  </annotation>
</enumeration>
<enumeration value="0130014">
  <annotation>
    <documentation>Silimed</documentation>
  </annotation>
</enumeration>
<enumeration value="0130015">
  <annotation>
    <documentation>Surgitek</documentation>
  </annotation>
</enumeration>
<enumeration value="0130016">
  <annotation>
    <documentation>G&G Biotechnology</documentation>
  </annotation>
</enumeration>
<enumeration value="0130017">
  <annotation>
    <documentation>nicht belegter Wert</documentation>
  </annotation>
</enumeration>
<enumeration value="0130018">
  <annotation>
    <documentation>nicht belegter Wert</documentation>
  </annotation>
</enumeration>
<enumeration value="0130019">
  <annotation>
    <documentation>nicht belegter Wert</documentation>
  </annotation>
</enumeration>
<enumeration value="0130020">
  <annotation>
    <documentation>nicht belegter Wert</documentation>
  </annotation>
</enumeration>
<enumeration value="0130021">
  <annotation>
    <documentation>nicht belegter Wert</documentation>
  </annotation>
</enumeration>
<enumeration value="0130042">
  <annotation>
    <documentation>sonstiger</documentation>
  </annotation>
</enumeration>
</restriction>
</simpleType>
```

simpleType enum_0131

| | | | |
|------------|--|---------|---|
| namespace | http://xml.ir-d.de/irdsaa | | |
| type | restriction of string | | |
| properties | base xs:string | | |
| facets | Kind | Value | Annotation |
| | enumeration | 0131001 | documentation Allergan |
| | enumeration | 0131002 | documentation Establishment labs |
| | enumeration | 0131003 | documentation Eurosilicone |
| | enumeration | 0131004 | documentation Galatea |
| | enumeration | 0131005 | documentation Integra |
| | enumeration | 0131006 | documentation Lifecell |
| | enumeration | 0131007 | documentation MBP (Medical Biomaterial Products) |
| | enumeration | 0131008 | documentation Mentor |
| | enumeration | 0131009 | documentation Novus Scientific |
| | enumeration | 0131042 | documentation sonstiger |
| annotation | documentation Kat_BI_ZubehoerHersteller | | |
| source | <pre> <simpleType name="enum_0131"> <annotation> <documentation>Kat_BI_ZubehoerHersteller</documentation> </annotation> <restriction base="xs:string"> <enumeration value="0131001"> <annotation> <documentation>Allergan</documentation> </annotation> </enumeration> <enumeration value="0131002"> <annotation> <documentation>Establishment labs</documentation> </annotation> </enumeration> <enumeration value="0131003"> <annotation> <documentation>Eurosilicone</documentation> </annotation> </enumeration> <enumeration value="0131004"> <annotation> <documentation>Galatea</documentation> </annotation> </enumeration> <enumeration value="0131005"> <annotation> <documentation>Integra</documentation> </annotation> </enumeration> <enumeration value="0131006"> <annotation> </pre> | | |

| | |
|--|---|
| | <pre> <documentation>Lifecell</documentation> </annotation> </enumeration> <enumeration value="0131007"> <annotation> <documentation>MBP (Medical Biomaterial Products)</documentation> </annotation> </enumeration> <enumeration value="0131008"> <annotation> <documentation>Mentor</documentation> </annotation> </enumeration> <enumeration value="0131009"> <annotation> <documentation>Novus Scientific</documentation> </annotation> </enumeration> <enumeration value="0131042"> <annotation> <documentation>sonstiger</documentation> </annotation> </enumeration> </restriction> </simpleType> </pre> |
|--|---|

simpleType enum_0190

| | | | |
|------------|---|---------|---------------------------------|
| namespace | http://xml.ir-d.de/irdsaa | | |
| type | restriction of string | | |
| properties | base xs:string | | |
| facets | Kind | Value | Annotation |
| | enumeration | 0190001 | documentation Brustimplantat |
| | enumeration | 0190003 | documentation Brustexpander |
| annotation | documentation Kat_BI_Artikeltyp | | |
| source | <pre> <simpleType name="enum_0190"> <annotation> <documentation>Kat_BI_Artikeltyp</documentation> </annotation> <restriction base="xs:string"> <enumeration value="0190001"> <annotation> <documentation>Brustimplantat</documentation> </annotation> </enumeration> <enumeration value="0190003"> <annotation> <documentation>Brustexpander</documentation> </annotation> </enumeration> </restriction> </simpleType> </pre> | | |

simpleType enum_0191

| | | | |
|------------|--|---------|-----------------------|
| namespace | http://xml.ir-d.de/irdsaa | | |
| type | restriction of string | | |
| properties | base xs:string | | |
| facets | Kind | Value | Annotation |
| | enumeration | 0191001 | documentation Netz |
| | enumeration | 0191002 | documentation ADM |
| annotation | documentation Kat_BI_ZubehoerTyp | | |
| source | <pre> <simpleType name="enum_0191"> <annotation> <documentation>Kat_BI_ZubehoerTyp</documentation> </annotation> <restriction base="xs:string"> <enumeration value="0191001"> <annotation> <documentation>Netz</documentation> </annotation> </enumeration> <enumeration value="0191002"> <annotation> <documentation>ADM</documentation> </annotation> </enumeration> </restriction> </simpleType> </pre> | | |

simpleType enum_0200

| | | | |
|------------|---|---------|--------------------------------|
| namespace | http://xml.ir-d.de/irdsaa | | |
| type | restriction of string | | |
| properties | base xs:string | | |
| facets | Kind | Value | Annotation |
| | enumeration | 0200001 | documentation Erst-OP |
| | enumeration | 0200002 | documentation Folgeeingriff |
| annotation | documentation Kat_EP_ArtEingriff | | |
| source | <pre> <simpleType name="enum_0200"> <annotation> <documentation>Kat_EP_ArtEingriff</documentation> </annotation> <restriction base="xs:string"> <enumeration value="0200001"> <annotation> <documentation>Erst-OP</documentation> </annotation> </enumeration> <enumeration value="0200002"> <annotation> <documentation>Folgeeingriff</documentation> </annotation> </enumeration> </restriction> </simpleType> </pre> | | |

```

</annotation>
</enumeration>
</restriction>
</simpleType>

```

simpleType enum_0202

| | | | |
|------------|---|---------|--|
| namespace | http://xml.ir-d.de/irdsaa | | |
| type | restriction of string | | |
| properties | base xs:string | | |
| facets | Kind | Value | Annotation |
| | enumeration | 0202001 | documentation Lockerung |
| | enumeration | 0202002 | documentation Infektion, Verdacht auf |
| | enumeration | 0202003 | documentation Infektion, gesichert |
| | enumeration | 0202004 | documentation Luxation, Inlay aus der Pfanne |
| | enumeration | 0202005 | documentation Luxation, Kopf aus Pfanne/Inlay |
| | enumeration | 0202006 | documentation Periprothetische Fraktur |
| | enumeration | 0202007 | documentation Verschleiß des PE-Inlays |
| | enumeration | 0202008 | documentation Implantatbruch |
| | enumeration | 0202009 | documentation Implantatfehlage/Malalignent |
| | enumeration | 0202010 | documentation Osteolysen bei festem Implantat |
| | enumeration | 0202011 | documentation Progression der Grunderkrankung |
| | enumeration | 0202012 | documentation ARMD |
| | enumeration | 0202013 | documentation Verdacht auf allergische Reaktion |
| | enumeration | 0202021 | documentation Zustand nach Prothesenentfernung |
| | enumeration | 0202042 | documentation andere Gründe |
| annotation | documentation Kat_EP_GrundWechselHuefte | | |
| source | <pre> <simpleType name="enum_0202"> <annotation> <documentation>Kat_EP_GrundWechselHuefte</documentation> </annotation> <restriction base="xs:string"> <enumeration value="0202001"> <annotation> <documentation>Lockerung</documentation> </annotation> </enumeration> <enumeration value="0202002"> <annotation> <documentation>Infektion, Verdacht auf</documentation> </annotation> </enumeration> <enumeration value="0202003"> </pre> | | |

```
<annotation>
  <documentation>Infektion, gesichert</documentation>
</annotation>
</enumeration>
<enumeration value="0202004">
  <annotation>
    <documentation>Luxation, Inlay aus der Pfanne</documentation>
  </annotation>
</enumeration>
<enumeration value="0202005">
  <annotation>
    <documentation>Luxation, Kopf aus Pfanne/Inlay</documentation>
  </annotation>
</enumeration>
<enumeration value="0202006">
  <annotation>
    <documentation>Periprothetische Fraktur</documentation>
  </annotation>
</enumeration>
<enumeration value="0202007">
  <annotation>
    <documentation>Verschleiß des PE-Inlays</documentation>
  </annotation>
</enumeration>
<enumeration value="0202008">
  <annotation>
    <documentation>Implantatbruch</documentation>
  </annotation>
</enumeration>
<enumeration value="0202009">
  <annotation>
    <documentation>Implantatfehllage/Malalignent</documentation>
  </annotation>
</enumeration>
<enumeration value="0202010">
  <annotation>
    <documentation>Osteolysen bei festem Implantat</documentation>
  </annotation>
</enumeration>
<enumeration value="0202011">
  <annotation>
    <documentation>Progression der Grunderkrankung</documentation>
  </annotation>
</enumeration>
<enumeration value="0202012">
  <annotation>
    <documentation>ARMD</documentation>
  </annotation>
</enumeration>
<enumeration value="0202013">
  <annotation>
    <documentation>Verdacht auf allergische Reaktion</documentation>
  </annotation>
</enumeration>
<enumeration value="0202021">
  <annotation>
    <documentation>Zustand nach Prothesenentfernung</documentation>
  </annotation>
</enumeration>
```

| | |
|--|--|
| | <pre> <enumeration value="0202042"> <annotation> <documentation>andere Gründe</documentation> </annotation> </enumeration> </restriction> </simpleType> </pre> |
|--|--|

simpleType **enum_0204**

| | | | |
|------------|--|---------|--|
| namespace | http://xml.ir-d.de/irdsaa | | |
| type | restriction of string | | |
| properties | base xs:string | | |
| facets | Kind | Value | Annotation |
| | enumeration | 0204001 | documentation Lockerung |
| | enumeration | 0204002 | documentation Infektion, Verdacht auf |
| | enumeration | 0204003 | documentation Infektion, gesichert |
| | enumeration | 0204006 | documentation Periprothetische Fraktur |
| | enumeration | 0204007 | documentation Verschleiß |
| | enumeration | 0204008 | documentation Implantatbruch |
| | enumeration | 0204009 | documentation Implantatfehlage/Malalignent |
| | enumeration | 0204010 | documentation Osteolysen bei festem Implantat |
| | enumeration | 0204011 | documentation Progression der Grunderkrankung |
| | enumeration | 0204012 | documentation ARMD |
| | enumeration | 0204013 | documentation Verdacht auf allergische Reaktion |
| | enumeration | 0204014 | documentation Dislokation/Migration von Komponenten |
| | enumeration | 0204015 | documentation Bandinstabilität |
| | enumeration | 0204016 | documentation Bewegungseinschränkung |
| | enumeration | 0204021 | documentation Zustand nach Prothesenentfernung |
| | enumeration | 0204042 | documentation andere Gründe |
| annotation | documentation Kat_EP_GrundWechselKnie | | |
| source | <pre> <simpleType name="enum_0204"> <annotation> <documentation>Kat_EP_GrundWechselKnie</documentation> </annotation> <restriction base="xs:string"> <enumeration value="0204001"> <annotation> <documentation>Lockerung</documentation> </annotation> </enumeration> <enumeration value="0204002"> </pre> | | |

```
<annotation>
  <documentation>Infektion, Verdacht auf</documentation>
</annotation>
</enumeration>
<enumeration value="0204003">
  <annotation>
    <documentation>Infektion, gesichert</documentation>
  </annotation>
</enumeration>
<enumeration value="0204006">
  <annotation>
    <documentation>Periprothetische Fraktur</documentation>
  </annotation>
</enumeration>
<enumeration value="0204007">
  <annotation>
    <documentation>Verschleiß</documentation>
  </annotation>
</enumeration>
<enumeration value="0204008">
  <annotation>
    <documentation>Implantatbruch</documentation>
  </annotation>
</enumeration>
<enumeration value="0204009">
  <annotation>
    <documentation>Implantatfehlage/Malalignent</documentation>
  </annotation>
</enumeration>
<enumeration value="0204010">
  <annotation>
    <documentation>Osteolysen bei festem Implantat</documentation>
  </annotation>
</enumeration>
<enumeration value="0204011">
  <annotation>
    <documentation>Progression der Grunderkrankung</documentation>
  </annotation>
</enumeration>
<enumeration value="0204012">
  <annotation>
    <documentation>ARMD</documentation>
  </annotation>
</enumeration>
<enumeration value="0204013">
  <annotation>
    <documentation>Verdacht auf allergische Reaktion</documentation>
  </annotation>
</enumeration>
<enumeration value="0204014">
  <annotation>
    <documentation>Dislokation/Migration von Komponenten</documentation>
  </annotation>
</enumeration>
<enumeration value="0204015">
  <annotation>
    <documentation>Bandinstabilität</documentation>
  </annotation>
</enumeration>
```

```

<enumeration value="0204016">
  <annotation>
    <documentation>Bewegungseinschränkung</documentation>
  </annotation>
</enumeration>
<enumeration value="0204021">
  <annotation>
    <documentation>Zustand nach Prothesenentfernung</documentation>
  </annotation>
</enumeration>
<enumeration value="0204042">
  <annotation>
    <documentation>andere Gründe</documentation>
  </annotation>
</enumeration>
</restriction>
</simpleType>

```

simpleType enum 0206

| | | | |
|------------|------------------------------|---------|--|
| namespace | http://xml.ir-d.de/irdsaa | | |
| type | restriction of string | | |
| properties | base xs:string | | |
| facets | Kind | Value | Annotation |
| | enumeration | 0206001 | documentation Lockerung |
| | enumeration | 0206002 | documentation Infektion, Verdacht auf |
| | enumeration | 0206003 | documentation Infektion, gesichert |
| | enumeration | 0206004 | documentation Luxation, Inlay aus der Pfanne |
| | enumeration | 0206005 | documentation Luxation, Kopf aus Pfanne/Inlay |
| | enumeration | 0206006 | documentation Periprothetische Fraktur |
| | enumeration | 0206007 | documentation Verschleiß |
| | enumeration | 0206008 | documentation Implantatbruch |
| | enumeration | 0206009 | documentation Implantatfehlage/Malalignent |
| | enumeration | 0206010 | documentation Osteolysen bei festem Implantat |
| | enumeration | 0206011 | documentation Progression der Grunderkrankung |
| | enumeration | 0206012 | documentation ARM-D |
| | enumeration | 0206013 | documentation Verdacht auf allergische Reaktion |
| | enumeration | 0206014 | documentation Dislokation/Migration von Komponenten |
| | enumeration | 0206015 | documentation Bandinstabilität |
| | enumeration | 0206016 | documentation Bewegungseinschränkung |
| | enumeration | 0206021 | documentation Zustand nach Prothesenentfernung |
| | enumeration | 0206042 | documentation andere Gründe |

| | |
|------------|--|
| annotation | documentation Kat_EP_GrundWechselTFE |
| source | <pre> <simpleType name="enum_0206"> <annotation> <documentation>Kat_EP_GrundWechselTFE</documentation> </annotation> <restriction base="xs:string"> <enumeration value="0206001"> <annotation> <documentation>Lockerung</documentation> </annotation> </enumeration> <enumeration value="0206002"> <annotation> <documentation>Infektion, Verdacht auf</documentation> </annotation> </enumeration> <enumeration value="0206003"> <annotation> <documentation>Infektion, gesichert</documentation> </annotation> </enumeration> <enumeration value="0206004"> <annotation> <documentation>Luxation, Inlay aus der Pfanne</documentation> </annotation> </enumeration> <enumeration value="0206005"> <annotation> <documentation>Luxation, Kopf aus Pfanne/Inlay</documentation> </annotation> </enumeration> <enumeration value="0206006"> <annotation> <documentation>Periprothetische Fraktur</documentation> </annotation> </enumeration> <enumeration value="0206007"> <annotation> <documentation>Verschleiß</documentation> </annotation> </enumeration> <enumeration value="0206008"> <annotation> <documentation>Implantatbruch</documentation> </annotation> </enumeration> <enumeration value="0206009"> <annotation> <documentation>Implantatfehllage/Malalignent</documentation> </annotation> </enumeration> <enumeration value="0206010"> <annotation> <documentation>Osteolysen bei festem Implantat</documentation> </annotation> </enumeration> <enumeration value="0206011"> <annotation> </pre> |

```

    <documentation>Progression der Grunderkrankung</documentation>
  </annotation>
</enumeration>
<enumeration value="0206012">
  <annotation>
    <documentation>ARMD</documentation>
  </annotation>
</enumeration>
<enumeration value="0206013">
  <annotation>
    <documentation>Verdacht auf allergische Reaktion</documentation>
  </annotation>
</enumeration>
<enumeration value="0206014">
  <annotation>
    <documentation>Dislokation/Migration von Komponenten</documentation>
  </annotation>
</enumeration>
<enumeration value="0206015">
  <annotation>
    <documentation>Bandinstabilität</documentation>
  </annotation>
</enumeration>
<enumeration value="0206016">
  <annotation>
    <documentation>Bewegungseinschränkung</documentation>
  </annotation>
</enumeration>
<enumeration value="0206021">
  <annotation>
    <documentation>Zustand nach Prothesenentfernung</documentation>
  </annotation>
</enumeration>
<enumeration value="0206042">
  <annotation>
    <documentation>andere Gründe</documentation>
  </annotation>
</enumeration>
</restriction>
</simpleType>

```

simpleType enum_0210

| | | | |
|------------|------------------------------|---------|--|
| namespace | http://xml.ir-d.de/irdsaa | | |
| type | restriction of string | | |
| properties | base xs:string | | |
| facets | Kind | Value | Annotation |
| | enumeration | 0210001 | documentation keine relevante Voroperation |
| | enumeration | 0210002 | documentation Osteosynthese/Osteotomie (Becken) |
| | enumeration | 0210003 | documentation Osteosynthese/Osteotomie (Femur) |
| | enumeration | 0210004 | documentation Osteosynthese/Osteotomie (beides) |
| | enumeration | 0210005 | documentation Operation bei Hüftkopfnekrose |

| | |
|------------|---|
| | enumeration 0210006 documentation Arthrodese |
| | enumeration 0210042 documentation andere |
| annotation | documentation Kat_EP_VoroperationHuefte |
| source | <pre> <simpleType name="enum_0210"> <annotation> <documentation>Kat_EP_VoroperationHuefte</documentation> </annotation> <restriction base="xs:string"> <enumeration value="0210001"> <annotation> <documentation>keine relevante Voroperation</documentation> </annotation> </enumeration> <enumeration value="0210002"> <annotation> <documentation>Osteosynthese/Osteotomie (Becken)</documentation> </annotation> </enumeration> <enumeration value="0210003"> <annotation> <documentation>Osteosynthese/Osteotomie (Femur)</documentation> </annotation> </enumeration> <enumeration value="0210004"> <annotation> <documentation>Osteosynthese/Osteotomie (beides)</documentation> </annotation> </enumeration> <enumeration value="0210005"> <annotation> <documentation>Operation bei Hüftkopfnekrose</documentation> </annotation> </enumeration> <enumeration value="0210006"> <annotation> <documentation>Arthrodese</documentation> </annotation> </enumeration> <enumeration value="0210042"> <annotation> <documentation>andere</documentation> </annotation> </enumeration> </restriction> </simpleType> </pre> |

simpleType enum_0211

| | | | |
|------------|------------------------------|------------------|---|
| namespace | http://xml.ir-d.de/irdsaa | | |
| type | restriction of string | | |
| properties | base xs:string | | |
| facets | Kind enumeration | Value 0211001 | Annotation documentation keine relevante Voroperation |

| | |
|------------|---|
| | <p>enumeration 0211002 documentation Osteosynthese/Osteotomie (Femur)</p> <p>enumeration 0211003 documentation Osteosynthese/Osteotomie (Tibia)</p> <p>enumeration 0211004 documentation Osteosynthese/Osteotomie (Patella)</p> <p>enumeration 0211005 documentation Osteosynthese/Osteotomie (mehrere)</p> <p>enumeration 0211006 documentation Kapsel-/Bandapparat</p> <p>enumeration 0211007 documentation Arthrodese</p> <p>enumeration 0211042 documentation andere</p> |
| annotation | documentation Kat_EP_VoroperationKnie |
| source | <pre> <simpleType name="enum_0211"> <annotation> <documentation>Kat_EP_VoroperationKnie</documentation> </annotation> <restriction base="xs:string"> <enumeration value="0211001"> <annotation> <documentation>keine relevante Voroperation</documentation> </annotation> </enumeration> <enumeration value="0211002"> <annotation> <documentation>Osteosynthese/Osteotomie (Femur)</documentation> </annotation> </enumeration> <enumeration value="0211003"> <annotation> <documentation>Osteosynthese/Osteotomie (Tibia)</documentation> </annotation> </enumeration> <enumeration value="0211004"> <annotation> <documentation>Osteosynthese/Osteotomie (Patella)</documentation> </annotation> </enumeration> <enumeration value="0211005"> <annotation> <documentation>Osteosynthese/Osteotomie (mehrere)</documentation> </annotation> </enumeration> <enumeration value="0211006"> <annotation> <documentation>Kapsel-/Bandapparat</documentation> </annotation> </enumeration> <enumeration value="0211007"> <annotation> <documentation>Arthrodese</documentation> </annotation> </enumeration> <enumeration value="0211042"> <annotation> <documentation>andere</documentation> </annotation> </enumeration> </restriction> </simpleType> </pre> |

| | |
|--|--|
| | <pre> </enumeration> </restriction> </simpleType> </pre> |
|--|--|

simpleType enum_0212

| | | | |
|------------|--|---------|--|
| namespace | http://xml.ir-d.de/irdsaa | | |
| type | restriction of string | | |
| properties | base xs:string | | |
| facets | Kind | Value | Annotation |
| | enumeration | 0212001 | documentation Hüfte |
| | enumeration | 0212002 | documentation Knie |
| | enumeration | 0212003 | documentation Totaler Femurersatz inkl. Durchsteck-Prothese |
| annotation | documentation Kat_EP_Gelenk | | |
| source | <pre> <simpleType name="enum_0212"> <annotation> <documentation>Kat_EP_Gelenk</documentation> </annotation> <restriction base="xs:string"> <enumeration value="0212001"> <annotation> <documentation>Hüfte</documentation> </annotation> </enumeration> <enumeration value="0212002"> <annotation> <documentation>Knie</documentation> </annotation> </enumeration> <enumeration value="0212003"> <annotation> <documentation>Totaler Femurersatz inkl. Durchsteck-Prothese</documentation> </annotation> </enumeration> </restriction> </simpleType> </pre> | | |

simpleType enum_0220

| | | | |
|------------|------------------------------|---------|--------------------------------|
| namespace | http://xml.ir-d.de/irdsaa | | |
| type | restriction of string | | |
| properties | base xs:string | | |
| facets | Kind | Value | Annotation |
| | enumeration | 0220001 | documentation anterior |
| | enumeration | 0220002 | documentation anterolateral |
| | enumeration | 0220003 | documentation lateral |
| | enumeration | 0220004 | documentation |

| | |
|------------|---|
| | <p>enumeration 0220005 posterior documentation posterolateral</p> <p>enumeration 0220006 documentation 2-Inzisionen-Zugang</p> <p>enumeration 0220042 documentation sonstiges/unbekannt</p> |
| annotation | documentation Kat_EP_Operationszugang |
| source | <pre> <simpleType name="enum_0220"> <annotation> <documentation>Kat_EP_Operationszugang</documentation> </annotation> <restriction base="xs:string"> <enumeration value="0220001"> <annotation> <documentation>anterior</documentation> </annotation> </enumeration> <enumeration value="0220002"> <annotation> <documentation>anterolateral</documentation> </annotation> </enumeration> <enumeration value="0220003"> <annotation> <documentation>lateral</documentation> </annotation> </enumeration> <enumeration value="0220004"> <annotation> <documentation>posterior</documentation> </annotation> </enumeration> <enumeration value="0220005"> <annotation> <documentation>posterolateral</documentation> </annotation> </enumeration> <enumeration value="0220006"> <annotation> <documentation>2-Inzisionen-Zugang</documentation> </annotation> </enumeration> <enumeration value="0220042"> <annotation> <documentation>sonstiges/unbekannt</documentation> </annotation> </enumeration> </restriction> </simpleType> </pre> |

simpleType enum_0222

| | |
|------------|------------------------------|
| namespace | http://xml.ir-d.de/irdsaa |
| type | restriction of string |
| properties | base xs:string |

| facets | <table border="1"> <thead> <tr> <th>Kind</th> <th>Value</th> <th>Annotation</th> </tr> </thead> <tbody> <tr> <td>enumeration</td> <td>0222001</td> <td>documentation nein</td> </tr> <tr> <td>enumeration</td> <td>0222002</td> <td>documentation ja- Ausbau</td> </tr> <tr> <td>enumeration</td> <td>0222003</td> <td>documentation ja- Einbau</td> </tr> </tbody> </table> | Kind | Value | Annotation | enumeration | 0222001 | documentation nein | enumeration | 0222002 | documentation ja- Ausbau | enumeration | 0222003 | documentation ja- Einbau |
|-------------|---|-----------------------------|-------|------------|-------------|---------|-----------------------|-------------|---------|-----------------------------|-------------|---------|-----------------------------|
| Kind | Value | Annotation | | | | | | | | | | | |
| enumeration | 0222001 | documentation nein | | | | | | | | | | | |
| enumeration | 0222002 | documentation ja- Ausbau | | | | | | | | | | | |
| enumeration | 0222003 | documentation ja- Einbau | | | | | | | | | | | |
| annotation | documentation Kat_EP_Zweizeitwechsel | | | | | | | | | | | | |
| source | <pre> <simpleType name="enum_0222"> <annotation> <documentation>Kat_EP_Zweizeitwechsel</documentation> </annotation> <restriction base="xs:string"> <enumeration value="0222001"> <annotation> <documentation>nein</documentation> </annotation> </enumeration> <enumeration value="0222002"> <annotation> <documentation>ja- Ausbau</documentation> </annotation> </enumeration> <enumeration value="0222003"> <annotation> <documentation>ja- Einbau</documentation> </annotation> </enumeration> </restriction> </simpleType> </pre> | | | | | | | | | | | | |

simpleType enum_0230

| namespace | http://xml.ir-d.de/irdsaa | | | | | | | | | | | | | | | | | | | | | | | | | | | | | | | | | | | | |
|-------------|--|---|-------|------------|-------------|---------|--------------------------------------|-------------|---------|---|-------------|---------|------------------------------|-------------|---------|-------------------------|-------------|---------|-----------------------------------|-------------|---------|---------------------------------|-------------|---------|---------------------------------------|-------------|---------|---------------------------------|-------------|---------|-----------------------------------|-------------|---------|--|-------------|---------|---------------|
| type | restriction of string | | | | | | | | | | | | | | | | | | | | | | | | | | | | | | | | | | | | |
| properties | base xs:string | | | | | | | | | | | | | | | | | | | | | | | | | | | | | | | | | | | | |
| facets | <table border="1"> <thead> <tr> <th>Kind</th> <th>Value</th> <th>Annotation</th> </tr> </thead> <tbody> <tr> <td>enumeration</td> <td>0230001</td> <td>documentation Smith & Nephew GmbH</td> </tr> <tr> <td>enumeration</td> <td>0230002</td> <td>documentation Mathys Orthopädie GmbH</td> </tr> <tr> <td>enumeration</td> <td>0230003</td> <td>documentation Ceramtec AG</td> </tr> <tr> <td>enumeration</td> <td>0230004</td> <td>documentation Biomet</td> </tr> <tr> <td>enumeration</td> <td>0230005</td> <td>documentation Peter Brehm GmbH</td> </tr> <tr> <td>enumeration</td> <td>0230006</td> <td>documentation Amplitude GmbH</td> </tr> <tr> <td>enumeration</td> <td>0230007</td> <td>documentation Exactech Deutschland</td> </tr> <tr> <td>enumeration</td> <td>0230008</td> <td>documentation Globus Medical</td> </tr> <tr> <td>enumeration</td> <td>0230009</td> <td>documentation Implantcast GmbH</td> </tr> <tr> <td>enumeration</td> <td>0230010</td> <td>documentation DePuy Orthopädie GmbH</td> </tr> <tr> <td>enumeration</td> <td>0230011</td> <td>documentation</td> </tr> </tbody> </table> | Kind | Value | Annotation | enumeration | 0230001 | documentation Smith & Nephew GmbH | enumeration | 0230002 | documentation Mathys Orthopädie GmbH | enumeration | 0230003 | documentation Ceramtec AG | enumeration | 0230004 | documentation Biomet | enumeration | 0230005 | documentation Peter Brehm GmbH | enumeration | 0230006 | documentation Amplitude GmbH | enumeration | 0230007 | documentation Exactech Deutschland | enumeration | 0230008 | documentation Globus Medical | enumeration | 0230009 | documentation Implantcast GmbH | enumeration | 0230010 | documentation DePuy Orthopädie GmbH | enumeration | 0230011 | documentation |
| Kind | Value | Annotation | | | | | | | | | | | | | | | | | | | | | | | | | | | | | | | | | | | |
| enumeration | 0230001 | documentation Smith & Nephew GmbH | | | | | | | | | | | | | | | | | | | | | | | | | | | | | | | | | | | |
| enumeration | 0230002 | documentation Mathys Orthopädie GmbH | | | | | | | | | | | | | | | | | | | | | | | | | | | | | | | | | | | |
| enumeration | 0230003 | documentation Ceramtec AG | | | | | | | | | | | | | | | | | | | | | | | | | | | | | | | | | | | |
| enumeration | 0230004 | documentation Biomet | | | | | | | | | | | | | | | | | | | | | | | | | | | | | | | | | | | |
| enumeration | 0230005 | documentation Peter Brehm GmbH | | | | | | | | | | | | | | | | | | | | | | | | | | | | | | | | | | | |
| enumeration | 0230006 | documentation Amplitude GmbH | | | | | | | | | | | | | | | | | | | | | | | | | | | | | | | | | | | |
| enumeration | 0230007 | documentation Exactech Deutschland | | | | | | | | | | | | | | | | | | | | | | | | | | | | | | | | | | | |
| enumeration | 0230008 | documentation Globus Medical | | | | | | | | | | | | | | | | | | | | | | | | | | | | | | | | | | | |
| enumeration | 0230009 | documentation Implantcast GmbH | | | | | | | | | | | | | | | | | | | | | | | | | | | | | | | | | | | |
| enumeration | 0230010 | documentation DePuy Orthopädie GmbH | | | | | | | | | | | | | | | | | | | | | | | | | | | | | | | | | | | |
| enumeration | 0230011 | documentation | | | | | | | | | | | | | | | | | | | | | | | | | | | | | | | | | | | |

| | | | |
|--|-------------|---------|--|
| | enumeration | 0230012 | IO-International Orthopaedics documentation Joint Replacement Ltd. Instrumentation |
| | enumeration | 0230013 | documentation Merete |
| | enumeration | 0230014 | documentation S&G Implants GmbH |
| | enumeration | 0230015 | documentation Speetec Implantate GmbH |
| | enumeration | 0230016 | documentation Stemcup Medical Products GmbH |
| | enumeration | 0230017 | documentation Symbios Deutschland GmbH |
| | enumeration | 0230018 | documentation Tantum AG |
| | enumeration | 0230019 | documentation Tomier GmbH |
| | enumeration | 0230020 | documentation MicroPort Orthopedics GmbH |
| | enumeration | 0230021 | documentation aap Implanate AG |
| | enumeration | 0230022 | documentation AQImplants |
| | enumeration | 0230023 | documentation ESKA Orthodynamics GmbH |
| | enumeration | 0230024 | documentation Atecos medical AG |
| | enumeration | 0230025 | documentation Chiropro GmbH |
| | enumeration | 0230026 | documentation Medacta |
| | enumeration | 0230027 | documentation OHST Medizintechnik AG |
| | enumeration | 0230028 | documentation Lima Deutschland GmbH |
| | enumeration | 0230029 | documentation alloPlus GmbH |
| | enumeration | 0230030 | documentation Heraeus Medical GmbH |
| | enumeration | 0230031 | documentation ImplanTec Deutschland GmbH |
| | enumeration | 0230032 | documentation Falcon Medical GmbH |
| | enumeration | 0230033 | documentation Meril GmbH |
| | enumeration | 0230034 | documentation Zimmer Germany GmbH |
| | enumeration | 0230035 | documentation Stryker GmbH & Co. KG |
| | enumeration | 0230036 | documentation Aesculap AG |
| | enumeration | 0230037 | documentation Waldemar Link GmbH & Co. KG |
| | enumeration | 0230038 | documentation Corin Germany GmbH |
| | enumeration | 0230039 | documentation nicht belegter Wert |
| | enumeration | 0230040 | documentation nicht belegter Wert |
| | enumeration | 0230041 | documentation nicht belegter Wert |
| | enumeration | 0230042 | documentation sonstige |
| | enumeration | 0230043 | documentation nicht belegter Wert |

| | |
|------------|---|
| | enumeration 0230044 documentation nicht belegter Wert |
| annotation | documentation Kat_EP_Hersteller |
| source | <pre> <simpleType name="enum_0230"> <annotation> <documentation>Kat_EP_Hersteller</documentation> </annotation> <restriction base="xs:string"> <enumeration value="0230001"> <annotation> <documentation>Smith & Nephew GmbH</documentation> </annotation> </enumeration> <enumeration value="0230002"> <annotation> <documentation>Mathys Orthopädie GmbH</documentation> </annotation> </enumeration> <enumeration value="0230003"> <annotation> <documentation>Ceramtec AG</documentation> </annotation> </enumeration> <enumeration value="0230004"> <annotation> <documentation>Biomet</documentation> </annotation> </enumeration> <enumeration value="0230005"> <annotation> <documentation>Peter Brehm GmbH</documentation> </annotation> </enumeration> <enumeration value="0230006"> <annotation> <documentation>Amplitude GmbH</documentation> </annotation> </enumeration> <enumeration value="0230007"> <annotation> <documentation>Exactech Deutschland</documentation> </annotation> </enumeration> <enumeration value="0230008"> <annotation> <documentation>Globus Medical</documentation> </annotation> </enumeration> <enumeration value="0230009"> <annotation> <documentation>Implantcast GmbH</documentation> </annotation> </enumeration> <enumeration value="0230010"> <annotation> <documentation>DePuy Orthopädie GmbH</documentation> </annotation> </enumeration> </restriction> </simpleType> </pre> |

```
<enumeration value="0230011">
  <annotation>
    <documentation>IO-International Orthopaedics</documentation>
  </annotation>
</enumeration>
<enumeration value="0230012">
  <annotation>
    <documentation>Joint Replacement Ltd. Instrumentation</documentation>
  </annotation>
</enumeration>
<enumeration value="0230013">
  <annotation>
    <documentation>Merete</documentation>
  </annotation>
</enumeration>
<enumeration value="0230014">
  <annotation>
    <documentation>S&amp;G Implants GmbH</documentation>
  </annotation>
</enumeration>
<enumeration value="0230015">
  <annotation>
    <documentation>Speetec Implantate GmbH</documentation>
  </annotation>
</enumeration>
<enumeration value="0230016">
  <annotation>
    <documentation>Stemcup Medical Products GmbH</documentation>
  </annotation>
</enumeration>
<enumeration value="0230017">
  <annotation>
    <documentation>Symbios Deutschland GmbH</documentation>
  </annotation>
</enumeration>
<enumeration value="0230018">
  <annotation>
    <documentation>Tantum AG</documentation>
  </annotation>
</enumeration>
<enumeration value="0230019">
  <annotation>
    <documentation>Tornier GmbH</documentation>
  </annotation>
</enumeration>
<enumeration value="0230020">
  <annotation>
    <documentation>MicroPort Orthopedics GmbH</documentation>
  </annotation>
</enumeration>
<enumeration value="0230021">
  <annotation>
    <documentation>aap Implanate AG</documentation>
  </annotation>
</enumeration>
<enumeration value="0230022">
  <annotation>
    <documentation>AQImplants</documentation>
  </annotation>
</enumeration>
```

```
</enumeration>
<enumeration value="0230023">
  <annotation>
    <documentation>ESKA Orthodynamics GmbH</documentation>
  </annotation>
</enumeration>
<enumeration value="0230024">
  <annotation>
    <documentation>Atecos medical AG</documentation>
  </annotation>
</enumeration>
<enumeration value="0230025">
  <annotation>
    <documentation>Chiropro GmbH</documentation>
  </annotation>
</enumeration>
<enumeration value="0230026">
  <annotation>
    <documentation>Medacta</documentation>
  </annotation>
</enumeration>
<enumeration value="0230027">
  <annotation>
    <documentation>OHST Medizintechnik AG</documentation>
  </annotation>
</enumeration>
<enumeration value="0230028">
  <annotation>
    <documentation>Lima Deutschland GmbH</documentation>
  </annotation>
</enumeration>
<enumeration value="0230029">
  <annotation>
    <documentation>alloPlus GmbH</documentation>
  </annotation>
</enumeration>
<enumeration value="0230030">
  <annotation>
    <documentation>Heraeus Medical GmbH</documentation>
  </annotation>
</enumeration>
<enumeration value="0230031">
  <annotation>
    <documentation>ImplanTec Deutschland GmbH</documentation>
  </annotation>
</enumeration>
<enumeration value="0230032">
  <annotation>
    <documentation>Falcon Medical GmbH</documentation>
  </annotation>
</enumeration>
<enumeration value="0230033">
  <annotation>
    <documentation>Meril GmbH</documentation>
  </annotation>
</enumeration>
<enumeration value="0230034">
  <annotation>
    <documentation>Zimmer Germany GmbH</documentation>
  </annotation>
</enumeration>
```

```

</annotation>
</enumeration>
<enumeration value="0230035">
  <annotation>
    <documentation>Stryker GmbH & Co. KG</documentation>
  </annotation>
</enumeration>
<enumeration value="0230036">
  <annotation>
    <documentation>Aesculap AG</documentation>
  </annotation>
</enumeration>
<enumeration value="0230037">
  <annotation>
    <documentation>Waldemar Link GmbH & Co. KG</documentation>
  </annotation>
</enumeration>
<enumeration value="0230038">
  <annotation>
    <documentation>Corin Germany GmbH</documentation>
  </annotation>
</enumeration>
<enumeration value="0230039">
  <annotation>
    <documentation>nicht belegter Wert</documentation>
  </annotation>
</enumeration>
<enumeration value="0230040">
  <annotation>
    <documentation>nicht belegter Wert</documentation>
  </annotation>
</enumeration>
<enumeration value="0230041">
  <annotation>
    <documentation>nicht belegter Wert</documentation>
  </annotation>
</enumeration>
<enumeration value="0230042">
  <annotation>
    <documentation>sonstige</documentation>
  </annotation>
</enumeration>
<enumeration value="0230043">
  <annotation>
    <documentation>nicht belegter Wert</documentation>
  </annotation>
</enumeration>
<enumeration value="0230044">
  <annotation>
    <documentation>nicht belegter Wert</documentation>
  </annotation>
</enumeration>
</restriction>
</simpleType>

```

simpleType enum_0252

| | |
|-----------|---------------------------|
| namespace | http://xml.ir-d.de/irdsaa |
|-----------|---------------------------|

| type | restriction of string | | | | | | | | | | | | |
|-------------|--|-------------------------|-------|------------|-------------|---------|-------------------------|-------------|---------|-------------------------|-------------|---------|-------------------------|
| properties | base xs:string | | | | | | | | | | | | |
| facets | <table border="1"> <thead> <tr> <th>Kind</th> <th>Value</th> <th>Annotation</th> </tr> </thead> <tbody> <tr> <td>enumeration</td> <td>0252001</td> <td>documentation Pfanne</td> </tr> <tr> <td>enumeration</td> <td>0252002</td> <td>documentation Schaft</td> </tr> <tr> <td>enumeration</td> <td>0252003</td> <td>documentation beides</td> </tr> </tbody> </table> | Kind | Value | Annotation | enumeration | 0252001 | documentation Pfanne | enumeration | 0252002 | documentation Schaft | enumeration | 0252003 | documentation beides |
| Kind | Value | Annotation | | | | | | | | | | | |
| enumeration | 0252001 | documentation Pfanne | | | | | | | | | | | |
| enumeration | 0252002 | documentation Schaft | | | | | | | | | | | |
| enumeration | 0252003 | documentation beides | | | | | | | | | | | |
| annotation | documentation Kat_EP_KomponenteHuefte | | | | | | | | | | | | |
| source | <pre> <simpleType name="enum_0252"> <annotation> <documentation>Kat_EP_KomponenteHuefte</documentation> </annotation> <restriction base="xs:string"> <enumeration value="0252001"> <annotation> <documentation>Pfanne</documentation> </annotation> </enumeration> <enumeration value="0252002"> <annotation> <documentation>Schaft</documentation> </annotation> </enumeration> <enumeration value="0252003"> <annotation> <documentation>beides</documentation> </annotation> </enumeration> </restriction> </simpleType> </pre> | | | | | | | | | | | | |

simpleType **enum_0254**

| namespace | http://xml.ir-d.de/irdsaa | | | | | | | | | | | | | | | |
|-------------|---|--------------------------|-------|------------|-------------|---------|------------------------|-------------|---------|------------------------|-------------|---------|--------------------------|-------------|---------|--------------------------|
| type | restriction of string | | | | | | | | | | | | | | | |
| properties | base xs:string | | | | | | | | | | | | | | | |
| facets | <table border="1"> <thead> <tr> <th>Kind</th> <th>Value</th> <th>Annotation</th> </tr> </thead> <tbody> <tr> <td>enumeration</td> <td>0254001</td> <td>documentation Femur</td> </tr> <tr> <td>enumeration</td> <td>0254002</td> <td>documentation Tibia</td> </tr> <tr> <td>enumeration</td> <td>0254003</td> <td>documentation Patella</td> </tr> <tr> <td>enumeration</td> <td>0254004</td> <td>documentation mehrere</td> </tr> </tbody> </table> | Kind | Value | Annotation | enumeration | 0254001 | documentation Femur | enumeration | 0254002 | documentation Tibia | enumeration | 0254003 | documentation Patella | enumeration | 0254004 | documentation mehrere |
| Kind | Value | Annotation | | | | | | | | | | | | | | |
| enumeration | 0254001 | documentation Femur | | | | | | | | | | | | | | |
| enumeration | 0254002 | documentation Tibia | | | | | | | | | | | | | | |
| enumeration | 0254003 | documentation Patella | | | | | | | | | | | | | | |
| enumeration | 0254004 | documentation mehrere | | | | | | | | | | | | | | |
| annotation | documentation Kat_EP_KomponenteKnie | | | | | | | | | | | | | | | |
| source | <pre> <simpleType name="enum_0254"> <annotation> <documentation>Kat_EP_KomponenteKnie</documentation> </annotation> <restriction base="xs:string"> <enumeration value="0254001"> </pre> | | | | | | | | | | | | | | | |

| | |
|--|---|
| | <pre> <annotation> <documentation>Femur</documentation> </annotation> </enumeration> <enumeration value="0254002"> <annotation> <documentation>Tibia</documentation> </annotation> </enumeration> <enumeration value="0254003"> <annotation> <documentation>Patella</documentation> </annotation> </enumeration> <enumeration value="0254004"> <annotation> <documentation>mehrere</documentation> </annotation> </enumeration> </restriction> </simpleType> </pre> |
|--|---|

simpleType enum_0256

| | | | |
|------------|---|---------|------------------------------------|
| namespace | http://xml.ir-d.de/irdsaa | | |
| type | restriction of string | | |
| properties | base xs:string | | |
| facets | Kind | Value | Annotation |
| | enumeration | 0256001 | documentation Pfanne |
| | enumeration | 0256002 | documentation Schaft |
| | enumeration | 0256003 | documentation Pfanne und Schaft |
| | enumeration | 0256004 | documentation Femur |
| | enumeration | 0256005 | documentation Tibia |
| | enumeration | 0256006 | documentation Patella |
| | enumeration | 0256007 | documentation mehrere |
| annotation | documentation Kat_EP_KomponenteTFE | | |
| source | <pre> <simpleType name="enum_0256"> <annotation> <documentation>Kat_EP_KomponenteTFE</documentation> </annotation> <restriction base="xs:string"> <enumeration value="0256001"> <annotation> <documentation>Pfanne</documentation> </annotation> </enumeration> <enumeration value="0256002"> <annotation> <documentation>Schaft</documentation> </pre> | | |

| | |
|--|---|
| | <pre> </annotation> </enumeration> <enumeration value="0256003"> <annotation> <documentation>Pfanne und Schaft</documentation> </annotation> </enumeration> <enumeration value="0256004"> <annotation> <documentation>Femur</documentation> </annotation> </enumeration> <enumeration value="0256005"> <annotation> <documentation>Tibia</documentation> </annotation> </enumeration> <enumeration value="0256006"> <annotation> <documentation>Patella</documentation> </annotation> </enumeration> <enumeration value="0256007"> <annotation> <documentation>mehrere</documentation> </annotation> </enumeration> </restriction> </simpleType> </pre> |
|--|---|

simpleType enum_0262

| | | | |
|------------|--|---------|--------------------------|
| namespace | http://xml.ir-d.de/irdsaa | | |
| type | restriction of string | | |
| properties | base xs:string | | |
| facets | Kind | Value | Annotation |
| | enumeration | 0262001 | documentation Pfanne |
| | enumeration | 0262002 | documentation Schaft |
| | enumeration | 0262003 | documentation Kopf |
| | enumeration | 0262004 | documentation Inlay |
| | enumeration | 0262005 | documentation Adapter |
| | enumeration | 0262006 | documentation mehrere |
| annotation | documentation Kat_EP_ImplantatbruchHuefte | | |
| source | <pre> <simpleType name="enum_0262"> <annotation> <documentation>Kat_EP_ImplantatbruchHuefte</documentation> </annotation> <restriction base="xs:string"> <enumeration value="0262001"> <annotation> </pre> | | |

| | |
|--|---|
| | <pre> <documentation>Pfanne</documentation> </annotation> </enumeration> <enumeration value="0262002"> <annotation> <documentation>Schaft</documentation> </annotation> </enumeration> <enumeration value="0262003"> <annotation> <documentation>Kopf</documentation> </annotation> </enumeration> <enumeration value="0262004"> <annotation> <documentation>Inlay</documentation> </annotation> </enumeration> <enumeration value="0262005"> <annotation> <documentation>Adapter</documentation> </annotation> </enumeration> <enumeration value="0262006"> <annotation> <documentation>mehrere</documentation> </annotation> </enumeration> </restriction> </simpleType> </pre> |
|--|---|

simpleType enum_0264

| | | | |
|------------|--|---------|-------------------------------|
| namespace | http://xml.ir-d.de/irdsaa | | |
| type | restriction of string | | |
| properties | base xs:string | | |
| facets | Kind | Value | Annotation |
| | enumeration | 0264001 | documentation Femur |
| | enumeration | 0264002 | documentation Tibia |
| | enumeration | 0264003 | documentation Inlay |
| | enumeration | 0264004 | documentation Adapter |
| | enumeration | 0264005 | documentation Verlängerung |
| | enumeration | 0264006 | documentation Schrauben |
| | enumeration | 0264007 | documentation mehrere |
| | enumeration | 0264042 | documentation andere |
| annotation | documentation Kat_EP_ImplantatbruchKnie | | |
| source | <pre> <simpleType name="enum_0264"> <annotation> <documentation>Kat EP ImplantatbruchKnie</documentation> </pre> | | |

```

</annotation>
<restriction base="xs:string">
  <enumeration value="0264001">
    <annotation>
      <documentation>Femur</documentation>
    </annotation>
  </enumeration>
  <enumeration value="0264002">
    <annotation>
      <documentation>Tibia</documentation>
    </annotation>
  </enumeration>
  <enumeration value="0264003">
    <annotation>
      <documentation>Inlay</documentation>
    </annotation>
  </enumeration>
  <enumeration value="0264004">
    <annotation>
      <documentation>Adapter</documentation>
    </annotation>
  </enumeration>
  <enumeration value="0264005">
    <annotation>
      <documentation>Verlängerung</documentation>
    </annotation>
  </enumeration>
  <enumeration value="0264006">
    <annotation>
      <documentation>Schrauben</documentation>
    </annotation>
  </enumeration>
  <enumeration value="0264007">
    <annotation>
      <documentation>mehrere</documentation>
    </annotation>
  </enumeration>
  <enumeration value="0264042">
    <annotation>
      <documentation>andere</documentation>
    </annotation>
  </enumeration>
</restriction>
</simpleType>

```

simpleType enum_0266

| | | | |
|------------|------------------------------|---------|-------------------------|
| namespace | http://xml.ir-d.de/irdsaa | | |
| type | restriction of string | | |
| properties | base xs:string | | |
| facets | Kind | Value | Annotation |
| | enumeration | 0266001 | documentation Pfanne |
| | enumeration | 0266002 | documentation Schaft |
| | enumeration | 0266003 | documentation Kopf |

| | |
|------------|---|
| | <p>enumeration 0266004 documentation Inlay</p> <p>enumeration 0266005 documentation Adapter</p> <p>enumeration 0266006 documentation Femur</p> <p>enumeration 0266007 documentation Tibia</p> <p>enumeration 0266008 documentation Verlängerung</p> <p>enumeration 0266009 documentation Schrauben</p> <p>enumeration 0266010 documentation mehrere</p> <p>enumeration 0266042 documentation andere</p> |
| annotation | documentation Kat_EP_ImplantatbruchTFE |
| source | <pre> <simpleType name="enum_0266"> <annotation> <documentation>Kat_EP_ImplantatbruchTFE</documentation> </annotation> <restriction base="xs:string"> <enumeration value="0266001"> <annotation> <documentation>Pfanne</documentation> </annotation> </enumeration> <enumeration value="0266002"> <annotation> <documentation>Schaft</documentation> </annotation> </enumeration> <enumeration value="0266003"> <annotation> <documentation>Kopf</documentation> </annotation> </enumeration> <enumeration value="0266004"> <annotation> <documentation>Inlay</documentation> </annotation> </enumeration> <enumeration value="0266005"> <annotation> <documentation>Adapter</documentation> </annotation> </enumeration> <enumeration value="0266006"> <annotation> <documentation>Femur</documentation> </annotation> </enumeration> <enumeration value="0266007"> <annotation> <documentation>Tibia</documentation> </annotation> </enumeration> <enumeration value="0266008"> <annotation> </pre> |

| | |
|--|--|
| | <pre> <documentation>Verlängerung</documentation> </annotation> </enumeration> <enumeration value="0266009"> <annotation> <documentation>Schrauben</documentation> </annotation> </enumeration> <enumeration value="0266010"> <annotation> <documentation>mehrere</documentation> </annotation> </enumeration> <enumeration value="0266042"> <annotation> <documentation>andere</documentation> </annotation> </enumeration> </restriction> </simpleType> </pre> |
|--|--|

simpleType enum_0270

| | | | |
|------------|---|---------|---------------------------------------|
| namespace | http://xml.ir-d.de/irdsaa | | |
| type | restriction of string | | |
| properties | base xs:string | | |
| facets | Kind | Value | Annotation |
| | enumeration | 0270001 | documentation PE-Inlay |
| | enumeration | 0270002 | documentation patellare Komponente |
| | enumeration | 0270003 | documentation beides |
| annotation | documentation Kat_EP_VerschleissKnie | | |
| source | <pre> <simpleType name="enum_0270"> <annotation> <documentation>Kat_EP_VerschleissKnie</documentation> </annotation> <restriction base="xs:string"> <enumeration value="0270001"> <annotation> <documentation>PE-Inlay</documentation> </annotation> </enumeration> <enumeration value="0270002"> <annotation> <documentation>patellare Komponente</documentation> </annotation> </enumeration> <enumeration value="0270003"> <annotation> <documentation>beides</documentation> </annotation> </enumeration> </restriction> </pre> | | |

| | |
|--|----------------------------------|
| | <code></simpleType></code> |
|--|----------------------------------|

simpleType enum_0271

| namespace | http://xml.ir-d.de/irdsaa | | | | | | | | | | | | | | | | | | | | | |
|-------------|---|---------------------------------------|-------|------------|-------------|---------|---------------------------|-------------|---------|------------------------|-------------|---------|---------------------------------------|-------------|---------|---------------------------|-------------|---------|--------------------------|-------------|---------|-------------------------|
| type | restriction of string | | | | | | | | | | | | | | | | | | | | | |
| properties | base xs:string | | | | | | | | | | | | | | | | | | | | | |
| facets | <table><thead><tr><th>Kind</th><th>Value</th><th>Annotation</th></tr></thead><tbody><tr><td>enumeration</td><td>0271001</td><td>documentation Schraube</td></tr><tr><td>enumeration</td><td>0271002</td><td>documentation Inlay</td></tr><tr><td>enumeration</td><td>0271003</td><td>documentation patellare Komponente</td></tr><tr><td>enumeration</td><td>0271004</td><td>documentation Kopplung</td></tr><tr><td>enumeration</td><td>0271005</td><td>documentation mehrere</td></tr><tr><td>enumeration</td><td>0271042</td><td>documentation andere</td></tr></tbody></table> | Kind | Value | Annotation | enumeration | 0271001 | documentation Schraube | enumeration | 0271002 | documentation Inlay | enumeration | 0271003 | documentation patellare Komponente | enumeration | 0271004 | documentation Kopplung | enumeration | 0271005 | documentation mehrere | enumeration | 0271042 | documentation andere |
| Kind | Value | Annotation | | | | | | | | | | | | | | | | | | | | |
| enumeration | 0271001 | documentation Schraube | | | | | | | | | | | | | | | | | | | | |
| enumeration | 0271002 | documentation Inlay | | | | | | | | | | | | | | | | | | | | |
| enumeration | 0271003 | documentation patellare Komponente | | | | | | | | | | | | | | | | | | | | |
| enumeration | 0271004 | documentation Kopplung | | | | | | | | | | | | | | | | | | | | |
| enumeration | 0271005 | documentation mehrere | | | | | | | | | | | | | | | | | | | | |
| enumeration | 0271042 | documentation andere | | | | | | | | | | | | | | | | | | | | |
| annotation | documentation Kat_EP_MigrationKnie | | | | | | | | | | | | | | | | | | | | | |
| source | <pre><simpleType name="enum_0271"> <annotation> <documentation>Kat_EP_MigrationKnie</documentation> </annotation> <restriction base="xs:string"> <enumeration value="0271001"> <annotation> <documentation>Schraube</documentation> </annotation> </enumeration> <enumeration value="0271002"> <annotation> <documentation>Inlay</documentation> </annotation> </enumeration> <enumeration value="0271003"> <annotation> <documentation>patellare Komponente</documentation> </annotation> </enumeration> <enumeration value="0271004"> <annotation> <documentation>Kopplung</documentation> </annotation> </enumeration> <enumeration value="0271005"> <annotation> <documentation>mehrere</documentation> </annotation> </enumeration> <enumeration value="0271042"> <annotation> <documentation>andere</documentation> </annotation> </enumeration> </restriction> </simpleType></pre> | | | | | | | | | | | | | | | | | | | | | |

| | |
|--|---|
| | <pre> </restriction> </simpleType> </pre> |
|--|---|

simpleType enum_0290

| | | | |
|------------|--|---------|---|
| namespace | http://xml.ir-d.de/irdsaa | | |
| type | restriction of string | | |
| properties | base xs:string | | |
| facets | Kind | Value | Annotation |
| | enumeration | 0290001 | documentation Hüft-Komponente |
| | enumeration | 0290002 | documentation Knie-Komponente |
| | enumeration | 0290003 | documentation Modulare Komponente (Hüfte/Knie) |
| annotation | documentation Kat_EP_Artikeltyp | | |
| source | <pre> <simpleType name="enum_0290"> <annotation> <documentation>Kat_EP_Artikeltyp</documentation> </annotation> <restriction base="xs:string"> <enumeration value="0290001"> <annotation> <documentation>Hüft-Komponente</documentation> </annotation> </enumeration> <enumeration value="0290002"> <annotation> <documentation>Knie-Komponente</documentation> </annotation> </enumeration> <enumeration value="0290003"> <annotation> <documentation>Modulare Komponente (Hüfte/Knie)</documentation> </annotation> </enumeration> </restriction> </simpleType> </pre> | | |

simpleType enum_0291

| | | | |
|------------|---|---------|------------------------------------|
| namespace | http://xml.ir-d.de/irdsaa | | |
| type | restriction of string | | |
| properties | base xs:string | | |
| facets | Kind | Value | Annotation |
| | enumeration | 0291001 | documentation Knochen-Zement |
| | enumeration | 0291002 | documentation sonstiges Zubehör |
| annotation | documentation Kat_EP_ZubehoerTyp | | |
| source | <pre> <simpleType name="enum_0291"> <annotation> </pre> | | |

| | |
|--|---|
| | <pre> <documentation>Kat_EP_ZubehoerTyp</documentation> </annotation> <restriction base="xs:string"> <enumeration value="0291001"> <annotation> <documentation>Knochen-Zement</documentation> </annotation> </enumeration> <enumeration value="0291002"> <annotation> <documentation>sonstiges Zubehör</documentation> </annotation> </enumeration> </restriction> </simpleType> </pre> |
|--|---|

simpleType enum_0300

| | | | |
|------------|---|---------|---|
| namespace | http://xml.ir-d.de/irdsaa | | |
| type | restriction of string | | |
| properties | base xs:string | | |
| facets | Kind | Value | Annotation |
| | enumeration | 0300001 | documentation konventionieller Aortenklappenersatz |
| | enumeration | 0300002 | documentation kathetergestützte Aortenklappenimplantation (TAVI) |
| annotation | documentation Kat_AK_ArtEingriff | | |
| source | <pre> <simpleType name="enum_0300"> <annotation> <documentation>Kat_AK_ArtEingriff</documentation> </annotation> <restriction base="xs:string"> <enumeration value="0300001"> <annotation> <documentation>konventionieller Aortenklappenersatz</documentation> </annotation> </enumeration> <enumeration value="0300002"> <annotation> <documentation>kathetergestützte Aortenklappenimplantation (TAVI)</documentation> </annotation> </enumeration> </restriction> </simpleType> </pre> | | |

simpleType enum_0302

| | | | |
|------------|------------------------------|---------|---------------|
| namespace | http://xml.ir-d.de/irdsaa | | |
| type | restriction of string | | |
| properties | base xs:string | | |
| facets | Kind | Value | Annotation |
| | enumeration | 0302001 | documentation |

| | |
|------------|--|
| | enumeration 0302002 Stenose documentation Insuffizienz enumeration 0302003 documentation Stenose und Insuffizienz |
| annotation | documentation Kat_AK_GrundEingriff |
| source | <pre> <simpleType name="enum_0302"> <annotation> <documentation>Kat_AK_GrundEingriff</documentation> </annotation> <restriction base="xs:string"> <enumeration value="0302001"> <annotation> <documentation>Stenose</documentation> </annotation> </enumeration> <enumeration value="0302002"> <annotation> <documentation>Insuffizienz</documentation> </annotation> </enumeration> <enumeration value="0302003"> <annotation> <documentation>Stenose und Insuffizienz</documentation> </annotation> </enumeration> </restriction> </simpleType> </pre> |

simpleType enum 0318

| | | | |
|------------|---|---------|-------------------------------------|
| namespace | http://xml.ir-d.de/irdsaa | | |
| type | restriction of string | | |
| properties | base xs:string | | |
| facets | Kind | Value | Annotation |
| | enumeration | 0318001 | documentation transapikal |
| | enumeration | 0318002 | documentation transaortal |
| | enumeration | 0318003 | documentation transfemoral |
| | enumeration | 0318004 | documentation transaxillär |
| | enumeration | 0318042 | documentation anderer Zugangsweg |
| annotation | documentation Kat_AK_ZugangKatheter | | |
| source | <pre> <simpleType name="enum_0318"> <annotation> <documentation>Kat_AK_ZugangKatheter</documentation> </annotation> <restriction base="xs:string"> <enumeration value="0318001"> <annotation> <documentation>transapikal</documentation> </annotation> </pre> | | |

| | |
|--|---|
| | <pre> </enumeration> <enumeration value="0318002"> <annotation> <documentation>transaortal</documentation> </annotation> </enumeration> <enumeration value="0318003"> <annotation> <documentation>transfemoral</documentation> </annotation> </enumeration> <enumeration value="0318004"> <annotation> <documentation>transaxillär</documentation> </annotation> </enumeration> <enumeration value="0318042"> <annotation> <documentation>anderer Zugangsweg</documentation> </annotation> </enumeration> </restriction> </simpleType> </pre> |
|--|---|

simpleType enum_0320

| | | | |
|------------|--|---------|---|
| namespace | http://xml.ir-d.de/irdsaa | | |
| type | restriction of string | | |
| properties | base xs:string | | |
| facets | Kind | Value | Annotation |
| | enumeration | 0320001 | documentation konventionelle Sternotomie |
| | enumeration | 0320002 | documentation partielle Sternotomie |
| | enumeration | 0320003 | documentation parastemaler Zugang |
| | enumeration | 0320042 | documentation anderer Zugangsweg |
| annotation | documentation Kat_AK_ZugangKonventionell | | |
| source | <pre> <simpleType name="enum_0320"> <annotation> <documentation>Kat_AK_ZugangKonventionell</documentation> </annotation> <restriction base="xs:string"> <enumeration value="0320001"> <annotation> <documentation>konventionelle Sternotomie</documentation> </annotation> </enumeration> <enumeration value="0320002"> <annotation> <documentation>partielle Sternotomie</documentation> </annotation> </enumeration> <enumeration value="0320003"> <annotation> </pre> | | |

| | |
|--|---|
| | <pre> <documentation>parasternaler Zugang</documentation> </annotation> </enumeration> <enumeration value="032004"> <annotation> <documentation>anderer Zugangsweg</documentation> </annotation> </enumeration> </restriction> </simpleType> </pre> |
|--|---|

simpleType enum_0322

| | | | |
|------------|--|---------|--|
| namespace | http://xml.ir-d.de/irdsaa | | |
| type | restriction of string | | |
| properties | base xs:string | | |
| facets | Kind | Value | Annotation |
| | enumeration | 0322001 | documentation nein |
| | enumeration | 0322002 | documentation ja, diätetisch behandelt |
| | enumeration | 0322003 | documentation ja, orale Medikation |
| | enumeration | 0322004 | documentation ja, mit Insulin behandelt |
| | enumeration | 0322005 | documentation ja, unbehandelt |
| | enumeration | 0322099 | documentation unbekannt |
| annotation | documentation Kat_AK_Diabetes | | |
| source | <pre> <simpleType name="enum_0322"> <annotation> <documentation>Kat_AK_Diabetes</documentation> </annotation> <restriction base="xs:string"> <enumeration value="0322001"> <annotation> <documentation>nein</documentation> </annotation> </enumeration> <enumeration value="0322002"> <annotation> <documentation>ja, diätetisch behandelt</documentation> </annotation> </enumeration> <enumeration value="0322003"> <annotation> <documentation>ja, orale Medikation</documentation> </annotation> </enumeration> <enumeration value="0322004"> <annotation> <documentation>ja, mit Insulin behandelt</documentation> </annotation> </enumeration> <enumeration value="0322005"> </pre> | | |

| | |
|--|---|
| | <pre> <annotation> <documentation>ja, unbehandelt</documentation> </annotation> </enumeration> <enumeration value="0322099"> <annotation> <documentation>unbekannt</documentation> </annotation> </enumeration> </restriction> </simpleType> </pre> |
|--|---|

simpleType enum_0324

| | | | |
|------------|---|---------|---|
| namespace | http://xml.ir-d.de/irdsaa | | |
| type | restriction of string | | |
| properties | base xs:string | | |
| facets | Kind | Value | Annotation |
| | enumeration | 0324001 | documentation (I): Beschwerdefreiheit, normale körperliche Belastbarkeit |
| | enumeration | 0324002 | documentation (II): Beschwerden bei stärkerer körperlicher Belastung |
| | enumeration | 0324003 | documentation (III): Beschwerden bei leichter körperlicher Belastung |
| | enumeration | 0324004 | documentation (IV): Beschwerden in Ruhe |
| annotation | documentation Kat_AK_NYHA | | |
| source | <pre> <simpleType name="enum_0324"> <annotation> <documentation>Kat_AK_NYHA</documentation> </annotation> <restriction base="xs:string"> <enumeration value="0324001"> <annotation> <documentation>(I): Beschwerdefreiheit, normale körperliche Belastbarkeit</documentation> </annotation> </enumeration> <enumeration value="0324002"> <annotation> <documentation>(II): Beschwerden bei stärkerer körperlicher Belastung</documentation> </annotation> </enumeration> <enumeration value="0324003"> <annotation> <documentation>(III): Beschwerden bei leichter körperlicher Belastung</documentation> </annotation> </enumeration> <enumeration value="0324004"> <annotation> <documentation>(IV): Beschwerden in Ruhe</documentation> </annotation> </enumeration> </restriction> </pre> | | |

</simpleType>

simpleType enum_0330

| | | | |
|------------|---|---------|--|
| namespace | http://xml.ir-d.de/irdsaa | | |
| type | restriction of string | | |
| properties | base xs:string | | |
| facets | Kind | Value | Annotation |
| | enumeration | 0330001 | documentation ATS Medical |
| | enumeration | 0330002 | documentation Edwards Lifesciences |
| | enumeration | 0330003 | documentation Medtronic |
| | enumeration | 0330004 | documentation JenaValve |
| | enumeration | 0330005 | documentation Corcym |
| | enumeration | 0330006 | documentation Abbott Medical / St. Jude |
| | enumeration | 0330007 | documentation Symetis |
| | enumeration | 0330008 | documentation Direct Flow Medical |
| | enumeration | 0330009 | documentation Boston Scientific |
| | enumeration | 0330010 | documentation Artivion |
| | enumeration | 0330011 | documentation Biosensors |
| | enumeration | 0330012 | documentation LivaNova |
| | enumeration | 0330013 | documentation Meril |
| | enumeration | 0330014 | documentation nicht belegter Wert |
| | enumeration | 0330015 | documentation nicht belegter Wert |
| | enumeration | 0330016 | documentation nicht belegter Wert |
| | enumeration | 0330017 | documentation nicht belegter Wert |
| | enumeration | 0330018 | documentation nicht belegter Wert |
| | enumeration | 0330042 | documentation sonstiger Hersteller |
| annotation | documentation Kat_AK_Hersteller | | |
| source | <pre><simpleType name="enum_0330"> <annotation> <documentation>Kat_AK_Hersteller</documentation> </annotation> <restriction base="xs:string"> <enumeration value="0330001"> <annotation> <documentation>ATS Medical</documentation> </annotation> </enumeration> <enumeration value="0330002"> <annotation></pre> | | |

```
<documentation>Edwards Lifesciences</documentation>
</annotation>
</enumeration>
<enumeration value="0330003">
  <annotation>
    <documentation>Medtronic</documentation>
  </annotation>
</enumeration>
<enumeration value="0330004">
  <annotation>
    <documentation>JenaValve</documentation>
  </annotation>
</enumeration>
<enumeration value="0330005">
  <annotation>
    <documentation>Corcym</documentation>
  </annotation>
</enumeration>
<enumeration value="0330006">
  <annotation>
    <documentation>Abbott Medical / St. Jude</documentation>
  </annotation>
</enumeration>
<enumeration value="0330007">
  <annotation>
    <documentation>Symetis</documentation>
  </annotation>
</enumeration>
<enumeration value="0330008">
  <annotation>
    <documentation>Direct Flow Medical</documentation>
  </annotation>
</enumeration>
<enumeration value="0330009">
  <annotation>
    <documentation>Boston Scientific</documentation>
  </annotation>
</enumeration>
<enumeration value="0330010">
  <annotation>
    <documentation>Artivion</documentation>
  </annotation>
</enumeration>
<enumeration value="0330011">
  <annotation>
    <documentation>Biosensors</documentation>
  </annotation>
</enumeration>
<enumeration value="0330012">
  <annotation>
    <documentation>LivaNova</documentation>
  </annotation>
</enumeration>
<enumeration value="0330013">
  <annotation>
    <documentation>Meril</documentation>
  </annotation>
</enumeration>
<enumeration value="0330014">
```

| | |
|--|--|
| | <pre> <annotation> <documentation>nicht belegter Wert</documentation> </annotation> </enumeration> <enumeration value="0330015"> <annotation> <documentation>nicht belegter Wert</documentation> </annotation> </enumeration> <enumeration value="0330016"> <annotation> <documentation>nicht belegter Wert</documentation> </annotation> </enumeration> <enumeration value="0330017"> <annotation> <documentation>nicht belegter Wert</documentation> </annotation> </enumeration> <enumeration value="0330018"> <annotation> <documentation>nicht belegter Wert</documentation> </annotation> </enumeration> <enumeration value="0330042"> <annotation> <documentation>sonstiger Hersteller</documentation> </annotation> </enumeration> </restriction> </simpleType> </pre> |
|--|--|

simpleType enum_0338

| | | | |
|------------|--|---------|-----------------------------|
| namespace | http://xml.ir-d.de/irdsaa | | |
| type | restriction of string | | |
| properties | base xs:string | | |
| facets | Kind | Value | Annotation |
| | enumeration | 0338001 | documentation LAD |
| | enumeration | 0338002 | documentation RCA |
| | enumeration | 0338003 | documentation RCX |
| | enumeration | 0338004 | documentation Hauptstamm |
| annotation | documentation Kat_AK_PCIArterien | | |
| source | <pre> <simpleType name="enum_0338"> <annotation> <documentation>Kat_AK_PCIArterien</documentation> </annotation> <restriction base="xs:string"> <enumeration value="0338001"> <annotation> <documentation>LAD</documentation> </annotation> </pre> | | |

| | |
|--|--|
| | <pre> </enumeration> <enumeration value="0338002"> <annotation> <documentation>RCA</documentation> </annotation> </enumeration> <enumeration value="0338003"> <annotation> <documentation>RCX</documentation> </annotation> </enumeration> <enumeration value="0338004"> <annotation> <documentation>Hauptstamm</documentation> </annotation> </enumeration> </restriction> </simpleType> </pre> |
|--|--|

simpleType enum_0339

| | | | |
|------------|---|---------|-------------------------|
| namespace | http://xml.ir-d.de/irdsaa | | |
| type | restriction of string | | |
| properties | base xs:string | | |
| facets | Kind | Value | Annotation |
| | enumeration | 0339001 | documentation TEE |
| | enumeration | 0339002 | documentation CT |
| | enumeration | 0339042 | documentation andere |
| annotation | documentation Kat AK AnnulusMessmethode | | |
| source | <pre> <simpleType name="enum_0339"> <annotation> <documentation>Kat_AK_AnnulusMessmethode</documentation> </annotation> <restriction base="xs:string"> <enumeration value="0339001"> <annotation> <documentation>TEE</documentation> </annotation> </enumeration> <enumeration value="0339002"> <annotation> <documentation>CT</documentation> </annotation> </enumeration> <enumeration value="0339042"> <annotation> <documentation>andere</documentation> </annotation> </enumeration> </restriction> </simpleType> </pre> | | |

simpleType enum_0341

| | | | |
|------------|--|---------|--|
| namespace | http://xml.ir-d.de/irdsaa | | |
| type | restriction of string | | |
| properties | base xs:string | | |
| facets | Kind | Value | Annotation |
| | enumeration | 0341001 | documentation intraprozedural verstorben |
| | enumeration | 0341002 | documentation Implantation von mehr als einer Prothese |
| | enumeration | 0341003 | documentation gravierende Gefäß- oder Zugangskomplikation (gemäß VARC-3) |
| | enumeration | 0341004 | documentation erforderlicher chirurgischer oder interventioneller Eingriff wegen einer Klappenfehlfunktion (gemäß VARC-3) |
| | enumeration | 0341005 | documentation >= große strukturelle kardiale Komplikation (gemäß VARC-3) |
| annotation | documentation Kat_AK_FailureGrund | | |
| source | <pre> <simpleType name="enum_0341"> <annotation> <documentation>Kat_AK_FailureGrund</documentation> </annotation> <restriction base="xs:string"> <enumeration value="0341001"> <annotation> <documentation>intraprozedural verstorben</documentation> </annotation> </enumeration> <enumeration value="0341002"> <annotation> <documentation>Implantation von mehr als einer Prothese</documentation> </annotation> </enumeration> <enumeration value="0341003"> <annotation> <documentation>gravierende Gefäß- oder Zugangskomplikation (gemäß VARC-3)</documentation> </annotation> </enumeration> <enumeration value="0341004"> <annotation> <documentation>erforderlicher chirurgischer oder interventioneller Eingriff wegen einer Klappenfehlfunktion (gemäß VARC-3)</documentation> </annotation> </enumeration> <enumeration value="0341005"> <annotation> <documentation>&gt;= große strukturelle kardiale Komplikation (gemäß VARC-3)</documentation> </annotation> </enumeration> </restriction> </simpleType> </pre> | | |

simpleType enum_0342

| | | | |
|------------|--|---------|--|
| namespace | http://xml.ir-d.de/irdsaa | | |
| type | restriction of string | | |
| properties | base xs:string | | |
| facets | Kind | Value | Annotation |
| | enumeration | 0342001 | documentation Alter |
| | enumeration | 0342002 | documentation Frailty |
| | enumeration | 0342003 | documentation Hochrisiko |
| | enumeration | 0342004 | documentation Prognose-limitierende Zweiterkrankung |
| | enumeration | 0342005 | documentation Porzellan-Aorta |
| | enumeration | 0342042 | documentation Sonstige |
| annotation | documentation Kat_AK_Tavi | | |
| source | <pre> <simpleType name="enum_0342"> <annotation> <documentation>Kat_AK_Tavi</documentation> </annotation> <restriction base="xs:string"> <enumeration value="0342001"> <annotation> <documentation>Alter</documentation> </annotation> </enumeration> <enumeration value="0342002"> <annotation> <documentation>Frailty</documentation> </annotation> </enumeration> <enumeration value="0342003"> <annotation> <documentation>Hochrisiko</documentation> </annotation> </enumeration> <enumeration value="0342004"> <annotation> <documentation>Prognose-limitierende Zweiterkrankung</documentation> </annotation> </enumeration> <enumeration value="0342005"> <annotation> <documentation>Porzellan-Aorta</documentation> </annotation> </enumeration> <enumeration value="0342042"> <annotation> <documentation>Sonstige</documentation> </annotation> </enumeration> </restriction> </simpleType> </pre> | | |

simpleType enum_0343

| | | | |
|------------|--|---------|--|
| namespace | http://xml.ir-d.de/irdsaa | | |
| type | restriction of string | | |
| properties | base xs:string | | |
| facets | Kind | Value | Annotation |
| | enumeration | 0343001 | documentation Device-Fehlpositionierung |
| | enumeration | 0343002 | documentation Koronarostienverschluss |
| | enumeration | 0343003 | documentation Aortendissektion |
| | enumeration | 0343004 | documentation Aortenregurgitation > = 2. Grades |
| | enumeration | 0343005 | documentation Annulus-Ruptur |
| | enumeration | 0343006 | documentation Ruptur-/Perforation einer Herzhöhle ohne Therapiebedarf |
| | enumeration | 0343007 | documentation Ruptur-/Perforation einer Herzhöhle mit Therapiebedarf |
| | enumeration | 0343008 | documentation Perikardtamponade |
| | enumeration | 0343009 | documentation kardiale Dekompensation |
| | enumeration | 0343010 | documentation Himembolie |
| | enumeration | 0343011 | documentation Rhythmusstörungen |
| | enumeration | 0343012 | documentation Device-Embolisation |
| | enumeration | 0343013 | documentation vaskuläre Komplikation |
| | enumeration | 0343014 | documentation Low Cardiac Output |
| | enumeration | 0343015 | documentation schwerwiegende Blutungen (intraprozedural) |
| | enumeration | 0343016 | documentation lebensbedrohliche Blutungen (intraprozedural) |
| | enumeration | 0343017 | documentation Patient verstarb im OP/Katheterlabor |
| | enumeration | 0343042 | documentation sonstige intraprozedurale Komplikationen |
| annotation | documentation Kat_AK_KomplikationTyp | | |
| source | <pre> <simpleType name="enum_0343"> <annotation> <documentation>Kat_AK_KomplikationTyp</documentation> </annotation> <restriction base="xs:string"> <enumeration value="0343001"> <annotation> <documentation>Device-Fehlpositionierung</documentation> </annotation> </enumeration> <enumeration value="0343002"> <annotation> <documentation>Koronarostienverschluss</documentation> </annotation> </enumeration> <enumeration value="0343003"> </pre> | | |

```

    <annotation>
      <documentation>Aortendissektion</documentation>
    </annotation>
  </enumeration>
  <enumeration value="0343004">
    <annotation>
      <documentation>Aortenregurgitation &gt; = 2. Grades</documentation>
    </annotation>
  </enumeration>
  <enumeration value="0343005">
    <annotation>
      <documentation>Annulus-Ruptur</documentation>
    </annotation>
  </enumeration>
  <enumeration value="0343006">
    <annotation>
      <documentation>Ruptur-/Perforation einer Herzhöhle ohne
Therapiebedarf</documentation>
    </annotation>
  </enumeration>
  <enumeration value="0343007">
    <annotation>
      <documentation>Ruptur-/Perforation einer Herzhöhle mit
Therapiebedarf</documentation>
    </annotation>
  </enumeration>
  <enumeration value="0343008">
    <annotation>
      <documentation>Perikardtamponade</documentation>
    </annotation>
  </enumeration>
  <enumeration value="0343009">
    <annotation>
      <documentation>kardiale Dekompensation</documentation>
    </annotation>
  </enumeration>
  <enumeration value="0343010">
    <annotation>
      <documentation>Hirnembolie</documentation>
    </annotation>
  </enumeration>
  <enumeration value="0343011">
    <annotation>
      <documentation>Rhythmusstörungen</documentation>
    </annotation>
  </enumeration>
  <enumeration value="0343012">
    <annotation>
      <documentation>Device-Embolisation</documentation>
    </annotation>
  </enumeration>
  <enumeration value="0343013">
    <annotation>
      <documentation>vaskuläre Komplikation</documentation>
    </annotation>
  </enumeration>
  <enumeration value="0343014">
    <annotation>
      <documentation>Low Cardiac Output</documentation>
    </annotation>
  </enumeration>

```

| | |
|--|---|
| | <pre> </annotation> </enumeration> <enumeration value="0343015"> <annotation> <documentation>schwerwiegende Blutungen (intraprozedural)</documentation> </annotation> </enumeration> <enumeration value="0343016"> <annotation> <documentation>lebensbedrohliche Blutungen (intraprozedural)</documentation> </annotation> </enumeration> <enumeration value="0343017"> <annotation> <documentation>Patient verstarb im OP/Katheterlabor</documentation> </annotation> </enumeration> <enumeration value="0343042"> <annotation> <documentation>sonstige intraprozedurale Komplikationen</documentation> </annotation> </enumeration> </restriction> </simpleType> </pre> |
|--|---|

simpleType enum_0346

| | | | |
|------------|--|---------|--|
| namespace | http://xml.ir-d.de/irdsaa | | |
| type | restriction of string | | |
| properties | base xs:string | | |
| facets | Kind | Value | Annotation |
| | enumeration | 0346001 | documentation keine Therapie erforderlich |
| | enumeration | 0346002 | documentation medikamentös |
| | enumeration | 0346003 | documentation IABP |
| | enumeration | 0346004 | documentation VAD |
| | enumeration | 0346005 | documentation ECMO |
| | enumeration | 0346042 | documentation sonstige |
| annotation | documentation Kat_AK_TherapieLCO | | |
| source | <pre> <simpleType name="enum_0346"> <annotation> <documentation>Kat_AK_TherapieLCO</documentation> </annotation> <restriction base="xs:string"> <enumeration value="0346001"> <annotation> <documentation>keine Therapie erforderlich</documentation> </annotation> </pre> | | |

| | |
|--|---|
| | <pre> </enumeration> <enumeration value="0346002"> <annotation> <documentation>medikamentös</documentation> </annotation> </enumeration> <enumeration value="0346003"> <annotation> <documentation>IABP</documentation> </annotation> </enumeration> <enumeration value="0346004"> <annotation> <documentation>VAD</documentation> </annotation> </enumeration> <enumeration value="0346005"> <annotation> <documentation>ECMO</documentation> </annotation> </enumeration> <enumeration value="0346042"> <annotation> <documentation>sonstige</documentation> </annotation> </enumeration> </restriction> </simpleType> </pre> |
|--|---|

simpleType enum_0347

| | | | |
|------------|---|---------|---|
| namespace | http://xml.ir-d.de/irdsaa | | |
| type | restriction of string | | |
| properties | base xs:string | | |
| facets | Kind | Value | Annotation |
| | enumeration | 0347001 | documentation Einzeleingriff |
| | enumeration | 0347002 | documentation Kombinationseingriff mit mehreren Prozeduren |
| annotation | documentation Kat_AK_Eingriffsumfang | | |
| source | <pre> <simpleType name="enum_0347"> <annotation> <documentation>Kat_AK_Eingriffsumfang</documentation> </annotation> <restriction base="xs:string"> <enumeration value="0347001"> <annotation> <documentation>Einzeleingriff</documentation> </annotation> </enumeration> <enumeration value="0347002"> <annotation> <documentation>Kombinationseingriff mit mehreren Prozeduren</documentation> </annotation> </enumeration> </restriction> </pre> | | |

| | |
|--|---|
| | <pre> </restriction> </simpleType> </pre> |
|--|---|

simpleType enum_0348

| | | | |
|------------|---|---------|---|
| namespace | http://xml.ir-d.de/irdsaa | | |
| type | restriction of string | | |
| properties | base xs:string | | |
| facets | Kind | Value | Annotation |
| | enumeration | 0348001 | documentation mit HLM |
| | enumeration | 0348002 | documentation ohne HLM |
| | enumeration | 0348003 | documentation Umstieg von OP ohne HLM auf OP mit HLM |
| annotation | documentation Kat_AK_OPVorgehen | | |
| source | <pre> <simpleType name="enum_0348"> <annotation> <documentation>Kat_AK_OPVorgehen</documentation> </annotation> <restriction base="xs:string"> <enumeration value="0348001"> <annotation> <documentation>mit HLM</documentation> </annotation> </enumeration> <enumeration value="0348002"> <annotation> <documentation>ohne HLM</documentation> </annotation> </enumeration> <enumeration value="0348003"> <annotation> <documentation>Umstieg von OP ohne HLM auf OP mit HLM</documentation> </annotation> </enumeration> </restriction> </simpleType> </pre> | | |

simpleType enum_0350

| | | | |
|------------|------------------------------|---------|--------------------------|
| namespace | http://xml.ir-d.de/irdsaa | | |
| type | restriction of string | | |
| properties | base xs:string | | |
| facets | Kind | Value | Annotation |
| | enumeration | 0350001 | documentation IABP |
| | enumeration | 0350002 | documentation Impella |
| | enumeration | 0350003 | documentation vv ECMO |
| | enumeration | 0350004 | documentation va ECMO |
| | enumeration | 0350042 | documentation |

| | |
|------------|--|
| | andere |
| annotation | documentation Kat AK Methode |
| source | <pre> <simpleType name="enum_0350"> <annotation> <documentation>Kat_AK_Methode</documentation> </annotation> <restriction base="xs:string"> <enumeration value="0350001"> <annotation> <documentation>IABP</documentation> </annotation> </enumeration> <enumeration value="0350002"> <annotation> <documentation>Impella</documentation> </annotation> </enumeration> <enumeration value="0350003"> <annotation> <documentation>vv ECMO</documentation> </annotation> </enumeration> <enumeration value="0350004"> <annotation> <documentation>va ECMO</documentation> </annotation> </enumeration> <enumeration value="0350042"> <annotation> <documentation>andere</documentation> </annotation> </enumeration> </restriction> </simpleType> </pre> |

simpleType enum_0351

| | | | |
|------------|------------------------------|---------|---|
| namespace | http://xml.ir-d.de/irdsaa | | |
| type | restriction of string | | |
| properties | base xs:string | | |
| facets | Kind | Value | Annotation |
| | enumeration | 0351001 | documentation nein |
| | enumeration | 0351002 | documentation ja, zu Stenotomie |
| | enumeration | 0351003 | documentation ja, zu transapikal |
| | enumeration | 0351004 | documentation ja, zu transaortal |
| | enumeration | 0351005 | documentation ja, zu transfemoral |
| | enumeration | 0351006 | documentation ja, zu transaxillär |
| | enumeration | 0351007 | documentation ja, zu anderem endovaskulären Zugang |
| | enumeration | 0351042 | documentation ja, zu anderem Zugang |

| | |
|------------|---|
| annotation | documentation Kat_AK_Konversion |
| source | <pre> <simpleType name="enum_0351"> <annotation> <documentation>Kat_AK_Konversion</documentation> </annotation> <restriction base="xs:string"> <enumeration value="0351001"> <annotation> <documentation>nein</documentation> </annotation> </enumeration> <enumeration value="0351002"> <annotation> <documentation>ja, zu Sternotomie</documentation> </annotation> </enumeration> <enumeration value="0351003"> <annotation> <documentation>ja, zu transapikal</documentation> </annotation> </enumeration> <enumeration value="0351004"> <annotation> <documentation>ja, zu transaortal</documentation> </annotation> </enumeration> <enumeration value="0351005"> <annotation> <documentation>ja, zu transfemoral</documentation> </annotation> </enumeration> <enumeration value="0351006"> <annotation> <documentation>ja, zu transaxillär</documentation> </annotation> </enumeration> <enumeration value="0351007"> <annotation> <documentation>ja, zu anderem endovaskulären Zugang</documentation> </annotation> </enumeration> <enumeration value="0351042"> <annotation> <documentation>ja, zu anderem Zugang</documentation> </annotation> </enumeration> </restriction> </simpleType> </pre> |

simpleType enum_0352

| | | | |
|------------|------------------------------|-----------|------------|
| namespace | http://xml.ir-d.de/irdsaa | | |
| type | restriction of string | | |
| properties | base | xs:string | |
| facets | Kind | Value | Annotation |

| | |
|------------|---|
| | enumeration 0352001 documentation nein enumeration 0352002 documentation ja, Intubationsnarkose enumeration 0352003 documentation ja, Maskenbeatmung, incl. LAMA enumeration 0352042 documentation ja, unbekannt welche |
| annotation | documentation Kat_AK_Anaesthesie |
| source | <pre> <simpleType name="enum_0352"> <annotation> <documentation>Kat_AK_Anaesthesie</documentation> </annotation> <restriction base="xs:string"> <enumeration value="0352001"> <annotation> <documentation>nein</documentation> </annotation> </enumeration> <enumeration value="0352002"> <annotation> <documentation>ja, Intubationsnarkose</documentation> </annotation> </enumeration> <enumeration value="0352003"> <annotation> <documentation>ja, Maskenbeatmung, incl. LAMA</documentation> </annotation> </enumeration> <enumeration value="0352042"> <annotation> <documentation>ja, unbekannt welche</documentation> </annotation> </enumeration> </restriction> </simpleType> </pre> |

simpleType enum_0353

| | | | |
|------------|---|---------|-----------------------------------|
| namespace | http://xml.ir-d.de/irdsaa | | |
| type | restriction of string | | |
| properties | base xs:string | | |
| facets | Kind | Value | Annotation |
| | enumeration | 0353001 | documentation keine |
| | enumeration | 0353002 | documentation leichtgradig |
| | enumeration | 0353003 | documentation mittelgradig |
| | enumeration | 0353004 | documentation hochgradig |
| | enumeration | 0353099 | documentation nicht bestimmbar |
| annotation | documentation Kat_AK_ResidualeAorteninsuffizienz | | |
| source | <pre> <simpleType name="enum_0353"> <annotation> </pre> | | |

| | |
|--|---|
| | <pre> <documentation>Kat_AK_ResidualeAorteninsuffizienz</documentation> </annotation> <restriction base="xs:string"> <enumeration value="0353001"> <annotation> <documentation>keine</documentation> </annotation> </enumeration> <enumeration value="0353002"> <annotation> <documentation>leichtgradig</documentation> </annotation> </enumeration> <enumeration value="0353003"> <annotation> <documentation>mittelgradig</documentation> </annotation> </enumeration> <enumeration value="0353004"> <annotation> <documentation>hochgradig</documentation> </annotation> </enumeration> <enumeration value="0353099"> <annotation> <documentation>nicht bestimmbar</documentation> </annotation> </enumeration> </restriction> </simpleType> </pre> |
|--|---|

simpleType enum_0354

| | | | |
|------------|---|---------|------------------------------------|
| namespace | http://xml.ir-d.de/irdsaa | | |
| type | restriction of string | | |
| properties | base xs:string | | |
| facets | Kind | Value | Annotation |
| | enumeration | 0354001 | documentation chirurgisch-offen |
| | enumeration | 0354002 | documentation Verschluss-System |
| | enumeration | 0354042 | documentation sonstige |
| annotation | documentation Kat_AK_Zugangswegverschluss | | |
| source | <pre> <simpleType name="enum_0354"> <annotation> <documentation>Kat_AK_Zugangswegverschluss</documentation> </annotation> <restriction base="xs:string"> <enumeration value="0354001"> <annotation> <documentation>chirurgisch-offen</documentation> </annotation> </enumeration> <enumeration value="0354002"> <annotation> </pre> | | |

| | |
|--|---|
| | <pre> <documentation>Verschluss-System</documentation> </annotation> </enumeration> <enumeration value="0354042"> <annotation> <documentation>sonstige</documentation> </annotation> </enumeration> </restriction> </simpleType> </pre> |
|--|---|

simpleType enum_0357

| | | | |
|------------|---|---------|--|
| namespace | http://xml.ir-d.de/irdsaa | | |
| type | restriction of string | | |
| properties | base xs:string | | |
| facets | Kind | Value | Annotation |
| | enumeration | 0357001 | documentation keine KHK |
| | enumeration | 0357002 | documentation 1-Gefäßerkrankung |
| | enumeration | 0357003 | documentation 2-Gefäßerkrankung |
| | enumeration | 0357004 | documentation 3-Gefäßerkrankung |
| | enumeration | 0357005 | documentation keine koronare Bildgebung |
| annotation | documentation Kat_AK_BefundBildgebung | | |
| source | <pre> <simpleType name="enum_0357"> <annotation> <documentation>Kat_AK_BefundBildgebung</documentation> </annotation> <restriction base="xs:string"> <enumeration value="0357001"> <annotation> <documentation>keine KHK</documentation> </annotation> </enumeration> <enumeration value="0357002"> <annotation> <documentation>1-Gefäßerkrankung</documentation> </annotation> </enumeration> <enumeration value="0357003"> <annotation> <documentation>2-Gefäßerkrankung</documentation> </annotation> </enumeration> <enumeration value="0357004"> <annotation> <documentation>3-Gefäßerkrankung</documentation> </annotation> </enumeration> <enumeration value="0357005"> <annotation> <documentation>keine koronare Bildgebung</documentation> </annotation> </enumeration> </restriction> </simpleType> </pre> | | |

```

</annotation>
</enumeration>
</restriction>
</simpleType>

```

simpleType enum_0358

| | | | |
|------------|--|---------|---|
| namespace | http://xml.ir-d.de/irdsaa | | |
| type | restriction of string | | |
| properties | base xs:string | | |
| facets | Kind | Value | Annotation |
| | enumeration | 0358001 | documentation 0 |
| | enumeration | 0358002 | documentation 1 |
| | enumeration | 0358003 | documentation 2 |
| | enumeration | 0358004 | documentation 3 |
| | enumeration | 0358005 | documentation 4 |
| | enumeration | 0358006 | documentation 5 oder mehr |
| | enumeration | 0358098 | documentation genaue Anzahl unbekannt (aber mind. 1) |
| | enumeration | 0358099 | documentation unbekannt |
| annotation | documentation Kat_AK_AnzahlVorOP | | |
| source | <pre> <simpleType name="enum_0358"> <annotation> <documentation>Kat_AK_AnzahlVorOP</documentation> </annotation> <restriction base="xs:string"> <enumeration value="0358001"> <annotation> <documentation>0</documentation> </annotation> </enumeration> <enumeration value="0358002"> <annotation> <documentation>1</documentation> </annotation> </enumeration> <enumeration value="0358003"> <annotation> <documentation>2</documentation> </annotation> </enumeration> <enumeration value="0358004"> <annotation> <documentation>3</documentation> </annotation> </enumeration> <enumeration value="0358005"> <annotation> <documentation>4</documentation> </annotation> </pre> | | |

| | |
|--|--|
| | <pre> </enumeration> <enumeration value="0358006"> <annotation> <documentation>5 oder mehr</documentation> </annotation> </enumeration> <enumeration value="0358098"> <annotation> <documentation>genaue Anzahl unbekannt (aber mind. 1)</documentation> </annotation> </enumeration> <enumeration value="0358099"> <annotation> <documentation>unbekannt</documentation> </annotation> </enumeration> </restriction> </simpleType> </pre> |
|--|--|

simpleType **enum_0359**

| | | | |
|------------|---|---------|----------------------------------|
| namespace | http://xml.ir-d.de/irdsaa | | |
| type | restriction of string | | |
| properties | base xs:string | | |
| facets | Kind | Value | Annotation |
| | enumeration | 0359001 | documentation nein |
| | enumeration | 0359002 | documentation ja - einseitig |
| | enumeration | 0359003 | documentation ja - beidseitig |
| | enumeration | 0359042 | documentation unbekannt |
| annotation | documentation Kat_AK_LVOT | | |
| source | <pre> <simpleType name="enum_0359"> <annotation> <documentation>Kat_AK_LVOT</documentation> </annotation> <restriction base="xs:string"> <enumeration value="0359001"> <annotation> <documentation>nein</documentation> </annotation> </enumeration> <enumeration value="0359002"> <annotation> <documentation>ja - einseitig</documentation> </annotation> </enumeration> <enumeration value="0359003"> <annotation> <documentation>ja - beidseitig</documentation> </annotation> </enumeration> <enumeration value="0359042"> <annotation> </pre> | | |

```

    <documentation>unbekannt</documentation>
  </annotation>
</enumeration>
</restriction>
</simpleType>

```

simpleType enum_0360

| | | | |
|------------|---|---------|-------------------------------|
| namespace | http://xml.ir-d.de/irdsaa | | |
| type | restriction of string | | |
| properties | base xs:string | | |
| facets | Kind | Value | Annotation |
| | enumeration | 0360001 | documentation keine |
| | enumeration | 0360002 | documentation leichtgradig |
| | enumeration | 0360003 | documentation mittelgradig |
| | enumeration | 0360004 | documentation hochgradig |
| | enumeration | 0360005 | documentation massive |
| | enumeration | 0360006 | documentation torrential |
| | enumeration | 0360099 | documentation unbekannt |
| annotation | documentation Kat_AK_TriskupidalInsuffizienz | | |
| source | <pre> <simpleType name="enum_0360"> <annotation> <documentation>Kat_AK_TriskupidalInsuffizienz</documentation> </annotation> <restriction base="xs:string"> <enumeration value="0360001"> <annotation> <documentation>keine</documentation> </annotation> </enumeration> <enumeration value="0360002"> <annotation> <documentation>leichtgradig</documentation> </annotation> </enumeration> <enumeration value="0360003"> <annotation> <documentation>mittelgradig</documentation> </annotation> </enumeration> <enumeration value="0360004"> <annotation> <documentation>hochgradig</documentation> </annotation> </enumeration> <enumeration value="0360005"> <annotation> <documentation>massive</documentation> </annotation> </enumeration> </restriction> </simpleType> </pre> | | |

| | |
|--|---|
| | <pre> </enumeration> <enumeration value="0360006"> <annotation> <documentation>torrential</documentation> </annotation> </enumeration> <enumeration value="0360099"> <annotation> <documentation>unbekannt</documentation> </annotation> </enumeration> </restriction> </simpleType> </pre> |
|--|---|

simpleType enum_0361

| namespace | http://xml.ir-d.de/irdsaa | | | | | | | | | | | | | | | | | | | | | |
|-------------|---|---|-------|------------|-------------|---------|-----------------------|-------------|---------|---|-------------|---------|--|-------------|---------|---|-------------|---------|--|-------------|---------|----------------------------|
| type | restriction of string | | | | | | | | | | | | | | | | | | | | | |
| properties | base xs:string | | | | | | | | | | | | | | | | | | | | | |
| facets | <table border="1"> <thead> <tr> <th>Kind</th> <th>Value</th> <th>Annotation</th> </tr> </thead> <tbody> <tr> <td>enumeration</td> <td>0361001</td> <td>documentation nein</td> </tr> <tr> <td>enumeration</td> <td>0361002</td> <td>documentation ja, letzte(r) innerhalb der letzten 48 Stunden</td> </tr> <tr> <td>enumeration</td> <td>0361003</td> <td>documentation ja, letzte(r) innerhalb der letzten 21 Tage</td> </tr> <tr> <td>enumeration</td> <td>0361004</td> <td>documentation ja, letzte(r) länger als 21 Tage</td> </tr> <tr> <td>enumeration</td> <td>0361098</td> <td>documentation ja, letzter Zeitpunkt unbekannt</td> </tr> <tr> <td>enumeration</td> <td>0361099</td> <td>documentation unbekannt</td> </tr> </tbody> </table> | Kind | Value | Annotation | enumeration | 0361001 | documentation nein | enumeration | 0361002 | documentation ja, letzte(r) innerhalb der letzten 48 Stunden | enumeration | 0361003 | documentation ja, letzte(r) innerhalb der letzten 21 Tage | enumeration | 0361004 | documentation ja, letzte(r) länger als 21 Tage | enumeration | 0361098 | documentation ja, letzter Zeitpunkt unbekannt | enumeration | 0361099 | documentation unbekannt |
| Kind | Value | Annotation | | | | | | | | | | | | | | | | | | | | |
| enumeration | 0361001 | documentation nein | | | | | | | | | | | | | | | | | | | | |
| enumeration | 0361002 | documentation ja, letzte(r) innerhalb der letzten 48 Stunden | | | | | | | | | | | | | | | | | | | | |
| enumeration | 0361003 | documentation ja, letzte(r) innerhalb der letzten 21 Tage | | | | | | | | | | | | | | | | | | | | |
| enumeration | 0361004 | documentation ja, letzte(r) länger als 21 Tage | | | | | | | | | | | | | | | | | | | | |
| enumeration | 0361098 | documentation ja, letzter Zeitpunkt unbekannt | | | | | | | | | | | | | | | | | | | | |
| enumeration | 0361099 | documentation unbekannt | | | | | | | | | | | | | | | | | | | | |
| annotation | documentation Kat_AK_SchockReanimation | | | | | | | | | | | | | | | | | | | | | |
| source | <pre> <simpleType name="enum_0361"> <annotation> <documentation>Kat_AK_SchockReanimation</documentation> </annotation> <restriction base="xs:string"> <enumeration value="0361001"> <annotation> <documentation>nein</documentation> </annotation> </enumeration> <enumeration value="0361002"> <annotation> <documentation>ja, letzte(r) innerhalb der letzten 48 Stunden</documentation> </annotation> </enumeration> <enumeration value="0361003"> <annotation> <documentation>ja, letzte(r) innerhalb der letzten 21 Tage</documentation> </annotation> </enumeration> <enumeration value="0361004"> </pre> | | | | | | | | | | | | | | | | | | | | | |

| | |
|--|---|
| | <pre> <annotation> <documentation>ja, letzte(r) länger als 21 Tage</documentation> </annotation> </enumeration> <enumeration value="0361098"> <annotation> <documentation>ja, letzter Zeitpunkt unbekannt</documentation> </annotation> </enumeration> <enumeration value="0361099"> <annotation> <documentation>unbekannt</documentation> </annotation> </enumeration> </restriction> </simpleType> </pre> |
|--|---|

simpleType enum 0362

| | | | |
|------------|---|---------|---------------------------------------|
| namespace | http://xml.ir-d.de/irdsaa | | |
| type | restriction of string | | |
| properties | base xs:string | | |
| facets | Kind | Value | Annotation |
| | enumeration | 0362001 | documentation Sinusrhythmus |
| | enumeration | 0362002 | documentation Vorhofflimmern |
| | enumeration | 0362042 | documentation anderer Herzrhythmus |
| annotation | documentation Kat_AK_Herzrhythmus | | |
| source | <pre> <simpleType name="enum_0362"> <annotation> <documentation>Kat_AK_Herzrhythmus</documentation> </annotation> <restriction base="xs:string"> <enumeration value="0362001"> <annotation> <documentation>Sinusrhythmus</documentation> </annotation> </enumeration> <enumeration value="0362002"> <annotation> <documentation>Vorhofflimmern</documentation> </annotation> </enumeration> <enumeration value="0362042"> <annotation> <documentation>anderer Herzrhythmus</documentation> </annotation> </enumeration> </restriction> </simpleType> </pre> | | |

simpleType enum_0363

| | | | |
|------------|--|---------|--------------------------------|
| namespace | http://xml.ir-d.de/irdsaa | | |
| type | restriction of string | | |
| properties | base xs:string | | |
| facets | Kind | Value | Annotation |
| | enumeration | 0363001 | documentation nein |
| | enumeration | 0363002 | documentation paroxysmal |
| | enumeration | 0363003 | documentation persistierend |
| | enumeration | 0363004 | documentation permanent |
| annotation | documentation Kat_AK_Vorhofflimmern | | |
| source | <pre> <simpleType name="enum_0363"> <annotation> <documentation>Kat_AK_Vorhofflimmern</documentation> </annotation> <restriction base="xs:string"> <enumeration value="0363001"> <annotation> <documentation>nein</documentation> </annotation> </enumeration> <enumeration value="0363002"> <annotation> <documentation>paroxysmal</documentation> </annotation> </enumeration> <enumeration value="0363003"> <annotation> <documentation>persistierend</documentation> </annotation> </enumeration> <enumeration value="0363004"> <annotation> <documentation>permanent</documentation> </annotation> </enumeration> </restriction> </simpleType> </pre> | | |

simpleType enum_0364

| | | | |
|------------|------------------------------|---------|--|
| namespace | http://xml.ir-d.de/irdsaa | | |
| type | restriction of string | | |
| properties | base xs:string | | |
| facets | Kind | Value | Annotation |
| | enumeration | 0364001 | documentation nein |
| | enumeration | 0364002 | documentation Schrittmacher ohne CRT-System |
| | enumeration | 0364003 | documentation Schrittmacher mit CRT-System |
| | enumeration | 0364004 | documentation |

| | |
|------------|---|
| | enumeration 0364005 Defibrillator ohne CRT-System documentation Defibrillator mit CRT-System |
| annotation | documentation Kat_AK_SchrittmacherDefi |
| source | <pre> <simpleType name="enum_0364"> <annotation> <documentation>Kat_AK_SchrittmacherDefi</documentation> </annotation> <restriction base="xs:string"> <enumeration value="0364001"> <annotation> <documentation>nein</documentation> </annotation> </enumeration> <enumeration value="0364002"> <annotation> <documentation>Schrittmacher ohne CRT-System</documentation> </annotation> </enumeration> <enumeration value="0364003"> <annotation> <documentation>Schrittmacher mit CRT-System</documentation> </annotation> </enumeration> <enumeration value="0364004"> <annotation> <documentation>Defibrillator ohne CRT-System</documentation> </annotation> </enumeration> <enumeration value="0364005"> <annotation> <documentation>Defibrillator mit CRT-System</documentation> </annotation> </enumeration> </restriction> </simpleType> </pre> |

simpleType enum_0365

| | | | |
|------------|---|---------|--------------------------------------|
| namespace | http://xml.ir-d.de/irdsaa | | |
| type | restriction of string | | |
| properties | base xs:string | | |
| facets | Kind | Value | Annotation |
| | enumeration | 0365001 | documentation nein |
| | enumeration | 0365002 | documentation ja, operativ |
| | enumeration | 0365003 | documentation ja, interventionell |
| annotation | documentation Kat_AK_MyokardRevaskularisation | | |
| source | <pre> <simpleType name="enum_0365"> <annotation> <documentation>Kat_AK_MyokardRevaskularisation</documentation> </annotation> <restriction base="xs:string"> </pre> | | |

| | |
|--|--|
| | <pre> <enumeration value="0365001"> <annotation> <documentation>nein</documentation> </annotation> </enumeration> <enumeration value="0365002"> <annotation> <documentation>ja, operativ</documentation> </annotation> </enumeration> <enumeration value="0365003"> <annotation> <documentation>ja, interventionell</documentation> </annotation> </enumeration> </restriction> </simpleType> </pre> |
|--|--|

simpleType enum_0366

| | | | |
|------------|--|---------|--|
| namespace | http://xml.ir-d.de/irdsaa | | |
| type | restriction of string | | |
| properties | base xs:string | | |
| facets | Kind | Value | Annotation |
| | enumeration | 0366001 | documentation nein |
| | enumeration | 0366002 | documentation ja, <= 6 Stunden |
| | enumeration | 0366003 | documentation ja, > 6 Stunden bis <= 3 Monate |
| | enumeration | 0366004 | documentation ja, > 3 Monate |
| | enumeration | 0366099 | documentation unbekannt |
| annotation | documentation Kat_AK_PCI | | |
| source | <pre> <simpleType name="enum_0366"> <annotation> <documentation>Kat_AK_PCI</documentation> </annotation> <restriction base="xs:string"> <enumeration value="0366001"> <annotation> <documentation>nein</documentation> </annotation> </enumeration> <enumeration value="0366002"> <annotation> <documentation>ja, &lt;= 6 Stunden</documentation> </annotation> </enumeration> <enumeration value="0366003"> <annotation> <documentation>ja, &gt; 6 Stunden bis &lt;= 3 Monate</documentation> </annotation> </enumeration> <enumeration value="0366004"> </pre> | | |

| | |
|--|---|
| | <pre> <annotation> <documentation>ja, &gt; 3 Monate</documentation> </annotation> </enumeration> <enumeration value="0366099"> <annotation> <documentation>unbekannt</documentation> </annotation> </enumeration> </restriction> </simpleType> </pre> |
|--|---|

simpleType enum_0367

| | | | |
|------------|---|---------|--|
| namespace | http://xml.ir-d.de/irdsaa | | |
| type | restriction of string | | |
| properties | base xs:string | | |
| facets | Kind | Value | Annotation |
| | enumeration | 0367001 | documentation keine |
| | enumeration | 0367002 | documentation Mediastinitis |
| | enumeration | 0367003 | documentation Sepsis |
| | enumeration | 0367004 | documentation broncho-pulmonale Infektion |
| | enumeration | 0367005 | documentation oto-laryngologische Infektion |
| | enumeration | 0367006 | documentation floride Endokarditis |
| | enumeration | 0367007 | documentation Peritonitis |
| | enumeration | 0367008 | documentation Wundinfektion Thorax |
| | enumeration | 0367009 | documentation Pleuraempyem |
| | enumeration | 0367010 | documentation Venenkatheterinfektion |
| | enumeration | 0367011 | documentation Harnwegsinfektion |
| | enumeration | 0367012 | documentation Wundinfektion untere Extremitäten |
| | enumeration | 0367013 | documentation HIV-Infektion |
| | enumeration | 0367014 | documentation Hepatitis B oder C |
| | enumeration | 0367015 | documentation andere Wundinfektion |
| | enumeration | 0367042 | documentation sonstige Infektion |
| annotation | documentation Kat_AK_Infektion | | |
| source | <pre> <simpleType name="enum_0367"> <annotation> <documentation>Kat_AK_Infektion</documentation> </annotation> <restriction base="xs:string"> <enumeration value="0367001"> <annotation> </pre> | | |

```
<documentation>keine</documentation>
</annotation>
</enumeration>
<enumeration value="0367002">
  <annotation>
    <documentation>Mediastinitis</documentation>
  </annotation>
</enumeration>
<enumeration value="0367003">
  <annotation>
    <documentation>Sepsis</documentation>
  </annotation>
</enumeration>
<enumeration value="0367004">
  <annotation>
    <documentation>broncho-pulmonale Infektion</documentation>
  </annotation>
</enumeration>
<enumeration value="0367005">
  <annotation>
    <documentation>oto-laryngologische Infektion</documentation>
  </annotation>
</enumeration>
<enumeration value="0367006">
  <annotation>
    <documentation>floride Endokarditis</documentation>
  </annotation>
</enumeration>
<enumeration value="0367007">
  <annotation>
    <documentation>Peritonitis</documentation>
  </annotation>
</enumeration>
<enumeration value="0367008">
  <annotation>
    <documentation>Wundinfektion Thorax</documentation>
  </annotation>
</enumeration>
<enumeration value="0367009">
  <annotation>
    <documentation>Pleuraempyem</documentation>
  </annotation>
</enumeration>
<enumeration value="0367010">
  <annotation>
    <documentation>Venenkatheterinfektion</documentation>
  </annotation>
</enumeration>
<enumeration value="0367011">
  <annotation>
    <documentation>Harnwegsinfektion</documentation>
  </annotation>
</enumeration>
<enumeration value="0367012">
  <annotation>
    <documentation>Wundinfektion untere Extremitäten</documentation>
  </annotation>
</enumeration>
<enumeration value="0367013">
```

| | |
|--|--|
| | <pre> <annotation> <documentation>HIV-Infektion</documentation> </annotation> </enumeration> <enumeration value="0367014"> <annotation> <documentation>Hepatitis B oder C</documentation> </annotation> </enumeration> <enumeration value="0367015"> <annotation> <documentation>andere Wundinfektion</documentation> </annotation> </enumeration> <enumeration value="0367042"> <annotation> <documentation>sonstige Infektion</documentation> </annotation> </enumeration> </restriction> </simpleType> </pre> |
|--|--|

simpleType enum_0368

| | | | |
|------------|--|---------|--|
| namespace | http://xml.ir-d.de/irdsaa | | |
| type | restriction of string | | |
| properties | base xs:string | | |
| facets | Kind | Value | Annotation |
| | enumeration | 0368001 | documentation nein |
| | enumeration | 0368002 | documentation ja, COPD mit Dauermedikation |
| | enumeration | 0368003 | documentation ja, COPD ohne Dauermedikation |
| | enumeration | 0368004 | documentation ja, andere Lungenerkrankungen |
| | enumeration | 0368099 | documentation unbekannt |
| annotation | documentation Kat_AK_Lungenerkrankung | | |
| source | <pre> <simpleType name="enum_0368"> <annotation> <documentation>Kat_AK_Lungenerkrankung</documentation> </annotation> <restriction base="xs:string"> <enumeration value="0368001"> <annotation> <documentation>nein</documentation> </annotation> </enumeration> <enumeration value="0368002"> <annotation> <documentation>ja, COPD mit Dauermedikation</documentation> </annotation> </enumeration> <enumeration value="0368003"> <annotation> </pre> | | |

| | |
|--|---|
| | <pre> <documentation>ja, COPD ohne Dauermedikation</documentation> </annotation> </enumeration> <enumeration value="0368004"> <annotation> <documentation>ja, andere Lungenerkrankungen</documentation> </annotation> </enumeration> <enumeration value="0368099"> <annotation> <documentation>unbekannt</documentation> </annotation> </enumeration> </restriction> </simpleType> </pre> |
|--|---|

simpleType enum 0369

| | | | |
|------------|---|---------|----------------------------|
| namespace | http://xml.ir-d.de/irdsaa | | |
| type | restriction of string | | |
| properties | base xs:string | | |
| facets | Kind | Value | Annotation |
| | enumeration | 0369001 | documentation nein |
| | enumeration | 0369002 | documentation akut |
| | enumeration | 0369003 | documentation chronisch |
| annotation | documentation Kat_AK_Nierenersatztherapie | | |
| source | <pre> <simpleType name="enum_0369"> <annotation> <documentation>Kat_AK_Nierenersatztherapie</documentation> </annotation> <restriction base="xs:string"> <enumeration value="0369001"> <annotation> <documentation>nein</documentation> </annotation> </enumeration> <enumeration value="0369002"> <annotation> <documentation>akut</documentation> </annotation> </enumeration> <enumeration value="0369003"> <annotation> <documentation>chronisch</documentation> </annotation> </enumeration> </restriction> </simpleType> </pre> | | |

simpleType enum_0370

| | | | |
|------------|---|---------|------------------------------------|
| namespace | http://xml.ir-d.de/irdsaa | | |
| type | restriction of string | | |
| properties | base xs:string | | |
| facets | Kind | Value | Annotation |
| | enumeration | 0370001 | documentation Echokardiographie |
| | enumeration | 0370002 | documentation Herzkatheter |
| | enumeration | 0370042 | documentation andere |
| annotation | documentation Kat_AK_AKOEFMessmethode | | |
| source | <pre> <simpleType name="enum_0370"> <annotation> <documentation>Kat_AK_AKOEFMessmethode</documentation> </annotation> <restriction base="xs:string"> <enumeration value="0370001"> <annotation> <documentation>Echokardiographie</documentation> </annotation> </enumeration> <enumeration value="0370002"> <annotation> <documentation>Herzkatheter</documentation> </annotation> </enumeration> <enumeration value="0370042"> <annotation> <documentation>andere</documentation> </annotation> </enumeration> </restriction> </simpleType> </pre> | | |

simpleType enum_0371

| | | | |
|------------|---|---------|----------------------------|
| namespace | http://xml.ir-d.de/irdsaa | | |
| type | restriction of string | | |
| properties | base xs:string | | |
| facets | Kind | Value | Annotation |
| | enumeration | 0371001 | documentation keine |
| | enumeration | 0371002 | documentation leicht |
| | enumeration | 0371003 | documentation mittel |
| | enumeration | 0371004 | documentation schwer |
| | enumeration | 0371099 | documentation unbekannt |
| annotation | documentation Kat_AK_Verkalkungsgrad | | |
| source | <pre> <simpleType name="enum_0371"> <annotation> </pre> | | |

| | |
|--|--|
| | <pre> <documentation>Kat_AK_Verkalkungsgrad</documentation> </annotation> <restriction base="xs:string"> <enumeration value="0371001"> <annotation> <documentation>keine</documentation> </annotation> </enumeration> <enumeration value="0371002"> <annotation> <documentation>leicht</documentation> </annotation> </enumeration> <enumeration value="0371003"> <annotation> <documentation>mittel</documentation> </annotation> </enumeration> <enumeration value="0371004"> <annotation> <documentation>schwer</documentation> </annotation> </enumeration> <enumeration value="0371099"> <annotation> <documentation>unbekannt</documentation> </annotation> </enumeration> </restriction> </simpleType> </pre> |
|--|--|

simpleType enum_0372

| | | | |
|------------|---|---------|---------------------------------|
| namespace | http://xml.ir-d.de/irdsaa | | |
| type | restriction of string | | |
| properties | base xs:string | | |
| facets | Kind | Value | Annotation |
| | enumeration | 0372001 | documentation nein |
| | enumeration | 0372002 | documentation ja, bicuspide |
| | enumeration | 0372003 | documentation ja, unicuspide |
| | enumeration | 0372099 | documentation unbekannt |
| annotation | documentation Kat_AK_BiUnicuspideKlappe | | |
| source | <pre> <simpleType name="enum_0372"> <annotation> <documentation>Kat_AK_BiUnicuspideKlappe</documentation> </annotation> <restriction base="xs:string"> <enumeration value="0372001"> <annotation> <documentation>nein</documentation> </annotation> </enumeration> </pre> | | |

| | |
|--|---|
| | <pre> <enumeration value="0372002"> <annotation> <documentation>ja, bicuspide</documentation> </annotation> </enumeration> <enumeration value="0372003"> <annotation> <documentation>ja, unicuspide</documentation> </annotation> </enumeration> <enumeration value="0372099"> <annotation> <documentation>unbekannt</documentation> </annotation> </enumeration> </restriction> </simpleType> </pre> |
|--|---|

simpleType enum 0373

| | | | |
|------------|--|---------|-------------------------------|
| namespace | http://xml.ir-d.de/irdsaa | | |
| type | restriction of string | | |
| properties | base xs:string | | |
| facets | Kind | Value | Annotation |
| | enumeration | 0373001 | documentation keine |
| | enumeration | 0373002 | documentation leichtgradig |
| | enumeration | 0373003 | documentation mittelgradig |
| | enumeration | 0373004 | documentation hochgradig |
| | enumeration | 0373099 | documentation unbekannt |
| annotation | documentation Kat_AK_Grad | | |
| source | <pre> <simpleType name="enum_0373"> <annotation> <documentation>Kat_AK_Grad</documentation> </annotation> <restriction base="xs:string"> <enumeration value="0373001"> <annotation> <documentation>keine</documentation> </annotation> </enumeration> <enumeration value="0373002"> <annotation> <documentation>leichtgradig</documentation> </annotation> </enumeration> <enumeration value="0373003"> <annotation> <documentation>mittelgradig</documentation> </annotation> </enumeration> <enumeration value="0373004"> </pre> | | |

| | |
|--|--|
| | <pre> <annotation> <documentation>hochgradig</documentation> </annotation> </enumeration> <enumeration value="0373099"> <annotation> <documentation>unbekannt</documentation> </annotation> </enumeration> </restriction> </simpleType> </pre> |
|--|--|

simpleType enum_0374

| | | | |
|------------|--|---------|--|
| namespace | http://xml.ir-d.de/irdsaa | | |
| type | restriction of string | | |
| properties | base xs:string | | |
| facets | Kind | Value | Annotation |
| | enumeration | 0374001 | documentation nein |
| | enumeration | 0374002 | documentation ja, <= 6 Stunden |
| | enumeration | 0374003 | documentation ja, > 6 Stunden bis <= 24 Stunden |
| | enumeration | 0374004 | documentation ja, > 1 bis 7 Tage |
| | enumeration | 0374005 | documentation ja, > 7 bis 21 Tage |
| | enumeration | 0374006 | documentation ja, > 21 Tage |
| | enumeration | 0374099 | documentation unbekannt |
| annotation | documentation Kat_AK_InfarktAnamnese | | |
| source | <pre> <simpleType name="enum_0374"> <annotation> <documentation>Kat_AK_InfarktAnamnese</documentation> </annotation> <restriction base="xs:string"> <enumeration value="0374001"> <annotation> <documentation>nein</documentation> </annotation> </enumeration> <enumeration value="0374002"> <annotation> <documentation>ja, &lt;= 6 Stunden</documentation> </annotation> </enumeration> <enumeration value="0374003"> <annotation> <documentation>ja, &gt; 6 Stunden bis &lt;= 24 Stunden</documentation> </annotation> </enumeration> <enumeration value="0374004"> <annotation> <documentation>ja, &gt; 1 bis 7 Tage</documentation> </pre> | | |

| | |
|--|---|
| | <pre> </annotation> </enumeration> <enumeration value="0374005"> <annotation> <documentation>ja, &gt; 7 bis 21 Tage</documentation> </annotation> </enumeration> <enumeration value="0374006"> <annotation> <documentation>ja, &gt; 21 Tage</documentation> </annotation> </enumeration> <enumeration value="0374099"> <annotation> <documentation>unbekannt</documentation> </annotation> </enumeration> </restriction> </simpleType> </pre> |
|--|---|

simpleType enum 0375

| | | | |
|------------|--|---------|---|
| namespace | http://xml.ir-d.de/irdsaa | | |
| type | restriction of string | | |
| properties | base xs:string | | |
| facets | Kind | Value | Annotation |
| | enumeration | 0375001 | documentation keine Symptome oder Angina |
| | enumeration | 0375002 | documentation Symptome, aber keine Ischämiezeichen |
| | enumeration | 0375003 | documentation stabile Angina |
| | enumeration | 0375004 | documentation instabile Angina |
| | enumeration | 0375005 | documentation Infarkt ohne ST-Hebung (Non-STEMI) |
| | enumeration | 0375006 | documentation Infarkt mit ST-Hebung (STEMI) |
| | enumeration | 0375042 | documentation unbekannt |
| annotation | documentation Kat_AK_KardialeSymptome | | |
| source | <pre> <simpleType name="enum_0375"> <annotation> <documentation>Kat_AK_KardialeSymptome</documentation> </annotation> <restriction base="xs:string"> <enumeration value="0375001"> <annotation> <documentation>keine Symptome oder Angina</documentation> </annotation> </enumeration> <enumeration value="0375002"> <annotation> <documentation>Symptome, aber keine Ischämiezeichen</documentation> </annotation> </enumeration> </restriction> </pre> | | |

| | |
|--|---|
| | <pre> <enumeration value="0375003"> <annotation> <documentation>stabile Angina</documentation> </annotation> </enumeration> <enumeration value="0375004"> <annotation> <documentation>instabile Angina</documentation> </annotation> </enumeration> <enumeration value="0375005"> <annotation> <documentation>Infarkt ohne ST-Hebung (Non-STEMI)</documentation> </annotation> </enumeration> <enumeration value="0375006"> <annotation> <documentation>Infarkt mit ST-Hebung (STEMI)</documentation> </annotation> </enumeration> <enumeration value="0375042"> <annotation> <documentation>unbekannt</documentation> </annotation> </enumeration> </restriction> </simpleType> </pre> |
|--|---|

simpleType enum_0376

| | | | |
|------------|---|---------|---|
| namespace | http://xml.ir-d.de/irdsaa | | |
| type | restriction of string | | |
| properties | base xs:string | | |
| facets | Kind | Value | Annotation |
| | enumeration | 0376001 | documentation nein |
| | enumeration | 0376002 | documentation ja, ZNS, zerebrovaskuläre Blutung |
| | enumeration | 0376003 | documentation ja, ZNS, zerebrovaskuläre Ischämie |
| | enumeration | 0376042 | documentation ja, ZNS, andere |
| annotation | documentation Kat_AK_Schlaganfall | | |
| source | <pre> <simpleType name="enum_0376"> <annotation> <documentation>Kat_AK_Schlaganfall</documentation> </annotation> <restriction base="xs:string"> <enumeration value="0376001"> <annotation> <documentation>nein</documentation> </annotation> </enumeration> <enumeration value="0376002"> <annotation> <documentation>ja, ZNS, zerebrovaskuläre Blutung</documentation> </pre> | | |

| | |
|--|---|
| | <pre> </annotation> </enumeration> <enumeration value="0376003"> <annotation> <documentation>ja, ZNS, zerebrovaskuläre Ischämie</documentation> </annotation> </enumeration> <enumeration value="0376042"> <annotation> <documentation>ja, ZNS, andere</documentation> </annotation> </enumeration> </restriction> </simpleType> </pre> |
|--|---|

simpleType enum_0377

| | | | |
|------------|---|---------|---|
| namespace | http://xml.lir-d.de/irdsaa | | |
| type | restriction of string | | |
| properties | base xs:string | | |
| facets | Kind | Value | Annotation |
| | enumeration | 0377001 | documentation ja, mild neurological dysfunction: NIHSS 0-5 |
| | enumeration | 0377002 | documentation ja, moderate neurological dysfunction: NIHSS 6-14 |
| | enumeration | 0377003 | documentation ja, severe neurological dysfunction: NIHSS >=15 |
| annotation | documentation Kat_AK_Nihss | | |
| source | <pre> <simpleType name="enum_0377"> <annotation> <documentation>Kat_AK_Nihss</documentation> </annotation> <restriction base="xs:string"> <enumeration value="0377001"> <annotation> <documentation>ja, mild neurological dysfunction: NIHSS 0-5</documentation> </annotation> </enumeration> <enumeration value="0377002"> <annotation> <documentation>ja, moderate neurological dysfunction: NIHSS 6-14</documentation> </annotation> </enumeration> <enumeration value="0377003"> <annotation> <documentation> ja, severe neurological dysfunction: NIHSS &gt;=15</documentation> </annotation> </enumeration> </restriction> </simpleType> </pre> | | |

simpleType enum_0378

| | | | |
|------------|---|---------|--|
| namespace | http://xml.ir-d.de/irdsaa | | |
| type | restriction of string | | |
| properties | base xs:string | | |
| facets | Kind | Value | Annotation |
| | enumeration | 0378001 | documentation nein |
| | enumeration | 0378002 | documentation ja, < 48h gemäss VARC-3-Definition |
| | enumeration | 0378003 | documentation ja, >= 48h - <= 72h gemäß VARC-3-Definition |
| | enumeration | 0378004 | documentation ja, > 72 h gemäß VARC-3 Definition |
| annotation | documentation Kat_AK_Myokardinfarkt | | |
| source | <pre> <simpleType name="enum_0378"> <annotation> <documentation>Kat_AK_Myokardinfarkt</documentation> </annotation> <restriction base="xs:string"> <enumeration value="0378001"> <annotation> <documentation>nein</documentation> </annotation> </enumeration> <enumeration value="0378002"> <annotation> <documentation>ja, &lt; 48h gemäss VARC-3-Definition</documentation> </annotation> </enumeration> <enumeration value="0378003"> <annotation> <documentation>ja, &gt;= 48h - &lt;= 72h gemäß VARC-3-Definition</documentation> </annotation> </enumeration> <enumeration value="0378004"> <annotation> <documentation>ja, &gt; 72 h gemäß VARC-3 Definition</documentation> </annotation> </enumeration> </restriction> </simpleType> </pre> | | |

simpleType enum_0379

| | | | |
|------------|------------------------------|---------|--|
| namespace | http://xml.ir-d.de/irdsaa | | |
| type | restriction of string | | |
| properties | base xs:string | | |
| facets | Kind | Value | Annotation |
| | enumeration | 0379001 | documentation Keine gefäss- oder zugangsassozierte Komplikationen |
| | enumeration | 0379002 | documentation Versagen des perkutanen Verschlusssystems |
| | enumeration | 0379003 | documentation Geringfügige Gefäßkomplikationen |

| | |
|------------|--|
| | enumeration 0379004 documentation Erhebliche Gefäßkomplikationen |
| annotation | documentation Kat_AK_ZugangKomplikationen |
| source | <pre> <simpleType name="enum_0379"> <annotation> <documentation>Kat_AK_ZugangKomplikationen</documentation> </annotation> <restriction base="xs:string"> <enumeration value="0379001"> <annotation> <documentation>Keine gefäss- oder zugangsassoziierte Komplikationen</documentation> </annotation> </enumeration> <enumeration value="0379002"> <annotation> <documentation>Versagen des perkutanen Verschlussystems</documentation> </annotation> </enumeration> <enumeration value="0379003"> <annotation> <documentation>Geringfügige Gefäßkomplikationen</documentation> </annotation> </enumeration> <enumeration value="0379004"> <annotation> <documentation>Erhebliche Gefäßkomplikationen</documentation> </annotation> </enumeration> </restriction> </simpleType> </pre> |

simpleType enum_0380

| | | | |
|------------|---|---------|--|
| namespace | http://xml.ir-d.de/irdsaa | | |
| type | restriction of string | | |
| properties | base xs:string | | |
| facets | Kind | Value | Annotation |
| | enumeration | 0380001 | documentation nein |
| | enumeration | 0380002 | documentation ja, intraprozedural |
| | enumeration | 0380003 | documentation ja, postprozedural |
| | enumeration | 0380004 | documentation ja, Zeitpunkt nicht bekannt |
| annotation | documentation Kat_AK_Reanimation | | |
| source | <pre> <simpleType name="enum_0380"> <annotation> <documentation>Kat_AK_Reanimation</documentation> </annotation> <restriction base="xs:string"> <enumeration value="0380001"> <annotation> </pre> | | |

| | |
|--|--|
| | <pre> <documentation>nein</documentation> </annotation> </enumeration> <enumeration value="0380002"> <annotation> <documentation>ja, intraprozedural</documentation> </annotation> </enumeration> <enumeration value="0380003"> <annotation> <documentation>ja, postprozedural</documentation> </annotation> </enumeration> <enumeration value="0380004"> <annotation> <documentation>ja, Zeitpunkt nicht bekannt</documentation> </annotation> </enumeration> </restriction> </simpleType> </pre> |
|--|--|

simpleType enum_0381

| | | | |
|------------|---|---------|---|
| namespace | http://xml.ir-d.de/irdsaa | | |
| type | restriction of string | | |
| properties | base xs:string | | |
| facets | Kind | Value | Annotation |
| | enumeration | 0381001 | documentation nein |
| | enumeration | 0381002 | documentation Thorakotomie/Rethorakotomie |
| | enumeration | 0381003 | documentation kathetergestützte Reintervention |
| | enumeration | 0381004 | documentation lokale Reinterventionen |
| | enumeration | 0381005 | documentation andere Reintervention |
| annotation | documentation Kat_AK_Massnahmen | | |
| source | <pre> <simpleType name="enum_0381"> <annotation> <documentation>Kat_AK_Massnahmen</documentation> </annotation> <restriction base="xs:string"> <enumeration value="0381001"> <annotation> <documentation>nein</documentation> </annotation> </enumeration> <enumeration value="0381002"> <annotation> <documentation>Thorakotomie/Rethorakotomie</documentation> </annotation> </enumeration> <enumeration value="0381003"> <annotation> <documentation>kathetergestützte Reintervention</documentation> </pre> | | |

| | |
|--|--|
| | <pre> </annotation> </enumeration> <enumeration value="0381004"> <annotation> <documentation>lokale Reinterventionen</documentation> </annotation> </enumeration> <enumeration value="0381005"> <annotation> <documentation>andere Reintervention</documentation> </annotation> </enumeration> </restriction> </simpleType> </pre> |
|--|--|

simpleType enum_0382

| | | | |
|------------|---|---------|--|
| namespace | http://xml.lir-d.de/irdsaa | | |
| type | restriction of string | | |
| properties | base xs:string | | |
| facets | Kind | Value | Annotation |
| | enumeration | 0382001 | documentation keine Rethorakotomie / kein weiterer Grund |
| | enumeration | 0382002 | documentation Blutung/Hämatom |
| | enumeration | 0382003 | documentation Low Cardiac Output |
| | enumeration | 0382004 | documentation Tamponade |
| | enumeration | 0382005 | documentation Graftprobleme, Ischämie |
| | enumeration | 0382006 | documentation Wundinfektion, Mediastinitis |
| | enumeration | 0382007 | documentation Dissektion |
| | enumeration | 0382008 | documentation Prothesendysfunktion |
| | enumeration | 0382009 | documentation instabiles Sternum |
| | enumeration | 0382010 | documentation Chylothorax |
| | enumeration | 0382011 | documentation lokale Revision im Bereich des Zugangsweges |
| | enumeration | 0382042 | documentation anderer Grund |
| annotation | documentation Kat_AK_Komplikation | | |
| source | <pre> <simpleType name="enum_0382"> <annotation> <documentation>Kat_AK_Komplikation</documentation> </annotation> <restriction base="xs:string"> <enumeration value="0382001"> <annotation> <documentation>keine Rethorakotomie / kein weiterer Grund</documentation> </annotation> </enumeration> </pre> | | |

```

<enumeration value="0382002">
  <annotation>
    <documentation>Blutung/Hämatom</documentation>
  </annotation>
</enumeration>
<enumeration value="0382003">
  <annotation>
    <documentation>Low Cardiac Output</documentation>
  </annotation>
</enumeration>
<enumeration value="0382004">
  <annotation>
    <documentation>Tamponade</documentation>
  </annotation>
</enumeration>
<enumeration value="0382005">
  <annotation>
    <documentation>Graftprobleme, Ischämie</documentation>
  </annotation>
</enumeration>
<enumeration value="0382006">
  <annotation>
    <documentation>Wundinfektion, Mediastinitis</documentation>
  </annotation>
</enumeration>
<enumeration value="0382007">
  <annotation>
    <documentation>Dissektion</documentation>
  </annotation>
</enumeration>
<enumeration value="0382008">
  <annotation>
    <documentation>Prothesendysfunktion</documentation>
  </annotation>
</enumeration>
<enumeration value="0382009">
  <annotation>
    <documentation>instabiles Sternum</documentation>
  </annotation>
</enumeration>
<enumeration value="0382010">
  <annotation>
    <documentation>Chylothorax</documentation>
  </annotation>
</enumeration>
<enumeration value="0382011">
  <annotation>
    <documentation>lokale Revision im Bereich des
Zugangsweges</documentation>
  </annotation>
</enumeration>
<enumeration value="0382042">
  <annotation>
    <documentation>anderer Grund</documentation>
  </annotation>
</enumeration>
</restriction>
</simpleType>

```

simpleType enum_0383

| | | | |
|------------|---|---------|--|
| namespace | http://xml.ir-d.de/irdsaa | | |
| type | restriction of string | | |
| properties | base xs:string | | |
| facets | Kind | Value | Annotation |
| | enumeration | 0383001 | documentation nein |
| | enumeration | 0383002 | documentation ja, mit forcierter Atemtherapie |
| | enumeration | 0383003 | documentation ja, Reintubation oder längerfristige Beatmung |
| | enumeration | 0383004 | documentation ja, Tracheotomie |
| annotation | documentation Kat_AK_RespiratorischeInsuffizienz | | |
| source | <pre> <simpleType name="enum_0383"> <annotation> <documentation>Kat_AK_RespiratorischeInsuffizienz</documentation> </annotation> <restriction base="xs:string"> <enumeration value="0383001"> <annotation> <documentation>nein</documentation> </annotation> </enumeration> <enumeration value="0383002"> <annotation> <documentation>ja, mit forcierter Atemtherapie</documentation> </annotation> </enumeration> <enumeration value="0383003"> <annotation> <documentation>ja, Reintubation oder längerfristige Beatmung</documentation> </annotation> </enumeration> <enumeration value="0383004"> <annotation> <documentation>ja, Tracheotomie</documentation> </annotation> </enumeration> </restriction> </simpleType> </pre> | | |

simpleType enum_0384

| | | | |
|------------|------------------------------|---------|--|
| namespace | http://xml.ir-d.de/irdsaa | | |
| type | restriction of string | | |
| properties | base xs:string | | |
| facets | Kind | Value | Annotation |
| | enumeration | 0384001 | documentation keine Blutungskomplikationen |
| | enumeration | 0384002 | documentation Geringfügige Blutung (Minor Bleeding - BARC type 2 or 3a) |

| | |
|------------|--|
| | <p>enumeration 0384003 documentation Starke Blutung (Major Bleeding - BARC type 3a)</p> <p>enumeration 0384004 documentation Lebensbedrohliche Blutung (Life-threatening or disabling bleeding - BARC type 3b or 3c or type 5)</p> |
| annotation | documentation Kat_AK_Blutungskomplikation |
| source | <pre> <simpleType name="enum_0384"> <annotation> <documentation>Kat_AK_Blutungskomplikation</documentation> </annotation> <restriction base="xs:string"> <enumeration value="0384001"> <annotation> <documentation>keine Blutungskomplikationen</documentation> </annotation> </enumeration> <enumeration value="0384002"> <annotation> <documentation>Geringfügige Blutung (Minor Bleeding - BARC type 2 or 3a)</documentation> </annotation> </enumeration> <enumeration value="0384003"> <annotation> <documentation>Starke Blutung (Major Bleeding - BARC type 3a)</documentation> </annotation> </enumeration> <enumeration value="0384004"> <annotation> <documentation>Lebensbedrohliche Blutung (Life-threatening or disabling bleeding - BARC type 3b or 3c or type 5)</documentation> </annotation> </enumeration> </restriction> </simpleType> </pre> |

simpleType enum_0385

| | | | |
|------------|--|---------|---|
| namespace | http://xml.ir-d.de/irdsaa | | |
| type | restriction of string | | |
| properties | base xs:string | | |
| facets | Kind | Value | Annotation |
| | enumeration | 0385001 | documentation Sinusrhythmus |
| | enumeration | 0385002 | documentation Vorhofflimmern |
| | enumeration | 0385003 | documentation Patient verstorben (kein Herzrhythmus) |
| | enumeration | 0385042 | documentation anderer Rhythmus |
| annotation | documentation Kat_AK_HerzrhythmusEntlassung | | |
| source | <pre> <simpleType name="enum_0385"> <annotation> <documentation>Kat_AK_HerzrhythmusEntlassung</documentation> </pre> | | |

| | |
|--|---|
| | <pre> </annotation> <restriction base="xs:string"> <enumeration value="0385001"> <annotation> <documentation>Sinusrhythmus</documentation> </annotation> </enumeration> <enumeration value="0385002"> <annotation> <documentation>Vorhofflimmern</documentation> </annotation> </enumeration> <enumeration value="0385003"> <annotation> <documentation>Patient verstorben (kein Herzrhythmus)</documentation> </annotation> </enumeration> <enumeration value="0385042"> <annotation> <documentation>anderer Rhythmus</documentation> </annotation> </enumeration> </restriction> </simpleType> </pre> |
|--|---|

simpleType enum_0388

| | | | |
|------------|--|---------|--|
| namespace | http://xml.ir-d.de/irdsaa | | |
| type | restriction of string | | |
| properties | base xs:string | | |
| facets | Kind | Value | Annotation |
| | enumeration | 0388001 | documentation nein |
| | enumeration | 0388002 | documentation ASS |
| | enumeration | 0388003 | documentation ADP-Rezeptor-Antagonist |
| | enumeration | 0388004 | documentation Kombination ASS und ADP-Rezeptor-Antagonist |
| | enumeration | 0388042 | documentation ja, andere |
| | enumeration | 0388099 | documentation unbekannt |
| annotation | documentation Kat_AK_Plaettchenaggregationshemmer | | |
| source | <pre> <simpleType name="enum_0388"> <annotation> <documentation>Kat_AK_Plaettchenaggregationshemmer</documentation> </annotation> <restriction base="xs:string"> <enumeration value="0388001"> <annotation> <documentation>nein</documentation> </annotation> </enumeration> <enumeration value="0388002"> <annotation> </pre> | | |

| | |
|--|--|
| | <pre> <documentation>ASS</documentation> </annotation> </enumeration> <enumeration value="0388003"> <annotation> <documentation>ADP-Rezeptor-Antagonist</documentation> </annotation> </enumeration> <enumeration value="0388004"> <annotation> <documentation>Kombination ASS und ADP-Rezeptor-Antagonist</documentation> </annotation> </enumeration> <enumeration value="0388042"> <annotation> <documentation>ja, andere</documentation> </annotation> </enumeration> <enumeration value="0388099"> <annotation> <documentation>unbekannt</documentation> </annotation> </enumeration> </restriction> </simpleType> </pre> |
|--|--|

simpleType enum_0389

| | | | |
|------------|--|---------|---|
| namespace | http://xml.ir-d.de/irdsaa | | |
| type | restriction of string | | |
| properties | base xs:string | | |
| facets | Kind | Value | Annotation |
| | enumeration | 0389001 | documentation nein |
| | enumeration | 0389002 | documentation Cumarin-Derivate |
| | enumeration | 0389003 | documentation Heparinoide |
| | enumeration | 0389004 | documentation orale Thrombinantagonisten |
| | enumeration | 0389005 | documentation Kombination Heparinoide und Cumarin-Derivate |
| | enumeration | 0389006 | documentation Direkte orale Antikoagulantien (DOAK / NOAK) |
| | enumeration | 0389042 | documentation ja, andere |
| | enumeration | 0389099 | documentation unbekannt |
| annotation | documentation Kat AK Antikoagulantien | | |
| source | <pre> <simpleType name="enum_0389"> <annotation> <documentation>Kat_AK_Antikoagulantien</documentation> </annotation> <restriction base="xs:string"> <enumeration value="0389001"> <annotation> </pre> | | |

```

        <documentation>nein</documentation>
    </annotation>
</enumeration>
<enumeration value="0389002">
    <annotation>
        <documentation>Cumarin-Derivate</documentation>
    </annotation>
</enumeration>
<enumeration value="0389003">
    <annotation>
        <documentation>Heparinoide</documentation>
    </annotation>
</enumeration>
<enumeration value="0389004">
    <annotation>
        <documentation>orale Thrombinantagonisten</documentation>
    </annotation>
</enumeration>
<enumeration value="0389005">
    <annotation>
        <documentation>Kombination Heparinoide und
Cumarin-Derivate</documentation>
    </annotation>
</enumeration>
<enumeration value="0389006">
    <annotation>
        <documentation>Direkte orale Antikoagulantien (DOAK /
NOAK)</documentation>
    </annotation>
</enumeration>
<enumeration value="0389042">
    <annotation>
        <documentation>ja, andere</documentation>
    </annotation>
</enumeration>
<enumeration value="0389099">
    <annotation>
        <documentation>unbekannt</documentation>
    </annotation>
</enumeration>
</restriction>
</simpleType>

```

simpleType **enum_0390**

| | | | |
|------------|---|---------|---|
| namespace | http://xml.ir-d.de/irdsaa | | |
| type | restriction of string | | |
| properties | base xs:string | | |
| facets | Kind | Value | Annotation |
| | enumeration | 0390001 | documentation biologisches Klappenmodell |
| | enumeration | 0390002 | documentation mechanisches Klappenmodell |
| annotation | documentation Kat_AK_Artikeltyp | | |
| source | <pre> <simpleType name="enum_0390"> <annotation> </pre> | | |

| | |
|--|---|
| | <pre> <documentation>Kat_AK_Artikeltyp</documentation> </annotation> <restriction base="xs:string"> <enumeration value="0390001"> <annotation> <documentation>biologisches Klappenmodell</documentation> </annotation> </enumeration> <enumeration value="0390002"> <annotation> <documentation>mechanisches Klappenmodell</documentation> </annotation> </enumeration> </restriction> </simpleType> </pre> |
|--|---|

simpleType enum 0398

| | | | |
|------------|--|---------|--|
| namespace | http://xml.ir-d.de/irdsaa | | |
| type | restriction of string | | |
| properties | base xs:string | | |
| facets | Kind | Value | Annotation |
| | enumeration | 0398001 | documentation kardiovaskuläre Ursache |
| | enumeration | 0398002 | documentation nicht-kardiovaskuläre Ursache |
| | enumeration | 0398099 | documentation Todesursache unbekannt |
| annotation | documentation Kat_AK_Todesursache | | |
| source | <pre> <simpleType name="enum_0398"> <annotation> <documentation>Kat_AK_Todesursache</documentation> </annotation> <restriction base="xs:string"> <enumeration value="0398001"> <annotation> <documentation>kardiovaskuläre Ursache</documentation> </annotation> </enumeration> <enumeration value="0398002"> <annotation> <documentation>nicht-kardiovaskuläre Ursache</documentation> </annotation> </enumeration> <enumeration value="0398099"> <annotation> <documentation>Todesursache unbekannt</documentation> </annotation> </enumeration> </restriction> </simpleType> </pre> | | |

simpleType enum_0399

| | | | |
|------------|--|---------|--|
| namespace | http://xml.ir-d.de/irdsaa | | |
| type | restriction of string | | |
| properties | base xs:string | | |
| facets | Kind | Value | Annotation |
| | enumeration | 0399001 | documentation Patient lebt |
| | enumeration | 0399002 | documentation Patient im Krankenhaus verstorben |
| annotation | documentation Kat_AK_Vitalstatus | | |
| source | <pre> <simpleType name="enum_0399"> <annotation> <documentation>Kat_AK_Vitalstatus</documentation> </annotation> <restriction base="xs:string"> <enumeration value="0399001"> <annotation> <documentation>Patient lebt</documentation> </annotation> </enumeration> <enumeration value="0399002"> <annotation> <documentation>Patient im Krankenhaus verstorben</documentation> </annotation> </enumeration> </restriction> </simpleType> </pre> | | |

simpleType enum_0044

| | | | |
|------------|---|--|---|
| namespace | http://xml.ir-d.de/emg | | |
| type | restriction of string | | |
| properties | base xs:string | | |
| used by | element | OperationBasis/OPE_AsaSchluessel | |
| facets | Kind | Value | Annotation |
| | enumeration | 0044001 | documentation 1= normaler, sonst gesunder Patient |
| | enumeration | 0044002 | documentation 2= Patient mit leichter Allgemeinerkrankung |
| | enumeration | 0044003 | documentation 3= Patient mit schwerer Allgemeinerkrankung |
| | enumeration | 0044004 | documentation 4= Patient mit schwerer Allgemeinerkrankung, die eine ständige Lebensbedrohung darstellt |
| | enumeration | 0044005 | documentation 5= moribunder Patient, der ohne die Operation voraussichtlich nicht überleben wird |
| annotation | documentation Kat_ASA | | |
| source | <pre> <simpleType name="enum_0044"> <annotation> <documentation>Kat_ASA</documentation> </annotation> <restriction base="xs:string"> <enumeration value="0044001"> </pre> | | |

| | |
|--|--|
| | <pre> <annotation> <documentation>1= normaler, sonst gesunder Patient</documentation> </annotation> </enumeration> <enumeration value="0044002"> <annotation> <documentation>2= Patient mit leichter Allgemeinerkrankung</documentation> </annotation> </enumeration> <enumeration value="0044003"> <annotation> <documentation>3= Patient mit schwerer Allgemeinerkrankung</documentation> </annotation> </enumeration> <enumeration value="0044004"> <annotation> <documentation>4= Patient mit schwerer Allgemeinerkrankung, die eine ständige Lebensbedrohung darstellt</documentation> </annotation> </enumeration> <enumeration value="0044005"> <annotation> <documentation>5= moribunder Patient, der ohne die Operation voraussichtlich nicht überleben wird</documentation> </annotation> </enumeration> </restriction> </simpleType> </pre> |
|--|--|

simpleType enum_0050

| | | | |
|------------|--|---------|-------------------------|
| namespace | http://xml.ir-d.de/emg | | |
| type | restriction of string | | |
| properties | base xs:string | | |
| used by | element OperationBasis/OPE SeitenLokalisationSchluessel | | |
| facets | Kind | Value | Annotation |
| | enumeration | 0050001 | documentation rechts |
| | enumeration | 0050002 | documentation links |
| annotation | documentation Kat_RechtsLinks | | |
| source | <pre> <simpleType name="enum_0050"> <annotation> <documentation>Kat_RechtsLinks</documentation> </annotation> <restriction base="xs:string"> <enumeration value="0050001"> <annotation> <documentation>rechts</documentation> </annotation> </enumeration> <enumeration value="0050002"> <annotation> </pre> | | |

| | |
|--|---|
| | <pre> <documentation>links</documentation> </annotation> </enumeration> </restriction> </simpleType> </pre> |
|--|---|

simpleType **enum_0060**

| | | | |
|------------|--|--|-----------------------|
| namespace | http://xml.ir-d.de/emg | | |
| type | restriction of string | | |
| properties | base xs:string | | |
| used by | elements | ArtikelidentifikationBasis/ARI GefundenJNSchlüssel ArtikelidentifikationBasis/ARI SonderstatusJNSchlüssel OperationAortenklappeBasis/OAK AortaThorakalSchlüssel OperationAortenklappeBasis/OAK BeatmungSchlüssel OperationAortenklappeBasis/OAK ExplantationSchlüssel OperationAortenklappeBasis/OAK InotropeSchlüssel OperationAortenklappeBasis/OAK IntraOpUnterstützungSchlüssel OperationAortenklappeBasis/OAK IsoliertSchlüssel OperationAortenklappeBasis/OAK KomplikationenSchlüssel OperationAortenklappeBasis/OAK KreislaufunterstützungSchlüssel OperationAortenklappeBasis/OAK NeuroprotektionSchlüssel OperationAortenklappeBasis/OAK PciWegenKhkSchlüssel OperationAortenklappeBasis/OAK PciWegenKomplikationSchlüssel OperationAortenklappeBasis/OAK PraeOpUnterstützungSchlüssel OperationAortenklappeBasis/OAK PtcaNachSchlüssel OperationAortenklappeBasis/OAK PtcaVorSchlüssel OperationAortenklappeBasis/OAK RapidPacingIntraSchlüssel OperationAortenklappeBasis/OAK RapidPacingNachSchlüssel OperationAortenklappeBasis/OAK RapidPacingVorSchlüssel OperationAortenklappeBasis/OAK SuccessSchlüssel OperationAortenklappeBasis/OAK TroponinSchlüssel OperationAortenklappeBasis/OAK ValveInValveSchlüssel OperationAortenklappeBasis/OAK ZusätzlichePciSchlüssel OperationEndoprotheseBasis/OEP FrakturJNSchlüssel PostoperationAortenklappeBasis/POA AvBlockSchlüssel PostoperationAortenklappeBasis/POA EndokarditisSchlüssel PostoperationAortenklappeBasis/POA IntraOpVerstorbenSchlüssel PostoperationAortenklappeBasis/POA NierenersatzSchlüssel PostoperationAortenklappeBasis/POA SepsisSchlüssel PostoperationAortenklappeBasis/POA VorhofflimmernSchlüssel | |
| facets | Kind | Value | Annotation |
| | enumeration | 0060001 | documentation ja |
| | enumeration | 0060002 | documentation nein |
| annotation | documentation Kat_JaNein | | |
| source | <pre> <simpleType name="enum_0060"> <annotation> <documentation>Kat_JaNein</documentation> </annotation> <restriction base="xs:string"> <enumeration value="0060001"> <annotation> <documentation>ja</documentation> </annotation> </enumeration> <enumeration value="0060002"> </pre> | | |

| | |
|--|---|
| | <pre> <annotation> <documentation>nein</documentation> </annotation> </enumeration> </restriction> </simpleType> </pre> |
|--|---|

simpleType enum_0061

| | | | |
|------------|---|---|----------------------------|
| namespace | http://xml.ir-d.de/emg | | |
| type | restriction of string | | |
| properties | base xs:string | | |
| used by | elements | OperationAortenklappeBasis/OAK ZugangVerkalkungSchluessel PatientenaufnahmeAortenklappeBasis/PAA AortenaneurysmaSchluessel PatientenaufnahmeAortenklappeBasis/PAA ArteriaCarotisSchluessel PatientenaufnahmeAortenklappeBasis/PAA AvkSchluessel PatientenaufnahmeAortenklappeBasis/PAA HypertonusSchluessel PatientenaufnahmeAortenklappeBasis/PAA PAvkSchluessel PatientenaufnahmeAortenklappeBasis/PAA SonstigeAvkSchluessel PatientenaufnahmeAortenklappeBasis/PAA ValvuloplastieSchluessel | |
| facets | Kind | Value | Annotation |
| | enumeration | 0061001 | documentation ja |
| | enumeration | 0061002 | documentation nein |
| | enumeration | 0061099 | documentation unbekannt |
| annotation | documentation Kat_JaNeinUnbekannt | | |
| source | <pre> <simpleType name="enum_0061"> <annotation> <documentation>Kat_JaNeinUnbekannt</documentation> </annotation> <restriction base="xs:string"> <enumeration value="0061001"> <annotation> <documentation>ja</documentation> </annotation> </enumeration> <enumeration value="0061002"> <annotation> <documentation>nein</documentation> </annotation> </enumeration> <enumeration value="0061099"> <annotation> <documentation>unbekannt</documentation> </annotation> </enumeration> </restriction> </simpleType> </pre> | | |

simpleType enum_0062

| | |
|-----------|------------------------|
| namespace | http://xml.ir-d.de/emg |
|-----------|------------------------|

| | | | |
|------------|--|---------|----------------------------------|
| type | restriction of string | | |
| properties | base xs:string | | |
| used by | element ZubehoerEndoprotheseBasis/ZEP EinheitSchluessel | | |
| facets | Kind | Value | Annotation |
| | enumeration | 0062001 | documentation Stück |
| | enumeration | 0062002 | documentation g |
| | enumeration | 0062003 | documentation mg |
| | enumeration | 0062004 | documentation l |
| | enumeration | 0062005 | documentation ml |
| | enumeration | 0062006 | documentation cm ³ |
| | enumeration | 0062007 | documentation mm |
| | enumeration | 0062008 | documentation cm |
| | enumeration | 0062009 | documentation dm |
| | enumeration | 0062010 | documentation m |
| | enumeration | 0062042 | documentation andere |
| annotation | documentation Kat_Einheit | | |
| source | <pre> <simpleType name="enum_0062"> <annotation> <documentation>Kat_Einheit</documentation> </annotation> <restriction base="xs:string"> <enumeration value="0062001"> <annotation> <documentation>Stück</documentation> </annotation> </enumeration> <enumeration value="0062002"> <annotation> <documentation>g</documentation> </annotation> </enumeration> <enumeration value="0062003"> <annotation> <documentation>mg</documentation> </annotation> </enumeration> <enumeration value="0062004"> <annotation> <documentation>l</documentation> </annotation> </enumeration> <enumeration value="0062005"> <annotation> <documentation>ml</documentation> </annotation> </enumeration> <enumeration value="0062006"> </pre> | | |

| | |
|--|--|
| | <pre> <annotation> <documentation>cm³</documentation> </annotation> </enumeration> <enumeration value="0062007"> <annotation> <documentation>mm</documentation> </annotation> </enumeration> <enumeration value="0062008"> <annotation> <documentation>cm</documentation> </annotation> </enumeration> <enumeration value="0062009"> <annotation> <documentation>dm</documentation> </annotation> </enumeration> <enumeration value="0062010"> <annotation> <documentation>m</documentation> </annotation> </enumeration> <enumeration value="0062042"> <annotation> <documentation>andere</documentation> </annotation> </enumeration> </restriction> </simpleType> </pre> |
|--|--|

simpleType enum_0065

| | | | |
|------------|---|---|--------------------------------|
| namespace | http://xml.ir-d.de/emg | | |
| type | restriction of string | | |
| properties | base xs:string | | |
| used by | element | FallBasis/FAL ArtAufenthaltSchluessel | |
| facets | Kind | Value | Annotation |
| | enumeration | 0065001 | documentation stationär |
| | enumeration | 0065002 | documentation teilstationär |
| | enumeration | 0065003 | documentation ambulant |
| annotation | documentation Kat_ArtAufenthalt | | |
| source | <pre> <simpleType name="enum_0065"> <annotation> <documentation>Kat_ArtAufenthalt</documentation> </annotation> <restriction base="xs:string"> <enumeration value="0065001"> <annotation> <documentation>stationär</documentation> </annotation> </pre> | | |

| | |
|--|---|
| | <pre> </enumeration> <enumeration value="0065002"> <annotation> <documentation>teilstationär</documentation> </annotation> </enumeration> <enumeration value="0065003"> <annotation> <documentation>ambulant</documentation> </annotation> </enumeration> </restriction> </simpleType> </pre> |
|--|---|

simpleType enum_0067

| | | | |
|------------|---|---------|----------------------------|
| namespace | http://xml.ir-d.de/emg | | |
| type | restriction of string | | |
| properties | base xs:string | | |
| used by | element ArtikelidentifikationBasis/ARI ArtikelArtSchluessel | | |
| facets | Kind | Value | Annotation |
| | enumeration | 0067001 | documentation Implantat |
| | enumeration | 0067002 | documentation Explantat |
| annotation | documentation Kat_ArtArtikel | | |
| source | <pre> <simpleType name="enum_0067"> <annotation> <documentation>Kat_ArtArtikel</documentation> </annotation> <restriction base="xs:string"> <enumeration value="0067001"> <annotation> <documentation>Implantat</documentation> </annotation> </enumeration> <enumeration value="0067002"> <annotation> <documentation>Explantat</documentation> </annotation> </enumeration> </restriction> </simpleType> </pre> | | |

simpleType enum_0068

| | | | |
|------------|---|---------|---------------|
| namespace | http://xml.ir-d.de/emg | | |
| type | restriction of string | | |
| properties | base xs:string | | |
| used by | element ArtikelidentifikationBasis/ARI KennzeichenTypSchluessel | | |
| facets | Kind | Value | Annotation |
| | enumeration | 0068001 | documentation |

| | |
|------------|--|
| | enumeration 0068002 UDI documentation Referenz (REF) enumeration 0068003 documentation Katalognummer enumeration 0068042 documentation sonstiger |
| annotation | documentation Kat_KennzeichenTyp |
| source | <pre> <simpleType name="enum_0068"> <annotation> <documentation>Kat_KennzeichenTyp</documentation> </annotation> <restriction base="xs:string"> <enumeration value="0068001"> <annotation> <documentation>UDI</documentation> </annotation> </enumeration> <enumeration value="0068002"> <annotation> <documentation>Referenz (REF)</documentation> </annotation> </enumeration> <enumeration value="0068003"> <annotation> <documentation>Katalognummer</documentation> </annotation> </enumeration> <enumeration value="0068042"> <annotation> <documentation>sonstiger</documentation> </annotation> </enumeration> </restriction> </simpleType> </pre> |

simpleType enum 0069

| | | | |
|------------|---|---------|----------------------------|
| namespace | http://xml.ir-d.de/emg | | |
| type | restriction of string | | |
| properties | base xs:string | | |
| used by | element ZubehoerBasis/ZUB ZubehoerArtSchluessel | | |
| facets | Kind | Value | Annotation |
| | enumeration | 0069001 | documentation Implantat |
| | enumeration | 0069002 | documentation Explantat |
| annotation | documentation Kat_ArtZubehoer | | |
| source | <pre> <simpleType name="enum_0069"> <annotation> <documentation>Kat_ArtZubehoer</documentation> </annotation> <restriction base="xs:string"> <enumeration value="0069001"> </pre> | | |

| | |
|--|---|
| | <pre> <annotation> <documentation>Implantat</documentation> </annotation> </enumeration> <enumeration value="0069002"> <annotation> <documentation>Explantat</documentation> </annotation> </enumeration> </restriction> </simpleType> </pre> |
|--|---|

simpleType enum_0070

| | | | |
|------------|---|---------|--------------------------|
| namespace | http://xml.ir-d.de/emg | | |
| type | restriction of string | | |
| properties | base xs:string | | |
| used by | element PatientenaufnahmeBasis/PAT GeschlechtSchlüssel | | |
| facets | Kind | Value | Annotation |
| | enumeration | 0070001 | documentation weiblich |
| | enumeration | 0070002 | documentation männlich |
| | enumeration | 0070003 | documentation divers |
| | enumeration | 0070042 | documentation unbestimmt |
| annotation | documentation Kat_Geschlecht | | |
| source | <pre> <simpleType name="enum_0070"> <annotation> <documentation>Kat_Geschlecht</documentation> </annotation> <restriction base="xs:string"> <enumeration value="0070001"> <annotation> <documentation>weiblich</documentation> </annotation> </enumeration> <enumeration value="0070002"> <annotation> <documentation>männlich</documentation> </annotation> </enumeration> <enumeration value="0070003"> <annotation> <documentation>divers</documentation> </annotation> </enumeration> <enumeration value="0070042"> <annotation> <documentation>unbestimmt</documentation> </annotation> </enumeration> </restriction> </simpleType> </pre> | | |

simpleType enum_0071

| | | | |
|------------|---|---------|---|
| namespace | http://xml.ir-d.de/emg | | |
| type | restriction of string | | |
| properties | base xs:string | | |
| used by | element ArtikelidentifikationBasis/ARI ArtikelArtFunktionSchluessel | | |
| facets | Kind | Value | Annotation |
| | enumeration | 0071001 | documentation Implantat |
| | enumeration | 0071002 | documentation Explantat |
| | enumeration | 0071003 | documentation Degeneriertes/defektes Produkt, das funktionslos im Körper verbleibt |
| annotation | documentation Kat_ArtikelArtFunktion | | |
| source | <pre> <simpleType name="enum_0071"> <annotation> <documentation>Kat_ArtikelArtFunktion</documentation> </annotation> <restriction base="xs:string"> <enumeration value="0071001"> <annotation> <documentation>Implantat</documentation> </annotation> </enumeration> <enumeration value="0071002"> <annotation> <documentation>Explantat</documentation> </annotation> </enumeration> <enumeration value="0071003"> <annotation> <documentation>Degeneriertes/defektes Produkt, das funktionslos im Körper verbleibt</documentation> </annotation> </enumeration> </restriction> </simpleType> </pre> | | |

simpleType enum_0075

| | | | |
|------------|--|---------|----------------------------|
| namespace | http://xml.ir-d.de/emg | | |
| type | restriction of string | | |
| properties | base xs:string | | |
| used by | element OperationEndoprotheseBasis/OEP DringlichkeitSchluessel | | |
| facets | Kind | Value | Annotation |
| | enumeration | 0075001 | documentation elektiv |
| | enumeration | 0075002 | documentation dringlich |
| | enumeration | 0075003 | documentation Notfall |

| | |
|------------|---|
| annotation | documentation Kat_Dringlichkeit |
| source | <pre> <simpleType name="enum_0075"> <annotation> <documentation>Kat_Dringlichkeit</documentation> </annotation> <restriction base="xs:string"> <enumeration value="0075001"> <annotation> <documentation>elektiv</documentation> </annotation> </enumeration> <enumeration value="0075002"> <annotation> <documentation>dringlich</documentation> </annotation> </enumeration> <enumeration value="0075003"> <annotation> <documentation>Notfall</documentation> </annotation> </enumeration> </restriction> </simpleType> </pre> |

simpleType **enum_0076**

| | | | |
|------------|--|---------|---|
| namespace | http://xml.ir-d.de/emg | | |
| type | restriction of string | | |
| properties | base xs:string | | |
| used by | element OperationAortenklappeBasis/OAK_DringlichkeitSchluessel | | |
| facets | Kind | Value | Annotation |
| | enumeration | 0076001 | documentation elektiv |
| | enumeration | 0076002 | documentation dringlich |
| | enumeration | 0076003 | documentation Notfall |
| | enumeration | 0076004 | documentation Notfall (Reanimation / ultima ratio) |
| annotation | documentation Kat_Dringlichkeit_Reanimation | | |
| source | <pre> <simpleType name="enum_0076"> <annotation> <documentation>Kat_Dringlichkeit_Reanimation</documentation> </annotation> <restriction base="xs:string"> <enumeration value="0076001"> <annotation> <documentation>elektiv</documentation> </annotation> </enumeration> <enumeration value="0076002"> <annotation> <documentation>dringlich</documentation> </annotation> </enumeration> </restriction> </simpleType> </pre> | | |

| | |
|--|---|
| | <pre> </enumeration> <enumeration value="0076003"> <annotation> <documentation>Notfall</documentation> </annotation> </enumeration> <enumeration value="0076004"> <annotation> <documentation>Notfall (Reanimation / ultima ratio)</documentation> </annotation> </enumeration> </restriction> </simpleType> </pre> |
|--|---|

simpleType enum_0080

| | | | |
|------------|---|---------|--|
| namespace | http://xml.ir-d.de/emg | | |
| type | restriction of string | | |
| properties | base xs:string | | |
| used by | element OperationBasis/OPE ImplantattypSchluessel | | |
| facets | Kind | Value | Annotation |
| | enumeration | 0080001 | documentation Endoprothese Hüfte/Knie |
| | enumeration | 0080002 | documentation Brustimplantat |
| | enumeration | 0080003 | documentation Aortenklappenprothese |
| annotation | documentation Kat_Implantattyp | | |
| source | <pre> <simpleType name="enum_0080"> <annotation> <documentation>Kat_Implantattyp</documentation> </annotation> <restriction base="xs:string"> <enumeration value="0080001"> <annotation> <documentation>Endoprothese Hüfte/Knie</documentation> </annotation> </enumeration> <enumeration value="0080002"> <annotation> <documentation>Brustimplantat</documentation> </annotation> </enumeration> <enumeration value="0080003"> <annotation> <documentation>Aortenklappenprothese</documentation> </annotation> </enumeration> </restriction> </simpleType> </pre> | | |

simpleType enum_0100

| | |
|-----------|------------------------|
| namespace | http://xml.ir-d.de/emg |
|-----------|------------------------|

| | | | |
|------------|--|---------|--|
| type | restriction of string | | |
| properties | base xs:string | | |
| used by | element OperationBrustimplantatBasis/OBI ArtEingriffSchluessel | | |
| facets | Kind | Value | Annotation |
| | enumeration | 0100001 | documentation Primäreingriff |
| | enumeration | 0100002 | documentation Austausch Expander gegen dauerhaftes Brustimplantat |
| | enumeration | 0100003 | documentation Revision |
| | enumeration | 0100004 | documentation Nur Explantation |
| annotation | documentation Kat_BI_ArtEingriff | | |
| source | <pre> <simpleType name="enum_0100"> <annotation> <documentation>Kat_BI_ArtEingriff</documentation> </annotation> <restriction base="xs:string"> <enumeration value="0100001"> <annotation> <documentation>Primäreingriff</documentation> </annotation> </enumeration> <enumeration value="0100002"> <annotation> <documentation>Austausch Expander gegen dauerhaftes Brustimplantat</documentation> </annotation> </enumeration> <enumeration value="0100003"> <annotation> <documentation>Revision</documentation> </annotation> </enumeration> <enumeration value="0100004"> <annotation> <documentation>Nur Explantation</documentation> </annotation> </enumeration> </restriction> </simpleType> </pre> | | |

simpleType **enum_0102**

| | | | |
|------------|--|---------|---|
| namespace | http://xml.ir-d.de/emg | | |
| type | restriction of string | | |
| properties | base xs:string | | |
| used by | element OperationBrustimplantatBasis/OBI GrundPrimaer EingriffSchluessel | | |
| facets | Kind | Value | Annotation |
| | enumeration | 0102001 | documentation kosmetische Augmentation |
| | enumeration | 0102002 | documentation Rekonstruktion, benigne |
| | enumeration | 0102003 | documentation |

| | |
|------------|--|
| | enumeration 0102004 documentation Rekonstruktion nach Mastektomie aufgrund eines Karzinoms Rekonstruktion nach risikoreduzierender Mastektomie |
| annotation | documentation Kat_BI_GrundPrimaereingriff |
| source | <pre> <simpleType name="enum_0102"> <annotation> <documentation>Kat_BI_GrundPrimaereingriff</documentation> </annotation> <restriction base="xs:string"> <enumeration value="0102001"> <annotation> <documentation>kosmetische Augmentation</documentation> </annotation> </enumeration> <enumeration value="0102002"> <annotation> <documentation>Rekonstruktion, benigne</documentation> </annotation> </enumeration> <enumeration value="0102003"> <annotation> <documentation>Rekonstruktion nach Mastektomie aufgrund eines Karzinoms</documentation> </annotation> </enumeration> <enumeration value="0102004"> <annotation> <documentation>Rekonstruktion nach risikoreduzierender Mastektomie</documentation> </annotation> </enumeration> </restriction> </simpleType> </pre> |

simpleType enum_0103

| | | | |
|------------|---|---------|---|
| namespace | http://xml.ir-d.de/emg | | |
| type | restriction of string | | |
| properties | base xs:string | | |
| used by | element OperationsdetailBrustimplantatBasis/ODB OperationsdetailPrimaer EingriffSchlüssel | | |
| facets | Kind | Value | Annotation |
| | enumeration | 0103001 | documentation simultane Lappendeckung |
| | enumeration | 0103002 | documentation simultane Eigenfetttransplantation |
| | enumeration | 0103003 | documentation simultane Mastopexie |
| | enumeration | 0103005 | documentation simultane Mastektomie, Ablatio / hautsparend |
| | enumeration | 0103006 | documentation simultane Mastektomie, nippelerhaltend |
| | enumeration | 0103007 | documentation Axilla-Dissektion |
| | enumeration | 0103008 | documentation Drainage |
| annotation | documentation | | |

| | |
|--------|---|
| | Kat_BI_OperationsdetailPrimaereingriff |
| source | <pre> <simpleType name="enum_0103"> <annotation> <documentation>Kat_BI_OperationsdetailPrimaereingriff</documentation> </annotation> <restriction base="xs:string"> <enumeration value="0103001"> <annotation> <documentation>simultane Lappendeckung</documentation> </annotation> </enumeration> <enumeration value="0103002"> <annotation> <documentation>simultane Eigenfetttransplantation</documentation> </annotation> </enumeration> <enumeration value="0103003"> <annotation> <documentation>simultane Mastopexie</documentation> </annotation> </enumeration> <enumeration value="0103005"> <annotation> <documentation>simultane Mastektomie, Ablatio / hautsparend</documentation> </annotation> </enumeration> <enumeration value="0103006"> <annotation> <documentation>simultane Mastektomie, nippelerhaltend</documentation> </annotation> </enumeration> <enumeration value="0103007"> <annotation> <documentation>Axilla-Dissektion</documentation> </annotation> </enumeration> <enumeration value="0103008"> <annotation> <documentation>Drainage</documentation> </annotation> </enumeration> </restriction> </simpleType> </pre> |

simpleType enum_0104

| | | | |
|------------|--|---|--|
| namespace | http://xml.lir-d.de/emg | | |
| type | restriction of string | | |
| properties | base xs:string | | |
| used by | element | OperationBrustimplantatBasis/OBI GrundAustauschSchluessel | |
| facets | Kind | Value | Annotation |
| | enumeration | 0104001 | documentation Austausch Expander gegen dauerhaftes Brustimplantat |
| annotation | documentation Kat_BI_GrundAustausch | | |

| | |
|--------|---|
| source | <pre> <simpleType name="enum_0104"> <annotation> <documentation>Kat_BI_GrundAustausch</documentation> </annotation> <restriction base="xs:string"> <enumeration value="0104001"> <annotation> <documentation>Austausch Expander gegen dauerhaftes Brustimplantat</documentation> </annotation> </enumeration> </restriction> </simpleType> </pre> |
|--------|---|

simpleType enum_0105

| | | | |
|------------|--|---|---|
| namespace | http://xml.ir-d.de/emg | | |
| type | restriction of string | | |
| properties | base xs:string | | |
| used by | element | OperationsdetailBrustimplantatBasis/ODB OperationsdetailAustauschSchluessel | |
| facets | Kind | Value | Annotation |
| | enumeration | 0105001 | documentation simultane Lappendeckung |
| | enumeration | 0105002 | documentation simultane Eigenfetttransplantation |
| | enumeration | 0105003 | documentation simultane Mastopexie |
| | enumeration | 0105008 | documentation Drainage |
| | enumeration | 0105009 | documentation Kapsulektomie, komplett |
| | enumeration | 0105010 | documentation Kapsulektomie, partiell |
| | enumeration | 0105011 | documentation Neopocket |
| annotation | documentation | Kat_BI_OperationsdetailAustausch | |
| source | <pre> <simpleType name="enum_0105"> <annotation> <documentation>Kat_BI_OperationsdetailAustausch</documentation> </annotation> <restriction base="xs:string"> <enumeration value="0105001"> <annotation> <documentation>simultane Lappendeckung</documentation> </annotation> </enumeration> <enumeration value="0105002"> <annotation> <documentation>simultane Eigenfetttransplantation</documentation> </annotation> </enumeration> <enumeration value="0105003"> <annotation> <documentation>simultane Mastopexie</documentation> </annotation> </enumeration> </restriction> </simpleType> </pre> | | |

| | |
|--|--|
| | <pre> <enumeration value="0105008"> <annotation> <documentation>Drainage</documentation> </annotation> </enumeration> <enumeration value="0105009"> <annotation> <documentation>Kapsulektomie, komplett</documentation> </annotation> </enumeration> <enumeration value="0105010"> <annotation> <documentation>Kapsulektomie, partiell</documentation> </annotation> </enumeration> <enumeration value="0105011"> <annotation> <documentation>Neopocket</documentation> </annotation> </enumeration> </restriction> </simpleType> </pre> |
|--|--|

simpleType enum_0106

| | | | |
|------------|--|---------|----------------------------------|
| namespace | http://xml.ir-d.de/emg | | |
| type | restriction of string | | |
| properties | base xs:string | | |
| used by | element OperationBrustimplantatBasis/OBI GrundRevisionExplantationSchluessel | | |
| facets | Kind | Value | Annotation |
| | enumeration | 0106001 | documentation Patientenwunsch |
| | enumeration | 0106002 | documentation asymptomatisch |
| | enumeration | 0106003 | documentation Komplikation |
| annotation | documentation Kat_BI_GrundRevisionExplantation | | |
| source | <pre> <simpleType name="enum_0106"> <annotation> <documentation>Kat_BI_GrundRevisionExplantation</documentation> </annotation> <restriction base="xs:string"> <enumeration value="0106001"> <annotation> <documentation>Patientenwunsch</documentation> </annotation> </enumeration> <enumeration value="0106002"> <annotation> <documentation>asymptomatisch</documentation> </annotation> </enumeration> <enumeration value="0106003"> <annotation> <documentation>Komplikation</documentation> </annotation> </enumeration> </restriction> </simpleType> </pre> | | |

```

</annotation>
</enumeration>
</restriction>
</simpleType>

```

simpleType enum_0107

| | | | |
|------------|---|--|---|
| namespace | http://xml.ir-d.de/emg | | |
| type | restriction of string | | |
| properties | base xs:string | | |
| used by | element | OperationsdetailBrustimplantatBasis/ODB OperationsdetailRevisionSchluessel | |
| facets | Kind | Value | Annotation |
| | enumeration | 0107001 | documentation simultane Lappendeckung |
| | enumeration | 0107002 | documentation simultane Eigenfetttransplantation |
| | enumeration | 0107003 | documentation simultane Mastopexie |
| | enumeration | 0107005 | documentation simultane Mastektomie, Ablatio / hautsparend |
| | enumeration | 0107006 | documentation simultane Mastektomie, nippelerhaltend |
| | enumeration | 0107007 | documentation Axilla-Dissektion |
| | enumeration | 0107008 | documentation Drainage |
| | enumeration | 0107009 | documentation Kapsulektomie, komplett |
| | enumeration | 0107010 | documentation Kapsulektomie, partiell |
| | enumeration | 0107011 | documentation Neopocket |
| annotation | documentation Kat_BI_OperationsdetailRevision | | |
| source | <pre> <simpleType name="enum_0107"> <annotation> <documentation>Kat_BI_OperationsdetailRevision</documentation> </annotation> <restriction base="xs:string"> <enumeration value="0107001"> <annotation> <documentation>simultane Lappendeckung</documentation> </annotation> </enumeration> <enumeration value="0107002"> <annotation> <documentation>simultane Eigenfetttransplantation</documentation> </annotation> </enumeration> <enumeration value="0107003"> <annotation> <documentation>simultane Mastopexie</documentation> </annotation> </enumeration> <enumeration value="0107005"> <annotation> <documentation>simultane Mastektomie, Ablatio / </pre> | | |

| | |
|--|--|
| | <pre> hautsparend</documentation> </annotation> </enumeration> <enumeration value="0107006"> <annotation> <documentation>simultane Mastektomie, nippelerhaltend</documentation> </annotation> </enumeration> <enumeration value="0107007"> <annotation> <documentation>Axilla-Dissektion</documentation> </annotation> </enumeration> <enumeration value="0107008"> <annotation> <documentation>Drainage</documentation> </annotation> </enumeration> <enumeration value="0107009"> <annotation> <documentation>Kapsulektomie, komplett</documentation> </annotation> </enumeration> <enumeration value="0107010"> <annotation> <documentation>Kapsulektomie, partiell</documentation> </annotation> </enumeration> <enumeration value="0107011"> <annotation> <documentation>Neopocket</documentation> </annotation> </enumeration> </restriction> </simpleType> </pre> |
|--|--|

simpleType enum_0110

| | | | |
|------------|--|---------|------------------------------|
| namespace | http://xml.ir-d.de/emg | | |
| type | restriction of string | | |
| properties | base xs:string | | |
| used by | element VorbereitungBrustimplantatBasis/BI_BehandlungLokalSchluessel | | |
| facets | Kind | Value | Annotation |
| | enumeration | 0110001 | documentation Bestrahlung |
| annotation | documentation Kat_BI_VorbereitungLokal | | |
| source | <pre> <simpleType name="enum_0110"> <annotation> <documentation>Kat_BI_VorbereitungLokal</documentation> </annotation> <restriction base="xs:string"> <enumeration value="0110001"> <annotation> <documentation>Bestrahlung</documentation> </annotation> </pre> | | |

| | |
|--|--|
| | <pre> </enumeration> </restriction> </simpleType> </pre> |
|--|--|

simpleType enum_0111

| | | | |
|------------|--|--|---|
| namespace | http://xml.ir-d.de/emg | | |
| type | restriction of string | | |
| properties | base xs:string | | |
| used by | element | OperationBrustimplantatBasis/OBI VerfahrenswechselSchluessel | |
| facets | Kind | Value | Annotation |
| | enumeration | 0111001 | documentation nein |
| | enumeration | 0111002 | documentation Lipofilling |
| | enumeration | 0111003 | documentation Eigengewebstrekonstruktion |
| annotation | documentation Kat_BI_Verfahrenswechsel | | |
| source | <pre> <simpleType name="enum_0111"> <annotation> <documentation>Kat_BI_Verfahrenswechsel</documentation> </annotation> <restriction base="xs:string"> <enumeration value="0111001"> <annotation> <documentation>nein</documentation> </annotation> </enumeration> <enumeration value="0111002"> <annotation> <documentation>Lipofilling</documentation> </annotation> </enumeration> <enumeration value="0111003"> <annotation> <documentation>Eigengewebstrekonstruktion</documentation> </annotation> </enumeration> </restriction> </simpleType> </pre> | | |

simpleType enum_0112

| | | | |
|------------|------------------------------|---|---|
| namespace | http://xml.ir-d.de/emg | | |
| type | restriction of string | | |
| properties | base xs:string | | |
| used by | element | OperationBrustimplantatBasis/OBI LageSchluessel | |
| facets | Kind | Value | Annotation |
| | enumeration | 0112001 | documentation subglandulär / epipektoral |
| | enumeration | 0112002 | documentation subpektoral |

| | |
|------------|--|
| | enumeration 0112003 documentation subfaszial enumeration 0112004 documentation sub-flap enumeration 0112005 documentation subkutan enumeration 0112006 documentation dual plane enumeration 0112042 documentation andere |
| annotation | documentation Kat_BI_LageImplantat |
| source | <pre> <simpleType name="enum_0112"> <annotation> <documentation>Kat_BI_LageImplantat</documentation> </annotation> <restriction base="xs:string"> <enumeration value="0112001"> <annotation> <documentation>subglandulär / epipektoral</documentation> </annotation> </enumeration> <enumeration value="0112002"> <annotation> <documentation>subpektoral</documentation> </annotation> </enumeration> <enumeration value="0112003"> <annotation> <documentation>subfaszial</documentation> </annotation> </enumeration> <enumeration value="0112004"> <annotation> <documentation>sub-flap</documentation> </annotation> </enumeration> <enumeration value="0112005"> <annotation> <documentation>subkutan</documentation> </annotation> </enumeration> <enumeration value="0112006"> <annotation> <documentation>dual plane</documentation> </annotation> </enumeration> <enumeration value="0112042"> <annotation> <documentation>andere</documentation> </annotation> </enumeration> </restriction> </simpleType> </pre> |

simpleType enum_0113

| | |
|-----------|------------------------|
| namespace | http://xml.ir-d.de/emg |
|-----------|------------------------|

| type | restriction of string | | | | | | |
|-------------|---|--|-------|------------|-------------|---------|--|
| properties | base xs:string | | | | | | |
| used by | element VorbereitungBrustimplantatBasis/VBI BehandlungSystemischSchlüssel | | | | | | |
| facets | <table border="1"> <thead> <tr> <th>Kind</th> <th>Value</th> <th>Annotation</th> </tr> </thead> <tbody> <tr> <td>enumeration</td> <td>0113001</td> <td>documentation Chemotherapie innerhalb der letzten drei Monate</td> </tr> </tbody> </table> | Kind | Value | Annotation | enumeration | 0113001 | documentation Chemotherapie innerhalb der letzten drei Monate |
| Kind | Value | Annotation | | | | | |
| enumeration | 0113001 | documentation Chemotherapie innerhalb der letzten drei Monate | | | | | |
| annotation | documentation Kat_BI_VorbereitungSystemisch | | | | | | |
| source | <pre> <simpleType name="enum_0113"> <annotation> <documentation>Kat_BI_VorbereitungSystemisch</documentation> </annotation> <restriction base="xs:string"> <enumeration value="0113001"> <annotation> <documentation>Chemotherapie innerhalb der letzten drei Monate</documentation> </annotation> </enumeration> </restriction> </simpleType> </pre> | | | | | | |

simpleType **enum_0114**

| namespace | http://xml.ir-d.de/emg | | | | | | | | | | | | | | | |
|-------------|---|----------------------------------|-------|------------|-------------|---------|------------------------------|-------------|---------|-----------------------|-------------|---------|----------------------------|-------------|---------|----------------------------------|
| type | restriction of string | | | | | | | | | | | | | | | |
| properties | base xs:string | | | | | | | | | | | | | | | |
| used by | element OperationBrustimplantatBasis/OBI EntfernungAdmNetzSchlüssel | | | | | | | | | | | | | | | |
| facets | <table border="1"> <thead> <tr> <th>Kind</th> <th>Value</th> <th>Annotation</th> </tr> </thead> <tbody> <tr> <td>enumeration</td> <td>0114001</td> <td>documentation vollständig</td> </tr> <tr> <td>enumeration</td> <td>0114002</td> <td>documentation nein</td> </tr> <tr> <td>enumeration</td> <td>0114003</td> <td>documentation teilweise</td> </tr> <tr> <td>enumeration</td> <td>0114004</td> <td>documentation nicht vorhanden</td> </tr> </tbody> </table> | Kind | Value | Annotation | enumeration | 0114001 | documentation vollständig | enumeration | 0114002 | documentation nein | enumeration | 0114003 | documentation teilweise | enumeration | 0114004 | documentation nicht vorhanden |
| Kind | Value | Annotation | | | | | | | | | | | | | | |
| enumeration | 0114001 | documentation vollständig | | | | | | | | | | | | | | |
| enumeration | 0114002 | documentation nein | | | | | | | | | | | | | | |
| enumeration | 0114003 | documentation teilweise | | | | | | | | | | | | | | |
| enumeration | 0114004 | documentation nicht vorhanden | | | | | | | | | | | | | | |
| annotation | documentation Kat_BI_EntfernungADMNetz | | | | | | | | | | | | | | | |
| source | <pre> <simpleType name="enum_0114"> <annotation> <documentation>Kat_BI_EntfernungADMNetz</documentation> </annotation> <restriction base="xs:string"> <enumeration value="0114001"> <annotation> <documentation>vollständig</documentation> </annotation> </enumeration> <enumeration value="0114002"> <annotation> <documentation>nein</documentation> </annotation> </enumeration> <enumeration value="0114003"> </pre> | | | | | | | | | | | | | | | |

| | |
|--|---|
| | <pre> <annotation> <documentation>teilweise</documentation> </annotation> </enumeration> <enumeration value="0114004"> <annotation> <documentation>nicht vorhanden</documentation> </annotation> </enumeration> </restriction> </simpleType> </pre> |
|--|---|

simpleType enum_0116

| | | | |
|------------|--|---------|--|
| namespace | http://xml.ir-d.de/emg | | |
| type | restriction of string | | |
| properties | base xs:string | | |
| used by | element MassnahmeBrustimplantatBasis/MAB MassnahmeSchlussel | | |
| facets | Kind | Value | Annotation |
| | enumeration | 0116001 | documentation Spülung, antibiotisch |
| | enumeration | 0116002 | documentation Spülung, antiseptisch |
| | enumeration | 0116003 | documentation Spülung, wirkstofffrei |
| | enumeration | 0116004 | documentation Spülung, andere |
| | enumeration | 0116005 | documentation prä-/perioperative Antibiotika |
| | enumeration | 0116006 | documentation postoperative Antibiotika |
| | enumeration | 0116007 | documentation Handschuhwechsel vor Implantation |
| | enumeration | 0116008 | documentation Implantationshilfe |
| annotation | documentation Kat_BI_Operationsmassnahme | | |
| source | <pre> <simpleType name="enum_0116"> <annotation> <documentation>Kat_BI_Operationsmassnahme</documentation> </annotation> <restriction base="xs:string"> <enumeration value="0116001"> <annotation> <documentation>Spülung, antibiotisch</documentation> </annotation> </enumeration> <enumeration value="0116002"> <annotation> <documentation>Spülung, antiseptisch</documentation> </annotation> </enumeration> <enumeration value="0116003"> <annotation> <documentation>Spülung, wirkstofffrei</documentation> </annotation> </enumeration> </pre> | | |

| | |
|--|--|
| | <pre> <enumeration value="0116004"> <annotation> <documentation>Spülung, andere</documentation> </annotation> </enumeration> <enumeration value="0116005"> <annotation> <documentation>prä-/perioperative Antibiotika</documentation> </annotation> </enumeration> <enumeration value="0116006"> <annotation> <documentation>postoperative Antibiotika</documentation> </annotation> </enumeration> <enumeration value="0116007"> <annotation> <documentation>Handschuhwechsel vor Implantation</documentation> </annotation> </enumeration> <enumeration value="0116008"> <annotation> <documentation>Implantationshilfe</documentation> </annotation> </enumeration> </restriction> </simpleType> </pre> |
|--|--|

simpleType enum_0118

| | | | |
|------------|---|---------|-----------------------------------|
| namespace | http://xml.ir-d.de/emg | | |
| type | restriction of string | | |
| properties | base xs:string | | |
| used by | element OperationBrustimplantatBasis/OBI ZugangSchluessel | | |
| facets | Kind | Value | Annotation |
| | enumeration | 0118001 | documentation axillär |
| | enumeration | 0118002 | documentation periareolär |
| | enumeration | 0118003 | documentation inframammär |
| | enumeration | 0118004 | documentation Mastektomienarbe |
| | enumeration | 0118042 | documentation anderer |
| annotation | documentation Kat_BI_Operationszugang | | |
| source | <pre> <simpleType name="enum_0118"> <annotation> <documentation>Kat_BI_Operationszugang</documentation> </annotation> <restriction base="xs:string"> <enumeration value="0118001"> <annotation> <documentation>axillär</documentation> </annotation> </pre> | | |

| | |
|--|---|
| | <pre> </enumeration> <enumeration value="0118002"> <annotation> <documentation>periareolär</documentation> </annotation> </enumeration> <enumeration value="0118003"> <annotation> <documentation>inframammär</documentation> </annotation> </enumeration> <enumeration value="0118004"> <annotation> <documentation>Mastektomienarbe</documentation> </annotation> </enumeration> <enumeration value="0118042"> <annotation> <documentation>anderer</documentation> </annotation> </enumeration> </restriction> </simpleType> </pre> |
|--|---|

simpleType enum_0120

| | | | |
|------------|--|---------|----------------------------------|
| namespace | http://xml.ir-d.de/emg | | |
| type | restriction of string | | |
| properties | base xs:string | | |
| used by | element BefundBrustimplantatBasis/BEB BefundAustauschSchluessel | | |
| facets | Kind | Value | Annotation |
| | enumeration | 0120001 | documentation Expander defekt |
| annotation | documentation Kat_BI_BefundAustausch | | |
| source | <pre> <simpleType name="enum_0120"> <annotation> <documentation>Kat_BI_BefundAustausch</documentation> </annotation> <restriction base="xs:string"> <enumeration value="0120001"> <annotation> <documentation>Expander defekt</documentation> </annotation> </enumeration> </restriction> </simpleType> </pre> | | |

simpleType enum_0121

| | | | |
|------------|------------------------------|--|--|
| namespace | http://xml.ir-d.de/emg | | |
| type | restriction of string | | |
| properties | base xs:string | | |

| used by | element BefundBrustimplantatBasis/BEB BefundSchluessel | | | | | | | | | | | | | | | | | | | | | | | | | | | | | | | | | | | | | | | | | | | | | | | | | | | |
|-------------|--|---|-------|------------|-------------|---------|----------------------------|-------------|---------|------------------------|-------------|---------|--------------------------|-------------|---------|--------------------------------|-------------|---------|----------------------------------|-------------|---------|--|-------------|---------|--|-------------|---------|--|-------------|---------|---------------------------------|-------------|---------|-------------------------------|-------------|---------|---|-------------|---------|--|-------------|---------|--|-------------|---------|---|-------------|---------|-----------------------------------|-------------|---------|--|
| facets | <table border="1"> <thead> <tr> <th>Kind</th> <th>Value</th> <th>Annotation</th> </tr> </thead> <tbody> <tr> <td>enumeration</td> <td>0121001</td> <td>documentation Infektion</td> </tr> <tr> <td>enumeration</td> <td>0121002</td> <td>documentation Serom</td> </tr> <tr> <td>enumeration</td> <td>0121003</td> <td>documentation Hämatom</td> </tr> <tr> <td>enumeration</td> <td>0121004</td> <td>documentation Kapselfibrose</td> </tr> <tr> <td>enumeration</td> <td>0121005</td> <td>documentation Implantatruptur</td> </tr> <tr> <td>enumeration</td> <td>0121006</td> <td>documentation Fehlpositionierung/Rotation</td> </tr> <tr> <td>enumeration</td> <td>0121007</td> <td>documentation BIA-ALCL/-SCC, Verdacht</td> </tr> <tr> <td>enumeration</td> <td>0121008</td> <td>documentation BIA-ALCL/-SCC, pathologisch bestätigt</td> </tr> <tr> <td>enumeration</td> <td>0121009</td> <td>documentation Brustschmerzen</td> </tr> <tr> <td>enumeration</td> <td>0121010</td> <td>documentation Doppelkapsel</td> </tr> <tr> <td>enumeration</td> <td>0121011</td> <td>documentation Netz-/ADM-bedingte Komplikation, Non-Integration</td> </tr> <tr> <td>enumeration</td> <td>0121012</td> <td>documentation Netz-/ADM-bedingte Komplikation, andere</td> </tr> <tr> <td>enumeration</td> <td>0121013</td> <td>documentation Hautnekrose/exponiertes Implantat</td> </tr> <tr> <td>enumeration</td> <td>0121014</td> <td>documentation BII/ASIA (Brustimplantat assoziierte Symptome), Verdacht</td> </tr> <tr> <td>enumeration</td> <td>0121015</td> <td>documentation Lymphadenopathie</td> </tr> <tr> <td>enumeration</td> <td>0121016</td> <td>documentation Brustkrebs, neu aufgetreten/Rezidiv</td> </tr> </tbody> </table> | Kind | Value | Annotation | enumeration | 0121001 | documentation Infektion | enumeration | 0121002 | documentation Serom | enumeration | 0121003 | documentation Hämatom | enumeration | 0121004 | documentation Kapselfibrose | enumeration | 0121005 | documentation Implantatruptur | enumeration | 0121006 | documentation Fehlpositionierung/Rotation | enumeration | 0121007 | documentation BIA-ALCL/-SCC, Verdacht | enumeration | 0121008 | documentation BIA-ALCL/-SCC, pathologisch bestätigt | enumeration | 0121009 | documentation Brustschmerzen | enumeration | 0121010 | documentation Doppelkapsel | enumeration | 0121011 | documentation Netz-/ADM-bedingte Komplikation, Non-Integration | enumeration | 0121012 | documentation Netz-/ADM-bedingte Komplikation, andere | enumeration | 0121013 | documentation Hautnekrose/exponiertes Implantat | enumeration | 0121014 | documentation BII/ASIA (Brustimplantat assoziierte Symptome), Verdacht | enumeration | 0121015 | documentation Lymphadenopathie | enumeration | 0121016 | documentation Brustkrebs, neu aufgetreten/Rezidiv |
| Kind | Value | Annotation | | | | | | | | | | | | | | | | | | | | | | | | | | | | | | | | | | | | | | | | | | | | | | | | | | |
| enumeration | 0121001 | documentation Infektion | | | | | | | | | | | | | | | | | | | | | | | | | | | | | | | | | | | | | | | | | | | | | | | | | | |
| enumeration | 0121002 | documentation Serom | | | | | | | | | | | | | | | | | | | | | | | | | | | | | | | | | | | | | | | | | | | | | | | | | | |
| enumeration | 0121003 | documentation Hämatom | | | | | | | | | | | | | | | | | | | | | | | | | | | | | | | | | | | | | | | | | | | | | | | | | | |
| enumeration | 0121004 | documentation Kapselfibrose | | | | | | | | | | | | | | | | | | | | | | | | | | | | | | | | | | | | | | | | | | | | | | | | | | |
| enumeration | 0121005 | documentation Implantatruptur | | | | | | | | | | | | | | | | | | | | | | | | | | | | | | | | | | | | | | | | | | | | | | | | | | |
| enumeration | 0121006 | documentation Fehlpositionierung/Rotation | | | | | | | | | | | | | | | | | | | | | | | | | | | | | | | | | | | | | | | | | | | | | | | | | | |
| enumeration | 0121007 | documentation BIA-ALCL/-SCC, Verdacht | | | | | | | | | | | | | | | | | | | | | | | | | | | | | | | | | | | | | | | | | | | | | | | | | | |
| enumeration | 0121008 | documentation BIA-ALCL/-SCC, pathologisch bestätigt | | | | | | | | | | | | | | | | | | | | | | | | | | | | | | | | | | | | | | | | | | | | | | | | | | |
| enumeration | 0121009 | documentation Brustschmerzen | | | | | | | | | | | | | | | | | | | | | | | | | | | | | | | | | | | | | | | | | | | | | | | | | | |
| enumeration | 0121010 | documentation Doppelkapsel | | | | | | | | | | | | | | | | | | | | | | | | | | | | | | | | | | | | | | | | | | | | | | | | | | |
| enumeration | 0121011 | documentation Netz-/ADM-bedingte Komplikation, Non-Integration | | | | | | | | | | | | | | | | | | | | | | | | | | | | | | | | | | | | | | | | | | | | | | | | | | |
| enumeration | 0121012 | documentation Netz-/ADM-bedingte Komplikation, andere | | | | | | | | | | | | | | | | | | | | | | | | | | | | | | | | | | | | | | | | | | | | | | | | | | |
| enumeration | 0121013 | documentation Hautnekrose/exponiertes Implantat | | | | | | | | | | | | | | | | | | | | | | | | | | | | | | | | | | | | | | | | | | | | | | | | | | |
| enumeration | 0121014 | documentation BII/ASIA (Brustimplantat assoziierte Symptome), Verdacht | | | | | | | | | | | | | | | | | | | | | | | | | | | | | | | | | | | | | | | | | | | | | | | | | | |
| enumeration | 0121015 | documentation Lymphadenopathie | | | | | | | | | | | | | | | | | | | | | | | | | | | | | | | | | | | | | | | | | | | | | | | | | | |
| enumeration | 0121016 | documentation Brustkrebs, neu aufgetreten/Rezidiv | | | | | | | | | | | | | | | | | | | | | | | | | | | | | | | | | | | | | | | | | | | | | | | | | | |
| annotation | documentation Kat_BI_BefundKomplett | | | | | | | | | | | | | | | | | | | | | | | | | | | | | | | | | | | | | | | | | | | | | | | | | | | |
| source | <pre> <simpleType name="enum_0121"> <annotation> <documentation>Kat_BI_BefundKomplett</documentation> </annotation> <restriction base="xs:string"> <enumeration value="0121001"> <annotation> <documentation>Infektion</documentation> </annotation> </enumeration> <enumeration value="0121002"> <annotation> <documentation>Serom</documentation> </annotation> </enumeration> <enumeration value="0121003"> <annotation> <documentation>Hämatom</documentation> </annotation> </enumeration> <enumeration value="0121004"> <annotation> <documentation>Kapselfibrose</documentation> </annotation> </enumeration> </restriction> </simpleType> </pre> | | | | | | | | | | | | | | | | | | | | | | | | | | | | | | | | | | | | | | | | | | | | | | | | | | | |

```

<enumeration value="0121005">
  <annotation>
    <documentation>Implantatruptur</documentation>
  </annotation>
</enumeration>
<enumeration value="0121006">
  <annotation>
    <documentation>Fehlpositionierung/Rotation</documentation>
  </annotation>
</enumeration>
<enumeration value="0121007">
  <annotation>
    <documentation>BIA-ALCL/-SCC, Verdacht</documentation>
  </annotation>
</enumeration>
<enumeration value="0121008">
  <annotation>
    <documentation>BIA-ALCL/-SCC, pathologisch bestätigt</documentation>
  </annotation>
</enumeration>
<enumeration value="0121009">
  <annotation>
    <documentation>Brustschmerzen</documentation>
  </annotation>
</enumeration>
<enumeration value="0121010">
  <annotation>
    <documentation>Doppelkapsel</documentation>
  </annotation>
</enumeration>
<enumeration value="0121011">
  <annotation>
    <documentation>Netz-/ADM-bedingte Komplikation,
Non-Integration</documentation>
  </annotation>
</enumeration>
<enumeration value="0121012">
  <annotation>
    <documentation>Netz-/ADM-bedingte Komplikation, andere</documentation>
  </annotation>
</enumeration>
<enumeration value="0121013">
  <annotation>
    <documentation>Hautnekrose/exponiertes Implantat</documentation>
  </annotation>
</enumeration>
<enumeration value="0121014">
  <annotation>
    <documentation>BII/ASIA (Brustimplantat assoziierte Symptome),
Verdacht</documentation>
  </annotation>
</enumeration>
<enumeration value="0121015">
  <annotation>
    <documentation>Lymphadenopathie</documentation>
  </annotation>
</enumeration>
<enumeration value="0121016">
  <annotation>

```

| | |
|--|---|
| | <pre> <documentation>Brustkrebs, neu aufgetreten/Rezidiv</documentation> </annotation> </enumeration> </restriction> </simpleType> </pre> |
|--|---|

simpleType enum_0122

| | | | |
|------------|---|---------|--|
| namespace | http://xml.ir-d.de/emg | | |
| type | restriction of string | | |
| properties | base xs:string | | |
| used by | element PatientenaufnahmeBrustimplantatBasis/PAB AutoimmunerkrankungSchluessel | | |
| facets | Kind | Value | Annotation |
| | enumeration | 0122001 | documentation ja, ärztlich nachgewiesen |
| | enumeration | 0122002 | documentation nein |
| | enumeration | 0122042 | documentation unbekannt |
| annotation | documentation Kat_BI_Autoimmunerkrankung | | |
| source | <pre> <simpleType name="enum_0122"> <annotation> <documentation>Kat_BI_Autoimmunerkrankung</documentation> </annotation> <restriction base="xs:string"> <enumeration value="0122001"> <annotation> <documentation>ja, ärztlich nachgewiesen</documentation> </annotation> </enumeration> <enumeration value="0122002"> <annotation> <documentation>nein</documentation> </annotation> </enumeration> <enumeration value="0122042"> <annotation> <documentation>unbekannt</documentation> </annotation> </enumeration> </restriction> </simpleType> </pre> | | |

simpleType enum_0123

| | | | |
|------------|---|---------|----------------------------------|
| namespace | http://xml.ir-d.de/emg | | |
| type | restriction of string | | |
| properties | base xs:string | | |
| used by | element PatientenaufnahmeBrustimplantatBasis/PAB VerlaufAutoimmunerkrankungSchluessel | | |
| facets | Kind | Value | Annotation |
| | enumeration | 0123001 | documentation neu aufgetreten |

| | |
|------------|--|
| | enumeration 0123002 documentation verschlechtert enumeration 0123003 documentation keine Veränderung enumeration 0123004 documentation nicht relevant, da Primäreingriff enumeration 0123042 documentation unbekannt |
| annotation | documentation Kat_BI_VerlaufAutoimmunerkrankung |
| source | <pre> <simpleType name="enum_0123"> <annotation> <documentation>Kat_BI_VerlaufAutoimmunerkrankung</documentation> </annotation> <restriction base="xs:string"> <enumeration value="0123001"> <annotation> <documentation>neu aufgetreten</documentation> </annotation> </enumeration> <enumeration value="0123002"> <annotation> <documentation>verschlechtert</documentation> </annotation> </enumeration> <enumeration value="0123003"> <annotation> <documentation>keine Veränderung</documentation> </annotation> </enumeration> <enumeration value="0123004"> <annotation> <documentation>nicht relevant, da Primäreingriff</documentation> </annotation> </enumeration> <enumeration value="0123042"> <annotation> <documentation>unbekannt</documentation> </annotation> </enumeration> </restriction> </simpleType> </pre> |

simpleType enum_0124

| | | | |
|------------|---|---------|--|
| namespace | http://xml.ir-d.de/emg | | |
| type | restriction of string | | |
| properties | base xs:string | | |
| used by | element ArtikelBrustimplantatBasis/ABI_FuellungSchluessel | | |
| facets | Kind | Value | Annotation |
| | enumeration | 0124001 | documentation Salzlösung |
| | enumeration | 0124002 | documentation Silikongel |
| | enumeration | 0124003 | documentation Kombination Silikongel und Salzlösung |
| | enumeration | 0124042 | documentation |

| | |
|------------|---|
| | sonstige |
| annotation | documentation Kat BI_Fuellung |
| source | <pre> <simpleType name="enum_0124"> <annotation> <documentation>Kat_BI_Fuellung</documentation> </annotation> <restriction base="xs:string"> <enumeration value="0124001"> <annotation> <documentation>Salzlösung</documentation> </annotation> </enumeration> <enumeration value="0124002"> <annotation> <documentation>Silikongel</documentation> </annotation> </enumeration> <enumeration value="0124003"> <annotation> <documentation>Kombination Silikongel und Salzlösung</documentation> </annotation> </enumeration> <enumeration value="0124042"> <annotation> <documentation>sonstige</documentation> </annotation> </enumeration> </restriction> </simpleType> </pre> |

simpleType enum_0126

| | | | |
|------------|---|---|---|
| namespace | http://xml.ir-d.de/emg | | |
| type | restriction of string | | |
| properties | base | xs:string | |
| used by | element | ArtikelBrustimplantatBasis/ABI_FormSchluessel | |
| facets | Kind | Value | Annotation |
| | enumeration | 0126001 | documentation anatomisch (tropfenförmig) |
| | enumeration | 0126002 | documentation rund (punktsymmetrisch) |
| | enumeration | 0126042 | documentation sonstige |
| annotation | documentation Kat BI_Form | | |
| source | <pre> <simpleType name="enum_0126"> <annotation> <documentation>Kat_BI_Form</documentation> </annotation> <restriction base="xs:string"> <enumeration value="0126001"> <annotation> <documentation>anatomisch (tropfenförmig)</documentation> </annotation> </enumeration> </pre> | | |

| | |
|--|--|
| | <pre> <enumeration value="0126002"> <annotation> <documentation>rund (punktsymmetrisch)</documentation> </annotation> </enumeration> <enumeration value="0126042"> <annotation> <documentation>sonstige</documentation> </annotation> </enumeration> </restriction> </simpleType> </pre> |
|--|--|

simpleType enum_0128

| namespace | http://xml.ir-d.de/emg | | | | | | | | | | | | |
|-------------|---|------------------------------|-------|------------|-------------|---------|------------------------------|-------------|---------|------------------------------|-------------|---------|-----------------------------|
| type | restriction of string | | | | | | | | | | | | |
| properties | base xs:string | | | | | | | | | | | | |
| used by | element ArtikelBrustimplantatBasis/ABI OberflaecheSchluesel | | | | | | | | | | | | |
| facets | <table border="1"> <thead> <tr> <th>Kind</th> <th>Value</th> <th>Annotation</th> </tr> </thead> <tbody> <tr> <td>enumeration</td> <td>0128001</td> <td>documentation glattwandig</td> </tr> <tr> <td>enumeration</td> <td>0128002</td> <td>documentation beschichtet</td> </tr> <tr> <td>enumeration</td> <td>0128003</td> <td>documentation texturiert</td> </tr> </tbody> </table> | Kind | Value | Annotation | enumeration | 0128001 | documentation glattwandig | enumeration | 0128002 | documentation beschichtet | enumeration | 0128003 | documentation texturiert |
| Kind | Value | Annotation | | | | | | | | | | | |
| enumeration | 0128001 | documentation glattwandig | | | | | | | | | | | |
| enumeration | 0128002 | documentation beschichtet | | | | | | | | | | | |
| enumeration | 0128003 | documentation texturiert | | | | | | | | | | | |
| annotation | documentation Kat_BI_Oberflaeche | | | | | | | | | | | | |
| source | <pre> <simpleType name="enum_0128"> <annotation> <documentation>Kat_BI_Oberflaeche</documentation> </annotation> <restriction base="xs:string"> <enumeration value="0128001"> <annotation> <documentation>glattwandig</documentation> </annotation> </enumeration> <enumeration value="0128002"> <annotation> <documentation>beschichtet</documentation> </annotation> </enumeration> <enumeration value="0128003"> <annotation> <documentation>texturiert</documentation> </annotation> </enumeration> </restriction> </simpleType> </pre> | | | | | | | | | | | | |

simpleType enum_0130

| | |
|-----------|------------------------|
| namespace | http://xml.ir-d.de/emg |
|-----------|------------------------|

| | | | |
|------------|---|---------|---|
| type | restriction of string | | |
| properties | base xs:string | | |
| used by | element ArtikelBrustimplantatBasis/ABI_HerstellerSchluessel | | |
| facets | Kind | Value | Annotation |
| | enumeration | 0130001 | documentation Allergan |
| | enumeration | 0130002 | documentation Cereplas |
| | enumeration | 0130003 | documentation CUI (Cox Uphoff Implants) |
| | enumeration | 0130004 | documentation EMSI Biomedical |
| | enumeration | 0130005 | documentation Establishment labs |
| | enumeration | 0130006 | documentation Eurosilicone |
| | enumeration | 0130007 | documentation Nagor |
| | enumeration | 0130008 | documentation Groupe Sebbin |
| | enumeration | 0130009 | documentation Laboratoires Arion |
| | enumeration | 0130010 | documentation Mentor |
| | enumeration | 0130011 | documentation Pérouse Plaste SAS |
| | enumeration | 0130012 | documentation PIP M-Implants |
| | enumeration | 0130013 | documentation Polytech Health & Aesthetics |
| | enumeration | 0130014 | documentation Silimed |
| | enumeration | 0130015 | documentation Surgitek |
| | enumeration | 0130016 | documentation G&G Biotechnology |
| | enumeration | 0130017 | documentation nicht belegter Wert |
| | enumeration | 0130018 | documentation nicht belegter Wert |
| | enumeration | 0130019 | documentation nicht belegter Wert |
| | enumeration | 0130020 | documentation nicht belegter Wert |
| | enumeration | 0130021 | documentation nicht belegter Wert |
| | enumeration | 0130042 | documentation sonstiger |
| annotation | documentation Kat_BI_Hersteller | | |
| source | <pre> <simpleType name="enum_0130"> <annotation> <documentation>Kat_BI_Hersteller</documentation> </annotation> <restriction base="xs:string"> <enumeration value="0130001"> <annotation> <documentation>Allergan</documentation> </annotation> </enumeration> <enumeration value="0130002"> </pre> | | |

```
<annotation>
  <documentation>Cereplas</documentation>
</annotation>
</enumeration>
<enumeration value="0130003">
  <annotation>
    <documentation>CUI (Cox Uphoff Implants)</documentation>
  </annotation>
</enumeration>
<enumeration value="0130004">
  <annotation>
    <documentation>EMSI Biomedical</documentation>
  </annotation>
</enumeration>
<enumeration value="0130005">
  <annotation>
    <documentation>Establishment labs</documentation>
  </annotation>
</enumeration>
<enumeration value="0130006">
  <annotation>
    <documentation>Eurosilicone</documentation>
  </annotation>
</enumeration>
<enumeration value="0130007">
  <annotation>
    <documentation>Nagor</documentation>
  </annotation>
</enumeration>
<enumeration value="0130008">
  <annotation>
    <documentation>Groupe Sebbin</documentation>
  </annotation>
</enumeration>
<enumeration value="0130009">
  <annotation>
    <documentation>Laboratoires Arion</documentation>
  </annotation>
</enumeration>
<enumeration value="0130010">
  <annotation>
    <documentation>Mentor</documentation>
  </annotation>
</enumeration>
<enumeration value="0130011">
  <annotation>
    <documentation>Pérouse Plastie SAS</documentation>
  </annotation>
</enumeration>
<enumeration value="0130012">
  <annotation>
    <documentation>PIP M-Implants</documentation>
  </annotation>
</enumeration>
<enumeration value="0130013">
  <annotation>
    <documentation>Polytech Health & Aesthetics</documentation>
  </annotation>
</enumeration>
```

```

<enumeration value="0130014">
  <annotation>
    <documentation>Silimed</documentation>
  </annotation>
</enumeration>
<enumeration value="0130015">
  <annotation>
    <documentation>Surgitek</documentation>
  </annotation>
</enumeration>
<enumeration value="0130016">
  <annotation>
    <documentation>G&amp;G Biotechnology</documentation>
  </annotation>
</enumeration>
<enumeration value="0130017">
  <annotation>
    <documentation>nicht belegter Wert</documentation>
  </annotation>
</enumeration>
<enumeration value="0130018">
  <annotation>
    <documentation>nicht belegter Wert</documentation>
  </annotation>
</enumeration>
<enumeration value="0130019">
  <annotation>
    <documentation>nicht belegter Wert</documentation>
  </annotation>
</enumeration>
<enumeration value="0130020">
  <annotation>
    <documentation>nicht belegter Wert</documentation>
  </annotation>
</enumeration>
<enumeration value="0130021">
  <annotation>
    <documentation>nicht belegter Wert</documentation>
  </annotation>
</enumeration>
<enumeration value="0130042">
  <annotation>
    <documentation>sonstiger</documentation>
  </annotation>
</enumeration>
</restriction>
</simpleType>

```

simpleType enum_0131

| | | | |
|------------|--|---------|---------------|
| namespace | http://xml.ir-d.de/emg | | |
| type | restriction of string | | |
| properties | base xs:string | | |
| used by | element ZubehoerBrustimplantatBasis/ZBI_HerstellerSchluessel | | |
| facets | Kind | Value | Annotation |
| | enumeration | 0131001 | documentation |

| | |
|------------|--|
| | <p>enumeration 0131002 Allergan documentation Establishment labs</p> <p>enumeration 0131003 documentation Eurosilicone</p> <p>enumeration 0131004 documentation Galatea</p> <p>enumeration 0131005 documentation Integra</p> <p>enumeration 0131006 documentation Lifecell</p> <p>enumeration 0131007 documentation MBP (Medical Biomaterial Products)</p> <p>enumeration 0131008 documentation Mentor</p> <p>enumeration 0131009 documentation Novus Scientific</p> <p>enumeration 0131042 documentation sonstiger</p> |
| annotation | documentation Kat_BI_ZubehoerHersteller |
| source | <pre> <simpleType name="enum_0131"> <annotation> <documentation>Kat_BI_ZubehoerHersteller</documentation> </annotation> <restriction base="xs:string"> <enumeration value="0131001"> <annotation> <documentation>Allergan</documentation> </annotation> </enumeration> <enumeration value="0131002"> <annotation> <documentation>Establishment labs</documentation> </annotation> </enumeration> <enumeration value="0131003"> <annotation> <documentation>Eurosilicone</documentation> </annotation> </enumeration> <enumeration value="0131004"> <annotation> <documentation>Galatea</documentation> </annotation> </enumeration> <enumeration value="0131005"> <annotation> <documentation>Integra</documentation> </annotation> </enumeration> <enumeration value="0131006"> <annotation> <documentation>Lifecell</documentation> </annotation> </enumeration> <enumeration value="0131007"> <annotation> <documentation>MBP (Medical Biomaterial Products)</documentation> </annotation> </enumeration> </restriction> </simpleType> </pre> |

| | |
|--|--|
| | <pre> <enumeration value="0131008"> <annotation> <documentation>Mentor</documentation> </annotation> </enumeration> <enumeration value="0131009"> <annotation> <documentation>Novus Scientific</documentation> </annotation> </enumeration> <enumeration value="0131042"> <annotation> <documentation>sonstiger</documentation> </annotation> </enumeration> </restriction> </simpleType> </pre> |
|--|--|

simpleType enum_0190

| | | | |
|------------|---|---------|---------------------------------|
| namespace | http://xml.ir-d.de/emg | | |
| type | restriction of string | | |
| properties | base xs:string | | |
| used by | element ArtikelBrustimplantatBasis/ABI ArtikelTypSchluessel | | |
| facets | Kind | Value | Annotation |
| | enumeration | 0190001 | documentation Brustimplantat |
| | enumeration | 0190003 | documentation Brustexpander |
| annotation | documentation Kat_BI_Artikeltyp | | |
| source | <pre> <simpleType name="enum_0190"> <annotation> <documentation>Kat_BI_Artikeltyp</documentation> </annotation> <restriction base="xs:string"> <enumeration value="0190001"> <annotation> <documentation>Brustimplantat</documentation> </annotation> </enumeration> <enumeration value="0190003"> <annotation> <documentation>Brustexpander</documentation> </annotation> </enumeration> </restriction> </simpleType> </pre> | | |

simpleType enum_0191

| | |
|-----------|------------------------------|
| namespace | http://xml.ir-d.de/emg |
| type | restriction of string |

| properties | base xs:string | | | | | | | | | |
|-------------|--|-----------------------|-------|------------|-------------|---------|-----------------------|-------------|---------|----------------------|
| used by | element ZubehoerBrustimplantatBasis/ZBI_ZubehoerTypSchluessel | | | | | | | | | |
| facets | <table border="1"> <thead> <tr> <th>Kind</th> <th>Value</th> <th>Annotation</th> </tr> </thead> <tbody> <tr> <td>enumeration</td> <td>0191001</td> <td>documentation Netz</td> </tr> <tr> <td>enumeration</td> <td>0191002</td> <td>documentation ADM</td> </tr> </tbody> </table> | Kind | Value | Annotation | enumeration | 0191001 | documentation Netz | enumeration | 0191002 | documentation ADM |
| Kind | Value | Annotation | | | | | | | | |
| enumeration | 0191001 | documentation Netz | | | | | | | | |
| enumeration | 0191002 | documentation ADM | | | | | | | | |
| annotation | documentation Kat_BI_ZubehoerTyp | | | | | | | | | |
| source | <pre><simpleType name="enum_0191"> <annotation> <documentation>Kat_BI_ZubehoerTyp</documentation> </annotation> <restriction base="xs:string"> <enumeration value="0191001"> <annotation> <documentation>Netz</documentation> </annotation> </enumeration> <enumeration value="0191002"> <annotation> <documentation>ADM</documentation> </annotation> </enumeration> </restriction> </simpleType></pre> | | | | | | | | | |

simpleType enum_0200

| namespace | http://xml.ir-d.de/emg | | | | | | | | | |
|-------------|---|--------------------------------|-------|------------|-------------|---------|--------------------------|-------------|---------|--------------------------------|
| type | restriction of string | | | | | | | | | |
| properties | base xs:string | | | | | | | | | |
| used by | element OperationEndoprotheseBasis/OEP_ArtEingriffSchluessel | | | | | | | | | |
| facets | <table border="1"> <thead> <tr> <th>Kind</th> <th>Value</th> <th>Annotation</th> </tr> </thead> <tbody> <tr> <td>enumeration</td> <td>0200001</td> <td>documentation Erst-OP</td> </tr> <tr> <td>enumeration</td> <td>0200002</td> <td>documentation Folgeeingriff</td> </tr> </tbody> </table> | Kind | Value | Annotation | enumeration | 0200001 | documentation Erst-OP | enumeration | 0200002 | documentation Folgeeingriff |
| Kind | Value | Annotation | | | | | | | | |
| enumeration | 0200001 | documentation Erst-OP | | | | | | | | |
| enumeration | 0200002 | documentation Folgeeingriff | | | | | | | | |
| annotation | documentation Kat_EP_ArtEingriff | | | | | | | | | |
| source | <pre><simpleType name="enum_0200"> <annotation> <documentation>Kat_EP_ArtEingriff</documentation> </annotation> <restriction base="xs:string"> <enumeration value="0200001"> <annotation> <documentation>Erst-OP</documentation> </annotation> </enumeration> <enumeration value="0200002"> <annotation> <documentation>Folgeeingriff</documentation> </annotation> </enumeration> </restriction> </simpleType></pre> | | | | | | | | | |

```

</restriction>
</simpleType>

```

simpleType enum_0202

| | | | |
|------------|---|---------|--|
| namespace | http://xml.ir-d.de/emg | | |
| type | restriction of string | | |
| properties | base xs:string | | |
| used by | element OperationEndoprotheseBasis/OEP GrundWechselHuefteSchluessel | | |
| facets | Kind | Value | Annotation |
| | enumeration | 0202001 | documentation Lockerung |
| | enumeration | 0202002 | documentation Infektion, Verdacht auf |
| | enumeration | 0202003 | documentation Infektion, gesichert |
| | enumeration | 0202004 | documentation Luxation, Inlay aus der Pfanne |
| | enumeration | 0202005 | documentation Luxation, Kopf aus Pfanne/Inlay |
| | enumeration | 0202006 | documentation Periprothetische Fraktur |
| | enumeration | 0202007 | documentation Verschleiß des PE-Inlays |
| | enumeration | 0202008 | documentation Implantatbruch |
| | enumeration | 0202009 | documentation Implantatfehlage/Malalignement |
| | enumeration | 0202010 | documentation Osteolysen bei festem Implantat |
| | enumeration | 0202011 | documentation Progression der Grunderkrankung |
| | enumeration | 0202012 | documentation ARM-D |
| | enumeration | 0202013 | documentation Verdacht auf allergische Reaktion |
| | enumeration | 0202021 | documentation Zustand nach Prothesenentfernung |
| | enumeration | 0202042 | documentation andere Gründe |
| annotation | documentation Kat_EP_GrundWechselHuefte | | |
| source | <pre> <simpleType name="enum_0202"> <annotation> <documentation>Kat_EP_GrundWechselHuefte</documentation> </annotation> <restriction base="xs:string"> <enumeration value="0202001"> <annotation> <documentation>Lockerung</documentation> </annotation> </enumeration> <enumeration value="0202002"> <annotation> <documentation>Infektion, Verdacht auf</documentation> </annotation> </enumeration> <enumeration value="0202003"> </pre> | | |

```
<annotation>
  <documentation>Infektion, gesichert</documentation>
</annotation>
</enumeration>
<enumeration value="0202004">
  <annotation>
    <documentation>Luxation, Inlay aus der Pfanne</documentation>
  </annotation>
</enumeration>
<enumeration value="0202005">
  <annotation>
    <documentation>Luxation, Kopf aus Pfanne/Inlay</documentation>
  </annotation>
</enumeration>
<enumeration value="0202006">
  <annotation>
    <documentation>Periprothetische Fraktur</documentation>
  </annotation>
</enumeration>
<enumeration value="0202007">
  <annotation>
    <documentation>Verschleiß des PE-Inlays</documentation>
  </annotation>
</enumeration>
<enumeration value="0202008">
  <annotation>
    <documentation>Implantatbruch</documentation>
  </annotation>
</enumeration>
<enumeration value="0202009">
  <annotation>
    <documentation>Implantatfehllage/Malalignent</documentation>
  </annotation>
</enumeration>
<enumeration value="0202010">
  <annotation>
    <documentation>Osteolysen bei festem Implantat</documentation>
  </annotation>
</enumeration>
<enumeration value="0202011">
  <annotation>
    <documentation>Progression der Grunderkrankung</documentation>
  </annotation>
</enumeration>
<enumeration value="0202012">
  <annotation>
    <documentation>ARMD</documentation>
  </annotation>
</enumeration>
<enumeration value="0202013">
  <annotation>
    <documentation>Verdacht auf allergische Reaktion</documentation>
  </annotation>
</enumeration>
<enumeration value="0202021">
  <annotation>
    <documentation>Zustand nach Prothesenentfernung</documentation>
  </annotation>
</enumeration>
```

| | |
|--|--|
| | <pre> <enumeration value="0202042"> <annotation> <documentation>andere Gründe</documentation> </annotation> </enumeration> </restriction> </simpleType> </pre> |
|--|--|

simpleType enum_0204

| | | | |
|------------|--|---------|--|
| namespace | http://xml.ir-d.de/emg | | |
| type | restriction of string | | |
| properties | base xs:string | | |
| used by | element OperationEndprotheseBasis/OEP GrundWechselKnieSchluessel | | |
| facets | Kind | Value | Annotation |
| | enumeration | 0204001 | documentation Lockerung |
| | enumeration | 0204002 | documentation Infektion, Verdacht auf |
| | enumeration | 0204003 | documentation Infektion, gesichert |
| | enumeration | 0204006 | documentation Periprothetische Fraktur |
| | enumeration | 0204007 | documentation Verschleiß |
| | enumeration | 0204008 | documentation Implantatbruch |
| | enumeration | 0204009 | documentation Implantatfehlage/Malalignent |
| | enumeration | 0204010 | documentation Osteolysen bei festem Implantat |
| | enumeration | 0204011 | documentation Progression der Grunderkrankung |
| | enumeration | 0204012 | documentation ARMD |
| | enumeration | 0204013 | documentation Verdacht auf allergische Reaktion |
| | enumeration | 0204014 | documentation Dislokation/Migration von Komponenten |
| | enumeration | 0204015 | documentation Bandinstabilität |
| | enumeration | 0204016 | documentation Bewegungseinschränkung |
| | enumeration | 0204021 | documentation Zustand nach Prothesenentfernung |
| | enumeration | 0204042 | documentation andere Gründe |
| annotation | documentation Kat_EP_GrundWechselKnie | | |
| source | <pre> <simpleType name="enum_0204"> <annotation> <documentation>Kat_EP_GrundWechselKnie</documentation> </annotation> <restriction base="xs:string"> <enumeration value="0204001"> <annotation> <documentation>Lockerung</documentation> </annotation> </enumeration> </pre> | | |

```
<enumeration value="0204002">
  <annotation>
    <documentation>Infektion, Verdacht auf</documentation>
  </annotation>
</enumeration>
<enumeration value="0204003">
  <annotation>
    <documentation>Infektion, gesichert</documentation>
  </annotation>
</enumeration>
<enumeration value="0204006">
  <annotation>
    <documentation>Periprothetische Fraktur</documentation>
  </annotation>
</enumeration>
<enumeration value="0204007">
  <annotation>
    <documentation>Verschleiß</documentation>
  </annotation>
</enumeration>
<enumeration value="0204008">
  <annotation>
    <documentation>Implantatbruch</documentation>
  </annotation>
</enumeration>
<enumeration value="0204009">
  <annotation>
    <documentation>Implantatfehlage/Malalignent</documentation>
  </annotation>
</enumeration>
<enumeration value="0204010">
  <annotation>
    <documentation>Osteolysen bei festem Implantat</documentation>
  </annotation>
</enumeration>
<enumeration value="0204011">
  <annotation>
    <documentation>Progression der Grunderkrankung</documentation>
  </annotation>
</enumeration>
<enumeration value="0204012">
  <annotation>
    <documentation>ARMD</documentation>
  </annotation>
</enumeration>
<enumeration value="0204013">
  <annotation>
    <documentation>Verdacht auf allergische Reaktion</documentation>
  </annotation>
</enumeration>
<enumeration value="0204014">
  <annotation>
    <documentation>Dislokation/Migration von Komponenten</documentation>
  </annotation>
</enumeration>
<enumeration value="0204015">
  <annotation>
    <documentation>Bandinstabilität</documentation>
  </annotation>
</enumeration>
```

```

</enumeration>
<enumeration value="0204016">
  <annotation>
    <documentation>Bewegungseinschränkung</documentation>
  </annotation>
</enumeration>
<enumeration value="0204021">
  <annotation>
    <documentation>Zustand nach Prothesenentfernung</documentation>
  </annotation>
</enumeration>
<enumeration value="0204042">
  <annotation>
    <documentation>andere Gründe</documentation>
  </annotation>
</enumeration>
</restriction>
</simpleType>

```

simpleType **enum_0206**

| | | | |
|------------|--|---------|--|
| namespace | http://xml.ir-d.de/emg | | |
| type | restriction of string | | |
| properties | base xs:string | | |
| used by | element OperationEndprotheseBasis/OEP GrundWechselTfeSchlüssel | | |
| facets | Kind | Value | Annotation |
| | enumeration | 0206001 | documentation Lockerung |
| | enumeration | 0206002 | documentation Infektion, Verdacht auf |
| | enumeration | 0206003 | documentation Infektion, gesichert |
| | enumeration | 0206004 | documentation Luxation, Inlay aus der Pfanne |
| | enumeration | 0206005 | documentation Luxation, Kopf aus Pfanne/Inlay |
| | enumeration | 0206006 | documentation Periprothetische Fraktur |
| | enumeration | 0206007 | documentation Verschleiß |
| | enumeration | 0206008 | documentation Implantatbruch |
| | enumeration | 0206009 | documentation Implantatfehlage/Malalignent |
| | enumeration | 0206010 | documentation Osteolysen bei festem Implantat |
| | enumeration | 0206011 | documentation Progression der Grunderkrankung |
| | enumeration | 0206012 | documentation ARMD |
| | enumeration | 0206013 | documentation Verdacht auf allergische Reaktion |
| | enumeration | 0206014 | documentation Dislokation/Migration von Komponenten |
| | enumeration | 0206015 | documentation Bandinstabilität |
| | enumeration | 0206016 | documentation Bewegungseinschränkung |
| | enumeration | 0206021 | documentation |

| | |
|------------|--|
| | enumeration 0206042 Zustand nach Prothesenentfernung documentation andere Gründe |
| annotation | documentation Kat_EP_GrundWechselTFE |
| source | <pre> <simpleType name="enum_0206"> <annotation> <documentation>Kat_EP_GrundWechselTFE</documentation> </annotation> <restriction base="xs:string"> <enumeration value="0206001"> <annotation> <documentation>Lockerung</documentation> </annotation> </enumeration> <enumeration value="0206002"> <annotation> <documentation>Infektion, Verdacht auf</documentation> </annotation> </enumeration> <enumeration value="0206003"> <annotation> <documentation>Infektion, gesichert</documentation> </annotation> </enumeration> <enumeration value="0206004"> <annotation> <documentation>Luxation, Inlay aus der Pfanne</documentation> </annotation> </enumeration> <enumeration value="0206005"> <annotation> <documentation>Luxation, Kopf aus Pfanne/Inlay</documentation> </annotation> </enumeration> <enumeration value="0206006"> <annotation> <documentation>Periprothetische Fraktur</documentation> </annotation> </enumeration> <enumeration value="0206007"> <annotation> <documentation>Verschleiß</documentation> </annotation> </enumeration> <enumeration value="0206008"> <annotation> <documentation>Implantatbruch</documentation> </annotation> </enumeration> <enumeration value="0206009"> <annotation> <documentation>Implantatfehllage/Malalignent</documentation> </annotation> </enumeration> <enumeration value="0206010"> <annotation> <documentation>Osteolysen bei festem Implantat</documentation> </annotation> </enumeration> </restriction> </simpleType> </pre> |

```

</enumeration>
<enumeration value="0206011">
  <annotation>
    <documentation>Progression der Grunderkrankung</documentation>
  </annotation>
</enumeration>
<enumeration value="0206012">
  <annotation>
    <documentation>ARMD</documentation>
  </annotation>
</enumeration>
<enumeration value="0206013">
  <annotation>
    <documentation>Verdacht auf allergische Reaktion</documentation>
  </annotation>
</enumeration>
<enumeration value="0206014">
  <annotation>
    <documentation>Dislokation/Migration von Komponenten</documentation>
  </annotation>
</enumeration>
<enumeration value="0206015">
  <annotation>
    <documentation>Bandinstabilität</documentation>
  </annotation>
</enumeration>
<enumeration value="0206016">
  <annotation>
    <documentation>Bewegungseinschränkung</documentation>
  </annotation>
</enumeration>
<enumeration value="0206021">
  <annotation>
    <documentation>Zustand nach Prothesenentfernung</documentation>
  </annotation>
</enumeration>
<enumeration value="0206042">
  <annotation>
    <documentation>andere Gründe</documentation>
  </annotation>
</enumeration>
</restriction>
</simpleType>

```

simpleType enum_0210

| | | | |
|------------|---|---------|--|
| namespace | http://xml.ir-d.de/emg | | |
| type | restriction of string | | |
| properties | base xs:string | | |
| used by | element VorbereitungEndoprotheseBasis/VEP_VorOpHuefteSchluessel | | |
| facets | Kind | Value | Annotation |
| | enumeration | 0210001 | documentation keine relevante Voroperation |
| | enumeration | 0210002 | documentation Osteosynthese/Osteotomie (Becken) |
| | enumeration | 0210003 | documentation |

| | |
|------------|---|
| | <p>enumeration 0210004 Osteosynthese/Osteotomie (Femur) documentation</p> <p>enumeration 0210005 Osteosynthese/Osteotomie (beides) documentation</p> <p>enumeration 0210006 Operation bei Hüftkopfnekrose documentation</p> <p>enumeration 0210042 Arthrodese documentation andere</p> |
| annotation | documentation Kat_EP_VoroperationHuefte |
| source | <pre> <simpleType name="enum_0210"> <annotation> <documentation>Kat_EP_VoroperationHuefte</documentation> </annotation> <restriction base="xs:string"> <enumeration value="0210001"> <annotation> <documentation>keine relevante Voroperation</documentation> </annotation> </enumeration> <enumeration value="0210002"> <annotation> <documentation>Osteosynthese/Osteotomie (Becken)</documentation> </annotation> </enumeration> <enumeration value="0210003"> <annotation> <documentation>Osteosynthese/Osteotomie (Femur)</documentation> </annotation> </enumeration> <enumeration value="0210004"> <annotation> <documentation>Osteosynthese/Osteotomie (beides)</documentation> </annotation> </enumeration> <enumeration value="0210005"> <annotation> <documentation>Operation bei Hüftkopfnekrose</documentation> </annotation> </enumeration> <enumeration value="0210006"> <annotation> <documentation>Arthrodese</documentation> </annotation> </enumeration> <enumeration value="0210042"> <annotation> <documentation>andere</documentation> </annotation> </enumeration> </restriction> </simpleType> </pre> |

simpleType enum_0211

| | |
|-----------|------------------------------|
| namespace | http://xml.ir-d.de/emg |
| type | restriction of string |

| properties | base xs:string | | | | | | | | | | | | | | | | | | | | | | | | | | | |
|-------------|---|---|-------|------------|-------------|---------|---|-------------|---------|---|-------------|---------|---|-------------|---------|---|-------------|---------|---|-------------|---------|--------------------------------------|-------------|---------|-----------------------------|-------------|---------|-------------------------|
| used by | element VorbereitungEndoprotheseBasis/VEP_VorOpKnieSchlüssel | | | | | | | | | | | | | | | | | | | | | | | | | | | |
| facets | <table border="1"> <thead> <tr> <th>Kind</th> <th>Value</th> <th>Annotation</th> </tr> </thead> <tbody> <tr> <td>enumeration</td> <td>0211001</td> <td>documentation keine relevante Voroperation</td> </tr> <tr> <td>enumeration</td> <td>0211002</td> <td>documentation Osteosynthese/Osteotomie (Femur)</td> </tr> <tr> <td>enumeration</td> <td>0211003</td> <td>documentation Osteosynthese/Osteotomie (Tibia)</td> </tr> <tr> <td>enumeration</td> <td>0211004</td> <td>documentation Osteosynthese/Osteotomie (Patella)</td> </tr> <tr> <td>enumeration</td> <td>0211005</td> <td>documentation Osteosynthese/Osteotomie (mehrere)</td> </tr> <tr> <td>enumeration</td> <td>0211006</td> <td>documentation Kapsel-/Bandapparat</td> </tr> <tr> <td>enumeration</td> <td>0211007</td> <td>documentation Arthrodese</td> </tr> <tr> <td>enumeration</td> <td>0211042</td> <td>documentation andere</td> </tr> </tbody> </table> | Kind | Value | Annotation | enumeration | 0211001 | documentation keine relevante Voroperation | enumeration | 0211002 | documentation Osteosynthese/Osteotomie (Femur) | enumeration | 0211003 | documentation Osteosynthese/Osteotomie (Tibia) | enumeration | 0211004 | documentation Osteosynthese/Osteotomie (Patella) | enumeration | 0211005 | documentation Osteosynthese/Osteotomie (mehrere) | enumeration | 0211006 | documentation Kapsel-/Bandapparat | enumeration | 0211007 | documentation Arthrodese | enumeration | 0211042 | documentation andere |
| Kind | Value | Annotation | | | | | | | | | | | | | | | | | | | | | | | | | | |
| enumeration | 0211001 | documentation keine relevante Voroperation | | | | | | | | | | | | | | | | | | | | | | | | | | |
| enumeration | 0211002 | documentation Osteosynthese/Osteotomie (Femur) | | | | | | | | | | | | | | | | | | | | | | | | | | |
| enumeration | 0211003 | documentation Osteosynthese/Osteotomie (Tibia) | | | | | | | | | | | | | | | | | | | | | | | | | | |
| enumeration | 0211004 | documentation Osteosynthese/Osteotomie (Patella) | | | | | | | | | | | | | | | | | | | | | | | | | | |
| enumeration | 0211005 | documentation Osteosynthese/Osteotomie (mehrere) | | | | | | | | | | | | | | | | | | | | | | | | | | |
| enumeration | 0211006 | documentation Kapsel-/Bandapparat | | | | | | | | | | | | | | | | | | | | | | | | | | |
| enumeration | 0211007 | documentation Arthrodese | | | | | | | | | | | | | | | | | | | | | | | | | | |
| enumeration | 0211042 | documentation andere | | | | | | | | | | | | | | | | | | | | | | | | | | |
| annotation | documentation Kat_EP_VoroperationKnie | | | | | | | | | | | | | | | | | | | | | | | | | | | |
| source | <pre> <simpleType name="enum_0211"> <annotation> <documentation>Kat_EP_VoroperationKnie</documentation> </annotation> <restriction base="xs:string"> <enumeration value="0211001"> <annotation> <documentation>keine relevante Voroperation</documentation> </annotation> </enumeration> <enumeration value="0211002"> <annotation> <documentation>Osteosynthese/Osteotomie (Femur)</documentation> </annotation> </enumeration> <enumeration value="0211003"> <annotation> <documentation>Osteosynthese/Osteotomie (Tibia)</documentation> </annotation> </enumeration> <enumeration value="0211004"> <annotation> <documentation>Osteosynthese/Osteotomie (Patella)</documentation> </annotation> </enumeration> <enumeration value="0211005"> <annotation> <documentation>Osteosynthese/Osteotomie (mehrere)</documentation> </annotation> </enumeration> <enumeration value="0211006"> <annotation> <documentation>Kapsel-/Bandapparat</documentation> </annotation> </enumeration> <enumeration value="0211007"> <annotation> <documentation>Arthrodese</documentation> </annotation> </enumeration> </restriction> </simpleType> </pre> | | | | | | | | | | | | | | | | | | | | | | | | | | | |

| | |
|--|--|
| | <pre> </annotation> </enumeration> <enumeration value="0211042"> <annotation> <documentation>andere</documentation> </annotation> </enumeration> </restriction> </simpleType> </pre> |
|--|--|

simpleType enum_0212

| | | | |
|------------|--|---------|--|
| namespace | http://xml.ir-d.de/emg | | |
| type | restriction of string | | |
| properties | base xs:string | | |
| used by | element OperationEndoprotheseBasis/OEP_GelenkSchluessel | | |
| facets | Kind | Value | Annotation |
| | enumeration | 0212001 | documentation Hüfte |
| | enumeration | 0212002 | documentation Knie |
| | enumeration | 0212003 | documentation Totaler Femurersatz inkl. Durchsteck-Prothese |
| annotation | documentation Kat_EP_Gelenk | | |
| source | <pre> <simpleType name="enum_0212"> <annotation> <documentation>Kat_EP_Gelenk</documentation> </annotation> <restriction base="xs:string"> <enumeration value="0212001"> <annotation> <documentation>Hüfte</documentation> </annotation> </enumeration> <enumeration value="0212002"> <annotation> <documentation>Knie</documentation> </annotation> </enumeration> <enumeration value="0212003"> <annotation> <documentation>Totaler Femurersatz inkl. Durchsteck-Prothese</documentation> </annotation> </enumeration> </restriction> </simpleType> </pre> | | |

simpleType enum_0220

| | | | |
|-----------|------------------------------|--|--|
| namespace | http://xml.ir-d.de/emg | | |
| type | restriction of string | | |

| | | | |
|------------|---|---------|--------------------------------------|
| properties | base xs:string | | |
| used by | element OperationEndoprotheseBasis/OEP_ZugangHuefteSchluessel | | |
| facets | Kind | Value | Annotation |
| | enumeration | 0220001 | documentation anterior |
| | enumeration | 0220002 | documentation anterolateral |
| | enumeration | 0220003 | documentation lateral |
| | enumeration | 0220004 | documentation posterior |
| | enumeration | 0220005 | documentation posterolateral |
| | enumeration | 0220006 | documentation 2-Inzisionen-Zugang |
| | enumeration | 0220042 | documentation sonstiges/unbekannt |
| annotation | documentation Kat_EP_Operationszugang | | |
| source | <pre> <simpleType name="enum_0220"> <annotation> <documentation>Kat_EP_Operationszugang</documentation> </annotation> <restriction base="xs:string"> <enumeration value="0220001"> <annotation> <documentation>anterior</documentation> </annotation> </enumeration> <enumeration value="0220002"> <annotation> <documentation>anterolateral</documentation> </annotation> </enumeration> <enumeration value="0220003"> <annotation> <documentation>lateral</documentation> </annotation> </enumeration> <enumeration value="0220004"> <annotation> <documentation>posterior</documentation> </annotation> </enumeration> <enumeration value="0220005"> <annotation> <documentation>posterolateral</documentation> </annotation> </enumeration> <enumeration value="0220006"> <annotation> <documentation>2-Inzisionen-Zugang</documentation> </annotation> </enumeration> <enumeration value="0220042"> <annotation> <documentation>sonstiges/unbekannt</documentation> </annotation> </enumeration> </restriction> </simpleType> </pre> | | |

| | |
|--|---|
| | <pre> </restriction> </simpleType> </pre> |
|--|---|

simpleType enum_0222

| | | | |
|------------|---|---------|-----------------------------|
| namespace | http://xml.ir-d.de/emg | | |
| type | restriction of string | | |
| properties | base xs:string | | |
| used by | element OperationEndoprotheseBasis/OEP_ZweizeitwechselSchluessel | | |
| facets | Kind | Value | Annotation |
| | enumeration | 0222001 | documentation nein |
| | enumeration | 0222002 | documentation ja- Ausbau |
| | enumeration | 0222003 | documentation ja- Einbau |
| annotation | documentation Kat_EP_Zweizeitwechsel | | |
| source | <pre> <simpleType name="enum_0222"> <annotation> <documentation>Kat_EP_Zweizeitwechsel</documentation> </annotation> <restriction base="xs:string"> <enumeration value="0222001"> <annotation> <documentation>nein</documentation> </annotation> </enumeration> <enumeration value="0222002"> <annotation> <documentation>ja- Ausbau</documentation> </annotation> </enumeration> <enumeration value="0222003"> <annotation> <documentation>ja- Einbau</documentation> </annotation> </enumeration> </restriction> </simpleType> </pre> | | |

simpleType enum_0230

| | | | |
|------------|--|---------|---|
| namespace | http://xml.ir-d.de/emg | | |
| type | restriction of string | | |
| properties | base xs:string | | |
| used by | elements ArtikelEndoprotheseBasis/AEP_HerstellerSchluessel ZubehoerEndoprotheseBasis/ZEP_HerstellerSchluessel | | |
| facets | Kind | Value | Annotation |
| | enumeration | 0230001 | documentation Smith & Nephew GmbH |
| | enumeration | 0230002 | documentation Mathys Orthopädie GmbH |
| | enumeration | 0230003 | documentation |

| | | |
|-------------|---------|---|
| enumeration | 0230004 | Ceramtec AG documentation Biomet |
| enumeration | 0230005 | documentation Peter Brehm GmbH |
| enumeration | 0230006 | documentation Amplitude GmbH |
| enumeration | 0230007 | documentation Exactech Deutschland |
| enumeration | 0230008 | documentation Globus Medical |
| enumeration | 0230009 | documentation Implantcast GmbH |
| enumeration | 0230010 | documentation DePuy Orthopädie GmbH |
| enumeration | 0230011 | documentation IO-International Orthopaedics |
| enumeration | 0230012 | documentation Joint Replacement Ltd. Instrumentation |
| enumeration | 0230013 | documentation Merete |
| enumeration | 0230014 | documentation S&G Implants GmbH |
| enumeration | 0230015 | documentation Speetec Implantate GmbH |
| enumeration | 0230016 | documentation Stemcup Medical Products GmbH |
| enumeration | 0230017 | documentation Symbios Deutschland GmbH |
| enumeration | 0230018 | documentation Tantum AG |
| enumeration | 0230019 | documentation Tomier GmbH |
| enumeration | 0230020 | documentation MicroPort Orthopedics GmbH |
| enumeration | 0230021 | documentation aap Implanate AG |
| enumeration | 0230022 | documentation AQImplants |
| enumeration | 0230023 | documentation ESKA Orthodynamics GmbH |
| enumeration | 0230024 | documentation Ateos medical AG |
| enumeration | 0230025 | documentation Chiropro GmbH |
| enumeration | 0230026 | documentation Medacta |
| enumeration | 0230027 | documentation OHST Medizintechnik AG |
| enumeration | 0230028 | documentation Lima Deutschland GmbH |
| enumeration | 0230029 | documentation alloPlus GmbH |
| enumeration | 0230030 | documentation Heraeus Medical GmbH |
| enumeration | 0230031 | documentation ImplanTec Deutschland GmbH |
| enumeration | 0230032 | documentation Falcon Medical GmbH |
| enumeration | 0230033 | documentation Meril GmbH |
| enumeration | 0230034 | documentation Zimmer Germany GmbH |
| enumeration | 0230035 | documentation Stryker GmbH & Co. KG |

| | |
|------------|--|
| | <p>enumeration 0230036 documentation Aesculap AG</p> <p>enumeration 0230037 documentation Waldemar Link GmbH & Co. KG</p> <p>enumeration 0230038 documentation Corin Gemany GmbH</p> <p>enumeration 0230039 documentation nicht belegter Wert</p> <p>enumeration 0230040 documentation nicht belegter Wert</p> <p>enumeration 0230041 documentation nicht belegter Wert</p> <p>enumeration 0230042 documentation sonstige</p> <p>enumeration 0230043 documentation nicht belegter Wert</p> <p>enumeration 0230044 documentation nicht belegter Wert</p> |
| annotation | documentation Kat_EP_Hersteller |
| source | <pre> <simpleType name="enum_0230"> <annotation> <documentation>Kat_EP_Hersteller</documentation> </annotation> <restriction base="xs:string"> <enumeration value="0230001"> <annotation> <documentation>Smith & Nephew GmbH</documentation> </annotation> </enumeration> <enumeration value="0230002"> <annotation> <documentation>Mathys Orthopädie GmbH</documentation> </annotation> </enumeration> <enumeration value="0230003"> <annotation> <documentation>Ceramtec AG</documentation> </annotation> </enumeration> <enumeration value="0230004"> <annotation> <documentation>Biomet</documentation> </annotation> </enumeration> <enumeration value="0230005"> <annotation> <documentation>Peter Brehm GmbH</documentation> </annotation> </enumeration> <enumeration value="0230006"> <annotation> <documentation>Amplitude GmbH</documentation> </annotation> </enumeration> <enumeration value="0230007"> <annotation> <documentation>Exactech Deutschland</documentation> </annotation> </enumeration> </restriction> </simpleType> </pre> |

```
<enumeration value="0230008">
  <annotation>
    <documentation>Globus Medical</documentation>
  </annotation>
</enumeration>
<enumeration value="0230009">
  <annotation>
    <documentation>Implantcast GmbH</documentation>
  </annotation>
</enumeration>
<enumeration value="0230010">
  <annotation>
    <documentation>DePuy Orthopädie GmbH</documentation>
  </annotation>
</enumeration>
<enumeration value="0230011">
  <annotation>
    <documentation>IO-International Orthopaedics</documentation>
  </annotation>
</enumeration>
<enumeration value="0230012">
  <annotation>
    <documentation>Joint Replacement Ltd. Instrumentation</documentation>
  </annotation>
</enumeration>
<enumeration value="0230013">
  <annotation>
    <documentation>Merete</documentation>
  </annotation>
</enumeration>
<enumeration value="0230014">
  <annotation>
    <documentation>S&G Implants GmbH</documentation>
  </annotation>
</enumeration>
<enumeration value="0230015">
  <annotation>
    <documentation>Speetec Implantate GmbH</documentation>
  </annotation>
</enumeration>
<enumeration value="0230016">
  <annotation>
    <documentation>Stemcup Medical Products GmbH</documentation>
  </annotation>
</enumeration>
<enumeration value="0230017">
  <annotation>
    <documentation>Symbios Deutschland GmbH</documentation>
  </annotation>
</enumeration>
<enumeration value="0230018">
  <annotation>
    <documentation>Tantum AG</documentation>
  </annotation>
</enumeration>
<enumeration value="0230019">
  <annotation>
    <documentation>Tornier GmbH</documentation>
  </annotation>
</enumeration>
```

```
</enumeration>
<enumeration value="0230020">
  <annotation>
    <documentation>MicroPort Orthopedics GmbH</documentation>
  </annotation>
</enumeration>
<enumeration value="0230021">
  <annotation>
    <documentation>aap Implanate AG</documentation>
  </annotation>
</enumeration>
<enumeration value="0230022">
  <annotation>
    <documentation>AQImplants</documentation>
  </annotation>
</enumeration>
<enumeration value="0230023">
  <annotation>
    <documentation>ESKA Orthodynamics GmbH</documentation>
  </annotation>
</enumeration>
<enumeration value="0230024">
  <annotation>
    <documentation>Atesos medical AG</documentation>
  </annotation>
</enumeration>
<enumeration value="0230025">
  <annotation>
    <documentation>Chiropro GmbH</documentation>
  </annotation>
</enumeration>
<enumeration value="0230026">
  <annotation>
    <documentation>Medacta</documentation>
  </annotation>
</enumeration>
<enumeration value="0230027">
  <annotation>
    <documentation>OHST Medizintechnik AG</documentation>
  </annotation>
</enumeration>
<enumeration value="0230028">
  <annotation>
    <documentation>Lima Deutschland GmbH</documentation>
  </annotation>
</enumeration>
<enumeration value="0230029">
  <annotation>
    <documentation>alloPlus GmbH</documentation>
  </annotation>
</enumeration>
<enumeration value="0230030">
  <annotation>
    <documentation>Heraeus Medical GmbH</documentation>
  </annotation>
</enumeration>
<enumeration value="0230031">
  <annotation>
    <documentation>ImplanTec Deutschland GmbH</documentation>
  </annotation>
</enumeration>
```

```
</annotation>
</enumeration>
<enumeration value="0230032">
  <annotation>
    <documentation>Falcon Medical GmbH</documentation>
  </annotation>
</enumeration>
<enumeration value="0230033">
  <annotation>
    <documentation>Meril GmbH</documentation>
  </annotation>
</enumeration>
<enumeration value="0230034">
  <annotation>
    <documentation>Zimmer Germany GmbH</documentation>
  </annotation>
</enumeration>
<enumeration value="0230035">
  <annotation>
    <documentation>Stryker GmbH & Co. KG</documentation>
  </annotation>
</enumeration>
<enumeration value="0230036">
  <annotation>
    <documentation>Aesculap AG</documentation>
  </annotation>
</enumeration>
<enumeration value="0230037">
  <annotation>
    <documentation>Waldemar Link GmbH & Co. KG</documentation>
  </annotation>
</enumeration>
<enumeration value="0230038">
  <annotation>
    <documentation>Corin Germany GmbH</documentation>
  </annotation>
</enumeration>
<enumeration value="0230039">
  <annotation>
    <documentation>nicht belegter Wert</documentation>
  </annotation>
</enumeration>
<enumeration value="0230040">
  <annotation>
    <documentation>nicht belegter Wert</documentation>
  </annotation>
</enumeration>
<enumeration value="0230041">
  <annotation>
    <documentation>nicht belegter Wert</documentation>
  </annotation>
</enumeration>
<enumeration value="0230042">
  <annotation>
    <documentation>sonstige</documentation>
  </annotation>
</enumeration>
<enumeration value="0230043">
  <annotation>
```

| | |
|--|--|
| | <pre> <documentation>nicht belegter Wert</documentation> </annotation> </enumeration> <enumeration value="0230044"> <annotation> <documentation>nicht belegter Wert</documentation> </annotation> </enumeration> </restriction> </simpleType> </pre> |
|--|--|

simpleType enum_0252

| | | | |
|------------|--|---------|-------------------------|
| namespace | http://xml.ir-d.de/emg | | |
| type | restriction of string | | |
| properties | base xs:string | | |
| used by | element OperationEndprotheseBasis/OEP KomponenteHuefteSchluessel | | |
| facets | Kind | Value | Annotation |
| | enumeration | 0252001 | documentation Pfanne |
| | enumeration | 0252002 | documentation Schaft |
| | enumeration | 0252003 | documentation beides |
| annotation | documentation Kat_EP_KomponenteHuefte | | |
| source | <pre> <simpleType name="enum_0252"> <annotation> <documentation>Kat_EP_KomponenteHuefte</documentation> </annotation> <restriction base="xs:string"> <enumeration value="0252001"> <annotation> <documentation>Pfanne</documentation> </annotation> </enumeration> <enumeration value="0252002"> <annotation> <documentation>Schaft</documentation> </annotation> </enumeration> <enumeration value="0252003"> <annotation> <documentation>beides</documentation> </annotation> </enumeration> </restriction> </simpleType> </pre> | | |

simpleType enum_0254

| | |
|-----------|------------------------------|
| namespace | http://xml.ir-d.de/emg |
| type | restriction of string |

| properties | base xs:string | | | | | | | | | | | | | | | |
|-------------|--|--------------------------|-------|------------|-------------|---------|------------------------|-------------|---------|------------------------|-------------|---------|--------------------------|-------------|---------|--------------------------|
| used by | element OperationEndoprotheseBasis/OEP KomponenteKnieSchluessel | | | | | | | | | | | | | | | |
| facets | <table border="1"> <thead> <tr> <th>Kind</th> <th>Value</th> <th>Annotation</th> </tr> </thead> <tbody> <tr> <td>enumeration</td> <td>0254001</td> <td>documentation Femur</td> </tr> <tr> <td>enumeration</td> <td>0254002</td> <td>documentation Tibia</td> </tr> <tr> <td>enumeration</td> <td>0254003</td> <td>documentation Patella</td> </tr> <tr> <td>enumeration</td> <td>0254004</td> <td>documentation mehrere</td> </tr> </tbody> </table> | Kind | Value | Annotation | enumeration | 0254001 | documentation Femur | enumeration | 0254002 | documentation Tibia | enumeration | 0254003 | documentation Patella | enumeration | 0254004 | documentation mehrere |
| Kind | Value | Annotation | | | | | | | | | | | | | | |
| enumeration | 0254001 | documentation Femur | | | | | | | | | | | | | | |
| enumeration | 0254002 | documentation Tibia | | | | | | | | | | | | | | |
| enumeration | 0254003 | documentation Patella | | | | | | | | | | | | | | |
| enumeration | 0254004 | documentation mehrere | | | | | | | | | | | | | | |
| annotation | documentation Kat_EP_KomponenteKnie | | | | | | | | | | | | | | | |
| source | <pre> <simpleType name="enum_0254"> <annotation> <documentation>Kat_EP_KomponenteKnie</documentation> </annotation> <restriction base="xs:string"> <enumeration value="0254001"> <annotation> <documentation>Femur</documentation> </annotation> </enumeration> <enumeration value="0254002"> <annotation> <documentation>Tibia</documentation> </annotation> </enumeration> <enumeration value="0254003"> <annotation> <documentation>Patella</documentation> </annotation> </enumeration> <enumeration value="0254004"> <annotation> <documentation>mehrere</documentation> </annotation> </enumeration> </restriction> </simpleType> </pre> | | | | | | | | | | | | | | | |

simpleType enum 0256

| namespace | http://xml.ir-d.de/emg | | | | | | | | | | | | | | | |
|-------------|---|------------------------------------|-------|------------|-------------|---------|-------------------------|-------------|---------|-------------------------|-------------|---------|------------------------------------|-------------|---------|------------------------|
| type | restriction of string | | | | | | | | | | | | | | | |
| properties | base xs:string | | | | | | | | | | | | | | | |
| used by | element OperationEndoprotheseBasis/OEP KomponenteTfeSchluessel | | | | | | | | | | | | | | | |
| facets | <table border="1"> <thead> <tr> <th>Kind</th> <th>Value</th> <th>Annotation</th> </tr> </thead> <tbody> <tr> <td>enumeration</td> <td>0256001</td> <td>documentation Pfanne</td> </tr> <tr> <td>enumeration</td> <td>0256002</td> <td>documentation Schaft</td> </tr> <tr> <td>enumeration</td> <td>0256003</td> <td>documentation Pfanne und Schaft</td> </tr> <tr> <td>enumeration</td> <td>0256004</td> <td>documentation Femur</td> </tr> </tbody> </table> | Kind | Value | Annotation | enumeration | 0256001 | documentation Pfanne | enumeration | 0256002 | documentation Schaft | enumeration | 0256003 | documentation Pfanne und Schaft | enumeration | 0256004 | documentation Femur |
| Kind | Value | Annotation | | | | | | | | | | | | | | |
| enumeration | 0256001 | documentation Pfanne | | | | | | | | | | | | | | |
| enumeration | 0256002 | documentation Schaft | | | | | | | | | | | | | | |
| enumeration | 0256003 | documentation Pfanne und Schaft | | | | | | | | | | | | | | |
| enumeration | 0256004 | documentation Femur | | | | | | | | | | | | | | |

| | |
|------------|--|
| | enumeration 0256005 documentation Tibia enumeration 0256006 documentation Patella enumeration 0256007 documentation mehrere |
| annotation | documentation Kat_EP_KomponenteTFE |
| source | <pre> <simpleType name="enum_0256"> <annotation> <documentation>Kat_EP_KomponenteTFE</documentation> </annotation> <restriction base="xs:string"> <enumeration value="0256001"> <annotation> <documentation>Pfanne</documentation> </annotation> </enumeration> <enumeration value="0256002"> <annotation> <documentation>Schaft</documentation> </annotation> </enumeration> <enumeration value="0256003"> <annotation> <documentation>Pfanne und Schaft</documentation> </annotation> </enumeration> <enumeration value="0256004"> <annotation> <documentation>Femur</documentation> </annotation> </enumeration> <enumeration value="0256005"> <annotation> <documentation>Tibia</documentation> </annotation> </enumeration> <enumeration value="0256006"> <annotation> <documentation>Patella</documentation> </annotation> </enumeration> <enumeration value="0256007"> <annotation> <documentation>mehrere</documentation> </annotation> </enumeration> </restriction> </simpleType> </pre> |

simpleType enum_0262

| | |
|------------|------------------------------|
| namespace | http://xml.ir-d.de/emg |
| type | restriction of string |
| properties | base xs:string |

| used by | element OperationEndoprotheseBasis/OEP ImplantatbruchHuefteSchlüssel | | | | | | | | | | | | | | | | | | | | | |
|-------------|---|--------------------------|-------|------------|-------------|---------|-------------------------|-------------|---------|-------------------------|-------------|---------|-----------------------|-------------|---------|------------------------|-------------|---------|--------------------------|-------------|---------|--------------------------|
| facets | <table border="1"> <thead> <tr> <th>Kind</th> <th>Value</th> <th>Annotation</th> </tr> </thead> <tbody> <tr> <td>enumeration</td> <td>0262001</td> <td>documentation Pfanne</td> </tr> <tr> <td>enumeration</td> <td>0262002</td> <td>documentation Schaft</td> </tr> <tr> <td>enumeration</td> <td>0262003</td> <td>documentation Kopf</td> </tr> <tr> <td>enumeration</td> <td>0262004</td> <td>documentation Inlay</td> </tr> <tr> <td>enumeration</td> <td>0262005</td> <td>documentation Adapter</td> </tr> <tr> <td>enumeration</td> <td>0262006</td> <td>documentation mehrere</td> </tr> </tbody> </table> | Kind | Value | Annotation | enumeration | 0262001 | documentation Pfanne | enumeration | 0262002 | documentation Schaft | enumeration | 0262003 | documentation Kopf | enumeration | 0262004 | documentation Inlay | enumeration | 0262005 | documentation Adapter | enumeration | 0262006 | documentation mehrere |
| Kind | Value | Annotation | | | | | | | | | | | | | | | | | | | | |
| enumeration | 0262001 | documentation Pfanne | | | | | | | | | | | | | | | | | | | | |
| enumeration | 0262002 | documentation Schaft | | | | | | | | | | | | | | | | | | | | |
| enumeration | 0262003 | documentation Kopf | | | | | | | | | | | | | | | | | | | | |
| enumeration | 0262004 | documentation Inlay | | | | | | | | | | | | | | | | | | | | |
| enumeration | 0262005 | documentation Adapter | | | | | | | | | | | | | | | | | | | | |
| enumeration | 0262006 | documentation mehrere | | | | | | | | | | | | | | | | | | | | |
| annotation | documentation Kat_EP_ImplantatbruchHuefte | | | | | | | | | | | | | | | | | | | | | |
| source | <pre> <simpleType name="enum_0262"> <annotation> <documentation>Kat_EP_ImplantatbruchHuefte</documentation> </annotation> <restriction base="xs:string"> <enumeration value="0262001"> <annotation> <documentation>Pfanne</documentation> </annotation> </enumeration> <enumeration value="0262002"> <annotation> <documentation>Schaft</documentation> </annotation> </enumeration> <enumeration value="0262003"> <annotation> <documentation>Kopf</documentation> </annotation> </enumeration> <enumeration value="0262004"> <annotation> <documentation>Inlay</documentation> </annotation> </enumeration> <enumeration value="0262005"> <annotation> <documentation>Adapter</documentation> </annotation> </enumeration> <enumeration value="0262006"> <annotation> <documentation>mehrere</documentation> </annotation> </enumeration> </restriction> </simpleType> </pre> | | | | | | | | | | | | | | | | | | | | | |

simpleType enum_0264

| | |
|-----------|------------------------|
| namespace | http://xml.ir-d.de/emg |
|-----------|------------------------|

| | | | |
|------------|---|---------|-------------------------------|
| type | restriction of string | | |
| properties | base xs:string | | |
| used by | element OperationEndoprotheseBasis/OEP ImplantatbruchKnieSchlüssel | | |
| facets | Kind | Value | Annotation |
| | enumeration | 0264001 | documentation Femur |
| | enumeration | 0264002 | documentation Tibia |
| | enumeration | 0264003 | documentation Inlay |
| | enumeration | 0264004 | documentation Adapter |
| | enumeration | 0264005 | documentation Verlängerung |
| | enumeration | 0264006 | documentation Schrauben |
| | enumeration | 0264007 | documentation mehrere |
| | enumeration | 0264042 | documentation andere |
| annotation | documentation Kat_EP_ImplantatbruchKnie | | |
| source | <pre> <simpleType name="enum_0264"> <annotation> <documentation>Kat_EP_ImplantatbruchKnie</documentation> </annotation> <restriction base="xs:string"> <enumeration value="0264001"> <annotation> <documentation>Femur</documentation> </annotation> </enumeration> <enumeration value="0264002"> <annotation> <documentation>Tibia</documentation> </annotation> </enumeration> <enumeration value="0264003"> <annotation> <documentation>Inlay</documentation> </annotation> </enumeration> <enumeration value="0264004"> <annotation> <documentation>Adapter</documentation> </annotation> </enumeration> <enumeration value="0264005"> <annotation> <documentation>Verlängerung</documentation> </annotation> </enumeration> <enumeration value="0264006"> <annotation> <documentation>Schrauben</documentation> </annotation> </enumeration> <enumeration value="0264007"> <annotation> </pre> | | |

| | |
|--|---|
| | <pre> <documentation>mehrere</documentation> </annotation> </enumeration> <enumeration value="0264042"> <annotation> <documentation>andere</documentation> </annotation> </enumeration> </restriction> </simpleType> </pre> |
|--|---|

simpleType enum_0266

| | | | |
|------------|--|---------|-------------------------------|
| namespace | http://xml.ir-d.de/emg | | |
| type | restriction of string | | |
| properties | base xs:string | | |
| used by | element OperationEndoprotheseBasis/OEP ImplantatbruchTfeSchluessel | | |
| facets | Kind | Value | Annotation |
| | enumeration | 0266001 | documentation Pfanne |
| | enumeration | 0266002 | documentation Schaft |
| | enumeration | 0266003 | documentation Kopf |
| | enumeration | 0266004 | documentation Inlay |
| | enumeration | 0266005 | documentation Adapter |
| | enumeration | 0266006 | documentation Femur |
| | enumeration | 0266007 | documentation Tibia |
| | enumeration | 0266008 | documentation Verlängerung |
| | enumeration | 0266009 | documentation Schrauben |
| | enumeration | 0266010 | documentation mehrere |
| | enumeration | 0266042 | documentation andere |
| annotation | documentation Kat_EP_ImplantatbruchTFE | | |
| source | <pre> <simpleType name="enum_0266"> <annotation> <documentation>Kat_EP_ImplantatbruchTFE</documentation> </annotation> <restriction base="xs:string"> <enumeration value="0266001"> <annotation> <documentation>Pfanne</documentation> </annotation> </enumeration> <enumeration value="0266002"> <annotation> <documentation>Schaft</documentation> </annotation> </enumeration> <enumeration value="0266003"> </pre> | | |

```

    <annotation>
      <documentation>Kopf</documentation>
    </annotation>
  </enumeration>
  <enumeration value="0266004">
    <annotation>
      <documentation>Inlay</documentation>
    </annotation>
  </enumeration>
  <enumeration value="0266005">
    <annotation>
      <documentation>Adapter</documentation>
    </annotation>
  </enumeration>
  <enumeration value="0266006">
    <annotation>
      <documentation>Femur</documentation>
    </annotation>
  </enumeration>
  <enumeration value="0266007">
    <annotation>
      <documentation>Tibia</documentation>
    </annotation>
  </enumeration>
  <enumeration value="0266008">
    <annotation>
      <documentation>Verlängerung</documentation>
    </annotation>
  </enumeration>
  <enumeration value="0266009">
    <annotation>
      <documentation>Schrauben</documentation>
    </annotation>
  </enumeration>
  <enumeration value="0266010">
    <annotation>
      <documentation>mehrere</documentation>
    </annotation>
  </enumeration>
  <enumeration value="0266042">
    <annotation>
      <documentation>andere</documentation>
    </annotation>
  </enumeration>
</restriction>
</simpleType>

```

simpleType enum_0270

| | | | |
|------------|------------------------------|--|---------------------------|
| namespace | http://xml.ir-d.de/emg | | |
| type | restriction of string | | |
| properties | base xs:string | | |
| used by | element | OperationEndoprotheseBasis/OEP_VerschleissKnieSchluessel | |
| facets | Kind | Value | Annotation |
| | enumeration | 0270001 | documentation PE-Inlay |

| | |
|------------|---|
| | enumeration 0270002 documentation patellare Komponente enumeration 0270003 documentation beides |
| annotation | documentation Kat_EP_VerschleissKnie |
| source | <pre> <simpleType name="enum_0270"> <annotation> <documentation>Kat_EP_VerschleissKnie</documentation> </annotation> <restriction base="xs:string"> <enumeration value="0270001"> <annotation> <documentation>PE-Inlay</documentation> </annotation> </enumeration> <enumeration value="0270002"> <annotation> <documentation>patellare Komponente</documentation> </annotation> </enumeration> <enumeration value="0270003"> <annotation> <documentation>beides</documentation> </annotation> </enumeration> </restriction> </simpleType> </pre> |

simpleType enum_0271

| | | | |
|------------|---|---------|---------------------------------------|
| namespace | http://xml.ir-d.de/emg | | |
| type | restriction of string | | |
| properties | base xs:string | | |
| used by | element OperationEndoprotheseBasis/OEP_MigrationKnieSchluesel | | |
| facets | Kind | Value | Annotation |
| | enumeration | 0271001 | documentation Schraube |
| | enumeration | 0271002 | documentation Inlay |
| | enumeration | 0271003 | documentation patellare Komponente |
| | enumeration | 0271004 | documentation Kopplung |
| | enumeration | 0271005 | documentation mehrere |
| | enumeration | 0271042 | documentation andere |
| annotation | documentation Kat_EP_MigrationKnie | | |
| source | <pre> <simpleType name="enum_0271"> <annotation> <documentation>Kat_EP_MigrationKnie</documentation> </annotation> <restriction base="xs:string"> <enumeration value="0271001"> <annotation> </pre> | | |

| | |
|--|--|
| | <pre> <documentation>Schraube</documentation> </annotation> </enumeration> <enumeration value="0271002"> <annotation> <documentation>Inlay</documentation> </annotation> </enumeration> <enumeration value="0271003"> <annotation> <documentation>patellare Komponente</documentation> </annotation> </enumeration> <enumeration value="0271004"> <annotation> <documentation>Kopplung</documentation> </annotation> </enumeration> <enumeration value="0271005"> <annotation> <documentation>mehrere</documentation> </annotation> </enumeration> <enumeration value="0271042"> <annotation> <documentation>andere</documentation> </annotation> </enumeration> </restriction> </simpleType> </pre> |
|--|--|

simpleType enum_0290

| | | | |
|------------|--|---------|---|
| namespace | http://xml.ir-d.de/emg | | |
| type | restriction of string | | |
| properties | base xs:string | | |
| used by | element ArtikelEndoprotheseBasis/AEP ArtikelTypSchluessel | | |
| facets | Kind | Value | Annotation |
| | enumeration | 0290001 | documentation Hüft-Komponente |
| | enumeration | 0290002 | documentation Knie-Komponente |
| | enumeration | 0290003 | documentation Modulare Komponente (Hüfte/Knie) |
| annotation | documentation Kat_EP_Artikeltyp | | |
| source | <pre> <simpleType name="enum_0290"> <annotation> <documentation>Kat_EP_Artikeltyp</documentation> </annotation> <restriction base="xs:string"> <enumeration value="0290001"> <annotation> <documentation>Hüft-Komponente</documentation> </annotation> </enumeration> </pre> | | |

| | |
|--|--|
| | <pre> <enumeration value="0290002"> <annotation> <documentation>Knie-Komponente</documentation> </annotation> </enumeration> <enumeration value="0290003"> <annotation> <documentation>Modulare Komponente (Hüfte/Knie)</documentation> </annotation> </enumeration> </restriction> </simpleType> </pre> |
|--|--|

simpleType enum_0291

| | | | |
|------------|--|---------|------------------------------------|
| namespace | http://xml.ir-d.de/emg | | |
| type | restriction of string | | |
| properties | base xs:string | | |
| used by | element ZubehoerEndoprotheseBasis/ZEP_ZubehoerTypSchluessel | | |
| facets | Kind | Value | Annotation |
| | enumeration | 0291001 | documentation Knochen-Zement |
| | enumeration | 0291002 | documentation sonstiges Zubehör |
| annotation | documentation Kat_EP_ZubehoerTyp | | |
| source | <pre> <simpleType name="enum_0291"> <annotation> <documentation>Kat_EP_ZubehoerTyp</documentation> </annotation> <restriction base="xs:string"> <enumeration value="0291001"> <annotation> <documentation>Knochen-Zement</documentation> </annotation> </enumeration> <enumeration value="0291002"> <annotation> <documentation>sonstiges Zubehör</documentation> </annotation> </enumeration> </restriction> </simpleType> </pre> | | |

simpleType enum_0300

| | | | |
|------------|--|---------|--|
| namespace | http://xml.ir-d.de/emg | | |
| type | restriction of string | | |
| properties | base xs:string | | |
| used by | element OperationAortenklappeBasis/OAK_ArtEingriffSchluessel | | |
| facets | Kind | Value | Annotation |
| | enumeration | 0300001 | documentation konventioneller Aortenklappenersatz |

| | |
|------------|--|
| | enumeration 030002 documentation kathetergestützte Aortenklappenimplantation (TAVI) |
| annotation | documentation Kat_AK_ArtEingriff |
| source | <pre> <simpleType name="enum_0300"> <annotation> <documentation>Kat_AK_ArtEingriff</documentation> </annotation> <restriction base="xs:string"> <enumeration value="0300001"> <annotation> <documentation>konventonieller Aortenklappenersatz</documentation> </annotation> </enumeration> <enumeration value="0300002"> <annotation> <documentation>kathetergestützte Aortenklappenimplantation (TAVI)</documentation> </annotation> </enumeration> </restriction> </simpleType> </pre> |

simpleType enum_0302

| | | | |
|------------|--|--|---|
| namespace | http://xml.ir-d.de/emg | | |
| type | restriction of string | | |
| properties | base | xs:string | |
| used by | element | OperationAortenklappeBasis/OAK GrundEingriffSchluessel | |
| facets | Kind | Value | Annotation |
| | enumeration | 0302001 | documentation Stenose |
| | enumeration | 0302002 | documentation Insuffizienz |
| | enumeration | 0302003 | documentation Stenose und Insuffizienz |
| annotation | documentation Kat_AK_GrundEingriff | | |
| source | <pre> <simpleType name="enum_0302"> <annotation> <documentation>Kat_AK_GrundEingriff</documentation> </annotation> <restriction base="xs:string"> <enumeration value="0302001"> <annotation> <documentation>Stenose</documentation> </annotation> </enumeration> <enumeration value="0302002"> <annotation> <documentation>Insuffizienz</documentation> </annotation> </enumeration> <enumeration value="0302003"> <annotation> <documentation>Stenose und Insuffizienz</documentation> </annotation> </enumeration> </restriction> </simpleType> </pre> | | |

```

</annotation>
</enumeration>
</restriction>
</simpleType>

```

simpleType enum_0318

| | | | |
|------------|--|---|-------------------------------------|
| namespace | http://xml.ir-d.de/emg | | |
| type | restriction of string | | |
| properties | base xs:string | | |
| used by | element | OperationAortenklappeBasis/OAK ZugangKatheterSchluessel | |
| facets | Kind | Value | Annotation |
| | enumeration | 0318001 | documentation transapikal |
| | enumeration | 0318002 | documentation transaortal |
| | enumeration | 0318003 | documentation transfemoral |
| | enumeration | 0318004 | documentation transaxillär |
| | enumeration | 0318042 | documentation anderer Zugangsweg |
| annotation | documentation Kat_AK_ZugangKatheter | | |
| source | <pre> <simpleType name="enum_0318"> <annotation> <documentation>Kat_AK_ZugangKatheter</documentation> </annotation> <restriction base="xs:string"> <enumeration value="0318001"> <annotation> <documentation>transapikal</documentation> </annotation> </enumeration> <enumeration value="0318002"> <annotation> <documentation>transaortal</documentation> </annotation> </enumeration> <enumeration value="0318003"> <annotation> <documentation>transfemoral</documentation> </annotation> </enumeration> <enumeration value="0318004"> <annotation> <documentation>transaxillär</documentation> </annotation> </enumeration> <enumeration value="0318042"> <annotation> <documentation>anderer Zugangsweg</documentation> </annotation> </enumeration> </restriction> </simpleType> </pre> | | |

simpleType enum_0320

| | | | |
|------------|--|---------|---|
| namespace | http://xml.ir-d.de/emg | | |
| type | restriction of string | | |
| properties | base xs:string | | |
| used by | element OperationAortenklappeBasis/OAK ZugangKonventionellSchluessel | | |
| facets | Kind | Value | Annotation |
| | enumeration | 0320001 | documentation konventionelle Sternotomie |
| | enumeration | 0320002 | documentation partielle Sternotomie |
| | enumeration | 0320003 | documentation parasternaler Zugang |
| | enumeration | 0320042 | documentation anderer Zugangsweg |
| annotation | documentation Kat_AK_ZugangKonventionell | | |
| source | <pre> <simpleType name="enum_0320"> <annotation> <documentation>Kat_AK_ZugangKonventionell</documentation> </annotation> <restriction base="xs:string"> <enumeration value="0320001"> <annotation> <documentation>konventionelle Sternotomie</documentation> </annotation> </enumeration> <enumeration value="0320002"> <annotation> <documentation>partielle Sternotomie</documentation> </annotation> </enumeration> <enumeration value="0320003"> <annotation> <documentation>parasternaler Zugang</documentation> </annotation> </enumeration> <enumeration value="0320042"> <annotation> <documentation>anderer Zugangsweg</documentation> </annotation> </enumeration> </restriction> </simpleType> </pre> | | |

simpleType enum_0322

| | | | |
|------------|--|---------|---------------|
| namespace | http://xml.ir-d.de/emg | | |
| type | restriction of string | | |
| properties | base xs:string | | |
| used by | element PatientenaufnahmeKardiologieBasis/PKA DiabetesSchluessel | | |
| facets | Kind | Value | Annotation |
| | enumeration | 0322001 | documentation |

| | |
|------------|---|
| | enumeration 0322002 nein documentation ja, diätetisch behandelt enumeration 0322003 documentation ja, orale Medikation enumeration 0322004 documentation ja, mit Insulin behandelt enumeration 0322005 documentation ja, unbehandelt enumeration 0322099 documentation unbekannt |
| annotation | documentation Kat AK Diabetes |
| source | <pre> <simpleType name="enum_0322"> <annotation> <documentation>Kat_AK_Diabetes</documentation> </annotation> <restriction base="xs:string"> <enumeration value="0322001"> <annotation> <documentation>nein</documentation> </annotation> </enumeration> <enumeration value="0322002"> <annotation> <documentation>ja, diätetisch behandelt</documentation> </annotation> </enumeration> <enumeration value="0322003"> <annotation> <documentation>ja, orale Medikation</documentation> </annotation> </enumeration> <enumeration value="0322004"> <annotation> <documentation>ja, mit Insulin behandelt</documentation> </annotation> </enumeration> <enumeration value="0322005"> <annotation> <documentation>ja, unbehandelt</documentation> </annotation> </enumeration> <enumeration value="0322099"> <annotation> <documentation>unbekannt</documentation> </annotation> </enumeration> </restriction> </simpleType> </pre> |

simpleType enum_0324

| | |
|------------|--|
| namespace | http://xml.ir-d.de/emg |
| type | restriction of string |
| properties | base xs:string |
| used by | element PatientenaufnahmeKardiologieBasis/PKA_NyhaSchluessel |

| facets | <table border="1"> <thead> <tr> <th>Kind</th> <th>Value</th> <th>Annotation</th> </tr> </thead> <tbody> <tr> <td>enumeration</td> <td>0324001</td> <td>documentation (I): Beschwerdefreiheit, normale körperliche Belastbarkeit</td> </tr> <tr> <td>enumeration</td> <td>0324002</td> <td>documentation (II): Beschwerden bei stärkerer körperlicher Belastung</td> </tr> <tr> <td>enumeration</td> <td>0324003</td> <td>documentation (III): Beschwerden bei leichter körperlicher Belastung</td> </tr> <tr> <td>enumeration</td> <td>0324004</td> <td>documentation (IV): Beschwerden in Ruhe</td> </tr> </tbody> </table> | Kind | Value | Annotation | enumeration | 0324001 | documentation (I): Beschwerdefreiheit, normale körperliche Belastbarkeit | enumeration | 0324002 | documentation (II): Beschwerden bei stärkerer körperlicher Belastung | enumeration | 0324003 | documentation (III): Beschwerden bei leichter körperlicher Belastung | enumeration | 0324004 | documentation (IV): Beschwerden in Ruhe |
|-------------|---|---|-------|------------|-------------|---------|---|-------------|---------|---|-------------|---------|---|-------------|---------|--|
| Kind | Value | Annotation | | | | | | | | | | | | | | |
| enumeration | 0324001 | documentation (I): Beschwerdefreiheit, normale körperliche Belastbarkeit | | | | | | | | | | | | | | |
| enumeration | 0324002 | documentation (II): Beschwerden bei stärkerer körperlicher Belastung | | | | | | | | | | | | | | |
| enumeration | 0324003 | documentation (III): Beschwerden bei leichter körperlicher Belastung | | | | | | | | | | | | | | |
| enumeration | 0324004 | documentation (IV): Beschwerden in Ruhe | | | | | | | | | | | | | | |
| annotation | documentation Kat_AK_NYHA | | | | | | | | | | | | | | | |
| source | <pre> <simpleType name="enum_0324"> <annotation> <documentation>Kat_AK_NYHA</documentation> </annotation> <restriction base="xs:string"> <enumeration value="0324001"> <annotation> <documentation>(I): Beschwerdefreiheit, normale körperliche Belastbarkeit</documentation> </annotation> </enumeration> <enumeration value="0324002"> <annotation> <documentation>(II): Beschwerden bei stärkerer körperlicher Belastung</documentation> </annotation> </enumeration> <enumeration value="0324003"> <annotation> <documentation>(III): Beschwerden bei leichter körperlicher Belastung</documentation> </annotation> </enumeration> <enumeration value="0324004"> <annotation> <documentation>(IV): Beschwerden in Ruhe</documentation> </annotation> </enumeration> </restriction> </simpleType> </pre> | | | | | | | | | | | | | | | |

simpleType enum_0330

| namespace | http://xml.ir-d.de/emg | | | | | | | | | | | | | | | |
|-------------|--|---------------------------------------|-------|------------|-------------|---------|------------------------------|-------------|---------|---------------------------------------|-------------|---------|----------------------------|-------------|---------|----------------------------|
| type | restriction of string | | | | | | | | | | | | | | | |
| properties | base xs:string | | | | | | | | | | | | | | | |
| used by | element ArtikelAortenklappeBasis/AAK_HerstellerSchluessel | | | | | | | | | | | | | | | |
| facets | <table border="1"> <thead> <tr> <th>Kind</th> <th>Value</th> <th>Annotation</th> </tr> </thead> <tbody> <tr> <td>enumeration</td> <td>0330001</td> <td>documentation ATS Medical</td> </tr> <tr> <td>enumeration</td> <td>0330002</td> <td>documentation Edwards Lifesciences</td> </tr> <tr> <td>enumeration</td> <td>0330003</td> <td>documentation Medtronic</td> </tr> <tr> <td>enumeration</td> <td>0330004</td> <td>documentation JenaValve</td> </tr> </tbody> </table> | Kind | Value | Annotation | enumeration | 0330001 | documentation ATS Medical | enumeration | 0330002 | documentation Edwards Lifesciences | enumeration | 0330003 | documentation Medtronic | enumeration | 0330004 | documentation JenaValve |
| Kind | Value | Annotation | | | | | | | | | | | | | | |
| enumeration | 0330001 | documentation ATS Medical | | | | | | | | | | | | | | |
| enumeration | 0330002 | documentation Edwards Lifesciences | | | | | | | | | | | | | | |
| enumeration | 0330003 | documentation Medtronic | | | | | | | | | | | | | | |
| enumeration | 0330004 | documentation JenaValve | | | | | | | | | | | | | | |

| | |
|------------|---|
| | <p>enumeration 0330005 documentation Corcym</p> <p>enumeration 0330006 documentation Abbott Medical / St. Jude</p> <p>enumeration 0330007 documentation Symetis</p> <p>enumeration 0330008 documentation Direct Flow Medical</p> <p>enumeration 0330009 documentation Boston Scientific</p> <p>enumeration 0330010 documentation Artivion</p> <p>enumeration 0330011 documentation Biosensors</p> <p>enumeration 0330012 documentation LivaNova</p> <p>enumeration 0330013 documentation Meril</p> <p>enumeration 0330014 documentation nicht belegter Wert</p> <p>enumeration 0330015 documentation nicht belegter Wert</p> <p>enumeration 0330016 documentation nicht belegter Wert</p> <p>enumeration 0330017 documentation nicht belegter Wert</p> <p>enumeration 0330018 documentation nicht belegter Wert</p> <p>enumeration 0330042 documentation sonstiger Hersteller</p> |
| annotation | documentation Kat_AK_Hersteller |
| source | <pre> <simpleType name="enum_0330"> <annotation> <documentation>Kat_AK_Hersteller</documentation> </annotation> <restriction base="xs:string"> <enumeration value="0330001"> <annotation> <documentation>ATS Medical</documentation> </annotation> </enumeration> <enumeration value="0330002"> <annotation> <documentation>Edwards Lifesciences</documentation> </annotation> </enumeration> <enumeration value="0330003"> <annotation> <documentation>Medtronic</documentation> </annotation> </enumeration> <enumeration value="0330004"> <annotation> <documentation>JenaValve</documentation> </annotation> </enumeration> <enumeration value="0330005"> <annotation> <documentation>Corcym</documentation> </annotation> </enumeration> </restriction> </simpleType> </pre> |

```
<enumeration value="0330006">
  <annotation>
    <documentation>Abbott Medical / St. Jude</documentation>
  </annotation>
</enumeration>
<enumeration value="0330007">
  <annotation>
    <documentation>Symetis</documentation>
  </annotation>
</enumeration>
<enumeration value="0330008">
  <annotation>
    <documentation>Direct Flow Medical</documentation>
  </annotation>
</enumeration>
<enumeration value="0330009">
  <annotation>
    <documentation>Boston Scientific</documentation>
  </annotation>
</enumeration>
<enumeration value="0330010">
  <annotation>
    <documentation>Artivion</documentation>
  </annotation>
</enumeration>
<enumeration value="0330011">
  <annotation>
    <documentation>Biosensors</documentation>
  </annotation>
</enumeration>
<enumeration value="0330012">
  <annotation>
    <documentation>LivaNova</documentation>
  </annotation>
</enumeration>
<enumeration value="0330013">
  <annotation>
    <documentation>Meril</documentation>
  </annotation>
</enumeration>
<enumeration value="0330014">
  <annotation>
    <documentation>nicht belegter Wert</documentation>
  </annotation>
</enumeration>
<enumeration value="0330015">
  <annotation>
    <documentation>nicht belegter Wert</documentation>
  </annotation>
</enumeration>
<enumeration value="0330016">
  <annotation>
    <documentation>nicht belegter Wert</documentation>
  </annotation>
</enumeration>
<enumeration value="0330017">
  <annotation>
    <documentation>nicht belegter Wert</documentation>
  </annotation>
</enumeration>
```

| | |
|--|---|
| | <pre> </enumeration> <enumeration value="0330018"> <annotation> <documentation>nicht belegter Wert</documentation> </annotation> </enumeration> <enumeration value="0330042"> <annotation> <documentation>sonstiger Hersteller</documentation> </annotation> </enumeration> </restriction> </simpleType> </pre> |
|--|---|

simpleType enum_0338

| | | | |
|------------|--|---------|-----------------------------|
| namespace | http://xml.ir-d.de/emg | | |
| type | restriction of string | | |
| properties | base xs:string | | |
| used by | element PciAortenklappeBasis/PCA PciArterienSchluessel | | |
| facets | Kind | Value | Annotation |
| | enumeration | 0338001 | documentation LAD |
| | enumeration | 0338002 | documentation RCA |
| | enumeration | 0338003 | documentation RCX |
| | enumeration | 0338004 | documentation Hauptstamm |
| annotation | documentation Kat_AK_PCIArterien | | |
| source | <pre> <simpleType name="enum_0338"> <annotation> <documentation>Kat_AK_PCIArterien</documentation> </annotation> <restriction base="xs:string"> <enumeration value="0338001"> <annotation> <documentation>LAD</documentation> </annotation> </enumeration> <enumeration value="0338002"> <annotation> <documentation>RCA</documentation> </annotation> </enumeration> <enumeration value="0338003"> <annotation> <documentation>RCX</documentation> </annotation> </enumeration> <enumeration value="0338004"> <annotation> <documentation>Hauptstamm</documentation> </annotation> </enumeration> </restriction> </simpleType> </pre> | | |

| | |
|--|---|
| | <pre> </restriction> </simpleType> </pre> |
|--|---|

simpleType enum_0339

| | | | |
|------------|---|---------|-------------------------|
| namespace | http://xml.ir-d.de/emg | | |
| type | restriction of string | | |
| properties | base xs:string | | |
| used by | element OperationAortenklappeBasis/OAK MessmethodeSchluessel | | |
| facets | Kind | Value | Annotation |
| | enumeration | 0339001 | documentation TEE |
| | enumeration | 0339002 | documentation CT |
| | enumeration | 0339042 | documentation andere |
| annotation | documentation Kat_AK_AnnulusMessmethode | | |
| source | <pre> <simpleType name="enum_0339"> <annotation> <documentation>Kat_AK_AnnulusMessmethode</documentation> </annotation> <restriction base="xs:string"> <enumeration value="0339001"> <annotation> <documentation>TEE</documentation> </annotation> </enumeration> <enumeration value="0339002"> <annotation> <documentation>CT</documentation> </annotation> </enumeration> <enumeration value="0339042"> <annotation> <documentation>andere</documentation> </annotation> </enumeration> </restriction> </simpleType> </pre> | | |

simpleType enum_0341

| | | | |
|------------|--|---------|---|
| namespace | http://xml.ir-d.de/emg | | |
| type | restriction of string | | |
| properties | base xs:string | | |
| used by | element FailureGrundAortenklappeBasis/FAK FailureGrundSchluessel | | |
| facets | Kind | Value | Annotation |
| | enumeration | 0341001 | documentation intraprozedural verstorben |
| | enumeration | 0341002 | documentation Implantation von mehr als einer Prothese |
| | enumeration | 0341003 | documentation |

| | |
|------------|--|
| | enumeration 0341004 documentation gravierende Gefäß- oder Zugangskomplikation (gemäß VARC-3) |
| | enumeration 0341005 documentation erforderlicher chirurgischer oder interventioneller Eingriff wegen einer Klappenfehlfunktion (gemäß VARC-3) |
| | documentation >= große strukturelle kardiale Komplikation (gemäß VARC-3) |
| annotation | documentation Kat_AK_FailureGrund |
| source | <pre> <simpleType name="enum_0341"> <annotation> <documentation>Kat_AK_FailureGrund</documentation> </annotation> <restriction base="xs:string"> <enumeration value="0341001"> <annotation> <documentation>intraprozedural verstorben</documentation> </annotation> </enumeration> <enumeration value="0341002"> <annotation> <documentation>Implantation von mehr als einer Prothese</documentation> </annotation> </enumeration> <enumeration value="0341003"> <annotation> <documentation>gravierende Gefäß- oder Zugangskomplikation (gemäß VARC-3)</documentation> </annotation> </enumeration> <enumeration value="0341004"> <annotation> <documentation>erforderlicher chirurgischer oder interventioneller Eingriff wegen einer Klappenfehlfunktion (gemäß VARC-3)</documentation> </annotation> </enumeration> <enumeration value="0341005"> <annotation> <documentation>&gt;= große strukturelle kardiale Komplikation (gemäß VARC-3)</documentation> </annotation> </enumeration> </restriction> </simpleType> </pre> |

simpleType enum_0342

| | | | |
|------------|---|---------|-----------------------------|
| namespace | http://xml.ir-d.de/emg | | |
| type | restriction of string | | |
| properties | base xs:string | | |
| used by | element TaviAortenklappeBasis/TAK GrundTaviSchluessel | | |
| facets | Kind | Value | Annotation |
| | enumeration | 0342001 | documentation Alter |
| | enumeration | 0342002 | documentation Frailty |
| | enumeration | 0342003 | documentation Hochrisiko |

| | |
|------------|--|
| | enumeration 0342004 documentation Prognose-limitierende Zweiterkrankung enumeration 0342005 documentation Porzellan-Aorta enumeration 0342042 documentation Sonstige |
| annotation | documentation Kat_AK_Tavi |
| source | <pre> <simpleType name="enum_0342"> <annotation> <documentation>Kat_AK_Tavi</documentation> </annotation> <restriction base="xs:string"> <enumeration value="0342001"> <annotation> <documentation>Alter</documentation> </annotation> </enumeration> <enumeration value="0342002"> <annotation> <documentation>Frailty</documentation> </annotation> </enumeration> <enumeration value="0342003"> <annotation> <documentation>Hochrisiko</documentation> </annotation> </enumeration> <enumeration value="0342004"> <annotation> <documentation>Prognose-limitierende Zweiterkrankung</documentation> </annotation> </enumeration> <enumeration value="0342005"> <annotation> <documentation>Porzellan-Aorta</documentation> </annotation> </enumeration> <enumeration value="0342042"> <annotation> <documentation>Sonstige</documentation> </annotation> </enumeration> </restriction> </simpleType> </pre> |

simpleType enum 0343

| | | | |
|------------|---|---------|--|
| namespace | http://xml.ir-d.de/emg | | |
| type | restriction of string | | |
| properties | base xs:string | | |
| used by | element KomplikationAortenklappeBasis/KAK KomplikationTypSchluessel | | |
| facets | Kind | Value | Annotation |
| | enumeration | 0343001 | documentation Device-Fehlpositionierung |
| | enumeration | 0343002 | documentation |

| | |
|------------|---|
| | <p>enumeration 0343003 Koronarostienverschluss documentation Aortendissektion</p> <p>enumeration 0343004 documentation Aortenregurgitation &gt; = 2. Grades</p> <p>enumeration 0343005 documentation Annulus-Ruptur</p> <p>enumeration 0343006 documentation Ruptur-/Perforation einer Herzhöhle ohne Therapiebedarf</p> <p>enumeration 0343007 documentation Ruptur-/Perforation einer Herzhöhle mit Therapiebedarf</p> <p>enumeration 0343008 documentation Perikardtamponade</p> <p>enumeration 0343009 documentation kardiale Dekompensation</p> <p>enumeration 0343010 documentation Himembolie</p> <p>enumeration 0343011 documentation Rhythmusstörungen</p> <p>enumeration 0343012 documentation Device-Embolisation</p> <p>enumeration 0343013 documentation vaskuläre Komplikation</p> <p>enumeration 0343014 documentation Low Cardiac Output</p> <p>enumeration 0343015 documentation schwerwiegende Blutungen (intraprozedural)</p> <p>enumeration 0343016 documentation lebensbedrohliche Blutungen (intraprozedural)</p> <p>enumeration 0343017 documentation Patient verstarb im OP/Katheterlabor</p> <p>enumeration 0343042 documentation sonstige intraprozedurale Komplikationen</p> |
| annotation | documentation Kat_AK_KomplikationTyp |
| source | <pre> <simpleType name="enum_0343"> <annotation> <documentation>Kat_AK_KomplikationTyp</documentation> </annotation> <restriction base="xs:string"> <enumeration value="0343001"> <annotation> <documentation>Device-Fehlpositionierung</documentation> </annotation> </enumeration> <enumeration value="0343002"> <annotation> <documentation>Koronarostienverschluss</documentation> </annotation> </enumeration> <enumeration value="0343003"> <annotation> <documentation>Aortendissektion</documentation> </annotation> </enumeration> <enumeration value="0343004"> <annotation> <documentation>Aortenregurgitation &gt; = 2. Grades</documentation> </annotation> </enumeration> <enumeration value="0343005"> <annotation> </pre> |

```

    <documentation>Annulus-Ruptur</documentation>
  </annotation>
</enumeration>
<enumeration value="0343006">
  <annotation>
    <documentation>Ruptur-/Perforation einer Herzhöhle ohne
Therapiebedarf</documentation>
  </annotation>
</enumeration>
<enumeration value="0343007">
  <annotation>
    <documentation>Ruptur-/Perforation einer Herzhöhle mit
Therapiebedarf</documentation>
  </annotation>
</enumeration>
<enumeration value="0343008">
  <annotation>
    <documentation>Perikardtamponade</documentation>
  </annotation>
</enumeration>
<enumeration value="0343009">
  <annotation>
    <documentation>kardiale Dekompensation</documentation>
  </annotation>
</enumeration>
<enumeration value="0343010">
  <annotation>
    <documentation>Hirnembolie</documentation>
  </annotation>
</enumeration>
<enumeration value="0343011">
  <annotation>
    <documentation>Rhythmusstörungen</documentation>
  </annotation>
</enumeration>
<enumeration value="0343012">
  <annotation>
    <documentation>Device-Embolisation</documentation>
  </annotation>
</enumeration>
<enumeration value="0343013">
  <annotation>
    <documentation>vaskuläre Komplikation</documentation>
  </annotation>
</enumeration>
<enumeration value="0343014">
  <annotation>
    <documentation>Low Cardiac Output</documentation>
  </annotation>
</enumeration>
<enumeration value="0343015">
  <annotation>
    <documentation>schwerwiegende Blutungen
(intraprozedural)</documentation>
  </annotation>
</enumeration>
<enumeration value="0343016">
  <annotation>
    <documentation>lebensbedrohliche Blutungen

```

| | |
|--|--|
| | <pre> (intraprozedural)</documentation> </annotation> </enumeration> <enumeration value="0343017"> <annotation> <documentation>Patient verstarb im OP/Katheterlabor</documentation> </annotation> </enumeration> <enumeration value="0343042"> <annotation> <documentation>sonstige intraprozedurale Komplikationen</documentation> </annotation> </enumeration> </restriction> </simpleType> </pre> |
|--|--|

simpleType enum 0346

| | | | |
|------------|--|---------|--|
| namespace | http://xml.ir-d.de/emg | | |
| type | restriction of string | | |
| properties | base xs:string | | |
| used by | element OperationAortenklappeBasis/OAK TherapieLcoSchluessel | | |
| facets | Kind | Value | Annotation |
| | enumeration | 0346001 | documentation keine Therapie erforderlich |
| | enumeration | 0346002 | documentation medikamentös |
| | enumeration | 0346003 | documentation IABP |
| | enumeration | 0346004 | documentation VAD |
| | enumeration | 0346005 | documentation ECMO |
| | enumeration | 0346042 | documentation sonstige |
| annotation | documentation Kat_AK_TherapieLCO | | |
| source | <pre> <simpleType name="enum_0346"> <annotation> <documentation>Kat_AK_TherapieLCO</documentation> </annotation> <restriction base="xs:string"> <enumeration value="0346001"> <annotation> <documentation>keine Therapie erforderlich</documentation> </annotation> </enumeration> <enumeration value="0346002"> <annotation> <documentation>medikamentös</documentation> </annotation> </enumeration> <enumeration value="0346003"> <annotation> <documentation>IABP</documentation> </annotation> </pre> | | |

| | |
|--|---|
| | <pre> </enumeration> <enumeration value="0346004"> <annotation> <documentation>VAD</documentation> </annotation> </enumeration> <enumeration value="0346005"> <annotation> <documentation>ECMO</documentation> </annotation> </enumeration> <enumeration value="0346042"> <annotation> <documentation>sonstige</documentation> </annotation> </enumeration> </restriction> </simpleType> </pre> |
|--|---|

simpleType enum_0347

| | | | |
|------------|---|---------|---|
| namespace | http://xml.ir-d.de/emg | | |
| type | restriction of string | | |
| properties | base xs:string | | |
| used by | element OperationAortenklappeBasis/OAK EingriffsumfangSchluessel | | |
| facets | Kind | Value | Annotation |
| | enumeration | 0347001 | documentation Einzeleingriff |
| | enumeration | 0347002 | documentation Kombinationseingriff mit mehreren Prozeduren |
| annotation | documentation Kat_AK_Eingriffsumfang | | |
| source | <pre> <simpleType name="enum_0347"> <annotation> <documentation>Kat_AK_Eingriffsumfang</documentation> </annotation> <restriction base="xs:string"> <enumeration value="0347001"> <annotation> <documentation>Einzeleingriff</documentation> </annotation> </enumeration> <enumeration value="0347002"> <annotation> <documentation>Kombinationseingriff mit mehreren Prozeduren</documentation> </annotation> </enumeration> </restriction> </simpleType> </pre> | | |

simpleType enum_0348

| | |
|-----------|------------------------|
| namespace | http://xml.ir-d.de/emg |
|-----------|------------------------|

| type | restriction of string | | | | | | | | | | | | |
|-------------|---|---|-------|------------|-------------|---------|--------------------------|-------------|---------|---------------------------|-------------|---------|---|
| properties | base xs:string | | | | | | | | | | | | |
| used by | element OperationAortenklappeBasis/OAK VorgehenSchluessel | | | | | | | | | | | | |
| facets | <table border="1"> <thead> <tr> <th>Kind</th> <th>Value</th> <th>Annotation</th> </tr> </thead> <tbody> <tr> <td>enumeration</td> <td>0348001</td> <td>documentation mit HLM</td> </tr> <tr> <td>enumeration</td> <td>0348002</td> <td>documentation ohne HLM</td> </tr> <tr> <td>enumeration</td> <td>0348003</td> <td>documentation Umstieg von OP ohne HLM auf OP mit HLM</td> </tr> </tbody> </table> | Kind | Value | Annotation | enumeration | 0348001 | documentation mit HLM | enumeration | 0348002 | documentation ohne HLM | enumeration | 0348003 | documentation Umstieg von OP ohne HLM auf OP mit HLM |
| Kind | Value | Annotation | | | | | | | | | | | |
| enumeration | 0348001 | documentation mit HLM | | | | | | | | | | | |
| enumeration | 0348002 | documentation ohne HLM | | | | | | | | | | | |
| enumeration | 0348003 | documentation Umstieg von OP ohne HLM auf OP mit HLM | | | | | | | | | | | |
| annotation | documentation Kat_AK_OPVorgehen | | | | | | | | | | | | |
| source | <pre> <simpleType name="enum_0348"> <annotation> <documentation>Kat_AK_OPVorgehen</documentation> </annotation> <restriction base="xs:string"> <enumeration value="0348001"> <annotation> <documentation>mit HLM</documentation> </annotation> </enumeration> <enumeration value="0348002"> <annotation> <documentation>ohne HLM</documentation> </annotation> </enumeration> <enumeration value="0348003"> <annotation> <documentation>Umstieg von OP ohne HLM auf OP mit HLM</documentation> </annotation> </enumeration> </restriction> </simpleType> </pre> | | | | | | | | | | | | |

simpleType **enum_0350**

| namespace | http://xml.ir-d.de/emg | | | | | | | | | | | | | | | | | | |
|-------------|---|--------------------------|-------|------------|-------------|---------|-----------------------|-------------|---------|--------------------------|-------------|---------|--------------------------|-------------|---------|--------------------------|-------------|---------|-------------------------|
| type | restriction of string | | | | | | | | | | | | | | | | | | |
| properties | base xs:string | | | | | | | | | | | | | | | | | | |
| used by | elements OperationAortenklappeBasis/OAK IntraOpMethodeSchluessel OperationAortenklappeBasis/OAK PraeOpMethodeSchluessel | | | | | | | | | | | | | | | | | | |
| facets | <table border="1"> <thead> <tr> <th>Kind</th> <th>Value</th> <th>Annotation</th> </tr> </thead> <tbody> <tr> <td>enumeration</td> <td>0350001</td> <td>documentation IABP</td> </tr> <tr> <td>enumeration</td> <td>0350002</td> <td>documentation Impella</td> </tr> <tr> <td>enumeration</td> <td>0350003</td> <td>documentation vv ECMO</td> </tr> <tr> <td>enumeration</td> <td>0350004</td> <td>documentation va ECMO</td> </tr> <tr> <td>enumeration</td> <td>0350042</td> <td>documentation andere</td> </tr> </tbody> </table> | Kind | Value | Annotation | enumeration | 0350001 | documentation IABP | enumeration | 0350002 | documentation Impella | enumeration | 0350003 | documentation vv ECMO | enumeration | 0350004 | documentation va ECMO | enumeration | 0350042 | documentation andere |
| Kind | Value | Annotation | | | | | | | | | | | | | | | | | |
| enumeration | 0350001 | documentation IABP | | | | | | | | | | | | | | | | | |
| enumeration | 0350002 | documentation Impella | | | | | | | | | | | | | | | | | |
| enumeration | 0350003 | documentation vv ECMO | | | | | | | | | | | | | | | | | |
| enumeration | 0350004 | documentation va ECMO | | | | | | | | | | | | | | | | | |
| enumeration | 0350042 | documentation andere | | | | | | | | | | | | | | | | | |
| annotation | documentation Kat_AK_Methode | | | | | | | | | | | | | | | | | | |
| source | <pre> <simpleType name="enum_0350"> </pre> | | | | | | | | | | | | | | | | | | |

```

<annotation>
  <documentation>Kat_AK_Methode</documentation>
</annotation>
<restriction base="xs:string">
  <enumeration value="0350001">
    <annotation>
      <documentation>IABP</documentation>
    </annotation>
  </enumeration>
  <enumeration value="0350002">
    <annotation>
      <documentation>Impella</documentation>
    </annotation>
  </enumeration>
  <enumeration value="0350003">
    <annotation>
      <documentation>vv ECMO</documentation>
    </annotation>
  </enumeration>
  <enumeration value="0350004">
    <annotation>
      <documentation>va ECMO</documentation>
    </annotation>
  </enumeration>
  <enumeration value="0350042">
    <annotation>
      <documentation>andere</documentation>
    </annotation>
  </enumeration>
</restriction>
</simpleType>

```

simpleType **enum_0351**

| | | | |
|------------|------------------------------|---|---|
| namespace | http://xml.ir-d.de/emg | | |
| type | restriction of string | | |
| properties | base xs:string | | |
| used by | element | OperationAortenklappeBasis/OAK KonversionSchluessel | |
| facets | Kind | Value | Annotation |
| | enumeration | 0351001 | documentation nein |
| | enumeration | 0351002 | documentation ja, zu Stenotomie |
| | enumeration | 0351003 | documentation ja, zu transapikal |
| | enumeration | 0351004 | documentation ja, zu transaortal |
| | enumeration | 0351005 | documentation ja, zu transfemoral |
| | enumeration | 0351006 | documentation ja, zu transaxillär |
| | enumeration | 0351007 | documentation ja, zu anderem endovaskulären Zugang |
| | enumeration | 0351042 | documentation ja, zu anderem Zugang |
| annotation | documentation | Kat_AK_Konversion | |

| | |
|--------|---|
| source | <pre> <simpleType name="enum_0351"> <annotation> <documentation>Kat_AK_Konversion</documentation> </annotation> <restriction base="xs:string"> <enumeration value="0351001"> <annotation> <documentation>nein</documentation> </annotation> </enumeration> <enumeration value="0351002"> <annotation> <documentation>ja, zu Sternotomie</documentation> </annotation> </enumeration> <enumeration value="0351003"> <annotation> <documentation>ja, zu transapikal</documentation> </annotation> </enumeration> <enumeration value="0351004"> <annotation> <documentation>ja, zu transaortal</documentation> </annotation> </enumeration> <enumeration value="0351005"> <annotation> <documentation>ja, zu transfemoral</documentation> </annotation> </enumeration> <enumeration value="0351006"> <annotation> <documentation>ja, zu transaxillär</documentation> </annotation> </enumeration> <enumeration value="0351007"> <annotation> <documentation>ja, zu anderem endovaskulären Zugang</documentation> </annotation> </enumeration> <enumeration value="0351042"> <annotation> <documentation>ja, zu anderem Zugang</documentation> </annotation> </enumeration> </restriction> </simpleType> </pre> |
|--------|---|

simpleType enum_0352

| | | | |
|------------|------------------------------|--|-----------------------------|
| namespace | http://xml.lir-d.de/emg | | |
| type | restriction of string | | |
| properties | base xs:string | | |
| used by | element | OperationAortenklappeBasis/OAK AnaesthesieSchluessel | |
| facets | Kind enumeration | Value 0352001 | Annotation documentation |

| | |
|------------|---|
| | <p>enumeration 0352002 nein documentation ja, Intubationsnarkose</p> <p>enumeration 0352003 documentation ja, Maskenbeatmung, incl. LAMA</p> <p>enumeration 0352042 documentation ja, unbekannt welche</p> |
| annotation | documentation Kat_AK_Anaesthesie |
| source | <pre><simpleType name="enum_0352"> <annotation> <documentation>Kat_AK_Anaesthesie</documentation> </annotation> <restriction base="xs:string"> <enumeration value="0352001"> <annotation> <documentation>nein</documentation> </annotation> </enumeration> <enumeration value="0352002"> <annotation> <documentation>ja, Intubationsnarkose</documentation> </annotation> </enumeration> <enumeration value="0352003"> <annotation> <documentation>ja, Maskenbeatmung, incl. LAMA</documentation> </annotation> </enumeration> <enumeration value="0352042"> <annotation> <documentation>ja, unbekannt welche</documentation> </annotation> </enumeration> </restriction> </simpleType></pre> |

simpleType enum_0353

| | | | |
|------------|--|---------|-----------------------------------|
| namespace | http://xml.ir-d.de/emg | | |
| type | restriction of string | | |
| properties | base xs:string | | |
| used by | element OperationAortenklappeBasis/OAK ResidualeInsuffizienzSchluessel | | |
| facets | Kind | Value | Annotation |
| | enumeration | 0353001 | documentation keine |
| | enumeration | 0353002 | documentation leichtgradig |
| | enumeration | 0353003 | documentation mittelgradig |
| | enumeration | 0353004 | documentation hochgradig |
| | enumeration | 0353099 | documentation nicht bestimmbar |
| annotation | documentation Kat_AK_ResidualeAorteninsuffizienz | | |
| source | <simpleType name="enum_0353"> | | |

| | |
|--|--|
| | <pre> <annotation> <documentation>Kat_AK_ResidualeAorteninsuffizienz</documentation> </annotation> <restriction base="xs:string"> <enumeration value="0353001"> <annotation> <documentation>keine</documentation> </annotation> </enumeration> <enumeration value="0353002"> <annotation> <documentation>leichtgradig</documentation> </annotation> </enumeration> <enumeration value="0353003"> <annotation> <documentation>mittelgradig</documentation> </annotation> </enumeration> <enumeration value="0353004"> <annotation> <documentation>hochgradig</documentation> </annotation> </enumeration> <enumeration value="0353099"> <annotation> <documentation>nicht bestimmbar</documentation> </annotation> </enumeration> </restriction> </simpleType> </pre> |
|--|--|

simpleType enum_0354

| | | | |
|------------|---|--|------------------------------------|
| namespace | http://xml.ir-d.de/emg | | |
| type | restriction of string | | |
| properties | base xs:string | | |
| used by | element | OperationAortenklappeBasis/OAK ZugangVerschlussSchlussel | |
| facets | Kind | Value | Annotation |
| | enumeration | 0354001 | documentation chirurgisch-offen |
| | enumeration | 0354002 | documentation Verschluss-System |
| | enumeration | 0354042 | documentation sonstige |
| annotation | documentation | Kat_AK_Zugangswegverschluss | |
| source | <pre> <simpleType name="enum_0354"> <annotation> <documentation>Kat_AK_Zugangswegverschluss</documentation> </annotation> <restriction base="xs:string"> <enumeration value="0354001"> <annotation> <documentation>chirurgisch-offen</documentation> </annotation> </enumeration> </restriction> </simpleType> </pre> | | |

| | |
|--|---|
| | <pre> </enumeration> <enumeration value="0354002"> <annotation> <documentation>Verschluss-System</documentation> </annotation> </enumeration> <enumeration value="0354042"> <annotation> <documentation>sonstige</documentation> </annotation> </enumeration> </restriction> </simpleType> </pre> |
|--|---|

simpleType enum_0357

| | | | |
|------------|--|---------|--|
| namespace | http://xml.ir-d.de/emg | | |
| type | restriction of string | | |
| properties | base xs:string | | |
| used by | element PatientenaufnahmeAortenklappeBasis/PAA BefundSchluessel | | |
| facets | Kind | Value | Annotation |
| | enumeration | 0357001 | documentation keine KHK |
| | enumeration | 0357002 | documentation 1-Gefäßerkrankung |
| | enumeration | 0357003 | documentation 2-Gefäßerkrankung |
| | enumeration | 0357004 | documentation 3-Gefäßerkrankung |
| | enumeration | 0357005 | documentation keine koronare Bildgebung |
| annotation | documentation Kat_AK_BefundBildgebung | | |
| source | <pre> <simpleType name="enum_0357"> <annotation> <documentation>Kat_AK_BefundBildgebung</documentation> </annotation> <restriction base="xs:string"> <enumeration value="0357001"> <annotation> <documentation>keine KHK</documentation> </annotation> </enumeration> <enumeration value="0357002"> <annotation> <documentation>1-Gefäßerkrankung</documentation> </annotation> </enumeration> <enumeration value="0357003"> <annotation> <documentation>2-Gefäßerkrankung</documentation> </annotation> </enumeration> <enumeration value="0357004"> <annotation> <documentation>3-Gefäßerkrankung</documentation> </annotation> </enumeration> </restriction> </simpleType> </pre> | | |

| | |
|--|---|
| | <pre> </annotation> </enumeration> <enumeration value="0357005"> <annotation> <documentation>keine koronare Bildgebung</documentation> </annotation> </enumeration> </restriction> </simpleType> </pre> |
|--|---|

simpleType enum_0358

| | | | |
|------------|--|---------|---|
| namespace | http://xml.ir-d.de/emg | | |
| type | restriction of string | | |
| properties | base xs:string | | |
| used by | element PatientenaufnahmeAortenklappeBasis/PAA_AnzahlVorOpSchluessel | | |
| facets | Kind | Value | Annotation |
| | enumeration | 0358001 | documentation 0 |
| | enumeration | 0358002 | documentation 1 |
| | enumeration | 0358003 | documentation 2 |
| | enumeration | 0358004 | documentation 3 |
| | enumeration | 0358005 | documentation 4 |
| | enumeration | 0358006 | documentation 5 oder mehr |
| | enumeration | 0358098 | documentation genaue Anzahl unbekannt (aber mind. 1) |
| | enumeration | 0358099 | documentation unbekannt |
| annotation | documentation Kat_AK_AnzahlVorOP | | |
| source | <pre> <simpleType name="enum_0358"> <annotation> <documentation>Kat_AK_AnzahlVorOP</documentation> </annotation> <restriction base="xs:string"> <enumeration value="0358001"> <annotation> <documentation>0</documentation> </annotation> </enumeration> <enumeration value="0358002"> <annotation> <documentation>1</documentation> </annotation> </enumeration> <enumeration value="0358003"> <annotation> <documentation>2</documentation> </annotation> </enumeration> <enumeration value="0358004"> <annotation> </pre> | | |

| | |
|--|--|
| | <pre> <documentation>3</documentation> </annotation> </enumeration> <enumeration value="0358005"> <annotation> <documentation>4</documentation> </annotation> </enumeration> <enumeration value="0358006"> <annotation> <documentation>5 oder mehr</documentation> </annotation> </enumeration> <enumeration value="0358098"> <annotation> <documentation>genaue Anzahl unbekannt (aber mind. 1)</documentation> </annotation> </enumeration> <enumeration value="0358099"> <annotation> <documentation>unbekannt</documentation> </annotation> </enumeration> </restriction> </simpleType> </pre> |
|--|--|

simpleType enum_0359

| | | | |
|------------|--|---|----------------------------------|
| namespace | http://xml.ir-d.de/emg | | |
| type | restriction of string | | |
| properties | base xs:string | | |
| used by | element | PatientenaufnahmeAortenklappeBasis/PAA LvotSchluessel | |
| facets | Kind | Value | Annotation |
| | enumeration | 0359001 | documentation nein |
| | enumeration | 0359002 | documentation ja - einseitig |
| | enumeration | 0359003 | documentation ja - beidseitig |
| | enumeration | 0359042 | documentation unbekannt |
| annotation | documentation Kat_AK_LVOT | | |
| source | <pre> <simpleType name="enum_0359"> <annotation> <documentation>Kat_AK_LVOT</documentation> </annotation> <restriction base="xs:string"> <enumeration value="0359001"> <annotation> <documentation>nein</documentation> </annotation> </enumeration> <enumeration value="0359002"> <annotation> <documentation>ja - einseitig</documentation> </annotation> </enumeration> </restriction> </simpleType> </pre> | | |

| | |
|--|--|
| | <pre> </annotation> </enumeration> <enumeration value="0359003"> <annotation> <documentation>ja - beidseitig</documentation> </annotation> </enumeration> <enumeration value="0359042"> <annotation> <documentation>unbekannt</documentation> </annotation> </enumeration> </restriction> </simpleType> </pre> |
|--|--|

simpleType enum_0360

| | | | |
|------------|--|--|-------------------------------|
| namespace | http://xml.lir-d.de/emg | | |
| type | restriction of string | | |
| properties | base xs:string | | |
| used by | elements | PatientenaufnahmeAortenklappeBasis/PAA TrikuspidalinsuffizienzSchluessel PostoperationAortenklappeBasis/POA TrikuspidalinsuffizienzSchluessel | |
| facets | Kind | Value | Annotation |
| | enumeration | 0360001 | documentation keine |
| | enumeration | 0360002 | documentation leichtgradig |
| | enumeration | 0360003 | documentation mittelgradig |
| | enumeration | 0360004 | documentation hochgradig |
| | enumeration | 0360005 | documentation massive |
| | enumeration | 0360006 | documentation torrential |
| | enumeration | 0360099 | documentation unbekannt |
| annotation | documentation Kat_AK_TriskupidalInsuffizienz | | |
| source | <pre> <simpleType name="enum_0360"> <annotation> <documentation>Kat_AK_TriskupidalInsuffizienz</documentation> </annotation> <restriction base="xs:string"> <enumeration value="0360001"> <annotation> <documentation>keine</documentation> </annotation> </enumeration> <enumeration value="0360002"> <annotation> <documentation>leichtgradig</documentation> </annotation> </enumeration> <enumeration value="0360003"> <annotation> <documentation>mittelgradig</documentation> </annotation> </enumeration> </restriction> </simpleType> </pre> | | |

```

</enumeration>
<enumeration value="0360004">
  <annotation>
    <documentation>hochgradig</documentation>
  </annotation>
</enumeration>
<enumeration value="0360005">
  <annotation>
    <documentation>massive</documentation>
  </annotation>
</enumeration>
<enumeration value="0360006">
  <annotation>
    <documentation>torrential</documentation>
  </annotation>
</enumeration>
<enumeration value="0360099">
  <annotation>
    <documentation>unbekannt</documentation>
  </annotation>
</enumeration>
</restriction>
</simpleType>

```

simpleType **enum_0361**

| | | | |
|------------|--|---------|---|
| namespace | http://xml.ir-d.de/emg | | |
| type | restriction of string | | |
| properties | base xs:string | | |
| used by | elements PatientenaufnahmeAortenklappeBasis/PAA DekompensationSchluessel PatientenaufnahmeAortenklappeBasis/PAA ReanimationSchluessel | | |
| facets | Kind | Value | Annotation |
| | enumeration | 0361001 | documentation nein |
| | enumeration | 0361002 | documentation ja, letzte(r) innerhalb der letzten 48 Stunden |
| | enumeration | 0361003 | documentation ja, letzte(r) innerhalb der letzten 21 Tage |
| | enumeration | 0361004 | documentation ja, letzte(r) länger als 21 Tage |
| | enumeration | 0361098 | documentation ja, letzter Zeitpunkt unbekannt |
| | enumeration | 0361099 | documentation unbekannt |
| annotation | documentation Kat_AK_SchockReanimation | | |
| source | <pre> <simpleType name="enum_0361"> <annotation> <documentation>Kat_AK_SchockReanimation</documentation> </annotation> <restriction base="xs:string"> <enumeration value="0361001"> <annotation> <documentation>nein</documentation> </annotation> </enumeration> <enumeration value="0361002"> </pre> | | |

| | |
|--|--|
| | <pre> <annotation> <documentation>ja, letzte(r) innerhalb der letzten 48 Stunden</documentation> </annotation> </enumeration> <enumeration value="0361003"> <annotation> <documentation>ja, letzte(r) innerhalb der letzten 21 Tage</documentation> </annotation> </enumeration> <enumeration value="0361004"> <annotation> <documentation>ja, letzte(r) länger als 21 Tage</documentation> </annotation> </enumeration> <enumeration value="0361098"> <annotation> <documentation>ja, letzter Zeitpunkt unbekannt</documentation> </annotation> </enumeration> <enumeration value="0361099"> <annotation> <documentation>unbekannt</documentation> </annotation> </enumeration> </restriction> </simpleType> </pre> |
|--|--|

simpleType enum_0362

| | | | |
|------------|---|--|---------------------------------------|
| namespace | http://xml.ir-d.de/emg | | |
| type | restriction of string | | |
| properties | base xs:string | | |
| used by | element | PatientenaufnahmeAortenklappeBasis/PAA_HerzrhythmusSchlüssel | |
| facets | Kind | Value | Annotation |
| | enumeration | 0362001 | documentation Sinusrhythmus |
| | enumeration | 0362002 | documentation Vorhofflimmern |
| | enumeration | 0362042 | documentation anderer Herzrhythmus |
| annotation | documentation Kat_AK_Herzrhythmus | | |
| source | <pre> <simpleType name="enum_0362"> <annotation> <documentation>Kat_AK_Herzrhythmus</documentation> </annotation> <restriction base="xs:string"> <enumeration value="0362001"> <annotation> <documentation>Sinusrhythmus</documentation> </annotation> </enumeration> <enumeration value="0362002"> <annotation> </pre> | | |

| | |
|--|--|
| | <pre> <documentation>Vorhofflimmern</documentation> </annotation> </enumeration> <enumeration value="0362042"> <annotation> <documentation>anderer Herzrhythmus</documentation> </annotation> </enumeration> </restriction> </simpleType> </pre> |
|--|--|

simpleType enum_0363

| | | | |
|------------|--|---------|--------------------------------|
| namespace | http://xml.ir-d.de/emg | | |
| type | restriction of string | | |
| properties | base xs:string | | |
| used by | element PatientenaufnahmeAortenklappeBasis/PAA_VorhofflimmernSchluessel | | |
| facets | Kind | Value | Annotation |
| | enumeration | 0363001 | documentation nein |
| | enumeration | 0363002 | documentation paroxysmal |
| | enumeration | 0363003 | documentation persistierend |
| | enumeration | 0363004 | documentation permanent |
| annotation | documentation Kat_AK_Vorhofflimmern | | |
| source | <pre> <simpleType name="enum_0363"> <annotation> <documentation>Kat_AK_Vorhofflimmern</documentation> </annotation> <restriction base="xs:string"> <enumeration value="0363001"> <annotation> <documentation>nein</documentation> </annotation> </enumeration> <enumeration value="0363002"> <annotation> <documentation>paroxysmal</documentation> </annotation> </enumeration> <enumeration value="0363003"> <annotation> <documentation>persistierend</documentation> </annotation> </enumeration> <enumeration value="0363004"> <annotation> <documentation>permanent</documentation> </annotation> </enumeration> </restriction> </simpleType> </pre> | | |

simpleType enum_0364

| | | | |
|------------|---|---------|--|
| namespace | http://xml.ir-d.de/emg | | |
| type | restriction of string | | |
| properties | base xs:string | | |
| used by | elements PatientenaufnahmeAortenklappeBasis/PAA_SchrittmacherSchluessel PostoperationAortenklappeBasis/POA_SchrittmacherSchluessel | | |
| facets | Kind | Value | Annotation |
| | enumeration | 0364001 | documentation nein |
| | enumeration | 0364002 | documentation Schrittmacher ohne CRT-System |
| | enumeration | 0364003 | documentation Schrittmacher mit CRT-System |
| | enumeration | 0364004 | documentation Defibrillator ohne CRT-System |
| | enumeration | 0364005 | documentation Defibrillator mit CRT-System |
| annotation | documentation Kat_AK_SchrittmacherDefi | | |
| source | <pre> <simpleType name="enum_0364"> <annotation> <documentation>Kat_AK_SchrittmacherDefi</documentation> </annotation> <restriction base="xs:string"> <enumeration value="0364001"> <annotation> <documentation>nein</documentation> </annotation> </enumeration> <enumeration value="0364002"> <annotation> <documentation>Schrittmacher ohne CRT-System</documentation> </annotation> </enumeration> <enumeration value="0364003"> <annotation> <documentation>Schrittmacher mit CRT-System</documentation> </annotation> </enumeration> <enumeration value="0364004"> <annotation> <documentation>Defibrillator ohne CRT-System</documentation> </annotation> </enumeration> <enumeration value="0364005"> <annotation> <documentation>Defibrillator mit CRT-System</documentation> </annotation> </enumeration> </restriction> </simpleType> </pre> | | |

simpleType enum_0365

| | |
|-----------|------------------------|
| namespace | http://xml.ir-d.de/emg |
|-----------|------------------------|

| type | restriction of string | | | | | | | | | | | | |
|-------------|---|--------------------------------------|-------|------------|-------------|---------|-----------------------|-------------|---------|-------------------------------|-------------|---------|--------------------------------------|
| properties | base xs:string | | | | | | | | | | | | |
| used by | element PatientenaufnahmeAortenklappeBasis/PAA RevaskularisationSchluessel | | | | | | | | | | | | |
| facets | <table border="1"> <thead> <tr> <th>Kind</th> <th>Value</th> <th>Annotation</th> </tr> </thead> <tbody> <tr> <td>enumeration</td> <td>0365001</td> <td>documentation nein</td> </tr> <tr> <td>enumeration</td> <td>0365002</td> <td>documentation ja, operativ</td> </tr> <tr> <td>enumeration</td> <td>0365003</td> <td>documentation ja, interventionell</td> </tr> </tbody> </table> | Kind | Value | Annotation | enumeration | 0365001 | documentation nein | enumeration | 0365002 | documentation ja, operativ | enumeration | 0365003 | documentation ja, interventionell |
| Kind | Value | Annotation | | | | | | | | | | | |
| enumeration | 0365001 | documentation nein | | | | | | | | | | | |
| enumeration | 0365002 | documentation ja, operativ | | | | | | | | | | | |
| enumeration | 0365003 | documentation ja, interventionell | | | | | | | | | | | |
| annotation | documentation Kat_AK_MyokardRevaskularisation | | | | | | | | | | | | |
| source | <pre> <simpleType name="enum_0365"> <annotation> <documentation>Kat_AK_MyokardRevaskularisation</documentation> </annotation> <restriction base="xs:string"> <enumeration value="0365001"> <annotation> <documentation>nein</documentation> </annotation> </enumeration> <enumeration value="0365002"> <annotation> <documentation>ja, operativ</documentation> </annotation> </enumeration> <enumeration value="0365003"> <annotation> <documentation>ja, interventionell</documentation> </annotation> </enumeration> </restriction> </simpleType> </pre> | | | | | | | | | | | | |

simpleType **enum_0366**

| namespace | http://xml.ir-d.de/emg | | | | | | | | | | | | | | | | | | |
|-------------|--|--|-------|------------|-------------|---------|-----------------------|-------------|---------|--------------------------------------|-------------|---------|--|-------------|---------|------------------------------------|-------------|---------|----------------------------|
| type | restriction of string | | | | | | | | | | | | | | | | | | |
| properties | base xs:string | | | | | | | | | | | | | | | | | | |
| used by | element PatientenaufnahmeAortenklappeBasis/PAA PciSchluessel | | | | | | | | | | | | | | | | | | |
| facets | <table border="1"> <thead> <tr> <th>Kind</th> <th>Value</th> <th>Annotation</th> </tr> </thead> <tbody> <tr> <td>enumeration</td> <td>0366001</td> <td>documentation nein</td> </tr> <tr> <td>enumeration</td> <td>0366002</td> <td>documentation ja, &lt;= 6 Stunden</td> </tr> <tr> <td>enumeration</td> <td>0366003</td> <td>documentation ja, &gt; 6 Stunden bis &lt;= 3 Monate</td> </tr> <tr> <td>enumeration</td> <td>0366004</td> <td>documentation ja, &gt; 3 Monate</td> </tr> <tr> <td>enumeration</td> <td>0366099</td> <td>documentation unbekannt</td> </tr> </tbody> </table> | Kind | Value | Annotation | enumeration | 0366001 | documentation nein | enumeration | 0366002 | documentation ja, <= 6 Stunden | enumeration | 0366003 | documentation ja, > 6 Stunden bis <= 3 Monate | enumeration | 0366004 | documentation ja, > 3 Monate | enumeration | 0366099 | documentation unbekannt |
| Kind | Value | Annotation | | | | | | | | | | | | | | | | | |
| enumeration | 0366001 | documentation nein | | | | | | | | | | | | | | | | | |
| enumeration | 0366002 | documentation ja, <= 6 Stunden | | | | | | | | | | | | | | | | | |
| enumeration | 0366003 | documentation ja, > 6 Stunden bis <= 3 Monate | | | | | | | | | | | | | | | | | |
| enumeration | 0366004 | documentation ja, > 3 Monate | | | | | | | | | | | | | | | | | |
| enumeration | 0366099 | documentation unbekannt | | | | | | | | | | | | | | | | | |
| annotation | documentation Kat_AK_PCI | | | | | | | | | | | | | | | | | | |
| source | <pre> <simpleType name="enum_0366"> </pre> | | | | | | | | | | | | | | | | | | |

```

<annotation>
  <documentation>Kat_AK_PCI</documentation>
</annotation>
<restriction base="xs:string">
  <enumeration value="0366001">
    <annotation>
      <documentation>nein</documentation>
    </annotation>
  </enumeration>
  <enumeration value="0366002">
    <annotation>
      <documentation>ja, &lt;= 6 Stunden</documentation>
    </annotation>
  </enumeration>
  <enumeration value="0366003">
    <annotation>
      <documentation>ja, &gt; 6 Stunden bis &lt;= 3 Monate</documentation>
    </annotation>
  </enumeration>
  <enumeration value="0366004">
    <annotation>
      <documentation>ja, &gt; 3 Monate</documentation>
    </annotation>
  </enumeration>
  <enumeration value="0366099">
    <annotation>
      <documentation>unbekannt</documentation>
    </annotation>
  </enumeration>
</restriction>
</simpleType>

```

simpleType **enum_0367**

| | | | |
|------------|------------------------------|--|--|
| namespace | http://xml.ir-d.de/emg | | |
| type | restriction of string | | |
| properties | base xs:string | | |
| used by | element | InfektionAortenklappeBasis/IAK InfektionSchluessel | |
| facets | Kind | Value | Annotation |
| | enumeration | 0367001 | documentation keine |
| | enumeration | 0367002 | documentation Mediastinitis |
| | enumeration | 0367003 | documentation Sepsis |
| | enumeration | 0367004 | documentation broncho-pulmonale Infektion |
| | enumeration | 0367005 | documentation oto-laryngologische Infektion |
| | enumeration | 0367006 | documentation floride Endokarditis |
| | enumeration | 0367007 | documentation Peritonitis |
| | enumeration | 0367008 | documentation Wundinfektion Thorax |
| | enumeration | 0367009 | documentation Pleuraempyem |
| | enumeration | 0367010 | documentation |

| | |
|------------|--|
| | <p>enumeration 0367011 Venenkatheterinfektion documentation Harnwegsinfektion</p> <p>enumeration 0367012 documentation Wundinfektion untere Extremitäten</p> <p>enumeration 0367013 documentation HIV-Infektion</p> <p>enumeration 0367014 documentation Hepatitis B oder C</p> <p>enumeration 0367015 documentation andere Wundinfektion</p> <p>enumeration 0367042 documentation sonstige Infektion</p> |
| annotation | documentation Kat_AK_Infektion |
| source | <pre> <simpleType name="enum_0367"> <annotation> <documentation>Kat_AK_Infektion</documentation> </annotation> <restriction base="xs:string"> <enumeration value="0367001"> <annotation> <documentation>keine</documentation> </annotation> </enumeration> <enumeration value="0367002"> <annotation> <documentation>Mediastinitis</documentation> </annotation> </enumeration> <enumeration value="0367003"> <annotation> <documentation>Sepsis</documentation> </annotation> </enumeration> <enumeration value="0367004"> <annotation> <documentation>broncho-pulmonale Infektion</documentation> </annotation> </enumeration> <enumeration value="0367005"> <annotation> <documentation>oto-laryngologische Infektion</documentation> </annotation> </enumeration> <enumeration value="0367006"> <annotation> <documentation>floride Endokarditis</documentation> </annotation> </enumeration> <enumeration value="0367007"> <annotation> <documentation>Peritonitis</documentation> </annotation> </enumeration> <enumeration value="0367008"> <annotation> <documentation>Wundinfektion Thorax</documentation> </annotation> </enumeration> </restriction> </simpleType> </pre> |

```

<enumeration value="0367009">
  <annotation>
    <documentation>Pleuraempyem</documentation>
  </annotation>
</enumeration>
<enumeration value="0367010">
  <annotation>
    <documentation>Venenkatheterinfektion</documentation>
  </annotation>
</enumeration>
<enumeration value="0367011">
  <annotation>
    <documentation>Harnwegsinfektion</documentation>
  </annotation>
</enumeration>
<enumeration value="0367012">
  <annotation>
    <documentation>Wundinfektion untere Extremitäten</documentation>
  </annotation>
</enumeration>
<enumeration value="0367013">
  <annotation>
    <documentation>HIV-Infektion</documentation>
  </annotation>
</enumeration>
<enumeration value="0367014">
  <annotation>
    <documentation>Hepatitis B oder C</documentation>
  </annotation>
</enumeration>
<enumeration value="0367015">
  <annotation>
    <documentation>andere Wundinfektion</documentation>
  </annotation>
</enumeration>
<enumeration value="0367042">
  <annotation>
    <documentation>sonstige Infektion</documentation>
  </annotation>
</enumeration>
</restriction>
</simpleType>

```

simpleType enum_0368

| | | | |
|------------|---|---------|--|
| namespace | http://xml.ir-d.de/emg | | |
| type | restriction of string | | |
| properties | base xs:string | | |
| used by | element PatientenaufnahmeAortenklappeBasis/PAA LungenerkrankungSchluessel | | |
| facets | Kind | Value | Annotation |
| | enumeration | 0368001 | documentation nein |
| | enumeration | 0368002 | documentation ja, COPD mit Dauermedikation |
| | enumeration | 0368003 | documentation ja, COPD ohne Dauermedikation |

| | |
|------------|---|
| | enumeration 0368004 documentation ja, andere Lungenerkrankungen enumeration 0368099 documentation unbekannt |
| annotation | documentation Kat_AK_Lungenerkrankung |
| source | <pre> <simpleType name="enum_0368"> <annotation> <documentation>Kat_AK_Lungenerkrankung</documentation> </annotation> <restriction base="xs:string"> <enumeration value="0368001"> <annotation> <documentation>nein</documentation> </annotation> </enumeration> <enumeration value="0368002"> <annotation> <documentation>ja, COPD mit Dauermedikation</documentation> </annotation> </enumeration> <enumeration value="0368003"> <annotation> <documentation>ja, COPD ohne Dauermedikation</documentation> </annotation> </enumeration> <enumeration value="0368004"> <annotation> <documentation>ja, andere Lungenerkrankungen</documentation> </annotation> </enumeration> <enumeration value="0368099"> <annotation> <documentation>unbekannt</documentation> </annotation> </enumeration> </restriction> </simpleType> </pre> |

simpleType enum_0369

| | | | |
|------------|---|--|----------------------------|
| namespace | http://xml.ir-d.de/emg | | |
| type | restriction of string | | |
| properties | base xs:string | | |
| used by | element | PatientenaufnahmeKardiologieBasis/PKA_NierenersatzSchluessel | |
| facets | Kind | Value | Annotation |
| | enumeration | 0369001 | documentation nein |
| | enumeration | 0369002 | documentation akut |
| | enumeration | 0369003 | documentation chronisch |
| annotation | documentation Kat_AK_Nierenersatztherapie | | |
| source | <pre> <simpleType name="enum_0369"> <annotation> </pre> | | |

| | |
|--|--|
| | <pre> <documentation>Kat_AK_Nierenersatztherapie</documentation> </annotation> <restriction base="xs:string"> <enumeration value="0369001"> <annotation> <documentation>nein</documentation> </annotation> </enumeration> <enumeration value="0369002"> <annotation> <documentation>akut</documentation> </annotation> </enumeration> <enumeration value="0369003"> <annotation> <documentation>chronisch</documentation> </annotation> </enumeration> </restriction> </simpleType> </pre> |
|--|--|

simpleType enum_0370

| | | | |
|------------|---|---|------------------------------------|
| namespace | http://xml.ir-d.de/emg | | |
| type | restriction of string | | |
| properties | base xs:string | | |
| used by | element | PatientenaufnahmeAortenklappeBasis/PAA_AkoefMethodeSchluessel | |
| facets | Kind | Value | Annotation |
| | enumeration | 0370001 | documentation Echokardiographie |
| | enumeration | 0370002 | documentation Herzkatheter |
| | enumeration | 0370042 | documentation andere |
| annotation | documentation Kat_AK_AKOEFMessmethode | | |
| source | <pre> <simpleType name="enum_0370"> <annotation> <documentation>Kat_AK_AKOEFMessmethode</documentation> </annotation> <restriction base="xs:string"> <enumeration value="0370001"> <annotation> <documentation>Echokardiographie</documentation> </annotation> </enumeration> <enumeration value="0370002"> <annotation> <documentation>Herzkatheter</documentation> </annotation> </enumeration> <enumeration value="0370042"> <annotation> <documentation>andere</documentation> </annotation> </enumeration> </restriction> </pre> | | |

```
</restriction>
</simpleType>
```

simpleType enum_0371

| namespace | http://xml.ir-d.de/emg | | | | | | | | | | | | | | | | | | |
|-------------|---|----------------------------|-------|------------|-------------|---------|------------------------|-------------|---------|-------------------------|-------------|---------|-------------------------|-------------|---------|-------------------------|-------------|---------|----------------------------|
| type | restriction of string | | | | | | | | | | | | | | | | | | |
| properties | base xs:string | | | | | | | | | | | | | | | | | | |
| used by | element PatientenaufnahmeAortenklappeBasis/PAA VerkalkungsgradSchluessel | | | | | | | | | | | | | | | | | | |
| facets | <table><thead><tr><th>Kind</th><th>Value</th><th>Annotation</th></tr></thead><tbody><tr><td>enumeration</td><td>0371001</td><td>documentation keine</td></tr><tr><td>enumeration</td><td>0371002</td><td>documentation leicht</td></tr><tr><td>enumeration</td><td>0371003</td><td>documentation mittel</td></tr><tr><td>enumeration</td><td>0371004</td><td>documentation schwer</td></tr><tr><td>enumeration</td><td>0371099</td><td>documentation unbekannt</td></tr></tbody></table> | Kind | Value | Annotation | enumeration | 0371001 | documentation keine | enumeration | 0371002 | documentation leicht | enumeration | 0371003 | documentation mittel | enumeration | 0371004 | documentation schwer | enumeration | 0371099 | documentation unbekannt |
| Kind | Value | Annotation | | | | | | | | | | | | | | | | | |
| enumeration | 0371001 | documentation keine | | | | | | | | | | | | | | | | | |
| enumeration | 0371002 | documentation leicht | | | | | | | | | | | | | | | | | |
| enumeration | 0371003 | documentation mittel | | | | | | | | | | | | | | | | | |
| enumeration | 0371004 | documentation schwer | | | | | | | | | | | | | | | | | |
| enumeration | 0371099 | documentation unbekannt | | | | | | | | | | | | | | | | | |
| annotation | documentation Kat_AK_Verkalkungsgrad | | | | | | | | | | | | | | | | | | |
| source | <pre><simpleType name="enum_0371"> <annotation> <documentation>Kat_AK_Verkalkungsgrad</documentation> </annotation> <restriction base="xs:string"> <enumeration value="0371001"> <annotation> <documentation>keine</documentation> </annotation> </enumeration> <enumeration value="0371002"> <annotation> <documentation>leicht</documentation> </annotation> </enumeration> <enumeration value="0371003"> <annotation> <documentation>mittel</documentation> </annotation> </enumeration> <enumeration value="0371004"> <annotation> <documentation>schwer</documentation> </annotation> </enumeration> <enumeration value="0371099"> <annotation> <documentation>unbekannt</documentation> </annotation> </enumeration> </restriction> </simpleType></pre> | | | | | | | | | | | | | | | | | | |

simpleType enum_0372

| | | | |
|------------|--|---------|---------------------------------|
| namespace | http://xml.ir-d.de/emg | | |
| type | restriction of string | | |
| properties | base xs:string | | |
| used by | element PatientenaufnahmeAortenklappeBasis/PAA_BiUnicuspideKlappeSchluessel | | |
| facets | Kind | Value | Annotation |
| | enumeration | 0372001 | documentation nein |
| | enumeration | 0372002 | documentation ja, bicuspide |
| | enumeration | 0372003 | documentation ja, unicuspide |
| | enumeration | 0372099 | documentation unbekannt |
| annotation | documentation Kat_AK_BiUnicuspideKlappe | | |
| source | <pre> <simpleType name="enum_0372"> <annotation> <documentation>Kat_AK_BiUnicuspideKlappe</documentation> </annotation> <restriction base="xs:string"> <enumeration value="0372001"> <annotation> <documentation>nein</documentation> </annotation> </enumeration> <enumeration value="0372002"> <annotation> <documentation>ja, bicuspide</documentation> </annotation> </enumeration> <enumeration value="0372003"> <annotation> <documentation>ja, unicuspide</documentation> </annotation> </enumeration> <enumeration value="0372099"> <annotation> <documentation>unbekannt</documentation> </annotation> </enumeration> </restriction> </simpleType> </pre> | | |

simpleType enum_0373

| | | | |
|------------|---|--|--|
| namespace | http://xml.ir-d.de/emg | | |
| type | restriction of string | | |
| properties | base xs:string | | |
| used by | elements PatientenaufnahmeAortenklappeBasis/PAA_AorteninsuffizienzSchluessel PatientenaufnahmeAortenklappeBasis/PAA_AortenstenoseSchluessel PatientenaufnahmeAortenklappeBasis/PAA_MitralinsuffizienzSchluessel PostoperationAortenklappeBasis/POA_AorteninsuffizienzSchluessel PostoperationAortenklappeBasis/POA_MitralinsuffizienzSchluessel | | |

| facets | <table border="1"> <thead> <tr> <th>Kind</th> <th>Value</th> <th>Annotation</th> </tr> </thead> <tbody> <tr> <td>enumeration</td> <td>0373001</td> <td>documentation keine</td> </tr> <tr> <td>enumeration</td> <td>0373002</td> <td>documentation leichtgradig</td> </tr> <tr> <td>enumeration</td> <td>0373003</td> <td>documentation mittelgradig</td> </tr> <tr> <td>enumeration</td> <td>0373004</td> <td>documentation hochgradig</td> </tr> <tr> <td>enumeration</td> <td>0373099</td> <td>documentation unbekannt</td> </tr> </tbody> </table> | Kind | Value | Annotation | enumeration | 0373001 | documentation keine | enumeration | 0373002 | documentation leichtgradig | enumeration | 0373003 | documentation mittelgradig | enumeration | 0373004 | documentation hochgradig | enumeration | 0373099 | documentation unbekannt |
|-------------|--|-------------------------------|-------|------------|-------------|---------|------------------------|-------------|---------|-------------------------------|-------------|---------|-------------------------------|-------------|---------|-----------------------------|-------------|---------|----------------------------|
| Kind | Value | Annotation | | | | | | | | | | | | | | | | | |
| enumeration | 0373001 | documentation keine | | | | | | | | | | | | | | | | | |
| enumeration | 0373002 | documentation leichtgradig | | | | | | | | | | | | | | | | | |
| enumeration | 0373003 | documentation mittelgradig | | | | | | | | | | | | | | | | | |
| enumeration | 0373004 | documentation hochgradig | | | | | | | | | | | | | | | | | |
| enumeration | 0373099 | documentation unbekannt | | | | | | | | | | | | | | | | | |
| annotation | documentation Kat AK Grad | | | | | | | | | | | | | | | | | | |
| source | <pre> <simpleType name="enum_0373"> <annotation> <documentation>Kat_AK_Grad</documentation> </annotation> <restriction base="xs:string"> <enumeration value="0373001"> <annotation> <documentation>keine</documentation> </annotation> </enumeration> <enumeration value="0373002"> <annotation> <documentation>leichtgradig</documentation> </annotation> </enumeration> <enumeration value="0373003"> <annotation> <documentation>mittelgradig</documentation> </annotation> </enumeration> <enumeration value="0373004"> <annotation> <documentation>hochgradig</documentation> </annotation> </enumeration> <enumeration value="0373099"> <annotation> <documentation>unbekannt</documentation> </annotation> </enumeration> </restriction> </simpleType> </pre> | | | | | | | | | | | | | | | | | | |

simpleType enum 0374

| namespace | http://xml.ir-d.de/emg | | | | | | | | | |
|-------------|--|---|-------|------------|-------------|---------|-----------------------|-------------|---------|--------------------------------------|
| type | restriction of string | | | | | | | | | |
| properties | base xs:string | | | | | | | | | |
| used by | element | PatientenaufnahmeAortenklappeBasis/PAA MyokardinfarktSchluessel | | | | | | | | |
| facets | <table border="1"> <thead> <tr> <th>Kind</th> <th>Value</th> <th>Annotation</th> </tr> </thead> <tbody> <tr> <td>enumeration</td> <td>0374001</td> <td>documentation nein</td> </tr> <tr> <td>enumeration</td> <td>0374002</td> <td>documentation ja, &lt;= 6 Stunden</td> </tr> </tbody> </table> | Kind | Value | Annotation | enumeration | 0374001 | documentation nein | enumeration | 0374002 | documentation ja, <= 6 Stunden |
| Kind | Value | Annotation | | | | | | | | |
| enumeration | 0374001 | documentation nein | | | | | | | | |
| enumeration | 0374002 | documentation ja, <= 6 Stunden | | | | | | | | |

| | |
|------------|---|
| | enumeration 0374003 documentation ja, > 6 Stunden bis <= 24 Stunden enumeration 0374004 documentation ja, > 1 bis 7 Tage enumeration 0374005 documentation ja, > 7 bis 21 Tage enumeration 0374006 documentation ja, > 21 Tage enumeration 0374099 documentation unbekannt |
| annotation | documentation Kat_AK_InfarktAnamnese |
| source | <pre> <simpleType name="enum_0374"> <annotation> <documentation>Kat_AK_InfarktAnamnese</documentation> </annotation> <restriction base="xs:string"> <enumeration value="0374001"> <annotation> <documentation>nein</documentation> </annotation> </enumeration> <enumeration value="0374002"> <annotation> <documentation>ja, <= 6 Stunden</documentation> </annotation> </enumeration> <enumeration value="0374003"> <annotation> <documentation>ja, > 6 Stunden bis <= 24 Stunden</documentation> </annotation> </enumeration> <enumeration value="0374004"> <annotation> <documentation>ja, > 1 bis 7 Tage</documentation> </annotation> </enumeration> <enumeration value="0374005"> <annotation> <documentation>ja, > 7 bis 21 Tage</documentation> </annotation> </enumeration> <enumeration value="0374006"> <annotation> <documentation>ja, > 21 Tage</documentation> </annotation> </enumeration> <enumeration value="0374099"> <annotation> <documentation>unbekannt</documentation> </annotation> </enumeration> </restriction> </simpleType> </pre> |

simpleType enum_0375

| | |
|-----------|------------------------|
| namespace | http://xml.ir-d.de/emg |
|-----------|------------------------|

| | | | |
|------------|--|---------|---|
| type | restriction of string | | |
| properties | base xs:string | | |
| used by | element PatientenaufnahmeAortenklappeBasis/PAA SymptomeSchluessel | | |
| facets | Kind | Value | Annotation |
| | enumeration | 0375001 | documentation keine Symptome oder Angina |
| | enumeration | 0375002 | documentation Symptome, aber keine Ischämiezeichen |
| | enumeration | 0375003 | documentation stabile Angina |
| | enumeration | 0375004 | documentation instabile Angina |
| | enumeration | 0375005 | documentation Infarkt ohne ST-Hebung (Non-STEMI) |
| | enumeration | 0375006 | documentation Infarkt mit ST-Hebung (STEMI) |
| | enumeration | 0375042 | documentation unbekannt |
| annotation | documentation Kat_AK_KardialeSymptome | | |
| source | <pre> <simpleType name="enum_0375"> <annotation> <documentation>Kat_AK_KardialeSymptome</documentation> </annotation> <restriction base="xs:string"> <enumeration value="0375001"> <annotation> <documentation>keine Symptome oder Angina</documentation> </annotation> </enumeration> <enumeration value="0375002"> <annotation> <documentation>Symptome, aber keine Ischämiezeichen</documentation> </annotation> </enumeration> <enumeration value="0375003"> <annotation> <documentation>stabile Angina</documentation> </annotation> </enumeration> <enumeration value="0375004"> <annotation> <documentation>instabile Angina</documentation> </annotation> </enumeration> <enumeration value="0375005"> <annotation> <documentation>Infarkt ohne ST-Hebung (Non-STEMI)</documentation> </annotation> </enumeration> <enumeration value="0375006"> <annotation> <documentation>Infarkt mit ST-Hebung (STEMI)</documentation> </annotation> </enumeration> <enumeration value="0375042"> <annotation> <documentation>unbekannt</documentation> </annotation> </enumeration> </restriction> </simpleType> </pre> | | |

| | |
|--|--|
| | <pre> </annotation> </enumeration> </restriction> </simpleType> </pre> |
|--|--|

simpleType enum_0376

| | | | |
|------------|--|---|---|
| namespace | http://xml.ir-d.de/emg | | |
| type | restriction of string | | |
| properties | base xs:string | | |
| used by | element | PostoperationAortenklappeBasis/POA_SchlaganfallSchluessel | |
| facets | Kind | Value | Annotation |
| | enumeration | 0376001 | documentation nein |
| | enumeration | 0376002 | documentation ja, ZNS, zerebrovaskuläre Blutung |
| | enumeration | 0376003 | documentation ja, ZNS, zerebrovaskuläre Ischämie |
| | enumeration | 0376042 | documentation ja, ZNS, andere |
| annotation | documentation Kat_AK_Schlaganfall | | |
| source | <pre> <simpleType name="enum_0376"> <annotation> <documentation>Kat_AK_Schlaganfall</documentation> </annotation> <restriction base="xs:string"> <enumeration value="0376001"> <annotation> <documentation>nein</documentation> </annotation> </enumeration> <enumeration value="0376002"> <annotation> <documentation>ja, ZNS, zerebrovaskuläre Blutung</documentation> </annotation> </enumeration> <enumeration value="0376003"> <annotation> <documentation>ja, ZNS, zerebrovaskuläre Ischämie</documentation> </annotation> </enumeration> <enumeration value="0376042"> <annotation> <documentation>ja, ZNS, andere</documentation> </annotation> </enumeration> </restriction> </simpleType> </pre> | | |

simpleType enum_0377

| | |
|-----------|------------------------------|
| namespace | http://xml.ir-d.de/emg |
| type | restriction of string |

| properties | base xs:string | | | | | | | | | | | | |
|-------------|---|---|-------|------------|-------------|---------|---|-------------|---------|--|-------------|---------|---|
| used by | element PostoperationAortenklappeBasis/POA NihssSchluessel | | | | | | | | | | | | |
| facets | <table border="1"> <thead> <tr> <th>Kind</th> <th>Value</th> <th>Annotation</th> </tr> </thead> <tbody> <tr> <td>enumeration</td> <td>0377001</td> <td>documentation ja, mild neurological dysfunction: NIHSS 0-5</td> </tr> <tr> <td>enumeration</td> <td>0377002</td> <td>documentation ja, moderate neurological dysfunction: NIHSS 6-14</td> </tr> <tr> <td>enumeration</td> <td>0377003</td> <td>documentation ja, severe neurological dysfunction: NIHSS &gt;=15</td> </tr> </tbody> </table> | Kind | Value | Annotation | enumeration | 0377001 | documentation ja, mild neurological dysfunction: NIHSS 0-5 | enumeration | 0377002 | documentation ja, moderate neurological dysfunction: NIHSS 6-14 | enumeration | 0377003 | documentation ja, severe neurological dysfunction: NIHSS >=15 |
| Kind | Value | Annotation | | | | | | | | | | | |
| enumeration | 0377001 | documentation ja, mild neurological dysfunction: NIHSS 0-5 | | | | | | | | | | | |
| enumeration | 0377002 | documentation ja, moderate neurological dysfunction: NIHSS 6-14 | | | | | | | | | | | |
| enumeration | 0377003 | documentation ja, severe neurological dysfunction: NIHSS >=15 | | | | | | | | | | | |
| annotation | documentation Kat_AK_Nihss | | | | | | | | | | | | |
| source | <pre> <simpleType name="enum_0377"> <annotation> <documentation>Kat_AK_Nihss</documentation> </annotation> <restriction base="xs:string"> <enumeration value="0377001"> <annotation> <documentation>ja, mild neurological dysfunction: NIHSS 0-5</documentation> </annotation> </enumeration> <enumeration value="0377002"> <annotation> <documentation>ja, moderate neurological dysfunction: NIHSS 6-14</documentation> </annotation> </enumeration> <enumeration value="0377003"> <annotation> <documentation> ja, severe neurological dysfunction: NIHSS &gt;=15</documentation> </annotation> </enumeration> </restriction> </simpleType> </pre> | | | | | | | | | | | | |

simpleType enum_0378

| namespace | http://xml.ir-d.de/emg | | | | | | | | | | | | | | | |
|-------------|--|--|-------|------------|-------------|---------|-----------------------|-------------|---------|--|-------------|---------|--|-------------|---------|--|
| type | restriction of string | | | | | | | | | | | | | | | |
| properties | base xs:string | | | | | | | | | | | | | | | |
| used by | element PostoperationAortenklappeBasis/POA MyokardinfarktSchluessel | | | | | | | | | | | | | | | |
| facets | <table border="1"> <thead> <tr> <th>Kind</th> <th>Value</th> <th>Annotation</th> </tr> </thead> <tbody> <tr> <td>enumeration</td> <td>0378001</td> <td>documentation nein</td> </tr> <tr> <td>enumeration</td> <td>0378002</td> <td>documentation ja, &lt; 48h gemäss VARC-3-Definition</td> </tr> <tr> <td>enumeration</td> <td>0378003</td> <td>documentation ja, &gt;= 48h - &lt;= 72h gemäß VARC-3-Definition</td> </tr> <tr> <td>enumeration</td> <td>0378004</td> <td>documentation ja, &gt; 72 h gemäß VARC-3 Definition</td> </tr> </tbody> </table> | Kind | Value | Annotation | enumeration | 0378001 | documentation nein | enumeration | 0378002 | documentation ja, < 48h gemäss VARC-3-Definition | enumeration | 0378003 | documentation ja, >= 48h - <= 72h gemäß VARC-3-Definition | enumeration | 0378004 | documentation ja, > 72 h gemäß VARC-3 Definition |
| Kind | Value | Annotation | | | | | | | | | | | | | | |
| enumeration | 0378001 | documentation nein | | | | | | | | | | | | | | |
| enumeration | 0378002 | documentation ja, < 48h gemäss VARC-3-Definition | | | | | | | | | | | | | | |
| enumeration | 0378003 | documentation ja, >= 48h - <= 72h gemäß VARC-3-Definition | | | | | | | | | | | | | | |
| enumeration | 0378004 | documentation ja, > 72 h gemäß VARC-3 Definition | | | | | | | | | | | | | | |
| annotation | documentation Kat_AK_Myokardinfarkt | | | | | | | | | | | | | | | |
| source | <pre> <simpleType name="enum_0378"> <annotation> </pre> | | | | | | | | | | | | | | | |

| | |
|--|--|
| | <pre> <documentation>Kat_AK_Myokardinfarkt</documentation> </annotation> <restriction base="xs:string"> <enumeration value="0378001"> <annotation> <documentation>nein</documentation> </annotation> </enumeration> <enumeration value="0378002"> <annotation> <documentation>ja, &lt; 48h gemäss VARC-3-Definition</documentation> </annotation> </enumeration> <enumeration value="0378003"> <annotation> <documentation>ja, &gt;= 48h - &lt;= 72h gemäß VARC-3-Definition</documentation> </annotation> </enumeration> <enumeration value="0378004"> <annotation> <documentation>ja, &gt; 72 h gemäß VARC-3 Definition</documentation> </annotation> </enumeration> </restriction> </simpleType> </pre> |
|--|--|

simpleType enum_0379

| | | | |
|------------|--|---|--|
| namespace | http://xml.ir-d.de/emg | | |
| type | restriction of string | | |
| properties | base xs:string | | |
| used by | element | PostoperationAortenklappeBasis/POA ZugangKomplikationenSchluessel | |
| facets | Kind | Value | Annotation |
| | enumeration | 0379001 | documentation Keine gefäss- oder zugangsassozierte Komplikationen |
| | enumeration | 0379002 | documentation Versagen des perkutanen Verschlusssystems |
| | enumeration | 0379003 | documentation Geringfügige Gefäßkomplikationen |
| | enumeration | 0379004 | documentation Erhebliche Gefäßkomplikationen |
| annotation | documentation | Kat_AK_ZugangKomplikationen | |
| source | <pre> <simpleType name="enum_0379"> <annotation> <documentation>Kat_AK_ZugangKomplikationen</documentation> </annotation> <restriction base="xs:string"> <enumeration value="0379001"> <annotation> <documentation>Keine gefäss- oder zugangsassozierte Komplikationen</documentation> </annotation> </enumeration> <enumeration value="0379002"> </pre> | | |

| | |
|--|---|
| | <pre> <annotation> <documentation>Versagen des perkutanen Verschlussystems</documentation> </annotation> </enumeration> <enumeration value="0379003"> <annotation> <documentation>Geringfügige Gefäßkomplikationen</documentation> </annotation> </enumeration> <enumeration value="0379004"> <annotation> <documentation>Erhebliche Gefäßkomplikationen</documentation> </annotation> </enumeration> </restriction> </simpleType> </pre> |
|--|---|

simpleType enum 0380

| | | | |
|------------|---|---------|--|
| namespace | http://xml.ir-d.de/emg | | |
| type | restriction of string | | |
| properties | base xs:string | | |
| used by | element PostoperationAortenklappeBasis/POA ReanimationSchlüssel | | |
| facets | Kind | Value | Annotation |
| | enumeration | 0380001 | documentation nein |
| | enumeration | 0380002 | documentation ja, intraprozedural |
| | enumeration | 0380003 | documentation ja, postprozedural |
| | enumeration | 0380004 | documentation ja, Zeitpunkt nicht bekannt |
| annotation | documentation Kat_AK_Reanimation | | |
| source | <pre> <simpleType name="enum_0380"> <annotation> <documentation>Kat_AK_Reanimation</documentation> </annotation> <restriction base="xs:string"> <enumeration value="0380001"> <annotation> <documentation>nein</documentation> </annotation> </enumeration> <enumeration value="0380002"> <annotation> <documentation>ja, intraprozedural</documentation> </annotation> </enumeration> <enumeration value="0380003"> <annotation> <documentation>ja, postprozedural</documentation> </annotation> </enumeration> <enumeration value="0380004"> </pre> | | |

| | |
|--|--|
| | <pre> <annotation> <documentation>ja, Zeitpunkt nicht bekannt</documentation> </annotation> </enumeration> </restriction> </simpleType> </pre> |
|--|--|

simpleType enum_0381

| | | | |
|------------|---|---------|---|
| namespace | http://xml.ir-d.de/emg | | |
| type | restriction of string | | |
| properties | base xs:string | | |
| used by | element PostoperationAortenklappeBasis/POA MassnahmenSchluessel | | |
| facets | Kind | Value | Annotation |
| | enumeration | 0381001 | documentation nein |
| | enumeration | 0381002 | documentation Thorakotomie/Rethorakotomie |
| | enumeration | 0381003 | documentation kathetergestützte Reintervention |
| | enumeration | 0381004 | documentation lokale Reinterventionen |
| | enumeration | 0381005 | documentation andere Reintervention |
| annotation | documentation Kat_AK_Massnahmen | | |
| source | <pre> <simpleType name="enum_0381"> <annotation> <documentation>Kat_AK_Massnahmen</documentation> </annotation> <restriction base="xs:string"> <enumeration value="0381001"> <annotation> <documentation>nein</documentation> </annotation> </enumeration> <enumeration value="0381002"> <annotation> <documentation>Thorakotomie/Rethorakotomie</documentation> </annotation> </enumeration> <enumeration value="0381003"> <annotation> <documentation>kathetergestützte Reintervention</documentation> </annotation> </enumeration> <enumeration value="0381004"> <annotation> <documentation>lokale Reinterventionen</documentation> </annotation> </enumeration> <enumeration value="0381005"> <annotation> <documentation>andere Reintervention</documentation> </annotation> </enumeration> </restriction> </simpleType> </pre> | | |

```

</restriction>
</simpleType>

```

simpleType enum_0382

| | | | |
|------------|--|---|--|
| namespace | http://xml.ir-d.de/emg | | |
| type | restriction of string | | |
| properties | base xs:string | | |
| used by | element | PostoperationAortenklappeBasis/POA_GrundMassnahmeSchluessel | |
| facets | Kind | Value | Annotation |
| | enumeration | 0382001 | documentation keine Rethorakotomie / kein weiterer Grund |
| | enumeration | 0382002 | documentation Blutung/Hämatom |
| | enumeration | 0382003 | documentation Low Cardiac Output |
| | enumeration | 0382004 | documentation Tamponade |
| | enumeration | 0382005 | documentation Graftprobleme, Ischämie |
| | enumeration | 0382006 | documentation Wundinfektion, Mediastinitis |
| | enumeration | 0382007 | documentation Dissektion |
| | enumeration | 0382008 | documentation Prothesendysfunktion |
| | enumeration | 0382009 | documentation instabiles Sternum |
| | enumeration | 0382010 | documentation Chylothorax |
| | enumeration | 0382011 | documentation lokale Revision im Bereich des Zugangsweges |
| | enumeration | 0382042 | documentation anderer Grund |
| annotation | documentation Kat_AK_Komplikation | | |
| source | <pre> <simpleType name="enum_0382"> <annotation> <documentation>Kat_AK_Komplikation</documentation> </annotation> <restriction base="xs:string"> <enumeration value="0382001"> <annotation> <documentation>keine Rethorakotomie / kein weiterer Grund</documentation> </annotation> </enumeration> <enumeration value="0382002"> <annotation> <documentation>Blutung/Hämatom</documentation> </annotation> </enumeration> <enumeration value="0382003"> <annotation> <documentation>Low Cardiac Output</documentation> </annotation> </enumeration> <enumeration value="0382004"> </pre> | | |

```

    <annotation>
      <documentation>Tamponade</documentation>
    </annotation>
  </enumeration>
  <enumeration value="0382005">
    <annotation>
      <documentation>Graftprobleme, Ischämie</documentation>
    </annotation>
  </enumeration>
  <enumeration value="0382006">
    <annotation>
      <documentation>Wundinfektion, Mediastinitis</documentation>
    </annotation>
  </enumeration>
  <enumeration value="0382007">
    <annotation>
      <documentation>Dissektion</documentation>
    </annotation>
  </enumeration>
  <enumeration value="0382008">
    <annotation>
      <documentation>Prothesendysfunktion</documentation>
    </annotation>
  </enumeration>
  <enumeration value="0382009">
    <annotation>
      <documentation>instabiles Sternum</documentation>
    </annotation>
  </enumeration>
  <enumeration value="0382010">
    <annotation>
      <documentation>Chylothorax</documentation>
    </annotation>
  </enumeration>
  <enumeration value="0382011">
    <annotation>
      <documentation>lokale Revision im Bereich des
Zugangsweges</documentation>
    </annotation>
  </enumeration>
  <enumeration value="0382042">
    <annotation>
      <documentation>anderer Grund</documentation>
    </annotation>
  </enumeration>
</restriction>
</simpleType>

```

simpleType enum_0383

| | | | |
|------------|------------------------------|---|---------------|
| namespace | http://xml.ir-d.de/emg | | |
| type | restriction of string | | |
| properties | base xs:string | | |
| used by | element | PostoperationAortenklappeBasis/POA AtemInsuffizienzSchluessel | |
| facets | Kind | Value | Annotation |
| | enumeration | 0383001 | documentation |

| | |
|------------|---|
| | <pre> enumeration 0383002 nein documentation ja, mit forcierter Atemtherapie enumeration 0383003 documentation ja, Reintubation oder längerfristige Beatmung enumeration 0383004 documentation ja, Tracheotomie </pre> |
| annotation | documentation Kat_AK_RespiratorischeInsuffizienz |
| source | <pre> <simpleType name="enum_0383"> <annotation> <documentation>Kat_AK_RespiratorischeInsuffizienz</documentation> </annotation> <restriction base="xs:string"> <enumeration value="0383001"> <annotation> <documentation>nein</documentation> </annotation> </enumeration> <enumeration value="0383002"> <annotation> <documentation>ja, mit forcierter Atemtherapie</documentation> </annotation> </enumeration> <enumeration value="0383003"> <annotation> <documentation>ja, Reintubation oder längerfristige Beatmung</documentation> </annotation> </enumeration> <enumeration value="0383004"> <annotation> <documentation>ja, Tracheotomie</documentation> </annotation> </enumeration> </restriction> </simpleType> </pre> |

simpleType enum_0384

| | | | |
|------------|--|---------|--|
| namespace | http://xml.ir-d.de/emg | | |
| type | restriction of string | | |
| properties | base xs:string | | |
| used by | element PostoperationAortenklappeBasis/POA BlutungSchluessel | | |
| facets | Kind | Value | Annotation |
| | enumeration | 0384001 | documentation keine Blutungskomplikationen |
| | enumeration | 0384002 | documentation Geringfügige Blutung (Minor Bleeding - BARC type 2 or 3a) |
| | enumeration | 0384003 | documentation Starke Blutung (Major Bleeding - BARC type 3a) |
| | enumeration | 0384004 | documentation Lebensbedrohliche Blutung (Life-threatening or disabling bleeding - BARC type 3b or 3c or type 5) |
| annotation | documentation Kat_AK_Blutungskomplikation | | |
| source | <pre> <simpleType name="enum_0384"> </pre> | | |

| | |
|--|--|
| | <pre> <annotation> <documentation>Kat_AK_Blutungskomplikation</documentation> </annotation> <restriction base="xs:string"> <enumeration value="0384001"> <annotation> <documentation>keine Blutungskomplikationen</documentation> </annotation> </enumeration> <enumeration value="0384002"> <annotation> <documentation>Geringfügige Blutung (Minor Bleeding - BARC type 2 or 3a)</documentation> </annotation> </enumeration> <enumeration value="0384003"> <annotation> <documentation>Starke Blutung (Major Bleeding - BARC type 3a)</documentation> </annotation> </enumeration> <enumeration value="0384004"> <annotation> <documentation>Lebensbedrohliche Blutung (Life-threatening or disabling bleeding - BARC type 3b or 3c or type 5)</documentation> </annotation> </enumeration> </restriction> </simpleType> </pre> |
|--|--|

simpleType enum_0385

| | | | |
|------------|---|---|---|
| namespace | http://xml.ir-d.de/emg | | |
| type | restriction of string | | |
| properties | base xs:string | | |
| used by | element | PostoperationAortenklappeBasis/POA_HerzrhythmusSchluessel | |
| facets | Kind | Value | Annotation |
| | enumeration | 0385001 | documentation Sinusrhythmus |
| | enumeration | 0385002 | documentation Vorhofflimmern |
| | enumeration | 0385003 | documentation Patient verstorben (kein Herzrhythmus) |
| | enumeration | 0385042 | documentation anderer Rhythmus |
| annotation | documentation | Kat_AK_HerzrhythmusEntlassung | |
| source | <pre> <simpleType name="enum_0385"> <annotation> <documentation>Kat_AK_HerzrhythmusEntlassung</documentation> </annotation> <restriction base="xs:string"> <enumeration value="0385001"> <annotation> <documentation>Sinusrhythmus</documentation> </annotation> </enumeration> </restriction> </simpleType> </pre> | | |

| | |
|--|--|
| | <pre> </enumeration> <enumeration value="0385002"> <annotation> <documentation>Vorhofflimmern</documentation> </annotation> </enumeration> <enumeration value="0385003"> <annotation> <documentation>Patient verstorben (kein Herzrhythmus)</documentation> </annotation> </enumeration> <enumeration value="0385042"> <annotation> <documentation>anderer Rhythmus</documentation> </annotation> </enumeration> </restriction> </simpleType> </pre> |
|--|--|

simpleType enum_0388

| | | | |
|------------|---|---------|--|
| namespace | http://xml.ir-d.de/emg | | |
| type | restriction of string | | |
| properties | base xs:string | | |
| used by | element PostoperationAortenklappeBasis/POA AggregationshemmerSchlüssel | | |
| facets | Kind | Value | Annotation |
| | enumeration | 0388001 | documentation nein |
| | enumeration | 0388002 | documentation ASS |
| | enumeration | 0388003 | documentation ADP-Rezeptor-Antagonist |
| | enumeration | 0388004 | documentation Kombination ASS und ADP-Rezeptor-Antagonist |
| | enumeration | 0388042 | documentation ja, andere |
| | enumeration | 0388099 | documentation unbekannt |
| annotation | documentation Kat AK Plaettchenaggregationshemmer | | |
| source | <pre> <simpleType name="enum_0388"> <annotation> <documentation>Kat_AK_Plaettchenaggregationshemmer</documentation> </annotation> <restriction base="xs:string"> <enumeration value="0388001"> <annotation> <documentation>nein</documentation> </annotation> </enumeration> <enumeration value="0388002"> <annotation> <documentation>ASS</documentation> </annotation> </enumeration> <enumeration value="0388003"> <annotation> </pre> | | |

| | |
|--|---|
| | <pre> <documentation>ADP-Rezeptor-Antagonist</documentation> </annotation> </enumeration> <enumeration value="0388004"> <annotation> <documentation>Kombination ASS und ADP-Rezeptor-Antagonist</documentation> </annotation> </enumeration> <enumeration value="0388042"> <annotation> <documentation>ja, andere</documentation> </annotation> </enumeration> <enumeration value="0388099"> <annotation> <documentation>unbekannt</documentation> </annotation> </enumeration> </restriction> </simpleType> </pre> |
|--|---|

simpleType enum_0389

| | | | |
|------------|---|--|---|
| namespace | http://xml.ir-d.de/emg | | |
| type | restriction of string | | |
| properties | base xs:string | | |
| used by | element | AntikoagulansAortenklappeBasis/AKA_AntikoagulansSchluessel | |
| facets | Kind | Value | Annotation |
| | enumeration | 0389001 | documentation nein |
| | enumeration | 0389002 | documentation Cumarin-Derivate |
| | enumeration | 0389003 | documentation Heparinoide |
| | enumeration | 0389004 | documentation orale Thrombinantagonisten |
| | enumeration | 0389005 | documentation Kombination Heparinoide und Cumarin-Derivate |
| | enumeration | 0389006 | documentation Direkte orale Antikoagulantien (DOAK / NOAK) |
| | enumeration | 0389042 | documentation ja, andere |
| | enumeration | 0389099 | documentation unbekannt |
| annotation | documentation | Kat_AK_Antikoagulantien | |
| source | <pre> <simpleType name="enum_0389"> <annotation> <documentation>Kat_AK_Antikoagulantien</documentation> </annotation> <restriction base="xs:string"> <enumeration value="0389001"> <annotation> <documentation>nein</documentation> </annotation> </enumeration> </pre> | | |

| | |
|--|---|
| | <pre> <enumeration value="0389002"> <annotation> <documentation>Cumarin-Derivate</documentation> </annotation> </enumeration> <enumeration value="0389003"> <annotation> <documentation>Heparinoide</documentation> </annotation> </enumeration> <enumeration value="0389004"> <annotation> <documentation>orale Thrombinantagonisten</documentation> </annotation> </enumeration> <enumeration value="0389005"> <annotation> <documentation>Kombination Heparinoide und Cumarin-Derivate</documentation> </annotation> </enumeration> <enumeration value="0389006"> <annotation> <documentation>Direkte orale Antikoagulantien (DOAK / NOAK)</documentation> </annotation> </enumeration> <enumeration value="0389042"> <annotation> <documentation>ja, andere</documentation> </annotation> </enumeration> <enumeration value="0389099"> <annotation> <documentation>unbekannt</documentation> </annotation> </enumeration> </restriction> </simpleType> </pre> |
|--|---|

simpleType enum 0390

| | | | |
|------------|--|---------|---|
| namespace | http://xml.ir-d.de/emg | | |
| type | restriction of string | | |
| properties | base xs:string | | |
| used by | element ArtikelAortenklappeBasis/AAK ArtikelTypSchluessel | | |
| facets | Kind | Value | Annotation |
| | enumeration | 0390001 | documentation biologisches Klappenmodell |
| | enumeration | 0390002 | documentation mechanisches Klappenmodell |
| annotation | documentation Kat_AK_Artikeltyp | | |
| source | <pre> <simpleType name="enum_0390"> <annotation> <documentation>Kat_AK_Artikeltyp</documentation> </pre> | | |

| | |
|--|--|
| | <pre> </annotation> <restriction base="xs:string"> <enumeration value="0390001"> <annotation> <documentation>biologisches Klappenmodell</documentation> </annotation> </enumeration> <enumeration value="0390002"> <annotation> <documentation>mechanisches Klappenmodell</documentation> </annotation> </enumeration> </restriction> </simpleType> </pre> |
|--|--|

simpleType enum_0398

| | | | |
|------------|--|---------|--|
| namespace | http://xml.ir-d.de/emg | | |
| type | restriction of string | | |
| properties | base xs:string | | |
| used by | element PostoperationAortenklappeBasis/POA TodesursacheSchluessel | | |
| facets | Kind | Value | Annotation |
| | enumeration | 0398001 | documentation kardiovaskuläre Ursache |
| | enumeration | 0398002 | documentation nicht-kardiovaskuläre Ursache |
| | enumeration | 0398099 | documentation Todesursache unbekannt |
| annotation | documentation Kat_AK_Todesursache | | |
| source | <pre> <simpleType name="enum_0398"> <annotation> <documentation>Kat_AK_Todesursache</documentation> </annotation> <restriction base="xs:string"> <enumeration value="0398001"> <annotation> <documentation>kardiovaskuläre Ursache</documentation> </annotation> </enumeration> <enumeration value="0398002"> <annotation> <documentation>nicht-kardiovaskuläre Ursache</documentation> </annotation> </enumeration> <enumeration value="0398099"> <annotation> <documentation>Todesursache unbekannt</documentation> </annotation> </enumeration> </restriction> </simpleType> </pre> | | |

simpleType enum_0399

| | | | |
|------------|--|---------|--|
| namespace | http://xml.ir-d.de/emg | | |
| type | restriction of string | | |
| properties | base xs:string | | |
| used by | element PostoperationAortenklappeBasis/POA VitalstatusSchluessel | | |
| facets | Kind | Value | Annotation |
| | enumeration | 0399001 | documentation Patient lebt |
| | enumeration | 0399002 | documentation Patient im Krankenhaus verstorben |
| annotation | documentation Kat_AK_Vitalstatus | | |
| source | <pre> <simpleType name="enum_0399"> <annotation> <documentation>Kat_AK_Vitalstatus</documentation> </annotation> <restriction base="xs:string"> <enumeration value="0399001"> <annotation> <documentation>Patient lebt</documentation> </annotation> </enumeration> <enumeration value="0399002"> <annotation> <documentation>Patient im Krankenhaus verstorben</documentation> </annotation> </enumeration> </restriction> </simpleType> </pre> | | |

complexType PatientenaufnahmeBasis

| | |
|-----------|--|
| diagram | |
| namespace | http://xml.ir-d.de/emg |
| children | PAT_Alter PAT_Groesse PAT_Gewicht PAT_GeschlechtSchluessel |
| used by | complexType Patientenaufnahme |
| source | <pre> <complexType name="PatientenaufnahmeBasis"> <sequence> <element name="PAT_Alter" type="xs:integer"/> <element name="PAT_Groesse" type="xs:integer" minOccurs="0"/> <element name="PAT_Gewicht" type="xs:integer" minOccurs="0"/> <element name="PAT_GeschlechtSchluessel" type="enum_0070"/> </sequence> </complexType> </pre> |

| | |
|--|---|
| | <pre></sequence> </complexType></pre> |
|--|---|

element **PatientenaufnahmeBasis/PAT_Alter**

| | |
|------------|--|
| diagram | |
| type | integer |
| properties | content simple |
| source | <pre><element name="PAT_Alter" type="xs:integer"/></pre> |

element **PatientenaufnahmeBasis/PAT_Groesse**

| | |
|------------|--|
| diagram | |
| type | integer |
| properties | minOcc 0 maxOcc 1 content simple |
| source | <pre><element name="PAT_Groesse" type="xs:integer" minOccurs="0"/></pre> |

element **PatientenaufnahmeBasis/PAT_Gewicht**

| | |
|------------|--|
| diagram | |
| type | integer |
| properties | minOcc 0 maxOcc 1 content simple |
| source | <pre><element name="PAT_Gewicht" type="xs:integer" minOccurs="0"/></pre> |

element **PatientenaufnahmeBasis/PAT_GeschlechtSchluessel**

| diagram | | | | | | | | | | | | | | | | |
|-------------|--|------------------------|-------|------------|-------------|---------|------------------------|-------------|---------|------------------------|-------------|---------|----------------------|-------------|---------|---------------|
| type | enum_0070 | | | | | | | | | | | | | | | |
| properties | content simple | | | | | | | | | | | | | | | |
| facets | <table border="1"> <thead> <tr> <th>Kind</th> <th>Value</th> <th>Annotation</th> </tr> </thead> <tbody> <tr> <td>enumeration</td> <td>0070001</td> <td>documentation weiblich</td> </tr> <tr> <td>enumeration</td> <td>0070002</td> <td>documentation männlich</td> </tr> <tr> <td>enumeration</td> <td>0070003</td> <td>documentation divers</td> </tr> <tr> <td>enumeration</td> <td>0070042</td> <td>documentation</td> </tr> </tbody> </table> | Kind | Value | Annotation | enumeration | 0070001 | documentation weiblich | enumeration | 0070002 | documentation männlich | enumeration | 0070003 | documentation divers | enumeration | 0070042 | documentation |
| Kind | Value | Annotation | | | | | | | | | | | | | | |
| enumeration | 0070001 | documentation weiblich | | | | | | | | | | | | | | |
| enumeration | 0070002 | documentation männlich | | | | | | | | | | | | | | |
| enumeration | 0070003 | documentation divers | | | | | | | | | | | | | | |
| enumeration | 0070042 | documentation | | | | | | | | | | | | | | |

| | |
|--------|---|
| | unbestimmt |
| source | <element name="PAT_GeschlechtSchluessel" type="enum_0070"/> |

complexType **PatientenaufnahmeBrustimplantatBasis**

| | |
|-----------|---|
| diagram | |
| namespace | http://xml.ir-d.de/emg |
| children | PAB_AutoimmunerkrankungSchluessel PAB_VerlaufAutoimmunerkrankungSchluessel |
| used by | element Patientenaufnahme/patientenaufnahmeBrustimplantat |
| source | <pre><complexType name="PatientenaufnahmeBrustimplantatBasis"> <sequence> <element name="PAB_AutoimmunerkrankungSchluessel" type="enum_0122"/> <element name="PAB_VerlaufAutoimmunerkrankungSchluessel" type="enum_0123" minOccurs="0"/> </sequence> </complexType></pre> |

element **PatientenaufnahmeBrustimplantatBasis/PAB_AutoimmunerkrankungSchluessel**

| diagram | | | | | | | | | | | | | |
|-------------|--|--|-------|------------|-------------|---------|--|-------------|---------|-----------------------|-------------|---------|----------------------------|
| type | enum 0122 | | | | | | | | | | | | |
| properties | content simple | | | | | | | | | | | | |
| facets | <table border="1"> <thead> <tr> <th>Kind</th> <th>Value</th> <th>Annotation</th> </tr> </thead> <tbody> <tr> <td>enumeration</td> <td>0122001</td> <td>documentation ja, ärztlich nachgewiesen</td> </tr> <tr> <td>enumeration</td> <td>0122002</td> <td>documentation nein</td> </tr> <tr> <td>enumeration</td> <td>0122042</td> <td>documentation unbekannt</td> </tr> </tbody> </table> | Kind | Value | Annotation | enumeration | 0122001 | documentation ja, ärztlich nachgewiesen | enumeration | 0122002 | documentation nein | enumeration | 0122042 | documentation unbekannt |
| Kind | Value | Annotation | | | | | | | | | | | |
| enumeration | 0122001 | documentation ja, ärztlich nachgewiesen | | | | | | | | | | | |
| enumeration | 0122002 | documentation nein | | | | | | | | | | | |
| enumeration | 0122042 | documentation unbekannt | | | | | | | | | | | |
| source | <element name="PAB_AutoimmunerkrankungSchluessel" type="enum_0122"/> | | | | | | | | | | | | |

element **PatientenaufnahmeBrustimplantatBasis/PAB_VerlaufAutoimmunerkrankungSchluessel**

| diagram | | | | | | | |
|-------------|---|----------------------------------|-------|------------|-------------|---------|----------------------------------|
| type | enum 0123 | | | | | | |
| properties | minOcc 0 maxOcc 1 content simple | | | | | | |
| facets | <table border="1"> <thead> <tr> <th>Kind</th> <th>Value</th> <th>Annotation</th> </tr> </thead> <tbody> <tr> <td>enumeration</td> <td>0123001</td> <td>documentation neu aufgetreten</td> </tr> </tbody> </table> | Kind | Value | Annotation | enumeration | 0123001 | documentation neu aufgetreten |
| Kind | Value | Annotation | | | | | |
| enumeration | 0123001 | documentation neu aufgetreten | | | | | |

| | | | | |
|--------|--|---------|---------------|-----------------------------------|
| | enumeration | 0123002 | documentation | verschlechtert |
| | enumeration | 0123003 | documentation | keine Veränderung |
| | enumeration | 0123004 | documentation | nicht relevant, da Primäreingriff |
| | enumeration | 0123042 | documentation | unbekannt |
| source | <code><element name="PAB_VerlaufAutoimmunerkrankungSchluessel" type="enum_0123" minOccurs="0"/></code> | | | |

complexType **PatientenaufnahmeKardiologie**

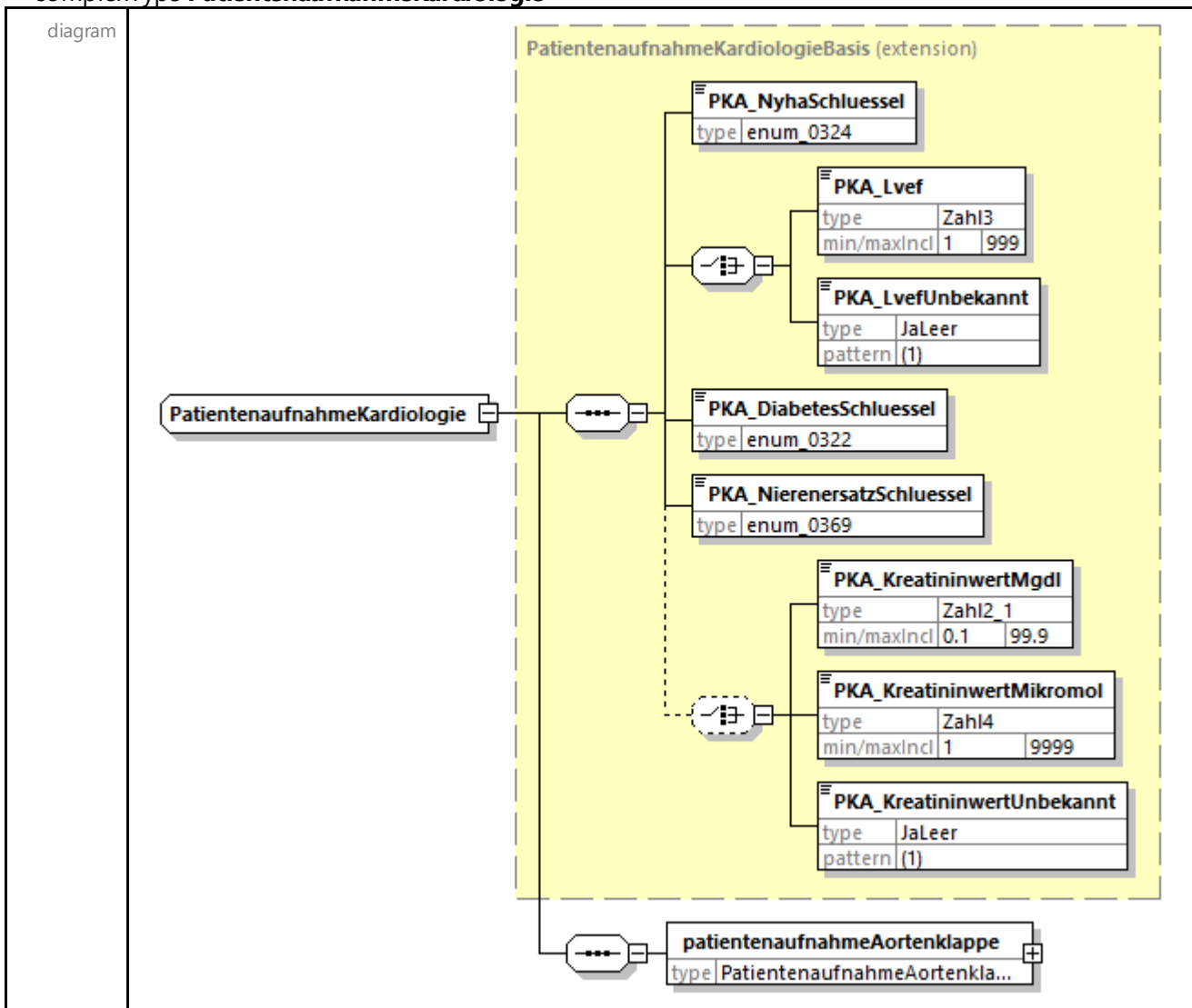

| | |
|------------|--|
| namespace | http://xml.ir-d.de/emg |
| type | extension of PatientenaufnahmeKardiologieBasis |
| properties | base PatientenaufnahmeKardiologieBasis |
| children | PKA NyhaSchluessel PKA Lvef PKA LvefUnbekannt PKA DiabetesSchluessel PKA NierenersatzSchluessel PKA KreatininwertMgdl PKA KreatininwertMikromol PKA KreatininwertUnbekannt patientenaufnahmeAortenklappe |
| used by | element Patientenaufnahme/patientenaufnahmeKardiologie |

source

```
<complexType name="PatientenaufnahmeKardiologie">  
  <complexContent>  
    <extension base="PatientenaufnahmeKardiologieBasis">  
      <sequence>  
        <element name="patientenaufnahmeAortenklappe"  
type="PatientenaufnahmeAortenklappe"/>  
      </sequence>  
    </extension>  
  </complexContent>  
</complexType>
```

element **PatientenaufnahmeKardiologie/patientenaufnahmeAortenklappe**

diagram

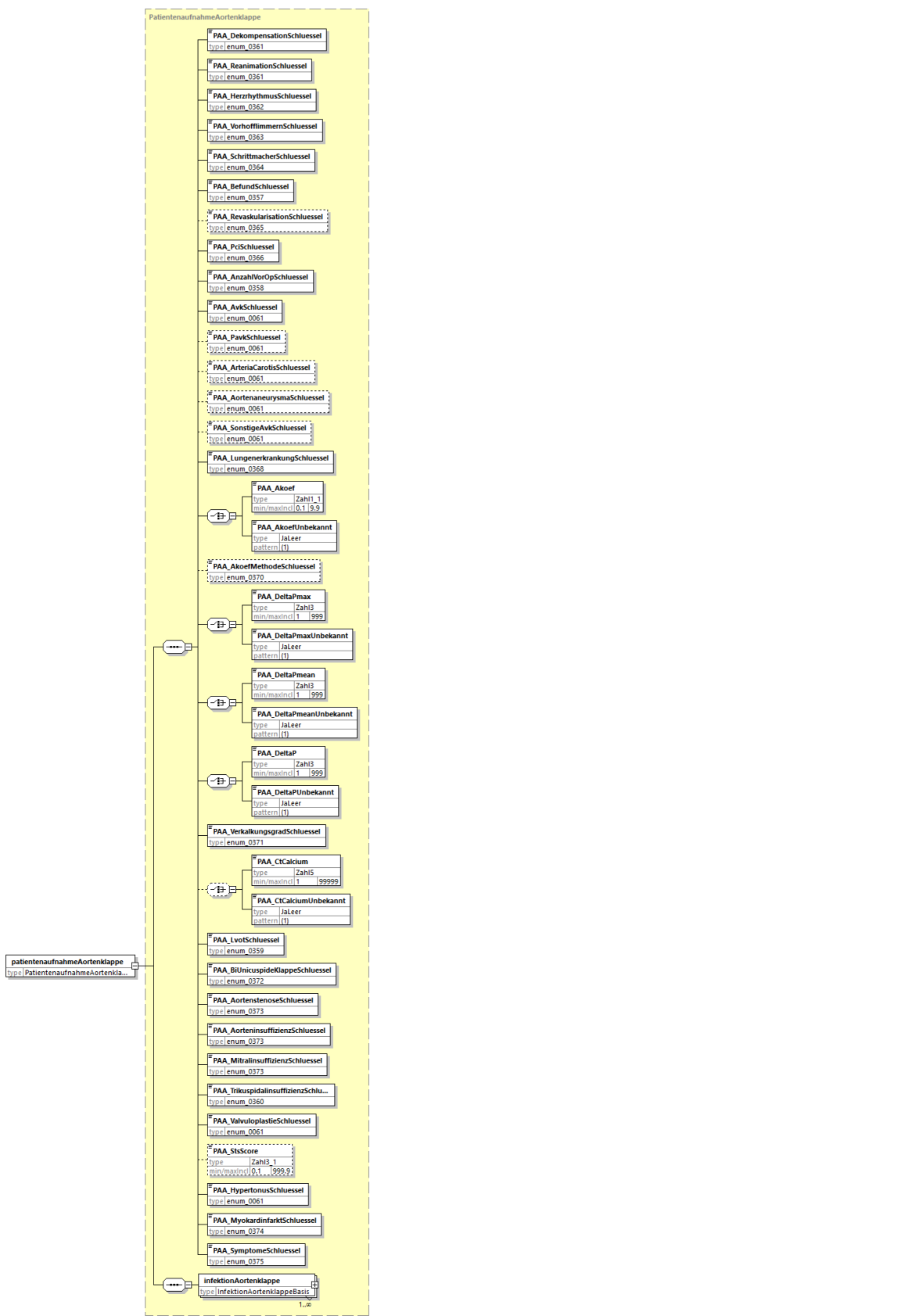

type **PatientenaufnahmeAortenklappe**

properties content complex

| | |
|----------|---|
| children | PAA DekompensationSchluessel PAA ReanimationSchluessel PAA HerzrhythmusSchluessel PAA VorhofflimmernSchluessel PAA SchrittmacherSchluessel PAA BefundSchluessel PAA RevaskularisationSchluessel PAA PciSchluessel PAA AnzahlVorOpSchluessel PAA AvkSchluessel PAA PavkSchluessel PAA ArteriaCarotisSchluessel PAA AortenaneurysmaSchluessel PAA SonstigeAvkSchluessel PAA LungenerkrankungSchluessel PAA Akoef PAA AkoefUnbekannt PAA AkoefMethodeSchluessel PAA DeltaPmax PAA DeltaPmaxUnbekannt PAA DeltaPmean PAA DeltaPmeanUnbekannt PAA DeltaP PAA DeltaPUnbekannt PAA VerkalkungsgradSchluessel PAA CtCalcium PAA CtCalciumUnbekannt PAA LvotSchluessel PAA BiUnicuspideKlappeSchluessel PAA AortenstenoseSchluessel PAA AorteninsuffizienzSchluessel PAA MitralinsuffizienzSchluessel PAA TrikuspidalinsuffizienzSchluessel PAA ValvuloplastieSchluessel PAA StsScore PAA HypertonusSchluessel PAA MyokardinfarktSchluessel PAA SymptomeSchluessel infektionAortenklappe |
| source | <pre><element name="patientenaufnahmeAortenklappe" type="PatientenaufnahmeAortenklappe"/></pre> |

complexType **OperationBasis**

| | |
|-----------|---|
| diagram | |
| namespace | http://xml.ir-d.de/emg |
| children | OPE LaufendeNumer OPE Datum OPE SeitenLokalisationSchluessel OPE AsaSchluessel OPE ImplantattypSchluessel |
| used by | complexType Operation |
| source | <pre><complexType name="OperationBasis"> <sequence> <element name="OPE_LaufendeNumer" type="Zahl3"/> <element name="OPE_Datum" type="xs:date"/> <element name="OPE_SeitenLokalisationSchluessel" type="enum_0050" minOccurs="0"/> <element name="OPE_AsaSchluessel" type="enum_0044"/> <element name="OPE_ImplantattypSchluessel" type="enum_0080"/> </sequence> </complexType></pre> |

element **OperationBasis/OPE_LaufendeNumer**

| | |
|---------|--|
| diagram | |
|---------|--|

| type | Zahl3 | | | | | | | | | |
|--------------|---|------------|-------|------------|--------------|---|--|--------------|-----|--|
| properties | content simple | | | | | | | | | |
| facets | <table border="1"> <thead> <tr> <th>Kind</th> <th>Value</th> <th>Annotation</th> </tr> </thead> <tbody> <tr> <td>minInclusive</td> <td>1</td> <td></td> </tr> <tr> <td>maxInclusive</td> <td>999</td> <td></td> </tr> </tbody> </table> | Kind | Value | Annotation | minInclusive | 1 | | maxInclusive | 999 | |
| Kind | Value | Annotation | | | | | | | | |
| minInclusive | 1 | | | | | | | | | |
| maxInclusive | 999 | | | | | | | | | |
| source | <code><element name="OPE_LaufendeNummer" type="Zahl3"/></code> | | | | | | | | | |

element **OperationBasis/OPE_Datum**

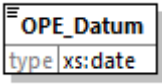
| | |
|------------|---|
| diagram |  |
| type | date |
| properties | content simple |
| source | <code><element name="OPE_Datum" type="xs:date"/></code> |

element **OperationBasis/OPE_SeitenLokalisationSchluessel**

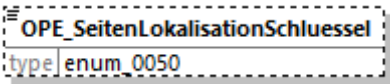
| diagram |  | | | | | | | | | |
|-------------|--|-------------------------|-------|------------|-------------|---------|-------------------------|-------------|---------|------------------------|
| type | enum_0050 | | | | | | | | | |
| properties | <table border="1"> <tbody> <tr> <td>minOcc</td> <td>0</td> </tr> <tr> <td>maxOcc</td> <td>1</td> </tr> <tr> <td>content</td> <td>simple</td> </tr> </tbody> </table> | minOcc | 0 | maxOcc | 1 | content | simple | | | |
| minOcc | 0 | | | | | | | | | |
| maxOcc | 1 | | | | | | | | | |
| content | simple | | | | | | | | | |
| facets | <table border="1"> <thead> <tr> <th>Kind</th> <th>Value</th> <th>Annotation</th> </tr> </thead> <tbody> <tr> <td>enumeration</td> <td>0050001</td> <td>documentation rechts</td> </tr> <tr> <td>enumeration</td> <td>0050002</td> <td>documentation links</td> </tr> </tbody> </table> | Kind | Value | Annotation | enumeration | 0050001 | documentation rechts | enumeration | 0050002 | documentation links |
| Kind | Value | Annotation | | | | | | | | |
| enumeration | 0050001 | documentation rechts | | | | | | | | |
| enumeration | 0050002 | documentation links | | | | | | | | |
| source | <code><element name="OPE_SeitenLokalisationSchluessel" type="enum_0050" minOccurs="0"/></code> | | | | | | | | | |

element **OperationBasis/OPE_AsaSchluessel**

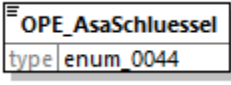
| diagram |  | | | | | | | | | | | | | | | |
|-------------|--|---|-------|------------|-------------|---------|--|-------------|---------|--|-------------|---------|--|-------------|---------|---|
| type | enum_0044 | | | | | | | | | | | | | | | |
| properties | content simple | | | | | | | | | | | | | | | |
| facets | <table border="1"> <thead> <tr> <th>Kind</th> <th>Value</th> <th>Annotation</th> </tr> </thead> <tbody> <tr> <td>enumeration</td> <td>0044001</td> <td>documentation 1= normaler, sonst gesunder Patient</td> </tr> <tr> <td>enumeration</td> <td>0044002</td> <td>documentation 2= Patient mit leichter Allgemeinerkrankung</td> </tr> <tr> <td>enumeration</td> <td>0044003</td> <td>documentation 3= Patient mit schwerer Allgemeinerkrankung</td> </tr> <tr> <td>enumeration</td> <td>0044004</td> <td>documentation 4= Patient mit schwerer Allgemeinerkrankung, die eine ständige Lebensbedrohung darstellt</td> </tr> </tbody> </table> | Kind | Value | Annotation | enumeration | 0044001 | documentation 1= normaler, sonst gesunder Patient | enumeration | 0044002 | documentation 2= Patient mit leichter Allgemeinerkrankung | enumeration | 0044003 | documentation 3= Patient mit schwerer Allgemeinerkrankung | enumeration | 0044004 | documentation 4= Patient mit schwerer Allgemeinerkrankung, die eine ständige Lebensbedrohung darstellt |
| Kind | Value | Annotation | | | | | | | | | | | | | | |
| enumeration | 0044001 | documentation 1= normaler, sonst gesunder Patient | | | | | | | | | | | | | | |
| enumeration | 0044002 | documentation 2= Patient mit leichter Allgemeinerkrankung | | | | | | | | | | | | | | |
| enumeration | 0044003 | documentation 3= Patient mit schwerer Allgemeinerkrankung | | | | | | | | | | | | | | |
| enumeration | 0044004 | documentation 4= Patient mit schwerer Allgemeinerkrankung, die eine ständige Lebensbedrohung darstellt | | | | | | | | | | | | | | |

| | |
|--------|---|
| | enumeration 0044005 documentation 5= moribunder Patient, der ohne die Operation voraussichtlich nicht überleben wird |
| source | <element name="OPE_AsaSchluessel" type="enum_0044"/> |

element **OperationBasis/OPE_ImplantattypSchluessel**

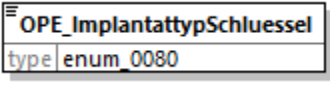
| diagram |  | | | | | | | | | | | | |
|-------------|--|--|-------|------------|-------------|---------|--|-------------|---------|---------------------------------|-------------|---------|--|
| type | enum_0080 | | | | | | | | | | | | |
| properties | content simple | | | | | | | | | | | | |
| facets | <table border="1"> <thead> <tr> <th>Kind</th> <th>Value</th> <th>Annotation</th> </tr> </thead> <tbody> <tr> <td>enumeration</td> <td>0080001</td> <td>documentation Endoprothese Hüfte/Knie</td> </tr> <tr> <td>enumeration</td> <td>0080002</td> <td>documentation Brustimplantat</td> </tr> <tr> <td>enumeration</td> <td>0080003</td> <td>documentation Aortenklappenprothese</td> </tr> </tbody> </table> | Kind | Value | Annotation | enumeration | 0080001 | documentation Endoprothese Hüfte/Knie | enumeration | 0080002 | documentation Brustimplantat | enumeration | 0080003 | documentation Aortenklappenprothese |
| Kind | Value | Annotation | | | | | | | | | | | |
| enumeration | 0080001 | documentation Endoprothese Hüfte/Knie | | | | | | | | | | | |
| enumeration | 0080002 | documentation Brustimplantat | | | | | | | | | | | |
| enumeration | 0080003 | documentation Aortenklappenprothese | | | | | | | | | | | |
| source | <element name="OPE_ImplantattypSchluessel" type="enum_0080"/> | | | | | | | | | | | | |

complexType **OperationBrustimplantat**

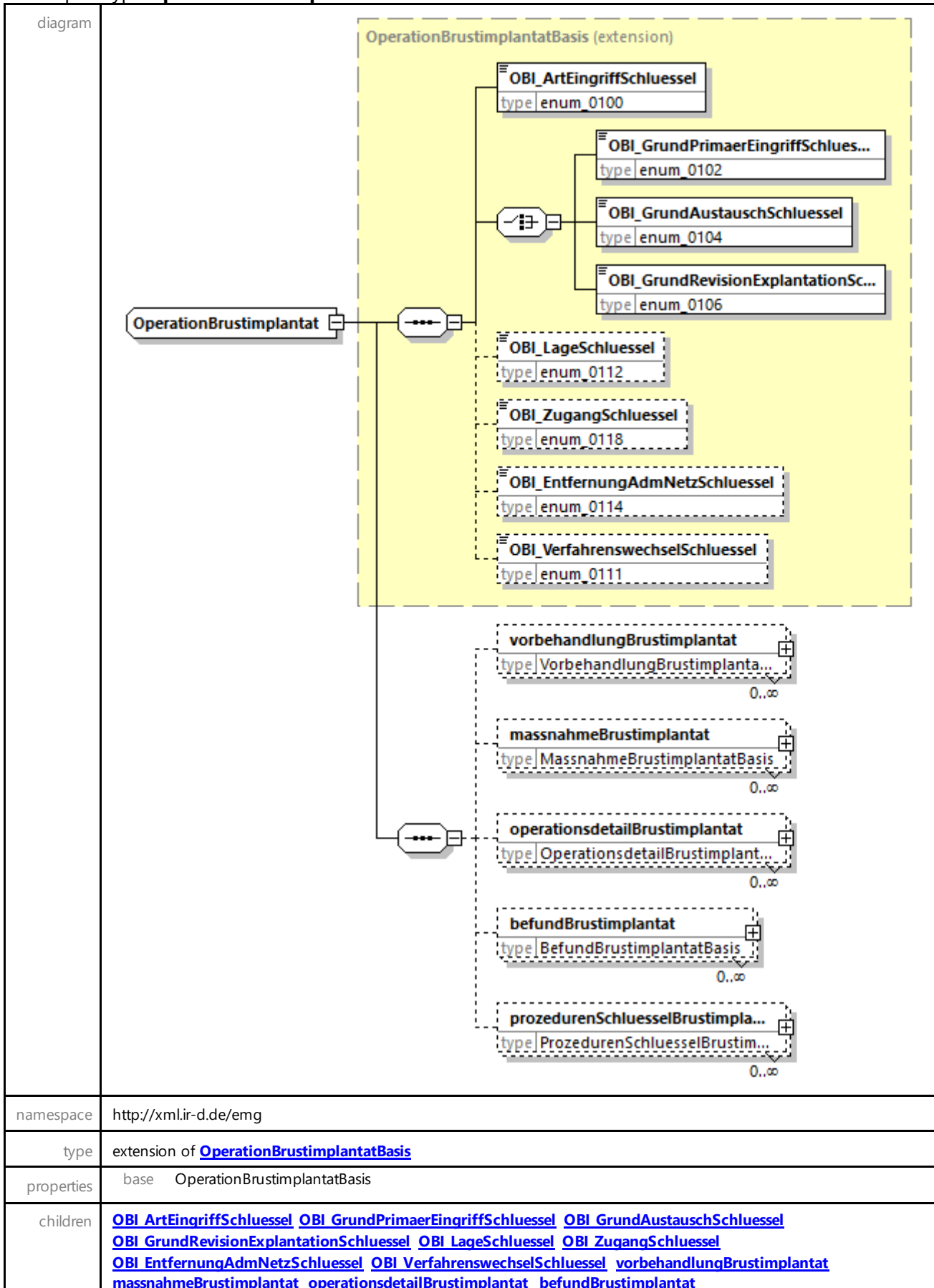

| | |
|---------|---|
| | prozedurenSchluesselBrustimplantat |
| used by | element Operation/operationBrustimplantat |
| source | <pre> <complexType name="OperationBrustimplantat"> <complexContent> <extension base="OperationBrustimplantatBasis"> <sequence> <element name="vorbehandlungBrustimplantat" type="VorbehandlungBrustimplantatBasis" minOccurs="0" maxOccurs="unbounded"/> <element name="massnahmeBrustimplantat" type="MassnahmeBrustimplantatBasis" minOccurs="0" maxOccurs="unbounded"/> <element name="operationsdetailBrustimplantat" type="OperationsdetailBrustimplantatBasis" minOccurs="0" maxOccurs="unbounded"/> <element name="befundBrustimplantat" type="BefundBrustimplantatBasis" minOccurs="0" maxOccurs="unbounded"/> <element name="prozedurenSchluesselBrustimplantat" type="ProzedurenSchluesselBrustimplantatBasis" minOccurs="0" maxOccurs="unbounded"/> </sequence> </extension> </complexContent> </complexType> </pre> |

element [OperationBrustimplantat/vorbehandlungBrustimplantat](#)

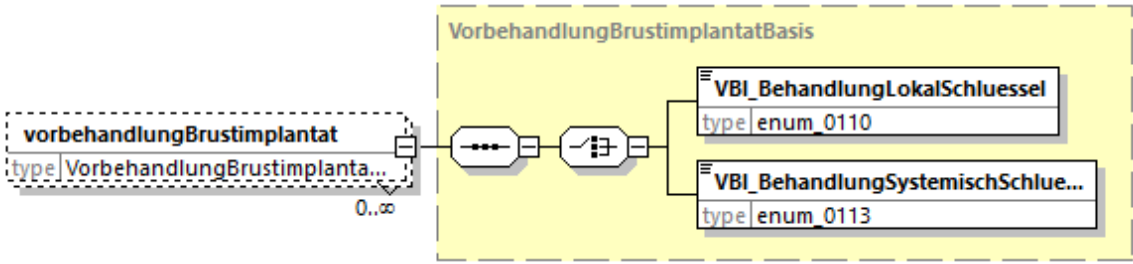
| | |
|------------|--|
| diagram |  |
| type | VorbehandlungBrustimplantatBasis |
| properties | minOcc 0 maxOcc unbounded content complex |
| children | VBI BehandlungLokalSchluessel VBI BehandlungSystemischSchluessel |
| source | <pre> <element name="vorbehandlungBrustimplantat" type="VorbehandlungBrustimplantatBasis" minOccurs="0" maxOccurs="unbounded"/> </pre> |

element [OperationBrustimplantat/massnahmeBrustimplantat](#)

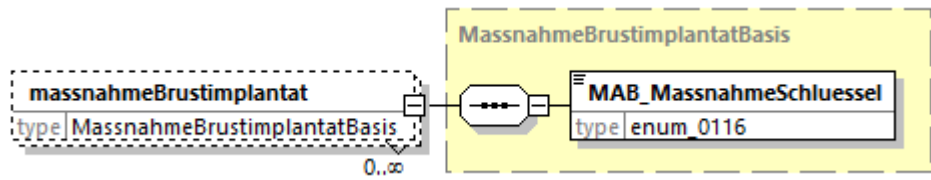
| | |
|------------|--|
| diagram |  |
| type | MassnahmeBrustimplantatBasis |
| properties | minOcc 0 maxOcc unbounded |

| | |
|----------|--|
| | content complex |
| children | MAB MassnahmeSchluessel |
| source | <code><element name="massnahmeBrustimplantat" type="MassnahmeBrustimplantatBasis" minOccurs="0" maxOccurs="unbounded"/></code> |

element **OperationBrustimplantat/operationsdetailBrustimplantat**

| | |
|------------|---|
| diagram | |
| type | OperationsdetailBrustimplantatBasis |
| properties | minOcc 0 maxOcc unbounded content complex |
| children | ODB_OperationsdetailPrimaerEingriffSchluessel ODB_OperationsdetailAustauschSchluessel ODB_OperationsdetailRevisionSchluessel |
| source | <code><element name="operationsdetailBrustimplantat" type="OperationsdetailBrustimplantatBasis" minOccurs="0" maxOccurs="unbounded"/></code> |

element **OperationBrustimplantat/befundBrustimplantat**

| | |
|------------|--|
| diagram | |
| type | BefundBrustimplantatBasis |
| properties | minOcc 0 maxOcc unbounded content complex |
| children | BEB_BefundSchluessel BEB_BefundAustauschSchluessel |
| source | <code><element name="befundBrustimplantat" type="BefundBrustimplantatBasis" minOccurs="0" maxOccurs="unbounded"/></code> |

element **OperationBrustimplantat/prozedurenSchluesselBrustimplantat**

| | |
|------------|--|
| diagram | |
| type | ProzedurenSchluesselBrustimplantatBasis |
| properties | minOcc 0 maxOcc unbounded content complex |
| children | PBI_ProzedurenSchluessel |
| source | <pre><element name="prozedurenSchluesselBrustimplantat" type="ProzedurenSchluesselBrustimplantatBasis" minOccurs="0" maxOccurs="unbounded"/></pre> |

complexType **OperationEndoprothese**

diagram

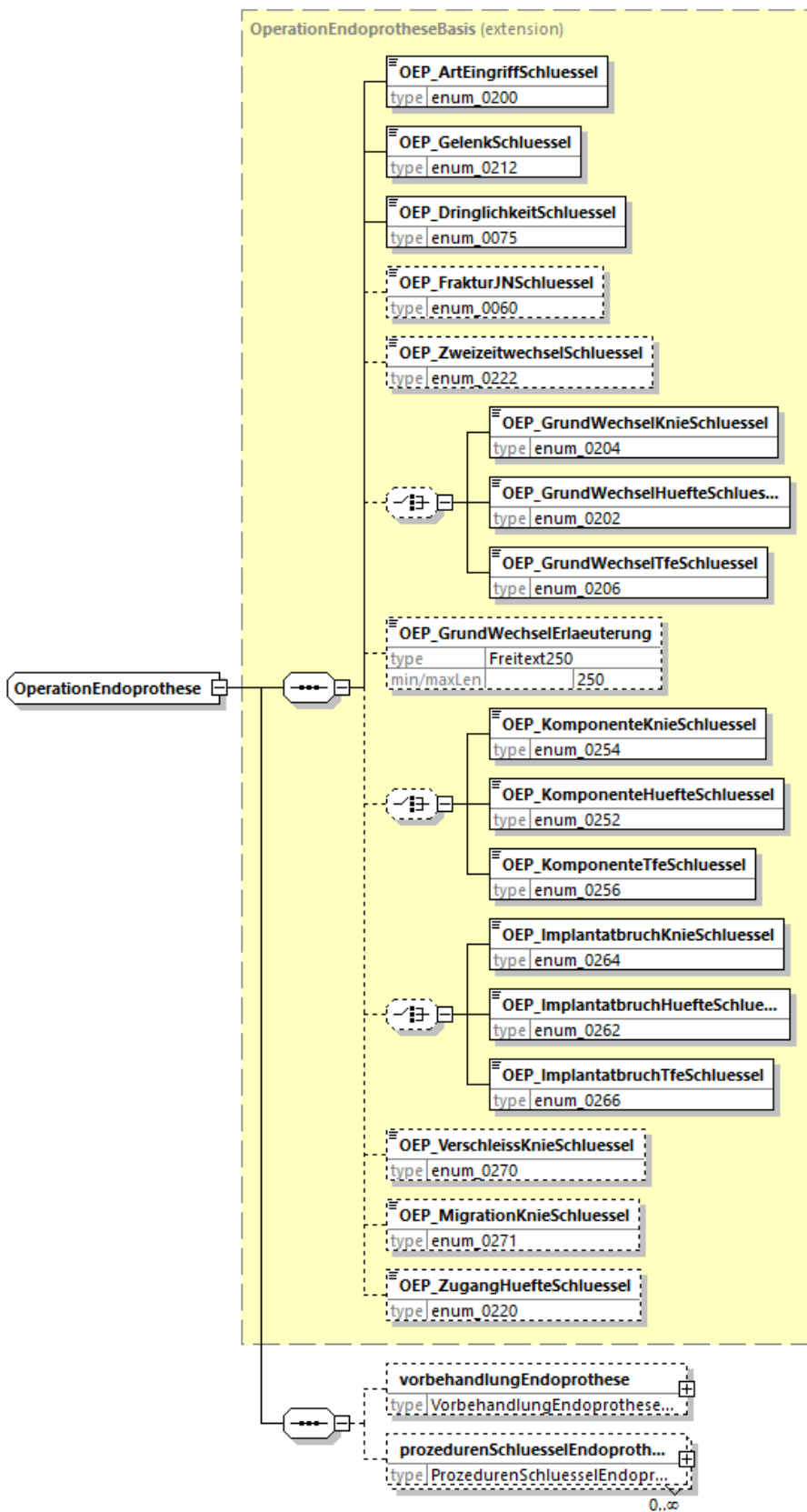

| | |
|-----------|---|
| namespace | http://xml.ir-d.de/emg |
| type | extension of OperationEndoprotheseBasis |

| | |
|------------|---|
| properties | base OperationEndoprotheseBasis |
| children | OEP ArtEingriffSchluessel OEP GelenkSchluessel OEP DringlichkeitSchluessel OEP FrakturJNSchluessel OEP ZweizeitwechselSchluessel OEP GrundWechselKnieSchluessel OEP GrundWechselHuefteSchluessel OEP GrundWechselTfeSchluessel OEP GrundWechselErlaeuterung OEP KomponenteKnieSchluessel OEP KomponenteHuefteSchluessel OEP KomponenteTfeSchluessel OEP ImplantatbruchKnieSchluessel OEP ImplantatbruchHuefteSchluessel OEP ImplantatbruchTfeSchluessel OEP VerschleissKnieSchluessel OEP MigrationKnieSchluessel OEP ZugangHuefteSchluessel vorbehandlungEndoprothese prozedurenSchluesselEndoprothese |
| used by | element Operation/operationEndoprothese |
| source | <pre> <complexType name="OperationEndoprothese"> <complexContent> <extension base="OperationEndoprotheseBasis"> <sequence> <element name="vorbehandlungEndoprothese" type="VorbehandlungEndoprotheseBasis" minOccurs="0"/> <element name="prozedurenSchluesselEndoprothese" type="ProzedurenSchluesselEndoprotheseBasis" minOccurs="0" maxOccurs="unbounded"/> </sequence> </extension> </complexContent> </complexType> </pre> |

element **OperationEndoprothese/vorbehandlungEndoprothese**

| | |
|------------|---|
| diagram | |
| type | VorbehandlungEndoprotheseBasis |
| properties | minOcc 0 maxOcc 1 content complex |
| children | VEP_VorOpKnieSchluessel VEP_VorOpHuefteSchluessel VEP_VorOpErlaeuterung |
| source | <pre> <element name="vorbehandlungEndoprothese" type="VorbehandlungEndoprotheseBasis" minOccurs="0"/> </pre> |

element **OperationEndoprothese/prozedurenSchluesselEndoprothese**

| | |
|------------|---|
| diagram | <p>The diagram shows a class 'prozedurenSchluesselEndoproth...' with a multiplicity of 0..∞ connected to a class 'PEP_ProzedurenSchluessel'. The 'PEP_ProzedurenSchluessel' class has a type of 'OPS' and a pattern of '(((135689)\-[0-9]){2}){([a-zA-Z0-9]...)'. The diagram is titled 'ProzedurenSchluesselEndoprothes...'.</p> |
| type | ProzedurenSchluesselEndoprotheseBasis |
| properties | minOcc 0 maxOcc unbounded content complex |
| children | PEP_ProzedurenSchluessel |
| source | <pre><element name="prozedurenSchluesselEndoprothese" type="ProzedurenSchluesselEndoprotheseBasis" minOccurs="0" maxOccurs="unbounded"/></pre> |

| | |
|------------|--|
| properties | base OperationAortenklappeBasis |
| children | OAK NummerEingriff OAK ArtEingriffSchluessel OAK GrundEingriffSchluessel OAK DringlichkeitSchluessel OAK ExplantationSchluessel OAK IsoliertSchluessel OAK ZugangKonventionellSchluessel OAK ZugangKatheterSchluessel OAK KomplikationenSchluessel OAK TherapieLcoSchluessel OAK Durchleuchtungszeit OAK BeatmungSchluessel OAK TroponinSchluessel OAK InotropeSchluessel OAK Eingriffsdauer OAK EingriffsumfangSchluessel OAK ProzedurenAnzahl OAK VorgehenSchluessel OAK Bypasszeit OAK BypasszeitUnbekannt OAK Abklemmzeit OAK AbklemmzeitUnbekannt OAK AortaThorakalSchluessel OAK NeuroprotektionSchluessel OAK KreislaufunterstuetzungSchluessel OAK PraeOpUnterstuetzungSchluessel OAK PraeOpMethodeSchluessel OAK IntraOpUnterstuetzungSchluessel OAK IntraOpMethodeSchluessel OAK AortenklappenOpAnzahl OAK ValvelnValveSchluessel OAK ZugangsGefaessdiameter OAK ZugangsGefaessUnbekannt OAK ZugangVerkalkungSchluessel OAK Aortenklappenannulus OAK MessmethodeSchluessel OAK DistanzRca OAK DistanzRcaUnbekannt OAK DistanzLca OAK DistanzLcaUnbekannt OAK PtcaVorSchluessel OAK PtcaVorDurchmesser OAK PtcaVorDurchmesserUnbekannt OAK PtcaVorAnzahl OAK RapidPacingVorSchluessel OAK RapidPacingIntraSchluessel OAK PtcaNachSchluessel OAK PtcaNachDurchmesser OAK PtcaNachDurchmesserUnbekannt OAK PtcaNachAnzahl OAK RapidPacingNachSchluessel OAK KonversionSchluessel OAK SuccessSchluessel OAK AnaesthesieSchluessel OAK DeltaPmeanNachOp OAK DeltaPmeanNachOpUnbekannt OAK ResidualeInsuffizienzSchluessel OAK ZugangVerschlussSchluessel OAK ZusätzlichePciSchluessel OAK PciWegenKhkSchluessel OAK PciWegenKomplikationSchluessel OAK LaesionenAnzahl komplikationAortenklappe taviAortenklappe pciAortenklappe failureGrundAortenklappe prozedurenSchluesselAortenklappe |
| used by | element Operation/operationAortenklappe |
| source | <pre> <complexType name="OperationAortenklappe"> <complexContent> <extension base="OperationAortenklappeBasis"> <sequence> <element name="komplikationAortenklappe" type="KomplikationAortenklappeBasis" minOccurs="0" maxOccurs="unbounded"/> <element name="taviAortenklappe" type="TaviAortenklappeBasis" minOccurs="0" maxOccurs="unbounded"/> <element name="pciAortenklappe" type="PciAortenklappeBasis" minOccurs="0" maxOccurs="unbounded"/> <element name="failureGrundAortenklappe" type="FailureGrundAortenklappeBasis" minOccurs="0" maxOccurs="unbounded"/> <element name="prozedurenSchluesselAortenklappe" type="ProzedurenSchluesselAortenklappeBasis" minOccurs="0" maxOccurs="unbounded"/> </sequence> </extension> </complexContent> </complexType> </pre> |

element **OperationAortenklappe/komplikationAortenklappe**

| | |
|------------|---|
| diagram | |
| type | KomplikationAortenklappeBasis |
| properties | minOcc 0 maxOcc unbounded content complex |
| children | KAK KomplikationTypSchluessel |

| | |
|--------|--|
| source | <code><element name="komplikationAortenklappe" type="KomplikationAortenklappeBasis" minOccurs="0" maxOccurs="unbounded"/></code> |
|--------|--|

element **OperationAortenklappe/taviAortenklappe**

| | |
|------------|--|
| diagram | |
| type | TaviAortenklappeBasis |
| properties | minOcc 0 maxOcc unbounded content complex |
| children | TAK GrundTaviSchlüssel |
| source | <code><element name="taviAortenklappe" type="TaviAortenklappeBasis" minOccurs="0" maxOccurs="unbounded"/></code> |

element **OperationAortenklappe/pciAortenklappe**

| | |
|------------|--|
| diagram | |
| type | PciAortenklappeBasis |
| properties | minOcc 0 maxOcc unbounded content complex |
| children | PCA PciArterienSchlüssel |
| source | <code><element name="pciAortenklappe" type="PciAortenklappeBasis" minOccurs="0" maxOccurs="unbounded"/></code> |

element **OperationAortenklappe/failureGrundAortenklappe**

| | |
|------------|--|
| diagram | |
| type | FailureGrundAortenklappeBasis |
| properties | minOcc 0 maxOcc unbounded content complex |
| children | FAK FailureGrundSchlüssel |
| source | <code><element name="failureGrundAortenklappe" type="FailureGrundAortenklappeBasis" minOccurs="0" maxOccurs="unbounded"/></code> |

`minOccurs="0" maxOccurs="unbounded"/>`

element **OperationAortenklappe/prozedurenSchluesselAortenklappe**

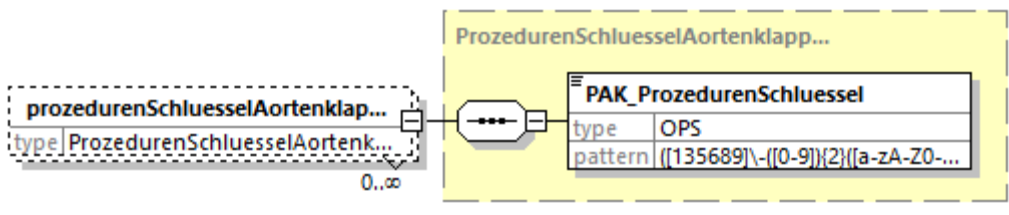
| | | | | | |
|------------|---|------|-----|---------|---------------------------------------|
| diagram |  <p>The diagram illustrates a relationship between two elements. On the left, a dashed box represents the element 'prozedurenSchluesselAortenklappe' with a multiplicity of '0..∞'. This is connected to a yellow box representing the element 'ProzedurenSchluesselAortenklappe'. Inside this yellow box, there is a table for the element 'PAK_ProzedurenSchluessel' with the following properties:</p> <table border="1"><tr><td>type</td><td>OPS</td></tr><tr><td>pattern</td><td>{([135689]\- [0-9]){2}([a-zA-Z0-9]...</td></tr></table> | type | OPS | pattern | {([135689]\- [0-9]){2}([a-zA-Z0-9]... |
| type | OPS | | | | |
| pattern | {([135689]\- [0-9]){2}([a-zA-Z0-9]... | | | | |
| type | ProzedurenSchluesselAortenklappeBasis | | | | |
| properties | minOcc 0 maxOcc unbounded content complex | | | | |
| children | PAK_ProzedurenSchluessel | | | | |
| source | <code><element name="prozedurenSchluesselAortenklappe" type="ProzedurenSchluesselAortenklappeBasis" minOccurs="0" maxOccurs="unbounded"/></code> | | | | |

complexType Artikelidentifikation

| | |
|-------------------|---|
| <p>diagram</p> | |
| <p>namespace</p> | <p>http://xml.ir-d.de/emg</p> |
| <p>type</p> | <p>extension of ArtikelidentifikationBasis</p> |
| <p>properties</p> | <p>base ArtikelidentifikationBasis</p> |
| <p>children</p> | <p>ARI LaufendeNummer ARI IrdNummer ARI Artikelkennzeichen ARI ArtikelkennzeichenUnbekannt ARI KennzeichenTypSchluessel ARI SonderstatusJNSchluessel ARI ArtikelArtSchluessel ARI ArtikelArtFunktionSchluessel ARI GefundenJNSchluessel artikelbeschreibung</p> |
| <p>used by</p> | <p>element Operation/artikelidentifikation</p> |
| <p>source</p> | <pre><complexType name="Artikelidentifikation"> <complexContent> <extension base="ArtikelidentifikationBasis"> <sequence> <element name="artikelbeschreibung" type="Artikelbeschreibung"/> </sequence> </extension> </complexContent> </complexType></pre> |

element **Artikelidentifikation/artikelbeschreibung**

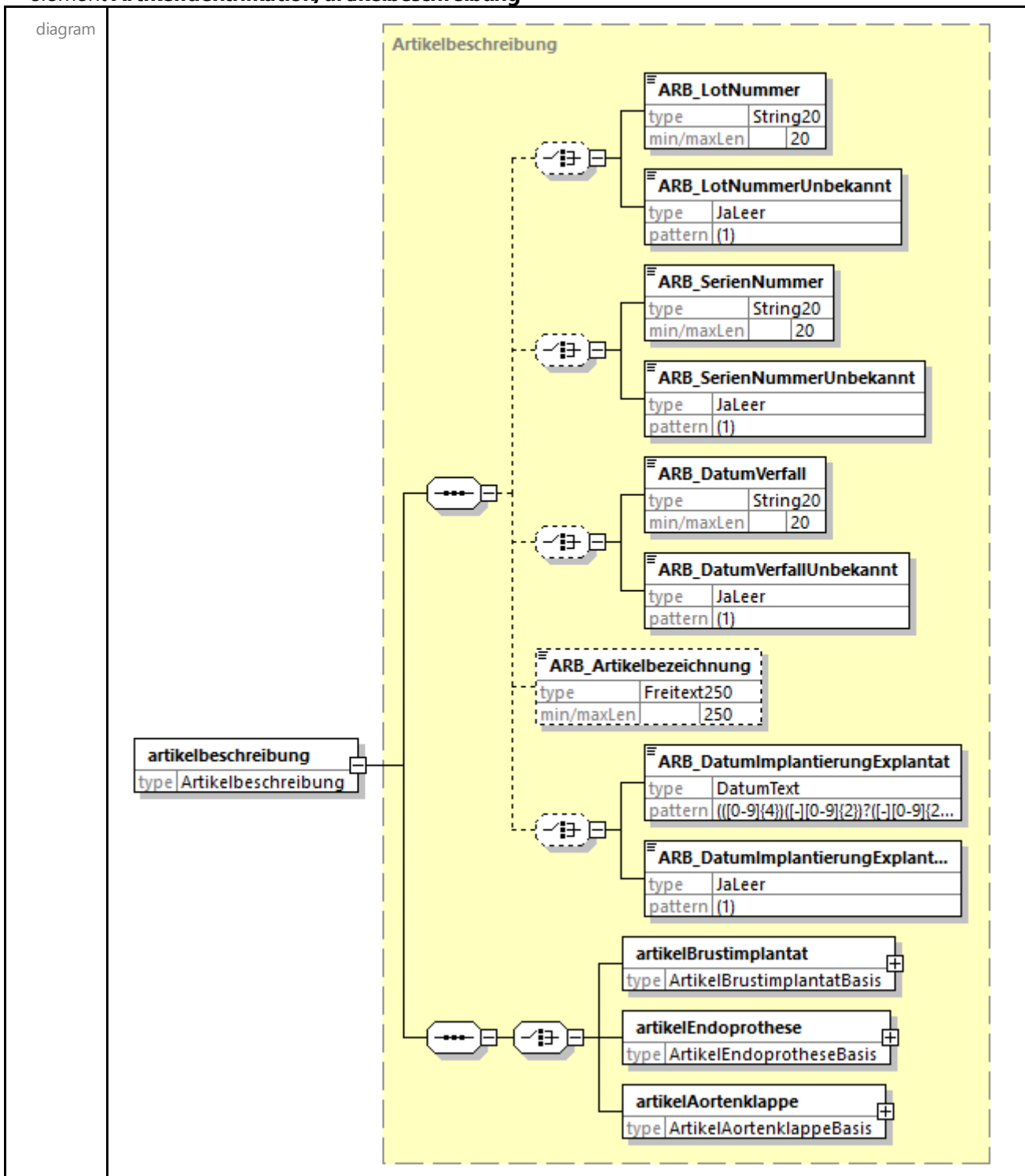

| | |
|------------|--|
| type | Artikelbeschreibung |
| properties | content complex |
| children | ARB LotNumber ARB LotNumberUnbekannt ARB SerienNumber ARB SerienNumberUnbekannt ARB DatumVerfall ARB DatumVerfallUnbekannt ARB Artikelbezeichnung ARB DatumImplantierungExplantat ARB DatumImplantierungExplantatUnbekannt artikelBrustimplantat artikelEndoprothese artikelAortenklappe |
| source | <code><element name="artikelbeschreibung" type="Artikelbeschreibung"/></code> |

complexType **Zubehoer**

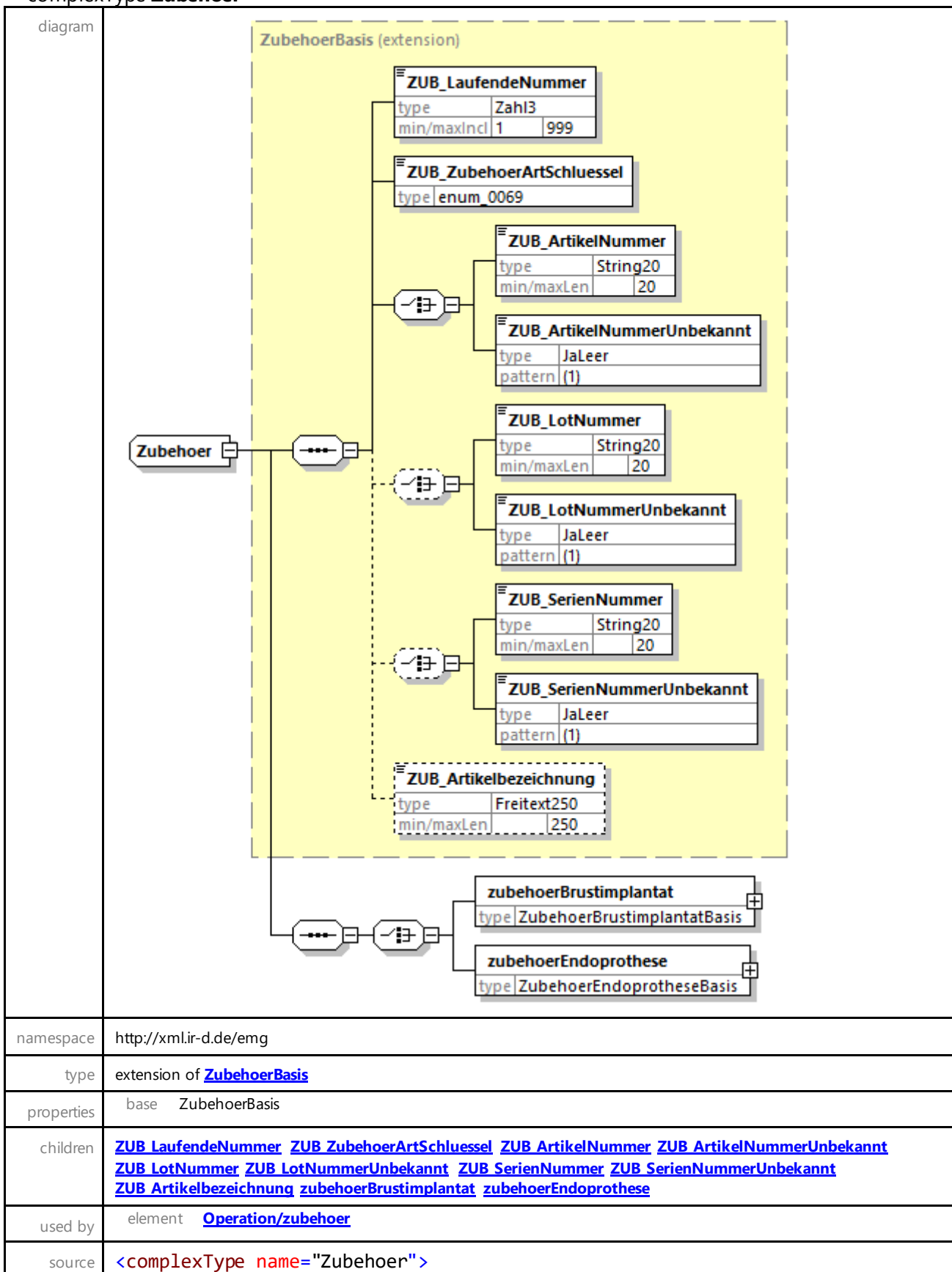

```

<complexContent>
  <extension base="ZubehoerBasis">
    <sequence>
      <choice>
        <element name="zubehoerBrustimplantat"
type="ZubehoerBrustimplantatBasis"/>
        <element name="zubehoerEndoprothese"
type="ZubehoerEndoprotheseBasis"/>
      </choice>
    </sequence>
  </extension>
</complexContent>
</complexType>

```

element **Zubehoer/zubehoerBrustimplantat**

| | |
|------------|--|
| diagram | |
| type | ZubehoerBrustimplantatBasis |
| properties | content complex |
| children | ZBI_HerstellerSchluessel ZBI_HerstellerUnbekannt ZBI_HerstellerSonstiger ZBI_ZubehoerTypSchluessel |
| source | <code><element name="zubehoerBrustimplantat" type="ZubehoerBrustimplantatBasis"/></code> |

element **Zubehoer/zubehoerEndoprothese**

| | |
|------------|---|
| diagram | |
| type | ZubehoerEndoprotheseBasis |
| properties | content complex |
| children | ZEP HerstellerSchluessel ZEP HerstellerUnbekannt ZEP HerstellerSonstiger ZEP ZubehoerTypSchluessel ZEP Menge ZEP EinheitSchluessel |
| source | <code><element name="zubehoerEndoprothese" type="ZubehoerEndoprotheseBasis"/></code> |

complexType **EntlassungBasis**

| | |
|-----------|---|
| diagram | |
| namespace | http://xml.ir-d.de/emg |
| children | ENT Datum ENT GrundSchluessel |
| used by | complexType Entlassung |
| source | <pre> <complexType name="EntlassungBasis"> <sequence> <element name="ENT_Datum" type="xs:date"/> <element name="ENT_GrundSchluessel" type="String2" minOccurs="0"/> </sequence> </complexType> </pre> |

element **EntlassungBasis/ENT_Datum**

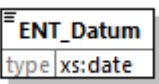
| | |
|------------|---|
| diagram |  |
| type | date |
| properties | content simple |
| source | <code><element name="ENT_Datum" type="xs:date"/></code> |

element **EntlassungBasis/ENT_GrundSchluessel**

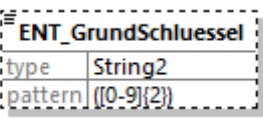
| | |
|------------|---|
| diagram |  |
| type | String2 |
| properties | minOcc 0 maxOcc 1 content simple |
| facets | Kind Value Annotation pattern ([0-9]{2}) |
| source | <code><element name="ENT_GrundSchluessel" type="String2" minOccurs="0"/></code> |

complexType **DiagnoseBrustimplantatBasis**

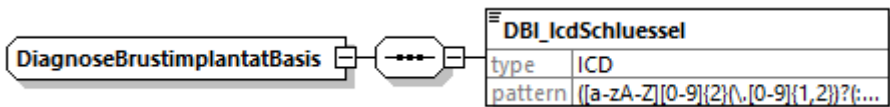
| | |
|-----------|--|
| diagram |  |
| namespace | http://xml.ir-d.de/emg |
| children | DBI_IcdSchluessel |
| used by | element Entlassung/diagnoseBrustimplantat |
| source | <pre><complexType name="DiagnoseBrustimplantatBasis"> <sequence> <element name="DBI_IcdSchluessel" type="ICD"/> </sequence> </complexType></pre> |

element **DiagnoseBrustimplantatBasis/DBI_IcdSchluessel**

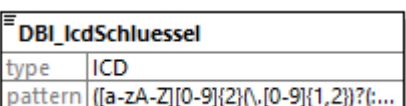
| | |
|------------|---|
| diagram |  |
| type | ICD |
| properties | content simple |
| facets | Kind Value Annotation pattern ([a-zA-Z][0-9]{2}(\.[0-9]{1,2})?;:[RLB])?) |

| | |
|--------|---|
| source | <code><element name="DBI_IcdSchluessel" type="ICD"/></code> |
|--------|---|

complexType DiagnoseEndoprotheseBasis

| | |
|-----------|--|
| diagram | |
| namespace | http://xml.ir-d.de/emg |
| children | DEP IcdSchluessel |
| used by | element Entlassung/diagnoseEndoprothese |
| source | <pre> <complexType name="DiagnoseEndoprotheseBasis"> <sequence> <element name="DEP_IcdSchluessel" type="ICD"/> </sequence> </complexType> </pre> |

element DiagnoseEndoprotheseBasis/DEP_IcdSchluessel

| diagram | | | | | | | |
|------------|--|------------|-------|------------|---------|---|--|
| type | ICD | | | | | | |
| properties | content simple | | | | | | |
| facets | <table border="1"> <thead> <tr> <th>Kind</th> <th>Value</th> <th>Annotation</th> </tr> </thead> <tbody> <tr> <td>pattern</td> <td>([a-zA-Z][0-9]{2}(\.[0-9]{1,2})?;(:RLB))?</td> <td></td> </tr> </tbody> </table> | Kind | Value | Annotation | pattern | ([a-zA-Z][0-9]{2}(\.[0-9]{1,2})?;(:RLB))? | |
| Kind | Value | Annotation | | | | | |
| pattern | ([a-zA-Z][0-9]{2}(\.[0-9]{1,2})?;(:RLB))? | | | | | | |
| source | <code><element name="DEP_IcdSchluessel" type="ICD"/></code> | | | | | | |

complexType DiagnoseAortenklappeBasis

| | |
|-----------|--|
| diagram | |
| namespace | http://xml.ir-d.de/emg |
| children | DAK IcdSchluessel |
| used by | element Entlassung/diagnoseAortenklappe |
| source | <pre> <complexType name="DiagnoseAortenklappeBasis"> <sequence> <element name="DAK_IcdSchluessel" type="ICD"/> </sequence> </complexType> </pre> |

element **DiagnoseAortenklappeBasis/DAK_IcdSchluessel**

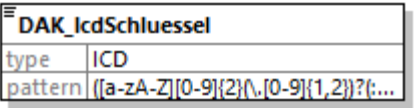
| diagram |  <pre> DAK_IcdSchluessel type ICD pattern ([a-zA-Z][0-9]{2}(\.[0-9]{1,2})?:(... </pre> | | | | | | |
|------------|---|------------|-------|------------|---------|--|--|
| type | ICD | | | | | | |
| properties | content simple | | | | | | |
| facets | <table border="1"> <thead> <tr> <th>Kind</th> <th>Value</th> <th>Annotation</th> </tr> </thead> <tbody> <tr> <td>pattern</td> <td>([a-zA-Z][0-9]{2}(\.[0-9]{1,2})?:(RLB))?</td> <td></td> </tr> </tbody> </table> | Kind | Value | Annotation | pattern | ([a-zA-Z][0-9]{2}(\.[0-9]{1,2})?:(RLB))? | |
| Kind | Value | Annotation | | | | | |
| pattern | ([a-zA-Z][0-9]{2}(\.[0-9]{1,2})?:(RLB))? | | | | | | |
| source | <code><element name="DAK_IcdSchluessel" type="ICD"/></code> | | | | | | |

complexType PostoperationAortenklappeBasis

diagram

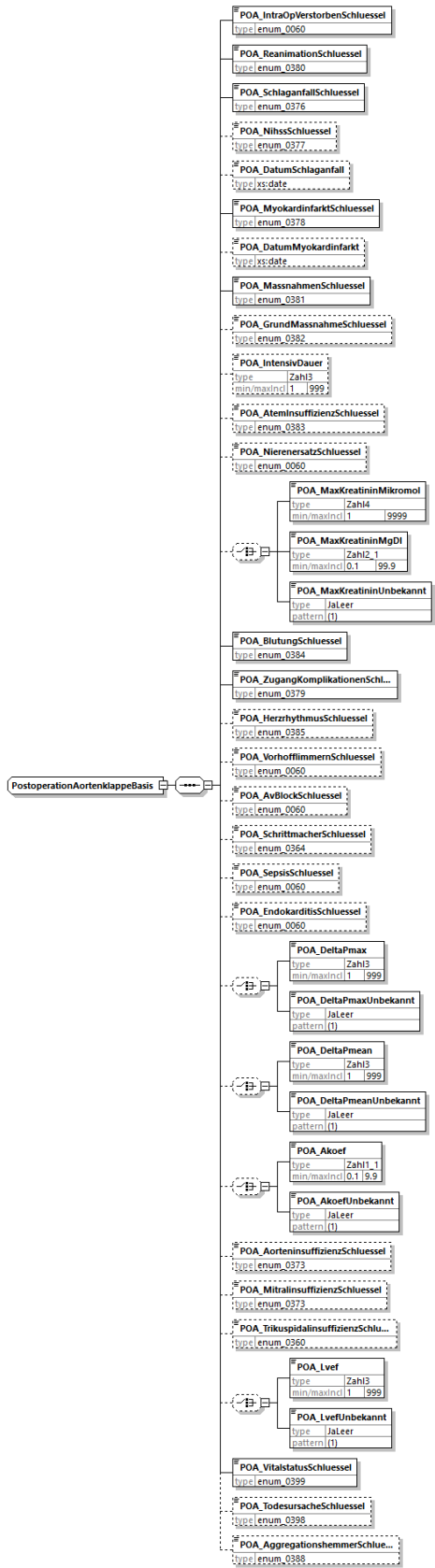

namespace <http://xml.ir-d.de/emg>

children [POA_IntraOpVerstorbenSchlüssel](#) [POA_ReanimationSchlüssel](#) [POA_SchlaganfallSchlüssel](#) [POA_NihssSchlüssel](#) [POA_DatumSchlaganfall](#) [POA_MyokardinfarktSchlüssel](#) [POA_DatumMyokardinfarkt](#)

| | |
|---------|---|
| | POA MassnahmenSchluessel POA GrundMassnahmeSchluessel POA IntensivDauer POA AtemInsuffizienzSchluessel POA NierenersatzSchluessel POA MaxKreatininMikromol POA MaxKreatininMgDI POA MaxKreatininUnbekannt POA BlutungSchluessel POA ZugangKomplikationenSchluessel POA HerzrhythmusSchluessel POA VorhofflimmernSchluessel POA AvBlockSchluessel POA SchrittmacherSchluessel POA SepsisSchluessel POA EndokarditisSchluessel POA DeltaPmax POA DeltaPmaxUnbekannt POA DeltaPmean POA DeltaPmeanUnbekannt POA Akoef POA AkoefUnbekannt POA AorteninsuffizienzSchluessel POA MitralinsuffizienzSchluessel POA TrikuspidalinsuffizienzSchluessel POA Lvef POA LvefUnbekannt POA VitalstatusSchluessel POA TodesursacheSchluessel POA AggregationshemmerSchluessel |
| used by | complexType PostoperationAortenklappe |
| source | <pre> <complexType name="PostoperationAortenklappeBasis"> <sequence> <element name="POA_IntraOpVerstorbenSchluessel" type="enum_0060"/> <element name="POA_ReanimationSchluessel" type="enum_0380"/> <element name="POA_SchlaganfallSchluessel" type="enum_0376"/> <element name="POA_NihssSchluessel" type="enum_0377" minOccurs="0"/> <element name="POA_DatumSchlaganfall" type="xs:date" minOccurs="0"/> <element name="POA_MyokardinfarktSchluessel" type="enum_0378"/> <element name="POA_DatumMyokardinfarkt" type="xs:date" minOccurs="0"/> <element name="POA_MassnahmenSchluessel" type="enum_0381"/> <element name="POA_GrundMassnahmeSchluessel" type="enum_0382" minOccurs="0"/> <element name="POA_IntensivDauer" type="Zahl3" minOccurs="0"/> <element name="POA_AtemInsuffizienzSchluessel" type="enum_0383" minOccurs="0"/> <element name="POA_NierenersatzSchluessel" type="enum_0060" minOccurs="0"/> <choice minOccurs="0"> <element name="POA_MaxKreatininMikromol" type="Zahl4"/> <element name="POA_MaxKreatininMgDI" type="Zahl2_1"/> <element name="POA_MaxKreatininUnbekannt" type="JaLeer"/> </choice> <element name="POA_BlutungSchluessel" type="enum_0384"/> <element name="POA_ZugangKomplikationenSchluessel" type="enum_0379"/> <element name="POA_HerzrhythmusSchluessel" type="enum_0385" minOccurs="0"/> <element name="POA_VorhofflimmernSchluessel" type="enum_0060" minOccurs="0"/> <element name="POA_AvBlockSchluessel" type="enum_0060" minOccurs="0"/> <element name="POA_SchrittmacherSchluessel" type="enum_0364" minOccurs="0"/> <element name="POA_SepsisSchluessel" type="enum_0060" minOccurs="0"/> <element name="POA_EndokarditisSchluessel" type="enum_0060" minOccurs="0"/> <choice minOccurs="0"> <element name="POA_DeltaPmax" type="Zahl3"/> <element name="POA_DeltaPmaxUnbekannt" type="JaLeer"/> </choice> <choice minOccurs="0"> <element name="POA_DeltaPmean" type="Zahl3"/> <element name="POA_DeltaPmeanUnbekannt" type="JaLeer"/> </choice> <choice minOccurs="0"> <element name="POA_Akoef" type="Zahl1_1"/> <element name="POA_AkoefUnbekannt" type="JaLeer"/> </choice> <element name="POA_AorteninsuffizienzSchluessel" type="enum_0373" minOccurs="0"/> <element name="POA_MitralinsuffizienzSchluessel" type="enum_0373" </pre> |

```

minOccurs="0"/>
  <element name="POA_TrikuspidalinsuffizienzSchluessel" type="enum_0360"
minOccurs="0"/>
  <choice minOccurs="0">
    <element name="POA_Lvef" type="Zahl3"/>
    <element name="POA_LvefUnbekannt" type="JaLeer"/>
  </choice>
  <element name="POA_VitalstatusSchluessel" type="enum_0399"/>
  <element name="POA_TodesursacheSchluessel" type="enum_0398"
minOccurs="0"/>
  <element name="POA_AggregationshemmerSchluessel" type="enum_0388"
minOccurs="0"/>
  </sequence>
</complexType>

```

element **PostoperationAortenklappeBasis/POA_IntraOpVerstorbenSchluessel**

| diagram |  | | | | | | | | | |
|-------------|---|-----------------------|-------|------------|-------------|---------|---------------------|-------------|---------|-----------------------|
| type | enum_0060 | | | | | | | | | |
| properties | content simple | | | | | | | | | |
| facets | <table border="1"> <thead> <tr> <th>Kind</th> <th>Value</th> <th>Annotation</th> </tr> </thead> <tbody> <tr> <td>enumeration</td> <td>0060001</td> <td>documentation ja</td> </tr> <tr> <td>enumeration</td> <td>0060002</td> <td>documentation nein</td> </tr> </tbody> </table> | Kind | Value | Annotation | enumeration | 0060001 | documentation ja | enumeration | 0060002 | documentation nein |
| Kind | Value | Annotation | | | | | | | | |
| enumeration | 0060001 | documentation ja | | | | | | | | |
| enumeration | 0060002 | documentation nein | | | | | | | | |
| source | <code><element name="POA_IntraOpVerstorbenSchluessel" type="enum_0060"/></code> | | | | | | | | | |

element **PostoperationAortenklappeBasis/POA_ReanimationSchluessel**

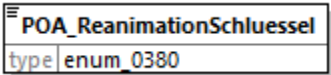
| diagram |  | | | | | | | | | | | | | | | |
|-------------|---|--|-------|------------|-------------|---------|-----------------------|-------------|---------|--------------------------------------|-------------|---------|-------------------------------------|-------------|---------|--|
| type | enum_0380 | | | | | | | | | | | | | | | |
| properties | content simple | | | | | | | | | | | | | | | |
| facets | <table border="1"> <thead> <tr> <th>Kind</th> <th>Value</th> <th>Annotation</th> </tr> </thead> <tbody> <tr> <td>enumeration</td> <td>0380001</td> <td>documentation nein</td> </tr> <tr> <td>enumeration</td> <td>0380002</td> <td>documentation ja, intraprozedural</td> </tr> <tr> <td>enumeration</td> <td>0380003</td> <td>documentation ja, postprozedural</td> </tr> <tr> <td>enumeration</td> <td>0380004</td> <td>documentation ja, Zeitpunkt nicht bekannt</td> </tr> </tbody> </table> | Kind | Value | Annotation | enumeration | 0380001 | documentation nein | enumeration | 0380002 | documentation ja, intraprozedural | enumeration | 0380003 | documentation ja, postprozedural | enumeration | 0380004 | documentation ja, Zeitpunkt nicht bekannt |
| Kind | Value | Annotation | | | | | | | | | | | | | | |
| enumeration | 0380001 | documentation nein | | | | | | | | | | | | | | |
| enumeration | 0380002 | documentation ja, intraprozedural | | | | | | | | | | | | | | |
| enumeration | 0380003 | documentation ja, postprozedural | | | | | | | | | | | | | | |
| enumeration | 0380004 | documentation ja, Zeitpunkt nicht bekannt | | | | | | | | | | | | | | |
| source | <code><element name="POA_ReanimationSchluessel" type="enum_0380"/></code> | | | | | | | | | | | | | | | |

element **PostoperationAortenklappeBasis/POA_SchlaganfallSchluessel**

| | |
|---------|---|
| diagram |  |
|---------|---|

| type | enum_0376 | | | | | | | | | | | | | | | |
|-------------|---|---|-------|------------|-------------|---------|-----------------------|-------------|---------|--|-------------|---------|---|-------------|---------|----------------------------------|
| properties | content simple | | | | | | | | | | | | | | | |
| facets | <table border="1"> <thead> <tr> <th>Kind</th> <th>Value</th> <th>Annotation</th> </tr> </thead> <tbody> <tr> <td>enumeration</td> <td>0376001</td> <td>documentation nein</td> </tr> <tr> <td>enumeration</td> <td>0376002</td> <td>documentation ja, ZNS, zerebrovaskuläre Blutung</td> </tr> <tr> <td>enumeration</td> <td>0376003</td> <td>documentation ja, ZNS, zerebrovaskuläre Ischämie</td> </tr> <tr> <td>enumeration</td> <td>0376042</td> <td>documentation ja, ZNS, andere</td> </tr> </tbody> </table> | Kind | Value | Annotation | enumeration | 0376001 | documentation nein | enumeration | 0376002 | documentation ja, ZNS, zerebrovaskuläre Blutung | enumeration | 0376003 | documentation ja, ZNS, zerebrovaskuläre Ischämie | enumeration | 0376042 | documentation ja, ZNS, andere |
| Kind | Value | Annotation | | | | | | | | | | | | | | |
| enumeration | 0376001 | documentation nein | | | | | | | | | | | | | | |
| enumeration | 0376002 | documentation ja, ZNS, zerebrovaskuläre Blutung | | | | | | | | | | | | | | |
| enumeration | 0376003 | documentation ja, ZNS, zerebrovaskuläre Ischämie | | | | | | | | | | | | | | |
| enumeration | 0376042 | documentation ja, ZNS, andere | | | | | | | | | | | | | | |
| source | <code><element name="POA_SchlaganfallSchluessel" type="enum_0376"/></code> | | | | | | | | | | | | | | | |

element **PostoperationAortenklappeBasis/POA_NihssSchluessel**

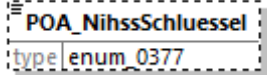
| diagram |  | | | | | | | | | | | | |
|-------------|---|---|-------|------------|-------------|---------|---|-------------|---------|--|-------------|---------|---|
| type | enum_0377 | | | | | | | | | | | | |
| properties | minOcc 0 maxOcc 1 content simple | | | | | | | | | | | | |
| facets | <table border="1"> <thead> <tr> <th>Kind</th> <th>Value</th> <th>Annotation</th> </tr> </thead> <tbody> <tr> <td>enumeration</td> <td>0377001</td> <td>documentation ja, mild neurological dysfunction: NIHSS 0-5</td> </tr> <tr> <td>enumeration</td> <td>0377002</td> <td>documentation ja, moderate neurological dysfunction: NIHSS 6-14</td> </tr> <tr> <td>enumeration</td> <td>0377003</td> <td>documentation ja, severe neurological dysfunction: NIHSS &gt;=15</td> </tr> </tbody> </table> | Kind | Value | Annotation | enumeration | 0377001 | documentation ja, mild neurological dysfunction: NIHSS 0-5 | enumeration | 0377002 | documentation ja, moderate neurological dysfunction: NIHSS 6-14 | enumeration | 0377003 | documentation ja, severe neurological dysfunction: NIHSS >=15 |
| Kind | Value | Annotation | | | | | | | | | | | |
| enumeration | 0377001 | documentation ja, mild neurological dysfunction: NIHSS 0-5 | | | | | | | | | | | |
| enumeration | 0377002 | documentation ja, moderate neurological dysfunction: NIHSS 6-14 | | | | | | | | | | | |
| enumeration | 0377003 | documentation ja, severe neurological dysfunction: NIHSS >=15 | | | | | | | | | | | |
| source | <code><element name="POA_NihssSchluessel" type="enum_0377" minOccurs="0"/></code> | | | | | | | | | | | | |

element **PostoperationAortenklappeBasis/POA_DatumSchlaganfall**

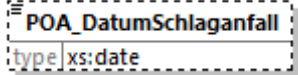
| | |
|------------|---|
| diagram |  |
| type | date |
| properties | minOcc 0 maxOcc 1 content simple |
| source | <code><element name="POA_DatumSchlaganfall" type="xs:date" minOccurs="0"/></code> |

element **PostoperationAortenklappeBasis/POA_MyokardinfarktSchluessel**

| diagram |  | | | | | | |
|-------------|---|---------------|-------|------------|-------------|---------|---------------|
| type | enum_0378 | | | | | | |
| properties | content simple | | | | | | |
| facets | <table border="1"> <thead> <tr> <th>Kind</th> <th>Value</th> <th>Annotation</th> </tr> </thead> <tbody> <tr> <td>enumeration</td> <td>0378001</td> <td>documentation</td> </tr> </tbody> </table> | Kind | Value | Annotation | enumeration | 0378001 | documentation |
| Kind | Value | Annotation | | | | | |
| enumeration | 0378001 | documentation | | | | | |

| | | | |
|--------|--|---------|--|
| | enumeration | 0378002 | nein documentation ja, < 48h gemäss VARC-3-Definition |
| | enumeration | 0378003 | documentation ja, >= 48h - <= 72h gemäß VARC-3-Definition |
| | enumeration | 0378004 | documentation ja, > 72 h gemäß VARC-3 Definition |
| source | <code><element name="POA_MyokardinfarktSchluessel" type="enum_0378"/></code> | | |

element **PostoperationAortenklappeBasis/POA_DatumMyokardinfarkt**

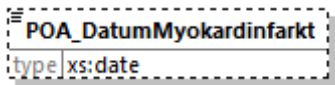
| | | | |
|------------|---|--------|--|
| diagram |  | | |
| type | date | | |
| properties | minOcc | 0 | |
| | maxOcc | 1 | |
| | content | simple | |
| source | <code><element name="POA_DatumMyokardinfarkt" type="xs:date" minOccurs="0"/></code> | | |

element **PostoperationAortenklappeBasis/POA_MassnahmenSchluessel**

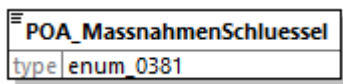
| | | | |
|------------|--|---------|---|
| diagram |  | | |
| type | enum 0381 | | |
| properties | content | simple | |
| facets | Kind | Value | Annotation |
| | enumeration | 0381001 | documentation nein |
| | enumeration | 0381002 | documentation Thorakotomie/Rethorakotomie |
| | enumeration | 0381003 | documentation kathetergestützte Reintervention |
| | enumeration | 0381004 | documentation lokale Reinterventionen |
| | enumeration | 0381005 | documentation andere Reintervention |
| source | <code><element name="POA_MassnahmenSchluessel" type="enum_0381"/></code> | | |

element **PostoperationAortenklappeBasis/POA_GrundMassnahmeSchluessel**

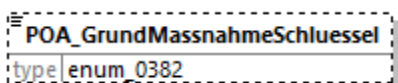
| | | | |
|------------|---|---------|---|
| diagram |  | | |
| type | enum 0382 | | |
| properties | minOcc | 0 | |
| | maxOcc | 1 | |
| | content | simple | |
| facets | Kind | Value | Annotation |
| | enumeration | 0382001 | documentation keine Rethorakotomie / kein weiterer Grund |
| | enumeration | 0382002 | documentation |

| | | | |
|--------|--|---------|--|
| | enumeration | 0382003 | Blutung/Hämatom documentation |
| | enumeration | 0382004 | Low Cardiac Output documentation |
| | enumeration | 0382005 | Tamponade documentation |
| | enumeration | 0382006 | Graftprobleme, Ischämie documentation |
| | enumeration | 0382007 | Wundinfektion, Mediastinitis documentation |
| | enumeration | 0382008 | Dissektion documentation |
| | enumeration | 0382009 | Prothesendysfunktion documentation |
| | enumeration | 0382010 | instabiles Sternum documentation |
| | enumeration | 0382011 | Chylothorax documentation |
| | enumeration | 0382042 | lokale Revision im Bereich des Zugangsweges documentation |
| | | | anderer Grund |
| source | <code><element name="POA_GrundMassnahmeSchluessel" type="enum_0382" minOccurs="0"/></code> | | |

element **PostoperationAortenklappeBasis/POA_IntensivDauer**

| | | | |
|------------|---|--------|------------|
| diagram | | | |
| type | Zahl3 | | |
| properties | minOcc | 0 | |
| | maxOcc | 1 | |
| | content | simple | |
| facets | Kind | Value | Annotation |
| | minInclusive | 1 | |
| | maxInclusive | 999 | |
| source | <code><element name="POA_IntensivDauer" type="Zahl3" minOccurs="0"/></code> | | |

element **PostoperationAortenklappeBasis/POA_AtemInsuffizienzSchluessel**

| | | | |
|------------|---------------------------|---------|--|
| diagram | | | |
| type | enum 0383 | | |
| properties | minOcc | 0 | |
| | maxOcc | 1 | |
| | content | simple | |
| facets | Kind | Value | Annotation |
| | enumeration | 0383001 | documentation nein |
| | enumeration | 0383002 | documentation ja, mit forcierter Atemtherapie |
| | enumeration | 0383003 | documentation ja, Reintubation oder längerfristige Beatmung |
| | enumeration | 0383004 | documentation ja, Tracheotomie |

| | |
|--------|--|
| source | <code><element name="POA_AtemInsuffizienzSchluessel" type="enum_0383" minOccurs="0"/></code> |
|--------|--|

element **PostoperationAortenklappeBasis/POA_NierenersatzSchluessel**

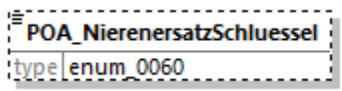
| diagram |  | | | | | | | | | |
|-------------|---|-----------------------|-------|------------|-------------|---------|---------------------|-------------|---------|-----------------------|
| type | enum 0060 | | | | | | | | | |
| properties | minOcc 0 maxOcc 1 content simple | | | | | | | | | |
| facets | <table border="1"> <thead> <tr> <th>Kind</th> <th>Value</th> <th>Annotation</th> </tr> </thead> <tbody> <tr> <td>enumeration</td> <td>0060001</td> <td>documentation ja</td> </tr> <tr> <td>enumeration</td> <td>0060002</td> <td>documentation nein</td> </tr> </tbody> </table> | Kind | Value | Annotation | enumeration | 0060001 | documentation ja | enumeration | 0060002 | documentation nein |
| Kind | Value | Annotation | | | | | | | | |
| enumeration | 0060001 | documentation ja | | | | | | | | |
| enumeration | 0060002 | documentation nein | | | | | | | | |
| source | <code><element name="POA_NierenersatzSchluessel" type="enum_0060" minOccurs="0"/></code> | | | | | | | | | |

element **PostoperationAortenklappeBasis/POA_MaxKreatininMikromol**

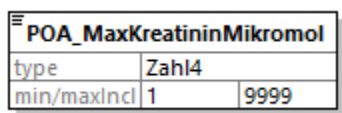
| diagram |  | | | | | | | | | |
|--------------|--|------------|-------|------------|--------------|---|--|--------------|------|--|
| type | Zahl4 | | | | | | | | | |
| properties | content simple | | | | | | | | | |
| facets | <table border="1"> <thead> <tr> <th>Kind</th> <th>Value</th> <th>Annotation</th> </tr> </thead> <tbody> <tr> <td>minInclusive</td> <td>1</td> <td></td> </tr> <tr> <td>maxInclusive</td> <td>9999</td> <td></td> </tr> </tbody> </table> | Kind | Value | Annotation | minInclusive | 1 | | maxInclusive | 9999 | |
| Kind | Value | Annotation | | | | | | | | |
| minInclusive | 1 | | | | | | | | | |
| maxInclusive | 9999 | | | | | | | | | |
| source | <code><element name="POA_MaxKreatininMikromol" type="Zahl4"/></code> | | | | | | | | | |

element **PostoperationAortenklappeBasis/POA_MaxKreatininMgDI**

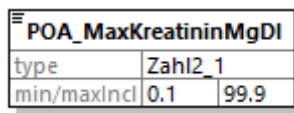
| diagram |  | | | | | | | | | | | | | | | |
|----------------|---|------------|-------|------------|--------------|-----|--|--------------|------|--|-------------|---|--|----------------|---|--|
| type | Zahl2_1 | | | | | | | | | | | | | | | |
| properties | content simple | | | | | | | | | | | | | | | |
| facets | <table border="1"> <thead> <tr> <th>Kind</th> <th>Value</th> <th>Annotation</th> </tr> </thead> <tbody> <tr> <td>minInclusive</td> <td>0.1</td> <td></td> </tr> <tr> <td>maxInclusive</td> <td>99.9</td> <td></td> </tr> <tr> <td>totalDigits</td> <td>3</td> <td></td> </tr> <tr> <td>fractionDigits</td> <td>1</td> <td></td> </tr> </tbody> </table> | Kind | Value | Annotation | minInclusive | 0.1 | | maxInclusive | 99.9 | | totalDigits | 3 | | fractionDigits | 1 | |
| Kind | Value | Annotation | | | | | | | | | | | | | | |
| minInclusive | 0.1 | | | | | | | | | | | | | | | |
| maxInclusive | 99.9 | | | | | | | | | | | | | | | |
| totalDigits | 3 | | | | | | | | | | | | | | | |
| fractionDigits | 1 | | | | | | | | | | | | | | | |
| source | <code><element name="POA_MaxKreatininMgDI" type="Zahl2_1"/></code> | | | | | | | | | | | | | | | |

element **PostoperationAortenklappeBasis/POA_MaxKreatininUnbekannt**

| diagram | | | | | | | |
|------------|--|------------|-------|------------|---------|-----|--|
| type | JaLeer | | | | | | |
| properties | content simple | | | | | | |
| facets | <table border="1"> <thead> <tr> <th>Kind</th> <th>Value</th> <th>Annotation</th> </tr> </thead> <tbody> <tr> <td>pattern</td> <td>(1)</td> <td></td> </tr> </tbody> </table> | Kind | Value | Annotation | pattern | (1) | |
| Kind | Value | Annotation | | | | | |
| pattern | (1) | | | | | | |
| source | <code><element name="POA_MaxKreatininUnbekannt" type="JaLeer"/></code> | | | | | | |

element **PostoperationAortenklappeBasis/POA_BlutungSchluessel**

| diagram | | | | | | | | | | | | | | | | |
|-------------|---|--|-------|------------|-------------|---------|---|-------------|---------|--|-------------|---------|---|-------------|---------|--|
| type | enum_0384 | | | | | | | | | | | | | | | |
| properties | content simple | | | | | | | | | | | | | | | |
| facets | <table border="1"> <thead> <tr> <th>Kind</th> <th>Value</th> <th>Annotation</th> </tr> </thead> <tbody> <tr> <td>enumeration</td> <td>0384001</td> <td>documentation keine Blutungskomplikationen</td> </tr> <tr> <td>enumeration</td> <td>0384002</td> <td>documentation Geringfügige Blutung (Minor Bleeding - BARC type 2 or 3a)</td> </tr> <tr> <td>enumeration</td> <td>0384003</td> <td>documentation Starke Blutung (Major Bleeding - BARC type 3a)</td> </tr> <tr> <td>enumeration</td> <td>0384004</td> <td>documentation Lebensbedrohliche Blutung (Life-threatening or disabling bleeding - BARC type 3b or 3c or type 5)</td> </tr> </tbody> </table> | Kind | Value | Annotation | enumeration | 0384001 | documentation keine Blutungskomplikationen | enumeration | 0384002 | documentation Geringfügige Blutung (Minor Bleeding - BARC type 2 or 3a) | enumeration | 0384003 | documentation Starke Blutung (Major Bleeding - BARC type 3a) | enumeration | 0384004 | documentation Lebensbedrohliche Blutung (Life-threatening or disabling bleeding - BARC type 3b or 3c or type 5) |
| Kind | Value | Annotation | | | | | | | | | | | | | | |
| enumeration | 0384001 | documentation keine Blutungskomplikationen | | | | | | | | | | | | | | |
| enumeration | 0384002 | documentation Geringfügige Blutung (Minor Bleeding - BARC type 2 or 3a) | | | | | | | | | | | | | | |
| enumeration | 0384003 | documentation Starke Blutung (Major Bleeding - BARC type 3a) | | | | | | | | | | | | | | |
| enumeration | 0384004 | documentation Lebensbedrohliche Blutung (Life-threatening or disabling bleeding - BARC type 3b or 3c or type 5) | | | | | | | | | | | | | | |
| source | <code><element name="POA_BlutungSchluessel" type="enum_0384"/></code> | | | | | | | | | | | | | | | |

element **PostoperationAortenklappeBasis/POA_ZugangKomplikationenSchluessel**

| diagram | | | | | | | | | | | | | | | | |
|-------------|--|---|-------|------------|-------------|---------|---|-------------|---------|--|-------------|---------|---|-------------|---------|---|
| type | enum_0379 | | | | | | | | | | | | | | | |
| properties | content simple | | | | | | | | | | | | | | | |
| facets | <table border="1"> <thead> <tr> <th>Kind</th> <th>Value</th> <th>Annotation</th> </tr> </thead> <tbody> <tr> <td>enumeration</td> <td>0379001</td> <td>documentation Keine gefäss- oder zugangsassoziierte Komplikationen</td> </tr> <tr> <td>enumeration</td> <td>0379002</td> <td>documentation Versagen des perkutanen Verschlusssystems</td> </tr> <tr> <td>enumeration</td> <td>0379003</td> <td>documentation Geringfügige Gefäßkomplikationen</td> </tr> <tr> <td>enumeration</td> <td>0379004</td> <td>documentation Erhebliche Gefäßkomplikationen</td> </tr> </tbody> </table> | Kind | Value | Annotation | enumeration | 0379001 | documentation Keine gefäss- oder zugangsassoziierte Komplikationen | enumeration | 0379002 | documentation Versagen des perkutanen Verschlusssystems | enumeration | 0379003 | documentation Geringfügige Gefäßkomplikationen | enumeration | 0379004 | documentation Erhebliche Gefäßkomplikationen |
| Kind | Value | Annotation | | | | | | | | | | | | | | |
| enumeration | 0379001 | documentation Keine gefäss- oder zugangsassoziierte Komplikationen | | | | | | | | | | | | | | |
| enumeration | 0379002 | documentation Versagen des perkutanen Verschlusssystems | | | | | | | | | | | | | | |
| enumeration | 0379003 | documentation Geringfügige Gefäßkomplikationen | | | | | | | | | | | | | | |
| enumeration | 0379004 | documentation Erhebliche Gefäßkomplikationen | | | | | | | | | | | | | | |
| source | <code><element name="POA_ZugangKomplikationenSchluessel" type="enum_0379"/></code> | | | | | | | | | | | | | | | |

element **PostoperationAortenklappeBasis/POA_HerzrhythmusSchluessel**

| diagram | | | | | | | | | | | | | | | | |
|-------------|--|---|-------|------------|-------------|---------|--------------------------------|-------------|---------|---------------------------------|-------------|---------|---|-------------|---------|-----------------------------------|
| type | enum 0385 | | | | | | | | | | | | | | | |
| properties | minOcc 0 maxOcc 1 content simple | | | | | | | | | | | | | | | |
| facets | <table border="1"> <thead> <tr> <th>Kind</th> <th>Value</th> <th>Annotation</th> </tr> </thead> <tbody> <tr> <td>enumeration</td> <td>0385001</td> <td>documentation Sinusrhythmus</td> </tr> <tr> <td>enumeration</td> <td>0385002</td> <td>documentation Vorhofflimmern</td> </tr> <tr> <td>enumeration</td> <td>0385003</td> <td>documentation Patient verstorben (kein Herzrhythmus)</td> </tr> <tr> <td>enumeration</td> <td>0385042</td> <td>documentation anderer Rhythmus</td> </tr> </tbody> </table> | Kind | Value | Annotation | enumeration | 0385001 | documentation Sinusrhythmus | enumeration | 0385002 | documentation Vorhofflimmern | enumeration | 0385003 | documentation Patient verstorben (kein Herzrhythmus) | enumeration | 0385042 | documentation anderer Rhythmus |
| Kind | Value | Annotation | | | | | | | | | | | | | | |
| enumeration | 0385001 | documentation Sinusrhythmus | | | | | | | | | | | | | | |
| enumeration | 0385002 | documentation Vorhofflimmern | | | | | | | | | | | | | | |
| enumeration | 0385003 | documentation Patient verstorben (kein Herzrhythmus) | | | | | | | | | | | | | | |
| enumeration | 0385042 | documentation anderer Rhythmus | | | | | | | | | | | | | | |
| source | <code><element name="POA_HerzrhythmusSchluessel" type="enum_0385" minOccurs="0"/></code> | | | | | | | | | | | | | | | |

element **PostoperationAortenklappeBasis/POA_VorhofflimmernSchluessel**

| diagram | | | | | | | | | | |
|-------------|---|-----------------------|-------|------------|-------------|---------|---------------------|-------------|---------|-----------------------|
| type | enum 0060 | | | | | | | | | |
| properties | minOcc 0 maxOcc 1 content simple | | | | | | | | | |
| facets | <table border="1"> <thead> <tr> <th>Kind</th> <th>Value</th> <th>Annotation</th> </tr> </thead> <tbody> <tr> <td>enumeration</td> <td>0060001</td> <td>documentation ja</td> </tr> <tr> <td>enumeration</td> <td>0060002</td> <td>documentation nein</td> </tr> </tbody> </table> | Kind | Value | Annotation | enumeration | 0060001 | documentation ja | enumeration | 0060002 | documentation nein |
| Kind | Value | Annotation | | | | | | | | |
| enumeration | 0060001 | documentation ja | | | | | | | | |
| enumeration | 0060002 | documentation nein | | | | | | | | |
| source | <code><element name="POA_VorhofflimmernSchluessel" type="enum_0060" minOccurs="0"/></code> | | | | | | | | | |

element **PostoperationAortenklappeBasis/POA_AvBlockSchluessel**

| diagram | | | | | | | | | | |
|-------------|---|-----------------------|-------|------------|-------------|---------|---------------------|-------------|---------|-----------------------|
| type | enum 0060 | | | | | | | | | |
| properties | minOcc 0 maxOcc 1 content simple | | | | | | | | | |
| facets | <table border="1"> <thead> <tr> <th>Kind</th> <th>Value</th> <th>Annotation</th> </tr> </thead> <tbody> <tr> <td>enumeration</td> <td>0060001</td> <td>documentation ja</td> </tr> <tr> <td>enumeration</td> <td>0060002</td> <td>documentation nein</td> </tr> </tbody> </table> | Kind | Value | Annotation | enumeration | 0060001 | documentation ja | enumeration | 0060002 | documentation nein |
| Kind | Value | Annotation | | | | | | | | |
| enumeration | 0060001 | documentation ja | | | | | | | | |
| enumeration | 0060002 | documentation nein | | | | | | | | |
| source | <code><element name="POA_AvBlockSchluessel" type="enum_0060" minOccurs="0"/></code> | | | | | | | | | |

element **PostoperationAortenklappeBasis/POA_SchrittmacherSchluessel**

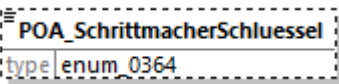
| diagram |  | | | | | | | | | | | | | | | | | | |
|-------------|--|--|-------|------------|-------------|---------|-----------------------|-------------|---------|--|-------------|---------|---|-------------|---------|--|-------------|---------|---|
| type | enum 0364 | | | | | | | | | | | | | | | | | | |
| properties | minOcc 0 maxOcc 1 content simple | | | | | | | | | | | | | | | | | | |
| facets | <table border="1"> <thead> <tr> <th>Kind</th> <th>Value</th> <th>Annotation</th> </tr> </thead> <tbody> <tr> <td>enumeration</td> <td>0364001</td> <td>documentation nein</td> </tr> <tr> <td>enumeration</td> <td>0364002</td> <td>documentation Schrittmacher ohne CRT-System</td> </tr> <tr> <td>enumeration</td> <td>0364003</td> <td>documentation Schrittmacher mit CRT-System</td> </tr> <tr> <td>enumeration</td> <td>0364004</td> <td>documentation Defibrillator ohne CRT-System</td> </tr> <tr> <td>enumeration</td> <td>0364005</td> <td>documentation Defibrillator mit CRT-System</td> </tr> </tbody> </table> | Kind | Value | Annotation | enumeration | 0364001 | documentation nein | enumeration | 0364002 | documentation Schrittmacher ohne CRT-System | enumeration | 0364003 | documentation Schrittmacher mit CRT-System | enumeration | 0364004 | documentation Defibrillator ohne CRT-System | enumeration | 0364005 | documentation Defibrillator mit CRT-System |
| Kind | Value | Annotation | | | | | | | | | | | | | | | | | |
| enumeration | 0364001 | documentation nein | | | | | | | | | | | | | | | | | |
| enumeration | 0364002 | documentation Schrittmacher ohne CRT-System | | | | | | | | | | | | | | | | | |
| enumeration | 0364003 | documentation Schrittmacher mit CRT-System | | | | | | | | | | | | | | | | | |
| enumeration | 0364004 | documentation Defibrillator ohne CRT-System | | | | | | | | | | | | | | | | | |
| enumeration | 0364005 | documentation Defibrillator mit CRT-System | | | | | | | | | | | | | | | | | |
| source | <code><element name="POA_SchrittmacherSchluessel" type="enum_0364" minOccurs="0"/></code> | | | | | | | | | | | | | | | | | | |

element **PostoperationAortenklappeBasis/POA_SepsisSchluessel**

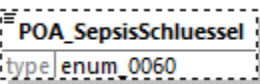
| diagram |  | | | | | | | | | |
|-------------|---|-----------------------|-------|------------|-------------|---------|---------------------|-------------|---------|-----------------------|
| type | enum 0060 | | | | | | | | | |
| properties | minOcc 0 maxOcc 1 content simple | | | | | | | | | |
| facets | <table border="1"> <thead> <tr> <th>Kind</th> <th>Value</th> <th>Annotation</th> </tr> </thead> <tbody> <tr> <td>enumeration</td> <td>0060001</td> <td>documentation ja</td> </tr> <tr> <td>enumeration</td> <td>0060002</td> <td>documentation nein</td> </tr> </tbody> </table> | Kind | Value | Annotation | enumeration | 0060001 | documentation ja | enumeration | 0060002 | documentation nein |
| Kind | Value | Annotation | | | | | | | | |
| enumeration | 0060001 | documentation ja | | | | | | | | |
| enumeration | 0060002 | documentation nein | | | | | | | | |
| source | <code><element name="POA_SepsisSchluessel" type="enum_0060" minOccurs="0"/></code> | | | | | | | | | |

element **PostoperationAortenklappeBasis/POA_EndokarditisSchluessel**

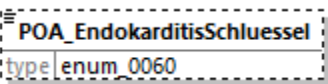
| diagram |  | | | | | | | | | |
|-------------|---|-----------------------|-------|------------|-------------|---------|---------------------|-------------|---------|-----------------------|
| type | enum 0060 | | | | | | | | | |
| properties | minOcc 0 maxOcc 1 content simple | | | | | | | | | |
| facets | <table border="1"> <thead> <tr> <th>Kind</th> <th>Value</th> <th>Annotation</th> </tr> </thead> <tbody> <tr> <td>enumeration</td> <td>0060001</td> <td>documentation ja</td> </tr> <tr> <td>enumeration</td> <td>0060002</td> <td>documentation nein</td> </tr> </tbody> </table> | Kind | Value | Annotation | enumeration | 0060001 | documentation ja | enumeration | 0060002 | documentation nein |
| Kind | Value | Annotation | | | | | | | | |
| enumeration | 0060001 | documentation ja | | | | | | | | |
| enumeration | 0060002 | documentation nein | | | | | | | | |
| source | <code><element name="POA_EndokarditisSchluessel" type="enum_0060" minOccurs="0"/></code> | | | | | | | | | |

element **PostoperationAortenklappeBasis/POA_DeltaPmax**

| diagram | | | | | | | | | | |
|--------------|---|------------|-------|------------|--------------|---|--|--------------|-----|--|
| type | Zahl3 | | | | | | | | | |
| properties | content simple | | | | | | | | | |
| facets | <table border="1"> <thead> <tr> <th>Kind</th> <th>Value</th> <th>Annotation</th> </tr> </thead> <tbody> <tr> <td>minInclusive</td> <td>1</td> <td></td> </tr> <tr> <td>maxInclusive</td> <td>999</td> <td></td> </tr> </tbody> </table> | Kind | Value | Annotation | minInclusive | 1 | | maxInclusive | 999 | |
| Kind | Value | Annotation | | | | | | | | |
| minInclusive | 1 | | | | | | | | | |
| maxInclusive | 999 | | | | | | | | | |
| source | <code><element name="POA_DeltaPmax" type="Zahl3"/></code> | | | | | | | | | |

element **PostoperationAortenklappeBasis/POA_DeltaPmaxUnbekannt**

| diagram | | | | | | | |
|------------|--|------------|-------|------------|---------|-----|--|
| type | JaLeer | | | | | | |
| properties | content simple | | | | | | |
| facets | <table border="1"> <thead> <tr> <th>Kind</th> <th>Value</th> <th>Annotation</th> </tr> </thead> <tbody> <tr> <td>pattern</td> <td>(1)</td> <td></td> </tr> </tbody> </table> | Kind | Value | Annotation | pattern | (1) | |
| Kind | Value | Annotation | | | | | |
| pattern | (1) | | | | | | |
| source | <code><element name="POA_DeltaPmaxUnbekannt" type="JaLeer"/></code> | | | | | | |

element **PostoperationAortenklappeBasis/POA_DeltaPmean**

| diagram | | | | | | | | | | |
|--------------|---|------------|-------|------------|--------------|---|--|--------------|-----|--|
| type | Zahl3 | | | | | | | | | |
| properties | content simple | | | | | | | | | |
| facets | <table border="1"> <thead> <tr> <th>Kind</th> <th>Value</th> <th>Annotation</th> </tr> </thead> <tbody> <tr> <td>minInclusive</td> <td>1</td> <td></td> </tr> <tr> <td>maxInclusive</td> <td>999</td> <td></td> </tr> </tbody> </table> | Kind | Value | Annotation | minInclusive | 1 | | maxInclusive | 999 | |
| Kind | Value | Annotation | | | | | | | | |
| minInclusive | 1 | | | | | | | | | |
| maxInclusive | 999 | | | | | | | | | |
| source | <code><element name="POA_DeltaPmean" type="Zahl3"/></code> | | | | | | | | | |

element **PostoperationAortenklappeBasis/POA_DeltaPmeanUnbekannt**

| diagram | | | | | | | |
|------------|--|------------|-------|------------|---------|-----|--|
| type | JaLeer | | | | | | |
| properties | content simple | | | | | | |
| facets | <table border="1"> <thead> <tr> <th>Kind</th> <th>Value</th> <th>Annotation</th> </tr> </thead> <tbody> <tr> <td>pattern</td> <td>(1)</td> <td></td> </tr> </tbody> </table> | Kind | Value | Annotation | pattern | (1) | |
| Kind | Value | Annotation | | | | | |
| pattern | (1) | | | | | | |

| | |
|--------|--|
| source | <code><element name="POA_DeltaPmeanUnbekannt" type="JaLeer"/></code> |
|--------|--|

element **PostoperationAortenklappeBasis/POA_Akoef**

| diagram | <pre> classDiagram class POA_Akoef { type Zahl1_1 min/maxIncl 0.1 9.9 } </pre> | | | | | | | | | | | | | | | |
|----------------|--|------------|-------|------------|--------------|-----|--|--------------|-----|--|-------------|---|--|----------------|---|--|
| type | Zahl1_1 | | | | | | | | | | | | | | | |
| properties | content simple | | | | | | | | | | | | | | | |
| facets | <table border="1"> <thead> <tr> <th>Kind</th> <th>Value</th> <th>Annotation</th> </tr> </thead> <tbody> <tr> <td>minInclusive</td> <td>0.1</td> <td></td> </tr> <tr> <td>maxInclusive</td> <td>9.9</td> <td></td> </tr> <tr> <td>totalDigits</td> <td>2</td> <td></td> </tr> <tr> <td>fractionDigits</td> <td>1</td> <td></td> </tr> </tbody> </table> | Kind | Value | Annotation | minInclusive | 0.1 | | maxInclusive | 9.9 | | totalDigits | 2 | | fractionDigits | 1 | |
| Kind | Value | Annotation | | | | | | | | | | | | | | |
| minInclusive | 0.1 | | | | | | | | | | | | | | | |
| maxInclusive | 9.9 | | | | | | | | | | | | | | | |
| totalDigits | 2 | | | | | | | | | | | | | | | |
| fractionDigits | 1 | | | | | | | | | | | | | | | |
| source | <code><element name="POA_Akoef" type="Zahl1_1"/></code> | | | | | | | | | | | | | | | |

element **PostoperationAortenklappeBasis/POA_AkoefUnbekannt**

| diagram | <pre> classDiagram class POA_AkoefUnbekannt { type JaLeer pattern (1) } </pre> | | | | | | |
|------------|--|------------|-------|------------|---------|-----|--|
| type | JaLeer | | | | | | |
| properties | content simple | | | | | | |
| facets | <table border="1"> <thead> <tr> <th>Kind</th> <th>Value</th> <th>Annotation</th> </tr> </thead> <tbody> <tr> <td>pattern</td> <td>(1)</td> <td></td> </tr> </tbody> </table> | Kind | Value | Annotation | pattern | (1) | |
| Kind | Value | Annotation | | | | | |
| pattern | (1) | | | | | | |
| source | <code><element name="POA_AkoefUnbekannt" type="JaLeer"/></code> | | | | | | |

element **PostoperationAortenklappeBasis/POA_AorteninsuffizienzSchluessel**

| diagram | <pre> classDiagram class POA_AorteninsuffizienzSchluessel { type enum_0373 } </pre> | | | | | | | | | | | | | | | | | | |
|-------------|--|-------------------------------|-------|------------|-------------|---------|------------------------|-------------|---------|-------------------------------|-------------|---------|-------------------------------|-------------|---------|-----------------------------|-------------|---------|----------------------------|
| type | enum_0373 | | | | | | | | | | | | | | | | | | |
| properties | <table border="1"> <tr> <td>minOcc</td> <td>0</td> </tr> <tr> <td>maxOcc</td> <td>1</td> </tr> <tr> <td>content</td> <td>simple</td> </tr> </table> | minOcc | 0 | maxOcc | 1 | content | simple | | | | | | | | | | | | |
| minOcc | 0 | | | | | | | | | | | | | | | | | | |
| maxOcc | 1 | | | | | | | | | | | | | | | | | | |
| content | simple | | | | | | | | | | | | | | | | | | |
| facets | <table border="1"> <thead> <tr> <th>Kind</th> <th>Value</th> <th>Annotation</th> </tr> </thead> <tbody> <tr> <td>enumeration</td> <td>0373001</td> <td>documentation keine</td> </tr> <tr> <td>enumeration</td> <td>0373002</td> <td>documentation leichtgradig</td> </tr> <tr> <td>enumeration</td> <td>0373003</td> <td>documentation mittelgradig</td> </tr> <tr> <td>enumeration</td> <td>0373004</td> <td>documentation hochgradig</td> </tr> <tr> <td>enumeration</td> <td>0373099</td> <td>documentation unbekannt</td> </tr> </tbody> </table> | Kind | Value | Annotation | enumeration | 0373001 | documentation keine | enumeration | 0373002 | documentation leichtgradig | enumeration | 0373003 | documentation mittelgradig | enumeration | 0373004 | documentation hochgradig | enumeration | 0373099 | documentation unbekannt |
| Kind | Value | Annotation | | | | | | | | | | | | | | | | | |
| enumeration | 0373001 | documentation keine | | | | | | | | | | | | | | | | | |
| enumeration | 0373002 | documentation leichtgradig | | | | | | | | | | | | | | | | | |
| enumeration | 0373003 | documentation mittelgradig | | | | | | | | | | | | | | | | | |
| enumeration | 0373004 | documentation hochgradig | | | | | | | | | | | | | | | | | |
| enumeration | 0373099 | documentation unbekannt | | | | | | | | | | | | | | | | | |
| source | <code><element name="POA_AorteninsuffizienzSchluessel" type="enum_0373"/></code> | | | | | | | | | | | | | | | | | | |

| | |
|--|---------------------------------|
| | <code>minOccurs="0"/></code> |
|--|---------------------------------|

element **PostoperationAortenklappeBasis/POA_MitralinsuffizienzSchluessel**

| | | | |
|------------|--|---------|-------------------------------|
| diagram | | | |
| type | enum 0373 | | |
| properties | minOcc 0 maxOcc 1 content simple | | |
| facets | Kind | Value | Annotation |
| | enumeration | 0373001 | documentation keine |
| | enumeration | 0373002 | documentation leichtgradig |
| | enumeration | 0373003 | documentation mittelgradig |
| | enumeration | 0373004 | documentation hochgradig |
| | enumeration | 0373099 | documentation unbekannt |
| source | <code><element name="POA_MitralinsuffizienzSchluessel" type="enum_0373" minOccurs="0"/></code> | | |

element **PostoperationAortenklappeBasis/POA_TrikuspidalinsuffizienzSchluessel**

| | | | |
|------------|---|---------|-------------------------------|
| diagram | | | |
| type | enum 0360 | | |
| properties | minOcc 0 maxOcc 1 content simple | | |
| facets | Kind | Value | Annotation |
| | enumeration | 0360001 | documentation keine |
| | enumeration | 0360002 | documentation leichtgradig |
| | enumeration | 0360003 | documentation mittelgradig |
| | enumeration | 0360004 | documentation hochgradig |
| | enumeration | 0360005 | documentation massive |
| | enumeration | 0360006 | documentation torrential |
| | enumeration | 0360099 | documentation unbekannt |
| source | <code><element name="POA_TrikuspidalinsuffizienzSchluessel" type="enum_0360" minOccurs="0"/></code> | | |

element **PostoperationAortenklappeBasis/POA_Lvef**

| diagram |  | | | | | | | | | |
|--------------|---|------------|-------|------------|--------------|---|--|--------------|-----|--|
| type | Zahl3 | | | | | | | | | |
| properties | content simple | | | | | | | | | |
| facets | <table border="1"> <thead> <tr> <th>Kind</th> <th>Value</th> <th>Annotation</th> </tr> </thead> <tbody> <tr> <td>minInclusive</td> <td>1</td> <td></td> </tr> <tr> <td>maxInclusive</td> <td>999</td> <td></td> </tr> </tbody> </table> | Kind | Value | Annotation | minInclusive | 1 | | maxInclusive | 999 | |
| Kind | Value | Annotation | | | | | | | | |
| minInclusive | 1 | | | | | | | | | |
| maxInclusive | 999 | | | | | | | | | |
| source | <code><element name="POA_Lvef" type="Zahl3"/></code> | | | | | | | | | |

element **PostoperationAortenklappeBasis/POA_LvefUnbekannt**

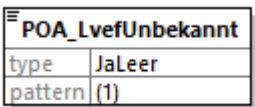
| diagram |  | | | | | | |
|------------|--|------------|-------|------------|---------|-----|--|
| type | JaLeer | | | | | | |
| properties | content simple | | | | | | |
| facets | <table border="1"> <thead> <tr> <th>Kind</th> <th>Value</th> <th>Annotation</th> </tr> </thead> <tbody> <tr> <td>pattern</td> <td>(1)</td> <td></td> </tr> </tbody> </table> | Kind | Value | Annotation | pattern | (1) | |
| Kind | Value | Annotation | | | | | |
| pattern | (1) | | | | | | |
| source | <code><element name="POA_LvefUnbekannt" type="JaLeer"/></code> | | | | | | |

element **PostoperationAortenklappeBasis/POA_VitalstatusSchluessel**

| diagram |  | | | | | | | | | |
|-------------|--|--|-------|------------|-------------|---------|-------------------------------|-------------|---------|--|
| type | enum 0399 | | | | | | | | | |
| properties | content simple | | | | | | | | | |
| facets | <table border="1"> <thead> <tr> <th>Kind</th> <th>Value</th> <th>Annotation</th> </tr> </thead> <tbody> <tr> <td>enumeration</td> <td>0399001</td> <td>documentation Patient lebt</td> </tr> <tr> <td>enumeration</td> <td>0399002</td> <td>documentation Patient im Krankenhaus verstorben</td> </tr> </tbody> </table> | Kind | Value | Annotation | enumeration | 0399001 | documentation Patient lebt | enumeration | 0399002 | documentation Patient im Krankenhaus verstorben |
| Kind | Value | Annotation | | | | | | | | |
| enumeration | 0399001 | documentation Patient lebt | | | | | | | | |
| enumeration | 0399002 | documentation Patient im Krankenhaus verstorben | | | | | | | | |
| source | <code><element name="POA_VitalstatusSchluessel" type="enum_0399"/></code> | | | | | | | | | |

element **PostoperationAortenklappeBasis/POA_TodesursacheSchluessel**

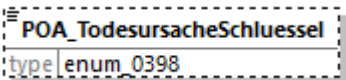
| | | | | | | | |
|------------|--|--------|---|--------|---|---------|--------|
| diagram |  | | | | | | |
| type | enum 0398 | | | | | | |
| properties | <table border="1"> <tbody> <tr> <td>minOcc</td> <td>0</td> </tr> <tr> <td>maxOcc</td> <td>1</td> </tr> <tr> <td>content</td> <td>simple</td> </tr> </tbody> </table> | minOcc | 0 | maxOcc | 1 | content | simple |
| minOcc | 0 | | | | | | |
| maxOcc | 1 | | | | | | |
| content | simple | | | | | | |

| | | | |
|--------|--|---------|--|
| facets | Kind | Value | Annotation |
| | enumeration | 0398001 | documentation kardiovaskuläre Ursache |
| | enumeration | 0398002 | documentation nicht-kardiovaskuläre Ursache |
| | enumeration | 0398099 | documentation Todesursache unbekannt |
| source | <code><element name="POA_TodesursacheSchluessel" type="enum_0398" minOccurs="0"/></code> | | |

element **PostoperationAortenklappeBasis/POA_AggregationshemmerSchluessel**

| | | | |
|------------|--|---------|--|
| diagram | | | |
| type | enum 0388 | | |
| properties | minOcc 0 maxOcc 1 content simple | | |
| facets | Kind | Value | Annotation |
| | enumeration | 0388001 | documentation nein |
| | enumeration | 0388002 | documentation ASS |
| | enumeration | 0388003 | documentation ADP-Rezeptor-Antagonist |
| | enumeration | 0388004 | documentation Kombination ASS und ADP-Rezeptor-Antagonist |
| | enumeration | 0388042 | documentation ja, andere |
| | enumeration | 0388099 | documentation unbekannt |
| source | <code><element name="POA_AggregationshemmerSchluessel" type="enum_0388" minOccurs="0"/></code> | | |

complexType **AntikoagulansAortenklappeBasis**

| | |
|-----------|---|
| diagram | |
| namespace | http://xml.ir-d.de/emg |
| children | AKA_AntikoagulansSchluessel |
| used by | element PostoperationAortenklappe/antikoagulansAortenklappe |
| source | <code><complexType name="AntikoagulansAortenklappeBasis"> <sequence> <element name="AKA_AntikoagulansSchluessel" type="enum_0389"/> </sequence> </complexType></code> |

element **AntikoagulansAortenklappeBasis/AKA_AntikoagulansSchluessel**

| | | | |
|------------|---|---------|---|
| diagram | | | |
| type | enum 0389 | | |
| properties | content simple | | |
| facets | Kind | Value | Annotation |
| | enumeration | 0389001 | documentation nein |
| | enumeration | 0389002 | documentation Cumarin-Derivate |
| | enumeration | 0389003 | documentation Heparinoide |
| | enumeration | 0389004 | documentation orale Thrombinantagonisten |
| | enumeration | 0389005 | documentation Kombination Heparinoide und Cumarin-Derivate |
| | enumeration | 0389006 | documentation Direkte orale Antikoagulantien (DOAK / NOAK) |
| | enumeration | 0389042 | documentation ja, andere |
| | enumeration | 0389099 | documentation unbekannt |
| source | <code><element name="AKA_AntikoagulansSchluessel" type="enum_0389"/></code> | | |

complexType **PatientenaufnahmeKardiologieBasis**

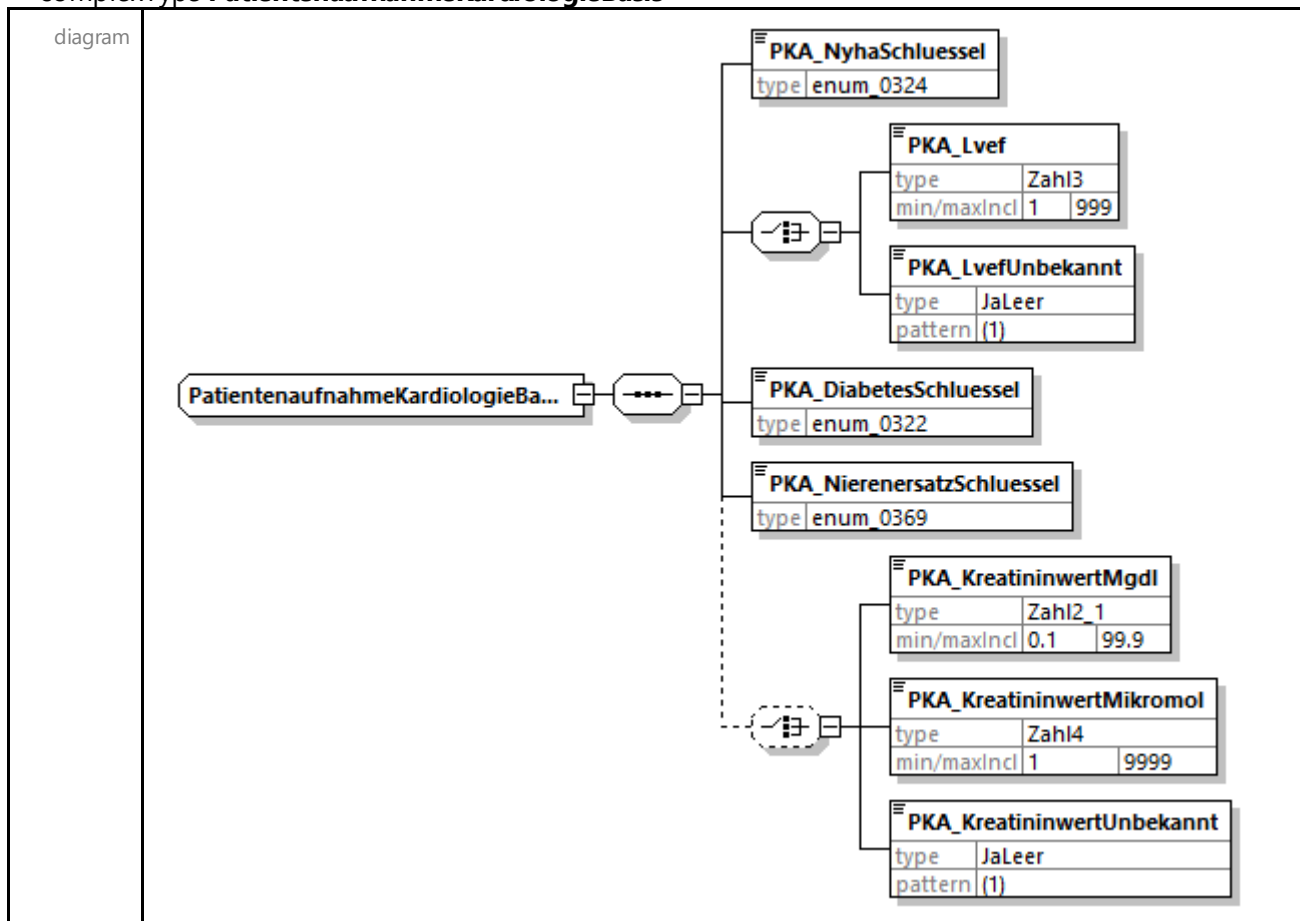

| | |
|-----------|---|
| namespace | http://xml.ir-d.de/emg |
| children | PKA NyhaSchluessel PKA Lvef PKA LvefUnbekannt PKA DiabetesSchluessel PKA NierenersatzSchluessel PKA KreatininwertMgdl PKA KreatininwertMikromol PKA KreatininwertUnbekannt |
| used by | complexType PatientenaufnahmeKardiologie |
| source | <pre> <complexType name="PatientenaufnahmeKardiologieBasis"> <sequence> <element name="PKA_NyhaSchluessel" type="enum_0324"/> <choice> <element name="PKA_Lvef" type="Zahl3"/> <element name="PKA_LvefUnbekannt" type="JaLeer"/> </choice> <element name="PKA_DiabetesSchluessel" type="enum_0322"/> <element name="PKA_NierenersatzSchluessel" type="enum_0369"/> <choice minOccurs="0"> <element name="PKA_KreatininwertMgdl" type="Zahl2_1"/> <element name="PKA_KreatininwertMikromol" type="Zahl14"/> <element name="PKA_KreatininwertUnbekannt" type="JaLeer"/> </choice> </sequence> </complexType> </pre> |

element [PatientenaufnahmeKardiologieBasis/PKA_NyhaSchluessel](#)

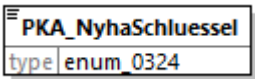
| diagram |  | | | | | | | | | | | | | | | |
|-------------|--|---|-------|------------|-------------|---------|---|-------------|---------|---|-------------|---------|---|-------------|---------|--|
| type | enum 0324 | | | | | | | | | | | | | | | |
| properties | content simple | | | | | | | | | | | | | | | |
| facets | <table border="1"> <thead> <tr> <th>Kind</th> <th>Value</th> <th>Annotation</th> </tr> </thead> <tbody> <tr> <td>enumeration</td> <td>0324001</td> <td>documentation (I): Beschwerdefreiheit, normale körperliche Belastbarkeit</td> </tr> <tr> <td>enumeration</td> <td>0324002</td> <td>documentation (II): Beschwerden bei stärkerer körperlicher Belastung</td> </tr> <tr> <td>enumeration</td> <td>0324003</td> <td>documentation (III): Beschwerden bei leichter körperlicher Belastung</td> </tr> <tr> <td>enumeration</td> <td>0324004</td> <td>documentation (IV): Beschwerden in Ruhe</td> </tr> </tbody> </table> | Kind | Value | Annotation | enumeration | 0324001 | documentation (I): Beschwerdefreiheit, normale körperliche Belastbarkeit | enumeration | 0324002 | documentation (II): Beschwerden bei stärkerer körperlicher Belastung | enumeration | 0324003 | documentation (III): Beschwerden bei leichter körperlicher Belastung | enumeration | 0324004 | documentation (IV): Beschwerden in Ruhe |
| Kind | Value | Annotation | | | | | | | | | | | | | | |
| enumeration | 0324001 | documentation (I): Beschwerdefreiheit, normale körperliche Belastbarkeit | | | | | | | | | | | | | | |
| enumeration | 0324002 | documentation (II): Beschwerden bei stärkerer körperlicher Belastung | | | | | | | | | | | | | | |
| enumeration | 0324003 | documentation (III): Beschwerden bei leichter körperlicher Belastung | | | | | | | | | | | | | | |
| enumeration | 0324004 | documentation (IV): Beschwerden in Ruhe | | | | | | | | | | | | | | |
| source | <code><element name="PKA_NyhaSchluessel" type="enum_0324"/></code> | | | | | | | | | | | | | | | |

element [PatientenaufnahmeKardiologieBasis/PKA_Lvef](#)

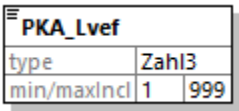
| diagram |  | | | | | | | | | |
|--------------|---|------------|-------|------------|--------------|---|--|--------------|-----|--|
| type | Zahl3 | | | | | | | | | |
| properties | content simple | | | | | | | | | |
| facets | <table border="1"> <thead> <tr> <th>Kind</th> <th>Value</th> <th>Annotation</th> </tr> </thead> <tbody> <tr> <td>minInclusive</td> <td>1</td> <td></td> </tr> <tr> <td>maxInclusive</td> <td>999</td> <td></td> </tr> </tbody> </table> | Kind | Value | Annotation | minInclusive | 1 | | maxInclusive | 999 | |
| Kind | Value | Annotation | | | | | | | | |
| minInclusive | 1 | | | | | | | | | |
| maxInclusive | 999 | | | | | | | | | |
| source | <code><element name="PKA_Lvef" type="Zahl3"/></code> | | | | | | | | | |

element **PatientenaufnahmeKardiologieBasis/PKA_LvefUnbekannt**

| diagram | | | | | | | |
|------------|--|------------|-------|------------|---------|-----|--|
| type | JaLeer | | | | | | |
| properties | content simple | | | | | | |
| facets | <table border="1"> <thead> <tr> <th>Kind</th> <th>Value</th> <th>Annotation</th> </tr> </thead> <tbody> <tr> <td>pattern</td> <td>(1)</td> <td></td> </tr> </tbody> </table> | Kind | Value | Annotation | pattern | (1) | |
| Kind | Value | Annotation | | | | | |
| pattern | (1) | | | | | | |
| source | <code><element name="PKA_LvefUnbekannt" type="JaLeer"/></code> | | | | | | |

element **PatientenaufnahmeKardiologieBasis/PKA_DiabetesSchluessel**

| diagram | | | | | | | | | | | | | | | | | | | | | | |
|-------------|--|--|-------|------------|-------------|---------|-----------------------|-------------|---------|---|-------------|---------|---------------------------------------|-------------|---------|--|-------------|---------|----------------------------------|-------------|---------|----------------------------|
| type | enum_0322 | | | | | | | | | | | | | | | | | | | | | |
| properties | content simple | | | | | | | | | | | | | | | | | | | | | |
| facets | <table border="1"> <thead> <tr> <th>Kind</th> <th>Value</th> <th>Annotation</th> </tr> </thead> <tbody> <tr> <td>enumeration</td> <td>0322001</td> <td>documentation nein</td> </tr> <tr> <td>enumeration</td> <td>0322002</td> <td>documentation ja, diätetisch behandelt</td> </tr> <tr> <td>enumeration</td> <td>0322003</td> <td>documentation ja, orale Medikation</td> </tr> <tr> <td>enumeration</td> <td>0322004</td> <td>documentation ja, mit Insulin behandelt</td> </tr> <tr> <td>enumeration</td> <td>0322005</td> <td>documentation ja, unbehandelt</td> </tr> <tr> <td>enumeration</td> <td>0322099</td> <td>documentation unbekannt</td> </tr> </tbody> </table> | Kind | Value | Annotation | enumeration | 0322001 | documentation nein | enumeration | 0322002 | documentation ja, diätetisch behandelt | enumeration | 0322003 | documentation ja, orale Medikation | enumeration | 0322004 | documentation ja, mit Insulin behandelt | enumeration | 0322005 | documentation ja, unbehandelt | enumeration | 0322099 | documentation unbekannt |
| Kind | Value | Annotation | | | | | | | | | | | | | | | | | | | | |
| enumeration | 0322001 | documentation nein | | | | | | | | | | | | | | | | | | | | |
| enumeration | 0322002 | documentation ja, diätetisch behandelt | | | | | | | | | | | | | | | | | | | | |
| enumeration | 0322003 | documentation ja, orale Medikation | | | | | | | | | | | | | | | | | | | | |
| enumeration | 0322004 | documentation ja, mit Insulin behandelt | | | | | | | | | | | | | | | | | | | | |
| enumeration | 0322005 | documentation ja, unbehandelt | | | | | | | | | | | | | | | | | | | | |
| enumeration | 0322099 | documentation unbekannt | | | | | | | | | | | | | | | | | | | | |
| source | <code><element name="PKA_DiabetesSchluessel" type="enum_0322"/></code> | | | | | | | | | | | | | | | | | | | | | |

element **PatientenaufnahmeKardiologieBasis/PKA_NierenersatzSchluessel**

| diagram | | | | | | | | | | | | | |
|-------------|---|----------------------------|-------|------------|-------------|---------|-----------------------|-------------|---------|-----------------------|-------------|---------|----------------------------|
| type | enum_0369 | | | | | | | | | | | | |
| properties | content simple | | | | | | | | | | | | |
| facets | <table border="1"> <thead> <tr> <th>Kind</th> <th>Value</th> <th>Annotation</th> </tr> </thead> <tbody> <tr> <td>enumeration</td> <td>0369001</td> <td>documentation nein</td> </tr> <tr> <td>enumeration</td> <td>0369002</td> <td>documentation akut</td> </tr> <tr> <td>enumeration</td> <td>0369003</td> <td>documentation chronisch</td> </tr> </tbody> </table> | Kind | Value | Annotation | enumeration | 0369001 | documentation nein | enumeration | 0369002 | documentation akut | enumeration | 0369003 | documentation chronisch |
| Kind | Value | Annotation | | | | | | | | | | | |
| enumeration | 0369001 | documentation nein | | | | | | | | | | | |
| enumeration | 0369002 | documentation akut | | | | | | | | | | | |
| enumeration | 0369003 | documentation chronisch | | | | | | | | | | | |
| source | <code><element name="PKA_NierenersatzSchluessel" type="enum_0369"/></code> | | | | | | | | | | | | |

element **PatientenaufnahmeKardiologieBasis/PKA_KreatininwertMgdl**

| diagram | <pre> PKA_KreatininwertMgdl type Zahl2_1 min/maxIncl 0.1 99.9 </pre> | | | | | | | | | | | | | | | |
|----------------|---|------------|-------|------------|--------------|-----|--|--------------|------|--|-------------|---|--|----------------|---|--|
| type | Zahl2_1 | | | | | | | | | | | | | | | |
| properties | content simple | | | | | | | | | | | | | | | |
| facets | <table border="1"> <thead> <tr> <th>Kind</th> <th>Value</th> <th>Annotation</th> </tr> </thead> <tbody> <tr> <td>minInclusive</td> <td>0.1</td> <td></td> </tr> <tr> <td>maxInclusive</td> <td>99.9</td> <td></td> </tr> <tr> <td>totalDigits</td> <td>3</td> <td></td> </tr> <tr> <td>fractionDigits</td> <td>1</td> <td></td> </tr> </tbody> </table> | Kind | Value | Annotation | minInclusive | 0.1 | | maxInclusive | 99.9 | | totalDigits | 3 | | fractionDigits | 1 | |
| Kind | Value | Annotation | | | | | | | | | | | | | | |
| minInclusive | 0.1 | | | | | | | | | | | | | | | |
| maxInclusive | 99.9 | | | | | | | | | | | | | | | |
| totalDigits | 3 | | | | | | | | | | | | | | | |
| fractionDigits | 1 | | | | | | | | | | | | | | | |
| source | <code><element name="PKA_KreatininwertMgdl" type="Zahl2_1"/></code> | | | | | | | | | | | | | | | |

element **PatientenaufnahmeKardiologieBasis/PKA_KreatininwertMikromol**

| diagram | <pre> PKA_KreatininwertMikromol type Zahl4 min/maxIncl 1 9999 </pre> | | | | | | | | | |
|--------------|--|------------|-------|------------|--------------|---|--|--------------|------|--|
| type | Zahl4 | | | | | | | | | |
| properties | content simple | | | | | | | | | |
| facets | <table border="1"> <thead> <tr> <th>Kind</th> <th>Value</th> <th>Annotation</th> </tr> </thead> <tbody> <tr> <td>minInclusive</td> <td>1</td> <td></td> </tr> <tr> <td>maxInclusive</td> <td>9999</td> <td></td> </tr> </tbody> </table> | Kind | Value | Annotation | minInclusive | 1 | | maxInclusive | 9999 | |
| Kind | Value | Annotation | | | | | | | | |
| minInclusive | 1 | | | | | | | | | |
| maxInclusive | 9999 | | | | | | | | | |
| source | <code><element name="PKA_KreatininwertMikromol" type="Zahl4"/></code> | | | | | | | | | |

element **PatientenaufnahmeKardiologieBasis/PKA_KreatininwertUnbekannt**

| diagram | <pre> PKA_KreatininwertUnbekannt type JaLeer pattern (1) </pre> | | | | | | |
|------------|--|------------|-------|------------|---------|-----|--|
| type | JaLeer | | | | | | |
| properties | content simple | | | | | | |
| facets | <table border="1"> <thead> <tr> <th>Kind</th> <th>Value</th> <th>Annotation</th> </tr> </thead> <tbody> <tr> <td>pattern</td> <td>(1)</td> <td></td> </tr> </tbody> </table> | Kind | Value | Annotation | pattern | (1) | |
| Kind | Value | Annotation | | | | | |
| pattern | (1) | | | | | | |
| source | <code><element name="PKA_KreatininwertUnbekannt" type="JaLeer"/></code> | | | | | | |

complexType PatientenaufnahmeAortenklappe

diagram

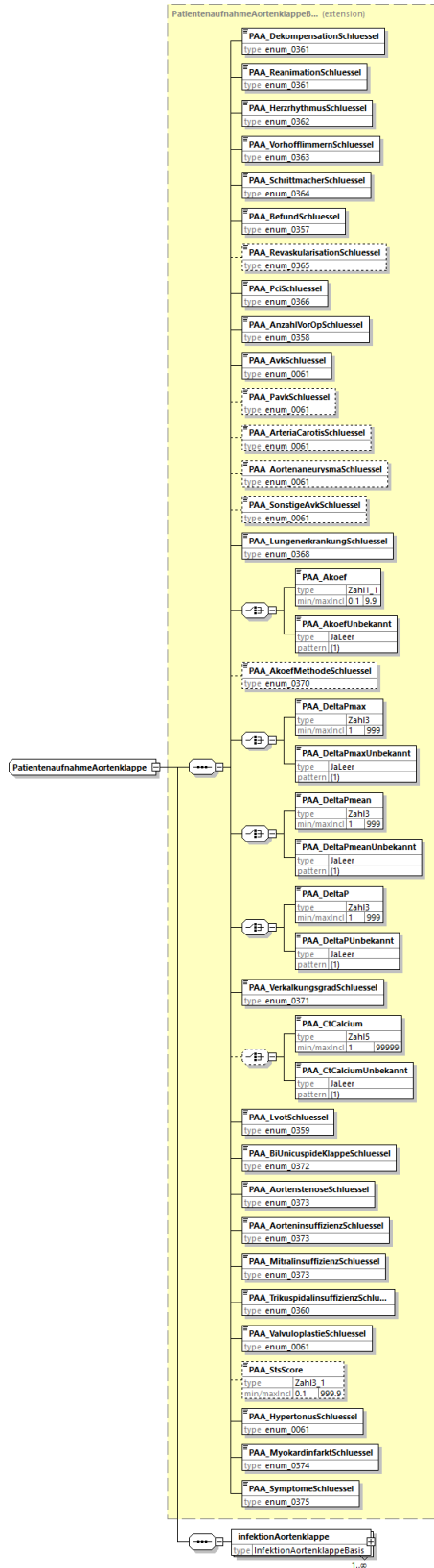

| | |
|------------|---|
| namespace | http://xml.ir-d.de/emg |
| type | extension of PatientenaufnahmeAortenklappeBasis |
| properties | base PatientenaufnahmeAortenklappeBasis |

| | |
|----------|---|
| children | PAA DekompensationSchluessel PAA ReanimationSchluessel PAA HerzrhythmusSchluessel PAA VorhofflimmernSchluessel PAA SchrittmacherSchluessel PAA BefundSchluessel PAA RevaskularisationSchluessel PAA PciSchluessel PAA AnzahlVorOpSchluessel PAA AvkSchluessel PAA PavkSchluessel PAA ArteriaCarotisSchluessel PAA AortenaneurysmaSchluessel PAA SonstigeAvkSchluessel PAA LungenerkrankungSchluessel PAA Akoef PAA AkoefUnbekannt PAA AkoefMethodeSchluessel PAA DeltaPmax PAA DeltaPmaxUnbekannt PAA DeltaPmean PAA DeltaPmeanUnbekannt PAA DeltaP PAA DeltaPUnbekannt PAA VerkalkungsgradSchluessel PAA CtCalcium PAA CtCalciumUnbekannt PAA LvotSchluessel PAA BiUnicuspideKlappeSchluessel PAA AortenstenoseSchluessel PAA AorteninsuffizienzSchluessel PAA MitralsuffizienzSchluessel PAA TrikuspidalinsuffizienzSchluessel PAA ValvuloplastieSchluessel PAA StsScore PAA HypertonusSchluessel PAA MyokardinfarktSchluessel PAA SymptomeSchluessel infektionAortenklappe |
| used by | element PatientenaufnahmeKardiologie/patientenaufnahmeAortenklappe |
| source | <pre> <complexType name="PatientenaufnahmeAortenklappe"> <complexContent> <extension base="PatientenaufnahmeAortenklappeBasis"> <sequence> <element name="infektionAortenklappe" type="InfektionAortenklappeBasis" maxOccurs="unbounded"/> </sequence> </extension> </complexContent> </complexType> </pre> |

element **PatientenaufnahmeAortenklappe/infektionAortenklappe**

| | |
|------------|--|
| diagram | |
| type | InfektionAortenklappeBasis |
| properties | minOcc 1 maxOcc unbounded content complex |
| children | IAK InfektionSchluessel |
| source | <pre> <element name="infektionAortenklappe" type="InfektionAortenklappeBasis" maxOccurs="unbounded"/> </pre> |

complexType **OperationBrustimplantatBasis**

| | |
|------------------|---|
| <p>diagram</p> | |
| <p>namespace</p> | <p>http://xml.ir-d.de/emg</p> |
| <p>children</p> | <p>OBI_ArtEingriffSchluessel OBI_GrundPrimaerEingriffSchluessel OBI_GrundAustauschSchluessel OBI_GrundRevisionExplantationSchluessel OBI_LageSchluessel OBI_ZugangSchluessel OBI_EntfernungAdmNetzSchluessel OBI_VerfahrenswechselSchluessel</p> |
| <p>used by</p> | <p>complexType OperationBrustimplantat</p> |
| <p>source</p> | <pre><complexType name="OperationBrustimplantatBasis"> <sequence> <element name="OBI_ArtEingriffSchluessel" type="enum_0100"/> <choice> <element name="OBI_GrundPrimaerEingriffSchluessel" type="enum_0102"/> <element name="OBI_GrundAustauschSchluessel" type="enum_0104"/> <element name="OBI_GrundRevisionExplantationSchluessel" type="enum_0106"/> </choice> <element name="OBI_LageSchluessel" type="enum_0112" minOccurs="0"/> <element name="OBI_ZugangSchluessel" type="enum_0118" minOccurs="0"/> <element name="OBI_EntfernungAdmNetzSchluessel" type="enum_0114" minOccurs="0"/> <element name="OBI_VerfahrenswechselSchluessel" type="enum_0111" minOccurs="0"/> </sequence> </complexType></pre> |

element **OperationBrustimplantatBasis/OBI_ArtEingriffSchluessel**

| | |
|----------------|----------------------------------|
| <p>diagram</p> | |
| <p>type</p> | <p>enum 0100</p> |

| | | | |
|------------|--|---------|--|
| properties | content simple | | |
| facets | Kind | Value | Annotation |
| | enumeration | 0100001 | documentation Primäreingriff |
| | enumeration | 0100002 | documentation Austausch Expander gegen dauerhaftes Brustimplantat |
| | enumeration | 0100003 | documentation Revision |
| | enumeration | 0100004 | documentation Nur Explantation |
| source | <element name="OBI_ArtEingriffSchluessel" type="enum_0100"/> | | |

element **OperationBrustimplantatBasis/OBI_GrundPrimaerEingriffSchluessel**

| | | | |
|------------|---|---------|---|
| diagram | | | |
| type | enum 0102 | | |
| properties | content simple | | |
| facets | Kind | Value | Annotation |
| | enumeration | 0102001 | documentation kosmetische Augmentation |
| | enumeration | 0102002 | documentation Rekonstruktion, benigne |
| | enumeration | 0102003 | documentation Rekonstruktion nach Mastektomie aufgrund eines Karzinoms |
| | enumeration | 0102004 | documentation Rekonstruktion nach risikoreduzierender Mastektomie |
| source | <element name="OBI_GrundPrimaerEingriffSchluessel" type="enum_0102"/> | | |

element **OperationBrustimplantatBasis/OBI_GrundAustauschSchluessel**

| | | | |
|------------|---|---------|--|
| diagram | | | |
| type | enum 0104 | | |
| properties | content simple | | |
| facets | Kind | Value | Annotation |
| | enumeration | 0104001 | documentation Austausch Expander gegen dauerhaftes Brustimplantat |
| source | <element name="OBI_GrundAustauschSchluessel" type="enum_0104"/> | | |

element **OperationBrustimplantatBasis/OBI_GrundRevisionExplantationSchluessel**

| | | | |
|------------|---------------------------|---------|---------------|
| diagram | | | |
| type | enum 0106 | | |
| properties | content simple | | |
| facets | Kind | Value | Annotation |
| | enumeration | 0106001 | documentation |

| | | |
|--------|--|--|
| | enumeration 0106002 | Patientenwunsch documentation asymptomatisch |
| | enumeration 0106003 | documentation Komplikation |
| source | <element name="OBI_GrundRevisionExplantationSchluessel" type="enum_0106"/> | |

element **OperationBrustimplantatBasis/OBI_LageSchluessel**

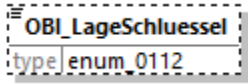
| | | | |
|------------|---|---------|---|
| diagram |  | | |
| type | enum 0112 | | |
| properties | minOcc 0 maxOcc 1 content simple | | |
| facets | Kind | Value | Annotation |
| | enumeration | 0112001 | documentation subglandulär / epipektoral |
| | enumeration | 0112002 | documentation subpektoral |
| | enumeration | 0112003 | documentation subfaszial |
| | enumeration | 0112004 | documentation sub-flap |
| | enumeration | 0112005 | documentation subkutan |
| | enumeration | 0112006 | documentation dual plane |
| | enumeration | 0112042 | documentation andere |
| source | <element name="OBI_LageSchluessel" type="enum_0112" minOccurs="0"/> | | |

element **OperationBrustimplantatBasis/OBI_ZugangSchluessel**

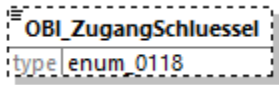
| | | | |
|------------|---|---------|-----------------------------------|
| diagram |  | | |
| type | enum 0118 | | |
| properties | minOcc 0 maxOcc 1 content simple | | |
| facets | Kind | Value | Annotation |
| | enumeration | 0118001 | documentation axillär |
| | enumeration | 0118002 | documentation periareolär |
| | enumeration | 0118003 | documentation inframammär |
| | enumeration | 0118004 | documentation Mastektomienarbe |
| | enumeration | 0118042 | documentation anderer |
| source | <element name="OBI_ZugangSchluessel" type="enum_0118" minOccurs="0"/> | | |

element **OperationBrustimplantatBasis/OBI_EntfernungAdmNetzSchluessel**

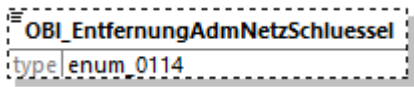
| diagram |  | | | | | | | | | | | | | | | |
|-------------|--|----------------------------------|-------|------------|-------------|---------|------------------------------|-------------|---------|-----------------------|-------------|---------|----------------------------|-------------|---------|----------------------------------|
| type | enum 0114 | | | | | | | | | | | | | | | |
| properties | minOcc 0 maxOcc 1 content simple | | | | | | | | | | | | | | | |
| facets | <table border="1"> <thead> <tr> <th>Kind</th> <th>Value</th> <th>Annotation</th> </tr> </thead> <tbody> <tr> <td>enumeration</td> <td>0114001</td> <td>documentation vollständig</td> </tr> <tr> <td>enumeration</td> <td>0114002</td> <td>documentation nein</td> </tr> <tr> <td>enumeration</td> <td>0114003</td> <td>documentation teilweise</td> </tr> <tr> <td>enumeration</td> <td>0114004</td> <td>documentation nicht vorhanden</td> </tr> </tbody> </table> | Kind | Value | Annotation | enumeration | 0114001 | documentation vollständig | enumeration | 0114002 | documentation nein | enumeration | 0114003 | documentation teilweise | enumeration | 0114004 | documentation nicht vorhanden |
| Kind | Value | Annotation | | | | | | | | | | | | | | |
| enumeration | 0114001 | documentation vollständig | | | | | | | | | | | | | | |
| enumeration | 0114002 | documentation nein | | | | | | | | | | | | | | |
| enumeration | 0114003 | documentation teilweise | | | | | | | | | | | | | | |
| enumeration | 0114004 | documentation nicht vorhanden | | | | | | | | | | | | | | |
| source | <code><element name="OBI_EntfernungAdmNetzSchluessel" type="enum_0114" minOccurs="0"/></code> | | | | | | | | | | | | | | | |

element **OperationBrustimplantatBasis/OBI_VerfahrenswechselSchluessel**

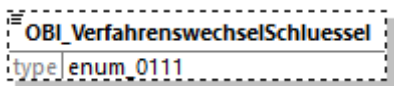
| diagram |  | | | | | | | | | | | | |
|-------------|---|---|-------|------------|-------------|---------|-----------------------|-------------|---------|------------------------------|-------------|---------|---|
| type | enum 0111 | | | | | | | | | | | | |
| properties | minOcc 0 maxOcc 1 content simple | | | | | | | | | | | | |
| facets | <table border="1"> <thead> <tr> <th>Kind</th> <th>Value</th> <th>Annotation</th> </tr> </thead> <tbody> <tr> <td>enumeration</td> <td>0111001</td> <td>documentation nein</td> </tr> <tr> <td>enumeration</td> <td>0111002</td> <td>documentation Lipofilling</td> </tr> <tr> <td>enumeration</td> <td>0111003</td> <td>documentation Eigengewebstrekonstruktion</td> </tr> </tbody> </table> | Kind | Value | Annotation | enumeration | 0111001 | documentation nein | enumeration | 0111002 | documentation Lipofilling | enumeration | 0111003 | documentation Eigengewebstrekonstruktion |
| Kind | Value | Annotation | | | | | | | | | | | |
| enumeration | 0111001 | documentation nein | | | | | | | | | | | |
| enumeration | 0111002 | documentation Lipofilling | | | | | | | | | | | |
| enumeration | 0111003 | documentation Eigengewebstrekonstruktion | | | | | | | | | | | |
| source | <code><element name="OBI_VerfahrenswechselSchluessel" type="enum_0111" minOccurs="0"/></code> | | | | | | | | | | | | |

complexType **VorbehandlungBrustimplantatBasis**

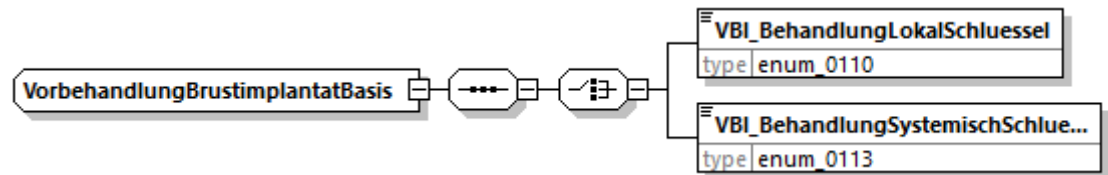
| | |
|-----------|--|
| diagram |  |
| namespace | http://xml.ir-d.de/emg |
| children | VBI_BehandlungLokalSchluessel VBI_BehandlungSystemischSchluessel |
| used by | element OperationBrustimplantat/vorbehandlungBrustimplantat |
| source | <code><complexType name="VorbehandlungBrustimplantatBasis"> <sequence></code> |

| | |
|--|---|
| | <pre> <choice> <element name="VBI_BehandlungLokalSchluessel" type="enum_0110"/> <element name="VBI_BehandlungSystemischSchluessel" type="enum_0113"/> </choice> </sequence> </complexType> </pre> |
|--|---|

element **VorbehandlungBrustimplantatBasis/VBI_BehandlungLokalSchluessel**

| diagram | | | | | | | |
|-------------|---|------------------------------|-------|------------|-------------|---------|------------------------------|
| type | enum 0110 | | | | | | |
| properties | content simple | | | | | | |
| facets | <table border="1"> <thead> <tr> <th>Kind</th> <th>Value</th> <th>Annotation</th> </tr> </thead> <tbody> <tr> <td>enumeration</td> <td>0110001</td> <td>documentation Bestrahlung</td> </tr> </tbody> </table> | Kind | Value | Annotation | enumeration | 0110001 | documentation Bestrahlung |
| Kind | Value | Annotation | | | | | |
| enumeration | 0110001 | documentation Bestrahlung | | | | | |
| source | <code><element name="VBI_BehandlungLokalSchluessel" type="enum_0110"/></code> | | | | | | |

element **VorbehandlungBrustimplantatBasis/VBI_BehandlungSystemischSchluessel**

| diagram | | | | | | | |
|-------------|---|--|-------|------------|-------------|---------|--|
| type | enum 0113 | | | | | | |
| properties | content simple | | | | | | |
| facets | <table border="1"> <thead> <tr> <th>Kind</th> <th>Value</th> <th>Annotation</th> </tr> </thead> <tbody> <tr> <td>enumeration</td> <td>0113001</td> <td>documentation Chemotherapie innerhalb der letzten drei Monate</td> </tr> </tbody> </table> | Kind | Value | Annotation | enumeration | 0113001 | documentation Chemotherapie innerhalb der letzten drei Monate |
| Kind | Value | Annotation | | | | | |
| enumeration | 0113001 | documentation Chemotherapie innerhalb der letzten drei Monate | | | | | |
| source | <code><element name="VBI_BehandlungSystemischSchluessel" type="enum_0113"/></code> | | | | | | |

complexType **MassnahmeBrustimplantatBasis**

| | |
|-----------|---|
| diagram | |
| namespace | http://xml.ir-d.de/emg |
| children | MAB_MassnahmeSchluessel |
| used by | element OperationBrustimplantat/massnahmeBrustimplantat |
| source | <pre> <complexType name="MassnahmeBrustimplantatBasis"> <sequence> <element name="MAB_MassnahmeSchluessel" type="enum_0116"/> </sequence> </complexType> </pre> |

element **MassnahmeBrustimplantatBasis/MAB_MassnahmeSchluessel**

| | | | |
|------------|---|---------|--|
| diagram | | | |
| type | enum 0116 | | |
| properties | content simple | | |
| facets | Kind | Value | Annotation |
| | enumeration | 0116001 | documentation Spülung, antibiotisch |
| | enumeration | 0116002 | documentation Spülung, antiseptisch |
| | enumeration | 0116003 | documentation Spülung, wirkstofffrei |
| | enumeration | 0116004 | documentation Spülung, andere |
| | enumeration | 0116005 | documentation prä-/perioperative Antibiotika |
| | enumeration | 0116006 | documentation postoperative Antibiotika |
| | enumeration | 0116007 | documentation Handschuhwechsel vor Implantation |
| | enumeration | 0116008 | documentation Implantationshilfe |
| source | <code><element name="MAB_MassnahmeSchluessel" type="enum_0116"/></code> | | |

complexType **OperationsdetailBrustimplantatBasis**

| | | | |
|-----------|--|--|--|
| diagram | | | |
| namespace | http://xml.ir-d.de/emg | | |
| children | ODB_OperationsdetailPrimaerEingriffSchluessel ODB_OperationsdetailAustauschSchluessel ODB_OperationsdetailRevisionSchluessel | | |
| used by | element | OperationBrustimplantat/operationsdetailBrustimplantat | |
| source | <pre> <complexType name="OperationsdetailBrustimplantatBasis"> <sequence> <choice> <element name="ODB_OperationsdetailPrimaerEingriffSchluessel" type="enum_0103"/> <element name="ODB_OperationsdetailAustauschSchluessel" type="enum_0105"/> <element name="ODB_OperationsdetailRevisionSchluessel" type="enum_0107"/> </choice> </sequence> </complexType> </pre> | | |

element **OperationsdetailBrustimplantatBasis/ODB_OperationsdetailPrimaerEingriffSchluessel**

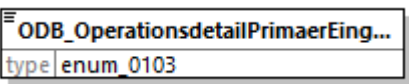
| | | | |
|------------|---|---------|---|
| diagram |  | | |
| type | enum 0103 | | |
| properties | content simple | | |
| facets | Kind | Value | Annotation |
| | enumeration | 0103001 | documentation simultane Lappendeckung |
| | enumeration | 0103002 | documentation simultane Eigenfetttransplantation |
| | enumeration | 0103003 | documentation simultane Mastopexie |
| | enumeration | 0103005 | documentation simultane Mastektomie, Ablatio / hautsparend |
| | enumeration | 0103006 | documentation simultane Mastektomie, nippelerhaltend |
| | enumeration | 0103007 | documentation Axilla-Dissektion |
| | enumeration | 0103008 | documentation Drainage |
| source | <pre><element name="ODB_OperationsdetailPrimaerEingriffSchluessel" type="enum_0103"/></pre> | | |

element **OperationsdetailBrustimplantatBasis/ODB_OperationsdetailAustauschSchluessel**

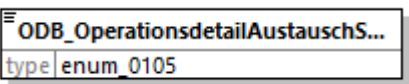
| | | | |
|------------|---|---------|---|
| diagram |  | | |
| type | enum 0105 | | |
| properties | content simple | | |
| facets | Kind | Value | Annotation |
| | enumeration | 0105001 | documentation simultane Lappendeckung |
| | enumeration | 0105002 | documentation simultane Eigenfetttransplantation |
| | enumeration | 0105003 | documentation simultane Mastopexie |
| | enumeration | 0105008 | documentation Drainage |
| | enumeration | 0105009 | documentation Kapsulektomie, komplett |
| | enumeration | 0105010 | documentation Kapsulektomie, partiell |
| | enumeration | 0105011 | documentation Neopocket |
| source | <pre><element name="ODB_OperationsdetailAustauschSchluessel" type="enum_0105"/></pre> | | |

element **OperationsdetailBrustimplantatBasis/ODB_OperationsdetailRevisionSchluessel**

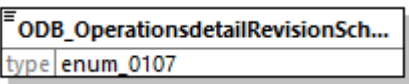
| | | | |
|---------|---|--|--|
| diagram |  | | |
| type | enum 0107 | | |

| | | | |
|------------|--|---------|---|
| properties | content simple | | |
| facets | Kind | Value | Annotation |
| | enumeration | 0107001 | documentation simultane Lappendeckung |
| | enumeration | 0107002 | documentation simultane Eigenfetttransplantation |
| | enumeration | 0107003 | documentation simultane Mastopexie |
| | enumeration | 0107005 | documentation simultane Mastektomie, Ablatio / hautsparend |
| | enumeration | 0107006 | documentation simultane Mastektomie, nippelerhaltend |
| | enumeration | 0107007 | documentation Axilla-Dissektion |
| | enumeration | 0107008 | documentation Drainage |
| | enumeration | 0107009 | documentation Kapsulektomie, komplett |
| | enumeration | 0107010 | documentation Kapsulektomie, partiell |
| | enumeration | 0107011 | documentation Neopocket |
| source | <code><element name="ODB_OperationsdetailRevisionSchluessel" type="enum_0107"/></code> | | |

complexType **BefundBrustimplantatBasis**

| | |
|-----------|---|
| diagram | |
| namespace | http://xml.ir-d.de/emg |
| children | BEB_BefundSchluessel BEB_BefundAustauschSchluessel |
| used by | element OperationBrustimplantat/befundBrustimplantat |
| source | <pre> <complexType name="BefundBrustimplantatBasis"> <sequence> <choice> <element name="BEB_BefundSchluessel" type="enum_0121"/> <element name="BEB_BefundAustauschSchluessel" type="enum_0120"/> </choice> </sequence> </complexType> </pre> |

element **BefundBrustimplantatBasis/BEB_BefundSchluessel**

| | | | | | | | |
|-------------|---|---------------|-------|------------|-------------|---------|---------------|
| diagram | | | | | | | |
| type | enum 0121 | | | | | | |
| properties | content simple | | | | | | |
| facets | <table border="1"> <tr> <td>Kind</td> <td>Value</td> <td>Annotation</td> </tr> <tr> <td>enumeration</td> <td>0121001</td> <td>documentation</td> </tr> </table> | Kind | Value | Annotation | enumeration | 0121001 | documentation |
| Kind | Value | Annotation | | | | | |
| enumeration | 0121001 | documentation | | | | | |

| | | | |
|--------|--|---------|---|
| | enumeration | 0121002 | Infektion documentation Serom |
| | enumeration | 0121003 | documentation Hämatom |
| | enumeration | 0121004 | documentation Kapsel fibrose |
| | enumeration | 0121005 | documentation Implantatruptur |
| | enumeration | 0121006 | documentation Fehlpositionierung/Rotation |
| | enumeration | 0121007 | documentation BIA-ALCL/-SCC, Verdacht |
| | enumeration | 0121008 | documentation BIA-ALCL/-SCC, pathologisch bestätigt |
| | enumeration | 0121009 | documentation Brustschmerzen |
| | enumeration | 0121010 | documentation Doppelkapsel |
| | enumeration | 0121011 | documentation Netz-/ADM-bedingte Komplikation, Non-Integration |
| | enumeration | 0121012 | documentation Netz-/ADM-bedingte Komplikation, andere |
| | enumeration | 0121013 | documentation Hautnekrose/exponiertes Implantat |
| | enumeration | 0121014 | documentation BII/ASIA (Brustimplantat assoziierte Symptome), Verdacht |
| | enumeration | 0121015 | documentation Lymphadenopathie |
| | enumeration | 0121016 | documentation Brustkrebs, neu aufgetreten/Rezidiv |
| source | <code><element name="BEB_BefundSchluessel" type="enum_0121"/></code> | | |

element **BefundBrustimplantatBasis/BEB_BefundAustauschSchluessel**

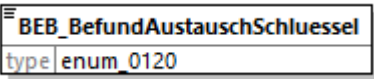
| | | | |
|------------|---|---------|----------------------------------|
| diagram |  | | |
| type | enum 0120 | | |
| properties | content simple | | |
| facets | Kind | Value | Annotation |
| | enumeration | 0120001 | documentation Expander defekt |
| source | <code><element name="BEB_BefundAustauschSchluessel" type="enum_0120"/></code> | | |

complexType **ProzedurenSchluesselBrustimplantatBasis**

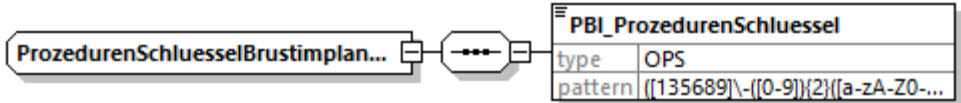
| | | | |
|-----------|--|--|--|
| diagram |  | | |
| namespace | http://xml.ir-d.de/emg | | |
| children | PBI_ProzedurenSchluessel | | |
| used by | element | OperationBrustimplantat/prozedurenSchluesselBrustimplantat | |

| | |
|--------|---|
| source | <pre><complexType name="ProzedurenSchluesselBrustimplantatBasis"> <sequence> <element name="PBI_ProzedurenSchluessel" type="OPS"/> </sequence> </complexType></pre> |
|--------|---|

element **ProzedurenSchluesselBrustimplantatBasis/PBI_ProzedurenSchluessel**

| diagram | | | | | | | |
|------------|--|------------|-------|------------|---------|---|--|
| type | OPS | | | | | | |
| properties | content simple | | | | | | |
| facets | <table border="1"> <thead> <tr> <th>Kind</th> <th>Value</th> <th>Annotation</th> </tr> </thead> <tbody> <tr> <td>pattern</td> <td>(([135689]\-[0-9]){2}([a-zA-Z0-9]{1}\.[a-zA-Z0-9]{1,2}))*(:[RLBrlb])?</td> <td></td> </tr> </tbody> </table> | Kind | Value | Annotation | pattern | (([135689]\-[0-9]){2}([a-zA-Z0-9]{1}\.[a-zA-Z0-9]{1,2}))*(:[RLBrlb])? | |
| Kind | Value | Annotation | | | | | |
| pattern | (([135689]\-[0-9]){2}([a-zA-Z0-9]{1}\.[a-zA-Z0-9]{1,2}))*(:[RLBrlb])? | | | | | | |
| source | <pre><element name="PBI_ProzedurenSchluessel" type="OPS"/></pre> | | | | | | |

complexType **OperationEndoprotheseBasis**

diagram

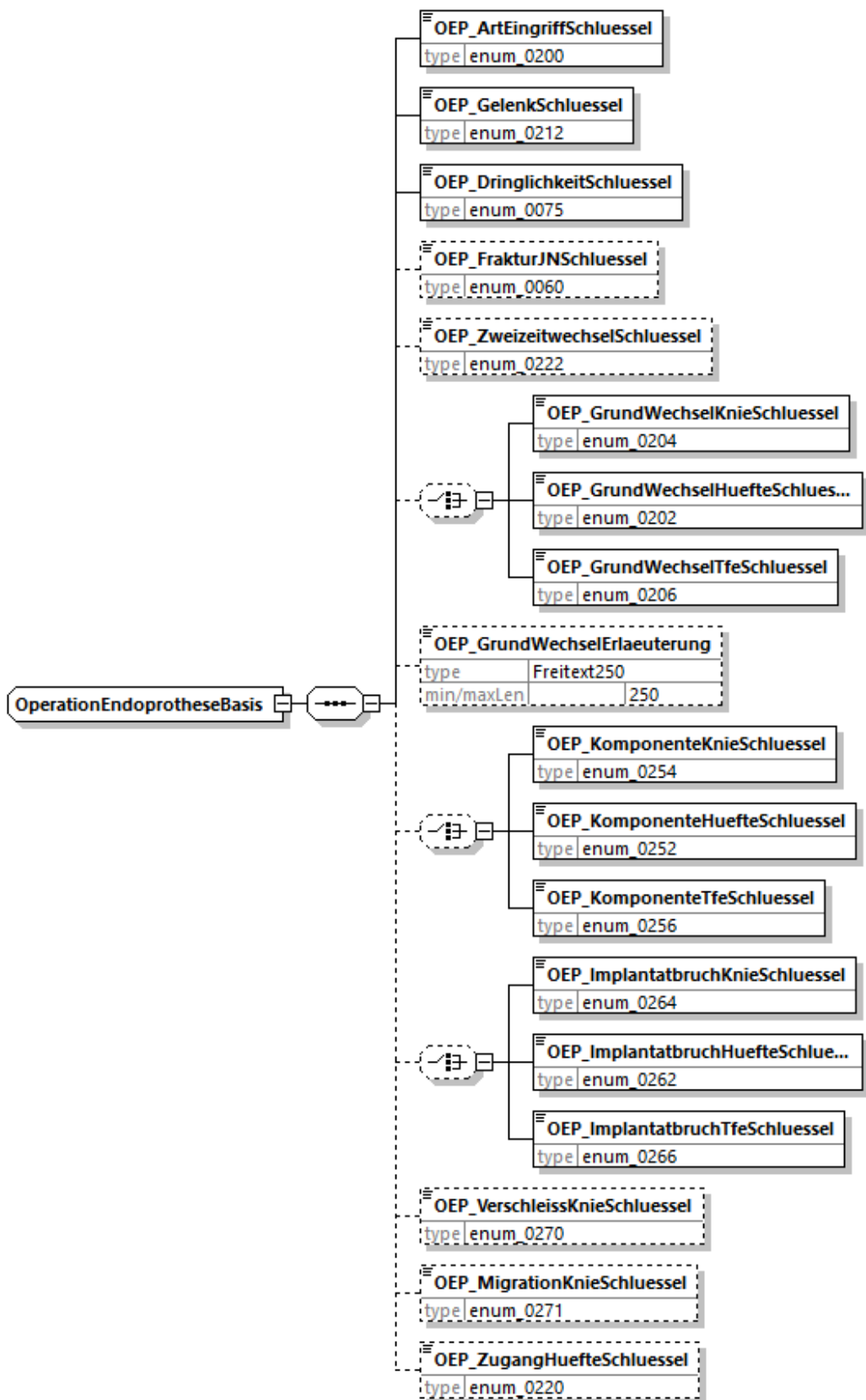

namespace <http://xml.ir-d.de/emg>

children [OEP_ArtEingriffSchluessel](#) [OEP_GelenkSchluessel](#) [OEP_DringlichkeitSchluessel](#) [OEP_FrakturJNSchluessel](#) [OEP_ZweizeitwechselSchluessel](#) [OEP_GrundWechselKnieSchluessel](#) [OEP_GrundWechselHuefteSchluessel](#)

| | |
|---------|--|
| | OEP GrundWechselTfeSchluessel OEP GrundWechselErlaeuterung OEP KomponenteKnieSchluessel OEP KomponenteHuefteSchluessel OEP KomponenteTfeSchluessel OEP ImplantatbruchKnieSchluessel OEP ImplantatbruchHuefteSchluessel OEP ImplantatbruchTfeSchluessel OEP VerschleissKnieSchluessel OEP MigrationKnieSchluessel OEP ZugangHuefteSchluessel |
| used by | complexType OperationEndoprothese |
| source | <pre> <complexType name="OperationEndoprotheseBasis"> <sequence> <element name="OEP_ArtEingriffSchluessel" type="enum_0200"/> <element name="OEP_GelenkSchluessel" type="enum_0212"/> <element name="OEP_DringlichkeitSchluessel" type="enum_0075"/> <element name="OEP_FrakturJNSchluessel" type="enum_0060" minOccurs="0"/> <element name="OEP_ZweizeitwechselSchluessel" type="enum_0222" minOccurs="0"/> <choice minOccurs="0"> <element name="OEP_GrundWechselKnieSchluessel" type="enum_0204"/> <element name="OEP_GrundWechselHuefteSchluessel" type="enum_0202"/> <element name="OEP_GrundWechselTfeSchluessel" type="enum_0206"/> </choice> <element name="OEP_GrundWechselErlaeuterung" type="Freitext250" minOccurs="0"/> <choice minOccurs="0"> <element name="OEP_KomponenteKnieSchluessel" type="enum_0254"/> <element name="OEP_KomponenteHuefteSchluessel" type="enum_0252"/> <element name="OEP_KomponenteTfeSchluessel" type="enum_0256"/> </choice> <choice minOccurs="0"> <element name="OEP_ImplantatbruchKnieSchluessel" type="enum_0264"/> <element name="OEP_ImplantatbruchHuefteSchluessel" type="enum_0262"/> <element name="OEP_ImplantatbruchTfeSchluessel" type="enum_0266"/> </choice> <element name="OEP_VerschleissKnieSchluessel" type="enum_0270" minOccurs="0"/> <element name="OEP_MigrationKnieSchluessel" type="enum_0271" minOccurs="0"/> <element name="OEP_ZugangHuefteSchluessel" type="enum_0220" minOccurs="0"/> </sequence> </complexType> </pre> |

element **OperationEndoprotheseBasis/OEP_ArtEingriffSchluessel**

| diagram | | | | | | | | | | |
|-------------|---|--------------------------------|-------|------------|-------------|---------|--------------------------|-------------|---------|--------------------------------|
| type | enum 0200 | | | | | | | | | |
| properties | content simple | | | | | | | | | |
| facets | <table border="1"> <thead> <tr> <th>Kind</th> <th>Value</th> <th>Annotation</th> </tr> </thead> <tbody> <tr> <td>enumeration</td> <td>0200001</td> <td>documentation Erst-OP</td> </tr> <tr> <td>enumeration</td> <td>0200002</td> <td>documentation Folgeeingriff</td> </tr> </tbody> </table> | Kind | Value | Annotation | enumeration | 0200001 | documentation Erst-OP | enumeration | 0200002 | documentation Folgeeingriff |
| Kind | Value | Annotation | | | | | | | | |
| enumeration | 0200001 | documentation Erst-OP | | | | | | | | |
| enumeration | 0200002 | documentation Folgeeingriff | | | | | | | | |
| source | <pre><element name="OEP_ArtEingriffSchluessel" type="enum_0200"/></pre> | | | | | | | | | |

element **OperationEndoprotheseBasis/OEP_GelenkSchluessel**

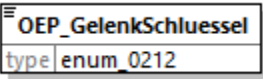
| diagram |  | | | | | | | | | | | | |
|-------------|--|--|-------|------------|-------------|---------|------------------------|-------------|---------|-----------------------|-------------|---------|--|
| type | enum_0212 | | | | | | | | | | | | |
| properties | content simple | | | | | | | | | | | | |
| facets | <table border="1"> <thead> <tr> <th>Kind</th> <th>Value</th> <th>Annotation</th> </tr> </thead> <tbody> <tr> <td>enumeration</td> <td>0212001</td> <td>documentation Hüfte</td> </tr> <tr> <td>enumeration</td> <td>0212002</td> <td>documentation Knie</td> </tr> <tr> <td>enumeration</td> <td>0212003</td> <td>documentation Totaler Femurersatz inkl. Durchsteck-Prothese</td> </tr> </tbody> </table> | Kind | Value | Annotation | enumeration | 0212001 | documentation Hüfte | enumeration | 0212002 | documentation Knie | enumeration | 0212003 | documentation Totaler Femurersatz inkl. Durchsteck-Prothese |
| Kind | Value | Annotation | | | | | | | | | | | |
| enumeration | 0212001 | documentation Hüfte | | | | | | | | | | | |
| enumeration | 0212002 | documentation Knie | | | | | | | | | | | |
| enumeration | 0212003 | documentation Totaler Femurersatz inkl. Durchsteck-Prothese | | | | | | | | | | | |
| source | <code><element name="OEP_GelenkSchluessel" type="enum_0212"/></code> | | | | | | | | | | | | |

element **OperationEndoprotheseBasis/OEP_DringlichkeitSchluessel**

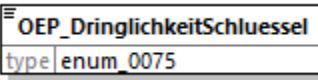
| diagram |  | | | | | | | | | | | | |
|-------------|---|----------------------------|-------|------------|-------------|---------|--------------------------|-------------|---------|----------------------------|-------------|---------|--------------------------|
| type | enum_0075 | | | | | | | | | | | | |
| properties | content simple | | | | | | | | | | | | |
| facets | <table border="1"> <thead> <tr> <th>Kind</th> <th>Value</th> <th>Annotation</th> </tr> </thead> <tbody> <tr> <td>enumeration</td> <td>0075001</td> <td>documentation elektiv</td> </tr> <tr> <td>enumeration</td> <td>0075002</td> <td>documentation dringlich</td> </tr> <tr> <td>enumeration</td> <td>0075003</td> <td>documentation Notfall</td> </tr> </tbody> </table> | Kind | Value | Annotation | enumeration | 0075001 | documentation elektiv | enumeration | 0075002 | documentation dringlich | enumeration | 0075003 | documentation Notfall |
| Kind | Value | Annotation | | | | | | | | | | | |
| enumeration | 0075001 | documentation elektiv | | | | | | | | | | | |
| enumeration | 0075002 | documentation dringlich | | | | | | | | | | | |
| enumeration | 0075003 | documentation Notfall | | | | | | | | | | | |
| source | <code><element name="OEP_DringlichkeitSchluessel" type="enum_0075"/></code> | | | | | | | | | | | | |

element **OperationEndoprotheseBasis/OEP_FrakturJNSchluessel**

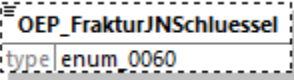
| diagram |  | | | | | | | | | |
|-------------|---|-----------------------|-------|------------|-------------|---------|---------------------|-------------|---------|-----------------------|
| type | enum_0060 | | | | | | | | | |
| properties | minOcc 0 maxOcc 1 content simple | | | | | | | | | |
| facets | <table border="1"> <thead> <tr> <th>Kind</th> <th>Value</th> <th>Annotation</th> </tr> </thead> <tbody> <tr> <td>enumeration</td> <td>0060001</td> <td>documentation ja</td> </tr> <tr> <td>enumeration</td> <td>0060002</td> <td>documentation nein</td> </tr> </tbody> </table> | Kind | Value | Annotation | enumeration | 0060001 | documentation ja | enumeration | 0060002 | documentation nein |
| Kind | Value | Annotation | | | | | | | | |
| enumeration | 0060001 | documentation ja | | | | | | | | |
| enumeration | 0060002 | documentation nein | | | | | | | | |
| source | <code><element name="OEP_FrakturJNSchluessel" type="enum_0060" minOccurs="0"/></code> | | | | | | | | | |

element **OperationEndoprotheseBasis/OEP_ZweizeitwechselSchluessel**

| diagram |  | | | | | | | | | | | | |
|-------------|--|-----------------------------|-------|------------|-------------|---------|-----------------------|-------------|---------|-----------------------------|-------------|---------|-----------------------------|
| type | enum 0222 | | | | | | | | | | | | |
| properties | minOcc 0 maxOcc 1 content simple | | | | | | | | | | | | |
| facets | <table border="1"> <thead> <tr> <th>Kind</th> <th>Value</th> <th>Annotation</th> </tr> </thead> <tbody> <tr> <td>enumeration</td> <td>0222001</td> <td>documentation nein</td> </tr> <tr> <td>enumeration</td> <td>0222002</td> <td>documentation ja- Ausbau</td> </tr> <tr> <td>enumeration</td> <td>0222003</td> <td>documentation ja- Einbau</td> </tr> </tbody> </table> | Kind | Value | Annotation | enumeration | 0222001 | documentation nein | enumeration | 0222002 | documentation ja- Ausbau | enumeration | 0222003 | documentation ja- Einbau |
| Kind | Value | Annotation | | | | | | | | | | | |
| enumeration | 0222001 | documentation nein | | | | | | | | | | | |
| enumeration | 0222002 | documentation ja- Ausbau | | | | | | | | | | | |
| enumeration | 0222003 | documentation ja- Einbau | | | | | | | | | | | |
| source | <code><element name="OEP_ZweizeitwechselSchluessel" type="enum_0222" minOccurs="0"/></code> | | | | | | | | | | | | |

element **OperationEndoprotheseBasis/OEP_GrundWechselKnieSchluessel**

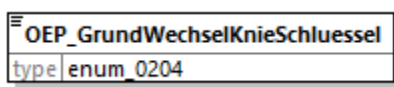
| diagram |  | | | | | | | | | | | | | | | | | | | | | | | | | | | | | | | | | | | | | | | | | | | | | | | | | | | |
|-------------|--|--|-------|------------|-------------|---------|----------------------------|-------------|---------|--|-------------|---------|---------------------------------------|-------------|---------|---|-------------|---------|-----------------------------|-------------|---------|---------------------------------|-------------|---------|---|-------------|---------|--|-------------|---------|--|-------------|---------|-----------------------|-------------|---------|--|-------------|---------|--|-------------|---------|-----------------------------------|-------------|---------|---|-------------|---------|---|-------------|---------|--------------------------------|
| type | enum 0204 | | | | | | | | | | | | | | | | | | | | | | | | | | | | | | | | | | | | | | | | | | | | | | | | | | | |
| properties | content simple | | | | | | | | | | | | | | | | | | | | | | | | | | | | | | | | | | | | | | | | | | | | | | | | | | | |
| facets | <table border="1"> <thead> <tr> <th>Kind</th> <th>Value</th> <th>Annotation</th> </tr> </thead> <tbody> <tr> <td>enumeration</td> <td>0204001</td> <td>documentation Lockerung</td> </tr> <tr> <td>enumeration</td> <td>0204002</td> <td>documentation Infektion, Verdacht auf</td> </tr> <tr> <td>enumeration</td> <td>0204003</td> <td>documentation Infektion, gesichert</td> </tr> <tr> <td>enumeration</td> <td>0204006</td> <td>documentation Periprothetische Fraktur</td> </tr> <tr> <td>enumeration</td> <td>0204007</td> <td>documentation Verschleiß</td> </tr> <tr> <td>enumeration</td> <td>0204008</td> <td>documentation Implantatbruch</td> </tr> <tr> <td>enumeration</td> <td>0204009</td> <td>documentation Implantatfehlage/Malalignent</td> </tr> <tr> <td>enumeration</td> <td>0204010</td> <td>documentation Osteolysen bei festem Implantat</td> </tr> <tr> <td>enumeration</td> <td>0204011</td> <td>documentation Progression der Grunderkrankung</td> </tr> <tr> <td>enumeration</td> <td>0204012</td> <td>documentation ARMD</td> </tr> <tr> <td>enumeration</td> <td>0204013</td> <td>documentation Verdacht auf allergische Reaktion</td> </tr> <tr> <td>enumeration</td> <td>0204014</td> <td>documentation Dislokation/Migration von Komponenten</td> </tr> <tr> <td>enumeration</td> <td>0204015</td> <td>documentation Bandinstabilität</td> </tr> <tr> <td>enumeration</td> <td>0204016</td> <td>documentation Bewegungseinschränkung</td> </tr> <tr> <td>enumeration</td> <td>0204021</td> <td>documentation Zustand nach Prothesenentfernung</td> </tr> <tr> <td>enumeration</td> <td>0204042</td> <td>documentation andere Gründe</td> </tr> </tbody> </table> | Kind | Value | Annotation | enumeration | 0204001 | documentation Lockerung | enumeration | 0204002 | documentation Infektion, Verdacht auf | enumeration | 0204003 | documentation Infektion, gesichert | enumeration | 0204006 | documentation Periprothetische Fraktur | enumeration | 0204007 | documentation Verschleiß | enumeration | 0204008 | documentation Implantatbruch | enumeration | 0204009 | documentation Implantatfehlage/Malalignent | enumeration | 0204010 | documentation Osteolysen bei festem Implantat | enumeration | 0204011 | documentation Progression der Grunderkrankung | enumeration | 0204012 | documentation ARMD | enumeration | 0204013 | documentation Verdacht auf allergische Reaktion | enumeration | 0204014 | documentation Dislokation/Migration von Komponenten | enumeration | 0204015 | documentation Bandinstabilität | enumeration | 0204016 | documentation Bewegungseinschränkung | enumeration | 0204021 | documentation Zustand nach Prothesenentfernung | enumeration | 0204042 | documentation andere Gründe |
| Kind | Value | Annotation | | | | | | | | | | | | | | | | | | | | | | | | | | | | | | | | | | | | | | | | | | | | | | | | | | |
| enumeration | 0204001 | documentation Lockerung | | | | | | | | | | | | | | | | | | | | | | | | | | | | | | | | | | | | | | | | | | | | | | | | | | |
| enumeration | 0204002 | documentation Infektion, Verdacht auf | | | | | | | | | | | | | | | | | | | | | | | | | | | | | | | | | | | | | | | | | | | | | | | | | | |
| enumeration | 0204003 | documentation Infektion, gesichert | | | | | | | | | | | | | | | | | | | | | | | | | | | | | | | | | | | | | | | | | | | | | | | | | | |
| enumeration | 0204006 | documentation Periprothetische Fraktur | | | | | | | | | | | | | | | | | | | | | | | | | | | | | | | | | | | | | | | | | | | | | | | | | | |
| enumeration | 0204007 | documentation Verschleiß | | | | | | | | | | | | | | | | | | | | | | | | | | | | | | | | | | | | | | | | | | | | | | | | | | |
| enumeration | 0204008 | documentation Implantatbruch | | | | | | | | | | | | | | | | | | | | | | | | | | | | | | | | | | | | | | | | | | | | | | | | | | |
| enumeration | 0204009 | documentation Implantatfehlage/Malalignent | | | | | | | | | | | | | | | | | | | | | | | | | | | | | | | | | | | | | | | | | | | | | | | | | | |
| enumeration | 0204010 | documentation Osteolysen bei festem Implantat | | | | | | | | | | | | | | | | | | | | | | | | | | | | | | | | | | | | | | | | | | | | | | | | | | |
| enumeration | 0204011 | documentation Progression der Grunderkrankung | | | | | | | | | | | | | | | | | | | | | | | | | | | | | | | | | | | | | | | | | | | | | | | | | | |
| enumeration | 0204012 | documentation ARMD | | | | | | | | | | | | | | | | | | | | | | | | | | | | | | | | | | | | | | | | | | | | | | | | | | |
| enumeration | 0204013 | documentation Verdacht auf allergische Reaktion | | | | | | | | | | | | | | | | | | | | | | | | | | | | | | | | | | | | | | | | | | | | | | | | | | |
| enumeration | 0204014 | documentation Dislokation/Migration von Komponenten | | | | | | | | | | | | | | | | | | | | | | | | | | | | | | | | | | | | | | | | | | | | | | | | | | |
| enumeration | 0204015 | documentation Bandinstabilität | | | | | | | | | | | | | | | | | | | | | | | | | | | | | | | | | | | | | | | | | | | | | | | | | | |
| enumeration | 0204016 | documentation Bewegungseinschränkung | | | | | | | | | | | | | | | | | | | | | | | | | | | | | | | | | | | | | | | | | | | | | | | | | | |
| enumeration | 0204021 | documentation Zustand nach Prothesenentfernung | | | | | | | | | | | | | | | | | | | | | | | | | | | | | | | | | | | | | | | | | | | | | | | | | | |
| enumeration | 0204042 | documentation andere Gründe | | | | | | | | | | | | | | | | | | | | | | | | | | | | | | | | | | | | | | | | | | | | | | | | | | |

| | |
|--------|--|
| source | <code><element name="OEP_GrundWechselKnieSchluessel" type="enum_0204"/></code> |
|--------|--|

element **OperationEndoprotheseBasis/OEP_GrundWechselHuefteSchluessel**

| | | | |
|------------|--|---------|--|
| diagram | | | |
| type | enum 0202 | | |
| properties | content simple | | |
| facets | Kind | Value | Annotation |
| | enumeration | 0202001 | documentation Lockerung |
| | enumeration | 0202002 | documentation Infektion, Verdacht auf |
| | enumeration | 0202003 | documentation Infektion, gesichert |
| | enumeration | 0202004 | documentation Luxation, Inlay aus der Pfanne |
| | enumeration | 0202005 | documentation Luxation, Kopf aus Pfanne/Inlay |
| | enumeration | 0202006 | documentation Periprothetische Fraktur |
| | enumeration | 0202007 | documentation Verschleiß des PE-Inlays |
| | enumeration | 0202008 | documentation Implantatbruch |
| | enumeration | 0202009 | documentation Implantatfehlage/Malalignent |
| | enumeration | 0202010 | documentation Osteolysen bei festem Implantat |
| | enumeration | 0202011 | documentation Progression der Grunderkrankung |
| | enumeration | 0202012 | documentation ARMD |
| | enumeration | 0202013 | documentation Verdacht auf allergische Reaktion |
| | enumeration | 0202021 | documentation Zustand nach Prothesenentfernung |
| | enumeration | 0202042 | documentation andere Gründe |
| source | <code><element name="OEP_GrundWechselHuefteSchluessel" type="enum_0202"/></code> | | |

element **OperationEndoprotheseBasis/OEP_GrundWechselTfeSchluessel**

| | | | |
|------------|---------------------------|---------|--|
| diagram | | | |
| type | enum 0206 | | |
| properties | content simple | | |
| facets | Kind | Value | Annotation |
| | enumeration | 0206001 | documentation Lockerung |
| | enumeration | 0206002 | documentation Infektion, Verdacht auf |
| | enumeration | 0206003 | documentation Infektion, gesichert |

| | | | |
|--------|---|---------|--|
| | enumeration | 0206004 | documentation Luxation, Inlay aus der Pfanne |
| | enumeration | 0206005 | documentation Luxation, Kopf aus Pfanne/Inlay |
| | enumeration | 0206006 | documentation Periprothetische Fraktur |
| | enumeration | 0206007 | documentation Verschleiß |
| | enumeration | 0206008 | documentation Implantatbruch |
| | enumeration | 0206009 | documentation Implantatfehlage/Malalignent |
| | enumeration | 0206010 | documentation Osteolysen bei festem Implantat |
| | enumeration | 0206011 | documentation Progression der Grunderkrankung |
| | enumeration | 0206012 | documentation ARMD |
| | enumeration | 0206013 | documentation Verdacht auf allergische Reaktion |
| | enumeration | 0206014 | documentation Dislokation/Migration von Komponenten |
| | enumeration | 0206015 | documentation Bandinstabilität |
| | enumeration | 0206016 | documentation Bewegungseinschränkung |
| | enumeration | 0206021 | documentation Zustand nach Prothesenentfernung |
| | enumeration | 0206042 | documentation andere Gründe |
| source | <code><element name="OEP_GrundWechselTfeSchluessel" type="enum_0206"/></code> | | |

element **OperationEndoprotheseBasis/OEP_GrundWechselErlaeuterung**

| | | | |
|------------|--|--------|------------|
| diagram | | | |
| type | Freitext250 | | |
| properties | minOcc | 0 | |
| | maxOcc | 1 | |
| | content | simple | |
| facets | Kind | Value | Annotation |
| | maxLength | 250 | |
| source | <code><element name="OEP_GrundWechselErlaeuterung" type="Freitext250" minOccurs="0"/></code> | | |

element **OperationEndoprotheseBasis/OEP_KomponenteKnieSchluessel**

| | | | |
|------------|---------------------------|---------|------------------------|
| diagram | | | |
| type | enum_0254 | | |
| properties | content | simple | |
| facets | Kind | Value | Annotation |
| | enumeration | 0254001 | documentation Femur |

| | | | |
|--------|--|---------|--------------------------|
| | enumeration | 0254002 | documentation Tibia |
| | enumeration | 0254003 | documentation Patella |
| | enumeration | 0254004 | documentation mehrere |
| source | <code><element name="OEP_KomponenteKnieSchluessel" type="enum_0254"/></code> | | |

element **OperationEndoprotheseBasis/OEP_KomponenteHuefteSchluessel**

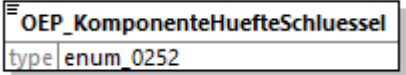
| | | | |
|------------|--|---------|-------------------------|
| diagram |  | | |
| type | enum 0252 | | |
| properties | content simple | | |
| facets | Kind | Value | Annotation |
| | enumeration | 0252001 | documentation Pfanne |
| | enumeration | 0252002 | documentation Schaft |
| | enumeration | 0252003 | documentation beides |
| source | <code><element name="OEP_KomponenteHuefteSchluessel" type="enum_0252"/></code> | | |

element **OperationEndoprotheseBasis/OEP_KomponenteTfeSchluessel**

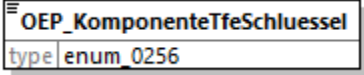
| | | | |
|------------|---|---------|------------------------------------|
| diagram |  | | |
| type | enum 0256 | | |
| properties | content simple | | |
| facets | Kind | Value | Annotation |
| | enumeration | 0256001 | documentation Pfanne |
| | enumeration | 0256002 | documentation Schaft |
| | enumeration | 0256003 | documentation Pfanne und Schaft |
| | enumeration | 0256004 | documentation Femur |
| | enumeration | 0256005 | documentation Tibia |
| | enumeration | 0256006 | documentation Patella |
| | enumeration | 0256007 | documentation mehrere |
| source | <code><element name="OEP_KomponenteTfeSchluessel" type="enum_0256"/></code> | | |

element **OperationEndoprotheseBasis/OEP_ImplantatbruchKnieSchluessel**

| | | | |
|---------|---|--|--|
| diagram |  | | |
|---------|---|--|--|

| | | | |
|------------|--|---------|-------------------------------|
| type | enum_0264 | | |
| properties | content simple | | |
| facets | Kind | Value | Annotation |
| | enumeration | 0264001 | documentation Femur |
| | enumeration | 0264002 | documentation Tibia |
| | enumeration | 0264003 | documentation Inlay |
| | enumeration | 0264004 | documentation Adapter |
| | enumeration | 0264005 | documentation Verlängerung |
| | enumeration | 0264006 | documentation Schrauben |
| | enumeration | 0264007 | documentation mehrere |
| | enumeration | 0264042 | documentation andere |
| source | <code><element name="OEP_ImplantatbruchKnieSchluessel" type="enum_0264"/></code> | | |

element **OperationEndoprotheseBasis/OEP_ImplantatbruchHuefteSchluessel**

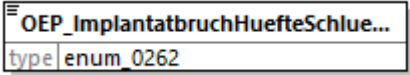
| | | | |
|------------|--|---------|--------------------------|
| diagram |  | | |
| type | enum_0262 | | |
| properties | content simple | | |
| facets | Kind | Value | Annotation |
| | enumeration | 0262001 | documentation Pfanne |
| | enumeration | 0262002 | documentation Schaft |
| | enumeration | 0262003 | documentation Kopf |
| | enumeration | 0262004 | documentation Inlay |
| | enumeration | 0262005 | documentation Adapter |
| | enumeration | 0262006 | documentation mehrere |
| source | <code><element name="OEP_ImplantatbruchHuefteSchluessel" type="enum_0262"/></code> | | |

element **OperationEndoprotheseBasis/OEP_ImplantatbruchTfeSchluessel**

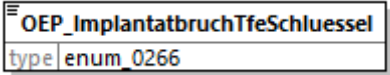
| | | | |
|------------|---|---------|-------------------------|
| diagram |  | | |
| type | enum_0266 | | |
| properties | content simple | | |
| facets | Kind | Value | Annotation |
| | enumeration | 0266001 | documentation Pfanne |
| | enumeration | 0266002 | documentation |

| | | | |
|--------|---|---------|------------------------------------|
| | enumeration | 0266003 | Schaft documentation |
| | enumeration | 0266004 | Kopf documentation |
| | enumeration | 0266005 | Inlay documentation |
| | enumeration | 0266006 | Adapter documentation |
| | enumeration | 0266007 | Femur documentation |
| | enumeration | 0266008 | Tibia documentation |
| | enumeration | 0266009 | Verlängerung documentation |
| | enumeration | 0266010 | Schrauben documentation |
| | enumeration | 0266042 | mehrere documentation andere |
| source | <code><element name="OEP_ImplantatbruchTfeSchluessel" type="enum_0266"/></code> | | |

element **OperationEndoprotheseBasis/OEP_VerschleissKnieSchluessel**

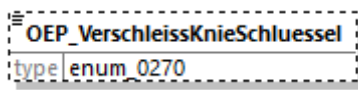
| | | | |
|------------|---|---------|---------------------------------------|
| diagram |  | | |
| type | enum 0270 | | |
| properties | minOcc 0 maxOcc 1 content simple | | |
| facets | Kind | Value | Annotation |
| | enumeration | 0270001 | documentation PE-Inlay |
| | enumeration | 0270002 | documentation patellare Komponente |
| | enumeration | 0270003 | documentation beides |
| source | <code><element name="OEP_VerschleissKnieSchluessel" type="enum_0270" minOccurs="0"/></code> | | |

element **OperationEndoprotheseBasis/OEP_MigrationKnieSchluessel**

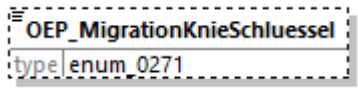
| | | | |
|------------|---|---------|---------------------------------------|
| diagram |  | | |
| type | enum 0271 | | |
| properties | minOcc 0 maxOcc 1 content simple | | |
| facets | Kind | Value | Annotation |
| | enumeration | 0271001 | documentation Schraube |
| | enumeration | 0271002 | documentation Inlay |
| | enumeration | 0271003 | documentation patellare Komponente |
| | enumeration | 0271004 | documentation Kopplung |

| | | |
|--------|---|--------------------------|
| | enumeration 0271005 | documentation mehrere |
| | enumeration 0271042 | documentation andere |
| source | <code><element name="OEP_MigrationKnieSchluessel" type="enum_0271" minOccurs="0"/></code> | |

element **OperationEndoprotheseBasis/OEP_ZugangHuefteSchluessel**

| | | | |
|------------|--|---------|--------------------------------------|
| diagram | | | |
| type | enum 0220 | | |
| properties | minOcc | 0 | |
| | maxOcc | 1 | |
| | content | simple | |
| facets | Kind | Value | Annotation |
| | enumeration | 0220001 | documentation anterior |
| | enumeration | 0220002 | documentation anterolateral |
| | enumeration | 0220003 | documentation lateral |
| | enumeration | 0220004 | documentation posterior |
| | enumeration | 0220005 | documentation posterolateral |
| | enumeration | 0220006 | documentation 2-Inzisionen-Zugang |
| | enumeration | 0220042 | documentation sonstiges/unbekannt |
| source | <code><element name="OEP_ZugangHuefteSchluessel" type="enum_0220" minOccurs="0"/></code> | | |

complexType **VorbehandlungEndoprotheseBasis**

| | | | |
|-----------|---|---|--|
| diagram | | | |
| namespace | http://xml.ir-d.de/emg | | |
| children | VEP_VorOpKnieSchluessel VEP_VorOpHuefteSchluessel VEP_VorOpErlaeuterung | | |
| used by | element | OperationEndoprothese/vorbehandlungEndoprothese | |
| source | <pre> <complexType name="VorbehandlungEndoprotheseBasis"> <sequence> <choice minOccurs="0"> <element name="VEP_VorOpKnieSchluessel" type="enum_0211"/> <element name="VEP_VorOpHuefteSchluessel" type="enum_0210"/> </choice> <element name="VEP_VorOpErlaeuterung" type="Freitext250" minOccurs="0"/> </sequence> </pre> | | |

```

</sequence>
</complexType>

```

element **VorbehandlungEndoprotheseBasis/VEP_VorOpKnieSchluessel**

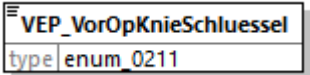
| | | | |
|------------|---|---------|---|
| diagram |  | | |
| type | enum 0211 | | |
| properties | content simple | | |
| facets | Kind | Value | Annotation |
| | enumeration | 0211001 | documentation keine relevante Voroperation |
| | enumeration | 0211002 | documentation Osteosynthese/Osteotomie (Femur) |
| | enumeration | 0211003 | documentation Osteosynthese/Osteotomie (Tibia) |
| | enumeration | 0211004 | documentation Osteosynthese/Osteotomie (Patella) |
| | enumeration | 0211005 | documentation Osteosynthese/Osteotomie (mehrere) |
| | enumeration | 0211006 | documentation Kapsel-/Bandapparat |
| | enumeration | 0211007 | documentation Arthrodese |
| | enumeration | 0211042 | documentation andere |
| source | <code><element name="VEP_VorOpKnieSchluessel" type="enum_0211"/></code> | | |

element **VorbehandlungEndoprotheseBasis/VEP_VorOpHuefteSchluessel**

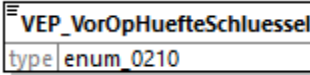
| | | | |
|------------|---|---------|--|
| diagram |  | | |
| type | enum 0210 | | |
| properties | content simple | | |
| facets | Kind | Value | Annotation |
| | enumeration | 0210001 | documentation keine relevante Voroperation |
| | enumeration | 0210002 | documentation Osteosynthese/Osteotomie (Becken) |
| | enumeration | 0210003 | documentation Osteosynthese/Osteotomie (Femur) |
| | enumeration | 0210004 | documentation Osteosynthese/Osteotomie (beides) |
| | enumeration | 0210005 | documentation Operation bei Hüftkopfnekrose |
| | enumeration | 0210006 | documentation Arthrodese |
| | enumeration | 0210042 | documentation andere |
| source | <code><element name="VEP_VorOpHuefteSchluessel" type="enum_0210"/></code> | | |

element **VorbehandlungEndoprotheseBasis/VEP_VorOpErlaeuterung**

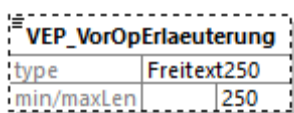
| | |
|------------|---|
| diagram |  |
| type | Freitext250 |
| properties | minOcc 0 maxOcc 1 content simple |
| facets | Kind Value Annotation maxLength 250 |
| source | <code><element name="VEP_VorOpErlaeuterung" type="Freitext250" minOccurs="0"/></code> |

complexType **ProzedurenSchluesselEndoprotheseBasis**

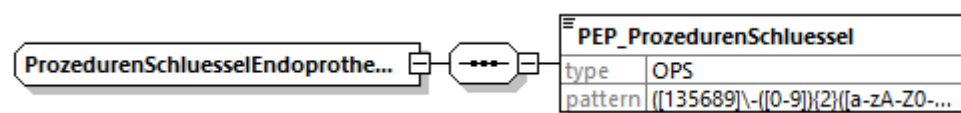
| | |
|-----------|---|
| diagram |  |
| namespace | http://xml.ir-d.de/emg |
| children | PEP_ProzedurenSchluessel |
| used by | element OperationEndoprothese/prozedurenSchluesselEndoprothese |
| source | <code><complexType name="ProzedurenSchluesselEndoprotheseBasis"> <sequence> <element name="PEP_ProzedurenSchluessel" type="OPS"/> </sequence> </complexType></code> |

element **ProzedurenSchluesselEndoprotheseBasis/PEP_ProzedurenSchluessel**

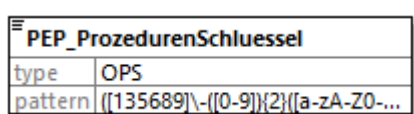
| | |
|------------|--|
| diagram |  |
| type | OPS |
| properties | content simple |
| facets | Kind Value Annotation pattern (([135689]\-([0-9]){2})([a-zA-Z0-9]){1}\.([a-zA-Z0-9]{1,2}))*(:[RLBrlb])? |
| source | <code><element name="PEP_ProzedurenSchluessel" type="OPS"/></code> |

| | |
|---------|--|
| | <p> OAK ZugangKatheterSchluessel OAK KomplikationenSchluessel OAK TherapieLcoSchluessel OAK Durchleuchtungszeit OAK BeatmungSchluessel OAK TroponinSchluessel OAK InotropeSchluessel OAK Eingriffsdauer OAK EingriffsumfangSchluessel OAK ProzedurenAnzahl OAK VorgehenSchluessel OAK Bypasszeit OAK BypasszeitUnbekannt OAK Abklemmzeit OAK AbklemmzeitUnbekannt OAK AortaThorakalSchluessel OAK NeuroprotektionSchluessel OAK KreislaufunterstuetzungSchluessel OAK PraeOpUnterstuetzungSchluessel OAK PraeOpMethodeSchluessel OAK IntraOpUnterstuetzungSchluessel OAK IntraOpMethodeSchluessel OAK AortenklappenOpAnzahl OAK ValvelnValveSchluessel OAK ZugangsGefaessdiameter OAK ZugangsGefaessUnbekannt OAK ZugangVerkalkungSchluessel OAK Aortenklappenannulus OAK MessmethodeSchluessel OAK DistanzRca OAK DistanzRcaUnbekannt OAK DistanzLca OAK DistanzLcaUnbekannt OAK PtcaVorSchluessel OAK PtcaVorDurchmesser OAK PtcaVorDurchmesserUnbekannt OAK PtcaVorAnzahl OAK RapidPacingVorSchluessel OAK RapidPacingIntraSchluessel OAK PtcaNachSchluessel OAK PtcaNachDurchmesser OAK PtcaNachDurchmesserUnbekannt OAK PtcaNachAnzahl OAK RapidPacingNachSchluessel OAK KonversionSchluessel OAK SuccessSchluessel OAK AnaesthesieSchluessel OAK DeltaPmeanNachOp OAK DeltaPmeanNachOpUnbekannt OAK ResidualeinsuffizienzSchluessel OAK ZugangVerschlussSchluessel OAK ZusaetzlichePciSchluessel OAK PciWegenKhkSchluessel OAK PciWegenKomplikationSchluessel OAK LaesionenAnzahl </p> |
| used by | <p>complexType OperationAortenklappe</p> |
| source | <pre> <complexType name="OperationAortenklappeBasis"> <sequence> <element name="OAK_NummerEingriff" type="Zahl2"/> <element name="OAK_ArtEingriffSchluessel" type="enum_0300"/> <element name="OAK_GrundEingriffSchluessel" type="enum_0302"/> <element name="OAK_DringlichkeitSchluessel" type="enum_0076"/> <element name="OAK_ExplantationSchluessel" type="enum_0060" minOccurs="0"/> <element name="OAK_IsoliertSchluessel" type="enum_0060"/> <choice> <element name="OAK_ZugangKonventionellSchluessel" type="enum_0320"/> <element name="OAK_ZugangKatheterSchluessel" type="enum_0318"/> </choice> <element name="OAK_KomplikationenSchluessel" type="enum_0060"/> <element name="OAK_TherapieLcoSchluessel" type="enum_0346" minOccurs="0"/> <element name="OAK_Durchleuchtungszeit" type="Zahl3_1" minOccurs="0"/> <element name="OAK_BeatmungSchluessel" type="enum_0060"/> <element name="OAK_TroponinSchluessel" type="enum_0060"/> <element name="OAK_InotropeSchluessel" type="enum_0060"/> <element name="OAK_Eingriffsdauer" type="Zahl3"/> <element name="OAK_EingriffsumfangSchluessel" type="enum_0347"/> <element name="OAK_ProzedurenAnzahl" type="Zahl1" minOccurs="0"/> <element name="OAK_VorgehenSchluessel" type="enum_0348"/> <choice minOccurs="0"> <element name="OAK_Bypasszeit" type="Zahl3"/> <element name="OAK_BypasszeitUnbekannt" type="JaLeer"/> </choice> <choice minOccurs="0"> <element name="OAK_Abklemmzeit" type="Zahl3"/> <element name="OAK_AbklemmzeitUnbekannt" type="JaLeer"/> </choice> <element name="OAK_AortaThorakalSchluessel" type="enum_0060"/> <element name="OAK_NeuroprotektionSchluessel" type="enum_0060"/> <element name="OAK_KreislaufunterstuetzungSchluessel" type="enum_0060"/> <element name="OAK_PraeOpUnterstuetzungSchluessel" type="enum_0060" minOccurs="0"/> <element name="OAK_PraeOpMethodeSchluessel" type="enum_0350" minOccurs="0"/> <element name="OAK_IntraOpUnterstuetzungSchluessel" type="enum_0060" minOccurs="0"/> <element name="OAK_IntraOpMethodeSchluessel" type="enum_0350" </pre> |

```

minOccurs="0"/>
  <element name="OAK_AortenklappenOpAnzahl" type="Zahl2"/>
  <element name="OAK_ValveInValveSchluessel" type="enum_0060"
minOccurs="0"/>
  <choice minOccurs="0">
    <element name="OAK_ZugangsGefaessdiameter" type="Zahl1_1"/>
    <element name="OAK_ZugangsGefaessUnbekannt" type="JaLeer"/>
  </choice>
  <element name="OAK_ZugangVerkalkungSchluessel" type="enum_0061"
minOccurs="0"/>
  <element name="OAK_Aortenklappenannulus" type="Zahl3" minOccurs="0"/>
  <element name="OAK_MessmethodeSchluessel" type="enum_0339" minOccurs="0"/>
  <choice minOccurs="0">
    <element name="OAK_DistanzRca" type="Zahl3"/>
    <element name="OAK_DistanzRcaUnbekannt" type="JaLeer"/>
  </choice>
  <choice minOccurs="0">
    <element name="OAK_DistanzLca" type="Zahl3"/>
    <element name="OAK_DistanzLcaUnbekannt" type="JaLeer"/>
  </choice>
  <element name="OAK_PtcaVorSchluessel" type="enum_0060" minOccurs="0"/>
  <choice minOccurs="0">
    <element name="OAK_PtcaVorDurchmesser" type="Zahl2"/>
    <element name="OAK_PtcaVorDurchmesserUnbekannt" type="JaLeer"/>
  </choice>
  <element name="OAK_PtcaVorAnzahl" type="Zahl2" minOccurs="0"/>
  <element name="OAK_RapidPacingVorSchluessel" type="enum_0060"
minOccurs="0"/>
  <element name="OAK_RapidPacingIntraSchluessel" type="enum_0060"
minOccurs="0"/>
  <element name="OAK_PtcaNachSchluessel" type="enum_0060" minOccurs="0"/>
  <choice minOccurs="0">
    <element name="OAK_PtcaNachDurchmesser" type="Zahl2"/>
    <element name="OAK_PtcaNachDurchmesserUnbekannt" type="JaLeer"/>
  </choice>
  <element name="OAK_PtcaNachAnzahl" type="Zahl2" minOccurs="0"/>
  <element name="OAK_RapidPacingNachSchluessel" type="enum_0060"
minOccurs="0"/>
  <element name="OAK_KonversionSchluessel" type="enum_0351" minOccurs="0"/>
  <element name="OAK_SuccessSchluessel" type="enum_0060" minOccurs="0"/>
  <element name="OAK_AnaesthesieSchluessel" type="enum_0352" minOccurs="0"/>
  <choice minOccurs="0">
    <element name="OAK_DeltaPmeanNachOp" type="Zahl3"/>
    <element name="OAK_DeltaPmeanNachOpUnbekannt" type="JaLeer"/>
  </choice>
  <element name="OAK_ResidualeInsuffizienzSchluessel" type="enum_0353"
minOccurs="0"/>
  <element name="OAK_ZugangVerschlussSchluessel" type="enum_0354"
minOccurs="0"/>
  <element name="OAK_ZusaetzlichePciSchluessel" type="enum_0060"
minOccurs="0"/>
  <element name="OAK_PciWegenKhkSchluessel" type="enum_0060" minOccurs="0"/>
  <element name="OAK_PciWegenKomplikationSchluessel" type="enum_0060"
minOccurs="0"/>
  <element name="OAK_LaesionenAnzahl" type="Zahl1" minOccurs="0"/>
</sequence>
</complexType>

```

element **OperationAortenklappeBasis/OAK_NummerEingriff**

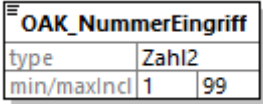
| diagram |  | | | | | | | | | |
|--------------|--|------------|-------|------------|--------------|---|--|--------------|----|--|
| type | Zahl2 | | | | | | | | | |
| properties | content simple | | | | | | | | | |
| facets | <table border="1"> <thead> <tr> <th>Kind</th> <th>Value</th> <th>Annotation</th> </tr> </thead> <tbody> <tr> <td>minInclusive</td> <td>1</td> <td></td> </tr> <tr> <td>maxInclusive</td> <td>99</td> <td></td> </tr> </tbody> </table> | Kind | Value | Annotation | minInclusive | 1 | | maxInclusive | 99 | |
| Kind | Value | Annotation | | | | | | | | |
| minInclusive | 1 | | | | | | | | | |
| maxInclusive | 99 | | | | | | | | | |
| source | <code><element name="OAK_NummerEingriff" type="Zahl2"/></code> | | | | | | | | | |

element **OperationAortenklappeBasis/OAK_ArtEingriffSchluessel**

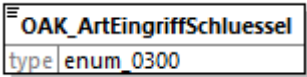
| diagram |  | | | | | | | | | |
|-------------|--|---|-------|------------|-------------|---------|--|-------------|---------|---|
| type | enum_0300 | | | | | | | | | |
| properties | content simple | | | | | | | | | |
| facets | <table border="1"> <thead> <tr> <th>Kind</th> <th>Value</th> <th>Annotation</th> </tr> </thead> <tbody> <tr> <td>enumeration</td> <td>0300001</td> <td>documentation konventioneller Aortenklappenersatz</td> </tr> <tr> <td>enumeration</td> <td>0300002</td> <td>documentation kathetergestützte Aortenklappenimplantation (TAVI)</td> </tr> </tbody> </table> | Kind | Value | Annotation | enumeration | 0300001 | documentation konventioneller Aortenklappenersatz | enumeration | 0300002 | documentation kathetergestützte Aortenklappenimplantation (TAVI) |
| Kind | Value | Annotation | | | | | | | | |
| enumeration | 0300001 | documentation konventioneller Aortenklappenersatz | | | | | | | | |
| enumeration | 0300002 | documentation kathetergestützte Aortenklappenimplantation (TAVI) | | | | | | | | |
| source | <code><element name="OAK_ArtEingriffSchluessel" type="enum_0300"/></code> | | | | | | | | | |

element **OperationAortenklappeBasis/OAK_GrundEingriffSchluessel**

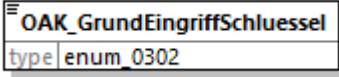
| diagram |  | | | | | | | | | | | | |
|-------------|---|---|-------|------------|-------------|---------|--------------------------|-------------|---------|-------------------------------|-------------|---------|---|
| type | enum_0302 | | | | | | | | | | | | |
| properties | content simple | | | | | | | | | | | | |
| facets | <table border="1"> <thead> <tr> <th>Kind</th> <th>Value</th> <th>Annotation</th> </tr> </thead> <tbody> <tr> <td>enumeration</td> <td>0302001</td> <td>documentation Stenose</td> </tr> <tr> <td>enumeration</td> <td>0302002</td> <td>documentation Insuffizienz</td> </tr> <tr> <td>enumeration</td> <td>0302003</td> <td>documentation Stenose und Insuffizienz</td> </tr> </tbody> </table> | Kind | Value | Annotation | enumeration | 0302001 | documentation Stenose | enumeration | 0302002 | documentation Insuffizienz | enumeration | 0302003 | documentation Stenose und Insuffizienz |
| Kind | Value | Annotation | | | | | | | | | | | |
| enumeration | 0302001 | documentation Stenose | | | | | | | | | | | |
| enumeration | 0302002 | documentation Insuffizienz | | | | | | | | | | | |
| enumeration | 0302003 | documentation Stenose und Insuffizienz | | | | | | | | | | | |
| source | <code><element name="OAK_GrundEingriffSchluessel" type="enum_0302"/></code> | | | | | | | | | | | | |

element **OperationAortenklappeBasis/OAK_DringlichkeitSchluessel**

| | |
|---------|---|
| diagram |  |
|---------|---|

| type | enum_0076 | | | | | | | | | | | | | | | |
|-------------|--|---|-------|------------|-------------|---------|--------------------------|-------------|---------|----------------------------|-------------|---------|--------------------------|-------------|---------|---|
| properties | content simple | | | | | | | | | | | | | | | |
| facets | <table border="1"> <thead> <tr> <th>Kind</th> <th>Value</th> <th>Annotation</th> </tr> </thead> <tbody> <tr> <td>enumeration</td> <td>0076001</td> <td>documentation elektiv</td> </tr> <tr> <td>enumeration</td> <td>0076002</td> <td>documentation dringlich</td> </tr> <tr> <td>enumeration</td> <td>0076003</td> <td>documentation Notfall</td> </tr> <tr> <td>enumeration</td> <td>0076004</td> <td>documentation Notfall (Reanimation / ultima ratio)</td> </tr> </tbody> </table> | Kind | Value | Annotation | enumeration | 0076001 | documentation elektiv | enumeration | 0076002 | documentation dringlich | enumeration | 0076003 | documentation Notfall | enumeration | 0076004 | documentation Notfall (Reanimation / ultima ratio) |
| Kind | Value | Annotation | | | | | | | | | | | | | | |
| enumeration | 0076001 | documentation elektiv | | | | | | | | | | | | | | |
| enumeration | 0076002 | documentation dringlich | | | | | | | | | | | | | | |
| enumeration | 0076003 | documentation Notfall | | | | | | | | | | | | | | |
| enumeration | 0076004 | documentation Notfall (Reanimation / ultima ratio) | | | | | | | | | | | | | | |
| source | <code><element name="OAK_DringlichkeitSchluessel" type="enum_0076"/></code> | | | | | | | | | | | | | | | |

element OperationAortenklappeBasis/OAK_ExplantationSchluessel

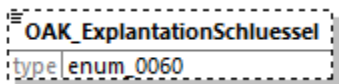
| diagram |  | | | | | | | | | |
|-------------|---|-----------------------|-------|------------|-------------|---------|---------------------|-------------|---------|-----------------------|
| type | enum_0060 | | | | | | | | | |
| properties | minOcc 0 maxOcc 1 content simple | | | | | | | | | |
| facets | <table border="1"> <thead> <tr> <th>Kind</th> <th>Value</th> <th>Annotation</th> </tr> </thead> <tbody> <tr> <td>enumeration</td> <td>0060001</td> <td>documentation ja</td> </tr> <tr> <td>enumeration</td> <td>0060002</td> <td>documentation nein</td> </tr> </tbody> </table> | Kind | Value | Annotation | enumeration | 0060001 | documentation ja | enumeration | 0060002 | documentation nein |
| Kind | Value | Annotation | | | | | | | | |
| enumeration | 0060001 | documentation ja | | | | | | | | |
| enumeration | 0060002 | documentation nein | | | | | | | | |
| source | <code><element name="OAK_ExplantationSchluessel" type="enum_0060" minOccurs="0"/></code> | | | | | | | | | |

element OperationAortenklappeBasis/OAK_IsoliertSchluessel

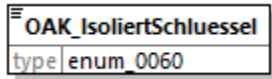
| diagram |  | | | | | | | | | |
|-------------|---|-----------------------|-------|------------|-------------|---------|---------------------|-------------|---------|-----------------------|
| type | enum_0060 | | | | | | | | | |
| properties | content simple | | | | | | | | | |
| facets | <table border="1"> <thead> <tr> <th>Kind</th> <th>Value</th> <th>Annotation</th> </tr> </thead> <tbody> <tr> <td>enumeration</td> <td>0060001</td> <td>documentation ja</td> </tr> <tr> <td>enumeration</td> <td>0060002</td> <td>documentation nein</td> </tr> </tbody> </table> | Kind | Value | Annotation | enumeration | 0060001 | documentation ja | enumeration | 0060002 | documentation nein |
| Kind | Value | Annotation | | | | | | | | |
| enumeration | 0060001 | documentation ja | | | | | | | | |
| enumeration | 0060002 | documentation nein | | | | | | | | |
| source | <code><element name="OAK_IsoliertSchluessel" type="enum_0060"/></code> | | | | | | | | | |

element OperationAortenklappeBasis/OAK_ZugangKonventionellSchluessel

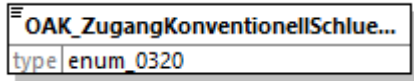
| | |
|------------|---|
| diagram |  |
| type | enum_0320 |
| properties | content simple |

| | | | |
|--------|---|------------------|---|
| facets | Kind enumeration | Value 0320001 | Annotation documentation konventionelle Sternotomie |
| | enumeration | 0320002 | documentation partielle Sternotomie |
| | enumeration | 0320003 | documentation parasternaler Zugang |
| | enumeration | 0320042 | documentation anderer Zugangsweg |
| source | <code><element name="OAK_ZugangKonventionellSchluessel" type="enum_0320"/></code> | | |

element **OperationAortenklappeBasis/OAK_ZugangKatheterSchluessel**

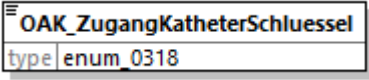
| | | | |
|------------|--|------------------|--|
| diagram |  | | |
| type | enum 0318 | | |
| properties | content simple | | |
| facets | Kind enumeration | Value 0318001 | Annotation documentation transapikal |
| | enumeration | 0318002 | documentation transaortal |
| | enumeration | 0318003 | documentation transfemoral |
| | enumeration | 0318004 | documentation transaxillär |
| | enumeration | 0318042 | documentation anderer Zugangsweg |
| source | <code><element name="OAK_ZugangKatheterSchluessel" type="enum_0318"/></code> | | |

element **OperationAortenklappeBasis/OAK_KomplikationenSchluessel**

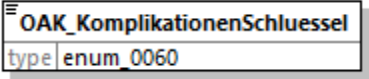
| | | | |
|------------|---|------------------|-----------------------------------|
| diagram |  | | |
| type | enum 0060 | | |
| properties | content simple | | |
| facets | Kind enumeration | Value 0060001 | Annotation documentation ja |
| | enumeration | 0060002 | documentation nein |
| source | <code><element name="OAK_KomplikationenSchluessel" type="enum_0060"/></code> | | |

element **OperationAortenklappeBasis/OAK_TherapieLcoSchluessel**

| | | | |
|---------|---|--|--|
| diagram |  | | |
| type | enum 0346 | | |

| properties | minOcc 0 maxOcc 1 content simple | | | | | | | | | | | | | | | | | | | | | |
|-------------|---|--|-------|------------|-------------|---------|--|-------------|---------|-------------------------------|-------------|---------|-----------------------|-------------|---------|----------------------|-------------|---------|-----------------------|-------------|---------|---------------------------|
| facets | <table border="1"> <thead> <tr> <th>Kind</th> <th>Value</th> <th>Annotation</th> </tr> </thead> <tbody> <tr> <td>enumeration</td> <td>0346001</td> <td>documentation keine Therapie erforderlich</td> </tr> <tr> <td>enumeration</td> <td>0346002</td> <td>documentation medikamentös</td> </tr> <tr> <td>enumeration</td> <td>0346003</td> <td>documentation IABP</td> </tr> <tr> <td>enumeration</td> <td>0346004</td> <td>documentation VAD</td> </tr> <tr> <td>enumeration</td> <td>0346005</td> <td>documentation ECMO</td> </tr> <tr> <td>enumeration</td> <td>0346042</td> <td>documentation sonstige</td> </tr> </tbody> </table> | Kind | Value | Annotation | enumeration | 0346001 | documentation keine Therapie erforderlich | enumeration | 0346002 | documentation medikamentös | enumeration | 0346003 | documentation IABP | enumeration | 0346004 | documentation VAD | enumeration | 0346005 | documentation ECMO | enumeration | 0346042 | documentation sonstige |
| Kind | Value | Annotation | | | | | | | | | | | | | | | | | | | | |
| enumeration | 0346001 | documentation keine Therapie erforderlich | | | | | | | | | | | | | | | | | | | | |
| enumeration | 0346002 | documentation medikamentös | | | | | | | | | | | | | | | | | | | | |
| enumeration | 0346003 | documentation IABP | | | | | | | | | | | | | | | | | | | | |
| enumeration | 0346004 | documentation VAD | | | | | | | | | | | | | | | | | | | | |
| enumeration | 0346005 | documentation ECMO | | | | | | | | | | | | | | | | | | | | |
| enumeration | 0346042 | documentation sonstige | | | | | | | | | | | | | | | | | | | | |
| source | <code><element name="OAK_TherapieLcoSchluessel" type="enum_0346" minOccurs="0"/></code> | | | | | | | | | | | | | | | | | | | | | |

element **OperationAortenklappeBasis/OAK_Durchleuchtungszeit**

| diagram | | | | | | | | | | | | | | | | |
|----------------|--|------------|-------|------------|--------------|-----|--|--------------|-------|--|-------------|---|--|----------------|---|--|
| type | Zahl3_1 | | | | | | | | | | | | | | | |
| properties | minOcc 0 maxOcc 1 content simple | | | | | | | | | | | | | | | |
| facets | <table border="1"> <thead> <tr> <th>Kind</th> <th>Value</th> <th>Annotation</th> </tr> </thead> <tbody> <tr> <td>minInclusive</td> <td>0.1</td> <td></td> </tr> <tr> <td>maxInclusive</td> <td>999.9</td> <td></td> </tr> <tr> <td>totalDigits</td> <td>4</td> <td></td> </tr> <tr> <td>fractionDigits</td> <td>1</td> <td></td> </tr> </tbody> </table> | Kind | Value | Annotation | minInclusive | 0.1 | | maxInclusive | 999.9 | | totalDigits | 4 | | fractionDigits | 1 | |
| Kind | Value | Annotation | | | | | | | | | | | | | | |
| minInclusive | 0.1 | | | | | | | | | | | | | | | |
| maxInclusive | 999.9 | | | | | | | | | | | | | | | |
| totalDigits | 4 | | | | | | | | | | | | | | | |
| fractionDigits | 1 | | | | | | | | | | | | | | | |
| source | <code><element name="OAK_Durchleuchtungszeit" type="Zahl3_1" minOccurs="0"/></code> | | | | | | | | | | | | | | | |

element **OperationAortenklappeBasis/OAK_BeatmungSchluessel**

| diagram | | | | | | | | | | |
|-------------|---|-----------------------|-------|------------|-------------|---------|---------------------|-------------|---------|-----------------------|
| type | enum_0060 | | | | | | | | | |
| properties | content simple | | | | | | | | | |
| facets | <table border="1"> <thead> <tr> <th>Kind</th> <th>Value</th> <th>Annotation</th> </tr> </thead> <tbody> <tr> <td>enumeration</td> <td>0060001</td> <td>documentation ja</td> </tr> <tr> <td>enumeration</td> <td>0060002</td> <td>documentation nein</td> </tr> </tbody> </table> | Kind | Value | Annotation | enumeration | 0060001 | documentation ja | enumeration | 0060002 | documentation nein |
| Kind | Value | Annotation | | | | | | | | |
| enumeration | 0060001 | documentation ja | | | | | | | | |
| enumeration | 0060002 | documentation nein | | | | | | | | |
| source | <code><element name="OAK_BeatmungSchluessel" type="enum_0060"/></code> | | | | | | | | | |

element **OperationAortenklappeBasis/OAK_TroponinSchluessel**

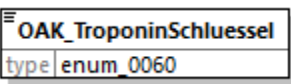
| diagram |  | | | | | | | | | |
|-------------|---|-----------------------|-------|------------|-------------|---------|---------------------|-------------|---------|-----------------------|
| type | enum_0060 | | | | | | | | | |
| properties | content simple | | | | | | | | | |
| facets | <table border="1"> <thead> <tr> <th>Kind</th> <th>Value</th> <th>Annotation</th> </tr> </thead> <tbody> <tr> <td>enumeration</td> <td>0060001</td> <td>documentation ja</td> </tr> <tr> <td>enumeration</td> <td>0060002</td> <td>documentation nein</td> </tr> </tbody> </table> | Kind | Value | Annotation | enumeration | 0060001 | documentation ja | enumeration | 0060002 | documentation nein |
| Kind | Value | Annotation | | | | | | | | |
| enumeration | 0060001 | documentation ja | | | | | | | | |
| enumeration | 0060002 | documentation nein | | | | | | | | |
| source | <code><element name="OAK_TroponinSchluessel" type="enum_0060"/></code> | | | | | | | | | |

element **OperationAortenklappeBasis/OAK_InotropeSchluessel**

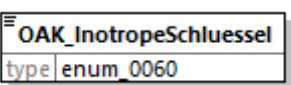
| diagram |  | | | | | | | | | |
|-------------|---|-----------------------|-------|------------|-------------|---------|---------------------|-------------|---------|-----------------------|
| type | enum_0060 | | | | | | | | | |
| properties | content simple | | | | | | | | | |
| facets | <table border="1"> <thead> <tr> <th>Kind</th> <th>Value</th> <th>Annotation</th> </tr> </thead> <tbody> <tr> <td>enumeration</td> <td>0060001</td> <td>documentation ja</td> </tr> <tr> <td>enumeration</td> <td>0060002</td> <td>documentation nein</td> </tr> </tbody> </table> | Kind | Value | Annotation | enumeration | 0060001 | documentation ja | enumeration | 0060002 | documentation nein |
| Kind | Value | Annotation | | | | | | | | |
| enumeration | 0060001 | documentation ja | | | | | | | | |
| enumeration | 0060002 | documentation nein | | | | | | | | |
| source | <code><element name="OAK_InotropeSchluessel" type="enum_0060"/></code> | | | | | | | | | |

element **OperationAortenklappeBasis/OAK_Eingriffsdauer**

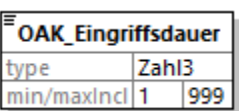
| diagram |  | | | | | | | | | |
|--------------|---|------------|-------|------------|--------------|---|--|--------------|-----|--|
| type | Zahl3 | | | | | | | | | |
| properties | content simple | | | | | | | | | |
| facets | <table border="1"> <thead> <tr> <th>Kind</th> <th>Value</th> <th>Annotation</th> </tr> </thead> <tbody> <tr> <td>minInclusive</td> <td>1</td> <td></td> </tr> <tr> <td>maxInclusive</td> <td>999</td> <td></td> </tr> </tbody> </table> | Kind | Value | Annotation | minInclusive | 1 | | maxInclusive | 999 | |
| Kind | Value | Annotation | | | | | | | | |
| minInclusive | 1 | | | | | | | | | |
| maxInclusive | 999 | | | | | | | | | |
| source | <code><element name="OAK_Eingriffsdauer" type="Zahl3"/></code> | | | | | | | | | |

element **OperationAortenklappeBasis/OAK_EingriffsumfangSchluessel**

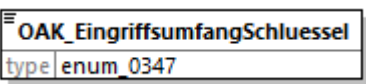
| | |
|------------|---|
| diagram |  |
| type | enum_0347 |
| properties | content simple |

| | | | |
|--------|---|---------|---|
| facets | Kind | Value | Annotation |
| | enumeration | 0347001 | documentation Einzeleingriff |
| | enumeration | 0347002 | documentation Kombinationseingriff mit mehreren Prozeduren |
| source | <code><element name="OAK_EingriffsumfangSchluessel" type="enum_0347"/></code> | | |

element **OperationAortenklappeBasis/OAK_ProzedurenAnzahl**

| | | | |
|------------|--|-------|------------|
| diagram | | | |
| type | Zahl1 | | |
| properties | minOcc 0 maxOcc 1 content simple | | |
| facets | Kind | Value | Annotation |
| | minInclusive | 1 | |
| | maxInclusive | 9 | |
| source | <code><element name="OAK_ProzedurenAnzahl" type="Zahl1" minOccurs="0"/></code> | | |

element **OperationAortenklappeBasis/OAK_VorgehenSchluessel**

| | | | |
|------------|--|---------|---|
| diagram | | | |
| type | enum_0348 | | |
| properties | content simple | | |
| facets | Kind | Value | Annotation |
| | enumeration | 0348001 | documentation mit HLM |
| | enumeration | 0348002 | documentation ohne HLM |
| | enumeration | 0348003 | documentation Umstieg von OP ohne HLM auf OP mit HLM |
| source | <code><element name="OAK_VorgehenSchluessel" type="enum_0348"/></code> | | |

element **OperationAortenklappeBasis/OAK_Bypasszeit**

| | | | |
|------------|--|-------|------------|
| diagram | | | |
| type | Zahl3 | | |
| properties | content simple | | |
| facets | Kind | Value | Annotation |
| | minInclusive | 1 | |
| | maxInclusive | 999 | |
| source | <code><element name="OAK_Bypasszeit" type="Zahl3"/></code> | | |

element **OperationAortenklappeBasis/OAK_BypasszeitUnbekannt**

| diagram | | | | | | | |
|------------|--|------------|-------|------------|---------|-----|--|
| type | JaLeer | | | | | | |
| properties | content simple | | | | | | |
| facets | <table border="1"> <thead> <tr> <th>Kind</th> <th>Value</th> <th>Annotation</th> </tr> </thead> <tbody> <tr> <td>pattern</td> <td>(1)</td> <td></td> </tr> </tbody> </table> | Kind | Value | Annotation | pattern | (1) | |
| Kind | Value | Annotation | | | | | |
| pattern | (1) | | | | | | |
| source | <code><element name="OAK_BypasszeitUnbekannt" type="JaLeer"/></code> | | | | | | |

element **OperationAortenklappeBasis/OAK_Abklemmzeit**

| diagram | | | | | | | | | | |
|--------------|---|------------|-------|------------|--------------|---|--|--------------|-----|--|
| type | Zahl3 | | | | | | | | | |
| properties | content simple | | | | | | | | | |
| facets | <table border="1"> <thead> <tr> <th>Kind</th> <th>Value</th> <th>Annotation</th> </tr> </thead> <tbody> <tr> <td>minInclusive</td> <td>1</td> <td></td> </tr> <tr> <td>maxInclusive</td> <td>999</td> <td></td> </tr> </tbody> </table> | Kind | Value | Annotation | minInclusive | 1 | | maxInclusive | 999 | |
| Kind | Value | Annotation | | | | | | | | |
| minInclusive | 1 | | | | | | | | | |
| maxInclusive | 999 | | | | | | | | | |
| source | <code><element name="OAK_Abklemmzeit" type="Zahl3"/></code> | | | | | | | | | |

element **OperationAortenklappeBasis/OAK_AbklemmzeitUnbekannt**

| diagram | | | | | | | |
|------------|--|------------|-------|------------|---------|-----|--|
| type | JaLeer | | | | | | |
| properties | content simple | | | | | | |
| facets | <table border="1"> <thead> <tr> <th>Kind</th> <th>Value</th> <th>Annotation</th> </tr> </thead> <tbody> <tr> <td>pattern</td> <td>(1)</td> <td></td> </tr> </tbody> </table> | Kind | Value | Annotation | pattern | (1) | |
| Kind | Value | Annotation | | | | | |
| pattern | (1) | | | | | | |
| source | <code><element name="OAK_AbklemmzeitUnbekannt" type="JaLeer"/></code> | | | | | | |

element **OperationAortenklappeBasis/OAK_AortaThorakalSchluessel**

| diagram | | | | | | | |
|-------------|---|---------------|-------|------------|-------------|---------|---------------|
| type | enum_0060 | | | | | | |
| properties | content simple | | | | | | |
| facets | <table border="1"> <thead> <tr> <th>Kind</th> <th>Value</th> <th>Annotation</th> </tr> </thead> <tbody> <tr> <td>enumeration</td> <td>0060001</td> <td>documentation</td> </tr> </tbody> </table> | Kind | Value | Annotation | enumeration | 0060001 | documentation |
| Kind | Value | Annotation | | | | | |
| enumeration | 0060001 | documentation | | | | | |

| | |
|--------|--|
| | enumeration 0060002 ja documentation nein |
| source | <element name="OAK_AortaThorakalSchluessel" type="enum_0060"/> |

element **OperationAortenklappeBasis/OAK_NeuroprotektionSchluessel**

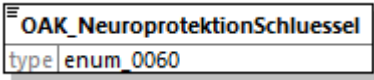
| diagram |  | | | | | | | | | |
|-------------|---|-----------------------|-------|------------|-------------|---------|---------------------|-------------|---------|-----------------------|
| type | enum_0060 | | | | | | | | | |
| properties | content simple | | | | | | | | | |
| facets | <table border="1"> <thead> <tr> <th>Kind</th> <th>Value</th> <th>Annotation</th> </tr> </thead> <tbody> <tr> <td>enumeration</td> <td>0060001</td> <td>documentation ja</td> </tr> <tr> <td>enumeration</td> <td>0060002</td> <td>documentation nein</td> </tr> </tbody> </table> | Kind | Value | Annotation | enumeration | 0060001 | documentation ja | enumeration | 0060002 | documentation nein |
| Kind | Value | Annotation | | | | | | | | |
| enumeration | 0060001 | documentation ja | | | | | | | | |
| enumeration | 0060002 | documentation nein | | | | | | | | |
| source | <element name="OAK_NeuroprotektionSchluessel" type="enum_0060"/> | | | | | | | | | |

element **OperationAortenklappeBasis/OAK_KreislaufunterstuetzungSchluessel**

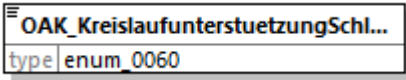
| diagram |  | | | | | | | | | |
|-------------|---|-----------------------|-------|------------|-------------|---------|---------------------|-------------|---------|-----------------------|
| type | enum_0060 | | | | | | | | | |
| properties | content simple | | | | | | | | | |
| facets | <table border="1"> <thead> <tr> <th>Kind</th> <th>Value</th> <th>Annotation</th> </tr> </thead> <tbody> <tr> <td>enumeration</td> <td>0060001</td> <td>documentation ja</td> </tr> <tr> <td>enumeration</td> <td>0060002</td> <td>documentation nein</td> </tr> </tbody> </table> | Kind | Value | Annotation | enumeration | 0060001 | documentation ja | enumeration | 0060002 | documentation nein |
| Kind | Value | Annotation | | | | | | | | |
| enumeration | 0060001 | documentation ja | | | | | | | | |
| enumeration | 0060002 | documentation nein | | | | | | | | |
| source | <element name="OAK_KreislaufunterstuetzungSchluessel" type="enum_0060"/> | | | | | | | | | |

element **OperationAortenklappeBasis/OAK_PraeOpUnterstuetzungSchluessel**

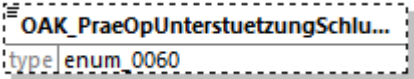
| diagram |  | | | | | | | | | |
|-------------|---|-----------------------|-------|------------|-------------|---------|---------------------|-------------|---------|-----------------------|
| type | enum_0060 | | | | | | | | | |
| properties | minOcc 0 maxOcc 1 content simple | | | | | | | | | |
| facets | <table border="1"> <thead> <tr> <th>Kind</th> <th>Value</th> <th>Annotation</th> </tr> </thead> <tbody> <tr> <td>enumeration</td> <td>0060001</td> <td>documentation ja</td> </tr> <tr> <td>enumeration</td> <td>0060002</td> <td>documentation nein</td> </tr> </tbody> </table> | Kind | Value | Annotation | enumeration | 0060001 | documentation ja | enumeration | 0060002 | documentation nein |
| Kind | Value | Annotation | | | | | | | | |
| enumeration | 0060001 | documentation ja | | | | | | | | |
| enumeration | 0060002 | documentation nein | | | | | | | | |
| source | <element name="OAK_PraeOpUnterstuetzungSchluessel" type="enum_0060" minOccurs="0"/> | | | | | | | | | |

element **OperationAortenklappeBasis/OAK_PraeOpMethodeSchluessel**

| diagram | | | | | | | | | | | | | | | | | | | |
|-------------|---|--------------------------|-------|------------|-------------|---------|-----------------------|-------------|---------|--------------------------|-------------|---------|--------------------------|-------------|---------|--------------------------|-------------|---------|-------------------------|
| type | enum 0350 | | | | | | | | | | | | | | | | | | |
| properties | minOcc 0 maxOcc 1 content simple | | | | | | | | | | | | | | | | | | |
| facets | <table border="1"> <thead> <tr> <th>Kind</th> <th>Value</th> <th>Annotation</th> </tr> </thead> <tbody> <tr> <td>enumeration</td> <td>0350001</td> <td>documentation IABP</td> </tr> <tr> <td>enumeration</td> <td>0350002</td> <td>documentation Impella</td> </tr> <tr> <td>enumeration</td> <td>0350003</td> <td>documentation vv ECMO</td> </tr> <tr> <td>enumeration</td> <td>0350004</td> <td>documentation va ECMO</td> </tr> <tr> <td>enumeration</td> <td>0350042</td> <td>documentation andere</td> </tr> </tbody> </table> | Kind | Value | Annotation | enumeration | 0350001 | documentation IABP | enumeration | 0350002 | documentation Impella | enumeration | 0350003 | documentation vv ECMO | enumeration | 0350004 | documentation va ECMO | enumeration | 0350042 | documentation andere |
| Kind | Value | Annotation | | | | | | | | | | | | | | | | | |
| enumeration | 0350001 | documentation IABP | | | | | | | | | | | | | | | | | |
| enumeration | 0350002 | documentation Impella | | | | | | | | | | | | | | | | | |
| enumeration | 0350003 | documentation vv ECMO | | | | | | | | | | | | | | | | | |
| enumeration | 0350004 | documentation va ECMO | | | | | | | | | | | | | | | | | |
| enumeration | 0350042 | documentation andere | | | | | | | | | | | | | | | | | |
| source | <code><element name="OAK_PraeOpMethodeSchluessel" type="enum_0350" minOccurs="0"/></code> | | | | | | | | | | | | | | | | | | |

element **OperationAortenklappeBasis/OAK_IntraOpUnterstuetzungSchluessel**

| diagram | | | | | | | | | | |
|-------------|---|-----------------------|-------|------------|-------------|---------|---------------------|-------------|---------|-----------------------|
| type | enum 0060 | | | | | | | | | |
| properties | minOcc 0 maxOcc 1 content simple | | | | | | | | | |
| facets | <table border="1"> <thead> <tr> <th>Kind</th> <th>Value</th> <th>Annotation</th> </tr> </thead> <tbody> <tr> <td>enumeration</td> <td>0060001</td> <td>documentation ja</td> </tr> <tr> <td>enumeration</td> <td>0060002</td> <td>documentation nein</td> </tr> </tbody> </table> | Kind | Value | Annotation | enumeration | 0060001 | documentation ja | enumeration | 0060002 | documentation nein |
| Kind | Value | Annotation | | | | | | | | |
| enumeration | 0060001 | documentation ja | | | | | | | | |
| enumeration | 0060002 | documentation nein | | | | | | | | |
| source | <code><element name="OAK_IntraOpUnterstuetzungSchluessel" type="enum_0060" minOccurs="0"/></code> | | | | | | | | | |

element **OperationAortenklappeBasis/OAK_IntraOpMethodeSchluessel**

| diagram | | | | | | | | | | | | | |
|-------------|--|--------------------------|-------|------------|-------------|---------|-----------------------|-------------|---------|--------------------------|-------------|---------|--------------------------|
| type | enum 0350 | | | | | | | | | | | | |
| properties | minOcc 0 maxOcc 1 content simple | | | | | | | | | | | | |
| facets | <table border="1"> <thead> <tr> <th>Kind</th> <th>Value</th> <th>Annotation</th> </tr> </thead> <tbody> <tr> <td>enumeration</td> <td>0350001</td> <td>documentation IABP</td> </tr> <tr> <td>enumeration</td> <td>0350002</td> <td>documentation Impella</td> </tr> <tr> <td>enumeration</td> <td>0350003</td> <td>documentation vv ECMO</td> </tr> </tbody> </table> | Kind | Value | Annotation | enumeration | 0350001 | documentation IABP | enumeration | 0350002 | documentation Impella | enumeration | 0350003 | documentation vv ECMO |
| Kind | Value | Annotation | | | | | | | | | | | |
| enumeration | 0350001 | documentation IABP | | | | | | | | | | | |
| enumeration | 0350002 | documentation Impella | | | | | | | | | | | |
| enumeration | 0350003 | documentation vv ECMO | | | | | | | | | | | |

| | |
|--------|--|
| | enumeration 0350004 documentation va ECMO |
| | enumeration 0350042 documentation andere |
| source | <code><element name="OAK_IntraOpMethodeSchluessel" type="enum_0350" minOccurs="0"/></code> |

element **OperationAortenklappeBasis/OAK_AortenklappenOpAnzahl**

| diagram | | | | | | | | | | |
|--------------|--|------------|-------|------------|--------------|---|--|--------------|----|--|
| type | Zahl2 | | | | | | | | | |
| properties | content simple | | | | | | | | | |
| facets | <table border="1"> <thead> <tr> <th>Kind</th> <th>Value</th> <th>Annotation</th> </tr> </thead> <tbody> <tr> <td>minInclusive</td> <td>1</td> <td></td> </tr> <tr> <td>maxInclusive</td> <td>99</td> <td></td> </tr> </tbody> </table> | Kind | Value | Annotation | minInclusive | 1 | | maxInclusive | 99 | |
| Kind | Value | Annotation | | | | | | | | |
| minInclusive | 1 | | | | | | | | | |
| maxInclusive | 99 | | | | | | | | | |
| source | <code><element name="OAK_AortenklappenOpAnzahl" type="Zahl2"/></code> | | | | | | | | | |

element **OperationAortenklappeBasis/OAK_ValveInValveSchluessel**

| diagram | | | | | | | | | | |
|-------------|---|-----------------------|-------|------------|-------------|---------|---------------------|-------------|---------|-----------------------|
| type | enum_0060 | | | | | | | | | |
| properties | minOcc 0 maxOcc 1 content simple | | | | | | | | | |
| facets | <table border="1"> <thead> <tr> <th>Kind</th> <th>Value</th> <th>Annotation</th> </tr> </thead> <tbody> <tr> <td>enumeration</td> <td>0060001</td> <td>documentation ja</td> </tr> <tr> <td>enumeration</td> <td>0060002</td> <td>documentation nein</td> </tr> </tbody> </table> | Kind | Value | Annotation | enumeration | 0060001 | documentation ja | enumeration | 0060002 | documentation nein |
| Kind | Value | Annotation | | | | | | | | |
| enumeration | 0060001 | documentation ja | | | | | | | | |
| enumeration | 0060002 | documentation nein | | | | | | | | |
| source | <code><element name="OAK_ValveInValveSchluessel" type="enum_0060" minOccurs="0"/></code> | | | | | | | | | |

element **OperationAortenklappeBasis/OAK_ZugangsGefaessdiameter**

| diagram | | | | | | | | | | | | | | | | |
|----------------|--|------------|-------|------------|--------------|-----|--|--------------|-----|--|-------------|---|--|----------------|---|--|
| type | Zahl1_1 | | | | | | | | | | | | | | | |
| properties | content simple | | | | | | | | | | | | | | | |
| facets | <table border="1"> <thead> <tr> <th>Kind</th> <th>Value</th> <th>Annotation</th> </tr> </thead> <tbody> <tr> <td>minInclusive</td> <td>0.1</td> <td></td> </tr> <tr> <td>maxInclusive</td> <td>9.9</td> <td></td> </tr> <tr> <td>totalDigits</td> <td>2</td> <td></td> </tr> <tr> <td>fractionDigits</td> <td>1</td> <td></td> </tr> </tbody> </table> | Kind | Value | Annotation | minInclusive | 0.1 | | maxInclusive | 9.9 | | totalDigits | 2 | | fractionDigits | 1 | |
| Kind | Value | Annotation | | | | | | | | | | | | | | |
| minInclusive | 0.1 | | | | | | | | | | | | | | | |
| maxInclusive | 9.9 | | | | | | | | | | | | | | | |
| totalDigits | 2 | | | | | | | | | | | | | | | |
| fractionDigits | 1 | | | | | | | | | | | | | | | |
| source | <code><element name="OAK_ZugangsGefaessdiameter" type="Zahl1_1"/></code> | | | | | | | | | | | | | | | |

element **OperationAortenklappeBasis/OAK_ZugangsGefaessUnbekannt**

| diagram | | | | | | | |
|------------|--|------------|-------|------------|---------|-----|--|
| type | JaLeer | | | | | | |
| properties | content simple | | | | | | |
| facets | <table border="1"> <thead> <tr> <th>Kind</th> <th>Value</th> <th>Annotation</th> </tr> </thead> <tbody> <tr> <td>pattern</td> <td>(1)</td> <td></td> </tr> </tbody> </table> | Kind | Value | Annotation | pattern | (1) | |
| Kind | Value | Annotation | | | | | |
| pattern | (1) | | | | | | |
| source | <code><element name="OAK_ZugangsGefaessUnbekannt" type="JaLeer"/></code> | | | | | | |

element **OperationAortenklappeBasis/OAK_ZugangVerkalkungSchluessel**

| diagram | | | | | | | | | | | | | |
|-------------|---|----------------------------|-------|------------|-------------|---------|---------------------|-------------|---------|-----------------------|-------------|---------|----------------------------|
| type | enum_0061 | | | | | | | | | | | | |
| properties | <table border="1"> <tbody> <tr> <td>minOcc</td> <td>0</td> </tr> <tr> <td>maxOcc</td> <td>1</td> </tr> <tr> <td>content</td> <td>simple</td> </tr> </tbody> </table> | minOcc | 0 | maxOcc | 1 | content | simple | | | | | | |
| minOcc | 0 | | | | | | | | | | | | |
| maxOcc | 1 | | | | | | | | | | | | |
| content | simple | | | | | | | | | | | | |
| facets | <table border="1"> <thead> <tr> <th>Kind</th> <th>Value</th> <th>Annotation</th> </tr> </thead> <tbody> <tr> <td>enumeration</td> <td>0061001</td> <td>documentation ja</td> </tr> <tr> <td>enumeration</td> <td>0061002</td> <td>documentation nein</td> </tr> <tr> <td>enumeration</td> <td>0061099</td> <td>documentation unbekannt</td> </tr> </tbody> </table> | Kind | Value | Annotation | enumeration | 0061001 | documentation ja | enumeration | 0061002 | documentation nein | enumeration | 0061099 | documentation unbekannt |
| Kind | Value | Annotation | | | | | | | | | | | |
| enumeration | 0061001 | documentation ja | | | | | | | | | | | |
| enumeration | 0061002 | documentation nein | | | | | | | | | | | |
| enumeration | 0061099 | documentation unbekannt | | | | | | | | | | | |
| source | <code><element name="OAK_ZugangVerkalkungSchluessel" type="enum_0061" minOccurs="0"/></code> | | | | | | | | | | | | |

element **OperationAortenklappeBasis/OAK_Aortenklappenannulus**

| diagram | | | | | | | | | | |
|--------------|---|------------|-------|------------|--------------|---------|--------|--------------|-----|--|
| type | Zahl3 | | | | | | | | | |
| properties | <table border="1"> <tbody> <tr> <td>minOcc</td> <td>0</td> </tr> <tr> <td>maxOcc</td> <td>1</td> </tr> <tr> <td>content</td> <td>simple</td> </tr> </tbody> </table> | minOcc | 0 | maxOcc | 1 | content | simple | | | |
| minOcc | 0 | | | | | | | | | |
| maxOcc | 1 | | | | | | | | | |
| content | simple | | | | | | | | | |
| facets | <table border="1"> <thead> <tr> <th>Kind</th> <th>Value</th> <th>Annotation</th> </tr> </thead> <tbody> <tr> <td>minInclusive</td> <td>1</td> <td></td> </tr> <tr> <td>maxInclusive</td> <td>999</td> <td></td> </tr> </tbody> </table> | Kind | Value | Annotation | minInclusive | 1 | | maxInclusive | 999 | |
| Kind | Value | Annotation | | | | | | | | |
| minInclusive | 1 | | | | | | | | | |
| maxInclusive | 999 | | | | | | | | | |
| source | <code><element name="OAK_Aortenklappenannulus" type="Zahl3" minOccurs="0"/></code> | | | | | | | | | |

element **OperationAortenklappeBasis/OAK_MessmethodeSchluessel**

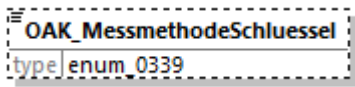
| diagram |  | | | | | | | | | | | | |
|-------------|---|-------------------------|-------|------------|-------------|---------|----------------------|-------------|---------|---------------------|-------------|---------|-------------------------|
| type | enum_0339 | | | | | | | | | | | | |
| properties | minOcc 0 maxOcc 1 content simple | | | | | | | | | | | | |
| facets | <table border="1"> <thead> <tr> <th>Kind</th> <th>Value</th> <th>Annotation</th> </tr> </thead> <tbody> <tr> <td>enumeration</td> <td>0339001</td> <td>documentation TEE</td> </tr> <tr> <td>enumeration</td> <td>0339002</td> <td>documentation CT</td> </tr> <tr> <td>enumeration</td> <td>0339042</td> <td>documentation andere</td> </tr> </tbody> </table> | Kind | Value | Annotation | enumeration | 0339001 | documentation TEE | enumeration | 0339002 | documentation CT | enumeration | 0339042 | documentation andere |
| Kind | Value | Annotation | | | | | | | | | | | |
| enumeration | 0339001 | documentation TEE | | | | | | | | | | | |
| enumeration | 0339002 | documentation CT | | | | | | | | | | | |
| enumeration | 0339042 | documentation andere | | | | | | | | | | | |
| source | <code><element name="OAK_MessmethodeSchluessel" type="enum_0339" minOccurs="0"/></code> | | | | | | | | | | | | |

element **OperationAortenklappeBasis/OAK_DistanzRca**

| diagram |  | | | | | | | | | |
|--------------|---|------------|-------|------------|--------------|---|--|--------------|-----|--|
| type | Zahl3 | | | | | | | | | |
| properties | content simple | | | | | | | | | |
| facets | <table border="1"> <thead> <tr> <th>Kind</th> <th>Value</th> <th>Annotation</th> </tr> </thead> <tbody> <tr> <td>minInclusive</td> <td>1</td> <td></td> </tr> <tr> <td>maxInclusive</td> <td>999</td> <td></td> </tr> </tbody> </table> | Kind | Value | Annotation | minInclusive | 1 | | maxInclusive | 999 | |
| Kind | Value | Annotation | | | | | | | | |
| minInclusive | 1 | | | | | | | | | |
| maxInclusive | 999 | | | | | | | | | |
| source | <code><element name="OAK_DistanzRca" type="Zahl3"/></code> | | | | | | | | | |

element **OperationAortenklappeBasis/OAK_DistanzRcaUnbekannt**

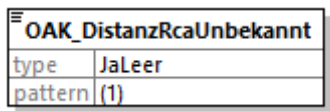
| diagram |  | | | | | | |
|------------|--|------------|-------|------------|---------|-----|--|
| type | JaLeer | | | | | | |
| properties | content simple | | | | | | |
| facets | <table border="1"> <thead> <tr> <th>Kind</th> <th>Value</th> <th>Annotation</th> </tr> </thead> <tbody> <tr> <td>pattern</td> <td>(1)</td> <td></td> </tr> </tbody> </table> | Kind | Value | Annotation | pattern | (1) | |
| Kind | Value | Annotation | | | | | |
| pattern | (1) | | | | | | |
| source | <code><element name="OAK_DistanzRcaUnbekannt" type="JaLeer"/></code> | | | | | | |

element **OperationAortenklappeBasis/OAK_DistanzLca**

| | |
|---------|---|
| diagram |  |
| type | Zahl3 |

| properties | content simple | | | | | | | | | |
|--------------|---|------------|-------|------------|--------------|---|--|--------------|-----|--|
| facets | <table border="1"> <thead> <tr> <th>Kind</th> <th>Value</th> <th>Annotation</th> </tr> </thead> <tbody> <tr> <td>minInclusive</td> <td>1</td> <td></td> </tr> <tr> <td>maxInclusive</td> <td>999</td> <td></td> </tr> </tbody> </table> | Kind | Value | Annotation | minInclusive | 1 | | maxInclusive | 999 | |
| Kind | Value | Annotation | | | | | | | | |
| minInclusive | 1 | | | | | | | | | |
| maxInclusive | 999 | | | | | | | | | |
| source | <code><element name="OAK_DistanzLca" type="Zahl13"/></code> | | | | | | | | | |

element **OperationAortenklappeBasis/OAK_DistanzLcaUnbekannt**

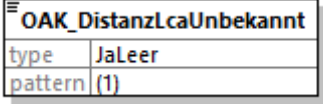
| diagram |  | | | | | | |
|------------|--|------------|-------|------------|---------|-----|--|
| type | JaLeer | | | | | | |
| properties | content simple | | | | | | |
| facets | <table border="1"> <thead> <tr> <th>Kind</th> <th>Value</th> <th>Annotation</th> </tr> </thead> <tbody> <tr> <td>pattern</td> <td>(1)</td> <td></td> </tr> </tbody> </table> | Kind | Value | Annotation | pattern | (1) | |
| Kind | Value | Annotation | | | | | |
| pattern | (1) | | | | | | |
| source | <code><element name="OAK_DistanzLcaUnbekannt" type="JaLeer"/></code> | | | | | | |

element **OperationAortenklappeBasis/OAK_PtcaVorSchluessel**

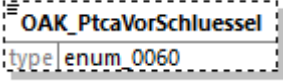
| diagram |  | | | | | | | | | |
|-------------|---|-----------------------|-------|------------|-------------|---------|---------------------|-------------|---------|-----------------------|
| type | enum_0060 | | | | | | | | | |
| properties | <table border="1"> <tbody> <tr> <td>minOcc</td> <td>0</td> </tr> <tr> <td>maxOcc</td> <td>1</td> </tr> <tr> <td>content</td> <td>simple</td> </tr> </tbody> </table> | minOcc | 0 | maxOcc | 1 | content | simple | | | |
| minOcc | 0 | | | | | | | | | |
| maxOcc | 1 | | | | | | | | | |
| content | simple | | | | | | | | | |
| facets | <table border="1"> <thead> <tr> <th>Kind</th> <th>Value</th> <th>Annotation</th> </tr> </thead> <tbody> <tr> <td>enumeration</td> <td>0060001</td> <td>documentation ja</td> </tr> <tr> <td>enumeration</td> <td>0060002</td> <td>documentation nein</td> </tr> </tbody> </table> | Kind | Value | Annotation | enumeration | 0060001 | documentation ja | enumeration | 0060002 | documentation nein |
| Kind | Value | Annotation | | | | | | | | |
| enumeration | 0060001 | documentation ja | | | | | | | | |
| enumeration | 0060002 | documentation nein | | | | | | | | |
| source | <code><element name="OAK_PtcaVorSchluessel" type="enum_0060" minOccurs="0"/></code> | | | | | | | | | |

element **OperationAortenklappeBasis/OAK_PtcaVorDurchmesser**

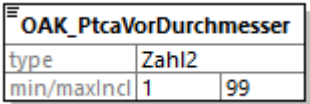
| diagram |  | | | | | | | | | |
|--------------|--|------------|-------|------------|--------------|---|--|--------------|----|--|
| type | Zahl2 | | | | | | | | | |
| properties | content simple | | | | | | | | | |
| facets | <table border="1"> <thead> <tr> <th>Kind</th> <th>Value</th> <th>Annotation</th> </tr> </thead> <tbody> <tr> <td>minInclusive</td> <td>1</td> <td></td> </tr> <tr> <td>maxInclusive</td> <td>99</td> <td></td> </tr> </tbody> </table> | Kind | Value | Annotation | minInclusive | 1 | | maxInclusive | 99 | |
| Kind | Value | Annotation | | | | | | | | |
| minInclusive | 1 | | | | | | | | | |
| maxInclusive | 99 | | | | | | | | | |
| source | <code><element name="OAK_PtcaVorDurchmesser" type="Zahl2"/></code> | | | | | | | | | |

element **OperationAortenklappeBasis/OAK_PtcaVorDurchmesserUnbekannt**

| diagram | | | | | | | |
|------------|--|------------|-------|------------|---------|-----|--|
| type | JaLeer | | | | | | |
| properties | content simple | | | | | | |
| facets | <table border="1"> <thead> <tr> <th>Kind</th> <th>Value</th> <th>Annotation</th> </tr> </thead> <tbody> <tr> <td>pattern</td> <td>(1)</td> <td></td> </tr> </tbody> </table> | Kind | Value | Annotation | pattern | (1) | |
| Kind | Value | Annotation | | | | | |
| pattern | (1) | | | | | | |
| source | <code><element name="OAK_PtcaVorDurchmesserUnbekannt" type="JaLeer"/></code> | | | | | | |

element **OperationAortenklappeBasis/OAK_PtcaVorAnzahl**

| diagram | | | | | | | | | | |
|--------------|--|------------|-------|------------|--------------|---------|--------|--------------|----|--|
| type | Zahl2 | | | | | | | | | |
| properties | <table border="1"> <tbody> <tr> <td>minOcc</td> <td>0</td> </tr> <tr> <td>maxOcc</td> <td>1</td> </tr> <tr> <td>content</td> <td>simple</td> </tr> </tbody> </table> | minOcc | 0 | maxOcc | 1 | content | simple | | | |
| minOcc | 0 | | | | | | | | | |
| maxOcc | 1 | | | | | | | | | |
| content | simple | | | | | | | | | |
| facets | <table border="1"> <thead> <tr> <th>Kind</th> <th>Value</th> <th>Annotation</th> </tr> </thead> <tbody> <tr> <td>minInclusive</td> <td>1</td> <td></td> </tr> <tr> <td>maxInclusive</td> <td>99</td> <td></td> </tr> </tbody> </table> | Kind | Value | Annotation | minInclusive | 1 | | maxInclusive | 99 | |
| Kind | Value | Annotation | | | | | | | | |
| minInclusive | 1 | | | | | | | | | |
| maxInclusive | 99 | | | | | | | | | |
| source | <code><element name="OAK_PtcaVorAnzahl" type="Zahl2" minOccurs="0"/></code> | | | | | | | | | |

element **OperationAortenklappeBasis/OAK_RapidPacingVorSchluessel**

| diagram | | | | | | | | | | |
|-------------|---|-----------------------|-------|------------|-------------|---------|---------------------|-------------|---------|-----------------------|
| type | enum_0060 | | | | | | | | | |
| properties | <table border="1"> <tbody> <tr> <td>minOcc</td> <td>0</td> </tr> <tr> <td>maxOcc</td> <td>1</td> </tr> <tr> <td>content</td> <td>simple</td> </tr> </tbody> </table> | minOcc | 0 | maxOcc | 1 | content | simple | | | |
| minOcc | 0 | | | | | | | | | |
| maxOcc | 1 | | | | | | | | | |
| content | simple | | | | | | | | | |
| facets | <table border="1"> <thead> <tr> <th>Kind</th> <th>Value</th> <th>Annotation</th> </tr> </thead> <tbody> <tr> <td>enumeration</td> <td>0060001</td> <td>documentation ja</td> </tr> <tr> <td>enumeration</td> <td>0060002</td> <td>documentation nein</td> </tr> </tbody> </table> | Kind | Value | Annotation | enumeration | 0060001 | documentation ja | enumeration | 0060002 | documentation nein |
| Kind | Value | Annotation | | | | | | | | |
| enumeration | 0060001 | documentation ja | | | | | | | | |
| enumeration | 0060002 | documentation nein | | | | | | | | |
| source | <code><element name="OAK_RapidPacingVorSchluessel" type="enum_0060" minOccurs="0"/></code> | | | | | | | | | |

element **OperationAortenklappeBasis/OAK_RapidPacingIntraSchluessel**

| | | | | | |
|------------|--|--------|---|--------|---|
| diagram | | | | | |
| type | enum_0060 | | | | |
| properties | <table border="1"> <tbody> <tr> <td>minOcc</td> <td>0</td> </tr> <tr> <td>maxOcc</td> <td>1</td> </tr> </tbody> </table> | minOcc | 0 | maxOcc | 1 |
| minOcc | 0 | | | | |
| maxOcc | 1 | | | | |

| | content simple | | | | | | | | | |
|-------------|---|-----------------------|-------|------------|-------------|---------|---------------------|-------------|---------|-----------------------|
| facets | <table border="1"> <thead> <tr> <th>Kind</th> <th>Value</th> <th>Annotation</th> </tr> </thead> <tbody> <tr> <td>enumeration</td> <td>0060001</td> <td>documentation ja</td> </tr> <tr> <td>enumeration</td> <td>0060002</td> <td>documentation nein</td> </tr> </tbody> </table> | Kind | Value | Annotation | enumeration | 0060001 | documentation ja | enumeration | 0060002 | documentation nein |
| Kind | Value | Annotation | | | | | | | | |
| enumeration | 0060001 | documentation ja | | | | | | | | |
| enumeration | 0060002 | documentation nein | | | | | | | | |
| source | <code><element name="OAK_RapidPacingIntraSchluessel" type="enum_0060" minOccurs="0"/></code> | | | | | | | | | |

element **OperationAortenklappeBasis/OAK_PtcaNachSchluessel**

| diagram | | | | | | | | | | |
|-------------|---|-----------------------|-------|------------|-------------|---------|---------------------|-------------|---------|-----------------------|
| type | enum_0060 | | | | | | | | | |
| properties | minOcc 0 maxOcc 1 content simple | | | | | | | | | |
| facets | <table border="1"> <thead> <tr> <th>Kind</th> <th>Value</th> <th>Annotation</th> </tr> </thead> <tbody> <tr> <td>enumeration</td> <td>0060001</td> <td>documentation ja</td> </tr> <tr> <td>enumeration</td> <td>0060002</td> <td>documentation nein</td> </tr> </tbody> </table> | Kind | Value | Annotation | enumeration | 0060001 | documentation ja | enumeration | 0060002 | documentation nein |
| Kind | Value | Annotation | | | | | | | | |
| enumeration | 0060001 | documentation ja | | | | | | | | |
| enumeration | 0060002 | documentation nein | | | | | | | | |
| source | <code><element name="OAK_PtcaNachSchluessel" type="enum_0060" minOccurs="0"/></code> | | | | | | | | | |

element **OperationAortenklappeBasis/OAK_PtcaNachDurchmesser**

| diagram | | | | | | | | | | |
|--------------|--|------------|-------|------------|--------------|---|--|--------------|----|--|
| type | Zahl2 | | | | | | | | | |
| properties | content simple | | | | | | | | | |
| facets | <table border="1"> <thead> <tr> <th>Kind</th> <th>Value</th> <th>Annotation</th> </tr> </thead> <tbody> <tr> <td>minInclusive</td> <td>1</td> <td></td> </tr> <tr> <td>maxInclusive</td> <td>99</td> <td></td> </tr> </tbody> </table> | Kind | Value | Annotation | minInclusive | 1 | | maxInclusive | 99 | |
| Kind | Value | Annotation | | | | | | | | |
| minInclusive | 1 | | | | | | | | | |
| maxInclusive | 99 | | | | | | | | | |
| source | <code><element name="OAK_PtcaNachDurchmesser" type="Zahl2"/></code> | | | | | | | | | |

element **OperationAortenklappeBasis/OAK_PtcaNachDurchmesserUnbekannt**

| diagram | | | | | | | |
|------------|--|------------|-------|------------|---------|-----|--|
| type | JaLeer | | | | | | |
| properties | content simple | | | | | | |
| facets | <table border="1"> <thead> <tr> <th>Kind</th> <th>Value</th> <th>Annotation</th> </tr> </thead> <tbody> <tr> <td>pattern</td> <td>(1)</td> <td></td> </tr> </tbody> </table> | Kind | Value | Annotation | pattern | (1) | |
| Kind | Value | Annotation | | | | | |
| pattern | (1) | | | | | | |
| source | <code><element name="OAK_PtcaNachDurchmesserUnbekannt" type="JaLeer"/></code> | | | | | | |

element **OperationAortenklappeBasis/OAK_PtcaNachAnzahl**

| diagram | | | | | | | | | | |
|--------------|--|------------|-------|------------|--------------|---|--|--------------|----|--|
| type | Zahl2 | | | | | | | | | |
| properties | minOcc 0 maxOcc 1 content simple | | | | | | | | | |
| facets | <table border="1"> <thead> <tr> <th>Kind</th> <th>Value</th> <th>Annotation</th> </tr> </thead> <tbody> <tr> <td>minInclusive</td> <td>1</td> <td></td> </tr> <tr> <td>maxInclusive</td> <td>99</td> <td></td> </tr> </tbody> </table> | Kind | Value | Annotation | minInclusive | 1 | | maxInclusive | 99 | |
| Kind | Value | Annotation | | | | | | | | |
| minInclusive | 1 | | | | | | | | | |
| maxInclusive | 99 | | | | | | | | | |
| source | <code><element name="OAK_PtcaNachAnzahl" type="Zahl2" minOccurs="0"/></code> | | | | | | | | | |

element **OperationAortenklappeBasis/OAK_RapidPacingNachSchluessel**

| diagram | | | | | | | | | | |
|-------------|---|-----------------------|-------|------------|-------------|---------|---------------------|-------------|---------|-----------------------|
| type | enum_0060 | | | | | | | | | |
| properties | minOcc 0 maxOcc 1 content simple | | | | | | | | | |
| facets | <table border="1"> <thead> <tr> <th>Kind</th> <th>Value</th> <th>Annotation</th> </tr> </thead> <tbody> <tr> <td>enumeration</td> <td>0060001</td> <td>documentation ja</td> </tr> <tr> <td>enumeration</td> <td>0060002</td> <td>documentation nein</td> </tr> </tbody> </table> | Kind | Value | Annotation | enumeration | 0060001 | documentation ja | enumeration | 0060002 | documentation nein |
| Kind | Value | Annotation | | | | | | | | |
| enumeration | 0060001 | documentation ja | | | | | | | | |
| enumeration | 0060002 | documentation nein | | | | | | | | |
| source | <code><element name="OAK_RapidPacingNachSchluessel" type="enum_0060" minOccurs="0"/></code> | | | | | | | | | |

element **OperationAortenklappeBasis/OAK_KonversionSchluessel**

| diagram | | | | | | | | | | | | | | | | | | | | | | | | | |
|-------------|--|---|-------|------------|-------------|---------|-----------------------|-------------|---------|------------------------------------|-------------|---------|-------------------------------------|-------------|---------|-------------------------------------|-------------|---------|---------------------------------------|-------------|---------|--------------------------------------|-------------|---------|---|
| type | enum_0351 | | | | | | | | | | | | | | | | | | | | | | | | |
| properties | minOcc 0 maxOcc 1 content simple | | | | | | | | | | | | | | | | | | | | | | | | |
| facets | <table border="1"> <thead> <tr> <th>Kind</th> <th>Value</th> <th>Annotation</th> </tr> </thead> <tbody> <tr> <td>enumeration</td> <td>0351001</td> <td>documentation nein</td> </tr> <tr> <td>enumeration</td> <td>0351002</td> <td>documentation ja, zu Stenotomie</td> </tr> <tr> <td>enumeration</td> <td>0351003</td> <td>documentation ja, zu transapikal</td> </tr> <tr> <td>enumeration</td> <td>0351004</td> <td>documentation ja, zu transaortal</td> </tr> <tr> <td>enumeration</td> <td>0351005</td> <td>documentation ja, zu transfemorale</td> </tr> <tr> <td>enumeration</td> <td>0351006</td> <td>documentation ja, zu transaxillär</td> </tr> <tr> <td>enumeration</td> <td>0351007</td> <td>documentation ja, zu anderem endovaskulären Zugang</td> </tr> </tbody> </table> | Kind | Value | Annotation | enumeration | 0351001 | documentation nein | enumeration | 0351002 | documentation ja, zu Stenotomie | enumeration | 0351003 | documentation ja, zu transapikal | enumeration | 0351004 | documentation ja, zu transaortal | enumeration | 0351005 | documentation ja, zu transfemorale | enumeration | 0351006 | documentation ja, zu transaxillär | enumeration | 0351007 | documentation ja, zu anderem endovaskulären Zugang |
| Kind | Value | Annotation | | | | | | | | | | | | | | | | | | | | | | | |
| enumeration | 0351001 | documentation nein | | | | | | | | | | | | | | | | | | | | | | | |
| enumeration | 0351002 | documentation ja, zu Stenotomie | | | | | | | | | | | | | | | | | | | | | | | |
| enumeration | 0351003 | documentation ja, zu transapikal | | | | | | | | | | | | | | | | | | | | | | | |
| enumeration | 0351004 | documentation ja, zu transaortal | | | | | | | | | | | | | | | | | | | | | | | |
| enumeration | 0351005 | documentation ja, zu transfemorale | | | | | | | | | | | | | | | | | | | | | | | |
| enumeration | 0351006 | documentation ja, zu transaxillär | | | | | | | | | | | | | | | | | | | | | | | |
| enumeration | 0351007 | documentation ja, zu anderem endovaskulären Zugang | | | | | | | | | | | | | | | | | | | | | | | |

| | |
|--------|---|
| | enumeration 0351042 documentation ja, zu anderem Zugang |
| source | <element name="OAK_KonversionSchluessel" type="enum_0351" minOccurs="0"/> |

element **OperationAortenklappeBasis/OAK_SuccessSchluessel**

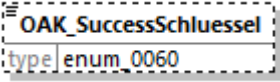
| diagram |  | | | | | | | | | |
|-------------|---|-----------------------|-------|------------|-------------|---------|---------------------|-------------|---------|-----------------------|
| type | enum_0060 | | | | | | | | | |
| properties | minOcc 0 maxOcc 1 content simple | | | | | | | | | |
| facets | <table border="1"> <thead> <tr> <th>Kind</th> <th>Value</th> <th>Annotation</th> </tr> </thead> <tbody> <tr> <td>enumeration</td> <td>0060001</td> <td>documentation ja</td> </tr> <tr> <td>enumeration</td> <td>0060002</td> <td>documentation nein</td> </tr> </tbody> </table> | Kind | Value | Annotation | enumeration | 0060001 | documentation ja | enumeration | 0060002 | documentation nein |
| Kind | Value | Annotation | | | | | | | | |
| enumeration | 0060001 | documentation ja | | | | | | | | |
| enumeration | 0060002 | documentation nein | | | | | | | | |
| source | <element name="OAK_SuccessSchluessel" type="enum_0060" minOccurs="0"/> | | | | | | | | | |

element **OperationAortenklappeBasis/OAK_AnaesthesieSchluessel**

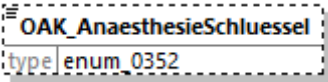
| diagram |  | | | | | | | | | | | | | | | |
|-------------|---|---|-------|------------|-------------|---------|-----------------------|-------------|---------|---|-------------|---------|---|-------------|---------|---------------------------------------|
| type | enum_0352 | | | | | | | | | | | | | | | |
| properties | minOcc 0 maxOcc 1 content simple | | | | | | | | | | | | | | | |
| facets | <table border="1"> <thead> <tr> <th>Kind</th> <th>Value</th> <th>Annotation</th> </tr> </thead> <tbody> <tr> <td>enumeration</td> <td>0352001</td> <td>documentation nein</td> </tr> <tr> <td>enumeration</td> <td>0352002</td> <td>documentation ja, Intubationsnarkose</td> </tr> <tr> <td>enumeration</td> <td>0352003</td> <td>documentation ja, Maskenbeatmung, incl. LAMA</td> </tr> <tr> <td>enumeration</td> <td>0352042</td> <td>documentation ja, unbekannt welche</td> </tr> </tbody> </table> | Kind | Value | Annotation | enumeration | 0352001 | documentation nein | enumeration | 0352002 | documentation ja, Intubationsnarkose | enumeration | 0352003 | documentation ja, Maskenbeatmung, incl. LAMA | enumeration | 0352042 | documentation ja, unbekannt welche |
| Kind | Value | Annotation | | | | | | | | | | | | | | |
| enumeration | 0352001 | documentation nein | | | | | | | | | | | | | | |
| enumeration | 0352002 | documentation ja, Intubationsnarkose | | | | | | | | | | | | | | |
| enumeration | 0352003 | documentation ja, Maskenbeatmung, incl. LAMA | | | | | | | | | | | | | | |
| enumeration | 0352042 | documentation ja, unbekannt welche | | | | | | | | | | | | | | |
| source | <element name="OAK_AnaesthesieSchluessel" type="enum_0352" minOccurs="0"/> | | | | | | | | | | | | | | | |

element **OperationAortenklappeBasis/OAK_DeltaPmeanNachOp**

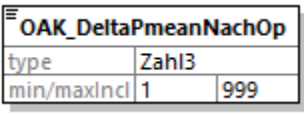
| diagram |  | | | | | | | | | |
|--------------|---|------------|-------|------------|--------------|---|--|--------------|-----|--|
| type | Zahl3 | | | | | | | | | |
| properties | content simple | | | | | | | | | |
| facets | <table border="1"> <thead> <tr> <th>Kind</th> <th>Value</th> <th>Annotation</th> </tr> </thead> <tbody> <tr> <td>minInclusive</td> <td>1</td> <td></td> </tr> <tr> <td>maxInclusive</td> <td>999</td> <td></td> </tr> </tbody> </table> | Kind | Value | Annotation | minInclusive | 1 | | maxInclusive | 999 | |
| Kind | Value | Annotation | | | | | | | | |
| minInclusive | 1 | | | | | | | | | |
| maxInclusive | 999 | | | | | | | | | |

| | |
|--------|--|
| source | <code><element name="OAK_DeltaPmeanNachOp" type="Zah13"/></code> |
|--------|--|

element **OperationAortenklappeBasis/OAK_DeltaPmeanNachOpUnbekannt**

| diagram | | | | | | | |
|------------|--|------------|-------|------------|---------|-----|--|
| type | JaLeer | | | | | | |
| properties | content simple | | | | | | |
| facets | <table border="1"> <thead> <tr> <th>Kind</th> <th>Value</th> <th>Annotation</th> </tr> </thead> <tbody> <tr> <td>pattern</td> <td>(1)</td> <td></td> </tr> </tbody> </table> | Kind | Value | Annotation | pattern | (1) | |
| Kind | Value | Annotation | | | | | |
| pattern | (1) | | | | | | |
| source | <code><element name="OAK_DeltaPmeanNachOpUnbekannt" type="JaLeer"/></code> | | | | | | |

element **OperationAortenklappeBasis/OAK_ResidualeInsuffizienzSchluessel**

| diagram | | | | | | | | | | | | | | | | | | | |
|-------------|---|-----------------------------------|-------|------------|-------------|---------|------------------------|-------------|---------|-------------------------------|-------------|---------|-------------------------------|-------------|---------|-----------------------------|-------------|---------|-----------------------------------|
| type | enum 0353 | | | | | | | | | | | | | | | | | | |
| properties | <table border="1"> <tr> <td>minOcc</td> <td>0</td> </tr> <tr> <td>maxOcc</td> <td>1</td> </tr> <tr> <td>content</td> <td>simple</td> </tr> </table> | minOcc | 0 | maxOcc | 1 | content | simple | | | | | | | | | | | | |
| minOcc | 0 | | | | | | | | | | | | | | | | | | |
| maxOcc | 1 | | | | | | | | | | | | | | | | | | |
| content | simple | | | | | | | | | | | | | | | | | | |
| facets | <table border="1"> <thead> <tr> <th>Kind</th> <th>Value</th> <th>Annotation</th> </tr> </thead> <tbody> <tr> <td>enumeration</td> <td>0353001</td> <td>documentation keine</td> </tr> <tr> <td>enumeration</td> <td>0353002</td> <td>documentation leichtgradig</td> </tr> <tr> <td>enumeration</td> <td>0353003</td> <td>documentation mittelgradig</td> </tr> <tr> <td>enumeration</td> <td>0353004</td> <td>documentation hochgradig</td> </tr> <tr> <td>enumeration</td> <td>0353099</td> <td>documentation nicht bestimmbar</td> </tr> </tbody> </table> | Kind | Value | Annotation | enumeration | 0353001 | documentation keine | enumeration | 0353002 | documentation leichtgradig | enumeration | 0353003 | documentation mittelgradig | enumeration | 0353004 | documentation hochgradig | enumeration | 0353099 | documentation nicht bestimmbar |
| Kind | Value | Annotation | | | | | | | | | | | | | | | | | |
| enumeration | 0353001 | documentation keine | | | | | | | | | | | | | | | | | |
| enumeration | 0353002 | documentation leichtgradig | | | | | | | | | | | | | | | | | |
| enumeration | 0353003 | documentation mittelgradig | | | | | | | | | | | | | | | | | |
| enumeration | 0353004 | documentation hochgradig | | | | | | | | | | | | | | | | | |
| enumeration | 0353099 | documentation nicht bestimmbar | | | | | | | | | | | | | | | | | |
| source | <code><element name="OAK_ResidualeInsuffizienzSchluessel" type="enum_0353" minOccurs="0"/></code> | | | | | | | | | | | | | | | | | | |

element **OperationAortenklappeBasis/OAK_ZugangVerschlussSchluessel**

| diagram | | | | | | | | | | | | | |
|-------------|---|------------------------------------|-------|------------|-------------|---------|------------------------------------|-------------|---------|------------------------------------|-------------|---------|---------------|
| type | enum 0354 | | | | | | | | | | | | |
| properties | <table border="1"> <tr> <td>minOcc</td> <td>0</td> </tr> <tr> <td>maxOcc</td> <td>1</td> </tr> <tr> <td>content</td> <td>simple</td> </tr> </table> | minOcc | 0 | maxOcc | 1 | content | simple | | | | | | |
| minOcc | 0 | | | | | | | | | | | | |
| maxOcc | 1 | | | | | | | | | | | | |
| content | simple | | | | | | | | | | | | |
| facets | <table border="1"> <thead> <tr> <th>Kind</th> <th>Value</th> <th>Annotation</th> </tr> </thead> <tbody> <tr> <td>enumeration</td> <td>0354001</td> <td>documentation chirurgisch-offen</td> </tr> <tr> <td>enumeration</td> <td>0354002</td> <td>documentation Verschluss-System</td> </tr> <tr> <td>enumeration</td> <td>0354042</td> <td>documentation</td> </tr> </tbody> </table> | Kind | Value | Annotation | enumeration | 0354001 | documentation chirurgisch-offen | enumeration | 0354002 | documentation Verschluss-System | enumeration | 0354042 | documentation |
| Kind | Value | Annotation | | | | | | | | | | | |
| enumeration | 0354001 | documentation chirurgisch-offen | | | | | | | | | | | |
| enumeration | 0354002 | documentation Verschluss-System | | | | | | | | | | | |
| enumeration | 0354042 | documentation | | | | | | | | | | | |

| | |
|--------|--|
| | sonstige |
| source | <code><element name="OAK_ZugangVerschlussSchluessel" type="enum_0354" minOccurs="0"/></code> |

element **OperationAortenklappeBasis/OAK_ZusaetzlichePciSchluessel**

| diagram | | | | | | | | | | |
|-------------|---|-----------------------|-------|------------|-------------|---------|---------------------|-------------|---------|-----------------------|
| type | enum 0060 | | | | | | | | | |
| properties | minOcc 0 maxOcc 1 content simple | | | | | | | | | |
| facets | <table border="1"> <thead> <tr> <th>Kind</th> <th>Value</th> <th>Annotation</th> </tr> </thead> <tbody> <tr> <td>enumeration</td> <td>0060001</td> <td>documentation ja</td> </tr> <tr> <td>enumeration</td> <td>0060002</td> <td>documentation nein</td> </tr> </tbody> </table> | Kind | Value | Annotation | enumeration | 0060001 | documentation ja | enumeration | 0060002 | documentation nein |
| Kind | Value | Annotation | | | | | | | | |
| enumeration | 0060001 | documentation ja | | | | | | | | |
| enumeration | 0060002 | documentation nein | | | | | | | | |
| source | <code><element name="OAK_ZusaetzlichePciSchluessel" type="enum_0060" minOccurs="0"/></code> | | | | | | | | | |

element **OperationAortenklappeBasis/OAK_PciWegenKhkSchluessel**

| diagram | | | | | | | | | | |
|-------------|---|-----------------------|-------|------------|-------------|---------|---------------------|-------------|---------|-----------------------|
| type | enum 0060 | | | | | | | | | |
| properties | minOcc 0 maxOcc 1 content simple | | | | | | | | | |
| facets | <table border="1"> <thead> <tr> <th>Kind</th> <th>Value</th> <th>Annotation</th> </tr> </thead> <tbody> <tr> <td>enumeration</td> <td>0060001</td> <td>documentation ja</td> </tr> <tr> <td>enumeration</td> <td>0060002</td> <td>documentation nein</td> </tr> </tbody> </table> | Kind | Value | Annotation | enumeration | 0060001 | documentation ja | enumeration | 0060002 | documentation nein |
| Kind | Value | Annotation | | | | | | | | |
| enumeration | 0060001 | documentation ja | | | | | | | | |
| enumeration | 0060002 | documentation nein | | | | | | | | |
| source | <code><element name="OAK_PciWegenKhkSchluessel" type="enum_0060" minOccurs="0"/></code> | | | | | | | | | |

element **OperationAortenklappeBasis/OAK_PciWegenKomplikationSchluessel**

| diagram | | | | | | | | | | |
|-------------|---|-----------------------|-------|------------|-------------|---------|---------------------|-------------|---------|-----------------------|
| type | enum 0060 | | | | | | | | | |
| properties | minOcc 0 maxOcc 1 content simple | | | | | | | | | |
| facets | <table border="1"> <thead> <tr> <th>Kind</th> <th>Value</th> <th>Annotation</th> </tr> </thead> <tbody> <tr> <td>enumeration</td> <td>0060001</td> <td>documentation ja</td> </tr> <tr> <td>enumeration</td> <td>0060002</td> <td>documentation nein</td> </tr> </tbody> </table> | Kind | Value | Annotation | enumeration | 0060001 | documentation ja | enumeration | 0060002 | documentation nein |
| Kind | Value | Annotation | | | | | | | | |
| enumeration | 0060001 | documentation ja | | | | | | | | |
| enumeration | 0060002 | documentation nein | | | | | | | | |
| source | <code><element name="OAK_PciWegenKomplikationSchluessel" type="enum_0060" minOccurs="0"/></code> | | | | | | | | | |

element **OperationAortenklappeBasis/OAK_LaesionenAnzahl**

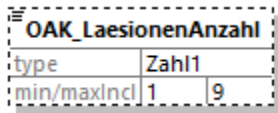
| diagram |  | | | | | | | | | |
|--------------|---|------------|-------|------------|--------------|---|--|--------------|---|--|
| type | Zahl1 | | | | | | | | | |
| properties | minOcc 0 maxOcc 1 content simple | | | | | | | | | |
| facets | <table border="1"> <thead> <tr> <th>Kind</th> <th>Value</th> <th>Annotation</th> </tr> </thead> <tbody> <tr> <td>minInclusive</td> <td>1</td> <td></td> </tr> <tr> <td>maxInclusive</td> <td>9</td> <td></td> </tr> </tbody> </table> | Kind | Value | Annotation | minInclusive | 1 | | maxInclusive | 9 | |
| Kind | Value | Annotation | | | | | | | | |
| minInclusive | 1 | | | | | | | | | |
| maxInclusive | 9 | | | | | | | | | |
| source | <code><element name="OAK_LaesionenAnzahl" type="Zahl1" minOccurs="0"/></code> | | | | | | | | | |

complexType **TaviAortenklappeBasis**

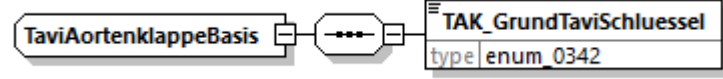
| | |
|-----------|--|
| diagram |  |
| namespace | http://xml.ir-d.de/emg |
| children | TAK_GrundTaviSchluessel |
| used by | element OperationAortenklappe/taviAortenklappe |
| source | <code><complexType name="TaviAortenklappeBasis"> <sequence> <element name="TAK_GrundTaviSchluessel" type="enum_0342"/> </sequence> </complexType></code> |

element **TaviAortenklappeBasis/TAK_GrundTaviSchluessel**

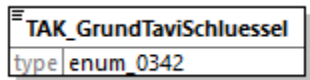
| diagram |  | | | | | | | | | | | | | | | | | | | | | |
|-------------|---|--|-------|------------|-------------|---------|------------------------|-------------|---------|--------------------------|-------------|---------|-----------------------------|-------------|---------|--|-------------|---------|----------------------------------|-------------|---------|---------------------------|
| type | enum_0342 | | | | | | | | | | | | | | | | | | | | | |
| properties | content simple | | | | | | | | | | | | | | | | | | | | | |
| facets | <table border="1"> <thead> <tr> <th>Kind</th> <th>Value</th> <th>Annotation</th> </tr> </thead> <tbody> <tr> <td>enumeration</td> <td>0342001</td> <td>documentation Alter</td> </tr> <tr> <td>enumeration</td> <td>0342002</td> <td>documentation Frailty</td> </tr> <tr> <td>enumeration</td> <td>0342003</td> <td>documentation Hochrisiko</td> </tr> <tr> <td>enumeration</td> <td>0342004</td> <td>documentation Prognose-limitierende Zweiterkrankung</td> </tr> <tr> <td>enumeration</td> <td>0342005</td> <td>documentation Porzellan-Aorta</td> </tr> <tr> <td>enumeration</td> <td>0342042</td> <td>documentation Sonstige</td> </tr> </tbody> </table> | Kind | Value | Annotation | enumeration | 0342001 | documentation Alter | enumeration | 0342002 | documentation Frailty | enumeration | 0342003 | documentation Hochrisiko | enumeration | 0342004 | documentation Prognose-limitierende Zweiterkrankung | enumeration | 0342005 | documentation Porzellan-Aorta | enumeration | 0342042 | documentation Sonstige |
| Kind | Value | Annotation | | | | | | | | | | | | | | | | | | | | |
| enumeration | 0342001 | documentation Alter | | | | | | | | | | | | | | | | | | | | |
| enumeration | 0342002 | documentation Frailty | | | | | | | | | | | | | | | | | | | | |
| enumeration | 0342003 | documentation Hochrisiko | | | | | | | | | | | | | | | | | | | | |
| enumeration | 0342004 | documentation Prognose-limitierende Zweiterkrankung | | | | | | | | | | | | | | | | | | | | |
| enumeration | 0342005 | documentation Porzellan-Aorta | | | | | | | | | | | | | | | | | | | | |
| enumeration | 0342042 | documentation Sonstige | | | | | | | | | | | | | | | | | | | | |
| source | <code><element name="TAK_GrundTaviSchluessel" type="enum_0342"/></code> | | | | | | | | | | | | | | | | | | | | | |

complexType **ProzedurenSchluesselAortenklappeBasis**

| | |
|-----------|---|
| diagram | |
| namespace | http://xml.ir-d.de/emg |
| children | PAK_ProzedurenSchluessel |
| used by | element OperationAortenklappe/prozedurenSchluesselAortenklappe |
| source | <pre><complexType name="ProzedurenSchluesselAortenklappeBasis"> <sequence> <element name="PAK_ProzedurenSchluessel" type="OPS"/> </sequence> </complexType></pre> |

element **ProzedurenSchluesselAortenklappeBasis/PAK_ProzedurenSchluessel**

| diagram | | | | | | | |
|------------|--|------------|-------|------------|---------|---|--|
| type | OPS | | | | | | |
| properties | content simple | | | | | | |
| facets | <table border="1"> <thead> <tr> <th>Kind</th> <th>Value</th> <th>Annotation</th> </tr> </thead> <tbody> <tr> <td>pattern</td> <td>((135689)\-([0-9]){2}([a-zA-Z0-9]){1}\.([a-zA-Z0-9]{1,2}))*(:[RLBrlb])?</td> <td></td> </tr> </tbody> </table> | Kind | Value | Annotation | pattern | ((135689)\-([0-9]){2}([a-zA-Z0-9]){1}\.([a-zA-Z0-9]{1,2}))*(:[RLBrlb])? | |
| Kind | Value | Annotation | | | | | |
| pattern | ((135689)\-([0-9]){2}([a-zA-Z0-9]){1}\.([a-zA-Z0-9]{1,2}))*(:[RLBrlb])? | | | | | | |
| source | <pre><element name="PAK_ProzedurenSchluessel" type="OPS"/></pre> | | | | | | |

complexType **FailureGrundAortenklappeBasis**

| | |
|-----------|---|
| diagram | |
| namespace | http://xml.ir-d.de/emg |
| children | FAK_FailureGrundSchluessel |
| used by | element OperationAortenklappe/failureGrundAortenklappe |
| source | <pre><complexType name="FailureGrundAortenklappeBasis"> <sequence> <element name="FAK_FailureGrundSchluessel" type="enum_0341"/> </sequence> </complexType></pre> |

element **FailureGrundAortenklappeBasis/FAK_FailureGrundSchluessel**

| | |
|---------|--|
| diagram | |
|---------|--|

| | | | |
|------------|--|---------|--|
| type | enum 0341 | | |
| properties | content simple | | |
| facets | Kind | Value | Annotation |
| | enumeration | 0341001 | documentation intraprozedural verstorben |
| | enumeration | 0341002 | documentation Implantation von mehr als einer Prothese |
| | enumeration | 0341003 | documentation gravierende Gefäß- oder Zugangskomplikation (gemäß VARC-3) |
| | enumeration | 0341004 | documentation erforderlicher chirurgischer oder interventioneller Eingriff wegen einer Klappenfehlfunktion (gemäß VARC-3) |
| | enumeration | 0341005 | documentation >= große strukturelle kardiale Komplikation (gemäß VARC-3) |
| source | <code><element name="FAK_FailureGrundSchluessel" type="enum_0341"/></code> | | |

complexType **PciAortenklappeBasis**

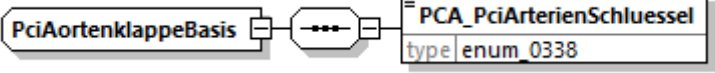
| | |
|-----------|---|
| diagram |  |
| namespace | http://xml.ir-d.de/emg |
| children | PCA_PciArterienSchluessel |
| used by | element OperationAortenklappe/pciAortenklappe |
| source | <code><complexType name="PciAortenklappeBasis"> <sequence> <element name="PCA_PciArterienSchluessel" type="enum_0338"/> </sequence> </complexType></code> |

element **PciAortenklappeBasis/PCA_PciArterienSchluessel**

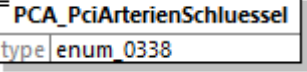
| | | | |
|------------|---|---------|-----------------------------|
| diagram |  | | |
| type | enum 0338 | | |
| properties | content simple | | |
| facets | Kind | Value | Annotation |
| | enumeration | 0338001 | documentation LAD |
| | enumeration | 0338002 | documentation RCA |
| | enumeration | 0338003 | documentation RCX |
| | enumeration | 0338004 | documentation Hauptstamm |
| source | <code><element name="PCA_PciArterienSchluessel" type="enum_0338"/></code> | | |

complexType **KomplikationAortenklappeBasis**

| | |
|-----------|--|
| diagram | |
| namespace | http://xml.ir-d.de/emg |
| children | KAK_KomplikationTypSchluessel |
| used by | element OperationAortenklappe/komplikationAortenklappe |
| source | <pre><complexType name="KomplikationAortenklappeBasis"> <sequence> <element name="KAK_KomplikationTypSchluessel" type="enum_0343"/> </sequence> </complexType></pre> |

element **KomplikationAortenklappeBasis/KAK_KomplikationTypSchluessel**

| diagram | | | | | | | | | | | | | | | | | | | | | | | | | | | | | | | | | | | | | | | | | | | | | | | | | | | | | | | | | | |
|-------------|---|--|-------|------------|-------------|---------|--|-------------|---------|--|-------------|---------|-----------------------------------|-------------|---------|---|-------------|---------|---------------------------------|-------------|---------|--|-------------|---------|---|-------------|---------|------------------------------------|-------------|---------|--|-------------|---------|------------------------------|-------------|---------|------------------------------------|-------------|---------|--------------------------------------|-------------|---------|---|-------------|---------|-------------------------------------|-------------|---------|---|-------------|---------|--|-------------|---------|---|-------------|---------|---------------|
| type | enum 0343 | | | | | | | | | | | | | | | | | | | | | | | | | | | | | | | | | | | | | | | | | | | | | | | | | | | | | | | | | |
| properties | content simple | | | | | | | | | | | | | | | | | | | | | | | | | | | | | | | | | | | | | | | | | | | | | | | | | | | | | | | | | |
| facets | <table border="1"> <thead> <tr> <th>Kind</th> <th>Value</th> <th>Annotation</th> </tr> </thead> <tbody> <tr> <td>enumeration</td> <td>0343001</td> <td>documentation Device-Fehlpositionierung</td> </tr> <tr> <td>enumeration</td> <td>0343002</td> <td>documentation Koronarostienverschluss</td> </tr> <tr> <td>enumeration</td> <td>0343003</td> <td>documentation Aortendissektion</td> </tr> <tr> <td>enumeration</td> <td>0343004</td> <td>documentation Aortenregurgitation &gt; = 2. Grades</td> </tr> <tr> <td>enumeration</td> <td>0343005</td> <td>documentation Annulus-Ruptur</td> </tr> <tr> <td>enumeration</td> <td>0343006</td> <td>documentation Ruptur-/Perforation einer Herzhöhle ohne Therapiebedarf</td> </tr> <tr> <td>enumeration</td> <td>0343007</td> <td>documentation Ruptur-/Perforation einer Herzhöhle mit Therapiebedarf</td> </tr> <tr> <td>enumeration</td> <td>0343008</td> <td>documentation Perikardtamponade</td> </tr> <tr> <td>enumeration</td> <td>0343009</td> <td>documentation kardiale Dekompensation</td> </tr> <tr> <td>enumeration</td> <td>0343010</td> <td>documentation Hirnembolie</td> </tr> <tr> <td>enumeration</td> <td>0343011</td> <td>documentation Rhythmusstörungen</td> </tr> <tr> <td>enumeration</td> <td>0343012</td> <td>documentation Device-Embolisation</td> </tr> <tr> <td>enumeration</td> <td>0343013</td> <td>documentation vaskuläre Komplikation</td> </tr> <tr> <td>enumeration</td> <td>0343014</td> <td>documentation Low Cardiac Output</td> </tr> <tr> <td>enumeration</td> <td>0343015</td> <td>documentation schwerwiegende Blutungen (intraprozedural)</td> </tr> <tr> <td>enumeration</td> <td>0343016</td> <td>documentation lebensbedrohliche Blutungen (intraprozedural)</td> </tr> <tr> <td>enumeration</td> <td>0343017</td> <td>documentation Patient verstarb im OP/Katheterlabor</td> </tr> <tr> <td>enumeration</td> <td>0343042</td> <td>documentation</td> </tr> </tbody> </table> | Kind | Value | Annotation | enumeration | 0343001 | documentation Device-Fehlpositionierung | enumeration | 0343002 | documentation Koronarostienverschluss | enumeration | 0343003 | documentation Aortendissektion | enumeration | 0343004 | documentation Aortenregurgitation > = 2. Grades | enumeration | 0343005 | documentation Annulus-Ruptur | enumeration | 0343006 | documentation Ruptur-/Perforation einer Herzhöhle ohne Therapiebedarf | enumeration | 0343007 | documentation Ruptur-/Perforation einer Herzhöhle mit Therapiebedarf | enumeration | 0343008 | documentation Perikardtamponade | enumeration | 0343009 | documentation kardiale Dekompensation | enumeration | 0343010 | documentation Hirnembolie | enumeration | 0343011 | documentation Rhythmusstörungen | enumeration | 0343012 | documentation Device-Embolisation | enumeration | 0343013 | documentation vaskuläre Komplikation | enumeration | 0343014 | documentation Low Cardiac Output | enumeration | 0343015 | documentation schwerwiegende Blutungen (intraprozedural) | enumeration | 0343016 | documentation lebensbedrohliche Blutungen (intraprozedural) | enumeration | 0343017 | documentation Patient verstarb im OP/Katheterlabor | enumeration | 0343042 | documentation |
| Kind | Value | Annotation | | | | | | | | | | | | | | | | | | | | | | | | | | | | | | | | | | | | | | | | | | | | | | | | | | | | | | | | |
| enumeration | 0343001 | documentation Device-Fehlpositionierung | | | | | | | | | | | | | | | | | | | | | | | | | | | | | | | | | | | | | | | | | | | | | | | | | | | | | | | | |
| enumeration | 0343002 | documentation Koronarostienverschluss | | | | | | | | | | | | | | | | | | | | | | | | | | | | | | | | | | | | | | | | | | | | | | | | | | | | | | | | |
| enumeration | 0343003 | documentation Aortendissektion | | | | | | | | | | | | | | | | | | | | | | | | | | | | | | | | | | | | | | | | | | | | | | | | | | | | | | | | |
| enumeration | 0343004 | documentation Aortenregurgitation > = 2. Grades | | | | | | | | | | | | | | | | | | | | | | | | | | | | | | | | | | | | | | | | | | | | | | | | | | | | | | | | |
| enumeration | 0343005 | documentation Annulus-Ruptur | | | | | | | | | | | | | | | | | | | | | | | | | | | | | | | | | | | | | | | | | | | | | | | | | | | | | | | | |
| enumeration | 0343006 | documentation Ruptur-/Perforation einer Herzhöhle ohne Therapiebedarf | | | | | | | | | | | | | | | | | | | | | | | | | | | | | | | | | | | | | | | | | | | | | | | | | | | | | | | | |
| enumeration | 0343007 | documentation Ruptur-/Perforation einer Herzhöhle mit Therapiebedarf | | | | | | | | | | | | | | | | | | | | | | | | | | | | | | | | | | | | | | | | | | | | | | | | | | | | | | | | |
| enumeration | 0343008 | documentation Perikardtamponade | | | | | | | | | | | | | | | | | | | | | | | | | | | | | | | | | | | | | | | | | | | | | | | | | | | | | | | | |
| enumeration | 0343009 | documentation kardiale Dekompensation | | | | | | | | | | | | | | | | | | | | | | | | | | | | | | | | | | | | | | | | | | | | | | | | | | | | | | | | |
| enumeration | 0343010 | documentation Hirnembolie | | | | | | | | | | | | | | | | | | | | | | | | | | | | | | | | | | | | | | | | | | | | | | | | | | | | | | | | |
| enumeration | 0343011 | documentation Rhythmusstörungen | | | | | | | | | | | | | | | | | | | | | | | | | | | | | | | | | | | | | | | | | | | | | | | | | | | | | | | | |
| enumeration | 0343012 | documentation Device-Embolisation | | | | | | | | | | | | | | | | | | | | | | | | | | | | | | | | | | | | | | | | | | | | | | | | | | | | | | | | |
| enumeration | 0343013 | documentation vaskuläre Komplikation | | | | | | | | | | | | | | | | | | | | | | | | | | | | | | | | | | | | | | | | | | | | | | | | | | | | | | | | |
| enumeration | 0343014 | documentation Low Cardiac Output | | | | | | | | | | | | | | | | | | | | | | | | | | | | | | | | | | | | | | | | | | | | | | | | | | | | | | | | |
| enumeration | 0343015 | documentation schwerwiegende Blutungen (intraprozedural) | | | | | | | | | | | | | | | | | | | | | | | | | | | | | | | | | | | | | | | | | | | | | | | | | | | | | | | | |
| enumeration | 0343016 | documentation lebensbedrohliche Blutungen (intraprozedural) | | | | | | | | | | | | | | | | | | | | | | | | | | | | | | | | | | | | | | | | | | | | | | | | | | | | | | | | |
| enumeration | 0343017 | documentation Patient verstarb im OP/Katheterlabor | | | | | | | | | | | | | | | | | | | | | | | | | | | | | | | | | | | | | | | | | | | | | | | | | | | | | | | | |
| enumeration | 0343042 | documentation | | | | | | | | | | | | | | | | | | | | | | | | | | | | | | | | | | | | | | | | | | | | | | | | | | | | | | | | |

sonstige intraprozedurale Komplikationen

source `<element name="KAK_KomplikationTypSchluessel" type="enum_0343"/>`

complexType **ArtikelidentifikationBasis**

diagram

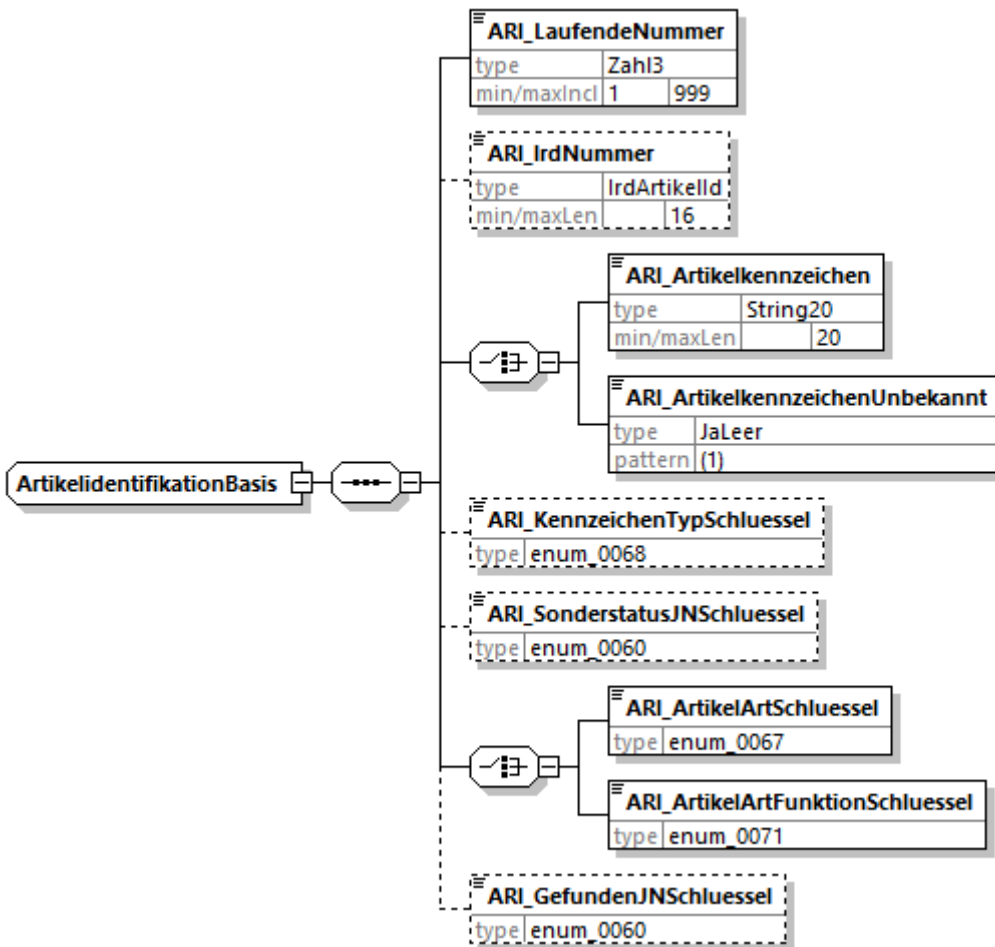

namespace `http://xml.ir-d.de/emg`

children [ARI LaufendeNumber](#) [ARI IrdNumber](#) [ARI Artikelkennzeichen](#) [ARI ArtikelkennzeichenUnbekannt](#) [ARI KennzeichenTypSchluessel](#) [ARI SonderstatusJNSchluessel](#) [ARI ArtikelArtSchluessel](#) [ARI ArtikelArtFunktionSchluessel](#) [ARI GefundenJNSchluessel](#)

used by complexType [Artikelidentifikation](#)

```
<complexType name="ArtikelidentifikationBasis">
  <sequence>
    <element name="ARI_LaufendeNumber" type="Zahl3"/>
    <element name="ARI_IrdNumber" type="IrdArtikelId" minOccurs="0"/>
    <choice>
      <element name="ARI_Artikelkennzeichen" type="String20"/>
      <element name="ARI_ArtikelkennzeichenUnbekannt" type="JaLeer"/>
    </choice>
    <element name="ARI_KennzeichenTypSchluessel" type="enum_0068"
minOccurs="0"/>
    <element name="ARI_SonderstatusJNSchluessel" type="enum_0060"
minOccurs="0"/>
    <choice>
      <element name="ARI_ArtikelArtSchluessel" type="enum_0067"/>
```

```

<element name="ARI_ArtikelArtFunktionSchluessel" type="enum_0071"/>
</choice>
<element name="ARI_GefundenJNSchluessel" type="enum_0060" minOccurs="0"/>
</sequence>
</complexType>

```

element ArtikelidentifikationBasis/ARI_LaufendeNummer

| diagram | <pre> classDiagram class ARI_LaufendeNummer { type Zahl3 min/maxIncl 1 999 } </pre> | | | | | | | | | |
|--------------|---|------------|-------|------------|--------------|---|--|--------------|-----|--|
| type | Zahl3 | | | | | | | | | |
| properties | content simple | | | | | | | | | |
| facets | <table border="1"> <thead> <tr> <th>Kind</th> <th>Value</th> <th>Annotation</th> </tr> </thead> <tbody> <tr> <td>minInclusive</td> <td>1</td> <td></td> </tr> <tr> <td>maxInclusive</td> <td>999</td> <td></td> </tr> </tbody> </table> | Kind | Value | Annotation | minInclusive | 1 | | maxInclusive | 999 | |
| Kind | Value | Annotation | | | | | | | | |
| minInclusive | 1 | | | | | | | | | |
| maxInclusive | 999 | | | | | | | | | |
| source | <code><element name="ARI_LaufendeNummer" type="Zahl3"/></code> | | | | | | | | | |

element ArtikelidentifikationBasis/ARI_IrdNummer

| diagram | <pre> classDiagram class ARI_IrdNummer { type IrdArtikelId min/maxLen 16 } </pre> | | | | | | |
|------------|---|------------|-------|------------|-----------|----|--|
| type | IrdArtikelId | | | | | | |
| properties | minOcc 0 maxOcc 1 content simple | | | | | | |
| facets | <table border="1"> <thead> <tr> <th>Kind</th> <th>Value</th> <th>Annotation</th> </tr> </thead> <tbody> <tr> <td>maxLength</td> <td>16</td> <td></td> </tr> </tbody> </table> | Kind | Value | Annotation | maxLength | 16 | |
| Kind | Value | Annotation | | | | | |
| maxLength | 16 | | | | | | |
| source | <code><element name="ARI_IrdNummer" type="IrdArtikelId" minOccurs="0"/></code> | | | | | | |

element ArtikelidentifikationBasis/ARI_Artikelkennzeichen

| diagram | <pre> classDiagram class ARI_Artikelkennzeichen { type String20 min/maxLen 20 } </pre> | | | | | | |
|------------|---|------------|-------|------------|-----------|----|--|
| type | String20 | | | | | | |
| properties | content simple | | | | | | |
| facets | <table border="1"> <thead> <tr> <th>Kind</th> <th>Value</th> <th>Annotation</th> </tr> </thead> <tbody> <tr> <td>maxLength</td> <td>20</td> <td></td> </tr> </tbody> </table> | Kind | Value | Annotation | maxLength | 20 | |
| Kind | Value | Annotation | | | | | |
| maxLength | 20 | | | | | | |
| source | <code><element name="ARI_Artikelkennzeichen" type="String20"/></code> | | | | | | |

element **ArtikelidentifikationBasis/ARI_ArtikelkennzeichenUnbekannt**

| diagram | | | | | | | |
|------------|--|------------|-------|------------|---------|-----|--|
| type | JaLeer | | | | | | |
| properties | content simple | | | | | | |
| facets | <table border="1"> <thead> <tr> <th>Kind</th> <th>Value</th> <th>Annotation</th> </tr> </thead> <tbody> <tr> <td>pattern</td> <td>(1)</td> <td></td> </tr> </tbody> </table> | Kind | Value | Annotation | pattern | (1) | |
| Kind | Value | Annotation | | | | | |
| pattern | (1) | | | | | | |
| source | <code><element name="ARI_ArtikelkennzeichenUnbekannt" type="JaLeer"/></code> | | | | | | |

element **ArtikelidentifikationBasis/ARI_KennzeichenTypSchluessel**

| diagram | | | | | | | | | | | | | | | | |
|-------------|--|---------------------------------|-------|------------|-------------|---------|----------------------|-------------|---------|---------------------------------|-------------|---------|--------------------------------|-------------|---------|----------------------------|
| type | enum 0068 | | | | | | | | | | | | | | | |
| properties | <table border="1"> <tbody> <tr> <td>minOcc</td> <td>0</td> </tr> <tr> <td>maxOcc</td> <td>1</td> </tr> <tr> <td>content</td> <td>simple</td> </tr> </tbody> </table> | minOcc | 0 | maxOcc | 1 | content | simple | | | | | | | | | |
| minOcc | 0 | | | | | | | | | | | | | | | |
| maxOcc | 1 | | | | | | | | | | | | | | | |
| content | simple | | | | | | | | | | | | | | | |
| facets | <table border="1"> <thead> <tr> <th>Kind</th> <th>Value</th> <th>Annotation</th> </tr> </thead> <tbody> <tr> <td>enumeration</td> <td>0068001</td> <td>documentation UDI</td> </tr> <tr> <td>enumeration</td> <td>0068002</td> <td>documentation Referenz (REF)</td> </tr> <tr> <td>enumeration</td> <td>0068003</td> <td>documentation Katalognummer</td> </tr> <tr> <td>enumeration</td> <td>0068042</td> <td>documentation sonstiger</td> </tr> </tbody> </table> | Kind | Value | Annotation | enumeration | 0068001 | documentation UDI | enumeration | 0068002 | documentation Referenz (REF) | enumeration | 0068003 | documentation Katalognummer | enumeration | 0068042 | documentation sonstiger |
| Kind | Value | Annotation | | | | | | | | | | | | | | |
| enumeration | 0068001 | documentation UDI | | | | | | | | | | | | | | |
| enumeration | 0068002 | documentation Referenz (REF) | | | | | | | | | | | | | | |
| enumeration | 0068003 | documentation Katalognummer | | | | | | | | | | | | | | |
| enumeration | 0068042 | documentation sonstiger | | | | | | | | | | | | | | |
| source | <code><element name="ARI_KennzeichenTypSchluessel" type="enum_0068" minOccurs="0"/></code> | | | | | | | | | | | | | | | |

element **ArtikelidentifikationBasis/ARI_SonderstatusJNSchluessel**

| diagram | | | | | | | | | | |
|-------------|---|-----------------------|-------|------------|-------------|---------|---------------------|-------------|---------|-----------------------|
| type | enum 0060 | | | | | | | | | |
| properties | <table border="1"> <tbody> <tr> <td>minOcc</td> <td>0</td> </tr> <tr> <td>maxOcc</td> <td>1</td> </tr> <tr> <td>content</td> <td>simple</td> </tr> </tbody> </table> | minOcc | 0 | maxOcc | 1 | content | simple | | | |
| minOcc | 0 | | | | | | | | | |
| maxOcc | 1 | | | | | | | | | |
| content | simple | | | | | | | | | |
| facets | <table border="1"> <thead> <tr> <th>Kind</th> <th>Value</th> <th>Annotation</th> </tr> </thead> <tbody> <tr> <td>enumeration</td> <td>0060001</td> <td>documentation ja</td> </tr> <tr> <td>enumeration</td> <td>0060002</td> <td>documentation nein</td> </tr> </tbody> </table> | Kind | Value | Annotation | enumeration | 0060001 | documentation ja | enumeration | 0060002 | documentation nein |
| Kind | Value | Annotation | | | | | | | | |
| enumeration | 0060001 | documentation ja | | | | | | | | |
| enumeration | 0060002 | documentation nein | | | | | | | | |
| source | <code><element name="ARI_SonderstatusJNSchluessel" type="enum_0060" minOccurs="0"/></code> | | | | | | | | | |

element **ArtikelidentifikationBasis/ARI_ArtikelArtSchluessel**

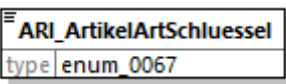
| diagram |  | | | | | | | | | |
|-------------|---|----------------------------|-------|------------|-------------|---------|----------------------------|-------------|---------|----------------------------|
| type | enum 0067 | | | | | | | | | |
| properties | content simple | | | | | | | | | |
| facets | <table border="1"> <thead> <tr> <th>Kind</th> <th>Value</th> <th>Annotation</th> </tr> </thead> <tbody> <tr> <td>enumeration</td> <td>0067001</td> <td>documentation Implantat</td> </tr> <tr> <td>enumeration</td> <td>0067002</td> <td>documentation Explantat</td> </tr> </tbody> </table> | Kind | Value | Annotation | enumeration | 0067001 | documentation Implantat | enumeration | 0067002 | documentation Explantat |
| Kind | Value | Annotation | | | | | | | | |
| enumeration | 0067001 | documentation Implantat | | | | | | | | |
| enumeration | 0067002 | documentation Explantat | | | | | | | | |
| source | <code><element name="ARI_ArtikelArtSchluessel" type="enum_0067"/></code> | | | | | | | | | |

element **ArtikelidentifikationBasis/ARI_ArtikelArtFunktionSchluessel**

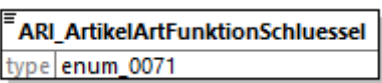
| diagram |  | | | | | | | | | | | | |
|-------------|--|---|-------|------------|-------------|---------|----------------------------|-------------|---------|----------------------------|-------------|---------|---|
| type | enum 0071 | | | | | | | | | | | | |
| properties | content simple | | | | | | | | | | | | |
| facets | <table border="1"> <thead> <tr> <th>Kind</th> <th>Value</th> <th>Annotation</th> </tr> </thead> <tbody> <tr> <td>enumeration</td> <td>0071001</td> <td>documentation Implantat</td> </tr> <tr> <td>enumeration</td> <td>0071002</td> <td>documentation Explantat</td> </tr> <tr> <td>enumeration</td> <td>0071003</td> <td>documentation Degeneriertes/defektes Produkt, das funktionslos im Körper verbleibt</td> </tr> </tbody> </table> | Kind | Value | Annotation | enumeration | 0071001 | documentation Implantat | enumeration | 0071002 | documentation Explantat | enumeration | 0071003 | documentation Degeneriertes/defektes Produkt, das funktionslos im Körper verbleibt |
| Kind | Value | Annotation | | | | | | | | | | | |
| enumeration | 0071001 | documentation Implantat | | | | | | | | | | | |
| enumeration | 0071002 | documentation Explantat | | | | | | | | | | | |
| enumeration | 0071003 | documentation Degeneriertes/defektes Produkt, das funktionslos im Körper verbleibt | | | | | | | | | | | |
| source | <code><element name="ARI_ArtikelArtFunktionSchluessel" type="enum_0071"/></code> | | | | | | | | | | | | |

element **ArtikelidentifikationBasis/ARI_GefundenJNSchluessel**

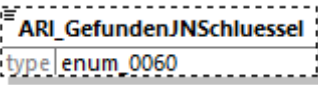
| diagram |  | | | | | | | | | |
|-------------|---|-----------------------|-------|------------|-------------|---------|---------------------|-------------|---------|-----------------------|
| type | enum 0060 | | | | | | | | | |
| properties | <table border="1"> <tr> <td>minOcc</td> <td>0</td> </tr> <tr> <td>maxOcc</td> <td>1</td> </tr> <tr> <td>content</td> <td>simple</td> </tr> </table> | minOcc | 0 | maxOcc | 1 | content | simple | | | |
| minOcc | 0 | | | | | | | | | |
| maxOcc | 1 | | | | | | | | | |
| content | simple | | | | | | | | | |
| facets | <table border="1"> <thead> <tr> <th>Kind</th> <th>Value</th> <th>Annotation</th> </tr> </thead> <tbody> <tr> <td>enumeration</td> <td>0060001</td> <td>documentation ja</td> </tr> <tr> <td>enumeration</td> <td>0060002</td> <td>documentation nein</td> </tr> </tbody> </table> | Kind | Value | Annotation | enumeration | 0060001 | documentation ja | enumeration | 0060002 | documentation nein |
| Kind | Value | Annotation | | | | | | | | |
| enumeration | 0060001 | documentation ja | | | | | | | | |
| enumeration | 0060002 | documentation nein | | | | | | | | |
| source | <code><element name="ARI_GefundenJNSchluessel" type="enum_0060" minOccurs="0"/></code> | | | | | | | | | |

complexType Artikelbeschreibung

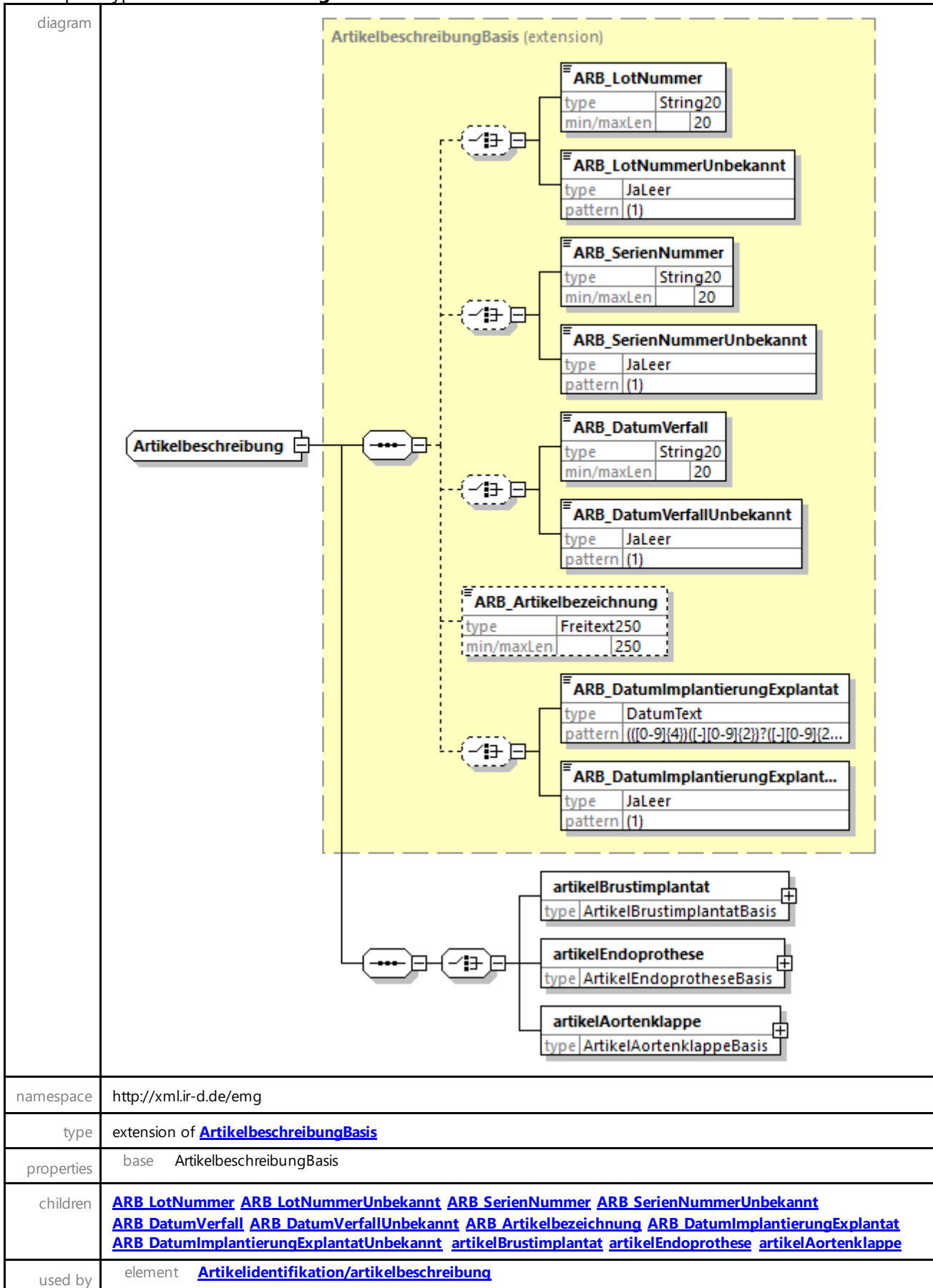

source

```
<complexType name="Artikelbeschreibung">
  <complexContent>
    <extension base="ArtikelbeschreibungBasis">
      <sequence>
        <choice>
          <element name="artikelBrustimplantat"
type="ArtikelBrustimplantatBasis"/>
          <element name="artikelEndoprothese"
type="ArtikelEndoprotheseBasis"/>
          <element name="artikelAortenklappe"
type="ArtikelAortenklappeBasis"/>
        </choice>
      </sequence>
    </extension>
  </complexContent>
</complexType>
```

element **Artikelbeschreibung/artikelBrustimplantat**

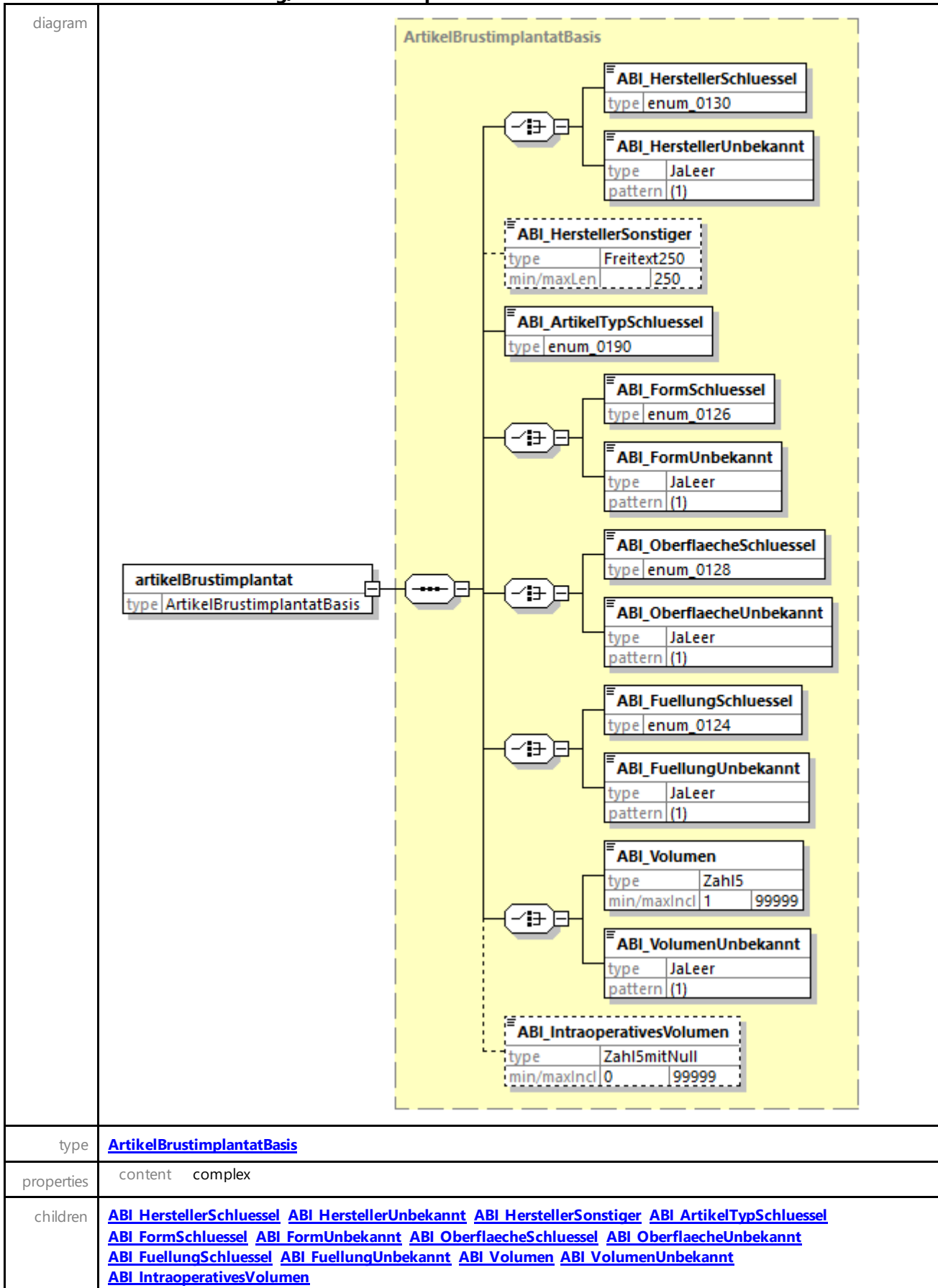

| | |
|--------|---|
| source | <element name="artikelBrustimplantat" type="ArtikelBrustimplantatBasis"/> |
|--------|---|

element **Artikelbeschreibung/artikelEndoprothese**

| | |
|------------|--|
| diagram | <p>The diagram illustrates the structure of the 'artikelEndoprothese' element. It is a simple type of 'ArtikelEndoprotheseBasis'. 'ArtikelEndoprotheseBasis' is a complex type containing four elements: 'AEP_HerstellerSchluessel' (enum_0230), 'AEP_HerstellerUnbekannt' (JaLeer, pattern (1)), 'AEP_HerstellerSonstiger' (Freitext250, min/maxLen 250), and 'AEP_ArtikelTypSchluessel' (enum_0290).</p> |
| type | ArtikelEndoprotheseBasis |
| properties | content complex |
| children | AEP_HerstellerSchluessel AEP_HerstellerUnbekannt AEP_HerstellerSonstiger AEP_ArtikelTypSchluessel |
| source | <element name="artikelEndoprothese" type="ArtikelEndoprotheseBasis"/> |

element **Artikelbeschreibung/artikelAortenklappe**

| | |
|-------------------|---|
| <p>diagram</p> | |
| <p>type</p> | <p>ArtikelAortenklappeBasis</p> |
| <p>properties</p> | <p>content complex</p> |
| <p>children</p> | <p>AAK ArtikelTypSchluessel AAK HerstellerSchluessel AAK HerstellerUnbekannt AAK HerstellerSonstiger AAK ProthesenGroesse AAK ProthesenGroesseUnbekannt AAK Dislokation</p> |
| <p>source</p> | <p><code><element name="artikelAortenklappe" type="ArtikelAortenklappeBasis"/></code></p> |

complexType **ZubehoerBasis**

| | |
|------------------|--|
| <p>diagram</p> | |
| <p>namespace</p> | <p>http://xml.ir-d.de/emg</p> |
| <p>children</p> | <p>ZUB LaufendeNummer ZUB ZubehoerArtSchluessel ZUB ArtikelNummer ZUB ArtikelNummerUnbekannt ZUB LotNummer ZUB LotNummerUnbekannt ZUB SerienNummer ZUB SerienNummerUnbekannt ZUB Artikelbezeichnung</p> |
| <p>used by</p> | <p>complexType Zubehoer</p> |
| <p>source</p> | <pre><complexType name="ZubehoerBasis"> <sequence> <element name="ZUB_LaufendeNummer" type="Zahl3"/> <element name="ZUB_ZubehoerArtSchluessel" type="enum_0069"/> <choice> <element name="ZUB_ArtikelNummer" type="String20"/> <element name="ZUB_ArtikelNummerUnbekannt" type="JaLeer"/> </choice> <choice minOccurs="0"> <element name="ZUB_LotNummer" type="String20"/> <element name="ZUB_LotNummerUnbekannt" type="JaLeer"/> </choice> <choice minOccurs="0"> <element name="ZUB_SerienNummer" type="String20"/> <element name="ZUB_SerienNummerUnbekannt" type="JaLeer"/> </choice> </sequence> </complexType></pre> |

| | |
|--|---|
| | <pre><element name="ZUB_Artikelbezeichnung" type="Freitext250" minOccurs="0"/> </sequence> </complexType></pre> |
|--|---|

element **ZubehoerBasis/ZUB_LaufendeNummer**

| diagram | | | | | | | | | | |
|--------------|---|------------|-------|------------|--------------|---|--|--------------|-----|--|
| type | Zahl3 | | | | | | | | | |
| properties | content simple | | | | | | | | | |
| facets | <table border="1"> <thead> <tr> <th>Kind</th> <th>Value</th> <th>Annotation</th> </tr> </thead> <tbody> <tr> <td>minInclusive</td> <td>1</td> <td></td> </tr> <tr> <td>maxInclusive</td> <td>999</td> <td></td> </tr> </tbody> </table> | Kind | Value | Annotation | minInclusive | 1 | | maxInclusive | 999 | |
| Kind | Value | Annotation | | | | | | | | |
| minInclusive | 1 | | | | | | | | | |
| maxInclusive | 999 | | | | | | | | | |
| source | <pre><element name="ZUB_LaufendeNummer" type="Zahl3"/></pre> | | | | | | | | | |

element **ZubehoerBasis/ZUB_ZubehoerArtSchluessel**

| diagram | | | | | | | | | | |
|-------------|---|----------------------------|-------|------------|-------------|---------|----------------------------|-------------|---------|----------------------------|
| type | enum_0069 | | | | | | | | | |
| properties | content simple | | | | | | | | | |
| facets | <table border="1"> <thead> <tr> <th>Kind</th> <th>Value</th> <th>Annotation</th> </tr> </thead> <tbody> <tr> <td>enumeration</td> <td>0069001</td> <td>documentation Implantat</td> </tr> <tr> <td>enumeration</td> <td>0069002</td> <td>documentation Explantat</td> </tr> </tbody> </table> | Kind | Value | Annotation | enumeration | 0069001 | documentation Implantat | enumeration | 0069002 | documentation Explantat |
| Kind | Value | Annotation | | | | | | | | |
| enumeration | 0069001 | documentation Implantat | | | | | | | | |
| enumeration | 0069002 | documentation Explantat | | | | | | | | |
| source | <pre><element name="ZUB_ZubehoerArtSchluessel" type="enum_0069"/></pre> | | | | | | | | | |

element **ZubehoerBasis/ZUB_ArtikelNummer**

| diagram | | | | | | | |
|------------|---|------------|-------|------------|-----------|----|--|
| type | String20 | | | | | | |
| properties | content simple | | | | | | |
| facets | <table border="1"> <thead> <tr> <th>Kind</th> <th>Value</th> <th>Annotation</th> </tr> </thead> <tbody> <tr> <td>maxLength</td> <td>20</td> <td></td> </tr> </tbody> </table> | Kind | Value | Annotation | maxLength | 20 | |
| Kind | Value | Annotation | | | | | |
| maxLength | 20 | | | | | | |
| source | <pre><element name="ZUB_ArtikelNummer" type="String20"/></pre> | | | | | | |

element **ZubehoerBasis/ZUB_ArtikelNummerUnbekannt**

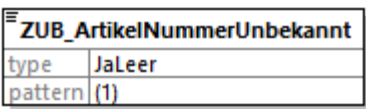
| | |
|------------|---|
| diagram |  |
| type | JaLeer |
| properties | content simple |
| facets | Kind Value Annotation pattern (1) |
| source | <code><element name="ZUB_ArtikelNummerUnbekannt" type="JaLeer"/></code> |

element **ZubehoerBasis/ZUB_LotNummer**

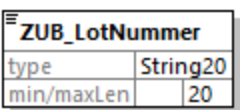
| | |
|------------|---|
| diagram |  |
| type | String20 |
| properties | content simple |
| facets | Kind Value Annotation maxLength 20 |
| source | <code><element name="ZUB_LotNummer" type="String20"/></code> |

element **ZubehoerBasis/ZUB_LotNummerUnbekannt**

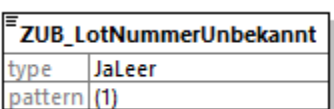
| | |
|------------|---|
| diagram |  |
| type | JaLeer |
| properties | content simple |
| facets | Kind Value Annotation pattern (1) |
| source | <code><element name="ZUB_LotNummerUnbekannt" type="JaLeer"/></code> |

element **ZubehoerBasis/ZUB_SerienNummer**

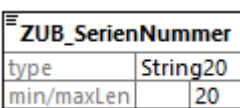
| | |
|------------|---|
| diagram |  |
| type | String20 |
| properties | content simple |
| facets | Kind Value Annotation maxLength 20 |
| source | <code><element name="ZUB_SerienNummer" type="String20"/></code> |

element **ZubehoerBasis/ZUB_SerienNummerUnbekannt**

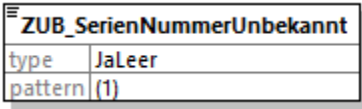
| diagram |  | | | | | | |
|------------|--|------------|-------|------------|---------|-----|--|
| type | JaLeer | | | | | | |
| properties | content simple | | | | | | |
| facets | <table border="1"> <thead> <tr> <th>Kind</th> <th>Value</th> <th>Annotation</th> </tr> </thead> <tbody> <tr> <td>pattern</td> <td>(1)</td> <td></td> </tr> </tbody> </table> | Kind | Value | Annotation | pattern | (1) | |
| Kind | Value | Annotation | | | | | |
| pattern | (1) | | | | | | |
| source | <code><element name="ZUB_SerienNummerUnbekannt" type="JaLeer"/></code> | | | | | | |

element **ZubehoerBasis/ZUB_Artikelbezeichnung**

| diagram |  | | | | | | |
|------------|--|------------|-------|------------|-----------|---------|--------|
| type | Freitext250 | | | | | | |
| properties | <table border="1"> <tbody> <tr> <td>minOcc</td> <td>0</td> </tr> <tr> <td>maxOcc</td> <td>1</td> </tr> <tr> <td>content</td> <td>simple</td> </tr> </tbody> </table> | minOcc | 0 | maxOcc | 1 | content | simple |
| minOcc | 0 | | | | | | |
| maxOcc | 1 | | | | | | |
| content | simple | | | | | | |
| facets | <table border="1"> <thead> <tr> <th>Kind</th> <th>Value</th> <th>Annotation</th> </tr> </thead> <tbody> <tr> <td>maxLength</td> <td>250</td> <td></td> </tr> </tbody> </table> | Kind | Value | Annotation | maxLength | 250 | |
| Kind | Value | Annotation | | | | | |
| maxLength | 250 | | | | | | |
| source | <code><element name="ZUB_Artikelbezeichnung" type="Freitext250" minOccurs="0"/></code> | | | | | | |

complexType **ZubehoerBrustimplantatBasis**

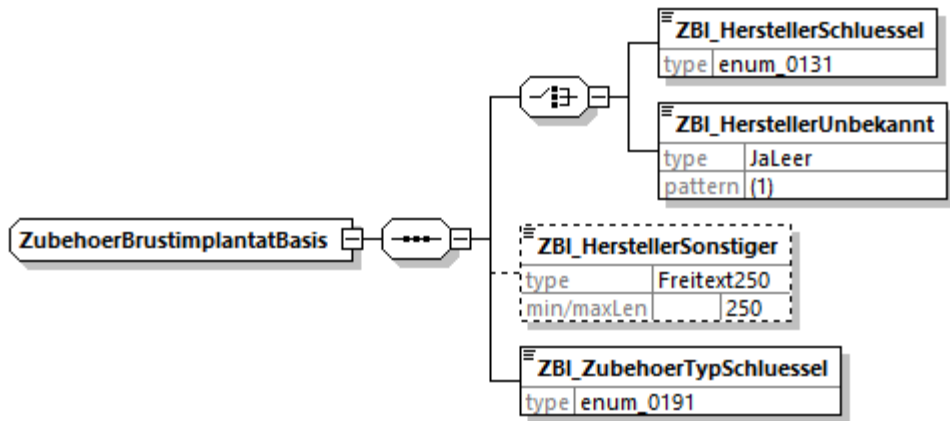
| | |
|-----------|---|
| diagram |  |
| namespace | http://xml.ir-d.de/emg |
| children | ZBI_HerstellerSchluessel ZBI_HerstellerUnbekannt ZBI_HerstellerSonstiger ZBI_ZubehoerTypSchluessel |
| used by | element Zubehoer/zubehoerBrustimplantat |
| source | <pre> <complexType name="ZubehoerBrustimplantatBasis"> <sequence> <choice> <element name="ZBI_HerstellerSchluessel" type="enum_0131"/> </pre> |

```

<element name="ZBI_HerstellerUnbekannt" type="JaLeer"/>
</choice>
<element name="ZBI_HerstellerSonstiger" type="Freitext250" minOccurs="0"/>
<element name="ZBI_ZubehoerTypSchluessel" type="enum_0191"/>
</sequence>
</complexType>

```

element **ZubehoerBrustimplantatBasis/ZBI_HerstellerSchluessel**

| | | | |
|------------|---|---------|---|
| diagram |  | | |
| type | enum 0131 | | |
| properties | content simple | | |
| facets | Kind | Value | Annotation |
| | enumeration | 0131001 | documentation Allergan |
| | enumeration | 0131002 | documentation Establishment labs |
| | enumeration | 0131003 | documentation Eurosilicone |
| | enumeration | 0131004 | documentation Galatea |
| | enumeration | 0131005 | documentation Integra |
| | enumeration | 0131006 | documentation Lifecell |
| | enumeration | 0131007 | documentation MBP (Medical Biomaterial Products) |
| | enumeration | 0131008 | documentation Mentor |
| | enumeration | 0131009 | documentation Novus Scientific |
| | enumeration | 0131042 | documentation sonstiger |
| source | <code><element name="ZBI_HerstellerSchluessel" type="enum_0131"/></code> | | |

element **ZubehoerBrustimplantatBasis/ZBI_HerstellerUnbekannt**

| | | | |
|------------|---|-------|------------|
| diagram |  | | |
| type | JaLeer | | |
| properties | content simple | | |
| facets | Kind | Value | Annotation |
| | pattern | (1) | |
| source | <code><element name="ZBI_HerstellerUnbekannt" type="JaLeer"/></code> | | |

element **ZubehoerBrustimplantatBasis/ZBI_HerstellerSonstiger**

| | |
|------------|---|
| diagram | |
| type | Freitext250 |
| properties | minOcc 0 maxOcc 1 content simple |
| facets | Kind Value Annotation maxLength 250 |
| source | <code><element name="ZBI_HerstellerSonstiger" type="Freitext250" minOccurs="0"/></code> |

element **ZubehoerBrustimplantatBasis/ZBI_ZubehoerTypSchluessel**

| | |
|------------|--|
| diagram | |
| type | enum 0191 |
| properties | content simple |
| facets | Kind Value Annotation enumeration 0191001 documentation Netz enumeration 0191002 documentation ADM |
| source | <code><element name="ZBI_ZubehoerTypSchluessel" type="enum_0191"/></code> |

complexType **ZubehoerEndoprotheseBasis**

| | |
|-----------|--|
| diagram | |
| namespace | http://xml.ir-d.de/emg |
| children | ZEP_HerstellerSchluessel ZEP_HerstellerUnbekannt ZEP_HerstellerSonstiger ZEP_ZubehoerTypSchluessel |

| | |
|---------|--|
| | ZEP Menge ZEP EinheitSchluessel |
| used by | element Zubehoer/zubehoerEndoprothese |
| source | <pre> <complexType name="ZubehoerEndoprotheseBasis"> <sequence> <choice> <element name="ZEP_HerstellerSchluessel" type="enum_0230"/> <element name="ZEP_HerstellerUnbekannt" type="JaLeer"/> </choice> <element name="ZEP_HerstellerSonstiger" type="Freitext250" minOccurs="0"/> <element name="ZEP_ZubehoerTypSchluessel" type="enum_0291"/> <element name="ZEP_Menge" type="Zahl5"/> <element name="ZEP_EinheitSchluessel" type="enum_0062"/> </sequence> </complexType> </pre> |

element [ZubehoerEndoprotheseBasis/ZEP_HerstellerSchluessel](#)

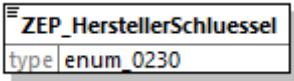
| | | | |
|------------|---|---------|---|
| diagram |  | | |
| type | enum 0230 | | |
| properties | content simple | | |
| facets | Kind | Value | Annotation |
| | enumeration | 0230001 | documentation Smith & Nephew GmbH |
| | enumeration | 0230002 | documentation Mathys Orthopädie GmbH |
| | enumeration | 0230003 | documentation Ceramtec AG |
| | enumeration | 0230004 | documentation Biomet |
| | enumeration | 0230005 | documentation Peter Brehm GmbH |
| | enumeration | 0230006 | documentation Amplitude GmbH |
| | enumeration | 0230007 | documentation Exactech Deutschland |
| | enumeration | 0230008 | documentation Globus Medical |
| | enumeration | 0230009 | documentation Implantcast GmbH |
| | enumeration | 0230010 | documentation DePuy Orthopädie GmbH |
| | enumeration | 0230011 | documentation IO-International Orthopaedics |
| | enumeration | 0230012 | documentation Joint Replacement Ltd. Instrumentation |
| | enumeration | 0230013 | documentation Merete |
| | enumeration | 0230014 | documentation S&G Implants GmbH |
| | enumeration | 0230015 | documentation Speetec Implantate GmbH |
| | enumeration | 0230016 | documentation Stemcup Medical Products GmbH |
| | enumeration | 0230017 | documentation Symbios Deutschland GmbH |
| | enumeration | 0230018 | documentation |

| | | | |
|--------|--|---------|--|
| | enumeration | 0230019 | Tantum AG documentation |
| | enumeration | 0230020 | Tomier GmbH documentation |
| | enumeration | 0230021 | MicroPort Orthopedics GmbH documentation |
| | enumeration | 0230022 | aap Implanate AG documentation |
| | enumeration | 0230023 | AQImplants documentation |
| | enumeration | 0230024 | ESKA Orthodynamics GmbH documentation |
| | enumeration | 0230025 | Atesos medical AG documentation |
| | enumeration | 0230026 | Chiropro GmbH documentation |
| | enumeration | 0230027 | Medacta documentation |
| | enumeration | 0230028 | OHST Medizintechnik AG documentation |
| | enumeration | 0230029 | Lima Deutschland GmbH documentation |
| | enumeration | 0230030 | alloPlus GmbH documentation |
| | enumeration | 0230031 | Heraeus Medical GmbH documentation |
| | enumeration | 0230032 | ImplanTec Deutschland GmbH documentation |
| | enumeration | 0230033 | Falcon Medical GmbH documentation |
| | enumeration | 0230034 | Meril GmbH documentation |
| | enumeration | 0230035 | Zimmer Germany GmbH documentation |
| | enumeration | 0230036 | Stryker GmbH & Co. KG documentation |
| | enumeration | 0230037 | Aesculap AG documentation |
| | enumeration | 0230038 | Waldemar Link GmbH & Co. KG documentation |
| | enumeration | 0230039 | Corin Germany GmbH documentation |
| | enumeration | 0230040 | nicht belegter Wert documentation |
| | enumeration | 0230041 | nicht belegter Wert documentation |
| | enumeration | 0230042 | nicht belegter Wert documentation |
| | enumeration | 0230043 | sonstige documentation |
| | enumeration | 0230044 | nicht belegter Wert documentation |
| source | <code><element name="ZEP_HerstellerSchluesse1" type="enum_0230"/></code> | | |

element **ZubehoerEndoprotheseBasis/ZEP_HerstellerUnbekannt**

| | |
|---------|---|
| diagram | <pre> classDiagram class ZEP_HerstellerUnbekannt { type JaLeer pattern (1) } </pre> |
|---------|---|

| | |
|------------|--|
| type | JaLeer |
| properties | content simple |
| facets | Kind Value Annotation pattern (1) |
| source | <code><element name="ZEP_HerstellerUnbekannt" type="JaLeer"/></code> |

element **ZubehoerEndoprotheseBasis/ZEP_HerstellerSonstiger**

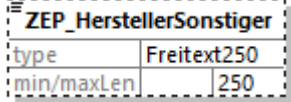
| | |
|------------|---|
| diagram |  |
| type | Freitext250 |
| properties | minOcc 0 maxOcc 1 content simple |
| facets | Kind Value Annotation maxLength 250 |
| source | <code><element name="ZEP_HerstellerSonstiger" type="Freitext250" minOccurs="0"/></code> |

element **ZubehoerEndoprotheseBasis/ZEP_ZubehoerTypSchluessel**

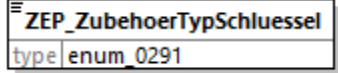
| | |
|------------|--|
| diagram |  |
| type | enum 0291 |
| properties | content simple |
| facets | Kind Value Annotation enumeration 0291001 documentation Knochen-Zement enumeration 0291002 documentation sonstiges Zubehör |
| source | <code><element name="ZEP_ZubehoerTypSchluessel" type="enum_0291"/></code> |

element **ZubehoerEndoprotheseBasis/ZEP_Menge**

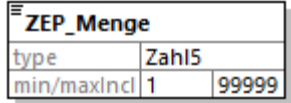
| | |
|------------|---|
| diagram |  |
| type | Zahl5 |
| properties | content simple |
| facets | Kind Value Annotation minInclusive 1 maxInclusive 99999 |
| source | <code><element name="ZEP_Menge" type="Zahl5"/></code> |

element **ZubehoerEndoprotheseBasis/ZEP_EinheitSchluessel**

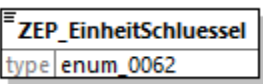
| | | | |
|------------|---|---------|----------------------------------|
| diagram |  | | |
| type | enum 0062 | | |
| properties | content simple | | |
| facets | Kind | Value | Annotation |
| | enumeration | 0062001 | documentation Stück |
| | enumeration | 0062002 | documentation g |
| | enumeration | 0062003 | documentation mg |
| | enumeration | 0062004 | documentation l |
| | enumeration | 0062005 | documentation ml |
| | enumeration | 0062006 | documentation cm ³ |
| | enumeration | 0062007 | documentation mm |
| | enumeration | 0062008 | documentation cm |
| | enumeration | 0062009 | documentation dm |
| | enumeration | 0062010 | documentation m |
| | enumeration | 0062042 | documentation andere |
| source | <code><element name="ZEP_EinheitSchluessel" type="enum_0062"/></code> | | |

complexType PatientenaufnahmeAortenklappeBasis

diagram

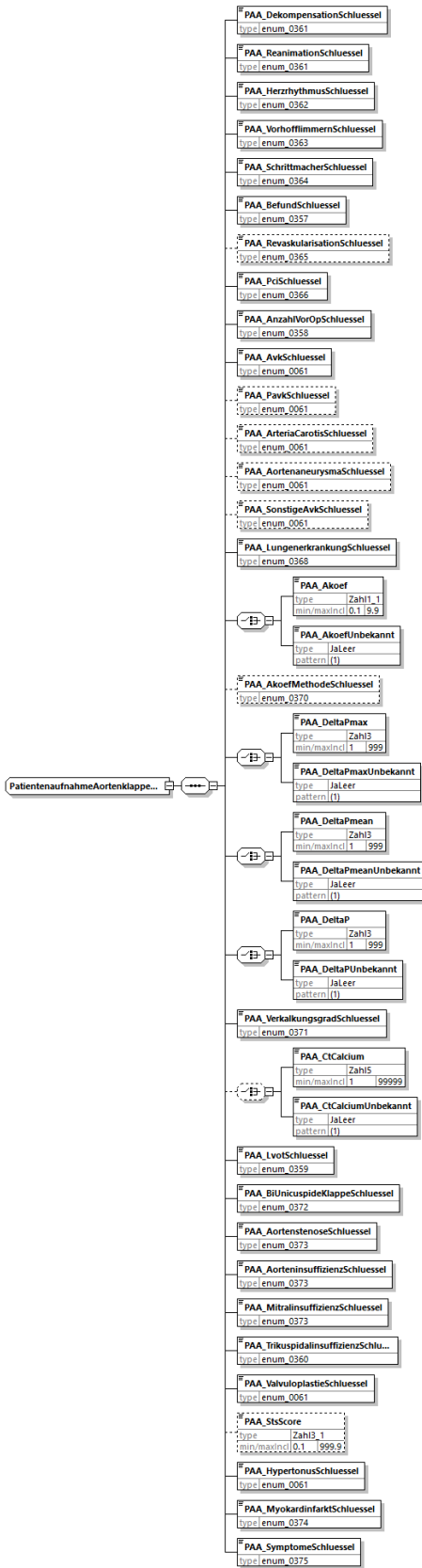

namespace http://xml.ir-d.de/emg

children

[PAA DekompensationSchluessel](#) [PAA ReanimationSchluessel](#) [PAA HerzrhythmusSchluessel](#)
[PAA VorhofflimmernSchluessel](#) [PAA SchrittmacherSchluessel](#) [PAA BefundSchluessel](#)

| | |
|---------|--|
| | PAA RevaskularisationSchluessel PAA PciSchluessel PAA AnzahlVorOpSchluessel PAA AvkSchluessel PAA PavkSchluessel PAA ArteriaCarotisSchluessel PAA AortenaneurysmaSchluessel PAA SonstigeAvkSchluessel PAA LungenerkrankungSchluessel PAA Akoef PAA AkoefUnbekannt PAA AkoefMethodeSchluessel PAA DeltaPmax PAA DeltaPmaxUnbekannt PAA DeltaPmean PAA DeltaPmeanUnbekannt PAA DeltaP PAA DeltaPUnbekannt PAA VerkalkungsgradSchluessel PAA CtCalcium PAA CtCalciumUnbekannt PAA LvotSchluessel PAA BiUnicuspideKlappeSchluessel PAA AortenstenoseSchluessel PAA AorteninsuffizienzSchluessel PAA MitralinsuffizienzSchluessel PAA TrikuspidalinsuffizienzSchluessel PAA ValvuloplastieSchluessel PAA StsScore PAA HypertonusSchluessel PAA MyokardinfarktSchluessel PAA SymptomeSchluessel |
| used by | complexType PatientenaufnahmeAortenklappe |
| source | <pre> <complexType name="PatientenaufnahmeAortenklappeBasis"> <sequence> <element name="PAA_DekompensationSchluessel" type="enum_0361"/> <element name="PAA_ReanimationSchluessel" type="enum_0361"/> <element name="PAA_HerzrhythmusSchluessel" type="enum_0362"/> <element name="PAA_VorhofflimmernSchluessel" type="enum_0363"/> <element name="PAA_SchrittmacherSchluessel" type="enum_0364"/> <element name="PAA_BefundSchluessel" type="enum_0357"/> <element name="PAA_RevaskularisationSchluessel" type="enum_0365" minOccurs="0"/> <element name="PAA_PciSchluessel" type="enum_0366"/> <element name="PAA_AnzahlVorOpSchluessel" type="enum_0358"/> <element name="PAA_AvkSchluessel" type="enum_0061"/> <element name="PAA_PavkSchluessel" type="enum_0061" minOccurs="0"/> <element name="PAA_ArteriaCarotisSchluessel" type="enum_0061" minOccurs="0"/> <element name="PAA_AortenaneurysmaSchluessel" type="enum_0061" minOccurs="0"/> <element name="PAA_SonstigeAvkSchluessel" type="enum_0061" minOccurs="0"/> <element name="PAA_LungenerkrankungSchluessel" type="enum_0368"/> <choice> <element name="PAA_Akoef" type="Zahl1_1"/> <element name="PAA_AkoefUnbekannt" type="JaLeer"/> </choice> <element name="PAA_AkoefMethodeSchluessel" type="enum_0370" minOccurs="0"/> <choice> <element name="PAA_DeltaPmax" type="Zahl3"/> <element name="PAA_DeltaPmaxUnbekannt" type="JaLeer"/> </choice> <choice> <element name="PAA_DeltaPmean" type="Zahl3"/> <element name="PAA_DeltaPmeanUnbekannt" type="JaLeer"/> </choice> <choice> <element name="PAA_DeltaP" type="Zahl3"/> <element name="PAA_DeltaPUnbekannt" type="JaLeer"/> </choice> <element name="PAA_VerkalkungsgradSchluessel" type="enum_0371"/> <choice minOccurs="0"> <element name="PAA_CtCalcium" type="Zahl15"/> <element name="PAA_CtCalciumUnbekannt" type="JaLeer"/> </choice> <element name="PAA_LvotSchluessel" type="enum_0359"/> <element name="PAA_BiUnicuspideKlappeSchluessel" type="enum_0372"/> <element name="PAA_AortenstenoseSchluessel" type="enum_0373"/> <element name="PAA_AorteninsuffizienzSchluessel" type="enum_0373"/> <element name="PAA_MitralinsuffizienzSchluessel" type="enum_0373"/> <element name="PAA_TrikuspidalinsuffizienzSchluessel" type="enum_0360"/> </pre> |

| | |
|--|---|
| | <pre> <element name="PAA_ValvuloplastieSchluessel" type="enum_0061"/> <element name="PAA_StsScore" type="Zahl3_1" minOccurs="0"/> <element name="PAA_HypertonusSchluessel" type="enum_0061"/> <element name="PAA_MyokardinfarktSchluessel" type="enum_0374"/> <element name="PAA_SymptomeSchluessel" type="enum_0375"/> </sequence> </complexType> </pre> |
|--|---|

element **PatientenaufnahmeAortenklappeBasis/PAA_DekompensationSchluessel**

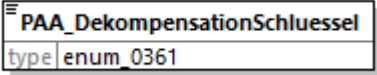
| | | | |
|------------|--|---------|---|
| diagram |  | | |
| type | enum 0361 | | |
| properties | content simple | | |
| facets | Kind | Value | Annotation |
| | enumeration | 0361001 | documentation nein |
| | enumeration | 0361002 | documentation ja, letzte(r) innerhalb der letzten 48 Stunden |
| | enumeration | 0361003 | documentation ja, letzte(r) innerhalb der letzten 21 Tage |
| | enumeration | 0361004 | documentation ja, letzte(r) länger als 21 Tage |
| | enumeration | 0361098 | documentation ja, letzter Zeitpunkt unbekannt |
| | enumeration | 0361099 | documentation unbekannt |
| source | <code><element name="PAA_DekompensationSchluessel" type="enum_0361"/></code> | | |

element **PatientenaufnahmeAortenklappeBasis/PAA_ReanimationSchluessel**

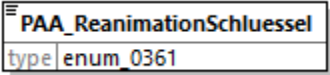
| | | | |
|------------|---|---------|---|
| diagram |  | | |
| type | enum 0361 | | |
| properties | content simple | | |
| facets | Kind | Value | Annotation |
| | enumeration | 0361001 | documentation nein |
| | enumeration | 0361002 | documentation ja, letzte(r) innerhalb der letzten 48 Stunden |
| | enumeration | 0361003 | documentation ja, letzte(r) innerhalb der letzten 21 Tage |
| | enumeration | 0361004 | documentation ja, letzte(r) länger als 21 Tage |
| | enumeration | 0361098 | documentation ja, letzter Zeitpunkt unbekannt |
| | enumeration | 0361099 | documentation unbekannt |
| source | <code><element name="PAA_ReanimationSchluessel" type="enum_0361"/></code> | | |

element **PatientenaufnahmeAortenklappeBasis/PAA_HerzrhythmusSchluessel**

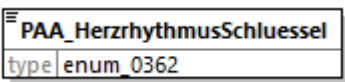
| | | | |
|------------|---|---------|---------------------------------------|
| diagram |  | | |
| type | enum 0362 | | |
| properties | content simple | | |
| facets | Kind | Value | Annotation |
| | enumeration | 0362001 | documentation Sinusrhythmus |
| | enumeration | 0362002 | documentation Vorhofflimmern |
| | enumeration | 0362042 | documentation anderer Herzrhythmus |
| source | <code><element name="PAA_HerzrhythmusSchluessel" type="enum_0362"/></code> | | |

element **PatientenaufnahmeAortenklappeBasis/PAA_VorhofflimmernSchluessel**

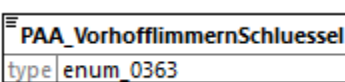
| | | | |
|------------|--|---------|--------------------------------|
| diagram |  | | |
| type | enum 0363 | | |
| properties | content simple | | |
| facets | Kind | Value | Annotation |
| | enumeration | 0363001 | documentation nein |
| | enumeration | 0363002 | documentation paroxysmal |
| | enumeration | 0363003 | documentation persistierend |
| | enumeration | 0363004 | documentation permanent |
| source | <code><element name="PAA_VorhofflimmernSchluessel" type="enum_0363"/></code> | | |

element **PatientenaufnahmeAortenklappeBasis/PAA_SchrittmacherSchluessel**

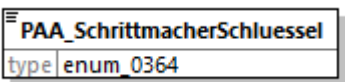
| | | | |
|------------|---|---------|--|
| diagram |  | | |
| type | enum 0364 | | |
| properties | content simple | | |
| facets | Kind | Value | Annotation |
| | enumeration | 0364001 | documentation nein |
| | enumeration | 0364002 | documentation Schrittmacher ohne CRT-System |
| | enumeration | 0364003 | documentation Schrittmacher mit CRT-System |
| | enumeration | 0364004 | documentation Defibrillator ohne CRT-System |
| | enumeration | 0364005 | documentation Defibrillator mit CRT-System |
| source | <code><element name="PAA_SchrittmacherSchluessel" type="enum_0364"/></code> | | |

element **PatientenaufnahmeAortenklappeBasis/PAA_BefundSchluessel**

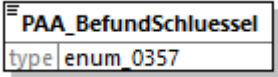
| | | | |
|------------|---|---------|--|
| diagram |  | | |
| type | enum 0357 | | |
| properties | content simple | | |
| facets | Kind | Value | Annotation |
| | enumeration | 0357001 | documentation keine KHK |
| | enumeration | 0357002 | documentation 1-Gefäßerkrankung |
| | enumeration | 0357003 | documentation 2-Gefäßerkrankung |
| | enumeration | 0357004 | documentation 3-Gefäßerkrankung |
| | enumeration | 0357005 | documentation keine koronare Bildgebung |
| source | <code><element name="PAA_BefundSchluessel" type="enum_0357"/></code> | | |

element **PatientenaufnahmeAortenklappeBasis/PAA_RevaskularisationSchluessel**

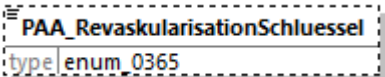
| | | | |
|------------|---|---------|--------------------------------------|
| diagram |  | | |
| type | enum 0365 | | |
| properties | minOcc | 0 | |
| | maxOcc | 1 | |
| | content | simple | |
| facets | Kind | Value | Annotation |
| | enumeration | 0365001 | documentation nein |
| | enumeration | 0365002 | documentation ja, operativ |
| | enumeration | 0365003 | documentation ja, interventionell |
| source | <code><element name="PAA_RevaskularisationSchluessel" type="enum_0365" minOccurs="0"/></code> | | |

element **PatientenaufnahmeAortenklappeBasis/PAA_PciSchluessel**

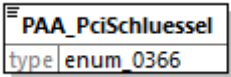
| | | | |
|------------|---|---------|--------------------------------------|
| diagram |  | | |
| type | enum 0366 | | |
| properties | content simple | | |
| facets | Kind | Value | Annotation |
| | enumeration | 0366001 | documentation nein |
| | enumeration | 0366002 | documentation ja, <= 6 Stunden |
| | enumeration | 0366003 | documentation |

| | | |
|--------|---|--|
| | enumeration 0366004 | ja, > 6 Stunden bis <= 3 Monate documentation |
| | enumeration 0366099 | ja, > 3 Monate documentation unbekannt |
| source | <code><element name="PAA_PciSchluessel" type="enum_0366"/></code> | |

element **PatientenaufnahmeAortenklappeBasis/PAA_AnzahlVorOpSchluessel**

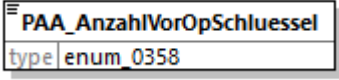
| | | | |
|------------|---|---------|---|
| diagram |  | | |
| type | enum 0358 | | |
| properties | content simple | | |
| facets | Kind | Value | Annotation |
| | enumeration | 0358001 | documentation 0 |
| | enumeration | 0358002 | documentation 1 |
| | enumeration | 0358003 | documentation 2 |
| | enumeration | 0358004 | documentation 3 |
| | enumeration | 0358005 | documentation 4 |
| | enumeration | 0358006 | documentation 5 oder mehr |
| | enumeration | 0358098 | documentation genaue Anzahl unbekannt (aber mind. 1) |
| | enumeration | 0358099 | documentation unbekannt |
| source | <code><element name="PAA_AnzahlVorOpSchluessel" type="enum_0358"/></code> | | |

element **PatientenaufnahmeAortenklappeBasis/PAA_AvkSchluessel**

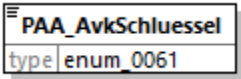
| | | | |
|------------|---|---------|----------------------------|
| diagram |  | | |
| type | enum 0061 | | |
| properties | content simple | | |
| facets | Kind | Value | Annotation |
| | enumeration | 0061001 | documentation ja |
| | enumeration | 0061002 | documentation nein |
| | enumeration | 0061099 | documentation unbekannt |
| source | <code><element name="PAA_AvkSchluessel" type="enum_0061"/></code> | | |

element **PatientenaufnahmeAortenklappeBasis/PAA_PavkSchluessel**

| diagram | | | | | | | | | | | | | |
|-------------|---|----------------------------|-------|------------|-------------|---------|---------------------|-------------|---------|-----------------------|-------------|---------|----------------------------|
| type | enum 0061 | | | | | | | | | | | | |
| properties | minOcc 0 maxOcc 1 content simple | | | | | | | | | | | | |
| facets | <table border="1"> <thead> <tr> <th>Kind</th> <th>Value</th> <th>Annotation</th> </tr> </thead> <tbody> <tr> <td>enumeration</td> <td>0061001</td> <td>documentation ja</td> </tr> <tr> <td>enumeration</td> <td>0061002</td> <td>documentation nein</td> </tr> <tr> <td>enumeration</td> <td>0061099</td> <td>documentation unbekannt</td> </tr> </tbody> </table> | Kind | Value | Annotation | enumeration | 0061001 | documentation ja | enumeration | 0061002 | documentation nein | enumeration | 0061099 | documentation unbekannt |
| Kind | Value | Annotation | | | | | | | | | | | |
| enumeration | 0061001 | documentation ja | | | | | | | | | | | |
| enumeration | 0061002 | documentation nein | | | | | | | | | | | |
| enumeration | 0061099 | documentation unbekannt | | | | | | | | | | | |
| source | <code><element name="PAA_PavkSchluessel" type="enum_0061" minOccurs="0"/></code> | | | | | | | | | | | | |

element **PatientenaufnahmeAortenklappeBasis/PAA_ArteriaCarotisSchluessel**

| diagram | | | | | | | | | | | | | |
|-------------|---|----------------------------|-------|------------|-------------|---------|---------------------|-------------|---------|-----------------------|-------------|---------|----------------------------|
| type | enum 0061 | | | | | | | | | | | | |
| properties | minOcc 0 maxOcc 1 content simple | | | | | | | | | | | | |
| facets | <table border="1"> <thead> <tr> <th>Kind</th> <th>Value</th> <th>Annotation</th> </tr> </thead> <tbody> <tr> <td>enumeration</td> <td>0061001</td> <td>documentation ja</td> </tr> <tr> <td>enumeration</td> <td>0061002</td> <td>documentation nein</td> </tr> <tr> <td>enumeration</td> <td>0061099</td> <td>documentation unbekannt</td> </tr> </tbody> </table> | Kind | Value | Annotation | enumeration | 0061001 | documentation ja | enumeration | 0061002 | documentation nein | enumeration | 0061099 | documentation unbekannt |
| Kind | Value | Annotation | | | | | | | | | | | |
| enumeration | 0061001 | documentation ja | | | | | | | | | | | |
| enumeration | 0061002 | documentation nein | | | | | | | | | | | |
| enumeration | 0061099 | documentation unbekannt | | | | | | | | | | | |
| source | <code><element name="PAA_ArteriaCarotisSchluessel" type="enum_0061" minOccurs="0"/></code> | | | | | | | | | | | | |

element **PatientenaufnahmeAortenklappeBasis/PAA_AortenaneurysmaSchluessel**

| diagram | | | | | | | | | | | | | |
|-------------|---|----------------------------|-------|------------|-------------|---------|---------------------|-------------|---------|-----------------------|-------------|---------|----------------------------|
| type | enum 0061 | | | | | | | | | | | | |
| properties | minOcc 0 maxOcc 1 content simple | | | | | | | | | | | | |
| facets | <table border="1"> <thead> <tr> <th>Kind</th> <th>Value</th> <th>Annotation</th> </tr> </thead> <tbody> <tr> <td>enumeration</td> <td>0061001</td> <td>documentation ja</td> </tr> <tr> <td>enumeration</td> <td>0061002</td> <td>documentation nein</td> </tr> <tr> <td>enumeration</td> <td>0061099</td> <td>documentation unbekannt</td> </tr> </tbody> </table> | Kind | Value | Annotation | enumeration | 0061001 | documentation ja | enumeration | 0061002 | documentation nein | enumeration | 0061099 | documentation unbekannt |
| Kind | Value | Annotation | | | | | | | | | | | |
| enumeration | 0061001 | documentation ja | | | | | | | | | | | |
| enumeration | 0061002 | documentation nein | | | | | | | | | | | |
| enumeration | 0061099 | documentation unbekannt | | | | | | | | | | | |
| source | <code><element name="PAA_AortenaneurysmaSchluessel" type="enum_0061" minOccurs="0"/></code> | | | | | | | | | | | | |

element **PatientenaufnahmeAortenklappeBasis/PAA_SonstigeAvkSchluessel**

| diagram |  | | | | | | | | | | | | |
|-------------|---|----------------------------|-------|------------|-------------|---------|---------------------|-------------|---------|-----------------------|-------------|---------|----------------------------|
| type | enum_0061 | | | | | | | | | | | | |
| properties | minOcc 0 maxOcc 1 content simple | | | | | | | | | | | | |
| facets | <table border="1"> <thead> <tr> <th>Kind</th> <th>Value</th> <th>Annotation</th> </tr> </thead> <tbody> <tr> <td>enumeration</td> <td>0061001</td> <td>documentation ja</td> </tr> <tr> <td>enumeration</td> <td>0061002</td> <td>documentation nein</td> </tr> <tr> <td>enumeration</td> <td>0061099</td> <td>documentation unbekannt</td> </tr> </tbody> </table> | Kind | Value | Annotation | enumeration | 0061001 | documentation ja | enumeration | 0061002 | documentation nein | enumeration | 0061099 | documentation unbekannt |
| Kind | Value | Annotation | | | | | | | | | | | |
| enumeration | 0061001 | documentation ja | | | | | | | | | | | |
| enumeration | 0061002 | documentation nein | | | | | | | | | | | |
| enumeration | 0061099 | documentation unbekannt | | | | | | | | | | | |
| source | <code><element name="PAA_SonstigeAvkSchluessel" type="enum_0061" minOccurs="0"/></code> | | | | | | | | | | | | |

element **PatientenaufnahmeAortenklappeBasis/PAA_LungenerkrankungSchluessel**

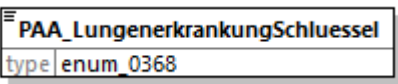
| diagram |  | | | | | | | | | | | | | | | | | | |
|-------------|---|--|-------|------------|-------------|---------|-----------------------|-------------|---------|---|-------------|---------|--|-------------|---------|--|-------------|---------|----------------------------|
| type | enum_0368 | | | | | | | | | | | | | | | | | | |
| properties | content simple | | | | | | | | | | | | | | | | | | |
| facets | <table border="1"> <thead> <tr> <th>Kind</th> <th>Value</th> <th>Annotation</th> </tr> </thead> <tbody> <tr> <td>enumeration</td> <td>0368001</td> <td>documentation nein</td> </tr> <tr> <td>enumeration</td> <td>0368002</td> <td>documentation ja, COPD mit Dauermedikation</td> </tr> <tr> <td>enumeration</td> <td>0368003</td> <td>documentation ja, COPD ohne Dauermedikation</td> </tr> <tr> <td>enumeration</td> <td>0368004</td> <td>documentation ja, andere Lungenerkrankungen</td> </tr> <tr> <td>enumeration</td> <td>0368099</td> <td>documentation unbekannt</td> </tr> </tbody> </table> | Kind | Value | Annotation | enumeration | 0368001 | documentation nein | enumeration | 0368002 | documentation ja, COPD mit Dauermedikation | enumeration | 0368003 | documentation ja, COPD ohne Dauermedikation | enumeration | 0368004 | documentation ja, andere Lungenerkrankungen | enumeration | 0368099 | documentation unbekannt |
| Kind | Value | Annotation | | | | | | | | | | | | | | | | | |
| enumeration | 0368001 | documentation nein | | | | | | | | | | | | | | | | | |
| enumeration | 0368002 | documentation ja, COPD mit Dauermedikation | | | | | | | | | | | | | | | | | |
| enumeration | 0368003 | documentation ja, COPD ohne Dauermedikation | | | | | | | | | | | | | | | | | |
| enumeration | 0368004 | documentation ja, andere Lungenerkrankungen | | | | | | | | | | | | | | | | | |
| enumeration | 0368099 | documentation unbekannt | | | | | | | | | | | | | | | | | |
| source | <code><element name="PAA_LungenerkrankungSchluessel" type="enum_0368"/></code> | | | | | | | | | | | | | | | | | | |

element **PatientenaufnahmeAortenklappeBasis/PAA_Akoef**

| diagram |  | | | | | | | | | | | | | | | |
|----------------|--|------------|-------|------------|--------------|-----|--|--------------|-----|--|-------------|---|--|----------------|---|--|
| type | Zahl1_1 | | | | | | | | | | | | | | | |
| properties | content simple | | | | | | | | | | | | | | | |
| facets | <table border="1"> <thead> <tr> <th>Kind</th> <th>Value</th> <th>Annotation</th> </tr> </thead> <tbody> <tr> <td>minInclusive</td> <td>0.1</td> <td></td> </tr> <tr> <td>maxInclusive</td> <td>9.9</td> <td></td> </tr> <tr> <td>totalDigits</td> <td>2</td> <td></td> </tr> <tr> <td>fractionDigits</td> <td>1</td> <td></td> </tr> </tbody> </table> | Kind | Value | Annotation | minInclusive | 0.1 | | maxInclusive | 9.9 | | totalDigits | 2 | | fractionDigits | 1 | |
| Kind | Value | Annotation | | | | | | | | | | | | | | |
| minInclusive | 0.1 | | | | | | | | | | | | | | | |
| maxInclusive | 9.9 | | | | | | | | | | | | | | | |
| totalDigits | 2 | | | | | | | | | | | | | | | |
| fractionDigits | 1 | | | | | | | | | | | | | | | |
| source | <code><element name="PAA_Akoef" type="Zahl1_1"/></code> | | | | | | | | | | | | | | | |

element **PatientenaufnahmeAortenklappeBasis/PAA_AkoefUnbekannt**

| diagram |  | | | | | | |
|------------|--|------------|-------|------------|---------|-----|--|
| type | JaLeer | | | | | | |
| properties | content simple | | | | | | |
| facets | <table border="1"> <thead> <tr> <th>Kind</th> <th>Value</th> <th>Annotation</th> </tr> </thead> <tbody> <tr> <td>pattern</td> <td>(1)</td> <td></td> </tr> </tbody> </table> | Kind | Value | Annotation | pattern | (1) | |
| Kind | Value | Annotation | | | | | |
| pattern | (1) | | | | | | |
| source | <code><element name="PAA_AkoefUnbekannt" type="JaLeer"/></code> | | | | | | |

element **PatientenaufnahmeAortenklappeBasis/PAA_AkoefMethodeSchluessel**

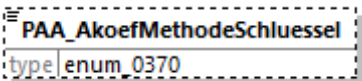
| diagram |  | | | | | | | | | | | | |
|-------------|---|------------------------------------|-------|------------|-------------|---------|------------------------------------|-------------|---------|-------------------------------|-------------|---------|-------------------------|
| type | enum_0370 | | | | | | | | | | | | |
| properties | <table border="1"> <tbody> <tr> <td>minOcc</td> <td>0</td> </tr> <tr> <td>maxOcc</td> <td>1</td> </tr> <tr> <td>content</td> <td>simple</td> </tr> </tbody> </table> | minOcc | 0 | maxOcc | 1 | content | simple | | | | | | |
| minOcc | 0 | | | | | | | | | | | | |
| maxOcc | 1 | | | | | | | | | | | | |
| content | simple | | | | | | | | | | | | |
| facets | <table border="1"> <thead> <tr> <th>Kind</th> <th>Value</th> <th>Annotation</th> </tr> </thead> <tbody> <tr> <td>enumeration</td> <td>0370001</td> <td>documentation Echokardiographie</td> </tr> <tr> <td>enumeration</td> <td>0370002</td> <td>documentation Herzkatheter</td> </tr> <tr> <td>enumeration</td> <td>0370042</td> <td>documentation andere</td> </tr> </tbody> </table> | Kind | Value | Annotation | enumeration | 0370001 | documentation Echokardiographie | enumeration | 0370002 | documentation Herzkatheter | enumeration | 0370042 | documentation andere |
| Kind | Value | Annotation | | | | | | | | | | | |
| enumeration | 0370001 | documentation Echokardiographie | | | | | | | | | | | |
| enumeration | 0370002 | documentation Herzkatheter | | | | | | | | | | | |
| enumeration | 0370042 | documentation andere | | | | | | | | | | | |
| source | <code><element name="PAA_AkoefMethodeSchluessel" type="enum_0370" minOccurs="0"/></code> | | | | | | | | | | | | |

element **PatientenaufnahmeAortenklappeBasis/PAA_DeltaPmax**

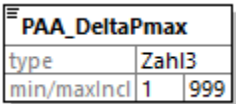
| diagram |  | | | | | | | | | |
|--------------|---|------------|-------|------------|--------------|---|--|--------------|-----|--|
| type | Zahl3 | | | | | | | | | |
| properties | content simple | | | | | | | | | |
| facets | <table border="1"> <thead> <tr> <th>Kind</th> <th>Value</th> <th>Annotation</th> </tr> </thead> <tbody> <tr> <td>minInclusive</td> <td>1</td> <td></td> </tr> <tr> <td>maxInclusive</td> <td>999</td> <td></td> </tr> </tbody> </table> | Kind | Value | Annotation | minInclusive | 1 | | maxInclusive | 999 | |
| Kind | Value | Annotation | | | | | | | | |
| minInclusive | 1 | | | | | | | | | |
| maxInclusive | 999 | | | | | | | | | |
| source | <code><element name="PAA_DeltaPmax" type="Zahl3"/></code> | | | | | | | | | |

element **PatientenaufnahmeAortenklappeBasis/PAA_DeltaPmaxUnbekannt**

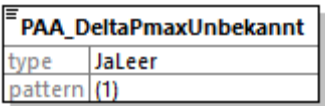
| diagram |  | | | | | | |
|------------|--|------------|-------|------------|---------|-----|--|
| type | JaLeer | | | | | | |
| properties | content simple | | | | | | |
| facets | <table border="1"> <thead> <tr> <th>Kind</th> <th>Value</th> <th>Annotation</th> </tr> </thead> <tbody> <tr> <td>pattern</td> <td>(1)</td> <td></td> </tr> </tbody> </table> | Kind | Value | Annotation | pattern | (1) | |
| Kind | Value | Annotation | | | | | |
| pattern | (1) | | | | | | |
| source | <code><element name="PAA_DeltaPmaxUnbekannt" type="JaLeer"/></code> | | | | | | |

element **PatientenaufnahmeAortenklappeBasis/PAA_DeltaPmean**

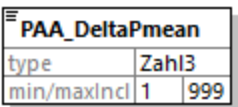
| diagram |  | | | | | | | | | |
|--------------|---|------------|-------|------------|--------------|---|--|--------------|-----|--|
| type | Zahl3 | | | | | | | | | |
| properties | content simple | | | | | | | | | |
| facets | <table border="1"> <thead> <tr> <th>Kind</th> <th>Value</th> <th>Annotation</th> </tr> </thead> <tbody> <tr> <td>minInclusive</td> <td>1</td> <td></td> </tr> <tr> <td>maxInclusive</td> <td>999</td> <td></td> </tr> </tbody> </table> | Kind | Value | Annotation | minInclusive | 1 | | maxInclusive | 999 | |
| Kind | Value | Annotation | | | | | | | | |
| minInclusive | 1 | | | | | | | | | |
| maxInclusive | 999 | | | | | | | | | |
| source | <code><element name="PAA_DeltaPmean" type="Zahl3"/></code> | | | | | | | | | |

element **PatientenaufnahmeAortenklappeBasis/PAA_DeltaPmeanUnbekannt**

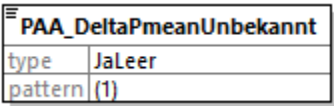
| diagram |  | | | | | | |
|------------|--|------------|-------|------------|---------|-----|--|
| type | JaLeer | | | | | | |
| properties | content simple | | | | | | |
| facets | <table border="1"> <thead> <tr> <th>Kind</th> <th>Value</th> <th>Annotation</th> </tr> </thead> <tbody> <tr> <td>pattern</td> <td>(1)</td> <td></td> </tr> </tbody> </table> | Kind | Value | Annotation | pattern | (1) | |
| Kind | Value | Annotation | | | | | |
| pattern | (1) | | | | | | |
| source | <code><element name="PAA_DeltaPmeanUnbekannt" type="JaLeer"/></code> | | | | | | |

element **PatientenaufnahmeAortenklappeBasis/PAA_DeltaP**

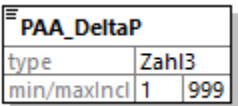
| diagram |  | | | | | | | | | |
|--------------|---|------------|-------|------------|--------------|---|--|--------------|-----|--|
| type | Zahl3 | | | | | | | | | |
| properties | content simple | | | | | | | | | |
| facets | <table border="1"> <thead> <tr> <th>Kind</th> <th>Value</th> <th>Annotation</th> </tr> </thead> <tbody> <tr> <td>minInclusive</td> <td>1</td> <td></td> </tr> <tr> <td>maxInclusive</td> <td>999</td> <td></td> </tr> </tbody> </table> | Kind | Value | Annotation | minInclusive | 1 | | maxInclusive | 999 | |
| Kind | Value | Annotation | | | | | | | | |
| minInclusive | 1 | | | | | | | | | |
| maxInclusive | 999 | | | | | | | | | |

| | |
|--------|--|
| source | <code><element name="PAA_DeltaP" type="Zahl3"/></code> |
|--------|--|

element **PatientenaufnahmeAortenklappeBasis/PAA_DeltaPUnbekannt**

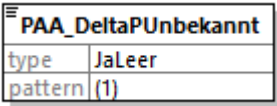
| diagram |  | | | | | | |
|------------|--|------------|-------|------------|---------|-----|--|
| type | JaLeer | | | | | | |
| properties | content simple | | | | | | |
| facets | <table border="1"> <thead> <tr> <th>Kind</th> <th>Value</th> <th>Annotation</th> </tr> </thead> <tbody> <tr> <td>pattern</td> <td>(1)</td> <td></td> </tr> </tbody> </table> | Kind | Value | Annotation | pattern | (1) | |
| Kind | Value | Annotation | | | | | |
| pattern | (1) | | | | | | |
| source | <code><element name="PAA_DeltaPUnbekannt" type="JaLeer"/></code> | | | | | | |

element **PatientenaufnahmeAortenklappeBasis/PAA_VerkalkungsgradSchluessel**

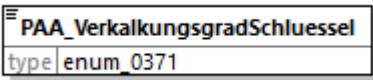
| diagram |  | | | | | | | | | | | | | | | | | | |
|-------------|--|----------------------------|-------|------------|-------------|---------|------------------------|-------------|---------|-------------------------|-------------|---------|-------------------------|-------------|---------|-------------------------|-------------|---------|----------------------------|
| type | enum 0371 | | | | | | | | | | | | | | | | | | |
| properties | content simple | | | | | | | | | | | | | | | | | | |
| facets | <table border="1"> <thead> <tr> <th>Kind</th> <th>Value</th> <th>Annotation</th> </tr> </thead> <tbody> <tr> <td>enumeration</td> <td>0371001</td> <td>documentation keine</td> </tr> <tr> <td>enumeration</td> <td>0371002</td> <td>documentation leicht</td> </tr> <tr> <td>enumeration</td> <td>0371003</td> <td>documentation mittel</td> </tr> <tr> <td>enumeration</td> <td>0371004</td> <td>documentation schwer</td> </tr> <tr> <td>enumeration</td> <td>0371099</td> <td>documentation unbekannt</td> </tr> </tbody> </table> | Kind | Value | Annotation | enumeration | 0371001 | documentation keine | enumeration | 0371002 | documentation leicht | enumeration | 0371003 | documentation mittel | enumeration | 0371004 | documentation schwer | enumeration | 0371099 | documentation unbekannt |
| Kind | Value | Annotation | | | | | | | | | | | | | | | | | |
| enumeration | 0371001 | documentation keine | | | | | | | | | | | | | | | | | |
| enumeration | 0371002 | documentation leicht | | | | | | | | | | | | | | | | | |
| enumeration | 0371003 | documentation mittel | | | | | | | | | | | | | | | | | |
| enumeration | 0371004 | documentation schwer | | | | | | | | | | | | | | | | | |
| enumeration | 0371099 | documentation unbekannt | | | | | | | | | | | | | | | | | |
| source | <code><element name="PAA_VerkalkungsgradSchluessel" type="enum_0371"/></code> | | | | | | | | | | | | | | | | | | |

element **PatientenaufnahmeAortenklappeBasis/PAA_CtCalcium**

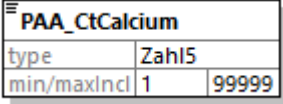
| diagram |  | | | | | | | | | |
|--------------|---|------------|-------|------------|--------------|---|--|--------------|-------|--|
| type | Zahl5 | | | | | | | | | |
| properties | content simple | | | | | | | | | |
| facets | <table border="1"> <thead> <tr> <th>Kind</th> <th>Value</th> <th>Annotation</th> </tr> </thead> <tbody> <tr> <td>minInclusive</td> <td>1</td> <td></td> </tr> <tr> <td>maxInclusive</td> <td>99999</td> <td></td> </tr> </tbody> </table> | Kind | Value | Annotation | minInclusive | 1 | | maxInclusive | 99999 | |
| Kind | Value | Annotation | | | | | | | | |
| minInclusive | 1 | | | | | | | | | |
| maxInclusive | 99999 | | | | | | | | | |
| source | <code><element name="PAA_CtCalcium" type="Zahl5"/></code> | | | | | | | | | |

element **PatientenaufnahmeAortenklappeBasis/PAA_CtCalciumUnbekannt**

| diagram | | | | | | | |
|------------|--|------------|-------|------------|---------|-----|--|
| type | JaLeer | | | | | | |
| properties | content simple | | | | | | |
| facets | <table border="1"> <thead> <tr> <th>Kind</th> <th>Value</th> <th>Annotation</th> </tr> </thead> <tbody> <tr> <td>pattern</td> <td>(1)</td> <td></td> </tr> </tbody> </table> | Kind | Value | Annotation | pattern | (1) | |
| Kind | Value | Annotation | | | | | |
| pattern | (1) | | | | | | |
| source | <code><element name="PAA_CtCalciumUnbekannt" type="JaLeer"/></code> | | | | | | |

element **PatientenaufnahmeAortenklappeBasis/PAA_LvotSchluessel**

| diagram | | | | | | | | | | | | | | | | |
|-------------|---|----------------------------------|-------|------------|-------------|---------|-----------------------|-------------|---------|---------------------------------|-------------|---------|----------------------------------|-------------|---------|----------------------------|
| type | enum 0359 | | | | | | | | | | | | | | | |
| properties | content simple | | | | | | | | | | | | | | | |
| facets | <table border="1"> <thead> <tr> <th>Kind</th> <th>Value</th> <th>Annotation</th> </tr> </thead> <tbody> <tr> <td>enumeration</td> <td>0359001</td> <td>documentation nein</td> </tr> <tr> <td>enumeration</td> <td>0359002</td> <td>documentation ja - einseitig</td> </tr> <tr> <td>enumeration</td> <td>0359003</td> <td>documentation ja - beidseitig</td> </tr> <tr> <td>enumeration</td> <td>0359042</td> <td>documentation unbekannt</td> </tr> </tbody> </table> | Kind | Value | Annotation | enumeration | 0359001 | documentation nein | enumeration | 0359002 | documentation ja - einseitig | enumeration | 0359003 | documentation ja - beidseitig | enumeration | 0359042 | documentation unbekannt |
| Kind | Value | Annotation | | | | | | | | | | | | | | |
| enumeration | 0359001 | documentation nein | | | | | | | | | | | | | | |
| enumeration | 0359002 | documentation ja - einseitig | | | | | | | | | | | | | | |
| enumeration | 0359003 | documentation ja - beidseitig | | | | | | | | | | | | | | |
| enumeration | 0359042 | documentation unbekannt | | | | | | | | | | | | | | |
| source | <code><element name="PAA_LvotSchluessel" type="enum_0359"/></code> | | | | | | | | | | | | | | | |

element **PatientenaufnahmeAortenklappeBasis/PAA_BiUnicuspideKlappeSchluessel**

| diagram | | | | | | | | | | | | | | | | |
|-------------|---|---------------------------------|-------|------------|-------------|---------|-----------------------|-------------|---------|--------------------------------|-------------|---------|---------------------------------|-------------|---------|----------------------------|
| type | enum 0372 | | | | | | | | | | | | | | | |
| properties | content simple | | | | | | | | | | | | | | | |
| facets | <table border="1"> <thead> <tr> <th>Kind</th> <th>Value</th> <th>Annotation</th> </tr> </thead> <tbody> <tr> <td>enumeration</td> <td>0372001</td> <td>documentation nein</td> </tr> <tr> <td>enumeration</td> <td>0372002</td> <td>documentation ja, bicuspide</td> </tr> <tr> <td>enumeration</td> <td>0372003</td> <td>documentation ja, unicuspide</td> </tr> <tr> <td>enumeration</td> <td>0372099</td> <td>documentation unbekannt</td> </tr> </tbody> </table> | Kind | Value | Annotation | enumeration | 0372001 | documentation nein | enumeration | 0372002 | documentation ja, bicuspide | enumeration | 0372003 | documentation ja, unicuspide | enumeration | 0372099 | documentation unbekannt |
| Kind | Value | Annotation | | | | | | | | | | | | | | |
| enumeration | 0372001 | documentation nein | | | | | | | | | | | | | | |
| enumeration | 0372002 | documentation ja, bicuspide | | | | | | | | | | | | | | |
| enumeration | 0372003 | documentation ja, unicuspide | | | | | | | | | | | | | | |
| enumeration | 0372099 | documentation unbekannt | | | | | | | | | | | | | | |
| source | <code><element name="PAA_BiUnicuspideKlappeSchluessel" type="enum_0372"/></code> | | | | | | | | | | | | | | | |

element **PatientenaufnahmeAortenklappeBasis/PAA_AortenstenoseSchluessel**

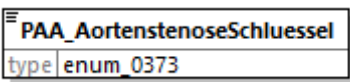
| | | | |
|------------|---|---------|-------------------------------|
| diagram |  | | |
| type | enum 0373 | | |
| properties | content simple | | |
| facets | Kind | Value | Annotation |
| | enumeration | 0373001 | documentation keine |
| | enumeration | 0373002 | documentation leichtgradig |
| | enumeration | 0373003 | documentation mittelgradig |
| | enumeration | 0373004 | documentation hochgradig |
| | enumeration | 0373099 | documentation unbekannt |
| source | <code><element name="PAA_AortenstenoseSchluessel" type="enum_0373"/></code> | | |

element **PatientenaufnahmeAortenklappeBasis/PAA_AorteninsuffizienzSchluessel**

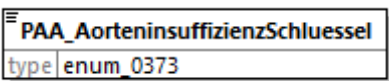
| | | | |
|------------|--|---------|-------------------------------|
| diagram |  | | |
| type | enum 0373 | | |
| properties | content simple | | |
| facets | Kind | Value | Annotation |
| | enumeration | 0373001 | documentation keine |
| | enumeration | 0373002 | documentation leichtgradig |
| | enumeration | 0373003 | documentation mittelgradig |
| | enumeration | 0373004 | documentation hochgradig |
| | enumeration | 0373099 | documentation unbekannt |
| source | <code><element name="PAA_AorteninsuffizienzSchluessel" type="enum_0373"/></code> | | |

element **PatientenaufnahmeAortenklappeBasis/PAA_MitralinsuffizienzSchluessel**

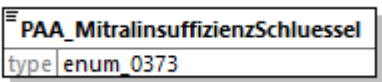
| | | | |
|------------|---|---------|-------------------------------|
| diagram |  | | |
| type | enum 0373 | | |
| properties | content simple | | |
| facets | Kind | Value | Annotation |
| | enumeration | 0373001 | documentation keine |
| | enumeration | 0373002 | documentation leichtgradig |
| | enumeration | 0373003 | documentation mittelgradig |

| | |
|--------|--|
| | enumeration 0373004 documentation hochgradig |
| | enumeration 0373099 documentation unbekannt |
| source | <code><element name="PAA_MitralinsuffizienzSchluessel" type="enum_0373"/></code> |

element **PatientenaufnahmeAortenklappeBasis/PAA_TrikuspidalinsuffizienzSchluessel**

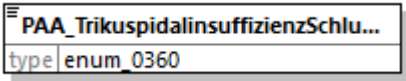
| | | | |
|------------|---|---------|----------------------------|
| diagram |  | | |
| type | enum 0360 | | |
| properties | content simple | | |
| facets | Kind | Value | Annotation |
| | enumeration | 0360001 | documentation keine |
| | enumeration | 0360002 | documentation leichtgradig |
| | enumeration | 0360003 | documentation mittelgradig |
| | enumeration | 0360004 | documentation hochgradig |
| | enumeration | 0360005 | documentation massive |
| | enumeration | 0360006 | documentation torrential |
| | enumeration | 0360099 | documentation unbekannt |
| source | <code><element name="PAA_TrikuspidalinsuffizienzSchluessel" type="enum_0360"/></code> | | |

element **PatientenaufnahmeAortenklappeBasis/PAA_ValvuloplastieSchluessel**

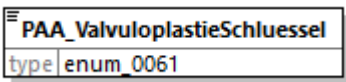
| | | | |
|------------|---|---------|-------------------------|
| diagram |  | | |
| type | enum 0061 | | |
| properties | content simple | | |
| facets | Kind | Value | Annotation |
| | enumeration | 0061001 | documentation ja |
| | enumeration | 0061002 | documentation nein |
| | enumeration | 0061099 | documentation unbekannt |
| source | <code><element name="PAA_ValvuloplastieSchluessel" type="enum_0061"/></code> | | |

element **PatientenaufnahmeAortenklappeBasis/PAA_StsScore**

| | | | |
|---------|---|--|--|
| diagram |  | | |
|---------|---|--|--|

| type | Zahl3_1 | | | | | | | | | | | | | | | |
|----------------|--|------------|-------|------------|--------------|-----|--|--------------|-------|--|-------------|---|--|----------------|---|--|
| properties | minOcc 0 maxOcc 1 content simple | | | | | | | | | | | | | | | |
| facets | <table border="1"> <thead> <tr> <th>Kind</th> <th>Value</th> <th>Annotation</th> </tr> </thead> <tbody> <tr> <td>minInclusive</td> <td>0.1</td> <td></td> </tr> <tr> <td>maxInclusive</td> <td>999.9</td> <td></td> </tr> <tr> <td>totalDigits</td> <td>4</td> <td></td> </tr> <tr> <td>fractionDigits</td> <td>1</td> <td></td> </tr> </tbody> </table> | Kind | Value | Annotation | minInclusive | 0.1 | | maxInclusive | 999.9 | | totalDigits | 4 | | fractionDigits | 1 | |
| Kind | Value | Annotation | | | | | | | | | | | | | | |
| minInclusive | 0.1 | | | | | | | | | | | | | | | |
| maxInclusive | 999.9 | | | | | | | | | | | | | | | |
| totalDigits | 4 | | | | | | | | | | | | | | | |
| fractionDigits | 1 | | | | | | | | | | | | | | | |
| source | <code><element name="PAA_StsScore" type="Zahl3_1" minOccurs="0"/></code> | | | | | | | | | | | | | | | |

element **PatientenaufnahmeAortenklappeBasis/PAA_HypertonusSchluessel**

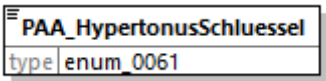
| diagram |  | | | | | | | | | | | | |
|-------------|---|----------------------------|-------|------------|-------------|---------|---------------------|-------------|---------|-----------------------|-------------|---------|----------------------------|
| type | enum 0061 | | | | | | | | | | | | |
| properties | content simple | | | | | | | | | | | | |
| facets | <table border="1"> <thead> <tr> <th>Kind</th> <th>Value</th> <th>Annotation</th> </tr> </thead> <tbody> <tr> <td>enumeration</td> <td>0061001</td> <td>documentation ja</td> </tr> <tr> <td>enumeration</td> <td>0061002</td> <td>documentation nein</td> </tr> <tr> <td>enumeration</td> <td>0061099</td> <td>documentation unbekannt</td> </tr> </tbody> </table> | Kind | Value | Annotation | enumeration | 0061001 | documentation ja | enumeration | 0061002 | documentation nein | enumeration | 0061099 | documentation unbekannt |
| Kind | Value | Annotation | | | | | | | | | | | |
| enumeration | 0061001 | documentation ja | | | | | | | | | | | |
| enumeration | 0061002 | documentation nein | | | | | | | | | | | |
| enumeration | 0061099 | documentation unbekannt | | | | | | | | | | | |
| source | <code><element name="PAA_HypertonusSchluessel" type="enum_0061"/></code> | | | | | | | | | | | | |

element **PatientenaufnahmeAortenklappeBasis/PAA_MyokardinfarktSchluessel**

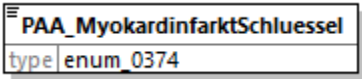
| diagram |  | | | | | | | | | | | | | | | | | | | | | | | | |
|-------------|--|--|-------|------------|-------------|---------|-----------------------|-------------|---------|--------------------------------------|-------------|---------|--|-------------|---------|--|-------------|---------|---|-------------|---------|-----------------------------------|-------------|---------|----------------------------|
| type | enum 0374 | | | | | | | | | | | | | | | | | | | | | | | | |
| properties | content simple | | | | | | | | | | | | | | | | | | | | | | | | |
| facets | <table border="1"> <thead> <tr> <th>Kind</th> <th>Value</th> <th>Annotation</th> </tr> </thead> <tbody> <tr> <td>enumeration</td> <td>0374001</td> <td>documentation nein</td> </tr> <tr> <td>enumeration</td> <td>0374002</td> <td>documentation ja, &lt;= 6 Stunden</td> </tr> <tr> <td>enumeration</td> <td>0374003</td> <td>documentation ja, &gt; 6 Stunden bis &lt;= 24 Stunden</td> </tr> <tr> <td>enumeration</td> <td>0374004</td> <td>documentation ja, &gt; 1 bis 7 Tage</td> </tr> <tr> <td>enumeration</td> <td>0374005</td> <td>documentation ja, &gt; 7 bis 21 Tage</td> </tr> <tr> <td>enumeration</td> <td>0374006</td> <td>documentation ja, &gt; 21 Tage</td> </tr> <tr> <td>enumeration</td> <td>0374099</td> <td>documentation unbekannt</td> </tr> </tbody> </table> | Kind | Value | Annotation | enumeration | 0374001 | documentation nein | enumeration | 0374002 | documentation ja, <= 6 Stunden | enumeration | 0374003 | documentation ja, > 6 Stunden bis <= 24 Stunden | enumeration | 0374004 | documentation ja, > 1 bis 7 Tage | enumeration | 0374005 | documentation ja, > 7 bis 21 Tage | enumeration | 0374006 | documentation ja, > 21 Tage | enumeration | 0374099 | documentation unbekannt |
| Kind | Value | Annotation | | | | | | | | | | | | | | | | | | | | | | | |
| enumeration | 0374001 | documentation nein | | | | | | | | | | | | | | | | | | | | | | | |
| enumeration | 0374002 | documentation ja, <= 6 Stunden | | | | | | | | | | | | | | | | | | | | | | | |
| enumeration | 0374003 | documentation ja, > 6 Stunden bis <= 24 Stunden | | | | | | | | | | | | | | | | | | | | | | | |
| enumeration | 0374004 | documentation ja, > 1 bis 7 Tage | | | | | | | | | | | | | | | | | | | | | | | |
| enumeration | 0374005 | documentation ja, > 7 bis 21 Tage | | | | | | | | | | | | | | | | | | | | | | | |
| enumeration | 0374006 | documentation ja, > 21 Tage | | | | | | | | | | | | | | | | | | | | | | | |
| enumeration | 0374099 | documentation unbekannt | | | | | | | | | | | | | | | | | | | | | | | |
| source | <code><element name="PAA_MyokardinfarktSchluessel" type="enum_0374"/></code> | | | | | | | | | | | | | | | | | | | | | | | | |

element **PatientenaufnahmeAortenklappeBasis/PAA_SymptomeSchluessel**

| | | | |
|------------|--|---------|---|
| diagram | | | |
| type | enum 0375 | | |
| properties | content simple | | |
| facets | Kind | Value | Annotation |
| | enumeration | 0375001 | documentation keine Symptome oder Angina |
| | enumeration | 0375002 | documentation Symptome, aber keine Ischämiezeichen |
| | enumeration | 0375003 | documentation stabile Angina |
| | enumeration | 0375004 | documentation instabile Angina |
| | enumeration | 0375005 | documentation Infarkt ohne ST-Hebung (Non-STEMI) |
| | enumeration | 0375006 | documentation Infarkt mit ST-Hebung (STEMI) |
| | enumeration | 0375042 | documentation unbekannt |
| source | <pre><element name="PAA_SymptomeSchluessel" type="enum_0375"/></pre> | | |

complexType **InfektionAortenklappeBasis**

| | | | |
|-----------|---|---|--|
| diagram | | | |
| namespace | http://xml.ir-d.de/emg | | |
| children | IAK_InfektionSchluessel | | |
| used by | element | PatientenaufnahmeAortenklappe/infektionAortenklappe | |
| source | <pre><complexType name="InfektionAortenklappeBasis"> <sequence> <element name="IAK_InfektionSchluessel" type="enum_0367"/> </sequence> </complexType></pre> | | |

element **InfektionAortenklappeBasis/IAK_InfektionSchluessel**

| | | | |
|------------|---------------------------|---------|--------------------------------|
| diagram | | | |
| type | enum 0367 | | |
| properties | content simple | | |
| facets | Kind | Value | Annotation |
| | enumeration | 0367001 | documentation keine |
| | enumeration | 0367002 | documentation Mediastinitis |
| | enumeration | 0367003 | documentation Sepsis |
| | enumeration | 0367004 | documentation |

| | | | |
|--------|---|---------|--|
| | enumeration | 0367005 | broncho-pulmonale Infektion documentation |
| | enumeration | 0367006 | oto-laryngologische Infektion documentation |
| | enumeration | 0367007 | floride Endokarditis documentation |
| | enumeration | 0367008 | Peritonitis documentation |
| | enumeration | 0367009 | Wundinfektion Thorax documentation |
| | enumeration | 0367010 | Pleuraempyem documentation |
| | enumeration | 0367011 | Venenkatheterinfektion documentation |
| | enumeration | 0367012 | Harnwegsinfektion documentation |
| | enumeration | 0367013 | Wundinfektion untere Extremitäten documentation |
| | enumeration | 0367014 | HIV-Infektion documentation |
| | enumeration | 0367015 | Hepatitis B oder C documentation |
| | enumeration | 0367042 | andere Wundinfektion documentation |
| | enumeration | 0367042 | sonstige Infektion |
| source | <code><element name="IAK_InfektionSchluessel" type="enum_0367"/></code> | | |

complexType **ArtikelbeschreibungBasis**

| | |
|------------------|---|
| <p>diagram</p> | |
| <p>namespace</p> | <p>http://xml.ir-d.de/emg</p> |
| <p>children</p> | <p>ARB LotNumer ARB LotNumerUnbekannt ARB SerienNumer ARB SerienNumerUnbekannt ARB DatumVerfall ARB DatumVerfallUnbekannt ARB Artikelbezeichnung ARB DatumImplantierungExplantat ARB DatumImplantierungExplantatUnbekannt</p> |
| <p>used by</p> | <p>complexType Artikelbeschreibung</p> |
| <p>source</p> | <pre><complexType name="ArtikelbeschreibungBasis"> <sequence> <choice minOccurs="0"> <element name="ARB_LotNumer" type="String20"/> <element name="ARB_LotNumerUnbekannt" type="JaLeer"/> </choice> <choice minOccurs="0"> <element name="ARB_SerienNumer" type="String20"/> <element name="ARB_SerienNumerUnbekannt" type="JaLeer"/> </choice> <choice minOccurs="0"> <element name="ARB_DatumVerfall" type="String20"/> <element name="ARB_DatumVerfallUnbekannt" type="JaLeer"/> </choice> <element name="ARB Artikelbezeichnung" type="Freitext250" minOccurs="0"/> <choice minOccurs="0"> <element name="ARB_DatumImplantierungExplantat" type="DatumText" pattern="((([0-9]{4}) ([-][0-9]{2}))?([-][0-9]{2}...))"/> <element name="ARB_DatumImplantierungExplantatUnbekannt" type="JaLeer" pattern="(1)"/> </choice> </sequence> </complexType></pre> |

| | |
|--|--|
| | <pre> <choice minOccurs="0"> <element name="ARB_DatumImplantierungExplantat" type="DatumText"/> <element name="ARB_DatumImplantierungExplantatUnbekannt" type="JaLeer"/> </choice> </sequence> </complexType> </pre> |
|--|--|

element **ArtikelbeschreibungBasis/ARB_LotNumber**

| diagram | | | | | | | |
|------------|---|------------|-------|------------|-----------|----|--|
| type | String20 | | | | | | |
| properties | content simple | | | | | | |
| facets | <table border="1"> <thead> <tr> <th>Kind</th> <th>Value</th> <th>Annotation</th> </tr> </thead> <tbody> <tr> <td>maxLength</td> <td>20</td> <td></td> </tr> </tbody> </table> | Kind | Value | Annotation | maxLength | 20 | |
| Kind | Value | Annotation | | | | | |
| maxLength | 20 | | | | | | |
| source | <code><element name="ARB_LotNumber" type="String20"/></code> | | | | | | |

element **ArtikelbeschreibungBasis/ARB_LotNumberUnbekannt**

| diagram | | | | | | | |
|------------|--|------------|-------|------------|---------|-----|--|
| type | JaLeer | | | | | | |
| properties | content simple | | | | | | |
| facets | <table border="1"> <thead> <tr> <th>Kind</th> <th>Value</th> <th>Annotation</th> </tr> </thead> <tbody> <tr> <td>pattern</td> <td>(1)</td> <td></td> </tr> </tbody> </table> | Kind | Value | Annotation | pattern | (1) | |
| Kind | Value | Annotation | | | | | |
| pattern | (1) | | | | | | |
| source | <code><element name="ARB_LotNumberUnbekannt" type="JaLeer"/></code> | | | | | | |

element **ArtikelbeschreibungBasis/ARB_SerienNumber**

| diagram | | | | | | | |
|------------|---|------------|-------|------------|-----------|----|--|
| type | String20 | | | | | | |
| properties | content simple | | | | | | |
| facets | <table border="1"> <thead> <tr> <th>Kind</th> <th>Value</th> <th>Annotation</th> </tr> </thead> <tbody> <tr> <td>maxLength</td> <td>20</td> <td></td> </tr> </tbody> </table> | Kind | Value | Annotation | maxLength | 20 | |
| Kind | Value | Annotation | | | | | |
| maxLength | 20 | | | | | | |
| source | <code><element name="ARB_SerienNumber" type="String20"/></code> | | | | | | |

element **ArtikelbeschreibungBasis/ARB_SerienNummerUnbekannt**

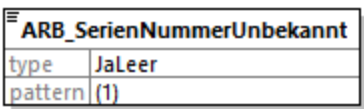
| | |
|------------|---|
| diagram |  |
| type | JaLeer |
| properties | content simple |
| facets | Kind Value Annotation pattern (1) |
| source | <code><element name="ARB_SerienNummerUnbekannt" type="JaLeer"/></code> |

element **ArtikelbeschreibungBasis/ARB_DatumVerfall**

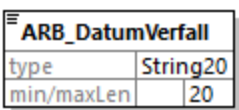
| | |
|------------|---|
| diagram |  |
| type | String20 |
| properties | content simple |
| facets | Kind Value Annotation maxLength 20 |
| source | <code><element name="ARB_DatumVerfall" type="String20"/></code> |

element **ArtikelbeschreibungBasis/ARB_DatumVerfallUnbekannt**

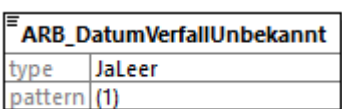
| | |
|------------|---|
| diagram |  |
| type | JaLeer |
| properties | content simple |
| facets | Kind Value Annotation pattern (1) |
| source | <code><element name="ARB_DatumVerfallUnbekannt" type="JaLeer"/></code> |

element **ArtikelbeschreibungBasis/ARB_Artikelbezeichnung**

| | |
|------------|---|
| diagram |  |
| type | Freitext250 |
| properties | minOcc 0 maxOcc 1 content simple |
| facets | Kind Value Annotation maxLength 250 |

| | |
|--------|--|
| source | <code><element name="ARB_Artikelbezeichnung" type="Freitext250" minOccurs="0"/></code> |
|--------|--|

element **ArtikelbeschreibungBasis/ARB_DatumImplantierungExplantat**

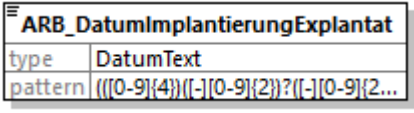
| | | | | | | | |
|------------|---|------------|-------|------------|---------|--|--|
| diagram |  | | | | | | |
| type | DatumText | | | | | | |
| properties | content simple | | | | | | |
| facets | <table border="1"> <tr> <td>Kind</td> <td>Value</td> <td>Annotation</td> </tr> <tr> <td>pattern</td> <td>(([0-9]{4})([-][0-9]{2})?([-][0-9]{2}...))</td> <td></td> </tr> </table> | Kind | Value | Annotation | pattern | (([0-9]{4})([-][0-9]{2})?([-][0-9]{2}...)) | |
| Kind | Value | Annotation | | | | | |
| pattern | (([0-9]{4})([-][0-9]{2})?([-][0-9]{2}...)) | | | | | | |
| source | <code><element name="ARB_DatumImplantierungExplantat" type="DatumText"/></code> | | | | | | |

element **ArtikelbeschreibungBasis/ARB_DatumImplantierungExplantatUnbekannt**

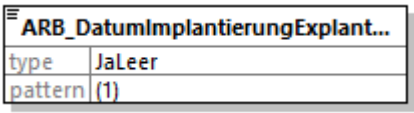
| | | | | | | | |
|------------|--|------------|-------|------------|---------|-----|--|
| diagram |  | | | | | | |
| type | JaLeer | | | | | | |
| properties | content simple | | | | | | |
| facets | <table border="1"> <tr> <td>Kind</td> <td>Value</td> <td>Annotation</td> </tr> <tr> <td>pattern</td> <td>(1)</td> <td></td> </tr> </table> | Kind | Value | Annotation | pattern | (1) | |
| Kind | Value | Annotation | | | | | |
| pattern | (1) | | | | | | |
| source | <code><element name="ARB_DatumImplantierungExplantatUnbekannt" type="JaLeer"/></code> | | | | | | |

complexType **ArtikelBrustimplantatBasis**

| | |
|------------------|---|
| <p>diagram</p> | |
| <p>namespace</p> | <p>http://xml.ir-d.de/emg</p> |
| <p>children</p> | <p>ABI_HerstellerSchluessel ABI_HerstellerUnbekannt ABI_HerstellerSonstiger ABI_ArtikelTypSchluessel ABI_FormSchluessel ABI_FormUnbekannt ABI_OberflaecheSchluessel ABI_OberflaecheUnbekannt ABI_FuellungSchluessel ABI_FuellungUnbekannt ABI_Volumen ABI_VolumenUnbekannt ABI_IntraoperativesVolumen</p> |
| <p>used by</p> | <p>element Artikelbeschreibung/artikelBrustimplantat</p> |
| <p>source</p> | <pre><complexType name="ArtikelBrustimplantatBasis"> <sequence> <choice></pre> |

```

<element name="ABI_HerstellerSchluessel" type="enum_0130"/>
<element name="ABI_HerstellerUnbekannt" type="JaLeer"/>
</choice>
<element name="ABI_HerstellerSonstiger" type="Freitext250" minOccurs="0"/>
<element name="ABI_ArtikelTypSchluessel" type="enum_0190"/>
<choice>
  <element name="ABI_FormSchluessel" type="enum_0126"/>
  <element name="ABI_FormUnbekannt" type="JaLeer"/>
</choice>
<choice>
  <element name="ABI_OberflaecheSchluessel" type="enum_0128"/>
  <element name="ABI_OberflaecheUnbekannt" type="JaLeer"/>
</choice>
<choice>
  <element name="ABI_FuellungSchluessel" type="enum_0124"/>
  <element name="ABI_FuellungUnbekannt" type="JaLeer"/>
</choice>
<choice>
  <element name="ABI_Volumen" type="Zahl5"/>
  <element name="ABI_VolumenUnbekannt" type="JaLeer"/>
</choice>
<element name="ABI_IntraoperativesVolumen" type="Zahl5mitNull"
minOccurs="0"/>
</sequence>
</complexType>

```

element ArtikelBrustimplantatBasis/ABI_HerstellerSchluessel

| | | | |
|------------|---|---------|--|
| diagram |  | | |
| type | enum 0130 | | |
| properties | content simple | | |
| facets | Kind | Value | Annotation |
| | enumeration | 0130001 | documentation Allergan |
| | enumeration | 0130002 | documentation Cereplas |
| | enumeration | 0130003 | documentation CUI (Cox Uphoff Implants) |
| | enumeration | 0130004 | documentation EMSI Biomedical |
| | enumeration | 0130005 | documentation Establishment labs |
| | enumeration | 0130006 | documentation Eurosilicone |
| | enumeration | 0130007 | documentation Nagor |
| | enumeration | 0130008 | documentation Groupe Sebbin |
| | enumeration | 0130009 | documentation Laboratoires Arion |
| | enumeration | 0130010 | documentation Mentor |
| | enumeration | 0130011 | documentation Pérouse Plastie SAS |
| | enumeration | 0130012 | documentation PIP M-Implants |

| | | | | |
|--------|--|---------|---------------|------------------------------|
| | enumeration | 0130013 | documentation | Polytech Health & Aesthetics |
| | enumeration | 0130014 | documentation | Silimed |
| | enumeration | 0130015 | documentation | Surgitek |
| | enumeration | 0130016 | documentation | G&G Biotechnology |
| | enumeration | 0130017 | documentation | nicht belegter Wert |
| | enumeration | 0130018 | documentation | nicht belegter Wert |
| | enumeration | 0130019 | documentation | nicht belegter Wert |
| | enumeration | 0130020 | documentation | nicht belegter Wert |
| | enumeration | 0130021 | documentation | nicht belegter Wert |
| | enumeration | 0130042 | documentation | sonstiger |
| source | <code><element name="ABI_HerstellerSchluessel" type="enum_0130"/></code> | | | |

element **ArtikelBrustimplantatBasis/ABI_HerstellerUnbekannt**

| | |
|------------|--|
| diagram | |
| type | JaLeer |
| properties | content simple |
| facets | Kind Value Annotation pattern (1) |
| source | <code><element name="ABI_HerstellerUnbekannt" type="JaLeer"/></code> |

element **ArtikelBrustimplantatBasis/ABI_HerstellerSonstiger**

| | |
|------------|---|
| diagram | |
| type | Freitext250 |
| properties | minOcc 0 maxOcc 1 content simple |
| facets | Kind Value Annotation maxLength 250 |
| source | <code><element name="ABI_HerstellerSonstiger" type="Freitext250" minOccurs="0"/></code> |

element **ArtikelBrustimplantatBasis/ABI_ArtikelTypSchluessel**

| | |
|---------|--|
| diagram | |
|---------|--|

| type | enum_0190 | | | | | | | | | |
|-------------|--|---------------------------------|-------|------------|-------------|---------|---------------------------------|-------------|---------|--------------------------------|
| properties | content simple | | | | | | | | | |
| facets | <table border="1"> <thead> <tr> <th>Kind</th> <th>Value</th> <th>Annotation</th> </tr> </thead> <tbody> <tr> <td>enumeration</td> <td>0190001</td> <td>documentation Brustimplantat</td> </tr> <tr> <td>enumeration</td> <td>0190003</td> <td>documentation Brustexpander</td> </tr> </tbody> </table> | Kind | Value | Annotation | enumeration | 0190001 | documentation Brustimplantat | enumeration | 0190003 | documentation Brustexpander |
| Kind | Value | Annotation | | | | | | | | |
| enumeration | 0190001 | documentation Brustimplantat | | | | | | | | |
| enumeration | 0190003 | documentation Brustexpander | | | | | | | | |
| source | <code><element name="ABI_ArtikelTypSchluessel" type="enum_0190"/></code> | | | | | | | | | |

element ArtikelBrustimplantatBasis/ABI_FormSchluessel

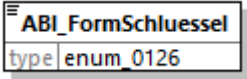
| diagram |  | | | | | | | | | | | | |
|-------------|---|---|-------|------------|-------------|---------|---|-------------|---------|--|-------------|---------|---------------------------|
| type | enum_0126 | | | | | | | | | | | | |
| properties | content simple | | | | | | | | | | | | |
| facets | <table border="1"> <thead> <tr> <th>Kind</th> <th>Value</th> <th>Annotation</th> </tr> </thead> <tbody> <tr> <td>enumeration</td> <td>0126001</td> <td>documentation anatomisch (tropfenförmig)</td> </tr> <tr> <td>enumeration</td> <td>0126002</td> <td>documentation rund (punktsymmetrisch)</td> </tr> <tr> <td>enumeration</td> <td>0126042</td> <td>documentation sonstige</td> </tr> </tbody> </table> | Kind | Value | Annotation | enumeration | 0126001 | documentation anatomisch (tropfenförmig) | enumeration | 0126002 | documentation rund (punktsymmetrisch) | enumeration | 0126042 | documentation sonstige |
| Kind | Value | Annotation | | | | | | | | | | | |
| enumeration | 0126001 | documentation anatomisch (tropfenförmig) | | | | | | | | | | | |
| enumeration | 0126002 | documentation rund (punktsymmetrisch) | | | | | | | | | | | |
| enumeration | 0126042 | documentation sonstige | | | | | | | | | | | |
| source | <code><element name="ABI_FormSchluessel" type="enum_0126"/></code> | | | | | | | | | | | | |

element ArtikelBrustimplantatBasis/ABI_FormUnbekannt

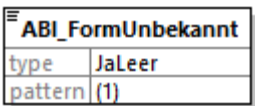
| diagram |  | | | | | | |
|------------|--|------------|-------|------------|---------|-----|--|
| type | JaLeer | | | | | | |
| properties | content simple | | | | | | |
| facets | <table border="1"> <thead> <tr> <th>Kind</th> <th>Value</th> <th>Annotation</th> </tr> </thead> <tbody> <tr> <td>pattern</td> <td>(1)</td> <td></td> </tr> </tbody> </table> | Kind | Value | Annotation | pattern | (1) | |
| Kind | Value | Annotation | | | | | |
| pattern | (1) | | | | | | |
| source | <code><element name="ABI_FormUnbekannt" type="JaLeer"/></code> | | | | | | |

element ArtikelBrustimplantatBasis/ABI_OberflaecheSchluessel

| diagram |  | | | | | | | | | | | | |
|-------------|---|------------------------------|-------|------------|-------------|---------|------------------------------|-------------|---------|------------------------------|-------------|---------|---------------|
| type | enum_0128 | | | | | | | | | | | | |
| properties | content simple | | | | | | | | | | | | |
| facets | <table border="1"> <thead> <tr> <th>Kind</th> <th>Value</th> <th>Annotation</th> </tr> </thead> <tbody> <tr> <td>enumeration</td> <td>0128001</td> <td>documentation glattwandig</td> </tr> <tr> <td>enumeration</td> <td>0128002</td> <td>documentation beschichtet</td> </tr> <tr> <td>enumeration</td> <td>0128003</td> <td>documentation</td> </tr> </tbody> </table> | Kind | Value | Annotation | enumeration | 0128001 | documentation glattwandig | enumeration | 0128002 | documentation beschichtet | enumeration | 0128003 | documentation |
| Kind | Value | Annotation | | | | | | | | | | | |
| enumeration | 0128001 | documentation glattwandig | | | | | | | | | | | |
| enumeration | 0128002 | documentation beschichtet | | | | | | | | | | | |
| enumeration | 0128003 | documentation | | | | | | | | | | | |

| | |
|--------|---|
| | texturiert |
| source | <code><element name="ABI_OberflaecheSchluesse1" type="enum_0128"/></code> |

element **ArtikelBrustimplantatBasis/ABI_OberflaecheUnbekannt**

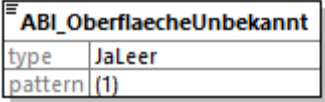
| | |
|------------|--|
| diagram |  <pre> classDiagram class ABI_OberflaecheUnbekannt { type JaLeer pattern (1) } </pre> |
| type | JaLeer |
| properties | content simple |
| facets | Kind Value Annotation pattern (1) |
| source | <code><element name="ABI_OberflaecheUnbekannt" type="JaLeer"/></code> |

element **ArtikelBrustimplantatBasis/ABI_FuellungSchluesse1**

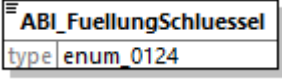
| diagram |  <pre> classDiagram class ABI_FuellungSchluesse1 { type enum_0124 } </pre> | | | | | | | | | | | | | | | |
|-------------|--|--|-------|------------|-------------|---------|-----------------------------|-------------|---------|-----------------------------|-------------|---------|--|-------------|---------|---------------------------|
| type | enum 0124 | | | | | | | | | | | | | | | |
| properties | content simple | | | | | | | | | | | | | | | |
| facets | <table border="1"> <thead> <tr> <th>Kind</th> <th>Value</th> <th>Annotation</th> </tr> </thead> <tbody> <tr> <td>enumeration</td> <td>0124001</td> <td>documentation Salzlösung</td> </tr> <tr> <td>enumeration</td> <td>0124002</td> <td>documentation Silikongel</td> </tr> <tr> <td>enumeration</td> <td>0124003</td> <td>documentation Kombination Silikongel und Salzlösung</td> </tr> <tr> <td>enumeration</td> <td>0124042</td> <td>documentation sonstige</td> </tr> </tbody> </table> | Kind | Value | Annotation | enumeration | 0124001 | documentation Salzlösung | enumeration | 0124002 | documentation Silikongel | enumeration | 0124003 | documentation Kombination Silikongel und Salzlösung | enumeration | 0124042 | documentation sonstige |
| Kind | Value | Annotation | | | | | | | | | | | | | | |
| enumeration | 0124001 | documentation Salzlösung | | | | | | | | | | | | | | |
| enumeration | 0124002 | documentation Silikongel | | | | | | | | | | | | | | |
| enumeration | 0124003 | documentation Kombination Silikongel und Salzlösung | | | | | | | | | | | | | | |
| enumeration | 0124042 | documentation sonstige | | | | | | | | | | | | | | |
| source | <code><element name="ABI_FuellungSchluesse1" type="enum_0124"/></code> | | | | | | | | | | | | | | | |

element **ArtikelBrustimplantatBasis/ABI_FuellungUnbekannt**

| | |
|------------|---|
| diagram |  <pre> classDiagram class ABI_FuellungUnbekannt { type JaLeer pattern (1) } </pre> |
| type | JaLeer |
| properties | content simple |
| facets | Kind Value Annotation pattern (1) |
| source | <code><element name="ABI_FuellungUnbekannt" type="JaLeer"/></code> |

element **ArtikelBrustimplantatBasis/ABI_Volumen**

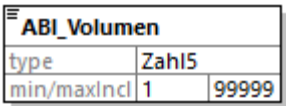
| diagram |  | | | | | | | | | |
|--------------|---|------------|-------|------------|--------------|---|--|--------------|-------|--|
| type | Zahl5 | | | | | | | | | |
| properties | content simple | | | | | | | | | |
| facets | <table border="1"> <thead> <tr> <th>Kind</th> <th>Value</th> <th>Annotation</th> </tr> </thead> <tbody> <tr> <td>minInclusive</td> <td>1</td> <td></td> </tr> <tr> <td>maxInclusive</td> <td>99999</td> <td></td> </tr> </tbody> </table> | Kind | Value | Annotation | minInclusive | 1 | | maxInclusive | 99999 | |
| Kind | Value | Annotation | | | | | | | | |
| minInclusive | 1 | | | | | | | | | |
| maxInclusive | 99999 | | | | | | | | | |
| source | <code><element name="ABI_Volumen" type="Zahl5"/></code> | | | | | | | | | |

element **ArtikelBrustimplantatBasis/ABI_VolumenUnbekannt**

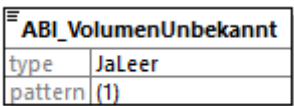
| diagram |  | | | | | | |
|------------|--|------------|-------|------------|---------|-----|--|
| type | JaLeer | | | | | | |
| properties | content simple | | | | | | |
| facets | <table border="1"> <thead> <tr> <th>Kind</th> <th>Value</th> <th>Annotation</th> </tr> </thead> <tbody> <tr> <td>pattern</td> <td>(1)</td> <td></td> </tr> </tbody> </table> | Kind | Value | Annotation | pattern | (1) | |
| Kind | Value | Annotation | | | | | |
| pattern | (1) | | | | | | |
| source | <code><element name="ABI_VolumenUnbekannt" type="JaLeer"/></code> | | | | | | |

element **ArtikelBrustimplantatBasis/ABI_IntraoperativesVolumen**

| diagram |  | | | | | | | | | |
|--------------|---|------------|-------|------------|--------------|---------|--------|--------------|-------|--|
| type | Zahl5mitNull | | | | | | | | | |
| properties | <table border="1"> <tbody> <tr> <td>minOcc</td> <td>0</td> </tr> <tr> <td>maxOcc</td> <td>1</td> </tr> <tr> <td>content</td> <td>simple</td> </tr> </tbody> </table> | minOcc | 0 | maxOcc | 1 | content | simple | | | |
| minOcc | 0 | | | | | | | | | |
| maxOcc | 1 | | | | | | | | | |
| content | simple | | | | | | | | | |
| facets | <table border="1"> <thead> <tr> <th>Kind</th> <th>Value</th> <th>Annotation</th> </tr> </thead> <tbody> <tr> <td>minInclusive</td> <td>0</td> <td></td> </tr> <tr> <td>maxInclusive</td> <td>99999</td> <td></td> </tr> </tbody> </table> | Kind | Value | Annotation | minInclusive | 0 | | maxInclusive | 99999 | |
| Kind | Value | Annotation | | | | | | | | |
| minInclusive | 0 | | | | | | | | | |
| maxInclusive | 99999 | | | | | | | | | |
| source | <code><element name="ABI_IntraoperativesVolumen" type="Zahl5mitNull" minOccurs="0"/></code> | | | | | | | | | |

complexType ArtikelEndoprotheseBasis

| | |
|-----------|--|
| diagram | |
| namespace | http://xml.ir-d.de/emg |
| children | AEP HerstellerSchluessel AEP HerstellerUnbekannt AEP HerstellerSonstiger AEP ArtikelTypSchluessel |
| used by | element Artikelbeschreibung/artikelEndoprothese |
| source | <pre> <complexType name="ArtikelEndoprotheseBasis"> <sequence> <choice> <element name="AEP_HerstellerSchluessel" type="enum_0230"/> <element name="AEP_HerstellerUnbekannt" type="JaLeer"/> </choice> <element name="AEP_HerstellerSonstiger" type="Freitext250" minOccurs="0"/> <element name="AEP_ArtikelTypSchluessel" type="enum_0290"/> </sequence> </complexType> </pre> |

element ArtikelEndoprotheseBasis/AEP_HerstellerSchluessel

| diagram | | | | | | | | | | | | | | | | | | | | | | | | | | | | | | | |
|-------------|--|---|-------|------------|-------------|---------|--------------------------------------|-------------|---------|---|-------------|---------|------------------------------|-------------|---------|-------------------------|-------------|---------|-----------------------------------|-------------|---------|---------------------------------|-------------|---------|---------------------------------------|-------------|---------|---------------------------------|-------------|---------|-----------------------------------|
| type | enum 0230 | | | | | | | | | | | | | | | | | | | | | | | | | | | | | | |
| properties | content simple | | | | | | | | | | | | | | | | | | | | | | | | | | | | | | |
| facets | <table border="1"> <thead> <tr> <th>Kind</th> <th>Value</th> <th>Annotation</th> </tr> </thead> <tbody> <tr> <td>enumeration</td> <td>0230001</td> <td>documentation Smith & Nephew GmbH</td> </tr> <tr> <td>enumeration</td> <td>0230002</td> <td>documentation Mathys Orthopädie GmbH</td> </tr> <tr> <td>enumeration</td> <td>0230003</td> <td>documentation Ceramtec AG</td> </tr> <tr> <td>enumeration</td> <td>0230004</td> <td>documentation Biomet</td> </tr> <tr> <td>enumeration</td> <td>0230005</td> <td>documentation Peter Brehm GmbH</td> </tr> <tr> <td>enumeration</td> <td>0230006</td> <td>documentation Amplitude GmbH</td> </tr> <tr> <td>enumeration</td> <td>0230007</td> <td>documentation Exactech Deutschland</td> </tr> <tr> <td>enumeration</td> <td>0230008</td> <td>documentation Globus Medical</td> </tr> <tr> <td>enumeration</td> <td>0230009</td> <td>documentation Implantcast GmbH</td> </tr> </tbody> </table> | Kind | Value | Annotation | enumeration | 0230001 | documentation Smith & Nephew GmbH | enumeration | 0230002 | documentation Mathys Orthopädie GmbH | enumeration | 0230003 | documentation Ceramtec AG | enumeration | 0230004 | documentation Biomet | enumeration | 0230005 | documentation Peter Brehm GmbH | enumeration | 0230006 | documentation Amplitude GmbH | enumeration | 0230007 | documentation Exactech Deutschland | enumeration | 0230008 | documentation Globus Medical | enumeration | 0230009 | documentation Implantcast GmbH |
| Kind | Value | Annotation | | | | | | | | | | | | | | | | | | | | | | | | | | | | | |
| enumeration | 0230001 | documentation Smith & Nephew GmbH | | | | | | | | | | | | | | | | | | | | | | | | | | | | | |
| enumeration | 0230002 | documentation Mathys Orthopädie GmbH | | | | | | | | | | | | | | | | | | | | | | | | | | | | | |
| enumeration | 0230003 | documentation Ceramtec AG | | | | | | | | | | | | | | | | | | | | | | | | | | | | | |
| enumeration | 0230004 | documentation Biomet | | | | | | | | | | | | | | | | | | | | | | | | | | | | | |
| enumeration | 0230005 | documentation Peter Brehm GmbH | | | | | | | | | | | | | | | | | | | | | | | | | | | | | |
| enumeration | 0230006 | documentation Amplitude GmbH | | | | | | | | | | | | | | | | | | | | | | | | | | | | | |
| enumeration | 0230007 | documentation Exactech Deutschland | | | | | | | | | | | | | | | | | | | | | | | | | | | | | |
| enumeration | 0230008 | documentation Globus Medical | | | | | | | | | | | | | | | | | | | | | | | | | | | | | |
| enumeration | 0230009 | documentation Implantcast GmbH | | | | | | | | | | | | | | | | | | | | | | | | | | | | | |

| | | |
|-------------|---------|---|
| enumeration | 0230010 | documentation DePuy Orthopädie GmbH |
| enumeration | 0230011 | documentation IO-International Orthopaedics |
| enumeration | 0230012 | documentation Joint Replacement Ltd. Instrumentation |
| enumeration | 0230013 | documentation Merete |
| enumeration | 0230014 | documentation S&G Implants GmbH |
| enumeration | 0230015 | documentation Speetec Implantate GmbH |
| enumeration | 0230016 | documentation Stemcup Medical Products GmbH |
| enumeration | 0230017 | documentation Symbios Deutschland GmbH |
| enumeration | 0230018 | documentation Tantum AG |
| enumeration | 0230019 | documentation Tomier GmbH |
| enumeration | 0230020 | documentation MicroPort Orthopedics GmbH |
| enumeration | 0230021 | documentation aap Implanate AG |
| enumeration | 0230022 | documentation AQImplants |
| enumeration | 0230023 | documentation ESKA Orthodynamics GmbH |
| enumeration | 0230024 | documentation Atesos medical AG |
| enumeration | 0230025 | documentation Chiropro GmbH |
| enumeration | 0230026 | documentation Medacta |
| enumeration | 0230027 | documentation OHST Medizintechnik AG |
| enumeration | 0230028 | documentation Lima Deutschland GmbH |
| enumeration | 0230029 | documentation alloPlus GmbH |
| enumeration | 0230030 | documentation Heraeus Medical GmbH |
| enumeration | 0230031 | documentation ImplanTec Deutschland GmbH |
| enumeration | 0230032 | documentation Falcon Medical GmbH |
| enumeration | 0230033 | documentation Meril GmbH |
| enumeration | 0230034 | documentation Zimmer Germany GmbH |
| enumeration | 0230035 | documentation Stryker GmbH & Co. KG |
| enumeration | 0230036 | documentation Aesculap AG |
| enumeration | 0230037 | documentation Waldemar Link GmbH & Co. KG |
| enumeration | 0230038 | documentation Corin Germany GmbH |
| enumeration | 0230039 | documentation nicht belegter Wert |
| enumeration | 0230040 | documentation nicht belegter Wert |
| enumeration | 0230041 | documentation nicht belegter Wert |
| enumeration | 0230042 | documentation nicht belegter Wert |

| | | |
|--------|--|--|
| | enumeration 0230043 | sonstige documentation nicht belegter Wert |
| | enumeration 0230044 | documentation nicht belegter Wert |
| source | <code><element name="AEP_HerstellerSchluessel" type="enum_0230"/></code> | |

element ArtikelEndoprotheseBasis/AEP_HerstellerUnbekannt

| | | |
|------------|---|------------------|
| diagram |  | |
| type | JaLeer | |
| properties | content simple | |
| facets | Kind | Value Annotation |
| | pattern | (1) |
| source | <code><element name="AEP_HerstellerUnbekannt" type="JaLeer"/></code> | |

element ArtikelEndoprotheseBasis/AEP_HerstellerSonstiger

| | | |
|------------|---|------------------|
| diagram |  | |
| type | Freitext250 | |
| properties | minOcc | 0 |
| | maxOcc | 1 |
| | content | simple |
| facets | Kind | Value Annotation |
| | maxLength | 250 |
| source | <code><element name="AEP_HerstellerSonstiger" type="Freitext250" minOccurs="0"/></code> | |

element ArtikelEndoprotheseBasis/AEP_ArtikelTypSchluessel

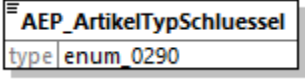
| | | |
|------------|---|---|
| diagram |  | |
| type | enum_0290 | |
| properties | content simple | |
| facets | Kind | Value Annotation |
| | enumeration | 0290001 documentation Hüft-Komponente |
| | enumeration | 0290002 documentation Knie-Komponente |
| | enumeration | 0290003 documentation Modulare Komponente (Hüfte/Knie) |
| source | <code><element name="AEP_ArtikelTypSchluessel" type="enum_0290"/></code> | |

complexType **ArtikelAortenklappeBasis**

| | |
|-----------|---|
| diagram | |
| namespace | http://xml.ir-d.de/emg |
| children | AAK ArtikelTypSchluessel AAK HerstellerSchluessel AAK HerstellerUnbekannt AAK HerstellerSonstiger AAK ProthesenGroesse AAK ProthesenGroesseUnbekannt AAK Dislokation |
| used by | element Artikelbeschreibung/artikelAortenklappe |
| source | <pre> <complexType name="ArtikelAortenklappeBasis"> <sequence> <element name="AAK_ArtikelTypSchluessel" type="enum_0390" minOccurs="0"/> <choice> <element name="AAK_HerstellerSchluessel" type="enum_0330"/> <element name="AAK_HerstellerUnbekannt" type="JaLeer"/> </choice> <element name="AAK_HerstellerSonstiger" type="Freitext250" minOccurs="0"/> <choice> <element name="AAK_ProthesenGroesse" type="Zahl2"/> <element name="AAK_ProthesenGroesseUnbekannt" type="JaLeer"/> </choice> <element name="AAK_Dislokation" type="JaLeer" minOccurs="0"/> </sequence> </complexType> </pre> |

element **ArtikelAortenklappeBasis/AAK_ArtikelTypSchluessel**

| | |
|------------|---------------------------|
| diagram | |
| type | enum_0390 |
| properties | minOcc 0 |

| | maxOcc 1 content simple | | | | | | | | | |
|-------------|---|---|-------|------------|-------------|---------|---|-------------|---------|---|
| facets | <table border="1"> <thead> <tr> <th>Kind</th> <th>Value</th> <th>Annotation</th> </tr> </thead> <tbody> <tr> <td>enumeration</td> <td>0390001</td> <td>documentation biologisches Klappenmodell</td> </tr> <tr> <td>enumeration</td> <td>0390002</td> <td>documentation mechanisches Klappenmodell</td> </tr> </tbody> </table> | Kind | Value | Annotation | enumeration | 0390001 | documentation biologisches Klappenmodell | enumeration | 0390002 | documentation mechanisches Klappenmodell |
| Kind | Value | Annotation | | | | | | | | |
| enumeration | 0390001 | documentation biologisches Klappenmodell | | | | | | | | |
| enumeration | 0390002 | documentation mechanisches Klappenmodell | | | | | | | | |
| source | <element name="AAK_ArtikelTypSchluessel" type="enum_0390" minOccurs="0"/> | | | | | | | | | |

element **ArtikelAortenklappeBasis/AAK_HerstellerSchluessel**

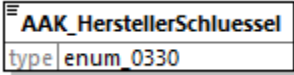
| diagram |  | | | | | | | | | | | | | | | | | | | | | | | | | | | | | | | | | | | | | | | | | | | | | | | | | | | | | | | | | | | | |
|-------------|---|--|-------|------------|-------------|---------|------------------------------|-------------|---------|---------------------------------------|-------------|---------|----------------------------|-------------|---------|----------------------------|-------------|---------|-------------------------|-------------|---------|--|-------------|---------|--------------------------|-------------|---------|--------------------------------------|-------------|---------|------------------------------------|-------------|---------|---------------------------|-------------|---------|-----------------------------|-------------|---------|---------------------------|-------------|---------|------------------------|-------------|---------|--------------------------------------|-------------|---------|--------------------------------------|-------------|---------|--------------------------------------|-------------|---------|--------------------------------------|-------------|---------|--------------------------------------|-------------|---------|---------------------------------------|
| type | enum 0330 | | | | | | | | | | | | | | | | | | | | | | | | | | | | | | | | | | | | | | | | | | | | | | | | | | | | | | | | | | | | |
| properties | content simple | | | | | | | | | | | | | | | | | | | | | | | | | | | | | | | | | | | | | | | | | | | | | | | | | | | | | | | | | | | | |
| facets | <table border="1"> <thead> <tr> <th>Kind</th> <th>Value</th> <th>Annotation</th> </tr> </thead> <tbody> <tr> <td>enumeration</td> <td>0330001</td> <td>documentation ATS Medical</td> </tr> <tr> <td>enumeration</td> <td>0330002</td> <td>documentation Edwards Lifesciences</td> </tr> <tr> <td>enumeration</td> <td>0330003</td> <td>documentation Medtronic</td> </tr> <tr> <td>enumeration</td> <td>0330004</td> <td>documentation JenaValve</td> </tr> <tr> <td>enumeration</td> <td>0330005</td> <td>documentation Corcym</td> </tr> <tr> <td>enumeration</td> <td>0330006</td> <td>documentation Abbott Medical / St. Jude</td> </tr> <tr> <td>enumeration</td> <td>0330007</td> <td>documentation Symetis</td> </tr> <tr> <td>enumeration</td> <td>0330008</td> <td>documentation Direct Flow Medical</td> </tr> <tr> <td>enumeration</td> <td>0330009</td> <td>documentation Boston Scientific</td> </tr> <tr> <td>enumeration</td> <td>0330010</td> <td>documentation Artivion</td> </tr> <tr> <td>enumeration</td> <td>0330011</td> <td>documentation Biosensors</td> </tr> <tr> <td>enumeration</td> <td>0330012</td> <td>documentation LivaNova</td> </tr> <tr> <td>enumeration</td> <td>0330013</td> <td>documentation Meril</td> </tr> <tr> <td>enumeration</td> <td>0330014</td> <td>documentation nicht belegter Wert</td> </tr> <tr> <td>enumeration</td> <td>0330015</td> <td>documentation nicht belegter Wert</td> </tr> <tr> <td>enumeration</td> <td>0330016</td> <td>documentation nicht belegter Wert</td> </tr> <tr> <td>enumeration</td> <td>0330017</td> <td>documentation nicht belegter Wert</td> </tr> <tr> <td>enumeration</td> <td>0330018</td> <td>documentation nicht belegter Wert</td> </tr> <tr> <td>enumeration</td> <td>0330042</td> <td>documentation sonstiger Hersteller</td> </tr> </tbody> </table> | Kind | Value | Annotation | enumeration | 0330001 | documentation ATS Medical | enumeration | 0330002 | documentation Edwards Lifesciences | enumeration | 0330003 | documentation Medtronic | enumeration | 0330004 | documentation JenaValve | enumeration | 0330005 | documentation Corcym | enumeration | 0330006 | documentation Abbott Medical / St. Jude | enumeration | 0330007 | documentation Symetis | enumeration | 0330008 | documentation Direct Flow Medical | enumeration | 0330009 | documentation Boston Scientific | enumeration | 0330010 | documentation Artivion | enumeration | 0330011 | documentation Biosensors | enumeration | 0330012 | documentation LivaNova | enumeration | 0330013 | documentation Meril | enumeration | 0330014 | documentation nicht belegter Wert | enumeration | 0330015 | documentation nicht belegter Wert | enumeration | 0330016 | documentation nicht belegter Wert | enumeration | 0330017 | documentation nicht belegter Wert | enumeration | 0330018 | documentation nicht belegter Wert | enumeration | 0330042 | documentation sonstiger Hersteller |
| Kind | Value | Annotation | | | | | | | | | | | | | | | | | | | | | | | | | | | | | | | | | | | | | | | | | | | | | | | | | | | | | | | | | | | |
| enumeration | 0330001 | documentation ATS Medical | | | | | | | | | | | | | | | | | | | | | | | | | | | | | | | | | | | | | | | | | | | | | | | | | | | | | | | | | | | |
| enumeration | 0330002 | documentation Edwards Lifesciences | | | | | | | | | | | | | | | | | | | | | | | | | | | | | | | | | | | | | | | | | | | | | | | | | | | | | | | | | | | |
| enumeration | 0330003 | documentation Medtronic | | | | | | | | | | | | | | | | | | | | | | | | | | | | | | | | | | | | | | | | | | | | | | | | | | | | | | | | | | | |
| enumeration | 0330004 | documentation JenaValve | | | | | | | | | | | | | | | | | | | | | | | | | | | | | | | | | | | | | | | | | | | | | | | | | | | | | | | | | | | |
| enumeration | 0330005 | documentation Corcym | | | | | | | | | | | | | | | | | | | | | | | | | | | | | | | | | | | | | | | | | | | | | | | | | | | | | | | | | | | |
| enumeration | 0330006 | documentation Abbott Medical / St. Jude | | | | | | | | | | | | | | | | | | | | | | | | | | | | | | | | | | | | | | | | | | | | | | | | | | | | | | | | | | | |
| enumeration | 0330007 | documentation Symetis | | | | | | | | | | | | | | | | | | | | | | | | | | | | | | | | | | | | | | | | | | | | | | | | | | | | | | | | | | | |
| enumeration | 0330008 | documentation Direct Flow Medical | | | | | | | | | | | | | | | | | | | | | | | | | | | | | | | | | | | | | | | | | | | | | | | | | | | | | | | | | | | |
| enumeration | 0330009 | documentation Boston Scientific | | | | | | | | | | | | | | | | | | | | | | | | | | | | | | | | | | | | | | | | | | | | | | | | | | | | | | | | | | | |
| enumeration | 0330010 | documentation Artivion | | | | | | | | | | | | | | | | | | | | | | | | | | | | | | | | | | | | | | | | | | | | | | | | | | | | | | | | | | | |
| enumeration | 0330011 | documentation Biosensors | | | | | | | | | | | | | | | | | | | | | | | | | | | | | | | | | | | | | | | | | | | | | | | | | | | | | | | | | | | |
| enumeration | 0330012 | documentation LivaNova | | | | | | | | | | | | | | | | | | | | | | | | | | | | | | | | | | | | | | | | | | | | | | | | | | | | | | | | | | | |
| enumeration | 0330013 | documentation Meril | | | | | | | | | | | | | | | | | | | | | | | | | | | | | | | | | | | | | | | | | | | | | | | | | | | | | | | | | | | |
| enumeration | 0330014 | documentation nicht belegter Wert | | | | | | | | | | | | | | | | | | | | | | | | | | | | | | | | | | | | | | | | | | | | | | | | | | | | | | | | | | | |
| enumeration | 0330015 | documentation nicht belegter Wert | | | | | | | | | | | | | | | | | | | | | | | | | | | | | | | | | | | | | | | | | | | | | | | | | | | | | | | | | | | |
| enumeration | 0330016 | documentation nicht belegter Wert | | | | | | | | | | | | | | | | | | | | | | | | | | | | | | | | | | | | | | | | | | | | | | | | | | | | | | | | | | | |
| enumeration | 0330017 | documentation nicht belegter Wert | | | | | | | | | | | | | | | | | | | | | | | | | | | | | | | | | | | | | | | | | | | | | | | | | | | | | | | | | | | |
| enumeration | 0330018 | documentation nicht belegter Wert | | | | | | | | | | | | | | | | | | | | | | | | | | | | | | | | | | | | | | | | | | | | | | | | | | | | | | | | | | | |
| enumeration | 0330042 | documentation sonstiger Hersteller | | | | | | | | | | | | | | | | | | | | | | | | | | | | | | | | | | | | | | | | | | | | | | | | | | | | | | | | | | | |
| source | <element name="AAK_HerstellerSchluessel" type="enum_0330"/> | | | | | | | | | | | | | | | | | | | | | | | | | | | | | | | | | | | | | | | | | | | | | | | | | | | | | | | | | | | | |

element **ArtikelAortenklappeBasis/AAK_HerstellerUnbekannt**

| | |
|------------|---|
| diagram |  |
| type | JaLeer |
| properties | content simple |
| facets | Kind Value Annotation pattern (1) |
| source | <code><element name="AAK_HerstellerUnbekannt" type="JaLeer"/></code> |

element **ArtikelAortenklappeBasis/AAK_HerstellerSonstiger**

| | |
|------------|---|
| diagram |  |
| type | Freitext250 |
| properties | minOcc 0 maxOcc 1 content simple |
| facets | Kind Value Annotation maxLength 250 |
| source | <code><element name="AAK_HerstellerSonstiger" type="Freitext250" minOccurs="0"/></code> |

element **ArtikelAortenklappeBasis/AAK_ProthesenGrossesse**

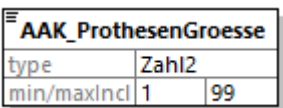
| | |
|------------|---|
| diagram |  |
| type | Zahl2 |
| properties | content simple |
| facets | Kind Value Annotation minInclusive 1 maxInclusive 99 |
| source | <code><element name="AAK_ProthesenGrossesse" type="Zahl2"/></code> |

element **ArtikelAortenklappeBasis/AAK_ProthesenGrossesseUnbekannt**

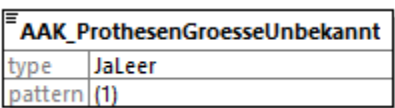
| | |
|------------|---|
| diagram |  |
| type | JaLeer |
| properties | content simple |
| facets | Kind Value Annotation pattern (1) |

| | |
|--------|--|
| source | <code><element name="AAK_ProthesenGroesseUnbekannt" type="JaLeer"/></code> |
|--------|--|

element **ArtikelAortenklappeBasis/AAK_Dislokation**

| | |
|------------|---|
| diagram | <pre> classDiagram class AAK_Dislokation { type JaLeer pattern (1) } </pre> |
| type | JaLeer |
| properties | minOcc 0 maxOcc 1 content simple |
| facets | Kind Value Annotation pattern (1) |
| source | <code><element name="AAK_Dislokation" type="JaLeer" minOccurs="0"/></code> |