

Schema **IRD_XML_Spezifikation.xsd**

schema location: http://xml.ir-d.de/rst/schema/verbindlich/V3.1.0/IRD_XML_Spezifikation.xsd
attributeFormDefault:
elementFormDefault: **unqualified**
targetNamespace: **http://xml.ir-d.de/rst**

Elements

[GEMeldung](#)
[GESelbstauskunft](#)
[GESTorno](#)
[IRDMeldungAntwort](#)
[IRDSelbstauskunftAntwort](#)
[IRDStornoAntwort](#)

schema location: <http://xml.ir-d.de/rst/schema/verbindlich/V3.1.0/GEMeldung.xsd>
attributeFormDefault:
elementFormDefault: **unqualified**
targetNamespace: **http://xml.ir-d.de/emg**

Complex types

[GeMeldung](#)

schema location: <http://xml.ir-d.de/rst/schema/verbindlich/V3.1.0/GESTorno.xsd>
attributeFormDefault:
elementFormDefault: **unqualified**
targetNamespace: **http://xml.ir-d.de/stn**

Complex types

[GeStorno](#)

schema location: <http://xml.ir-d.de/rst/schema/verbindlich/V3.1.0/IRDMeldungAntwort.xsd>
attributeFormDefault:
elementFormDefault: **unqualified**
targetNamespace: **http://xml.ir-d.de/irdma**

Complex types

[meldungAntwort](#)

schema location: <http://xml.ir-d.de/rst/schema/verbindlich/V3.1.0/IRDStornoAntwort.xsd>
attributeFormDefault:
elementFormDefault: **unqualified**
targetNamespace: **http://xml.ir-d.de/irdsa**

Complex types

[stornoAntwort](#)

schema location: <http://xml.ir-d.de/rst/schema/verbindlich/V3.1.0/GESelbstauskunft.xsd>
attributeFormDefault:
elementFormDefault: **unqualified**
targetNamespace: **http://xml.ir-d.de/sak**

Complex types

[GeSelbstauskunft](#)

schema location: <http://xml.ir-d.de/rst/schema/verbindlich/V3.1.0/IRDSelbstauskunftAntwort.xsd>
attributeFormDefault:
elementFormDefault: **unqualified**
targetNamespace: **http://xml.ir-d.de/irdsaa**

Complex types

[selbstauskunftAntwort](#)

schema location: <http://xml.ir-d.de/rst/schema/verbindlich/V3.1.0/Bausteine/Meldung.xsd>
attributeFormDefault:
elementFormDefault: **unqualified**
targetNamespace: **http://xml.ir-d.de/emg**

Complex types

[Meldung](#)

schema location: <http://xml.ir-d.de/rst/schema/verbindlich/V3.1.0/Bausteine/Storno.xsd>
attributeFormDefault:
elementFormDefault: **unqualified**
targetNamespace: **http://xml.ir-d.de/stn**

Complex types

[Storno](#)

schema location: <http://xml.ir-d.de/rst/schema/verbindlich/V3.1.0/Bausteine/MeldungIrd.xsd>
attributeFormDefault:
elementFormDefault: **unqualified**
targetNamespace: **http://xml.ir-d.de/irdma**

Complex types

[MeldungIrd](#)

schema location: <http://xml.ir-d.de/rst/schema/verbindlich/V3.1.0/Bausteine/EmpfangsbestaetigungBasis.xsd>
attributeFormDefault:
elementFormDefault: **unqualified**
targetNamespace: **http://xml.ir-d.de/irdma**

Complex types

[EmpfangsbestaetigungBasis](#)

schema location: <http://xml.ir-d.de/rst/schema/verbindlich/V3.1.0/Bausteine/HinweisBasis.xsd>
attributeFormDefault:
elementFormDefault: **unqualified**
targetNamespace: **http://xml.ir-d.de/irdma**

Complex types

[HinweisBasis](#)

schema location: <http://xml.ir-d.de/rst/schema/verbindlich/V3.1.0/Bausteine/Warnung.xsd>
attributeFormDefault:
elementFormDefault: **unqualified**
targetNamespace: **http://xml.ir-d.de/irdma**

Complex types

[Warnung](#)

schema location: <http://xml.ir-d.de/rst/schema/verbindlich/V3.1.0/Bausteine/BestaetigungBasis.xsd>
attributeFormDefault:
elementFormDefault: **unqualified**
targetNamespace: **http://xml.ir-d.de/irdma**

Complex types

[BestaetigungBasis](#)

schema location: <http://xml.ir-d.de/rst/schema/verbindlich/V3.1.0/Bausteine/Storno.xsd>
attributeFormDefault:
elementFormDefault: **unqualified**
targetNamespace: **http://xml.ir-d.de/irdsa**

Complex types

[Storno](#)

schema location: <http://xml.ir-d.de/rst/schema/verbindlich/V3.1.0/Bausteine/EmpfangsbestaetigungBasis.xsd>
attributeFormDefault:
elementFormDefault: **unqualified**
targetNamespace: **http://xml.ir-d.de/irdsa**

Complex types

[EmpfangsbestaetigungBasis](#)

schema location: <http://xml.ir-d.de/rst/schema/verbindlich/V3.1.0/Bausteine/HinweisBasis.xsd>
attributeFormDefault:
elementFormDefault: **unqualified**
targetNamespace: **http://xml.ir-d.de/irdsa**

Complex types

[HinweisBasis](#)

schema location: <http://xml.ir-d.de/rst/schema/verbindlich/V3.1.0/Bausteine/Selbstauskunft.xsd>
attributeFormDefault:
elementFormDefault: **unqualified**
targetNamespace: **http://xml.ir-d.de/sak**

Complex types

[Selbstauskunft](#)

schema location: <http://xml.ir-d.de/rst/schema/verbindlich/V3.1.0/Bausteine/Selbstauskunft.xsd>
attributeFormDefault:
elementFormDefault: **unqualified**
targetNamespace: **http://xml.ir-d.de/irdsaa**

Complex types

[Selbstauskunft](#)

schema location: <http://xml.ir-d.de/rst/schema/verbindlich/V3.1.0/Bausteine/EmpfangsbestaetigungBasis.xsd>
attributeFormDefault:
elementFormDefault: **unqualified**
targetNamespace: **http://xml.ir-d.de/irdsaa**

Complex types

[EmpfangsbestaetigungBasis](#)

schema location: <http://xml.ir-d.de/rst/schema/verbindlich/V3.1.0/Bausteine/MeldungBasis.xsd>
attributeFormDefault:
elementFormDefault: **unqualified**
targetNamespace: **http://xml.ir-d.de/emg**

Complex types

[MeldungBasis](#)

schema location: <http://xml.ir-d.de/rst/schema/verbindlich/V3.1.0/Bausteine/Fall.xsd>
attributeFormDefault:
elementFormDefault: **unqualified**
targetNamespace: **http://xml.ir-d.de/emg**

Complex types

[Fall](#)

schema location: http://xml.ir-d.de/rst/schema/verbindlich/V3.1.0/Datentypen/IRD_DatenTypen.xsd
attributeFormDefault:
elementFormDefault: **unqualified**
targetNamespace: **http://xml.ir-d.de/stn**

Simple types

[DatumText](#)

[Freitext250](#)

[Freitext500](#)

[HashString](#)

[HashWert](#)

[ICD](#)

[IdEinrichtung](#)

[IrdArtikelId](#)

[IrdSpezVersion](#)

[JaLeer](#)

[Meldebestaetigung](#)

[OPS](#)

[String2](#)

[String20](#)

[Sw](#)

[Transfervnummer](#)

[Versionsnummer](#)

[Zahl1](#)

[Zahl1_1](#)

[Zahl2](#)

[Zahl2_1](#)

[Zahl3](#)

[Zahl3_1](#)

[Zahl4](#)
[Zahl5](#)

schema location: <http://xml.ir-d.de/rst/schema/verbindlich/V3.1.0/Bausteine/MeldungIrdBasis.xsd>
attributeFormDefault:
elementFormDefault: **unqualified**
targetNamespace: **http://xml.ir-d.de/stn**

Complex types
[MeldungIrdBasis](#)

schema location: <http://xml.ir-d.de/rst/schema/verbindlich/V3.1.0/Bausteine/StornoFallBasis.xsd>
attributeFormDefault:
elementFormDefault: **unqualified**
targetNamespace: **http://xml.ir-d.de/stn**

Complex types
[StornoFallBasis](#)

schema location: http://xml.ir-d.de/rst/schema/verbindlich/V3.1.0/Datentypen/IRD_DatenTypen.xsd
attributeFormDefault:
elementFormDefault: **unqualified**
targetNamespace: **http://xml.ir-d.de/irdma**

Simple types
[DatumText](#)
[Freitext250](#)
[Freitext500](#)
[HashString](#)
[HashWert](#)
[ICD](#)
[IdEinrichtung](#)
[IrdArtikelId](#)
[IrdSpezVersion](#)
[JaLeer](#)
[Meldebestaetigung](#)
[OPS](#)
[String2](#)
[String20](#)
[Sw](#)
[Transfervnummer](#)
[Versionsnummer](#)
[Zahl1](#)
[Zahl1 1](#)
[Zahl2](#)
[Zahl2 1](#)
[Zahl3](#)
[Zahl3 1](#)
[Zahl4](#)
[Zahl5](#)

schema location: <http://xml.ir-d.de/rst/schema/verbindlich/V3.1.0/Bausteine/MeldungIrdBasis.xsd>
attributeFormDefault:
elementFormDefault: **unqualified**
targetNamespace: **http://xml.ir-d.de/irdma**

Complex types
[MeldungIrdBasis](#)

schema location: <http://xml.ir-d.de/rst/schema/verbindlich/V3.1.0/Bausteine/MeldungIrdFallBasis.xsd>
attributeFormDefault:
elementFormDefault: **unqualified**
targetNamespace: **http://xml.ir-d.de/irdma**

Complex types
[MeldungIrdFallBasis](#)

schema location: http://xml.ir-d.de/rst/schema/verbindlich/V3.1.0/Datentypen/IRD_DatenTypen.xsd
attributeFormDefault:
elementFormDefault: **unqualified**
targetNamespace: **http://xml.ir-d.de/irdsa**

Simple types
[DatumText](#)
[Freitext250](#)
[Freitext500](#)
[HashString](#)
[HashWert](#)
[ICD](#)
[IdEinrichtung](#)
[IrdArtikelId](#)
[IrdSpezVersion](#)
[JaLeer](#)
[Meldebestaetigung](#)
[OPS](#)
[String2](#)
[String20](#)
[Sw](#)
[Transfervummer](#)
[Versionsnummer](#)
[Zahl1](#)
[Zahl1_1](#)
[Zahl2](#)
[Zahl2_1](#)
[Zahl3](#)
[Zahl3_1](#)
[Zahl4](#)
[Zahl5](#)

schema location: <http://xml.ir-d.de/rst/schema/verbindlich/V3.1.0/Bausteine/MeldungIrdBasis.xsd>
attributeFormDefault:
elementFormDefault: **unqualified**
targetNamespace: **http://xml.ir-d.de/irdsa**

Complex types
[MeldungIrdBasis](#)

schema location: <http://xml.ir-d.de/rst/schema/verbindlich/V3.1.0/Bausteine/StornoFallBasis.xsd>
attributeFormDefault:
elementFormDefault: **unqualified**
targetNamespace: **http://xml.ir-d.de/irdsa**

Complex types
[StornoFallBasis](#)

schema location: http://xml.ir-d.de/rst/schema/verbindlich/V3.1.0/Datentypen/IRD_DatenTypen.xsd
attributeFormDefault:
elementFormDefault: **unqualified**
targetNamespace: **http://xml.ir-d.de/sak**

Simple types
[DatumText](#)
[Freitext250](#)
[Freitext500](#)
[HashString](#)
[HashWert](#)
[ICD](#)
[IdEinrichtung](#)
[IrdArtikelId](#)
[IrdSpezVersion](#)
[JaLeer](#)
[Meldebestaetigung](#)
[OPS](#)
[String2](#)
[String20](#)
[Sw](#)
[Transfervnummer](#)
[Versionsnummer](#)
[Zahl1](#)
[Zahl1_1](#)
[Zahl2](#)
[Zahl2_1](#)
[Zahl3](#)
[Zahl3_1](#)
[Zahl4](#)
[Zahl5](#)

schema location: <http://xml.ir-d.de/rst/schema/verbindlich/V3.1.0/Bausteine/MeldungIrdBasis.xsd>

attributeFormDefault:
elementFormDefault: **unqualified**
targetNamespace: **http://xml.ir-d.de/sak**

Complex types
[MeldungIrdBasis](#)

schema location: <http://xml.ir-d.de/rst/schema/verbindlich/V3.1.0/Bausteine/SelbstauskunftFallBasis.xsd>
attributeFormDefault:
elementFormDefault: **unqualified**
targetNamespace: **http://xml.ir-d.de/sak**

Complex types
[SelbstauskunftFallBasis](#)

schema location: http://xml.ir-d.de/rst/schema/verbindlich/V3.1.0/Datentypen/IRD_DatenTypen.xsd
attributeFormDefault:
elementFormDefault: **unqualified**
targetNamespace: **http://xml.ir-d.de/irdsaa**

Simple types
[DatumText](#)
[Freitext250](#)
[Freitext500](#)
[HashString](#)
[HashWert](#)
[ICD](#)
[IdEinrichtung](#)
[IrdArtikelId](#)
[IrdSpezVersion](#)
[JaLeer](#)
[Meldebestaetigung](#)
[OPS](#)
[String2](#)
[String20](#)
[Sw](#)
[Transfervummer](#)
[Versionsnummer](#)
[Zahl1](#)
[Zahl1_1](#)
[Zahl2](#)
[Zahl2_1](#)
[Zahl3](#)
[Zahl3_1](#)
[Zahl4](#)
[Zahl5](#)

schema location: <http://xml.ir-d.de/rst/schema/verbindlich/V3.1.0/Bausteine/MeldungIrdBasis.xsd>
attributeFormDefault:
elementFormDefault: **unqualified**

targetNamespace: <http://xml.ir-d.de/irdsaa>

Complex types

[MeldungIrdBasis](#)

schema location: <http://xml.ir-d.de/rst/schema/verbindlich/V3.1.0/Bausteine/SelbstauskunftFallBasis.xsd>

attributeFormDefault:

elementFormDefault: **unqualified**

targetNamespace: <http://xml.ir-d.de/irdsaa>

Complex types

[SelbstauskunftFallBasis](#)

schema location: http://xml.ir-d.de/rst/schema/verbindlich/V3.1.0/Datentypen/IRD_DatenTypen.xsd

attributeFormDefault:

elementFormDefault: **unqualified**

targetNamespace: <http://xml.ir-d.de/emg>

Simple types

[DatumText](#)

[Freitext250](#)

[Freitext500](#)

[HashString](#)

[HashWert](#)

[ICD](#)

[IdEinrichtung](#)

[IrdArtikelId](#)

[IrdSpezVersion](#)

[JaLeer](#)

[Meldebestaetigung](#)

[OPS](#)

[String2](#)

[String20](#)

[Sw](#)

[Transfervummer](#)

[Versionsnummer](#)

[Zahl1](#)

[Zahl1_1](#)

[Zahl2](#)

[Zahl2_1](#)

[Zahl3](#)

[Zahl3_1](#)

[Zahl4](#)

[Zahl5](#)

schema location: <http://xml.ir-d.de/rst/schema/verbindlich/V3.1.0/Bausteine/FallBasis.xsd>

attributeFormDefault:

elementFormDefault: **unqualified**

targetNamespace: <http://xml.ir-d.de/emg>

Complex types

[FallBasis](#)

schema location: <http://xml.ir-d.de/rst/schema/verbindlich/V3.1.0/Bausteine/AusloeserBasis.xsd>
attributeFormDefault:
elementFormDefault: **unqualified**
targetNamespace: **http://xml.ir-d.de/emg**

Complex types

[AusloeserBasis](#)

schema location: <http://xml.ir-d.de/rst/schema/verbindlich/V3.1.0/Bausteine/Patientenaufnahme.xsd>
attributeFormDefault:
elementFormDefault: **unqualified**
targetNamespace: **http://xml.ir-d.de/emg**

Complex types

[Patientenaufnahme](#)

schema location: <http://xml.ir-d.de/rst/schema/verbindlich/V3.1.0/Bausteine/Operation.xsd>
attributeFormDefault:
elementFormDefault: **unqualified**
targetNamespace: **http://xml.ir-d.de/emg**

Complex types

[Operation](#)

schema location: <http://xml.ir-d.de/rst/schema/verbindlich/V3.1.0/Bausteine/Entlassung.xsd>
attributeFormDefault:
elementFormDefault: **unqualified**
targetNamespace: **http://xml.ir-d.de/emg**

Complex types

[Entlassung](#)

schema location: <http://xml.ir-d.de/rst/schema/verbindlich/V3.1.0/Bausteine/PostoperationAortenklappe.xsd>
attributeFormDefault:
elementFormDefault: **unqualified**
targetNamespace: **http://xml.ir-d.de/emg**

Complex types

[PostoperationAortenklappe](#)

schema location: http://xml.ir-d.de/rst/schema/verbindlich/V3.1.0/Datentypen/IRD_Wertelisten.xsd

attributeFormDefault:

elementFormDefault: **qualified**

targetNamespace: **http://xml.ir-d.de/stn**

Simple types

[enum 0044](#)

[enum 0050](#)

[enum 0060](#)

[enum 0061](#)

[enum 0062](#)

[enum 0065](#)

[enum 0067](#)

[enum 0068](#)

[enum 0069](#)

[enum 0070](#)

[enum 0071](#)

[enum 0075](#)

[enum 0076](#)

[enum 0080](#)

[enum 0100](#)

[enum 0102](#)

[enum 0103](#)

[enum 0104](#)

[enum 0105](#)

[enum 0106](#)

[enum 0107](#)

[enum 0110](#)

[enum 0111](#)

[enum 0112](#)

[enum 0113](#)

[enum 0114](#)

[enum 0116](#)

[enum 0118](#)

[enum 0120](#)

[enum 0121](#)

[enum 0122](#)

[enum 0123](#)

[enum 0124](#)

[enum 0126](#)

[enum 0128](#)

[enum 0130](#)

[enum 0131](#)

[enum 0190](#)

[enum 0191](#)

[enum 0200](#)

[enum 0202](#)

[enum 0204](#)

[enum 0206](#)

[enum 0210](#)

[enum 0211](#)

[enum 0212](#)

[enum 0220](#)

[enum 0222](#)

[enum 0230](#)

[enum 0252](#)

[enum 0254](#)
[enum 0256](#)
[enum 0262](#)
[enum 0264](#)
[enum 0266](#)
[enum 0270](#)
[enum 0271](#)
[enum 0290](#)
[enum 0291](#)
[enum 0300](#)
[enum 0302](#)
[enum 0318](#)
[enum 0320](#)
[enum 0322](#)
[enum 0324](#)
[enum 0330](#)
[enum 0338](#)
[enum 0339](#)
[enum 0341](#)
[enum 0342](#)
[enum 0343](#)
[enum 0346](#)
[enum 0347](#)
[enum 0348](#)
[enum 0350](#)
[enum 0351](#)
[enum 0352](#)
[enum 0353](#)
[enum 0354](#)
[enum 0357](#)
[enum 0358](#)
[enum 0359](#)
[enum 0360](#)
[enum 0361](#)
[enum 0362](#)
[enum 0363](#)
[enum 0364](#)
[enum 0365](#)
[enum 0366](#)
[enum 0367](#)
[enum 0368](#)
[enum 0369](#)
[enum 0370](#)
[enum 0371](#)
[enum 0372](#)
[enum 0373](#)
[enum 0374](#)
[enum 0375](#)
[enum 0376](#)
[enum 0377](#)
[enum 0378](#)
[enum 0379](#)
[enum 0380](#)
[enum 0381](#)
[enum 0382](#)
[enum 0383](#)
[enum 0384](#)
[enum 0385](#)
[enum 0388](#)
[enum 0389](#)
[enum 0390](#)
[enum 0398](#)
[enum 0399](#)

schema location: http://xml.ir-d.de/rst/schema/verbindlich/V3.1.0/Datentypen/IRD_Wertelisten.xsd
attributeFormDefault:
elementFormDefault: **qualified**
targetNamespace: **http://xml.ir-d.de/irdma**

Simple types

[enum 0044](#)
[enum 0050](#)
[enum 0060](#)
[enum 0061](#)
[enum 0062](#)
[enum 0065](#)
[enum 0067](#)
[enum 0068](#)
[enum 0069](#)
[enum 0070](#)
[enum 0071](#)
[enum 0075](#)
[enum 0076](#)
[enum 0080](#)
[enum 0100](#)
[enum 0102](#)
[enum 0103](#)
[enum 0104](#)
[enum 0105](#)
[enum 0106](#)
[enum 0107](#)
[enum 0110](#)
[enum 0111](#)
[enum 0112](#)
[enum 0113](#)
[enum 0114](#)
[enum 0116](#)
[enum 0118](#)
[enum 0120](#)
[enum 0121](#)
[enum 0122](#)
[enum 0123](#)
[enum 0124](#)
[enum 0126](#)
[enum 0128](#)
[enum 0130](#)
[enum 0131](#)
[enum 0190](#)
[enum 0191](#)
[enum 0200](#)
[enum 0202](#)
[enum 0204](#)
[enum 0206](#)
[enum 0210](#)
[enum 0211](#)
[enum 0212](#)
[enum 0220](#)
[enum 0222](#)
[enum 0230](#)
[enum 0252](#)
[enum 0254](#)
[enum 0256](#)
[enum 0262](#)
[enum 0264](#)

[enum 0266](#)
[enum 0270](#)
[enum 0271](#)
[enum 0290](#)
[enum 0291](#)
[enum 0300](#)
[enum 0302](#)
[enum 0318](#)
[enum 0320](#)
[enum 0322](#)
[enum 0324](#)
[enum 0330](#)
[enum 0338](#)
[enum 0339](#)
[enum 0341](#)
[enum 0342](#)
[enum 0343](#)
[enum 0346](#)
[enum 0347](#)
[enum 0348](#)
[enum 0350](#)
[enum 0351](#)
[enum 0352](#)
[enum 0353](#)
[enum 0354](#)
[enum 0357](#)
[enum 0358](#)
[enum 0359](#)
[enum 0360](#)
[enum 0361](#)
[enum 0362](#)
[enum 0363](#)
[enum 0364](#)
[enum 0365](#)
[enum 0366](#)
[enum 0367](#)
[enum 0368](#)
[enum 0369](#)
[enum 0370](#)
[enum 0371](#)
[enum 0372](#)
[enum 0373](#)
[enum 0374](#)
[enum 0375](#)
[enum 0376](#)
[enum 0377](#)
[enum 0378](#)
[enum 0379](#)
[enum 0380](#)
[enum 0381](#)
[enum 0382](#)
[enum 0383](#)
[enum 0384](#)
[enum 0385](#)
[enum 0388](#)
[enum 0389](#)
[enum 0390](#)
[enum 0398](#)
[enum 0399](#)

schema location:

http://xml.ir-d.de/rst/schema/verbindlich/V3.1.0/Datentypen/IRD_Wertelisten.xsd

attributeFormDefault:

elementFormDefault: **qualified**
targetNamespace: **http://xml.ir-d.de/irdsa**

Simple types

[enum 0044](#)
[enum 0050](#)
[enum 0060](#)
[enum 0061](#)
[enum 0062](#)
[enum 0065](#)
[enum 0067](#)
[enum 0068](#)
[enum 0069](#)
[enum 0070](#)
[enum 0071](#)
[enum 0075](#)
[enum 0076](#)
[enum 0080](#)
[enum 0100](#)
[enum 0102](#)
[enum 0103](#)
[enum 0104](#)
[enum 0105](#)
[enum 0106](#)
[enum 0107](#)
[enum 0110](#)
[enum 0111](#)
[enum 0112](#)
[enum 0113](#)
[enum 0114](#)
[enum 0116](#)
[enum 0118](#)
[enum 0120](#)
[enum 0121](#)
[enum 0122](#)
[enum 0123](#)
[enum 0124](#)
[enum 0126](#)
[enum 0128](#)
[enum 0130](#)
[enum 0131](#)
[enum 0190](#)
[enum 0191](#)
[enum 0200](#)
[enum 0202](#)
[enum 0204](#)
[enum 0206](#)
[enum 0210](#)
[enum 0211](#)
[enum 0212](#)
[enum 0220](#)
[enum 0222](#)
[enum 0230](#)
[enum 0252](#)
[enum 0254](#)
[enum 0256](#)
[enum 0262](#)
[enum 0264](#)
[enum 0266](#)
[enum 0270](#)
[enum 0271](#)
[enum 0290](#)
[enum 0291](#)

[enum 0300](#)
[enum 0302](#)
[enum 0318](#)
[enum 0320](#)
[enum 0322](#)
[enum 0324](#)
[enum 0330](#)
[enum 0338](#)
[enum 0339](#)
[enum 0341](#)
[enum 0342](#)
[enum 0343](#)
[enum 0346](#)
[enum 0347](#)
[enum 0348](#)
[enum 0350](#)
[enum 0351](#)
[enum 0352](#)
[enum 0353](#)
[enum 0354](#)
[enum 0357](#)
[enum 0358](#)
[enum 0359](#)
[enum 0360](#)
[enum 0361](#)
[enum 0362](#)
[enum 0363](#)
[enum 0364](#)
[enum 0365](#)
[enum 0366](#)
[enum 0367](#)
[enum 0368](#)
[enum 0369](#)
[enum 0370](#)
[enum 0371](#)
[enum 0372](#)
[enum 0373](#)
[enum 0374](#)
[enum 0375](#)
[enum 0376](#)
[enum 0377](#)
[enum 0378](#)
[enum 0379](#)
[enum 0380](#)
[enum 0381](#)
[enum 0382](#)
[enum 0383](#)
[enum 0384](#)
[enum 0385](#)
[enum 0388](#)
[enum 0389](#)
[enum 0390](#)
[enum 0398](#)
[enum 0399](#)

schema location: http://xml.ir-d.de/rst/schema/verbindlich/V3.1.0/Datentypen/IRD_Wertelisten.xsd
attributeFormDefault:
elementFormDefault: **qualified**
targetNamespace: <http://xml.ir-d.de/sak>

Simple types

[enum 0044](#)
[enum 0050](#)
[enum 0060](#)
[enum 0061](#)
[enum 0062](#)
[enum 0065](#)
[enum 0067](#)
[enum 0068](#)
[enum 0069](#)
[enum 0070](#)
[enum 0071](#)
[enum 0075](#)
[enum 0076](#)
[enum 0080](#)
[enum 0100](#)
[enum 0102](#)
[enum 0103](#)
[enum 0104](#)
[enum 0105](#)
[enum 0106](#)
[enum 0107](#)
[enum 0110](#)
[enum 0111](#)
[enum 0112](#)
[enum 0113](#)
[enum 0114](#)
[enum 0116](#)
[enum 0118](#)
[enum 0120](#)
[enum 0121](#)
[enum 0122](#)
[enum 0123](#)
[enum 0124](#)
[enum 0126](#)
[enum 0128](#)
[enum 0130](#)
[enum 0131](#)
[enum 0190](#)
[enum 0191](#)
[enum 0200](#)
[enum 0202](#)
[enum 0204](#)
[enum 0206](#)
[enum 0210](#)
[enum 0211](#)
[enum 0212](#)
[enum 0220](#)
[enum 0222](#)
[enum 0230](#)
[enum 0252](#)
[enum 0254](#)
[enum 0256](#)
[enum 0262](#)
[enum 0264](#)
[enum 0266](#)
[enum 0270](#)
[enum 0271](#)
[enum 0290](#)
[enum 0291](#)
[enum 0300](#)
[enum 0302](#)
[enum 0318](#)
[enum 0320](#)
[enum 0322](#)

[enum 0324](#)
[enum 0330](#)
[enum 0338](#)
[enum 0339](#)
[enum 0341](#)
[enum 0342](#)
[enum 0343](#)
[enum 0346](#)
[enum 0347](#)
[enum 0348](#)
[enum 0350](#)
[enum 0351](#)
[enum 0352](#)
[enum 0353](#)
[enum 0354](#)
[enum 0357](#)
[enum 0358](#)
[enum 0359](#)
[enum 0360](#)
[enum 0361](#)
[enum 0362](#)
[enum 0363](#)
[enum 0364](#)
[enum 0365](#)
[enum 0366](#)
[enum 0367](#)
[enum 0368](#)
[enum 0369](#)
[enum 0370](#)
[enum 0371](#)
[enum 0372](#)
[enum 0373](#)
[enum 0374](#)
[enum 0375](#)
[enum 0376](#)
[enum 0377](#)
[enum 0378](#)
[enum 0379](#)
[enum 0380](#)
[enum 0381](#)
[enum 0382](#)
[enum 0383](#)
[enum 0384](#)
[enum 0385](#)
[enum 0388](#)
[enum 0389](#)
[enum 0390](#)
[enum 0398](#)
[enum 0399](#)

schema location: http://xml.ir-d.de/rst/schema/verbindlich/V3.1.0/Datentypen/IRD_Wertlisten.xsd
attributeFormDefault:
elementFormDefault: **qualified**
targetNamespace: <http://xml.ir-d.de/irdsaa>

Simple types
[enum 0044](#)
[enum 0050](#)
[enum 0060](#)
[enum 0061](#)

[enum 0062](#)
[enum 0065](#)
[enum 0067](#)
[enum 0068](#)
[enum 0069](#)
[enum 0070](#)
[enum 0071](#)
[enum 0075](#)
[enum 0076](#)
[enum 0080](#)
[enum 0100](#)
[enum 0102](#)
[enum 0103](#)
[enum 0104](#)
[enum 0105](#)
[enum 0106](#)
[enum 0107](#)
[enum 0110](#)
[enum 0111](#)
[enum 0112](#)
[enum 0113](#)
[enum 0114](#)
[enum 0116](#)
[enum 0118](#)
[enum 0120](#)
[enum 0121](#)
[enum 0122](#)
[enum 0123](#)
[enum 0124](#)
[enum 0126](#)
[enum 0128](#)
[enum 0130](#)
[enum 0131](#)
[enum 0190](#)
[enum 0191](#)
[enum 0200](#)
[enum 0202](#)
[enum 0204](#)
[enum 0206](#)
[enum 0210](#)
[enum 0211](#)
[enum 0212](#)
[enum 0220](#)
[enum 0222](#)
[enum 0230](#)
[enum 0252](#)
[enum 0254](#)
[enum 0256](#)
[enum 0262](#)
[enum 0264](#)
[enum 0266](#)
[enum 0270](#)
[enum 0271](#)
[enum 0290](#)
[enum 0291](#)
[enum 0300](#)
[enum 0302](#)
[enum 0318](#)
[enum 0320](#)
[enum 0322](#)
[enum 0324](#)
[enum 0330](#)
[enum 0338](#)
[enum 0339](#)
[enum 0341](#)

[enum 0342](#)
[enum 0343](#)
[enum 0346](#)
[enum 0347](#)
[enum 0348](#)
[enum 0350](#)
[enum 0351](#)
[enum 0352](#)
[enum 0353](#)
[enum 0354](#)
[enum 0357](#)
[enum 0358](#)
[enum 0359](#)
[enum 0360](#)
[enum 0361](#)
[enum 0362](#)
[enum 0363](#)
[enum 0364](#)
[enum 0365](#)
[enum 0366](#)
[enum 0367](#)
[enum 0368](#)
[enum 0369](#)
[enum 0370](#)
[enum 0371](#)
[enum 0372](#)
[enum 0373](#)
[enum 0374](#)
[enum 0375](#)
[enum 0376](#)
[enum 0377](#)
[enum 0378](#)
[enum 0379](#)
[enum 0380](#)
[enum 0381](#)
[enum 0382](#)
[enum 0383](#)
[enum 0384](#)
[enum 0385](#)
[enum 0388](#)
[enum 0389](#)
[enum 0390](#)
[enum 0398](#)
[enum 0399](#)

schema location: http://xml.ir-d.de/rst/schema/verbindlich/V3.1.0/Datentypen/IRD_Wertelisten.xsd
attributeFormDefault:
elementFormDefault: **qualified**
targetNamespace: <http://xml.ir-d.de/emg>

Simple types
[enum 0044](#)
[enum 0050](#)
[enum 0060](#)
[enum 0061](#)
[enum 0062](#)
[enum 0065](#)
[enum 0067](#)
[enum 0068](#)
[enum 0069](#)

[enum 0070](#)
[enum 0071](#)
[enum 0075](#)
[enum 0076](#)
[enum 0080](#)
[enum 0100](#)
[enum 0102](#)
[enum 0103](#)
[enum 0104](#)
[enum 0105](#)
[enum 0106](#)
[enum 0107](#)
[enum 0110](#)
[enum 0111](#)
[enum 0112](#)
[enum 0113](#)
[enum 0114](#)
[enum 0116](#)
[enum 0118](#)
[enum 0120](#)
[enum 0121](#)
[enum 0122](#)
[enum 0123](#)
[enum 0124](#)
[enum 0126](#)
[enum 0128](#)
[enum 0130](#)
[enum 0131](#)
[enum 0190](#)
[enum 0191](#)
[enum 0200](#)
[enum 0202](#)
[enum 0204](#)
[enum 0206](#)
[enum 0210](#)
[enum 0211](#)
[enum 0212](#)
[enum 0220](#)
[enum 0222](#)
[enum 0230](#)
[enum 0252](#)
[enum 0254](#)
[enum 0256](#)
[enum 0262](#)
[enum 0264](#)
[enum 0266](#)
[enum 0270](#)
[enum 0271](#)
[enum 0290](#)
[enum 0291](#)
[enum 0300](#)
[enum 0302](#)
[enum 0318](#)
[enum 0320](#)
[enum 0322](#)
[enum 0324](#)
[enum 0330](#)
[enum 0338](#)
[enum 0339](#)
[enum 0341](#)
[enum 0342](#)
[enum 0343](#)
[enum 0346](#)
[enum 0347](#)
[enum 0348](#)

[enum 0350](#)
[enum 0351](#)
[enum 0352](#)
[enum 0353](#)
[enum 0354](#)
[enum 0357](#)
[enum 0358](#)
[enum 0359](#)
[enum 0360](#)
[enum 0361](#)
[enum 0362](#)
[enum 0363](#)
[enum 0364](#)
[enum 0365](#)
[enum 0366](#)
[enum 0367](#)
[enum 0368](#)
[enum 0369](#)
[enum 0370](#)
[enum 0371](#)
[enum 0372](#)
[enum 0373](#)
[enum 0374](#)
[enum 0375](#)
[enum 0376](#)
[enum 0377](#)
[enum 0378](#)
[enum 0379](#)
[enum 0380](#)
[enum 0381](#)
[enum 0382](#)
[enum 0383](#)
[enum 0384](#)
[enum 0385](#)
[enum 0388](#)
[enum 0389](#)
[enum 0390](#)
[enum 0398](#)
[enum 0399](#)

schema location: <http://xml.ir-d.de/rst/schema/verbindlich/V3.1.0/Bausteine/PatientenaufnahmeBasis.xsd>
attributeFormDefault:
elementFormDefault: **unqualified**
targetNamespace: **http://xml.ir-d.de/emg**

Complex types
[PatientenaufnahmeBasis](#)

schema location: <http://xml.ir-d.de/rst/schema/verbindlich/V3.1.0/Bausteine/PatientenaufnahmeBrustimplantatBasis.xsd>
attributeFormDefault:
elementFormDefault: **unqualified**
targetNamespace: **http://xml.ir-d.de/emg**

Complex types
[PatientenaufnahmeBrustimplantatBasis](#)

schema location: <http://xml.ir-d.de/rst/schema/verbindlich/V3.1.0/Bausteine/PatientenaufnahmeKardiologie.xsd>
attributeFormDefault:
elementFormDefault: **unqualified**
targetNamespace: **http://xml.ir-d.de/emg**

Complex types
[PatientenaufnahmeKardiologie](#)

schema location: <http://xml.ir-d.de/rst/schema/verbindlich/V3.1.0/Bausteine/OperationBasis.xsd>
attributeFormDefault:
elementFormDefault: **unqualified**
targetNamespace: **http://xml.ir-d.de/emg**

Complex types
[OperationBasis](#)

schema location: <http://xml.ir-d.de/rst/schema/verbindlich/V3.1.0/Bausteine/OperationBrustimplantat.xsd>
attributeFormDefault:
elementFormDefault: **unqualified**
targetNamespace: **http://xml.ir-d.de/emg**

Complex types
[OperationBrustimplantat](#)

schema location: <http://xml.ir-d.de/rst/schema/verbindlich/V3.1.0/Bausteine/OperationEndoprothese.xsd>
attributeFormDefault:
elementFormDefault: **unqualified**
targetNamespace: **http://xml.ir-d.de/emg**

Complex types
[OperationEndoprothese](#)

schema location: <http://xml.ir-d.de/rst/schema/verbindlich/V3.1.0/Bausteine/OperationAortenklappe.xsd>
attributeFormDefault:
elementFormDefault: **unqualified**
targetNamespace: **http://xml.ir-d.de/emg**

Complex types
[OperationAortenklappe](#)

schema location: <http://xml.ir-d.de/rst/schema/verbindlich/V3.1.0/Bausteine/Artikelidentifikation.xsd>
attributeFormDefault:
elementFormDefault: **unqualified**
targetNamespace: **http://xml.ir-d.de/emg**

Complex types
[Artikelidentifikation](#)

schema location: <http://xml.ir-d.de/rst/schema/verbindlich/V3.1.0/Bausteine/Zubehoer.xsd>
attributeFormDefault:
elementFormDefault: **unqualified**
targetNamespace: **http://xml.ir-d.de/emg**

Complex types
[Zubehoer](#)

schema location: <http://xml.ir-d.de/rst/schema/verbindlich/V3.1.0/Bausteine/EntlassungBasis.xsd>
attributeFormDefault:
elementFormDefault: **unqualified**
targetNamespace: **http://xml.ir-d.de/emg**

Complex types
[EntlassungBasis](#)

schema location: <http://xml.ir-d.de/rst/schema/verbindlich/V3.1.0/Bausteine/DiagnoseBrustimplantatBasis.xsd>
attributeFormDefault:
elementFormDefault: **unqualified**
targetNamespace: **http://xml.ir-d.de/emg**

Complex types
[DiagnoseBrustimplantatBasis](#)

schema location: <http://xml.ir-d.de/rst/schema/verbindlich/V3.1.0/Bausteine/DiagnoseEndoprotheseBasis.xsd>
attributeFormDefault:
elementFormDefault: **unqualified**
targetNamespace: **http://xml.ir-d.de/emg**

Complex types
[DiagnoseEndoprotheseBasis](#)

schema location: <http://xml.ir-d.de/rst/schema/verbindlich/V3.1.0/Bausteine/DiagnoseAortenklappeBasis.xsd>
attributeFormDefault:
elementFormDefault: **unqualified**
targetNamespace: **http://xml.ir-d.de/emg**

Complex types

[DiagnoseAortenklappeBasis](#)

schema location: <http://xml.ir-d.de/rst/schema/verbindlich/V3.1.0/Bausteine/PostoperationAortenklappeBasis.xsd>
attributeFormDefault:
elementFormDefault: **unqualified**
targetNamespace: **http://xml.ir-d.de/emg**

Complex types

[PostoperationAortenklappeBasis](#)

schema location: <http://xml.ir-d.de/rst/schema/verbindlich/V3.1.0/Bausteine/AntikoagulansAortenklappeBasis.xsd>
attributeFormDefault:
elementFormDefault: **unqualified**
targetNamespace: **http://xml.ir-d.de/emg**

Complex types

[AntikoagulansAortenklappeBasis](#)

schema location: <http://xml.ir-d.de/rst/schema/verbindlich/V3.1.0/Bausteine/PatientenaufnahmeKardiologieBasis.xsd>
attributeFormDefault:
elementFormDefault: **unqualified**
targetNamespace: **http://xml.ir-d.de/emg**

Complex types

[PatientenaufnahmeKardiologieBasis](#)

schema location: <http://xml.ir-d.de/rst/schema/verbindlich/V3.1.0/Bausteine/PatientenaufnahmeAortenklappe.xsd>
attributeFormDefault:
elementFormDefault: **unqualified**
targetNamespace: **http://xml.ir-d.de/emg**

Complex types

[PatientenaufnahmeAortenklappe](#)

schema location: <http://xml.ir-d.de/rst/schema/verbindlich/V3.1.0/Bausteine/OperationBrustimplantatBasis.xsd>
attributeFormDefault:
elementFormDefault: **unqualified**
targetNamespace: **http://xml.ir-d.de/emg**

Complex types

[OperationBrustimplantatBasis](#)

schema location: <http://xml.ir-d.de/rst/schema/verbindlich/V3.1.0/Bausteine/VorbehandlungBrustimplantatBasis.xsd>
attributeFormDefault:
elementFormDefault: **unqualified**
targetNamespace: **http://xml.ir-d.de/emg**

Complex types

[VorbehandlungBrustimplantatBasis](#)

schema location: <http://xml.ir-d.de/rst/schema/verbindlich/V3.1.0/Bausteine/MassnahmeBrustimplantatBasis.xsd>
attributeFormDefault:
elementFormDefault: **unqualified**
targetNamespace: **http://xml.ir-d.de/emg**

Complex types

[MassnahmeBrustimplantatBasis](#)

schema location: <http://xml.ir-d.de/rst/schema/verbindlich/V3.1.0/Bausteine/OperationsdetailBrustimplantatBasis.xsd>
attributeFormDefault:
elementFormDefault: **unqualified**
targetNamespace: **http://xml.ir-d.de/emg**

Complex types

[OperationsdetailBrustimplantatBasis](#)

schema location: <http://xml.ir-d.de/rst/schema/verbindlich/V3.1.0/Bausteine/BefundBrustimplantatBasis.xsd>
attributeFormDefault:
elementFormDefault: **unqualified**
targetNamespace: **http://xml.ir-d.de/emg**

Complex types

[BefundBrustimplantatBasis](#)

schema location: <http://xml.ir-d.de/rst/schema/verbindlich/V3.1.0/Bausteine/ProzedurenSchluesselBrustimplantatBasis.xsd>
attributeFormDefault:
:
elementFormDefault: **unqualified**
targetNamespace: **http://xml.ir-d.de/emg**

Complex types
[ProzedurenSchluesselBrustimplantatBasis](#)

schema location: <http://xml.ir-d.de/rst/schema/verbindlich/V3.1.0/Bausteine/OperationEndoprotheseBasis.xsd>
attributeFormDefault:
:
elementFormDefault: **unqualified**
targetNamespace: **http://xml.ir-d.de/emg**

Complex types
[OperationEndoprotheseBasis](#)

schema location: <http://xml.ir-d.de/rst/schema/verbindlich/V3.1.0/Bausteine/VorbehandlungEndoprotheseBasis.xsd>
attributeFormDefault:
:
elementFormDefault: **unqualified**
targetNamespace: **http://xml.ir-d.de/emg**

Complex types
[VorbehandlungEndoprotheseBasis](#)

schema location: <http://xml.ir-d.de/rst/schema/verbindlich/V3.1.0/Bausteine/ProzedurenSchluesselEndoprotheseBasis.xsd>
attributeFormDefault:
:
elementFormDefault: **unqualified**
targetNamespace: **http://xml.ir-d.de/emg**

Complex types
[ProzedurenSchluesselEndoprotheseBasis](#)

schema location: <http://xml.ir-d.de/rst/schema/verbindlich/V3.1.0/Bausteine/OperationAortenklappeBasis.xsd>
attributeFormDefault:
:
elementFormDefault: **unqualified**
targetNamespace: **http://xml.ir-d.de/emg**

Complex types

[OperationAortenklappeBasis](#)

schema location: <http://xml.ir-d.de/rst/schema/verbindlich/V3.1.0/Bausteine/TaviAortenklappeBasis.xsd>
attributeFormDefault:
elementFormDefault: **unqualified**
targetNamespace: **http://xml.ir-d.de/emg**

Complex types

[TaviAortenklappeBasis](#)

schema location: <http://xml.ir-d.de/rst/schema/verbindlich/V3.1.0/Bausteine/ProzedurenSchluesselAortenklappeBasis.xsd>
attributeFormDefault:
:
elementFormDefault: **unqualified**
targetNamespace: **http://xml.ir-d.de/emg**

Complex types

[ProzedurenSchluesselAortenklappeBasis](#)

schema location: <http://xml.ir-d.de/rst/schema/verbindlich/V3.1.0/Bausteine/FailureGrundAortenklappeBasis.xsd>
attributeFormDefault:
elementFormDefault: **unqualified**
targetNamespace: **http://xml.ir-d.de/emg**

Complex types

[FailureGrundAortenklappeBasis](#)

schema location: <http://xml.ir-d.de/rst/schema/verbindlich/V3.1.0/Bausteine/PciAortenklappeBasis.xsd>
attributeFormDefault:
elementFormDefault: **unqualified**
targetNamespace: **http://xml.ir-d.de/emg**

Complex types

[PciAortenklappeBasis](#)

schema location: <http://xml.ir-d.de/rst/schema/verbindlich/V3.1.0/Bausteine/KomplikationAortenklappeBasis.xsd>
attributeFormDefault:
elementFormDefault: **unqualified**
targetNamespace: **http://xml.ir-d.de/emg**

Complex types

[KomplikationAortenklappeBasis](#)

schema location: <http://xml.ir-d.de/rst/schema/verbindlich/V3.1.0/Bausteine/ArtikelidentifikationBasis.xsd>
attributeFormDefault:
elementFormDefault: **unqualified**
targetNamespace: **http://xml.ir-d.de/emg**

Complex types

[ArtikelidentifikationBasis](#)

schema location: <http://xml.ir-d.de/rst/schema/verbindlich/V3.1.0/Bausteine/Artikelbeschreibung.xsd>
attributeFormDefault:
elementFormDefault: **unqualified**
targetNamespace: **http://xml.ir-d.de/emg**

Complex types

[Artikelbeschreibung](#)

schema location: <http://xml.ir-d.de/rst/schema/verbindlich/V3.1.0/Bausteine/ZubehoerBasis.xsd>
attributeFormDefault:
elementFormDefault: **unqualified**
targetNamespace: **http://xml.ir-d.de/emg**

Complex types

[ZubehoerBasis](#)

schema location: <http://xml.ir-d.de/rst/schema/verbindlich/V3.1.0/Bausteine/ZubehoerBrustimplantatBasis.xsd>
attributeFormDefault:
elementFormDefault: **unqualified**
targetNamespace: **http://xml.ir-d.de/emg**

Complex types

[ZubehoerBrustimplantatBasis](#)

schema location: <http://xml.ir-d.de/rst/schema/verbindlich/V3.1.0/Bausteine/ZubehoerEndoprotheseBasis.xsd>
attributeFormDefault:
elementFormDefault: **unqualified**
targetNamespace: **http://xml.ir-d.de/emg**

Complex types

[ZubehoerEndoprotheseBasis](#)

schema location: <http://xml.ir-d.de/rst/schema/verbindlich/V3.1.0/Bausteine/PatientenaufnahmeAortenklappeBasis.xsd>
attributeFormDefault:
elementFormDefault: **unqualified**
targetNamespace: **http://xml.ir-d.de/emg**

Complex types

[PatientenaufnahmeAortenklappeBasis](#)

schema location: <http://xml.ir-d.de/rst/schema/verbindlich/V3.1.0/Bausteine/InfektionAortenklappeBasis.xsd>
attributeFormDefault:
elementFormDefault: **unqualified**
targetNamespace: **http://xml.ir-d.de/emg**

Complex types

[InfektionAortenklappeBasis](#)

schema location: <http://xml.ir-d.de/rst/schema/verbindlich/V3.1.0/Bausteine/ArtikelbeschreibungBasis.xsd>
attributeFormDefault:
elementFormDefault: **unqualified**
targetNamespace: **http://xml.ir-d.de/emg**

Complex types

[ArtikelbeschreibungBasis](#)

schema location: <http://xml.ir-d.de/rst/schema/verbindlich/V3.1.0/Bausteine/ArtikelBrustimplantatBasis.xsd>
attributeFormDefault:
elementFormDefault: **unqualified**
targetNamespace: **http://xml.ir-d.de/emg**

Complex types

[ArtikelBrustimplantatBasis](#)

schema location: <http://xml.ir-d.de/rst/schema/verbindlich/V3.1.0/Bausteine/ArtikelEndoprotheseBasis.xsd>
attributeFormDefault:
elementFormDefault: **unqualified**
targetNamespace: **http://xml.ir-d.de/emg**

Complex types

[ArtikelEndoprotheseBasis](#)

schema location: <http://xml.ir-d.de/rst/schema/verbindlich/V3.1.0/Bausteine/ArtikelAortenklappeBasis.xsd>

attributeFormDefault:

elementFormDefault: **unqualified**

targetNamespace: **http://xml.ir-d.de/emg**

Complex types

[ArtikelAortenklappeBasis](#)

element **GEMeldung**

diagram	<p>Meldung einer implantatbezogenen Massnahme nach § 16 IRegG. Hier: Meldung/Korrektur der Gesundheitseinrichtung an die Registerstelle. Die Meldung muss wohlgeformt und im Sinne dieses Schemas gültig sein. ...</p>
namespace	http://xml.ir-d.de/rst
type	emg:GeMeldung
properties	content complex
children	meldung
annotation	documentation Meldung einer implantatbezogenen Massnahme nach § 16 IRegG. Hier: Meldung/Korrektur der Gesundheitseinrichtung an die Registerstelle. Die Meldung muss wohlgeformt und im Sinne dieses Schemas gültig sein.
source	<pre><element name="GEMeldung" type="emg:GeMeldung"> <annotation> <documentation>Meldung einer implantatbezogenen Massnahme nach § 16 IRegG. Hier: Meldung/Korrektur der Gesundheitseinrichtung an die Registerstelle. Die Meldung muss wohlgeformt und im Sinne dieses Schemas gültig sein. </documentation> </annotation> </element></pre>

element **GESelbstauskunft**

diagram	
namespace	http://xml.ir-d.de/rst
type	sak:Geselbstauskunft
properties	content complex
children	meldung
annotation	documentation Selbstauskunftersuchen an die Registerstelle.
source	<pre><element name="GESelbstauskunft" type="sak:Geselbstauskunft"> <annotation> <documentation>Selbstauskunftersuchen an die Registerstelle.</documentation> </annotation> </element></pre>

element **GEStorno**

diagram	
namespace	http://xml.ir-d.de/rst
type	stn:GEStorno
properties	content complex
children	meldung
annotation	documentation Stornierung einer Meldung mit allen evtl. erfolgten Korrekturen der Gesundheitseinrichtung an die Registerstelle.
source	<pre><element name="GEStorno" type="stn:GEStorno"> <annotation> <documentation>Stornierung einer Meldung mit allen evtl. erfolgten Korrekturen der Gesundheitseinrichtung an die Registerstelle.</documentation> </annotation> </element></pre>

element IRDMeldungAntwort

diagram	
namespace	http://xml.ir-d.de/rst
type	irdma:meldungAntwort
properties	content complex
children	meldung empfangsbestaetigung fehler warnung bestaetigung
annotation	documentation Antwort der Registerstelle auf eine Meldung/Korrektur der Gesundheitseinrichtung.
source	<pre><element name="IRDMeldungAntwort" type="irdma:meldungAntwort"> <annotation> <documentation>Antwort der Registerstelle auf eine Meldung/Korrektur der Gesundheitseinrichtung.</documentation> </annotation> </element></pre>

element IRDSelbstauskunftAntwort

diagram	
namespace	http://xml.ir-d.de/rst
type	irdsaa:selbstauskunftAntwort
properties	content complex
children	meldung empfangsbestaetigung
annotation	documentation Antwort der Registerstelle auf ein Selbstauskunftersuchen der Gesundheitseinrichtung.
source	<pre><element name="IRDSelbstauskunftAntwort" type="irdsaa:selbstauskunftAntwort"></pre>

```

<annotation>
  <documentation>Antwort der Registerstelle auf ein Selbstauskunftersuchen
der Gesundheitseinrichtung.</documentation>
</annotation>
</element>

```

element IRDStornoAntwort

diagram	
namespace	http://xml.ir-d.de/rst
type	irdsa:stornoAntwort
properties	content complex
children	meldung empfangsbestaetigung fehler
annotation	documentation Antwort der Registerstelle auf ein Storno einer Meldung mit allen evtl. erfolgten Korrekturen der Gesundheitseinrichtung.
source	<pre> <element name="IRDStornoAntwort" type="irdsa:stornoAntwort"> <annotation> <documentation>Antwort der Registerstelle auf ein Storno einer Meldung mit allen evtl. erfolgten Korrekturen der Gesundheitseinrichtung.</documentation> </annotation> </element> </pre>

complexType GeMeldung

diagram	
namespace	http://xml.ir-d.de/emg
children	meldung
used by	element GEMeldung
source	<pre> <complexType name="GeMeldung"> <sequence> <element name="meldung" type="emg:Meldung"/> </sequence> </complexType> </pre>

element **GeMeldung/meldung**

diagram	
type	Meldung
properties	content complex
children	MEL_IrdIdGesundheitseinrichtung MEL_StandortId MEL_Bsnr MEL_IrdSpezVersion MEL_SwName MEL_SwHersteller MEL_SwVersion fall
source	<code><element name="meldung" type="emg:Meldung"/></code>

complexType **GeStorno**

diagram	
namespace	http://xml.ir-d.de/stn
children	meldung
used by	element GeStorno
source	<pre> <complexType name="GeStorno"> <sequence> <element name="meldung" type="stn:Storno"/> </sequence> </complexType> </pre>

element **GeStorno/meldung**

diagram	
type	Storno
properties	content complex
children	MEL_IrdIdGesundheitseinrichtung fall
source	<code><element name="meldung" type="stn:Storno"/></code>

complexType **meldungAntwort**

diagram	
namespace	http://xml.ir-d.de/irdma
children	meldung empfangsbestaetigung fehler warnung bestaetigung
used by	element IRDMeldungAntwort
source	<pre> <complexType name="meldungAntwort"> <sequence> <element name="meldung" type="irdma:MeldungIrd"/> <element name="empfangsbestaetigung" type="irdma:EmpfangsbestaetigungBasis"/> <choice> <element name="fehler" type="irdma:HinweisBasis" maxOccurs="unbounded"/> <element name="warnung" type="irdma:Warnung"/> <element name="bestaetigung" type="irdma:BestaetigungBasis"/> </choice> </sequence> </complexType> </pre>

element **meldungAntwort/meldung**

diagram	
type	MeldungIrd
properties	content complex
children	MEL_IrdIdGesundheitseinrichtung fall
source	<code><element name="meldung" type="irdma:MeldungIrd"/></code>

element **meldungAntwort/empfangsbestaetigung**

diagram	
type	EmpfangsbestaetigungBasis
properties	content complex
children	EBG_Empfangsbestaetigung EBG_DatumZeitEmpfang
source	<code><element name="empfangsbestaetigung" type="irdma:EmpfangsbestaetigungBasis"/></code>

element **meldungAntwort/fehler**

diagram	
type	HinweisBasis
properties	minOcc 1 maxOcc unbounded content complex
children	HNW_Datenelement HNW_Meldung HNW_Wert
source	<code><element name="fehler" type="irdma:HinweisBasis" maxOccurs="unbounded"/></code>

element **meldungAntwort/warnung**

diagram	
type	Warnung
properties	content complex
children	bestaetigung hinweis
source	<code><element name="warnung" type="irdma:Warnung"/></code>

element **meldungAntwort/bestaetigung**

diagram	
type	BestaetigungBasis
properties	content complex
children	BEG Meldebestaetigung ID BEG DatumZeitMeldebestaetigung BEG AusloesendeOpsListe BEG Produktzuordnung BEG Hash String BEG Hash Wert
source	<code><element name="bestaetigung" type="irdma:BestaetigungBasis"/></code>

complexType **stornoAntwort**

diagram	
namespace	http://xml.ir-d.de/irdsa
children	meldung empfangsbestaetigung fehler
used by	element IRDStornoAntwort
source	<pre> <complexType name="stornoAntwort"> <sequence> <element name="meldung" type="irdsa:Storno"/> <element name="empfangsbestaetigung" type="irdsa:EmpfangsbestaetigungBasis"/> <element name="fehler" type="irdsa:HinweisBasis" minOccurs="0" </pre>

```

maxOccurs="unbounded"/>
</sequence>
</complexType>

```

element **stornoAntwort/meldung**

diagram	
type	Storno
properties	content complex
children	MEL_IrdIdGesundheitseinrichtung fall
source	<code><element name="meldung" type="irdsa:Storno"/></code>

element **stornoAntwort/empfangsbestaetigung**

diagram	
type	EmpfangsbestaetigungBasis
properties	content complex
children	EBG_Empfangsbestaetigung EBG_DatumZeitEmpfang
source	<code><element name="empfangsbestaetigung" type="irdsa:EmpfangsbestaetigungBasis"/></code>

element **stornoAntwort/fehler**

diagram	
type	HinweisBasis
properties	minOcc 0 maxOcc unbounded content complex
children	HNW_Datenelement HNW_Meldung HNW_Wert
source	<code><element name="fehler" type="irdsa:HinweisBasis" minOccurs="0" maxOccurs="unbounded"/></code>

complexType **GeSelbstauskunft**

diagram	
namespace	http://xml.ir-d.de/sak
children	meldung
used by	element GESelbstauskunft
source	<pre><complexType name="GeSelbstauskunft"> <sequence> <element name="meldung" type="sak:Selbstauskunft"/> </sequence> </complexType></pre>

element **GeSelbstauskunft/meldung**

diagram	
type	Selbstauskunft

properties	content complex
children	MEL_IrdIdGesundheitseinrichtung fall
source	<code><element name="meldung" type="sak:Selbstauskunft"/></code>

complexType **selbstauskunftAntwort**

diagram	
namespace	http://xml.ir-d.de/irdsaa
children	meldung empfangsbestaetigung
used by	element IRDSelbstauskunftAntwort
source	<pre> <complexType name="selbstauskunftAntwort"> <sequence> <element name="meldung" type="irdsaa:Selbstauskunft"/> <element name="empfangsbestaetigung" type="irdsaa:EmpfangsbestaetigungBasis"/> </sequence> </complexType> </pre>

element **selbstauskunftAntwort/meldung**

diagram	
type	Selbstauskunft
properties	content complex
children	MEL_IrdIdGesundheitseinrichtung fall
source	<code><element name="meldung" type="irdsaa:Selbstauskunft"/></code>

element **selbstauskunftAntwort/empfangsbestaetigung**

diagram	
type	EmpfangsbestaetigungBasis
properties	content complex
children	EBG_Empfangsbestaetigung EBG_DatumZeitEmpfang
source	<code><element name="empfangsbestaetigung" type="irdsaa:EmpfangsbestaetigungBasis"/></code>

complexType **Meldung**

diagram	
namespace	http://xml.ir-d.de/emg
type	extension of MeldungBasis

properties	base MeldungBasis
children	MEL IrdIdGesundheitseinrichtung MEL StandortId MEL Bsnr MEL IrdSpezVersion MEL SwName MEL SwHersteller MEL SwVersion fall
used by	element GeMeldung/meldung
source	<pre> <complexType name="Meldung"> <complexContent> <extension base="MeldungBasis"> <sequence> <element name="fall" type="Fall"/> </sequence> </extension> </complexContent> </complexType> </pre>

element **Meldung/fall**

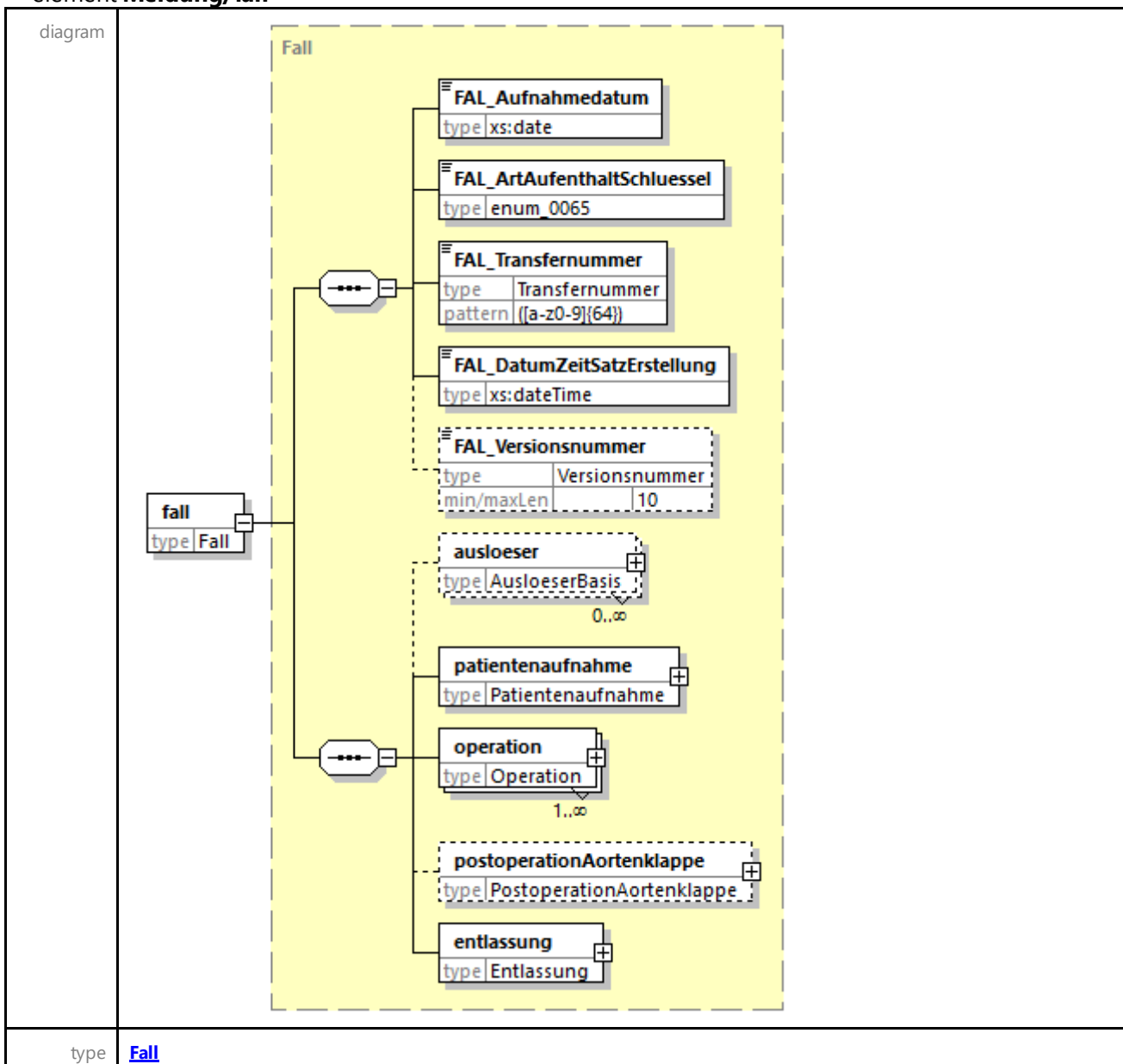

properties	content complex
children	FAL_Aufnahmedatum FAL_ArtAufenthaltSchluessel FAL_Transfernummer FAL_DatumZeitSatzErstellung FAL_Versionsnummer ausloeser patientenaufnahme operation postoperationAortenklappe entlassung
source	<code><element name="fall" type="Fall"/></code>

complexType **Storno**

diagram	
namespace	http://xml.ir-d.de/stn
type	extension of MeldungIrdBasis
properties	base MeldungIrdBasis
children	MEL_IrdIdGesundheitseinrichtung fall
used by	element GeStorno/meldung
source	<pre> <complexType name="Storno"> <complexContent> <extension base="MeldungIrdBasis"> <sequence> <element name="fall" type="StornoFallBasis"/> </sequence> </extension> </complexContent> </complexType> </pre>

element **Storno/fall**

diagram	
type	StornoFallBasis
properties	content complex
children	FAL_Transfernummer FAL_Aufnahmedatum
source	<code><element name="fall" type="StornoFallBasis"/></code>

complexType MeldungIrd

diagram	
namespace	http://xml.ir-d.de/irdma
type	extension of MeldungIrdBasis
properties	base MeldungIrdBasis
children	MEL_IrdIdGesundheitseinrichtung fall
used by	element meldungAntwort/meldung
source	<pre> <complexType name="MeldungIrd"> <complexContent> <extension base="MeldungIrdBasis"> <sequence> <element name="fall" type="MeldungIrdFallBasis"/> </sequence> </extension> </complexContent> </complexType> </pre>

element MeldungIrd/fall

diagram	
type	MeldungIrdFallBasis
properties	content complex
children	FAL_Transfernummer FAL_DatumZeitSatzErstellung
source	<pre> <element name="fall" type="MeldungIrdFallBasis"/> </pre>

complexType **EmpfangsbestaetigungBasis**

diagram	
namespace	http://xml.ir-d.de/irdma
children	EBG Empfangsbestaetigung EBG DatumZeitEmpfang
used by	element meldungAntwort/empfangsbestaetigung
source	<pre><complexType name="EmpfangsbestaetigungBasis"> <sequence> <element name="EBG_Empfangsbestaetigung" type="Freitext250" fixed="Hiermit wird der Eingang Ihrer Anfrage bestätigt"/> <element name="EBG_DatumZeitEmpfang" type="xs:dateTime"/> </sequence> </complexType></pre>

element **EmpfangsbestaetigungBasis/EBG_Empfangsbestaetigung**

diagram							
type	Freitext250						
properties	content simple fixed Hiermit wird der Eingang Ihrer Anfrage bestätigt						
facets	<table border="1"> <thead> <tr> <th>Kind</th> <th>Value</th> <th>Annotation</th> </tr> </thead> <tbody> <tr> <td>maxLength</td> <td>250</td> <td></td> </tr> </tbody> </table>	Kind	Value	Annotation	maxLength	250	
Kind	Value	Annotation					
maxLength	250						
source	<pre><element name="EBG_Empfangsbestaetigung" type="Freitext250" fixed="Hiermit wird der Eingang Ihrer Anfrage bestätigt"/></pre>						

element **EmpfangsbestaetigungBasis/EBG_DatumZeitEmpfang**

diagram	
type	dateTime
properties	content simple
source	<pre><element name="EBG_DatumZeitEmpfang" type="xs:dateTime"/></pre>

complexType **HinweisBasis**

diagram	
namespace	http://xml.ir-d.de/irdma
children	HNW_Datenelement HNW Meldung HNW Wert
used by	elements meldungAntwort/fehler Warnung/hinweis
source	<pre><complexType name="HinweisBasis"> <sequence> <element name="HNW_Datenelement" type="Freitext500"/> <element name="HNW_Meldung" type="Freitext500"/> <element name="HNW_Wert" type="Freitext500"/> </sequence> </complexType></pre>

element **HinweisBasis/HNW_Datenelement**

diagram							
type	Freitext500						
properties	content simple						
facets	<table border="1"> <thead> <tr> <th>Kind</th> <th>Value</th> <th>Annotation</th> </tr> </thead> <tbody> <tr> <td>maxLength</td> <td>500</td> <td></td> </tr> </tbody> </table>	Kind	Value	Annotation	maxLength	500	
Kind	Value	Annotation					
maxLength	500						
source	<pre><element name="HNW_Datenelement" type="Freitext500"/></pre>						

element **HinweisBasis/HNW_Meldung**

diagram							
type	Freitext500						
properties	content simple						
facets	<table border="1"> <thead> <tr> <th>Kind</th> <th>Value</th> <th>Annotation</th> </tr> </thead> <tbody> <tr> <td>maxLength</td> <td>500</td> <td></td> </tr> </tbody> </table>	Kind	Value	Annotation	maxLength	500	
Kind	Value	Annotation					
maxLength	500						
source	<pre><element name="HNW_Meldung" type="Freitext500"/></pre>						

element **HinweisBasis/HNW_Wert**

diagram							
type	Freitext500						
properties	content simple						
facets	<table border="1"> <tr> <td>Kind</td> <td>Value</td> <td>Annotation</td> </tr> <tr> <td>maxLength</td> <td>500</td> <td></td> </tr> </table>	Kind	Value	Annotation	maxLength	500	
Kind	Value	Annotation					
maxLength	500						
source	<code><element name="HNW_Wert" type="Freitext500"/></code>						

complexType **Warnung**

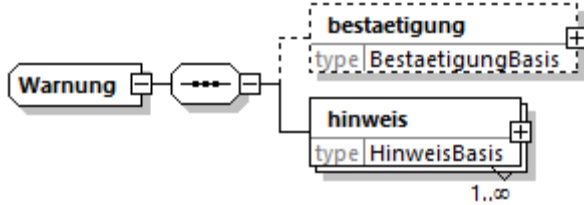
diagram	
namespace	http://xml.ir-d.de/irdma
children	bestaetigung hinweis
used by	element meldungAntwort/warnung
source	<pre> <complexType name="Warnung"> <sequence> <element name="bestaetigung" type="BestaetigungBasis" minOccurs="0"/> <element name="hinweis" type="HinweisBasis" maxOccurs="unbounded"/> </sequence> </complexType> </pre>

element **Warnung/bestaetigung**

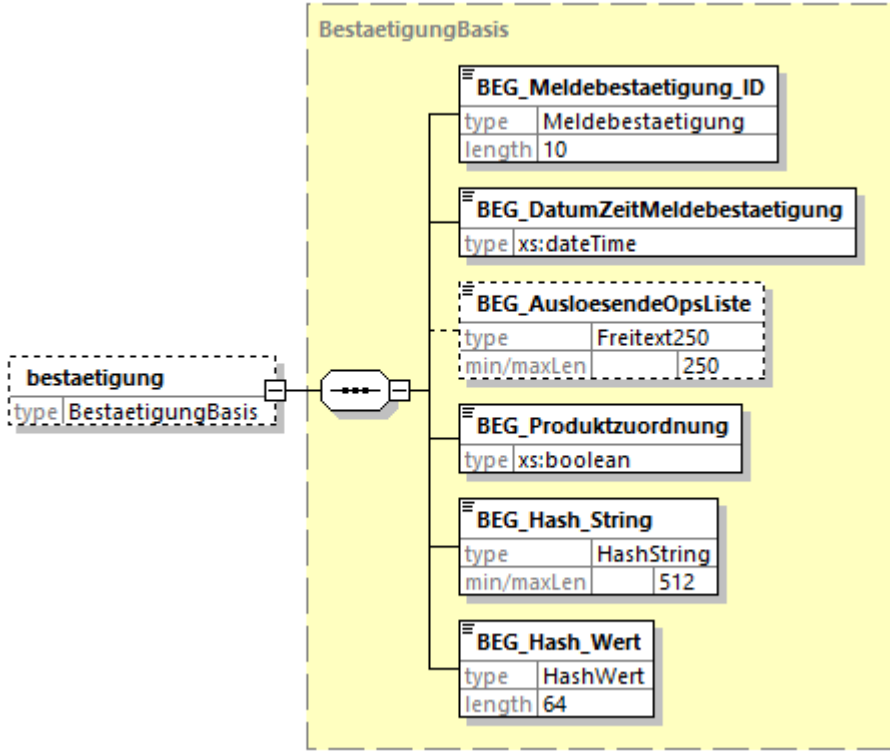
diagram	
type	BestaetigungBasis
properties	minOcc 0 maxOcc 1 content complex
children	BEG Meldebestaetigung ID BEG DatumZeitMeldebestaetigung BEG AusloesendeOpsListe BEG Produktzuordnung BEG Hash String BEG Hash Wert
source	<code><element name="bestaetigung" type="BestaetigungBasis" minOccurs="0"/></code>

element **Warnung/hinweis**

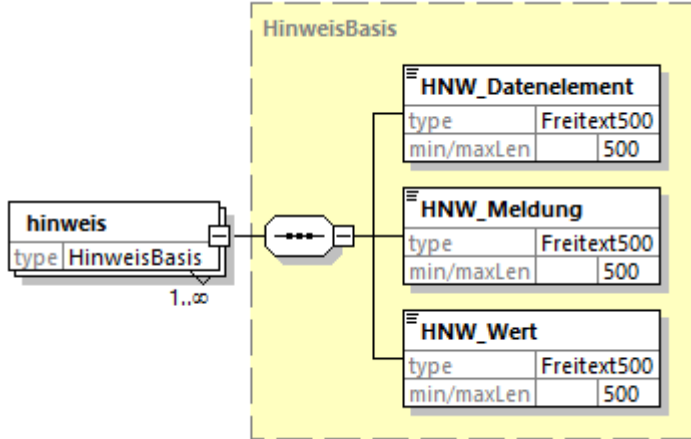
diagram	
type	HinweisBasis
properties	minOcc 1 maxOcc unbounded content complex

children	HNW Datenelement HNW Meldung HNW Wert
source	<code><element name="hinweis" type="HinweisBasis" maxOccurs="unbounded"/></code>

complexType **BestaetigungBasis**

diagram	
namespace	http://xml.ir-d.de/irdma
children	BEG Meldebestaetigung ID BEG DatumZeitMeldebestaetigung BEG AusloesendeOpsListe BEG Produktzuordnung BEG Hash String BEG Hash Wert
used by	elements meldungAntwort/bestaetigung Warnung/bestaetigung
source	<pre> <complexType name="BestaetigungBasis"> <sequence> <element name="BEG_Meldebestaetigung_ID" type="Meldebestaetigung"/> <element name="BEG_DatumZeitMeldebestaetigung" type="xs:dateTime"/> <element name="BEG_AusloesendeOpsListe" type="Freitext250" minOccurs="0"/> <element name="BEG_Produktzuordnung" type="xs:boolean"/> <element name="BEG_Hash_String" type="HashString"/> <element name="BEG_Hash_Wert" type="HashWert"/> </sequence> </complexType> </pre>

element **BestaetigungBasis/BEG_Meldebestaetigung_ID**

diagram	
type	Meldebestaetigung
properties	content simple
facets	Kind Value Annotation length 10

source	<code><element name="BEG_Meldebestaetigung_ID" type="Meldebestaetigung"/></code>
--------	--

element **BestaetigungBasis/BEG_DatumZeitMeldebestaetigung**

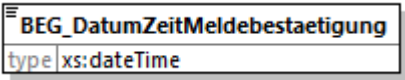
diagram	
type	dateTime
properties	content simple
source	<code><element name="BEG_DatumZeitMeldebestaetigung" type="xs:dateTime"/></code>

element **BestaetigungBasis/BEG_AusloesendeOpsListe**

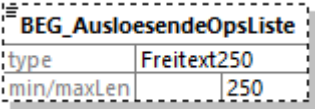
diagram							
type	Freitext250						
properties	minOcc 0 maxOcc 1 content simple						
facets	<table border="1"> <thead> <tr> <th>Kind</th> <th>Value</th> <th>Annotation</th> </tr> </thead> <tbody> <tr> <td>maxLength</td> <td>250</td> <td></td> </tr> </tbody> </table>	Kind	Value	Annotation	maxLength	250	
Kind	Value	Annotation					
maxLength	250						
source	<code><element name="BEG_AusloesendeOpsListe" type="Freitext250" minOccurs="0"/></code>						

element **BestaetigungBasis/BEG_Produktzuordnung**

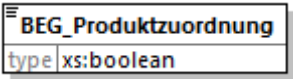
diagram	
type	boolean
properties	content simple
source	<code><element name="BEG_Produktzuordnung" type="xs:boolean"/></code>

element **BestaetigungBasis/BEG_Hash_String**

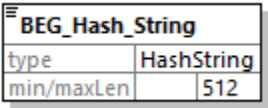
diagram							
type	HashString						
properties	content simple						
facets	<table border="1"> <thead> <tr> <th>Kind</th> <th>Value</th> <th>Annotation</th> </tr> </thead> <tbody> <tr> <td>maxLength</td> <td>512</td> <td></td> </tr> </tbody> </table>	Kind	Value	Annotation	maxLength	512	
Kind	Value	Annotation					
maxLength	512						
source	<code><element name="BEG_Hash_String" type="HashString"/></code>						

element **BestaetigungBasis/BEG_Hash_Wert**

diagram	
type	HashWert
properties	content simple
facets	Kind Value Annotation length 64
source	<code><element name="BEG_Hash_Wert" type="HashWert"/></code>

complexType **Storno**

diagram	
namespace	http://xml.ir-d.de/irdsa
type	extension of MeldungIrdBasis
properties	base MeldungIrdBasis
children	MEL_IrdIdGesundheitseinrichtung fall
used by	element stornoAntwort/meldung
source	<pre> <complexType name="Storno"> <complexContent> <extension base="MeldungIrdBasis"> <sequence> <element name="fall" type="StornoFallBasis"/> </sequence> </extension> </complexContent> </complexType> </pre>

element **Storno/fall**

diagram	<p>The diagram shows an element 'fall' with type 'StornoFallBasis' connected to a container 'StornoFallBasis'. Inside this container, there are two child elements: 'FAL_Transfernummer' (type: Transfernummer, pattern: [(a-z0-9){(64)}) and 'FAL_Aufnahmedatum' (type: xs:date).</p>
type	StornoFallBasis
properties	content complex
children	FAL Transfernummer FAL Aufnahmedatum
source	<code><element name="fall" type="StornoFallBasis"/></code>

complexType **EmpfangsbestaetigungBasis**

diagram	<p>The diagram shows a complex type 'EmpfangsbestaetigungBasis' containing two child elements: 'EBG_Empfangsbestaetigung' (type: Freitext250, fixed: Hiermit wird der Einga..., min/maxLen: 250) and 'EBG_DatumZeitEmpfang' (type: xs:dateTime).</p>
namespace	http://xml.ir-d.de/irdsa
children	EBG Empfangsbestaetigung EBG DatumZeitEmpfang
used by	element stornoAntwort/empfangsbestaetigung
source	<pre> <complexType name="EmpfangsbestaetigungBasis"> <sequence> <element name="EBG_Empfangsbestaetigung" type="Freitext250" fixed="Hiermit wird der Eingang Ihrer Anfrage bestätigt"/> <element name="EBG_DatumZeitEmpfang" type="xs:dateTime"/> </sequence> </complexType> </pre>

element **EmpfangsbestaetigungBasis/EBG_Empfangsbestaetigung**

diagram	<p>The diagram shows the element 'EBG_Empfangsbestaetigung' with properties: type: Freitext250, fixed: Hiermit wird der Einga..., min/maxLen: 250.</p>						
type	Freitext250						
properties	content simple fixed Hiermit wird der Eingang Ihrer Anfrage bestätigt						
facets	<table border="1"> <thead> <tr> <th>Kind</th> <th>Value</th> <th>Annotation</th> </tr> </thead> <tbody> <tr> <td>maxLength</td> <td>250</td> <td></td> </tr> </tbody> </table>	Kind	Value	Annotation	maxLength	250	
Kind	Value	Annotation					
maxLength	250						
source	<code><element name="EBG_Empfangsbestaetigung" type="Freitext250" fixed="Hiermit wird</code>						

der Eingang Ihrer Anfrage bestätigt"/>

element **EmpfangsbestaetigungBasis/EBG_DatumZeitEmpfang**

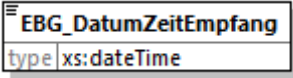
diagram	 <p>The diagram shows a box for the element EBG_DatumZeitEmpfang with the property <code>type xs:dateTime</code>.</p>
type	dateTime
properties	content simple
source	<code><element name="EBG_DatumZeitEmpfang" type="xs:dateTime"/></code>

complexType **HinweisBasis**

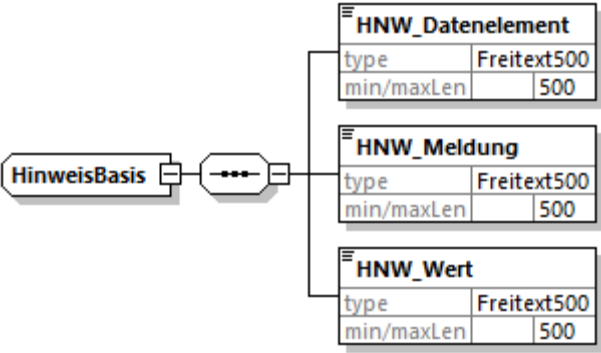
diagram	 <p>The diagram shows a complex type HinweisBasis containing a sequence of three elements: HNW_Datenelement, HNW_Meldung, and HNW_Wert. Each element has the type <code>Freitext500</code> and a <code>min/maxLen</code> of <code>500</code>.</p>
namespace	http://xml.ir-d.de/irdsa
children	HNW_Datenelement HNW_Meldung HNW_Wert
used by	element stornoAntwort/fehler
source	<pre><complexType name="HinweisBasis"> <sequence> <element name="HNW_Datenelement" type="Freitext500"/> <element name="HNW_Meldung" type="Freitext500"/> <element name="HNW_Wert" type="Freitext500"/> </sequence> </complexType></pre>

element **HinweisBasis/HNW_Datenelement**

diagram	 <p>The diagram shows a box for the element HNW_Datenelement with the type <code>Freitext500</code> and <code>min/maxLen</code> of <code>500</code>.</p>
type	Freitext500
properties	content simple
facets	Kind Value Annotation maxLength 500
source	<code><element name="HNW_Datenelement" type="Freitext500"/></code>

element **HinweisBasis/HNW_Meldung**

diagram							
type	Freitext500						
properties	content simple						
facets	<table border="1"> <thead> <tr> <th>Kind</th> <th>Value</th> <th>Annotation</th> </tr> </thead> <tbody> <tr> <td>maxLength</td> <td>500</td> <td></td> </tr> </tbody> </table>	Kind	Value	Annotation	maxLength	500	
Kind	Value	Annotation					
maxLength	500						
source	<code><element name="HNW_Meldung" type="Freitext500"/></code>						

element **HinweisBasis/HNW_Wert**

diagram							
type	Freitext500						
properties	content simple						
facets	<table border="1"> <thead> <tr> <th>Kind</th> <th>Value</th> <th>Annotation</th> </tr> </thead> <tbody> <tr> <td>maxLength</td> <td>500</td> <td></td> </tr> </tbody> </table>	Kind	Value	Annotation	maxLength	500	
Kind	Value	Annotation					
maxLength	500						
source	<code><element name="HNW_Wert" type="Freitext500"/></code>						

complexType **Selbstauskunft**

diagram	
namespace	http://xml.ir-d.de/sak
type	extension of MeldungIrdBasis
properties	base MeldungIrdBasis
children	MEL_IrdIdGesundheitseinrichtung fall
used by	element GeSelbstauskunft/meldung
source	<pre> <complexType name="Selbstauskunft"> <complexContent> <extension base="MeldungIrdBasis"> <sequence> <element name="fall" type="SelbstauskunftFallBasis"/> </sequence> </extension> </complexContent> </complexType> </pre>

```

</complexContent>
</complexType>

```

element **Selbstauskunft/fall**

diagram	
type	SelbstauskunftFallBasis
properties	content complex
children	FAL_Transfernummer
source	<code><element name="fall" type="SelbstauskunftFallBasis"/></code>

complexType **Selbstauskunft**

diagram	
namespace	http://xml.ir-d.de/irdsaa
type	extension of MeldungIrdBasis
properties	base MeldungIrdBasis
children	MEL_IrdIdGesundheitseinrichtung fall
used by	element selbstauskunftAntwort/meldung
source	<pre> <complexType name="Selbstauskunft"> <complexContent> <extension base="MeldungIrdBasis"> <sequence> <element name="fall" type="SelbstauskunftFallBasis"/> </sequence> </extension> </complexContent> </complexType> </pre>

element **Selbstauskunft/fall**

diagram	
type	SelbstauskunftFallBasis
properties	content complex
children	FAL Transfertextnummer
source	<code><element name="fall" type="SelbstauskunftFallBasis"/></code>

complexType **EmpfangsbestaetigungBasis**

diagram	
namespace	http://xml.ir-d.de/irdsaa
children	EBG Empfangsbestaetigung EBG DatumZeitEmpfang
used by	element selbstauskunftAntwort/empfangsbestaetigung
source	<pre> <complexType name="EmpfangsbestaetigungBasis"> <sequence> <element name="EBG_Empfangsbestaetigung" type="Freitext250" fixed="Hiermit wird der Eingang Ihrer Anfrage bestätigt"/> <element name="EBG_DatumZeitEmpfang" type="xs:dateTime"/> </sequence> </complexType> </pre>

element **EmpfangsbestaetigungBasis/EBG_Empfangsbestaetigung**

diagram							
type	Freitext250						
properties	content simple fixed Hiermit wird der Eingang Ihrer Anfrage bestätigt						
facets	<table border="1"> <thead> <tr> <th>Kind</th> <th>Value</th> <th>Annotation</th> </tr> </thead> <tbody> <tr> <td>maxLength</td> <td>250</td> <td></td> </tr> </tbody> </table>	Kind	Value	Annotation	maxLength	250	
Kind	Value	Annotation					
maxLength	250						
source	<code><element name="EBG_Empfangsbestaetigung" type="Freitext250" fixed="Hiermit wird der Eingang Ihrer Anfrage bestätigt"/></code>						

element **EmpfangsbestaetigungBasis/EBG_DatumZeitEmpfang**

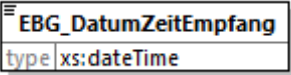
diagram	
type	dateTime
properties	content simple
source	<code><element name="EBG_DatumZeitEmpfang" type="xs:dateTime"/></code>

complexType **MeldungBasis**

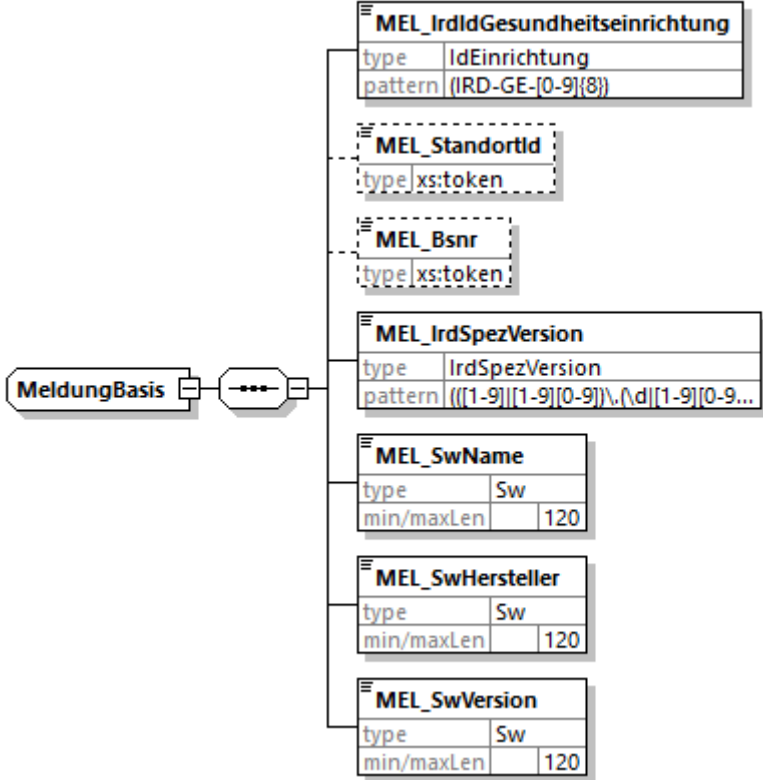
diagram	
namespace	http://xml.ir-d.de/emg
children	MEL_IrdIdGesundheitseinrichtung MEL_StandortId MEL_Bsnr MEL_IrdSpezVersion MEL_SwName MEL_SwHersteller MEL_SwVersion
used by	complexType Meldung
source	<pre> <complexType name="MeldungBasis"> <sequence> <element name="MEL_IrdIdGesundheitseinrichtung" type="IdEinrichtung"/> <element name="MEL_StandortId" type="xs:token" minOccurs="0"/> <element name="MEL_Bsnr" type="xs:token" minOccurs="0"/> <element name="MEL_IrdSpezVersion" type="IrdSpezVersion"/> <element name="MEL_SwName" type="Sw"/> <element name="MEL_SwHersteller" type="Sw"/> <element name="MEL_SwVersion" type="Sw"/> </sequence> </complexType> </pre>

element **MeldungBasis/MEL_IrdIdGesundheitseinrichtung**

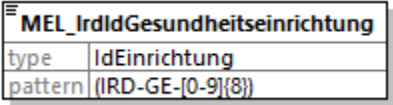
diagram							
type	IdEinrichtung						
properties	content simple						
facets	<table border="1"> <thead> <tr> <th>Kind</th> <th>Value</th> <th>Annotation</th> </tr> </thead> <tbody> <tr> <td>pattern</td> <td>(IRD-GE-[0-9]{8})</td> <td></td> </tr> </tbody> </table>	Kind	Value	Annotation	pattern	(IRD-GE-[0-9]{8})	
Kind	Value	Annotation					
pattern	(IRD-GE-[0-9]{8})						
source	<code><element name="MEL_IrdIdGesundheitseinrichtung" type="IdEinrichtung"/></code>						

element **MeldungBasis/MEL_StandortId**

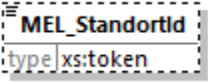
diagram							
type	token						
properties	<table border="1"> <tbody> <tr> <td>minOcc</td> <td>0</td> </tr> <tr> <td>maxOcc</td> <td>1</td> </tr> <tr> <td>content</td> <td>simple</td> </tr> </tbody> </table>	minOcc	0	maxOcc	1	content	simple
minOcc	0						
maxOcc	1						
content	simple						
source	<code><element name="MEL_StandortId" type="xs:token" minOccurs="0"/></code>						

element **MeldungBasis/MEL_Bsnr**

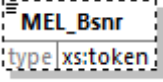
diagram							
type	token						
properties	<table border="1"> <tbody> <tr> <td>minOcc</td> <td>0</td> </tr> <tr> <td>maxOcc</td> <td>1</td> </tr> <tr> <td>content</td> <td>simple</td> </tr> </tbody> </table>	minOcc	0	maxOcc	1	content	simple
minOcc	0						
maxOcc	1						
content	simple						
source	<code><element name="MEL_Bsnr" type="xs:token" minOccurs="0"/></code>						

element **MeldungBasis/MEL_IrdSpezVersion**

diagram							
type	IrdSpezVersion						
properties	content simple						
facets	<table border="1"> <thead> <tr> <th>Kind</th> <th>Value</th> <th>Annotation</th> </tr> </thead> <tbody> <tr> <td>pattern</td> <td>((([1-9] [1-9][0-9])\.\d [1-9][0-9])\.\d [1-9][0-9]...)</td> <td></td> </tr> </tbody> </table>	Kind	Value	Annotation	pattern	((([1-9] [1-9][0-9])\.\d [1-9][0-9])\.\d [1-9][0-9]...)	
Kind	Value	Annotation					
pattern	((([1-9] [1-9][0-9])\.\d [1-9][0-9])\.\d [1-9][0-9]...)						
source	<code><element name="MEL_IrdSpezVersion" type="IrdSpezVersion"/></code>						

element **MeldungBasis/MEL_SwName**

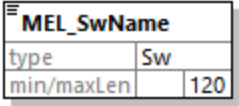
diagram							
type	Sw						
properties	content simple						
facets	<table border="1"> <tr> <td>Kind</td> <td>Value</td> <td>Annotation</td> </tr> <tr> <td>maxLength</td> <td>120</td> <td></td> </tr> </table>	Kind	Value	Annotation	maxLength	120	
Kind	Value	Annotation					
maxLength	120						
source	<code><element name="MEL_SwName" type="Sw"/></code>						

element **MeldungBasis/MEL_SwHersteller**

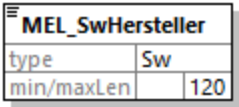
diagram							
type	Sw						
properties	content simple						
facets	<table border="1"> <tr> <td>Kind</td> <td>Value</td> <td>Annotation</td> </tr> <tr> <td>maxLength</td> <td>120</td> <td></td> </tr> </table>	Kind	Value	Annotation	maxLength	120	
Kind	Value	Annotation					
maxLength	120						
source	<code><element name="MEL_SwHersteller" type="Sw"/></code>						

element **MeldungBasis/MEL_SwVersion**

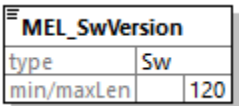
diagram							
type	Sw						
properties	content simple						
facets	<table border="1"> <tr> <td>Kind</td> <td>Value</td> <td>Annotation</td> </tr> <tr> <td>maxLength</td> <td>120</td> <td></td> </tr> </table>	Kind	Value	Annotation	maxLength	120	
Kind	Value	Annotation					
maxLength	120						
source	<code><element name="MEL_SwVersion" type="Sw"/></code>						

complexType **Fall**

<p>diagram</p>	
<p>namespace</p>	<p>http://xml.ir-d.de/emg</p>
<p>type</p>	<p>extension of FallBasis</p>
<p>properties</p>	<p>base FallBasis</p>
<p>children</p>	<p>FAL Aufnahmedatum FAL ArtAufenthaltSchluessel FAL Transfernummer FAL DatumZeitSatzErstellung FAL Versionsnummer ausloeser patientenaufnahme operation postoperationAortenklappe entlassung</p>
<p>used by</p>	<p>element Meldung/fall</p>
<p>source</p>	<pre><complexType name="Fall"> <complexContent> <extension base="FallBasis"> <sequence> <element name="ausloeser" type="AusloeserBasis" minOccurs="0" maxOccurs="unbounded"/> <element name="patientenaufnahme" type="Patientenaufnahme"/> <element name="operation" type="Operation" maxOccurs="unbounded"/> <element name="postoperationAortenklappe" type="PostoperationAortenklappe" minOccurs="0"/> <element name="entlassung" type="Entlassung"/> </sequence> </extension> </complexContent> </complexType></pre>

```

</sequence>
</extension>
</complexContent>
</complexType>

```

element Fall/ausloeser

diagram	
type	AusloeserBasis
properties	minOcc 0 maxOcc unbounded content complex
children	ALR_ProzedurenSchluessel
source	<code><element name="ausloeser" type="AusloeserBasis" minOccurs="0" maxOccurs="unbounded"/></code>

element Fall/patientenaufnahme

diagram	
type	Patientenaufnahme
properties	content complex
children	PAT Alter PAT Groesse PAT Gewicht PAT GeschlechtSchluessel patientenaufnahmeBrustimplantat patientenaufnahmeKardiologie
source	<code><element name="patientenaufnahme" type="Patientenaufnahme"/></code>

element **Fall/operation**

<p>diagram</p>	
<p>type</p>	<p>Operation</p>
<p>properties</p>	<p>minOcc 1 maxOcc unbounded content complex</p>
<p>children</p>	<p>OPE LaufendeNummer OPE Datum OPE SeitenLokalisationSchluessel OPE AsaSchluessel OPE ImplantattypSchluessel operationBrustimplantat operationEndoprothese operationAortenklappe artikelidentifikation zubehoer</p>
<p>source</p>	<pre><element name="operation" type="Operation" maxOccurs="unbounded"/></pre>

element Fall/postoperationAortenklappe

diagram

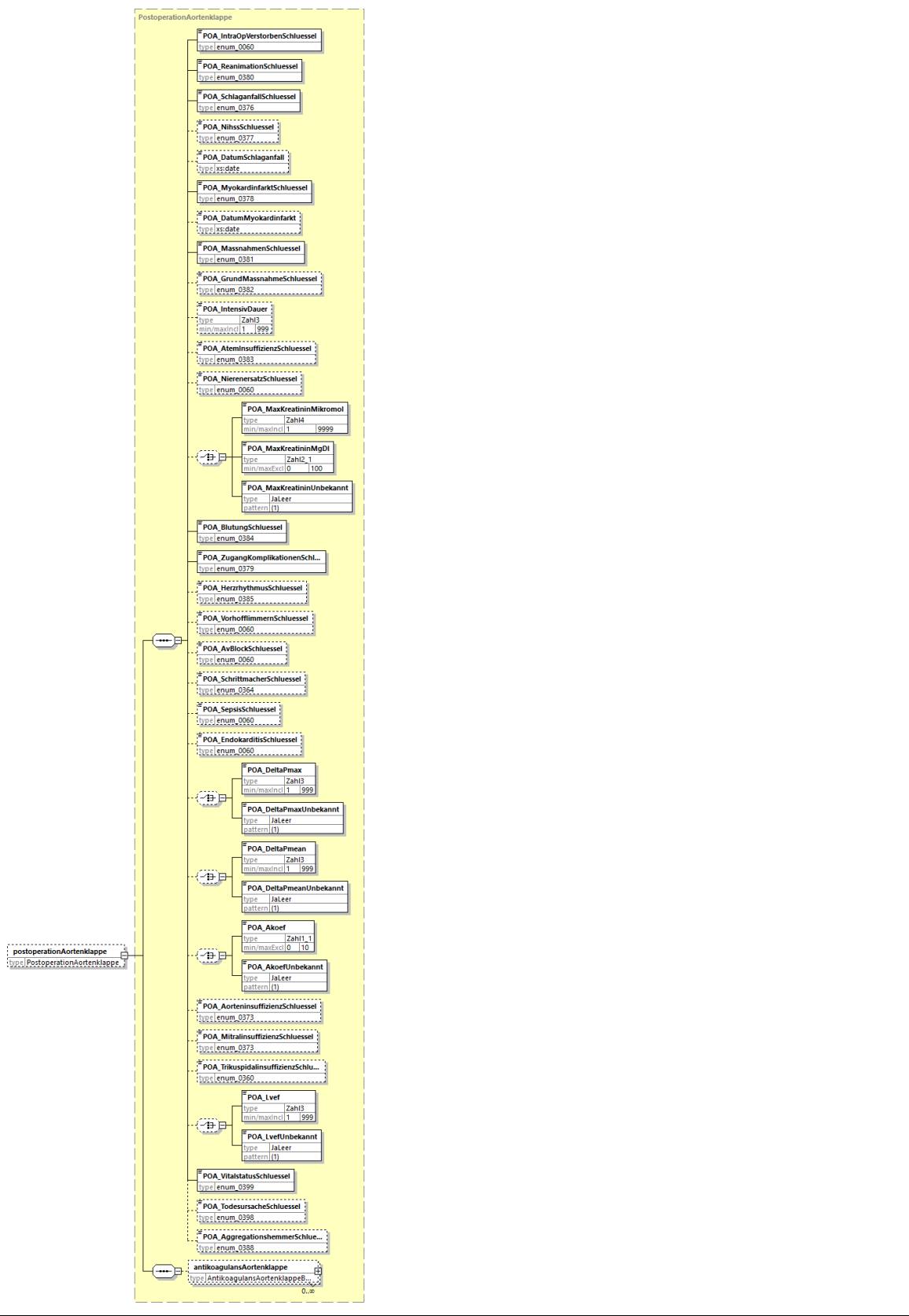

type	PostoperationAortenklappe
properties	minOcc 0 maxOcc 1 content complex

children	POA IntraOpVerstorbenSchluessel POA ReanimationSchluessel POA SchlaganfallSchluessel POA NihssSchluessel POA DatumSchlaganfall POA MyokardinfarktSchluessel POA DatumMyokardinfarkt POA MassnahmenSchluessel POA GrundMassnahmeSchluessel POA IntensivDauer POA AtemInsuffizienzSchluessel POA NierenersatzSchluessel POA MaxKreatininMikromol POA MaxKreatininMgDI POA MaxKreatininUnbekannt POA BlutungSchluessel POA ZugangKomplikationenSchluessel POA HerzrhythmusSchluessel POA VorhofflimmernSchluessel POA AvBlockSchluessel POA SchrittmacherSchluessel POA SepsisSchluessel POA EndokarditisSchluessel POA DeltaPmax POA DeltaPmaxUnbekannt POA DeltaPmean POA DeltaPmeanUnbekannt POA Akoef POA AkoefUnbekannt POA AorteninsuffizienzSchluessel POA MitralinsuffizienzSchluessel POA TrikuspidalinsuffizienzSchluessel POA Lvef POA LvefUnbekannt POA VitalstatusSchluessel POA TodesursacheSchluessel POA AggregationshemmerSchluessel antikoagulansAortenklappe
source	<pre><element name="postoperationAortenklappe" type="PostoperationAortenklappe" minOccurs="0"/></pre>

element **Fall/entlassung**

diagram	
type	Entlassung
properties	content complex
children	ENT_Datum ENT_GrundSchluessel diagnoseBrustimplantat diagnoseEndoprothese diagnoseAortenklappe
source	<pre><element name="entlassung" type="Entlassung"/></pre>

simpleType **DatumText**

namespace	http://xml.ir-d.de/stn						
type	restriction of token						
properties	base xs:token						
facets	<table border="0"> <tr> <td>Kind</td> <td>Value</td> <td>Annotation</td> </tr> <tr> <td>pattern</td> <td>((([0-9]{4})([0-9]{2})?([0-9]{2})?)?)</td> <td></td> </tr> </table>	Kind	Value	Annotation	pattern	((([0-9]{4})([0-9]{2})?([0-9]{2})?)?)	
Kind	Value	Annotation					
pattern	((([0-9]{4})([0-9]{2})?([0-9]{2})?)?)						
annotation	documentation Facette zur Festlegung des freien Datumformats: JJJJ[-MM][-TT]						

source	<pre> <simpleType name="DatumText"> <annotation> <documentation>Facette zur Festlegung des freien Datumformats: JJJJ[-MM[-TT]]</documentation> </annotation> <restriction base="xs:token"> <pattern value="((([0-9]{4})([-][0-9]{2})?([-][0-9]{2})?)"/> </restriction> </simpleType> </pre>
--------	---

simpleType **Freitext250**

namespace	http://xml.ir-d.de/stn						
type	restriction of token						
properties	base xs:token						
facets	<table border="1"> <thead> <tr> <th>Kind</th> <th>Value</th> <th>Annotation</th> </tr> </thead> <tbody> <tr> <td>maxLength</td> <td>250</td> <td></td> </tr> </tbody> </table>	Kind	Value	Annotation	maxLength	250	
Kind	Value	Annotation					
maxLength	250						
annotation	documentation Facette zur Festlegung des Freitextes von 250 Zeichen						
source	<pre> <simpleType name="Freitext250"> <annotation> <documentation>Facette zur Festlegung des Freitextes von 250 Zeichen</documentation> </annotation> <restriction base="xs:token"> <maxLength value="250"/> </restriction> </simpleType> </pre>						

simpleType **Freitext500**

namespace	http://xml.ir-d.de/stn						
type	restriction of token						
properties	base xs:token						
facets	<table border="1"> <thead> <tr> <th>Kind</th> <th>Value</th> <th>Annotation</th> </tr> </thead> <tbody> <tr> <td>maxLength</td> <td>500</td> <td></td> </tr> </tbody> </table>	Kind	Value	Annotation	maxLength	500	
Kind	Value	Annotation					
maxLength	500						
annotation	documentation Facette zur Festlegung des Freitextes von 500 Zeichen						
source	<pre> <simpleType name="Freitext500"> <annotation> <documentation>Facette zur Festlegung des Freitextes von 500 Zeichen</documentation> </annotation> <restriction base="xs:token"> <maxLength value="500"/> </restriction> </simpleType> </pre>						

simpleType **HashString**

namespace	http://xml.ir-d.de/stn
-----------	------------------------

type	restriction of token						
properties	base xs:token						
facets	<table border="1"> <thead> <tr> <th>Kind</th> <th>Value</th> <th>Annotation</th> </tr> </thead> <tbody> <tr> <td>maxLength</td> <td>512</td> <td></td> </tr> </tbody> </table>	Kind	Value	Annotation	maxLength	512	
Kind	Value	Annotation					
maxLength	512						
annotation	documentation Facette zur Festlegung des Hash-Strings der Meldebestätigung						
source	<pre><simpleType name="HashString"> <annotation> <documentation>Facette zur Festlegung des Hash-Strings der Meldebestätigung</documentation> </annotation> <restriction base="xs:token"> <maxLength value="512"/> </restriction> </simpleType></pre>						

simpleType HashWert

namespace	http://xml.ir-d.de/stn						
type	restriction of token						
properties	base xs:token						
facets	<table border="1"> <thead> <tr> <th>Kind</th> <th>Value</th> <th>Annotation</th> </tr> </thead> <tbody> <tr> <td>length</td> <td>64</td> <td></td> </tr> </tbody> </table>	Kind	Value	Annotation	length	64	
Kind	Value	Annotation					
length	64						
annotation	documentation Facette zur Festlegung des Hashwertes der Meldebestätigung						
source	<pre><simpleType name="HashWert"> <annotation> <documentation>Facette zur Festlegung des Hashwertes der Meldebestätigung</documentation> </annotation> <restriction base="xs:token"> <length value="64"/> </restriction> </simpleType></pre>						

simpleType ICD

namespace	http://xml.ir-d.de/stn						
type	restriction of token						
properties	base xs:token						
facets	<table border="1"> <thead> <tr> <th>Kind</th> <th>Value</th> <th>Annotation</th> </tr> </thead> <tbody> <tr> <td>pattern</td> <td>([a-zA-Z][0-9]{2}(\.[0-9]{1,2})?(:[RLB])?)</td> <td></td> </tr> </tbody> </table>	Kind	Value	Annotation	pattern	([a-zA-Z][0-9]{2}(\.[0-9]{1,2})?(:[RLB])?)	
Kind	Value	Annotation					
pattern	([a-zA-Z][0-9]{2}(\.[0-9]{1,2})?(:[RLB])?)						
annotation	documentation Facette zur Festlegung des ICD Code						
source	<pre><simpleType name="ICD"> <annotation> <documentation>Facette zur Festlegung des ICD Code</documentation> </annotation> <restriction base="xs:token"> <pattern value="([a-zA-Z][0-9]{2}(\.[0-9]{1,2})?(:[RLB])?)"/> </restriction> </simpleType></pre>						

	<code></simpleType></code>
--	----------------------------------

simpleType IdEinrichtung

namespace	http://xml.ir-d.de/stn						
type	restriction of token						
properties	base xs:token						
used by	element MeldungIrdBasis/MEL IrdIdGesundheitseinrichtung						
facets	<table border="1"> <thead> <tr> <th>Kind</th> <th>Value</th> <th>Annotation</th> </tr> </thead> <tbody> <tr> <td>pattern</td> <td>(IRD-GE-[0-9]{8})</td> <td></td> </tr> </tbody> </table>	Kind	Value	Annotation	pattern	(IRD-GE-[0-9]{8})	
Kind	Value	Annotation					
pattern	(IRD-GE-[0-9]{8})						
annotation	documentation Facette zur Festlegung der Gesundheitseinrichtung-ID						
source	<pre><simpleType name="IdEinrichtung"> <annotation> <documentation>Facette zur Festlegung der Gesundheitseinrichtung-ID</documentation> </annotation> <restriction base="xs:token"> <pattern value="(IRD-GE-[0-9]{8})"/> </restriction> </simpleType></pre>						

simpleType IrdArtikelId

namespace	http://xml.ir-d.de/stn						
type	restriction of token						
properties	base xs:token						
facets	<table border="1"> <thead> <tr> <th>Kind</th> <th>Value</th> <th>Annotation</th> </tr> </thead> <tbody> <tr> <td>maxLength</td> <td>16</td> <td></td> </tr> </tbody> </table>	Kind	Value	Annotation	maxLength	16	
Kind	Value	Annotation					
maxLength	16						
annotation	documentation Facette zur Festlegung der IrdNummer						
source	<pre><simpleType name="IrdArtikelId"> <annotation> <documentation>Facette zur Festlegung der IrdNummer</documentation> </annotation> <restriction base="xs:token"> <maxLength value="16"/> </restriction> </simpleType></pre>						

simpleType IrdSpezVersion

namespace	http://xml.ir-d.de/stn						
type	restriction of token						
properties	base xs:token						
facets	<table border="1"> <thead> <tr> <th>Kind</th> <th>Value</th> <th>Annotation</th> </tr> </thead> <tbody> <tr> <td>pattern</td> <td>(([1-9][1-9][0-9])\.\d{1}[1-9][0-9]\.\d{1}[1-9][0-9])</td> <td></td> </tr> </tbody> </table>	Kind	Value	Annotation	pattern	(([1-9][1-9][0-9])\.\d{1}[1-9][0-9]\.\d{1}[1-9][0-9])	
Kind	Value	Annotation					
pattern	(([1-9][1-9][0-9])\.\d{1}[1-9][0-9]\.\d{1}[1-9][0-9])						
annotation	documentation Facette zur Festlegung der Version der IRD-Spezifikation						

source	<pre> <simpleType name="IrdSpezVersion"> <annotation> <documentation>Facette zur Festlegung der Version der IRD-Spezifikation</documentation> </annotation> <restriction base="xs:token"> <pattern value="(([1-9] [1-9][0-9])\.\(\d [1-9][0-9])\.\(\d [1-9][0-9]))"/> </restriction> </simpleType> </pre>
--------	---

simpleType JaLeer

namespace	http://xml.ir-d.de/stn						
type	restriction of integer						
properties	base xs:integer						
facets	<table border="1"> <thead> <tr> <th>Kind</th> <th>Value</th> <th>Annotation</th> </tr> </thead> <tbody> <tr> <td>pattern</td> <td>(1)</td> <td></td> </tr> </tbody> </table>	Kind	Value	Annotation	pattern	(1)	
Kind	Value	Annotation					
pattern	(1)						
annotation	documentation Facette zur Festlegung des Unbekannt-Wertes (Bedeutung 1=true)						
source	<pre> <simpleType name="JaLeer"> <annotation> <documentation>Facette zur Festlegung des Unbekannt-Wertes (Bedeutung 1=true)</documentation> </annotation> <restriction base="xs:integer"> <pattern value="(1)"/> </restriction> </simpleType> </pre>						

simpleType Meldebestaetigung

namespace	http://xml.ir-d.de/stn						
type	restriction of token						
properties	base xs:token						
facets	<table border="1"> <thead> <tr> <th>Kind</th> <th>Value</th> <th>Annotation</th> </tr> </thead> <tbody> <tr> <td>length</td> <td>10</td> <td></td> </tr> </tbody> </table>	Kind	Value	Annotation	length	10	
Kind	Value	Annotation					
length	10						
annotation	documentation Facette zur Festlegung der Meldebestätigungslaenge von 10 Zeichen						
source	<pre> <simpleType name="Meldebestaetigung"> <annotation> <documentation>Facette zur Festlegung der Meldebestätigungslaenge von 10 Zeichen</documentation> </annotation> <restriction base="xs:token"> <length value="10"/> </restriction> </simpleType> </pre>						

simpleType OPS

namespac	http://xml.ir-d.de/stn
----------	------------------------

e							
type	restriction of token						
properties	base xs:token						
facets	<table border="1"> <thead> <tr> <th>Kind</th> <th>Value</th> <th>Annotation</th> </tr> </thead> <tbody> <tr> <td>pattern</td> <td>(([135689]\-([0-9]){2}([a-zA-Z0-9]){1}\.([a-zA-Z0-9]{1,2}))*(:[RLBr1b])?)</td> <td></td> </tr> </tbody> </table>	Kind	Value	Annotation	pattern	(([135689]\-([0-9]){2}([a-zA-Z0-9]){1}\.([a-zA-Z0-9]{1,2}))*(:[RLBr1b])?)	
Kind	Value	Annotation					
pattern	(([135689]\-([0-9]){2}([a-zA-Z0-9]){1}\.([a-zA-Z0-9]{1,2}))*(:[RLBr1b])?)						
annotation	documentation Facette zur Festlegung des Prozedurenschlüssels						
source	<pre><simpleType name="OPS"> <annotation> <documentation>Facette zur Festlegung des Prozedurenschlüssels</documentation> </annotation> <restriction base="xs:token"> <pattern value="([135689]\-([0-9]){2}([a-zA-Z0-9]){1}\.([a-zA-Z0-9]{1,2}))*(:[RLBr1b] ?)" /> </restriction> </simpleType></pre>						

simpleType **String2**

namespace	http://xml.ir-d.de/stn						
type	restriction of token						
properties	base xs:token						
facets	<table border="1"> <thead> <tr> <th>Kind</th> <th>Value</th> <th>Annotation</th> </tr> </thead> <tbody> <tr> <td>pattern</td> <td>([0-9]{2})</td> <td></td> </tr> </tbody> </table>	Kind	Value	Annotation	pattern	([0-9]{2})	
Kind	Value	Annotation					
pattern	([0-9]{2})						
annotation	documentation Facette zur Festlegung des kodierten Entlassungsgrundes						
source	<pre><simpleType name="String2"> <annotation> <documentation>Facette zur Festlegung des kodierten Entlassungsgrundes</documentation> </annotation> <restriction base="xs:token"> <pattern value="([0-9]{2})" /> </restriction> </simpleType></pre>						

simpleType **String20**

namespace	http://xml.ir-d.de/stn						
type	restriction of token						
properties	base xs:token						
facets	<table border="1"> <thead> <tr> <th>Kind</th> <th>Value</th> <th>Annotation</th> </tr> </thead> <tbody> <tr> <td>maxLength</td> <td>20</td> <td></td> </tr> </tbody> </table>	Kind	Value	Annotation	maxLength	20	
Kind	Value	Annotation					
maxLength	20						
annotation	documentation Facette zur Festlegung von: Artikel-, Ident-, Serien-, Lot-Nummer des Produkts						
source	<pre><simpleType name="String20"> <annotation> <documentation>Facette zur Festlegung von: Artikel-, Ident-, Serien-,</pre>						

	<pre> Lot-Nummer des Produkts</documentation> </annotation> <restriction base="xs:token"> <maxLength value="20"/> </restriction> </simpleType> </pre>
--	---

simpleType Sw

namespace	http://xml.ir-d.de/stn						
type	restriction of token						
properties	base xs:token						
facets	<table border="1"> <thead> <tr> <th>Kind</th> <th>Value</th> <th>Annotation</th> </tr> </thead> <tbody> <tr> <td>maxLength</td> <td>120</td> <td></td> </tr> </tbody> </table>	Kind	Value	Annotation	maxLength	120	
Kind	Value	Annotation					
maxLength	120						
annotation	documentation Facette für Merkmale der externen Software						
source	<pre> <simpleType name="Sw"> <annotation> <documentation>Facette für Merkmale der externen Software</documentation> </annotation> <restriction base="xs:token"> <maxLength value="120"/> </restriction> </simpleType> </pre>						

simpleType Transfervummer

namespace	http://xml.ir-d.de/stn						
type	restriction of token						
properties	base xs:token						
used by	element StornoFallBasis/FAL Transfervummer						
facets	<table border="1"> <thead> <tr> <th>Kind</th> <th>Value</th> <th>Annotation</th> </tr> </thead> <tbody> <tr> <td>pattern</td> <td>([a-z0-9]{64})</td> <td></td> </tr> </tbody> </table>	Kind	Value	Annotation	pattern	([a-z0-9]{64})	
Kind	Value	Annotation					
pattern	([a-z0-9]{64})						
annotation	documentation Facette zur Festlegung der Transfervummer						
source	<pre> <simpleType name="Transfervummer"> <annotation> <documentation>Facette zur Festlegung der Transfervummer</documentation> </annotation> <restriction base="xs:token"> <pattern value="([a-z0-9]{64})"/> </restriction> </simpleType> </pre>						

simpleType Versionsnummer

namespace	http://xml.ir-d.de/stn
type	restriction of token
properties	base xs:token

facets	<table border="1"> <thead> <tr> <th>Kind</th> <th>Value</th> <th>Annotation</th> </tr> </thead> <tbody> <tr> <td>maxLength</td> <td>10</td> <td></td> </tr> </tbody> </table>	Kind	Value	Annotation	maxLength	10	
Kind	Value	Annotation					
maxLength	10						
annotation	documentation Facette zur Festlegung der Versionsnummer des gelieferten Datensatzes						
source	<pre><simpleType name="Versionsnummer"> <annotation> <documentation>Facette zur Festlegung der Versionsnummer des gelieferten Datensatzes</documentation> </annotation> <restriction base="xs:token"> <maxLength value="10"/> </restriction> </simpleType></pre>						

simpleType Zahl1

namespace	http://xml.ir-d.de/stn									
type	restriction of positivInteger									
properties	base xs:positivInteger									
facets	<table border="1"> <thead> <tr> <th>Kind</th> <th>Value</th> <th>Annotation</th> </tr> </thead> <tbody> <tr> <td>minInclusive</td> <td>1</td> <td></td> </tr> <tr> <td>maxInclusive</td> <td>9</td> <td></td> </tr> </tbody> </table>	Kind	Value	Annotation	minInclusive	1		maxInclusive	9	
Kind	Value	Annotation								
minInclusive	1									
maxInclusive	9									
annotation	documentation Facette zur Festlegung der 1-stelligen Ganzzahlenwerte									
source	<pre><simpleType name="Zahl1"> <annotation> <documentation>Facette zur Festlegung der 1-stelligen Ganzzahlenwerte</documentation> </annotation> <restriction base="xs:positiveInteger"> <minInclusive value="1"/> <maxInclusive value="9"/> </restriction> </simpleType></pre>									

simpleType Zahl1_1

namespace	http://xml.ir-d.de/stn															
type	restriction of decimal															
properties	base xs:decimal															
facets	<table border="1"> <thead> <tr> <th>Kind</th> <th>Value</th> <th>Annotation</th> </tr> </thead> <tbody> <tr> <td>minExclusive</td> <td>0</td> <td></td> </tr> <tr> <td>maxExclusive</td> <td>10</td> <td></td> </tr> <tr> <td>totalDigits</td> <td>1</td> <td></td> </tr> <tr> <td>fractionDigits</td> <td>1</td> <td></td> </tr> </tbody> </table>	Kind	Value	Annotation	minExclusive	0		maxExclusive	10		totalDigits	1		fractionDigits	1	
Kind	Value	Annotation														
minExclusive	0															
maxExclusive	10															
totalDigits	1															
fractionDigits	1															
annotation	documentation Facette zur Festlegung des Formats [N].[N]															
source	<pre><simpleType name="Zahl1_1"> <annotation> <documentation>Facette zur Festlegung des Formats [N].[N]</documentation> </annotation> <restriction base="xs:decimal"></pre>															

	<pre> <totalDigits value="1"/> <fractionDigits value="1"/> <minExclusive value="0"/> <maxExclusive value="10"/> </restriction> </simpleType> </pre>
--	---

simpleType **Zahl2**

namespace	http://xml.ir-d.de/stn									
type	restriction of positiveInteger									
properties	base xs:positiveInteger									
facets	<table border="1"> <thead> <tr> <th>Kind</th> <th>Value</th> <th>Annotation</th> </tr> </thead> <tbody> <tr> <td>minInclusive</td> <td>1</td> <td></td> </tr> <tr> <td>maxInclusive</td> <td>99</td> <td></td> </tr> </tbody> </table>	Kind	Value	Annotation	minInclusive	1		maxInclusive	99	
Kind	Value	Annotation								
minInclusive	1									
maxInclusive	99									
annotation	documentation Facette zur Festlegung der 2-stelligen Ganzzahlenwerte									
source	<pre> <simpleType name="Zahl2"> <annotation> <documentation>Facette zur Festlegung der 2-stelligen Ganzzahlenwerte</documentation> </annotation> <restriction base="xs:positiveInteger"> <minInclusive value="1"/> <maxInclusive value="99"/> </restriction> </simpleType> </pre>									

simpleType **Zahl2_1**

namespace	http://xml.ir-d.de/stn															
type	restriction of decimal															
properties	base xs:decimal															
facets	<table border="1"> <thead> <tr> <th>Kind</th> <th>Value</th> <th>Annotation</th> </tr> </thead> <tbody> <tr> <td>minExclusive</td> <td>0</td> <td></td> </tr> <tr> <td>maxExclusive</td> <td>100</td> <td></td> </tr> <tr> <td>totalDigits</td> <td>2</td> <td></td> </tr> <tr> <td>fractionDigits</td> <td>1</td> <td></td> </tr> </tbody> </table>	Kind	Value	Annotation	minExclusive	0		maxExclusive	100		totalDigits	2		fractionDigits	1	
Kind	Value	Annotation														
minExclusive	0															
maxExclusive	100															
totalDigits	2															
fractionDigits	1															
annotation	documentation Facette zur Festlegung des Formats [NN].[N]															
source	<pre> <simpleType name="Zahl2_1"> <annotation> <documentation>Facette zur Festlegung des Formats [NN].[N]</documentation> </annotation> <restriction base="xs:decimal"> <totalDigits value="2"/> <fractionDigits value="1"/> <minExclusive value="0"/> <maxExclusive value="100"/> </restriction> </simpleType> </pre>															

simpleType Zahl3

namespace	http://xml.ir-d.de/stn									
type	restriction of positiveInteger									
properties	base xs:positiveInteger									
facets	<table><thead><tr><th>Kind</th><th>Value</th><th>Annotation</th></tr></thead><tbody><tr><td>minInclusive</td><td>1</td><td></td></tr><tr><td>maxInclusive</td><td>999</td><td></td></tr></tbody></table>	Kind	Value	Annotation	minInclusive	1		maxInclusive	999	
Kind	Value	Annotation								
minInclusive	1									
maxInclusive	999									
annotation	documentation Facette zur Festlegung der 3-stelligen Ganzzahlenwerte									
source	<pre><simpleType name="Zahl3"> <annotation> <documentation>Facette zur Festlegung der 3-stelligen Ganzzahlenwerte</documentation> </annotation> <restriction base="xs:positiveInteger"> <minInclusive value="1"/> <maxInclusive value="999"/> </restriction> </simpleType></pre>									

simpleType Zahl3_1

namespace	http://xml.ir-d.de/stn															
type	restriction of decimal															
properties	base xs:decimal															
facets	<table><thead><tr><th>Kind</th><th>Value</th><th>Annotation</th></tr></thead><tbody><tr><td>minExclusive</td><td>0</td><td></td></tr><tr><td>maxExclusive</td><td>1000</td><td></td></tr><tr><td>totalDigits</td><td>3</td><td></td></tr><tr><td>fractionDigits</td><td>1</td><td></td></tr></tbody></table>	Kind	Value	Annotation	minExclusive	0		maxExclusive	1000		totalDigits	3		fractionDigits	1	
Kind	Value	Annotation														
minExclusive	0															
maxExclusive	1000															
totalDigits	3															
fractionDigits	1															
annotation	documentation Facette zur Festlegung des Formats [NNN].[N]															
source	<pre><simpleType name="Zahl3_1"> <annotation> <documentation>Facette zur Festlegung des Formats [NNN].[N]</documentation> </annotation> <restriction base="xs:decimal"> <totalDigits value="3"/> <fractionDigits value="1"/> <minExclusive value="0"/> <maxExclusive value="1000"/> </restriction> </simpleType></pre>															

simpleType Zahl4

namespace	http://xml.ir-d.de/stn
type	restriction of positiveInteger
properties	base xs:positiveInteger

facets	<table border="1"> <thead> <tr> <th>Kind</th> <th>Value</th> <th>Annotation</th> </tr> </thead> <tbody> <tr> <td>minInclusive</td> <td>1</td> <td></td> </tr> <tr> <td>maxInclusive</td> <td>9999</td> <td></td> </tr> </tbody> </table>	Kind	Value	Annotation	minInclusive	1		maxInclusive	9999	
Kind	Value	Annotation								
minInclusive	1									
maxInclusive	9999									
annotation	documentation Facette zur Festlegung der 4-stelligen Ganzzahlenwerte									
source	<pre><simpleType name="Zahl4"> <annotation> <documentation>Facette zur Festlegung der 4-stelligen Ganzzahlenwerte</documentation> </annotation> <restriction base="xs:positiveInteger"> <minInclusive value="1"/> <maxInclusive value="9999"/> </restriction> </simpleType></pre>									

simpleType **Zahl5**

namespace	http://xml.ir-d.de/stn									
type	restriction of positiveInteger									
properties	base xs:positiveInteger									
facets	<table border="1"> <thead> <tr> <th>Kind</th> <th>Value</th> <th>Annotation</th> </tr> </thead> <tbody> <tr> <td>minInclusive</td> <td>1</td> <td></td> </tr> <tr> <td>maxInclusive</td> <td>99999</td> <td></td> </tr> </tbody> </table>	Kind	Value	Annotation	minInclusive	1		maxInclusive	99999	
Kind	Value	Annotation								
minInclusive	1									
maxInclusive	99999									
annotation	documentation Facette zur Festlegung der 5-stelligen Ganzzahlenwerte									
source	<pre><simpleType name="Zahl5"> <annotation> <documentation>Facette zur Festlegung der 5-stelligen Ganzzahlenwerte</documentation> </annotation> <restriction base="xs:positiveInteger"> <minInclusive value="1"/> <maxInclusive value="99999"/> </restriction> </simpleType></pre>									

complexType **MeldungIrdBasis**

diagram	
namespace	http://xml.ir-d.de/stn
children	MEL_IrdIdGesundheitseinrichtung
used by	complexType Storno
source	<pre><complexType name="MeldungIrdBasis"> <sequence> <element name="MEL_IrdIdGesundheitseinrichtung" type="IdEinrichtung"/> </sequence> </complexType></pre>

element **MeldungIrdBasis/MEL_IrdIdGesundheitseinrichtung**

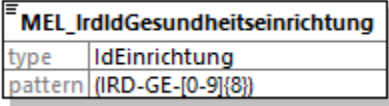
diagram							
type	IdEinrichtung						
properties	content simple						
facets	<table border="1"> <thead> <tr> <th>Kind</th> <th>Value</th> <th>Annotation</th> </tr> </thead> <tbody> <tr> <td>pattern</td> <td>(IRD-GE-[0-9]{8})</td> <td></td> </tr> </tbody> </table>	Kind	Value	Annotation	pattern	(IRD-GE-[0-9]{8})	
Kind	Value	Annotation					
pattern	(IRD-GE-[0-9]{8})						
source	<code><element name="MEL_IrdIdGesundheitseinrichtung" type="IdEinrichtung"/></code>						

complexType **StornoFallBasis**

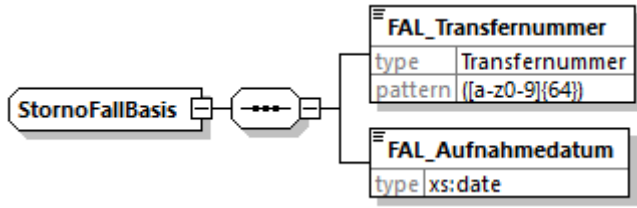
diagram	
namespace	http://xml.ir-d.de/stn
children	FAL_Transfernummer FAL_Aufnahmedatum
used by	element Storno/fall
source	<pre> <complexType name="StornoFallBasis"> <sequence> <element name="FAL_Transfernummer" type="Transfernummer"/> <element name="FAL_Aufnahmedatum" type="xs:date"/> </sequence> </complexType> </pre>

element **StornoFallBasis/FAL_Transfernummer**

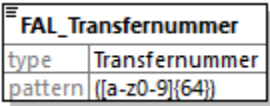
diagram							
type	Transfernummer						
properties	content simple						
facets	<table border="1"> <thead> <tr> <th>Kind</th> <th>Value</th> <th>Annotation</th> </tr> </thead> <tbody> <tr> <td>pattern</td> <td>([a-z0-9]{64})</td> <td></td> </tr> </tbody> </table>	Kind	Value	Annotation	pattern	([a-z0-9]{64})	
Kind	Value	Annotation					
pattern	([a-z0-9]{64})						
source	<code><element name="FAL_Transfernummer" type="Transfernummer"/></code>						

element **StornoFallBasis/FAL_Aufnahmedatum**

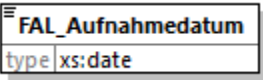
diagram	
type	date
properties	content simple
source	<code><element name="FAL_Aufnahmedatum" type="xs:date"/></code>

simpleType **DatumText**

namespace	http://xml.ir-d.de/irdma						
type	restriction of token						
properties	base xs:token						
facets	<table border="1"> <thead> <tr> <th>Kind</th> <th>Value</th> <th>Annotation</th> </tr> </thead> <tbody> <tr> <td>pattern</td> <td>(([0-9]{4})([0-9]{2})?([0-9]{2})?)</td> <td></td> </tr> </tbody> </table>	Kind	Value	Annotation	pattern	(([0-9]{4})([0-9]{2})?([0-9]{2})?)	
Kind	Value	Annotation					
pattern	(([0-9]{4})([0-9]{2})?([0-9]{2})?)						
annotation	documentation Facette zur Festlegung des freien Datumformats: JJJJ[-MM[-TT]]						
source	<pre><simpleType name="DatumText"> <annotation> <documentation>Facette zur Festlegung des freien Datumformats: JJJJ[-MM[-TT]]</documentation> </annotation> <restriction base="xs:token"> <pattern value="((([0-9]{4})([0-9]{2})?([0-9]{2})?)"/> </restriction> </simpleType></pre>						

simpleType **Freitext250**

namespace	http://xml.ir-d.de/irdma						
type	restriction of token						
properties	base xs:token						
used by	elements BestaetigungBasis/BEG AusloesendeOpsListe EmpfangsbestaetigungBasis/EBG Empfangsbestaetigung						
facets	<table border="1"> <thead> <tr> <th>Kind</th> <th>Value</th> <th>Annotation</th> </tr> </thead> <tbody> <tr> <td>maxLength</td> <td>250</td> <td></td> </tr> </tbody> </table>	Kind	Value	Annotation	maxLength	250	
Kind	Value	Annotation					
maxLength	250						
annotation	documentation Facette zur Festlegung des Freitextes von 250 Zeichen						
source	<pre><simpleType name="Freitext250"> <annotation> <documentation>Facette zur Festlegung des Freitextes von 250 Zeichen</documentation> </annotation> <restriction base="xs:token"> <maxLength value="250"/> </restriction> </simpleType></pre>						

simpleType **Freitext500**

namespace	http://xml.ir-d.de/irdma
type	restriction of token
properties	base xs:token
used by	elements HinweisBasis/HNW Datenelement HinweisBasis/HNW Meldung HinweisBasis/HNW Wert
facets	Kind Value Annotation maxLength 500
annotation	documentation Facette zur Festlegung des Freitextes von 500 Zeichen
source	<pre> <simpleType name="Freitext500"> <annotation> <documentation>Facette zur Festlegung des Freitextes von 500 Zeichen</documentation> </annotation> <restriction base="xs:token"> <maxLength value="500"/> </restriction> </simpleType> </pre>

simpleType **HashString**

namespace	http://xml.ir-d.de/irdma
type	restriction of token
properties	base xs:token
used by	element BestaetigungBasis/BEG Hash String
facets	Kind Value Annotation maxLength 512
annotation	documentation Facette zur Festlegung des Hash-Strings der Meldebestätigung
source	<pre> <simpleType name="HashString"> <annotation> <documentation>Facette zur Festlegung des Hash-Strings der Meldebestätigung</documentation> </annotation> <restriction base="xs:token"> <maxLength value="512"/> </restriction> </simpleType> </pre>

simpleType **HashWert**

namespace	http://xml.ir-d.de/irdma
type	restriction of token
properties	base xs:token
used by	element BestaetigungBasis/BEG Hash Wert
facets	Kind Value Annotation length 64
annotation	documentation Facette zur Festlegung des Hashwertes der Meldebestätigung

source	<pre> <simpleType name="HashWert"> <annotation> <documentation>Facette zur Festlegung des Hashwertes der Meldebestätigung</documentation> </annotation> <restriction base="xs:token"> <length value="64"/> </restriction> </simpleType> </pre>
--------	--

simpleType ICD

namespace	http://xml.ir-d.de/irdma						
type	restriction of token						
properties	base xs:token						
facets	<table border="1"> <thead> <tr> <th>Kind</th> <th>Value</th> <th>Annotation</th> </tr> </thead> <tbody> <tr> <td>pattern</td> <td>([a-zA-Z][0-9]{2}(\.[0-9]{1,2})?(:[RLB])?)</td> <td></td> </tr> </tbody> </table>	Kind	Value	Annotation	pattern	([a-zA-Z][0-9]{2}(\.[0-9]{1,2})?(:[RLB])?)	
Kind	Value	Annotation					
pattern	([a-zA-Z][0-9]{2}(\.[0-9]{1,2})?(:[RLB])?)						
annotation	documentation Facette zur Festlegung des ICD Code						
source	<pre> <simpleType name="ICD"> <annotation> <documentation>Facette zur Festlegung des ICD Code</documentation> </annotation> <restriction base="xs:token"> <pattern value="([a-zA-Z][0-9]{2}(\.[0-9]{1,2})?(:[RLB])?)"/> </restriction> </simpleType> </pre>						

simpleType IdEinrichtung

namespace	http://xml.ir-d.de/irdma						
type	restriction of token						
properties	base xs:token						
used by	element MeldungIrdBasis/MEL_IrdIdGesundheitseinrichtung						
facets	<table border="1"> <thead> <tr> <th>Kind</th> <th>Value</th> <th>Annotation</th> </tr> </thead> <tbody> <tr> <td>pattern</td> <td>(IRD-GE-[0-9]{8})</td> <td></td> </tr> </tbody> </table>	Kind	Value	Annotation	pattern	(IRD-GE-[0-9]{8})	
Kind	Value	Annotation					
pattern	(IRD-GE-[0-9]{8})						
annotation	documentation Facette zur Festlegung der Gesundheitseinrichtung-ID						
source	<pre> <simpleType name="IdEinrichtung"> <annotation> <documentation>Facette zur Festlegung der Gesundheitseinrichtung-ID</documentation> </annotation> <restriction base="xs:token"> <pattern value="(IRD-GE-[0-9]{8})"/> </restriction> </simpleType> </pre>						

simpleType IrdArtikellD

namespace	http://xml.ir-d.de/irdma
-----------	--------------------------

type	restriction of token						
properties	base xs:token						
facets	<table border="1"> <thead> <tr> <th>Kind</th> <th>Value</th> <th>Annotation</th> </tr> </thead> <tbody> <tr> <td>maxLength</td> <td>16</td> <td></td> </tr> </tbody> </table>	Kind	Value	Annotation	maxLength	16	
Kind	Value	Annotation					
maxLength	16						
annotation	documentation Facette zur Festlegung der IrdNummer						
source	<pre><simpleType name="IrdArtikelId"> <annotation> <documentation>Facette zur Festlegung der IrdNummer</documentation> </annotation> <restriction base="xs:token"> <maxLength value="16"/> </restriction> </simpleType></pre>						

simpleType IrdSpezVersion

namespace	http://xml.ir-d.de/irdma						
type	restriction of token						
properties	base xs:token						
facets	<table border="1"> <thead> <tr> <th>Kind</th> <th>Value</th> <th>Annotation</th> </tr> </thead> <tbody> <tr> <td>pattern</td> <td>((([1-9] [1-9][0-9])\.\d{1}[0-9])\.\d{1}[0-9])</td> <td></td> </tr> </tbody> </table>	Kind	Value	Annotation	pattern	((([1-9] [1-9][0-9])\.\d{1}[0-9])\.\d{1}[0-9])	
Kind	Value	Annotation					
pattern	((([1-9] [1-9][0-9])\.\d{1}[0-9])\.\d{1}[0-9])						
annotation	documentation Facette zur Festlegung der Version der IRD-Spezifikation						
source	<pre><simpleType name="IrdSpezVersion"> <annotation> <documentation>Facette zur Festlegung der Version der IRD-Spezifikation</documentation> </annotation> <restriction base="xs:token"> <pattern value="((([1-9] [1-9][0-9])\.\d{1}[0-9])\.\d{1}[0-9])"/> </restriction> </simpleType></pre>						

simpleType JaLeer

namespace	http://xml.ir-d.de/irdma						
type	restriction of integer						
properties	base xs:integer						
facets	<table border="1"> <thead> <tr> <th>Kind</th> <th>Value</th> <th>Annotation</th> </tr> </thead> <tbody> <tr> <td>pattern</td> <td>(1)</td> <td></td> </tr> </tbody> </table>	Kind	Value	Annotation	pattern	(1)	
Kind	Value	Annotation					
pattern	(1)						
annotation	documentation Facette zur Festlegung des Unbekannt-Wertes (Bedeutung 1=true)						
source	<pre><simpleType name="JaLeer"> <annotation> <documentation>Facette zur Festlegung des Unbekannt-Wertes (Bedeutung 1=true)</documentation> </annotation> <restriction base="xs:integer"> <pattern value="(1)"/> </restriction> </simpleType></pre>						

	<code></simpleType></code>
--	----------------------------------

simpleType **Meldebestaetigung**

namespace	http://xml.ir-d.de/irdma						
type	restriction of token						
properties	base xs:token						
used by	element BestaetigungBasis/BEG Meldebestaetigung ID						
facets	<table border="1"> <thead> <tr> <th>Kind</th> <th>Value</th> <th>Annotation</th> </tr> </thead> <tbody> <tr> <td>length</td> <td>10</td> <td></td> </tr> </tbody> </table>	Kind	Value	Annotation	length	10	
Kind	Value	Annotation					
length	10						
annotation	documentation Facette zur Festlegung der Meldebestätigungslaenge von 10 Zeichen						
source	<pre><simpleType name="Meldebestaetigung"> <annotation> <documentation>Facette zur Festlegung der Meldebestätigungslaenge von 10 Zeichen</documentation> </annotation> <restriction base="xs:token"> <length value="10"/> </restriction> </simpleType></pre>						

simpleType **OPS**

namespace	http://xml.ir-d.de/irdma						
type	restriction of token						
properties	base xs:token						
facets	<table border="1"> <thead> <tr> <th>Kind</th> <th>Value</th> <th>Annotation</th> </tr> </thead> <tbody> <tr> <td>pattern</td> <td>(([135689]\-([0-9]){2}([a-zA-Z0-9]){1}\.([a-zA-Z0-9]{1,2}))*(:[RLBr1b])?)</td> <td></td> </tr> </tbody> </table>	Kind	Value	Annotation	pattern	(([135689]\-([0-9]){2}([a-zA-Z0-9]){1}\.([a-zA-Z0-9]{1,2}))*(:[RLBr1b])?)	
Kind	Value	Annotation					
pattern	(([135689]\-([0-9]){2}([a-zA-Z0-9]){1}\.([a-zA-Z0-9]{1,2}))*(:[RLBr1b])?)						
annotation	documentation Facette zur Festlegung des Prozedurenschlüssels						
source	<pre><simpleType name="OPS"> <annotation> <documentation>Facette zur Festlegung des Prozedurenschlüssels</documentation> </annotation> <restriction base="xs:token"> <pattern value="([135689]\-([0-9]){2}([a-zA-Z0-9]){1}\.([a-zA-Z0-9]{1,2}))*(:[RLBr1b] ?)"/> </restriction> </simpleType></pre>						

simpleType **String2**

namespace	http://xml.ir-d.de/irdma
type	restriction of token
properties	base xs:token

facets	Kind Value Annotation pattern ([0-9]{2})
annotation	documentation Facette zur Festlegung des kodierten Entlassungsgrundes
source	<pre> <simpleType name="String2"> <annotation> <documentation>Facette zur Festlegung des kodierten Entlassungsgrundes</documentation> </annotation> <restriction base="xs:token"> <pattern value="([0-9]{2})"/> </restriction> </simpleType> </pre>

simpleType String20

namespace	http://xml.ir-d.de/irdma
type	restriction of token
properties	base xs:token
facets	Kind Value Annotation maxLength 20
annotation	documentation Facette zur Festlegung von: Artikel-, Ident-, Serien-, Lot-Nummer des Produkts
source	<pre> <simpleType name="String20"> <annotation> <documentation>Facette zur Festlegung von: Artikel-, Ident-, Serien-, Lot-Nummer des Produkts</documentation> </annotation> <restriction base="xs:token"> <maxLength value="20"/> </restriction> </simpleType> </pre>

simpleType Sw

namespace	http://xml.ir-d.de/irdma
type	restriction of token
properties	base xs:token
facets	Kind Value Annotation maxLength 120
annotation	documentation Facette für Merkmale der externen Software
source	<pre> <simpleType name="Sw"> <annotation> <documentation>Facette für Merkmale der externen Software</documentation> </annotation> <restriction base="xs:token"> <maxLength value="120"/> </restriction> </simpleType> </pre>

simpleType **Transfervummer**

namespace	http://xml.ir-d.de/irdma
type	restriction of token
properties	base xs:token
used by	element MeldungIrdFallBasis/FAL Transfervummer
facets	Kind Value Annotation pattern ([a-z0-9]{64})
annotation	documentation Facette zur Festlegung der Transfervummer
source	<pre><simpleType name="Transfervummer"> <annotation> <documentation>Facette zur Festlegung der Transfervummer</documentation> </annotation> <restriction base="xs:token"> <pattern value="([a-z0-9]{64})"/> </restriction> </simpleType></pre>

simpleType **Versionsnummer**

namespace	http://xml.ir-d.de/irdma
type	restriction of token
properties	base xs:token
facets	Kind Value Annotation maxLength 10
annotation	documentation Facette zur Festlegung der Versionsnummer des gelieferten Datensatzes
source	<pre><simpleType name="Versionsnummer"> <annotation> <documentation>Facette zur Festlegung der Versionsnummer des gelieferten Datensatzes</documentation> </annotation> <restriction base="xs:token"> <maxLength value="10"/> </restriction> </simpleType></pre>

simpleType **Zahl1**

namespace	http://xml.ir-d.de/irdma
type	restriction of positiveInteger
properties	base xs:positiveInteger
facets	Kind Value Annotation minInclusive 1 maxInclusive 9
annotation	documentation Facette zur Festlegung der 1-stelligen Ganzzahlenwerte
source	<pre><simpleType name="Zahl1"> <annotation> <documentation>Facette zur Festlegung der 1-stelligen</pre>

	<pre>Ganzzahlenwerte</documentation> </annotation> <restriction base="xs:positiveInteger"> <minInclusive value="1"/> <maxInclusive value="9"/> </restriction> </simpleType></pre>
--	---

simpleType **Zahl1_1**

namespace	http://xml.ir-d.de/irdma															
type	restriction of decimal															
properties	base xs:decimal															
facets	<table border="1"> <thead> <tr> <th>Kind</th> <th>Value</th> <th>Annotation</th> </tr> </thead> <tbody> <tr> <td>minExclusive</td> <td>0</td> <td></td> </tr> <tr> <td>maxExclusive</td> <td>10</td> <td></td> </tr> <tr> <td>totalDigits</td> <td>1</td> <td></td> </tr> <tr> <td>fractionDigits</td> <td>1</td> <td></td> </tr> </tbody> </table>	Kind	Value	Annotation	minExclusive	0		maxExclusive	10		totalDigits	1		fractionDigits	1	
Kind	Value	Annotation														
minExclusive	0															
maxExclusive	10															
totalDigits	1															
fractionDigits	1															
annotation	documentation Facette zur Festlegung des Formats [N].[N]															
source	<pre><simpleType name="Zahl1_1"> <annotation> <documentation>Facette zur Festlegung des Formats [N].[N]</documentation> </annotation> <restriction base="xs:decimal"> <totalDigits value="1"/> <fractionDigits value="1"/> <minExclusive value="0"/> <maxExclusive value="10"/> </restriction> </simpleType></pre>															

simpleType **Zahl2**

namespace	http://xml.ir-d.de/irdma									
type	restriction of positiveInteger									
properties	base xs:positiveInteger									
facets	<table border="1"> <thead> <tr> <th>Kind</th> <th>Value</th> <th>Annotation</th> </tr> </thead> <tbody> <tr> <td>minInclusive</td> <td>1</td> <td></td> </tr> <tr> <td>maxInclusive</td> <td>99</td> <td></td> </tr> </tbody> </table>	Kind	Value	Annotation	minInclusive	1		maxInclusive	99	
Kind	Value	Annotation								
minInclusive	1									
maxInclusive	99									
annotation	documentation Facette zur Festlegung der 2-stelligen Ganzzahlenwerte									
source	<pre><simpleType name="Zahl2"> <annotation> <documentation>Facette zur Festlegung der 2-stelligen Ganzzahlenwerte</documentation> </annotation> <restriction base="xs:positiveInteger"> <minInclusive value="1"/> <maxInclusive value="99"/> </restriction> </simpleType></pre>									

simpleType Zahl2_1

namespace	http://xml.ir-d.de/irdma															
type	restriction of decimal															
properties	base xs:decimal															
facets	<table border="1"> <thead> <tr> <th>Kind</th> <th>Value</th> <th>Annotation</th> </tr> </thead> <tbody> <tr> <td>minExclusive</td> <td>0</td> <td></td> </tr> <tr> <td>maxExclusive</td> <td>100</td> <td></td> </tr> <tr> <td>totalDigits</td> <td>2</td> <td></td> </tr> <tr> <td>fractionDigits</td> <td>1</td> <td></td> </tr> </tbody> </table>	Kind	Value	Annotation	minExclusive	0		maxExclusive	100		totalDigits	2		fractionDigits	1	
Kind	Value	Annotation														
minExclusive	0															
maxExclusive	100															
totalDigits	2															
fractionDigits	1															
annotation	documentation Facette zur Festlegung des Formats [NN].[N]															
source	<pre><simpleType name="Zahl2_1"> <annotation> <documentation>Facette zur Festlegung des Formats [NN].[N]</documentation> </annotation> <restriction base="xs:decimal"> <totalDigits value="2"/> <fractionDigits value="1"/> <minExclusive value="0"/> <maxExclusive value="100"/> </restriction> </simpleType></pre>															

simpleType Zahl3

namespace	http://xml.ir-d.de/irdma									
type	restriction of positiveInteger									
properties	base xs:positiveInteger									
facets	<table border="1"> <thead> <tr> <th>Kind</th> <th>Value</th> <th>Annotation</th> </tr> </thead> <tbody> <tr> <td>minInclusive</td> <td>1</td> <td></td> </tr> <tr> <td>maxInclusive</td> <td>999</td> <td></td> </tr> </tbody> </table>	Kind	Value	Annotation	minInclusive	1		maxInclusive	999	
Kind	Value	Annotation								
minInclusive	1									
maxInclusive	999									
annotation	documentation Facette zur Festlegung der 3-stelligen Ganzzahlenwerte									
source	<pre><simpleType name="Zahl3"> <annotation> <documentation>Facette zur Festlegung der 3-stelligen Ganzzahlenwerte</documentation> </annotation> <restriction base="xs:positiveInteger"> <minInclusive value="1"/> <maxInclusive value="999"/> </restriction> </simpleType></pre>									

simpleType Zahl3_1

namespace	http://xml.ir-d.de/irdma
type	restriction of decimal

properties	base xs:decimal															
facets	<table border="1"> <thead> <tr> <th>Kind</th> <th>Value</th> <th>Annotation</th> </tr> </thead> <tbody> <tr> <td>minExclusive</td> <td>0</td> <td></td> </tr> <tr> <td>maxExclusive</td> <td>1000</td> <td></td> </tr> <tr> <td>totalDigits</td> <td>3</td> <td></td> </tr> <tr> <td>fractionDigits</td> <td>1</td> <td></td> </tr> </tbody> </table>	Kind	Value	Annotation	minExclusive	0		maxExclusive	1000		totalDigits	3		fractionDigits	1	
Kind	Value	Annotation														
minExclusive	0															
maxExclusive	1000															
totalDigits	3															
fractionDigits	1															
annotation	documentation Facette zur Festlegung des Formats [NNN].[N]															
source	<pre><simpleType name="Zahl3_1"> <annotation> <documentation>Facette zur Festlegung des Formats [NNN].[N]</documentation> </annotation> <restriction base="xs:decimal"> <totalDigits value="3"/> <fractionDigits value="1"/> <minExclusive value="0"/> <maxExclusive value="1000"/> </restriction> </simpleType></pre>															

simpleType Zahl4

namespace	http://xml.ir-d.de/irdma									
type	restriction of positiveInteger									
properties	base xs:positiveInteger									
facets	<table border="1"> <thead> <tr> <th>Kind</th> <th>Value</th> <th>Annotation</th> </tr> </thead> <tbody> <tr> <td>minInclusive</td> <td>1</td> <td></td> </tr> <tr> <td>maxInclusive</td> <td>9999</td> <td></td> </tr> </tbody> </table>	Kind	Value	Annotation	minInclusive	1		maxInclusive	9999	
Kind	Value	Annotation								
minInclusive	1									
maxInclusive	9999									
annotation	documentation Facette zur Festlegung der 4-stelligen Ganzzahlenwerte									
source	<pre><simpleType name="Zahl4"> <annotation> <documentation>Facette zur Festlegung der 4-stelligen Ganzzahlenwerte</documentation> </annotation> <restriction base="xs:positiveInteger"> <minInclusive value="1"/> <maxInclusive value="9999"/> </restriction> </simpleType></pre>									

simpleType Zahl5

namespace	http://xml.ir-d.de/irdma									
type	restriction of positiveInteger									
properties	base xs:positiveInteger									
facets	<table border="1"> <thead> <tr> <th>Kind</th> <th>Value</th> <th>Annotation</th> </tr> </thead> <tbody> <tr> <td>minInclusive</td> <td>1</td> <td></td> </tr> <tr> <td>maxInclusive</td> <td>99999</td> <td></td> </tr> </tbody> </table>	Kind	Value	Annotation	minInclusive	1		maxInclusive	99999	
Kind	Value	Annotation								
minInclusive	1									
maxInclusive	99999									
annotation	documentation Facette zur Festlegung der 5-stelligen Ganzzahlenwerte									

source	<pre> <simpleType name="Zahl5"> <annotation> <documentation>Facette zur Festlegung der 5-stelligen Ganzzahlenwerte</documentation> </annotation> <restriction base="xs:positiveInteger"> <minInclusive value="1"/> <maxInclusive value="99999"/> </restriction> </simpleType> </pre>
--------	--

complexType MeldungIrdBasis

diagram	<pre> graph LR MeldungIrdBasis -- contains --> MEL_IrdIdGesundheitseinrichtung style MeldungIrdBasis fill:#fff,stroke:#333,stroke-width:1px style MEL_IrdIdGesundheitseinrichtung fill:#fff,stroke:#333,stroke-width:1px </pre>
namespace	http://xml.ir-d.de/irdma
children	MEL_IrdIdGesundheitseinrichtung
used by	complexType MeldungIrd
source	<pre> <complexType name="MeldungIrdBasis"> <sequence> <element name="MEL_IrdIdGesundheitseinrichtung" type="IdEinrichtung"/> </sequence> </complexType> </pre>

element MeldungIrdBasis/MEL_IrdIdGesundheitseinrichtung

diagram	<pre> graph LR MEL_IrdIdGesundheitseinrichtung style MEL_IrdIdGesundheitseinrichtung fill:#fff,stroke:#333,stroke-width:1px </pre>						
type	IdEinrichtung						
properties	content simple						
facets	<table border="1"> <thead> <tr> <th>Kind</th> <th>Value</th> <th>Annotation</th> </tr> </thead> <tbody> <tr> <td>pattern</td> <td>(IRD-GE-[0-9]{8})</td> <td></td> </tr> </tbody> </table>	Kind	Value	Annotation	pattern	(IRD-GE-[0-9]{8})	
Kind	Value	Annotation					
pattern	(IRD-GE-[0-9]{8})						
source	<pre><element name="MEL_IrdIdGesundheitseinrichtung" type="IdEinrichtung"/></pre>						

complexType MeldungIrdFallBasis

diagram	<pre> graph LR MeldungIrdFallBasis -- contains --> FAL_Transfernummer MeldungIrdFallBasis -- contains --> FAL_DatumZeitSatzErstellung style MeldungIrdFallBasis fill:#fff,stroke:#333,stroke-width:1px style FAL_Transfernummer fill:#fff,stroke:#333,stroke-width:1px style FAL_DatumZeitSatzErstellung fill:#fff,stroke:#333,stroke-width:1px </pre>
namespace	http://xml.ir-d.de/irdma
children	FAL_Transfernummer FAL_DatumZeitSatzErstellung

used by	element MeldungIrd/fal
source	<pre><complexType name="MeldungIrdFallBasis"> <sequence> <element name="FAL_Transfernummer" type="Transfernummer"/> <element name="FAL_DatumZeitSatzErstellung" type="xs:dateTime"/> </sequence> </complexType></pre>

element **MeldungIrdFallBasis/FAL_Transfernummer**

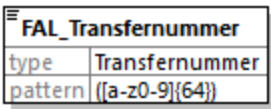
diagram							
type	Transfernummer						
properties	content simple						
facets	<table border="1"> <thead> <tr> <th>Kind</th> <th>Value</th> <th>Annotation</th> </tr> </thead> <tbody> <tr> <td>pattern</td> <td>([a-z0-9]{64})</td> <td></td> </tr> </tbody> </table>	Kind	Value	Annotation	pattern	([a-z0-9]{64})	
Kind	Value	Annotation					
pattern	([a-z0-9]{64})						
source	<pre><element name="FAL_Transfernummer" type="Transfernummer"/></pre>						

element **MeldungIrdFallBasis/FAL_DatumZeitSatzErstellung**

diagram	
type	dateTime
properties	content simple
source	<pre><element name="FAL_DatumZeitSatzErstellung" type="xs:dateTime"/></pre>

simpleType **DatumText**

namespace	http://xml.ir-d.de/irdsa						
type	restriction of token						
properties	base xs:token						
facets	<table border="1"> <thead> <tr> <th>Kind</th> <th>Value</th> <th>Annotation</th> </tr> </thead> <tbody> <tr> <td>pattern</td> <td>(([0-9]{4})([-][0-9]{2})?([-][0-9]{2})?)</td> <td></td> </tr> </tbody> </table>	Kind	Value	Annotation	pattern	(([0-9]{4})([-][0-9]{2})?([-][0-9]{2})?)	
Kind	Value	Annotation					
pattern	(([0-9]{4})([-][0-9]{2})?([-][0-9]{2})?)						
annotation	<p>documentation</p> <p>Facette zur Festlegung des freien Datumformats: JJJJ[-MM[-TT]]</p>						
source	<pre><simpleType name="DatumText"> <annotation> <documentation>Facette zur Festlegung des freien Datumformats: JJJJ[-MM[-TT]]</documentation> </annotation> <restriction base="xs:token"> <pattern value="(([0-9]{4})([-][0-9]{2})?([-][0-9]{2})?)"/> </restriction> </simpleType></pre>						

simpleType **Freitext250**

namespace	http://xml.ir-d.de/irdsa						
type	restriction of token						
properties	base xs:token						
used by	element EmpfangsbestaetigungBasis/EBG_Empfangsbestaetigung						
facets	<table border="1"> <thead> <tr> <th>Kind</th> <th>Value</th> <th>Annotation</th> </tr> </thead> <tbody> <tr> <td>maxLength</td> <td>250</td> <td></td> </tr> </tbody> </table>	Kind	Value	Annotation	maxLength	250	
Kind	Value	Annotation					
maxLength	250						
annotation	documentation Facette zur Festlegung des Freitextes von 250 Zeichen						
source	<pre><simpleType name="Freitext250"> <annotation> <documentation>Facette zur Festlegung des Freitextes von 250 Zeichen</documentation> </annotation> <restriction base="xs:token"> <maxLength value="250"/> </restriction> </simpleType></pre>						

simpleType **Freitext500**

namespace	http://xml.ir-d.de/irdsa						
type	restriction of token						
properties	base xs:token						
used by	elements HinweisBasis/HNW Datenelement HinweisBasis/HNW Meldung HinweisBasis/HNW Wert						
facets	<table border="1"> <thead> <tr> <th>Kind</th> <th>Value</th> <th>Annotation</th> </tr> </thead> <tbody> <tr> <td>maxLength</td> <td>500</td> <td></td> </tr> </tbody> </table>	Kind	Value	Annotation	maxLength	500	
Kind	Value	Annotation					
maxLength	500						
annotation	documentation Facette zur Festlegung des Freitextes von 500 Zeichen						
source	<pre><simpleType name="Freitext500"> <annotation> <documentation>Facette zur Festlegung des Freitextes von 500 Zeichen</documentation> </annotation> <restriction base="xs:token"> <maxLength value="500"/> </restriction> </simpleType></pre>						

simpleType **HashString**

namespace	http://xml.ir-d.de/irdsa						
type	restriction of token						
properties	base xs:token						
facets	<table border="1"> <thead> <tr> <th>Kind</th> <th>Value</th> <th>Annotation</th> </tr> </thead> <tbody> <tr> <td>maxLength</td> <td>512</td> <td></td> </tr> </tbody> </table>	Kind	Value	Annotation	maxLength	512	
Kind	Value	Annotation					
maxLength	512						
annotation	documentation Facette zur Festlegung des Hash-Strings der Meldebestätigung						

source	<pre> <simpleType name="HashString"> <annotation> <documentation>Facette zur Festlegung des Hash-Strings der Meldebestätigung</documentation> </annotation> <restriction base="xs:token"> <maxLength value="512"/> </restriction> </simpleType> </pre>
--------	--

simpleType HashWert

namespace	http://xml.ir-d.de/irdsa						
type	restriction of token						
properties	base xs:token						
facets	<table border="1"> <thead> <tr> <th>Kind</th> <th>Value</th> <th>Annotation</th> </tr> </thead> <tbody> <tr> <td>length</td> <td>64</td> <td></td> </tr> </tbody> </table>	Kind	Value	Annotation	length	64	
Kind	Value	Annotation					
length	64						
annotation	documentation Facette zur Festlegung des Hashwertes der Meldebestätigung						
source	<pre> <simpleType name="HashWert"> <annotation> <documentation>Facette zur Festlegung des Hashwertes der Meldebestätigung</documentation> </annotation> <restriction base="xs:token"> <length value="64"/> </restriction> </simpleType> </pre>						

simpleType ICD

namespace	http://xml.ir-d.de/irdsa						
type	restriction of token						
properties	base xs:token						
facets	<table border="1"> <thead> <tr> <th>Kind</th> <th>Value</th> <th>Annotation</th> </tr> </thead> <tbody> <tr> <td>pattern</td> <td>([a-zA-Z][0-9]{2}(\.[0-9]{1,2})?(:[RLB])?)</td> <td></td> </tr> </tbody> </table>	Kind	Value	Annotation	pattern	([a-zA-Z][0-9]{2}(\.[0-9]{1,2})?(:[RLB])?)	
Kind	Value	Annotation					
pattern	([a-zA-Z][0-9]{2}(\.[0-9]{1,2})?(:[RLB])?)						
annotation	documentation Facette zur Festlegung des ICD Code						
source	<pre> <simpleType name="ICD"> <annotation> <documentation>Facette zur Festlegung des ICD Code</documentation> </annotation> <restriction base="xs:token"> <pattern value="([a-zA-Z][0-9]{2}(\.[0-9]{1,2})?(:[RLB])?)"/> </restriction> </simpleType> </pre>						

simpleType IdEinrichtung

namespace	http://xml.ir-d.de/irdsa
type	restriction of token

properties	base xs:token						
used by	element MeldungIrdBasis/MEL_IrdIdGesundheitseinrichtung						
facets	<table border="1"> <thead> <tr> <th>Kind</th> <th>Value</th> <th>Annotation</th> </tr> </thead> <tbody> <tr> <td>pattern</td> <td>(IRD-GE-[0-9]{8})</td> <td></td> </tr> </tbody> </table>	Kind	Value	Annotation	pattern	(IRD-GE-[0-9]{8})	
Kind	Value	Annotation					
pattern	(IRD-GE-[0-9]{8})						
annotation	documentation Facette zur Festlegung der Gesundheitseinrichtung-ID						
source	<pre><simpleType name="IdEinrichtung"> <annotation> <documentation>Facette zur Festlegung der Gesundheitseinrichtung-ID</documentation> </annotation> <restriction base="xs:token"> <pattern value="(IRD-GE-[0-9]{8})"/> </restriction> </simpleType></pre>						

simpleType IrdArtikelId

namespace	http://xml.ir-d.de/irdsa						
type	restriction of token						
properties	base xs:token						
facets	<table border="1"> <thead> <tr> <th>Kind</th> <th>Value</th> <th>Annotation</th> </tr> </thead> <tbody> <tr> <td>maxLength</td> <td>16</td> <td></td> </tr> </tbody> </table>	Kind	Value	Annotation	maxLength	16	
Kind	Value	Annotation					
maxLength	16						
annotation	documentation Facette zur Festlegung der IrdNummer						
source	<pre><simpleType name="IrdArtikelId"> <annotation> <documentation>Facette zur Festlegung der IrdNummer</documentation> </annotation> <restriction base="xs:token"> <maxLength value="16"/> </restriction> </simpleType></pre>						

simpleType IrdSpezVersion

namespace	http://xml.ir-d.de/irdsa						
type	restriction of token						
properties	base xs:token						
facets	<table border="1"> <thead> <tr> <th>Kind</th> <th>Value</th> <th>Annotation</th> </tr> </thead> <tbody> <tr> <td>pattern</td> <td>(([1-9] [1-9][0-9])\.\d{1}[0-9])\.\d{1}[0-9])</td> <td></td> </tr> </tbody> </table>	Kind	Value	Annotation	pattern	(([1-9] [1-9][0-9])\.\d{1}[0-9])\.\d{1}[0-9])	
Kind	Value	Annotation					
pattern	(([1-9] [1-9][0-9])\.\d{1}[0-9])\.\d{1}[0-9])						
annotation	documentation Facette zur Festlegung der Version der IRD-Spezifikation						
source	<pre><simpleType name="IrdSpezVersion"> <annotation> <documentation>Facette zur Festlegung der Version der IRD-Spezifikation</documentation> </annotation> <restriction base="xs:token"> <pattern value="(([1-9] [1-9][0-9])\.\d{1}[0-9])\.\d{1}[0-9]"/> </restriction> </simpleType></pre>						

	<code></simpleType></code>
--	----------------------------------

simpleType **JaLeer**

namespace	http://xml.ir-d.de/irdsa						
type	restriction of integer						
properties	base xs:integer						
facets	<table border="1"> <tr> <td>Kind</td> <td>Value</td> <td>Annotation</td> </tr> <tr> <td>pattern</td> <td>(1)</td> <td></td> </tr> </table>	Kind	Value	Annotation	pattern	(1)	
Kind	Value	Annotation					
pattern	(1)						
annotation	documentation Facette zur Festlegung des Unbekannt-Wertes (Bedeutung 1=true)						
source	<pre><simpleType name="JaLeer"> <annotation> <documentation>Facette zur Festlegung des Unbekannt-Wertes (Bedeutung 1=true)</documentation> </annotation> <restriction base="xs:integer"> <pattern value="(1)"/> </restriction> </simpleType></pre>						

simpleType **Meldebestaetigung**

namespace	http://xml.ir-d.de/irdsa						
type	restriction of token						
properties	base xs:token						
facets	<table border="1"> <tr> <td>Kind</td> <td>Value</td> <td>Annotation</td> </tr> <tr> <td>length</td> <td>10</td> <td></td> </tr> </table>	Kind	Value	Annotation	length	10	
Kind	Value	Annotation					
length	10						
annotation	documentation Facette zur Festlegung der Meldebestätigungslaenge von 10 Zeichen						
source	<pre><simpleType name="Meldebestaetigung"> <annotation> <documentation>Facette zur Festlegung der Meldebestätigungslaenge von 10 Zeichen</documentation> </annotation> <restriction base="xs:token"> <length value="10"/> </restriction> </simpleType></pre>						

simpleType **OPS**

namespace	http://xml.ir-d.de/irdsa						
type	restriction of token						
properties	base xs:token						
facets	<table border="1"> <tr> <td>Kind</td> <td>Value</td> <td>Annotation</td> </tr> <tr> <td>pattern</td> <td>(([135689]\- [0-9]){2}([a-zA-Z0-9]){1}\.([a-zA-Z0-9]{1,2}))*(:[RLBrlb])?</td> <td></td> </tr> </table>	Kind	Value	Annotation	pattern	(([135689]\- [0-9]){2}([a-zA-Z0-9]){1}\.([a-zA-Z0-9]{1,2}))*(:[RLBrlb])?	
Kind	Value	Annotation					
pattern	(([135689]\- [0-9]){2}([a-zA-Z0-9]){1}\.([a-zA-Z0-9]{1,2}))*(:[RLBrlb])?						
annotation	documentation Facette zur Festlegung des Prozedurenschlüssels						

source	<pre> <simpleType name="OPS"> <annotation> <documentation>Facette zur Festlegung des Prozedurenschlüssels</documentation> </annotation> <restriction base="xs:token"> <pattern value="([135689]\-([0-9]){2}([a-zA-Z0-9]){1}(\.([a-zA-Z0-9]{1,2}))*(:[RLBr1b] ?))"/> </restriction> </simpleType> </pre>
--------	---

simpleType **String2**

namespace	http://xml.ir-d.de/irdsa						
type	restriction of token						
properties	base xs:token						
facets	<table border="1"> <thead> <tr> <th>Kind</th> <th>Value</th> <th>Annotation</th> </tr> </thead> <tbody> <tr> <td>pattern</td> <td>([0-9]{2})</td> <td></td> </tr> </tbody> </table>	Kind	Value	Annotation	pattern	([0-9]{2})	
Kind	Value	Annotation					
pattern	([0-9]{2})						
annotation	documentation Facette zur Festlegung des kodierten Entlassungsgrundes						
source	<pre> <simpleType name="String2"> <annotation> <documentation>Facette zur Festlegung des kodierten Entlassungsgrundes</documentation> </annotation> <restriction base="xs:token"> <pattern value="([0-9]{2})"/> </restriction> </simpleType> </pre>						

simpleType **String20**

namespace	http://xml.ir-d.de/irdsa						
type	restriction of token						
properties	base xs:token						
facets	<table border="1"> <thead> <tr> <th>Kind</th> <th>Value</th> <th>Annotation</th> </tr> </thead> <tbody> <tr> <td>maxLength</td> <td>20</td> <td></td> </tr> </tbody> </table>	Kind	Value	Annotation	maxLength	20	
Kind	Value	Annotation					
maxLength	20						
annotation	documentation Facette zur Festlegung von: Artikel-, Ident-, Serien-, Lot-Nummer des Produkts						
source	<pre> <simpleType name="String20"> <annotation> <documentation>Facette zur Festlegung von: Artikel-, Ident-, Serien-, Lot-Nummer des Produkts</documentation> </annotation> <restriction base="xs:token"> <maxLength value="20"/> </restriction> </simpleType> </pre>						

simpleType Sw

namespace	http://xml.ir-d.de/irdsa						
type	restriction of token						
properties	base xs:token						
facets	<table border="1"> <thead> <tr> <th>Kind</th> <th>Value</th> <th>Annotation</th> </tr> </thead> <tbody> <tr> <td>maxLength</td> <td>120</td> <td></td> </tr> </tbody> </table>	Kind	Value	Annotation	maxLength	120	
Kind	Value	Annotation					
maxLength	120						
annotation	documentation Facette für Merkmale der externen Software						
source	<pre><simpleType name="Sw"> <annotation> <documentation>Facette für Merkmale der externen Software</documentation> </annotation> <restriction base="xs:token"> <maxLength value="120"/> </restriction> </simpleType></pre>						

simpleType Transfervummer

namespace	http://xml.ir-d.de/irdsa						
type	restriction of token						
properties	base xs:token						
used by	element StornoFallBasis/FAL Transfervummer						
facets	<table border="1"> <thead> <tr> <th>Kind</th> <th>Value</th> <th>Annotation</th> </tr> </thead> <tbody> <tr> <td>pattern</td> <td>([a-z0-9]{64})</td> <td></td> </tr> </tbody> </table>	Kind	Value	Annotation	pattern	([a-z0-9]{64})	
Kind	Value	Annotation					
pattern	([a-z0-9]{64})						
annotation	documentation Facette zur Festlegung der Transfervummer						
source	<pre><simpleType name="Transfervummer"> <annotation> <documentation>Facette zur Festlegung der Transfervummer</documentation> </annotation> <restriction base="xs:token"> <pattern value="([a-z0-9]{64})"/> </restriction> </simpleType></pre>						

simpleType Versionsnummer

namespace	http://xml.ir-d.de/irdsa						
type	restriction of token						
properties	base xs:token						
facets	<table border="1"> <thead> <tr> <th>Kind</th> <th>Value</th> <th>Annotation</th> </tr> </thead> <tbody> <tr> <td>maxLength</td> <td>10</td> <td></td> </tr> </tbody> </table>	Kind	Value	Annotation	maxLength	10	
Kind	Value	Annotation					
maxLength	10						
annotation	documentation Facette zur Festlegung der Versionsnummer des gelieferten Datensatzes						
source	<pre><simpleType name="Versionsnummer"> <annotation> <documentation>Facette zur Festlegung der Versionsnummer des gelieferten Datensatzes</documentation> </annotation></pre>						

	<pre> <restriction base="xs:token"> <maxLength value="10"/> </restriction> </simpleType> </pre>
--	---

simpleType **Zahl1**

namespace	http://xml.ir-d.de/irdsa									
type	restriction of positiveInteger									
properties	base xs:positiveInteger									
facets	<table border="1"> <thead> <tr> <th>Kind</th> <th>Value</th> <th>Annotation</th> </tr> </thead> <tbody> <tr> <td>minInclusive</td> <td>1</td> <td></td> </tr> <tr> <td>maxInclusive</td> <td>9</td> <td></td> </tr> </tbody> </table>	Kind	Value	Annotation	minInclusive	1		maxInclusive	9	
Kind	Value	Annotation								
minInclusive	1									
maxInclusive	9									
annotation	documentation Facette zur Festlegung der 1-stelligen Ganzzahlenwerte									
source	<pre> <simpleType name="Zahl1"> <annotation> <documentation>Facette zur Festlegung der 1-stelligen Ganzzahlenwerte</documentation> </annotation> <restriction base="xs:positiveInteger"> <minInclusive value="1"/> <maxInclusive value="9"/> </restriction> </simpleType> </pre>									

simpleType **Zahl1_1**

namespace	http://xml.ir-d.de/irdsa															
type	restriction of decimal															
properties	base xs:decimal															
facets	<table border="1"> <thead> <tr> <th>Kind</th> <th>Value</th> <th>Annotation</th> </tr> </thead> <tbody> <tr> <td>minExclusive</td> <td>0</td> <td></td> </tr> <tr> <td>maxExclusive</td> <td>10</td> <td></td> </tr> <tr> <td>totalDigits</td> <td>1</td> <td></td> </tr> <tr> <td>fractionDigits</td> <td>1</td> <td></td> </tr> </tbody> </table>	Kind	Value	Annotation	minExclusive	0		maxExclusive	10		totalDigits	1		fractionDigits	1	
Kind	Value	Annotation														
minExclusive	0															
maxExclusive	10															
totalDigits	1															
fractionDigits	1															
annotation	documentation Facette zur Festlegung des Formats [N].[N]															
source	<pre> <simpleType name="Zahl1_1"> <annotation> <documentation>Facette zur Festlegung des Formats [N].[N]</documentation> </annotation> <restriction base="xs:decimal"> <totalDigits value="1"/> <fractionDigits value="1"/> <minExclusive value="0"/> <maxExclusive value="10"/> </restriction> </simpleType> </pre>															

simpleType Zahl2

namespace	http://xml.ir-d.de/irdsa									
type	restriction of positivelnteger									
properties	base xs:positivelnteger									
facets	<table border="1"> <thead> <tr> <th>Kind</th> <th>Value</th> <th>Annotation</th> </tr> </thead> <tbody> <tr> <td>minInclusive</td> <td>1</td> <td></td> </tr> <tr> <td>maxInclusive</td> <td>99</td> <td></td> </tr> </tbody> </table>	Kind	Value	Annotation	minInclusive	1		maxInclusive	99	
Kind	Value	Annotation								
minInclusive	1									
maxInclusive	99									
annotation	documentation Facette zur Festlegung der 2-stelligen Ganzzahlenwerte									
source	<pre><simpleType name="Zahl2"> <annotation> <documentation>Facette zur Festlegung der 2-stelligen Ganzzahlenwerte</documentation> </annotation> <restriction base="xs:positiveInteger"> <minInclusive value="1"/> <maxInclusive value="99"/> </restriction> </simpleType></pre>									

simpleType Zahl2_1

namespace	http://xml.ir-d.de/irdsa															
type	restriction of decimal															
properties	base xs:decimal															
facets	<table border="1"> <thead> <tr> <th>Kind</th> <th>Value</th> <th>Annotation</th> </tr> </thead> <tbody> <tr> <td>minExclusive</td> <td>0</td> <td></td> </tr> <tr> <td>maxExclusive</td> <td>100</td> <td></td> </tr> <tr> <td>totalDigits</td> <td>2</td> <td></td> </tr> <tr> <td>fractionDigits</td> <td>1</td> <td></td> </tr> </tbody> </table>	Kind	Value	Annotation	minExclusive	0		maxExclusive	100		totalDigits	2		fractionDigits	1	
Kind	Value	Annotation														
minExclusive	0															
maxExclusive	100															
totalDigits	2															
fractionDigits	1															
annotation	documentation Facette zur Festlegung des Formats [NN].[N]															
source	<pre><simpleType name="Zahl2_1"> <annotation> <documentation>Facette zur Festlegung des Formats [NN].[N]</documentation> </annotation> <restriction base="xs:decimal"> <totalDigits value="2"/> <fractionDigits value="1"/> <minExclusive value="0"/> <maxExclusive value="100"/> </restriction> </simpleType></pre>															

simpleType Zahl3

namespace	http://xml.ir-d.de/irdsa			
type	restriction of positivelnteger			
properties	base xs:positivelnteger			
facets	<table border="1"> <thead> <tr> <th>Kind</th> <th>Value</th> <th>Annotation</th> </tr> </thead> <tbody> </tbody> </table>	Kind	Value	Annotation
Kind	Value	Annotation		

	minInclusive 1 maxInclusive 999
annotation	documentation Facette zur Festlegung der 3-stelligen Ganzzahlenwerte
source	<pre><simpleType name="Zahl3"> <annotation> <documentation>Facette zur Festlegung der 3-stelligen Ganzzahlenwerte</documentation> </annotation> <restriction base="xs:positiveInteger"> <minInclusive value="1"/> <maxInclusive value="999"/> </restriction> </simpleType></pre>

simpleType Zahl3_1

namespace	http://xml.ir-d.de/irdsa															
type	restriction of decimal															
properties	base xs:decimal															
facets	<table border="1"> <thead> <tr> <th>Kind</th> <th>Value</th> <th>Annotation</th> </tr> </thead> <tbody> <tr> <td>minExclusive</td> <td>0</td> <td></td> </tr> <tr> <td>maxExclusive</td> <td>1000</td> <td></td> </tr> <tr> <td>totalDigits</td> <td>3</td> <td></td> </tr> <tr> <td>fractionDigits</td> <td>1</td> <td></td> </tr> </tbody> </table>	Kind	Value	Annotation	minExclusive	0		maxExclusive	1000		totalDigits	3		fractionDigits	1	
Kind	Value	Annotation														
minExclusive	0															
maxExclusive	1000															
totalDigits	3															
fractionDigits	1															
annotation	documentation Facette zur Festlegung des Formats [NNN].[N]															
source	<pre><simpleType name="Zahl3_1"> <annotation> <documentation>Facette zur Festlegung des Formats [NNN].[N]</documentation> </annotation> <restriction base="xs:decimal"> <totalDigits value="3"/> <fractionDigits value="1"/> <minExclusive value="0"/> <maxExclusive value="1000"/> </restriction> </simpleType></pre>															

simpleType Zahl4

namespace	http://xml.ir-d.de/irdsa									
type	restriction of positiveInteger									
properties	base xs:positiveInteger									
facets	<table border="1"> <thead> <tr> <th>Kind</th> <th>Value</th> <th>Annotation</th> </tr> </thead> <tbody> <tr> <td>minInclusive</td> <td>1</td> <td></td> </tr> <tr> <td>maxInclusive</td> <td>9999</td> <td></td> </tr> </tbody> </table>	Kind	Value	Annotation	minInclusive	1		maxInclusive	9999	
Kind	Value	Annotation								
minInclusive	1									
maxInclusive	9999									
annotation	documentation Facette zur Festlegung der 4-stelligen Ganzzahlenwerte									
source	<pre><simpleType name="Zahl4"> <annotation> <documentation>Facette zur Festlegung der 4-stelligen</pre>									

	<pre>Ganzzahlenwerte</documentation> </annotation> <restriction base="xs:positiveInteger"> <minInclusive value="1"/> <maxInclusive value="9999"/> </restriction> </simpleType></pre>
--	--

simpleType **Zahl5**

namespace	http://xml.ir-d.de/irdsa									
type	restriction of positiveInteger									
properties	base xs:positiveInteger									
facets	<table border="1"> <thead> <tr> <th>Kind</th> <th>Value</th> <th>Annotation</th> </tr> </thead> <tbody> <tr> <td>minInclusive</td> <td>1</td> <td></td> </tr> <tr> <td>maxInclusive</td> <td>99999</td> <td></td> </tr> </tbody> </table>	Kind	Value	Annotation	minInclusive	1		maxInclusive	99999	
Kind	Value	Annotation								
minInclusive	1									
maxInclusive	99999									
annotation	documentation Facette zur Festlegung der 5-stelligen Ganzzahlenwerte									
source	<pre><simpleType name="Zahl5"> <annotation> <documentation>Facette zur Festlegung der 5-stelligen Ganzzahlenwerte</documentation> </annotation> <restriction base="xs:positiveInteger"> <minInclusive value="1"/> <maxInclusive value="99999"/> </restriction> </simpleType></pre>									

complexType **MeldungIrdBasis**

diagram	
namespace	http://xml.ir-d.de/irdsa
children	MEL_IrdIdGesundheitseinrichtung
used by	complexType Storno
source	<pre><complexType name="MeldungIrdBasis"> <sequence> <element name="MEL_IrdIdGesundheitseinrichtung" type="IdEinrichtung"/> </sequence> </complexType></pre>

element **MeldungIrdBasis/MEL_IrdIdGesundheitseinrichtung**

diagram	
---------	--

type	IdEinrichtung						
properties	content simple						
facets	<table border="1"> <thead> <tr> <th>Kind</th> <th>Value</th> <th>Annotation</th> </tr> </thead> <tbody> <tr> <td>pattern</td> <td>(IRD-GE-[0-9]{8})</td> <td></td> </tr> </tbody> </table>	Kind	Value	Annotation	pattern	(IRD-GE-[0-9]{8})	
Kind	Value	Annotation					
pattern	(IRD-GE-[0-9]{8})						
source	<code><element name="MEL_IrdIdGesundheitseinrichtung" type="IdEinrichtung"/></code>						

complexType **StornoFallBasis**

diagram	
namespace	http://xml.ir-d.de/irdsa
children	FAL Transfernummer FAL Aufnahmedatum
used by	element Storno/fall
source	<pre> <complexType name="StornoFallBasis"> <sequence> <element name="FAL_Transfernummer" type="Transfernummer"/> <element name="FAL_Aufnahmedatum" type="xs:date"/> </sequence> </complexType> </pre>

element **StornoFallBasis/FAL_Transfernummer**

diagram							
type	Transfernummer						
properties	content simple						
facets	<table border="1"> <thead> <tr> <th>Kind</th> <th>Value</th> <th>Annotation</th> </tr> </thead> <tbody> <tr> <td>pattern</td> <td>([a-z0-9]{64})</td> <td></td> </tr> </tbody> </table>	Kind	Value	Annotation	pattern	([a-z0-9]{64})	
Kind	Value	Annotation					
pattern	([a-z0-9]{64})						
source	<code><element name="FAL_Transfernummer" type="Transfernummer"/></code>						

element **StornoFallBasis/FAL_Aufnahmedatum**

diagram	
type	date
properties	content simple
source	<code><element name="FAL_Aufnahmedatum" type="xs:date"/></code>

simpleType DatumText

namespace	http://xml.ir-d.de/sak						
type	restriction of token						
properties	base xs:token						
facets	<table border="1"> <thead> <tr> <th>Kind</th> <th>Value</th> <th>Annotation</th> </tr> </thead> <tbody> <tr> <td>pattern</td> <td>(([0-9]{4})([0-9]{2})?([0-9]{2})?)</td> <td></td> </tr> </tbody> </table>	Kind	Value	Annotation	pattern	(([0-9]{4})([0-9]{2})?([0-9]{2})?)	
Kind	Value	Annotation					
pattern	(([0-9]{4})([0-9]{2})?([0-9]{2})?)						
annotation	documentation Facette zur Festlegung des freien Datumformats: JJJ[-MM[-TT]]						
source	<pre><simpleType name="DatumText"> <annotation> <documentation>Facette zur Festlegung des freien Datumformats: JJJ[-MM[-TT]]</documentation> </annotation> <restriction base="xs:token"> <pattern value="((([0-9]{4})([0-9]{2})?([0-9]{2})?)"/> </restriction> </simpleType></pre>						

simpleType Freitext250

namespace	http://xml.ir-d.de/sak						
type	restriction of token						
properties	base xs:token						
facets	<table border="1"> <thead> <tr> <th>Kind</th> <th>Value</th> <th>Annotation</th> </tr> </thead> <tbody> <tr> <td>maxLength</td> <td>250</td> <td></td> </tr> </tbody> </table>	Kind	Value	Annotation	maxLength	250	
Kind	Value	Annotation					
maxLength	250						
annotation	documentation Facette zur Festlegung des Freitextes von 250 Zeichen						
source	<pre><simpleType name="Freitext250"> <annotation> <documentation>Facette zur Festlegung des Freitextes von 250 Zeichen</documentation> </annotation> <restriction base="xs:token"> <maxLength value="250"/> </restriction> </simpleType></pre>						

simpleType Freitext500

namespace	http://xml.ir-d.de/sak						
type	restriction of token						
properties	base xs:token						
facets	<table border="1"> <thead> <tr> <th>Kind</th> <th>Value</th> <th>Annotation</th> </tr> </thead> <tbody> <tr> <td>maxLength</td> <td>500</td> <td></td> </tr> </tbody> </table>	Kind	Value	Annotation	maxLength	500	
Kind	Value	Annotation					
maxLength	500						
annotation	documentation Facette zur Festlegung des Freitextes von 500 Zeichen						
source	<pre><simpleType name="Freitext500"> <annotation> <documentation>Facette zur Festlegung des Freitextes von 500</pre>						

	<pre> Zeichen</documentation> </annotation> <restriction base="xs:token"> <maxLength value="500"/> </restriction> </simpleType> </pre>
--	--

simpleType HashString

namespace	http://xml.ir-d.de/sak						
type	restriction of token						
properties	base xs:token						
facets	<table border="1"> <thead> <tr> <th>Kind</th> <th>Value</th> <th>Annotation</th> </tr> </thead> <tbody> <tr> <td>maxLength</td> <td>512</td> <td></td> </tr> </tbody> </table>	Kind	Value	Annotation	maxLength	512	
Kind	Value	Annotation					
maxLength	512						
annotation	documentation Facette zur Festlegung des Hash-Strings der Meldebestätigung						
source	<pre> <simpleType name="HashString"> <annotation> <documentation>Facette zur Festlegung des Hash-Strings der Meldebestätigung</documentation> </annotation> <restriction base="xs:token"> <maxLength value="512"/> </restriction> </simpleType> </pre>						

simpleType HashWert

namespace	http://xml.ir-d.de/sak						
type	restriction of token						
properties	base xs:token						
facets	<table border="1"> <thead> <tr> <th>Kind</th> <th>Value</th> <th>Annotation</th> </tr> </thead> <tbody> <tr> <td>length</td> <td>64</td> <td></td> </tr> </tbody> </table>	Kind	Value	Annotation	length	64	
Kind	Value	Annotation					
length	64						
annotation	documentation Facette zur Festlegung des Hashwertes der Meldebestätigung						
source	<pre> <simpleType name="HashWert"> <annotation> <documentation>Facette zur Festlegung des Hashwertes der Meldebestätigung</documentation> </annotation> <restriction base="xs:token"> <length value="64"/> </restriction> </simpleType> </pre>						

simpleType ICD

namespace	http://xml.ir-d.de/sak
type	restriction of token
properties	base xs:token

facets	Kind Value Annotation pattern ([a-zA-Z][0-9]{2}(\.[0-9]{1,2})?(:[RLB])?)
annotation	documentation Facette zur Festlegung des ICD Code
source	<pre><simpleType name="ICD"> <annotation> <documentation>Facette zur Festlegung des ICD Code</documentation> </annotation> <restriction base="xs:token"> <pattern value="([a-zA-Z][0-9]{2}(\.[0-9]{1,2})?(:[RLB])?)"/> </restriction> </simpleType></pre>

simpleType IdEinrichtung

namespace	http://xml.ir-d.de/sak
type	restriction of token
properties	base xs:token
used by	element MeldungIrdBasis/MEL_IrdIdGesundheitseinrichtung
facets	Kind Value Annotation pattern (IRD-GE-[0-9]{8})
annotation	documentation Facette zur Festlegung der Gesundheitseinrichtung-ID
source	<pre><simpleType name="IdEinrichtung"> <annotation> <documentation>Facette zur Festlegung der Gesundheitseinrichtung-ID</documentation> </annotation> <restriction base="xs:token"> <pattern value="(IRD-GE-[0-9]{8})"/> </restriction> </simpleType></pre>

simpleType IrdArtikelId

namespace	http://xml.ir-d.de/sak
type	restriction of token
properties	base xs:token
facets	Kind Value Annotation maxLength 16
annotation	documentation Facette zur Festlegung der IrdNummer
source	<pre><simpleType name="IrdArtikelId"> <annotation> <documentation>Facette zur Festlegung der IrdNummer</documentation> </annotation> <restriction base="xs:token"> <maxLength value="16"/> </restriction> </simpleType></pre>

simpleType IrdSpezVersion

namespace	http://xml.ir-d.de/sak						
type	restriction of token						
properties	base xs:token						
facets	<table border="1"> <thead> <tr> <th>Kind</th> <th>Value</th> <th>Annotation</th> </tr> </thead> <tbody> <tr> <td>pattern</td> <td>(([1-9] [1-9][0-9])\.\d{1-9})\.\d{1-9}</td> <td></td> </tr> </tbody> </table>	Kind	Value	Annotation	pattern	(([1-9] [1-9][0-9])\.\d{1-9})\.\d{1-9}	
Kind	Value	Annotation					
pattern	(([1-9] [1-9][0-9])\.\d{1-9})\.\d{1-9}						
annotation	documentation Facette zur Festlegung der Version der IRD-Spezifikation						
source	<pre><simpleType name="IrdSpezVersion"> <annotation> <documentation>Facette zur Festlegung der Version der IRD-Spezifikation</documentation> </annotation> <restriction base="xs:token"> <pattern value="(([1-9] [1-9][0-9])\.\d{1-9})\.\d{1-9}"/> </restriction> </simpleType></pre>						

simpleType JaLeer

namespace	http://xml.ir-d.de/sak						
type	restriction of integer						
properties	base xs:integer						
facets	<table border="1"> <thead> <tr> <th>Kind</th> <th>Value</th> <th>Annotation</th> </tr> </thead> <tbody> <tr> <td>pattern</td> <td>(1)</td> <td></td> </tr> </tbody> </table>	Kind	Value	Annotation	pattern	(1)	
Kind	Value	Annotation					
pattern	(1)						
annotation	documentation Facette zur Festlegung des Unbekannt-Wertes (Bedeutung 1=true)						
source	<pre><simpleType name="JaLeer"> <annotation> <documentation>Facette zur Festlegung des Unbekannt-Wertes (Bedeutung 1=true)</documentation> </annotation> <restriction base="xs:integer"> <pattern value="(1)"/> </restriction> </simpleType></pre>						

simpleType Meldebestaetigung

namespace	http://xml.ir-d.de/sak						
type	restriction of token						
properties	base xs:token						
facets	<table border="1"> <thead> <tr> <th>Kind</th> <th>Value</th> <th>Annotation</th> </tr> </thead> <tbody> <tr> <td>length</td> <td>10</td> <td></td> </tr> </tbody> </table>	Kind	Value	Annotation	length	10	
Kind	Value	Annotation					
length	10						
annotation	documentation Facette zur Festlegung der Meldebestätigungslaenge von 10 Zeichen						
source	<pre><simpleType name="Meldebestaetigung"> <annotation> <documentation>Facette zur Festlegung der Meldebestätigungslaenge von 10</pre>						

	<pre> Zeichen</documentation> </annotation> <restriction base="xs:token"> <length value="10"/> </restriction> </simpleType> </pre>
--	--

simpleType OPS

namespace	http://xml.ir-d.de/sak						
type	restriction of token						
properties	base xs:token						
facets	<table border="1"> <thead> <tr> <th>Kind</th> <th>Value</th> <th>Annotation</th> </tr> </thead> <tbody> <tr> <td>pattern</td> <td>(([135689]\-([0-9]){2}([a-zA-Z0-9]){1}\.([a-zA-Z0-9]{1,2}))*(:[RLBr1b])?)</td> <td></td> </tr> </tbody> </table>	Kind	Value	Annotation	pattern	(([135689]\-([0-9]){2}([a-zA-Z0-9]){1}\.([a-zA-Z0-9]{1,2}))*(:[RLBr1b])?)	
Kind	Value	Annotation					
pattern	(([135689]\-([0-9]){2}([a-zA-Z0-9]){1}\.([a-zA-Z0-9]{1,2}))*(:[RLBr1b])?)						
annotation	documentation Facette zur Festlegung des Prozedurenschlüssels						
source	<pre> <simpleType name="OPS"> <annotation> <documentation>Facette zur Festlegung des Prozedurenschlüssels</documentation> </annotation> <restriction base="xs:token"> <pattern value="([135689]\-([0-9]){2}([a-zA-Z0-9]){1}\.([a-zA-Z0-9]{1,2}))*(:[RLBr1b]) ?)" /> </restriction> </simpleType> </pre>						

simpleType String2

namespace	http://xml.ir-d.de/sak						
type	restriction of token						
properties	base xs:token						
facets	<table border="1"> <thead> <tr> <th>Kind</th> <th>Value</th> <th>Annotation</th> </tr> </thead> <tbody> <tr> <td>pattern</td> <td>([0-9]{2})</td> <td></td> </tr> </tbody> </table>	Kind	Value	Annotation	pattern	([0-9]{2})	
Kind	Value	Annotation					
pattern	([0-9]{2})						
annotation	documentation Facette zur Festlegung des kodierten Entlassungsgrundes						
source	<pre> <simpleType name="String2"> <annotation> <documentation>Facette zur Festlegung des kodierten Entlassungsgrundes</documentation> </annotation> <restriction base="xs:token"> <pattern value="([0-9]{2})" /> </restriction> </simpleType> </pre>						

simpleType String20

namespace	http://xml.ir-d.de/sak
-----------	------------------------

type	restriction of token						
properties	base xs:token						
facets	<table border="1"> <thead> <tr> <th>Kind</th> <th>Value</th> <th>Annotation</th> </tr> </thead> <tbody> <tr> <td>maxLength</td> <td>20</td> <td></td> </tr> </tbody> </table>	Kind	Value	Annotation	maxLength	20	
Kind	Value	Annotation					
maxLength	20						
annotation	documentation Facette zur Festlegung von: Artikel-, Ident-, Serien-, Lot-Nummer des Produkts						
source	<pre><simpleType name="String20"> <annotation> <documentation>Facette zur Festlegung von: Artikel-, Ident-, Serien-, Lot-Nummer des Produkts</documentation> </annotation> <restriction base="xs:token"> <maxLength value="20"/> </restriction> </simpleType></pre>						

simpleType Sw

namespace	http://xml.ir-d.de/sak						
type	restriction of token						
properties	base xs:token						
facets	<table border="1"> <thead> <tr> <th>Kind</th> <th>Value</th> <th>Annotation</th> </tr> </thead> <tbody> <tr> <td>maxLength</td> <td>120</td> <td></td> </tr> </tbody> </table>	Kind	Value	Annotation	maxLength	120	
Kind	Value	Annotation					
maxLength	120						
annotation	documentation Facette für Merkmale der externen Software						
source	<pre><simpleType name="Sw"> <annotation> <documentation>Facette für Merkmale der externen Software</documentation> </annotation> <restriction base="xs:token"> <maxLength value="120"/> </restriction> </simpleType></pre>						

simpleType Transfnummer

namespace	http://xml.ir-d.de/sak						
type	restriction of token						
properties	base xs:token						
used by	element SelbstauskunftFallBasis/FAL Transfnummer						
facets	<table border="1"> <thead> <tr> <th>Kind</th> <th>Value</th> <th>Annotation</th> </tr> </thead> <tbody> <tr> <td>pattern</td> <td>([a-z0-9]{64})</td> <td></td> </tr> </tbody> </table>	Kind	Value	Annotation	pattern	([a-z0-9]{64})	
Kind	Value	Annotation					
pattern	([a-z0-9]{64})						
annotation	documentation Facette zur Festlegung der Transfnummer						
source	<pre><simpleType name="Transfnummer"> <annotation> <documentation>Facette zur Festlegung der Transfnummer</documentation> </annotation> <restriction base="xs:token"> <pattern value="([a-z0-9]{64})"/> </restriction> </simpleType></pre>						

	<code></simpleType></code>
--	----------------------------------

simpleType **Versionsnummer**

namespace	http://xml.ir-d.de/sak						
type	restriction of token						
properties	base xs:token						
facets	<table border="1"> <thead> <tr> <th>Kind</th> <th>Value</th> <th>Annotation</th> </tr> </thead> <tbody> <tr> <td>maxLength</td> <td>10</td> <td></td> </tr> </tbody> </table>	Kind	Value	Annotation	maxLength	10	
Kind	Value	Annotation					
maxLength	10						
annotation	documentation Facette zur Festlegung der Versionsnummer des gelieferten Datensatzes						
source	<pre><simpleType name="Versionsnummer"> <annotation> <documentation>Facette zur Festlegung der Versionsnummer des gelieferten Datensatzes</documentation> </annotation> <restriction base="xs:token"> <maxLength value="10"/> </restriction> </simpleType></pre>						

simpleType **Zahl1**

namespace	http://xml.ir-d.de/sak									
type	restriction of positiveInteger									
properties	base xs:positiveInteger									
facets	<table border="1"> <thead> <tr> <th>Kind</th> <th>Value</th> <th>Annotation</th> </tr> </thead> <tbody> <tr> <td>minInclusive</td> <td>1</td> <td></td> </tr> <tr> <td>maxInclusive</td> <td>9</td> <td></td> </tr> </tbody> </table>	Kind	Value	Annotation	minInclusive	1		maxInclusive	9	
Kind	Value	Annotation								
minInclusive	1									
maxInclusive	9									
annotation	documentation Facette zur Festlegung der 1-stelligen Ganzzahlenwerte									
source	<pre><simpleType name="Zahl1"> <annotation> <documentation>Facette zur Festlegung der 1-stelligen Ganzzahlenwerte</documentation> </annotation> <restriction base="xs:positiveInteger"> <minInclusive value="1"/> <maxInclusive value="9"/> </restriction> </simpleType></pre>									

simpleType **Zahl1_1**

namespace	http://xml.ir-d.de/sak									
type	restriction of decimal									
properties	base xs:decimal									
facets	<table border="1"> <thead> <tr> <th>Kind</th> <th>Value</th> <th>Annotation</th> </tr> </thead> <tbody> <tr> <td>minExclusive</td> <td>0</td> <td></td> </tr> <tr> <td>maxExclusive</td> <td>10</td> <td></td> </tr> </tbody> </table>	Kind	Value	Annotation	minExclusive	0		maxExclusive	10	
Kind	Value	Annotation								
minExclusive	0									
maxExclusive	10									

	totalDigits 1 fractionDigits 1
annotation	documentation Facette zur Festlegung des Formats [N].[N]
source	<pre><simpleType name="Zahl1_1"> <annotation> <documentation>Facette zur Festlegung des Formats [N].[N]</documentation> </annotation> <restriction base="xs:decimal"> <totalDigits value="1"/> <fractionDigits value="1"/> <minExclusive value="0"/> <maxExclusive value="10"/> </restriction> </simpleType></pre>

simpleType Zahl2

namespace	http://xml.ir-d.de/sak									
type	restriction of positiveInteger									
properties	base xs:positiveInteger									
facets	<table border="1"> <thead> <tr> <th>Kind</th> <th>Value</th> <th>Annotation</th> </tr> </thead> <tbody> <tr> <td>minInclusive</td> <td>1</td> <td></td> </tr> <tr> <td>maxInclusive</td> <td>99</td> <td></td> </tr> </tbody> </table>	Kind	Value	Annotation	minInclusive	1		maxInclusive	99	
Kind	Value	Annotation								
minInclusive	1									
maxInclusive	99									
annotation	documentation Facette zur Festlegung der 2-stelligen Ganzzahlenwerte									
source	<pre><simpleType name="Zahl2"> <annotation> <documentation>Facette zur Festlegung der 2-stelligen Ganzzahlenwerte</documentation> </annotation> <restriction base="xs:positiveInteger"> <minInclusive value="1"/> <maxInclusive value="99"/> </restriction> </simpleType></pre>									

simpleType Zahl2_1

namespace	http://xml.ir-d.de/sak															
type	restriction of decimal															
properties	base xs:decimal															
facets	<table border="1"> <thead> <tr> <th>Kind</th> <th>Value</th> <th>Annotation</th> </tr> </thead> <tbody> <tr> <td>minExclusive</td> <td>0</td> <td></td> </tr> <tr> <td>maxExclusive</td> <td>100</td> <td></td> </tr> <tr> <td>totalDigits</td> <td>2</td> <td></td> </tr> <tr> <td>fractionDigits</td> <td>1</td> <td></td> </tr> </tbody> </table>	Kind	Value	Annotation	minExclusive	0		maxExclusive	100		totalDigits	2		fractionDigits	1	
Kind	Value	Annotation														
minExclusive	0															
maxExclusive	100															
totalDigits	2															
fractionDigits	1															
annotation	documentation Facette zur Festlegung des Formats [NN].[N]															
source	<pre><simpleType name="Zahl2_1"> <annotation> <documentation>Facette zur Festlegung des Formats [NN].[N]</documentation></pre>															

	<pre> </annotation> <restriction base="xs:decimal"> <totalDigits value="2"/> <fractionDigits value="1"/> <minExclusive value="0"/> <maxExclusive value="100"/> </restriction> </simpleType> </pre>
--	--

simpleType Zahl3

namespace	http://xml.ir-d.de/sak									
type	restriction of positivelnteger									
properties	base xs:positivelnteger									
facets	<table border="1"> <thead> <tr> <th>Kind</th> <th>Value</th> <th>Annotation</th> </tr> </thead> <tbody> <tr> <td>minInclusive</td> <td>1</td> <td></td> </tr> <tr> <td>maxInclusive</td> <td>999</td> <td></td> </tr> </tbody> </table>	Kind	Value	Annotation	minInclusive	1		maxInclusive	999	
Kind	Value	Annotation								
minInclusive	1									
maxInclusive	999									
annotation	documentation Facette zur Festlegung der 3-stelligen Ganzzahlenwerte									
source	<pre> <simpleType name="Zahl3"> <annotation> <documentation>Facette zur Festlegung der 3-stelligen Ganzzahlenwerte</documentation> </annotation> <restriction base="xs:positiveInteger"> <minInclusive value="1"/> <maxInclusive value="999"/> </restriction> </simpleType> </pre>									

simpleType Zahl3_1

namespace	http://xml.ir-d.de/sak															
type	restriction of decimal															
properties	base xs:decimal															
facets	<table border="1"> <thead> <tr> <th>Kind</th> <th>Value</th> <th>Annotation</th> </tr> </thead> <tbody> <tr> <td>minExclusive</td> <td>0</td> <td></td> </tr> <tr> <td>maxExclusive</td> <td>1000</td> <td></td> </tr> <tr> <td>totalDigits</td> <td>3</td> <td></td> </tr> <tr> <td>fractionDigits</td> <td>1</td> <td></td> </tr> </tbody> </table>	Kind	Value	Annotation	minExclusive	0		maxExclusive	1000		totalDigits	3		fractionDigits	1	
Kind	Value	Annotation														
minExclusive	0															
maxExclusive	1000															
totalDigits	3															
fractionDigits	1															
annotation	documentation Facette zur Festlegung des Formats [NNN].[N]															
source	<pre> <simpleType name="Zahl3_1"> <annotation> <documentation>Facette zur Festlegung des Formats [NNN].[N]</documentation> </annotation> <restriction base="xs:decimal"> <totalDigits value="3"/> <fractionDigits value="1"/> <minExclusive value="0"/> <maxExclusive value="1000"/> </restriction> </pre>															

	<code></simpleType></code>
--	----------------------------------

simpleType **Zahl4**

namespace	http://xml.ir-d.de/sak									
type	restriction of positivelnteger									
properties	base xs:positivelnteger									
facets	<table border="1"> <thead> <tr> <th>Kind</th> <th>Value</th> <th>Annotation</th> </tr> </thead> <tbody> <tr> <td>minInclusive</td> <td>1</td> <td></td> </tr> <tr> <td>maxInclusive</td> <td>9999</td> <td></td> </tr> </tbody> </table>	Kind	Value	Annotation	minInclusive	1		maxInclusive	9999	
Kind	Value	Annotation								
minInclusive	1									
maxInclusive	9999									
annotation	documentation Facette zur Festlegung der 4-stelligen Ganzzahlenwerte									
source	<pre> <simpleType name="Zahl4"> <annotation> <documentation>Facette zur Festlegung der 4-stelligen Ganzzahlenwerte</documentation> </annotation> <restriction base="xs:positiveInteger"> <minInclusive value="1"/> <maxInclusive value="9999"/> </restriction> </simpleType> </pre>									

simpleType **Zahl5**

namespace	http://xml.ir-d.de/sak									
type	restriction of positivelnteger									
properties	base xs:positivelnteger									
facets	<table border="1"> <thead> <tr> <th>Kind</th> <th>Value</th> <th>Annotation</th> </tr> </thead> <tbody> <tr> <td>minInclusive</td> <td>1</td> <td></td> </tr> <tr> <td>maxInclusive</td> <td>99999</td> <td></td> </tr> </tbody> </table>	Kind	Value	Annotation	minInclusive	1		maxInclusive	99999	
Kind	Value	Annotation								
minInclusive	1									
maxInclusive	99999									
annotation	documentation Facette zur Festlegung der 5-stelligen Ganzzahlenwerte									
source	<pre> <simpleType name="Zahl5"> <annotation> <documentation>Facette zur Festlegung der 5-stelligen Ganzzahlenwerte</documentation> </annotation> <restriction base="xs:positiveInteger"> <minInclusive value="1"/> <maxInclusive value="99999"/> </restriction> </simpleType> </pre>									

complexType **MeldungIrdBasis**

diagram	<pre> classDiagram class MeldungIrdBasis class MEL_IrdIdGesundheitseinrichtung { type pattern ((IRD-GE-[0-9]{8}) } MeldungIrdBasis "1" *-- "1" MEL_IrdIdGesundheitseinrichtung </pre>
---------	---

namespace	http://xml.ir-d.de/sak
children	MEL_IrdIdGesundheitseinrichtung
used by	complexType Selbstauskunft
source	<pre><complexType name="MeldungIrdBasis"> <sequence> <element name="MEL_IrdIdGesundheitseinrichtung" type="IdEinrichtung"/> </sequence> </complexType></pre>

element **MeldungIrdBasis/MEL_IrdIdGesundheitseinrichtung**

diagram							
type	IdEinrichtung						
properties	content simple						
facets	<table border="1"> <thead> <tr> <th>Kind</th> <th>Value</th> <th>Annotation</th> </tr> </thead> <tbody> <tr> <td>pattern</td> <td>(IRD-GE-[0-9]{8})</td> <td></td> </tr> </tbody> </table>	Kind	Value	Annotation	pattern	(IRD-GE-[0-9]{8})	
Kind	Value	Annotation					
pattern	(IRD-GE-[0-9]{8})						
source	<pre><element name="MEL_IrdIdGesundheitseinrichtung" type="IdEinrichtung"/></pre>						

complexType **SelbstauskunftFallBasis**

diagram	
namespace	http://xml.ir-d.de/sak
children	FAL_Transfernummer
used by	element Selbstauskunft/fall
source	<pre><complexType name="SelbstauskunftFallBasis"> <sequence> <element name="FAL_Transfernummer" type="Transfernummer"/> </sequence> </complexType></pre>

element **SelbstauskunftFallBasis/FAL_Transfernummer**

diagram							
type	Transfernummer						
properties	content simple						
facets	<table border="1"> <thead> <tr> <th>Kind</th> <th>Value</th> <th>Annotation</th> </tr> </thead> <tbody> <tr> <td>pattern</td> <td>([a-z0-9]{64})</td> <td></td> </tr> </tbody> </table>	Kind	Value	Annotation	pattern	([a-z0-9]{64})	
Kind	Value	Annotation					
pattern	([a-z0-9]{64})						

source	<code><element name="FAL_Transfernummer" type="Transfernummer"/></code>
--------	---

simpleType DatumText

namespace	http://xml.ir-d.de/irdsaa						
type	restriction of token						
properties	base xs:token						
facets	<table border="1"> <tr> <th>Kind</th> <th>Value</th> <th>Annotation</th> </tr> <tr> <td>pattern</td> <td><code>(([0-9]{4})([0-9]{2})?([0-9]{2})?)</code></td> <td></td> </tr> </table>	Kind	Value	Annotation	pattern	<code>(([0-9]{4})([0-9]{2})?([0-9]{2})?)</code>	
Kind	Value	Annotation					
pattern	<code>(([0-9]{4})([0-9]{2})?([0-9]{2})?)</code>						
annotation	documentation Facette zur Festlegung des freien Datumformats: JJJ[-MM[-TT]]						
source	<pre> <simpleType name="DatumText"> <annotation> <documentation>Facette zur Festlegung des freien Datumformats: JJJ[-MM[-TT]]</documentation> </annotation> <restriction base="xs:token"> <pattern value="((([0-9]{4})([0-9]{2})?([0-9]{2})?)"/> </restriction> </simpleType> </pre>						

simpleType Freitext250

namespace	http://xml.ir-d.de/irdsaa						
type	restriction of token						
properties	base xs:token						
used by	element EmpfangsbestaetigungBasis/EBG_Empfangsbestaetigung						
facets	<table border="1"> <tr> <th>Kind</th> <th>Value</th> <th>Annotation</th> </tr> <tr> <td>maxLength</td> <td>250</td> <td></td> </tr> </table>	Kind	Value	Annotation	maxLength	250	
Kind	Value	Annotation					
maxLength	250						
annotation	documentation Facette zur Festlegung des Freitextes von 250 Zeichen						
source	<pre> <simpleType name="Freitext250"> <annotation> <documentation>Facette zur Festlegung des Freitextes von 250 Zeichen</documentation> </annotation> <restriction base="xs:token"> <maxLength value="250"/> </restriction> </simpleType> </pre>						

simpleType Freitext500

namespace	http://xml.ir-d.de/irdsaa						
type	restriction of token						
properties	base xs:token						
facets	<table border="1"> <tr> <th>Kind</th> <th>Value</th> <th>Annotation</th> </tr> <tr> <td>maxLength</td> <td>500</td> <td></td> </tr> </table>	Kind	Value	Annotation	maxLength	500	
Kind	Value	Annotation					
maxLength	500						
annotation	documentation						

	Facette zur Festlegung des Freitextes von 500 Zeichen
source	<pre><simpleType name="Freitext500"> <annotation> <documentation>Facette zur Festlegung des Freitextes von 500 Zeichen</documentation> </annotation> <restriction base="xs:token"> <maxLength value="500"/> </restriction> </simpleType></pre>

simpleType HashString

namespace	http://xml.ir-d.de/irdsaa						
type	restriction of token						
properties	base xs:token						
facets	<table border="1"> <thead> <tr> <th>Kind</th> <th>Value</th> <th>Annotation</th> </tr> </thead> <tbody> <tr> <td>maxLength</td> <td>512</td> <td></td> </tr> </tbody> </table>	Kind	Value	Annotation	maxLength	512	
Kind	Value	Annotation					
maxLength	512						
annotation	documentation Facette zur Festlegung des Hash-Strings der Meldebestätigung						
source	<pre><simpleType name="HashString"> <annotation> <documentation>Facette zur Festlegung des Hash-Strings der Meldebestätigung</documentation> </annotation> <restriction base="xs:token"> <maxLength value="512"/> </restriction> </simpleType></pre>						

simpleType HashWert

namespace	http://xml.ir-d.de/irdsaa						
type	restriction of token						
properties	base xs:token						
facets	<table border="1"> <thead> <tr> <th>Kind</th> <th>Value</th> <th>Annotation</th> </tr> </thead> <tbody> <tr> <td>length</td> <td>64</td> <td></td> </tr> </tbody> </table>	Kind	Value	Annotation	length	64	
Kind	Value	Annotation					
length	64						
annotation	documentation Facette zur Festlegung des Hashwertes der Meldebestätigung						
source	<pre><simpleType name="HashWert"> <annotation> <documentation>Facette zur Festlegung des Hashwertes der Meldebestätigung</documentation> </annotation> <restriction base="xs:token"> <length value="64"/> </restriction> </simpleType></pre>						

simpleType ICD

namespace	http://xml.ir-d.de/irdsaa						
type	restriction of token						
properties	base xs:token						
facets	<table border="1"> <thead> <tr> <th>Kind</th> <th>Value</th> <th>Annotation</th> </tr> </thead> <tbody> <tr> <td>pattern</td> <td>([a-zA-Z][0-9]{2}(\.[0-9]{1,2})?(:[RLB])?)</td> <td></td> </tr> </tbody> </table>	Kind	Value	Annotation	pattern	([a-zA-Z][0-9]{2}(\.[0-9]{1,2})?(:[RLB])?)	
Kind	Value	Annotation					
pattern	([a-zA-Z][0-9]{2}(\.[0-9]{1,2})?(:[RLB])?)						
annotation	documentation Facette zur Festlegung des ICD Code						
source	<pre><simpleType name="ICD"> <annotation> <documentation>Facette zur Festlegung des ICD Code</documentation> </annotation> <restriction base="xs:token"> <pattern value="([a-zA-Z][0-9]{2}(\.[0-9]{1,2})?(:[RLB])?)"/> </restriction> </simpleType></pre>						

simpleType IdEinrichtung

namespace	http://xml.ir-d.de/irdsaa						
type	restriction of token						
properties	base xs:token						
used by	element MeldungIrdBasis/MEL_IrdIdGesundheitseinrichtung						
facets	<table border="1"> <thead> <tr> <th>Kind</th> <th>Value</th> <th>Annotation</th> </tr> </thead> <tbody> <tr> <td>pattern</td> <td>(IRD-GE-[0-9]{8})</td> <td></td> </tr> </tbody> </table>	Kind	Value	Annotation	pattern	(IRD-GE-[0-9]{8})	
Kind	Value	Annotation					
pattern	(IRD-GE-[0-9]{8})						
annotation	documentation Facette zur Festlegung der Gesundheitseinrichtung-ID						
source	<pre><simpleType name="IdEinrichtung"> <annotation> <documentation>Facette zur Festlegung der Gesundheitseinrichtung-ID</documentation> </annotation> <restriction base="xs:token"> <pattern value="(IRD-GE-[0-9]{8})"/> </restriction> </simpleType></pre>						

simpleType IrdArtikelId

namespace	http://xml.ir-d.de/irdsaa						
type	restriction of token						
properties	base xs:token						
facets	<table border="1"> <thead> <tr> <th>Kind</th> <th>Value</th> <th>Annotation</th> </tr> </thead> <tbody> <tr> <td>maxLength</td> <td>16</td> <td></td> </tr> </tbody> </table>	Kind	Value	Annotation	maxLength	16	
Kind	Value	Annotation					
maxLength	16						
annotation	documentation Facette zur Festlegung der IrdNummer						
source	<pre><simpleType name="IrdArtikelId"> <annotation> <documentation>Facette zur Festlegung der IrdNummer</documentation> </annotation></pre>						

	<pre> <restriction base="xs:token"> <maxLength value="16"/> </restriction> </simpleType> </pre>
--	---

simpleType IrdSpezVersion

namespace	http://xml.ir-d.de/irdsaa						
type	restriction of token						
properties	base xs:token						
facets	<table border="1"> <thead> <tr> <th>Kind</th> <th>Value</th> <th>Annotation</th> </tr> </thead> <tbody> <tr> <td>pattern</td> <td>(([1-9] [1-9][0-9])\.\d{1-9} \d{1-9})</td> <td></td> </tr> </tbody> </table>	Kind	Value	Annotation	pattern	(([1-9] [1-9][0-9])\.\d{1-9} \d{1-9})	
Kind	Value	Annotation					
pattern	(([1-9] [1-9][0-9])\.\d{1-9} \d{1-9})						
annotation	documentation Facette zur Festlegung der Version der IRD-Spezifikation						
source	<pre> <simpleType name="IrdSpezVersion"> <annotation> <documentation>Facette zur Festlegung der Version der IRD-Spezifikation</documentation> </annotation> <restriction base="xs:token"> <pattern value="(([1-9] [1-9][0-9])\.\d{1-9} \d{1-9})"/> </restriction> </simpleType> </pre>						

simpleType JaLeer

namespace	http://xml.ir-d.de/irdsaa						
type	restriction of integer						
properties	base xs:integer						
facets	<table border="1"> <thead> <tr> <th>Kind</th> <th>Value</th> <th>Annotation</th> </tr> </thead> <tbody> <tr> <td>pattern</td> <td>(1)</td> <td></td> </tr> </tbody> </table>	Kind	Value	Annotation	pattern	(1)	
Kind	Value	Annotation					
pattern	(1)						
annotation	documentation Facette zur Festlegung des Unbekannt-Wertes (Bedeutung 1=true)						
source	<pre> <simpleType name="JaLeer"> <annotation> <documentation>Facette zur Festlegung des Unbekannt-Wertes (Bedeutung 1=true)</documentation> </annotation> <restriction base="xs:integer"> <pattern value="(1)"/> </restriction> </simpleType> </pre>						

simpleType Meldebestaetigung

namespace	http://xml.ir-d.de/irdsaa						
type	restriction of token						
properties	base xs:token						
facets	<table border="1"> <thead> <tr> <th>Kind</th> <th>Value</th> <th>Annotation</th> </tr> </thead> <tbody> <tr> <td>length</td> <td>10</td> <td></td> </tr> </tbody> </table>	Kind	Value	Annotation	length	10	
Kind	Value	Annotation					
length	10						

annotation	documentation Facette zur Festlegung der Meldebestätigungslaenge von 10 Zeichen
source	<pre><simpleType name="Meldebestaetigung"> <annotation> <documentation>Facette zur Festlegung der Meldebestätigungslaenge von 10 Zeichen</documentation> </annotation> <restriction base="xs:token"> <length value="10"/> </restriction> </simpleType></pre>

simpleType OPS

namespace	http://xml.ir-d.de/irdsaa						
type	restriction of token						
properties	base xs:token						
facets	<table border="1"> <thead> <tr> <th>Kind</th> <th>Value</th> <th>Annotation</th> </tr> </thead> <tbody> <tr> <td>pattern</td> <td>(([135689]\-([0-9]){2}([a-zA-Z0-9]){1}\.([a-zA-Z0-9]{1,2}))*(:[RLBr1b])?)</td> <td></td> </tr> </tbody> </table>	Kind	Value	Annotation	pattern	(([135689]\-([0-9]){2}([a-zA-Z0-9]){1}\.([a-zA-Z0-9]{1,2}))*(:[RLBr1b])?)	
Kind	Value	Annotation					
pattern	(([135689]\-([0-9]){2}([a-zA-Z0-9]){1}\.([a-zA-Z0-9]{1,2}))*(:[RLBr1b])?)						
annotation	documentation Facette zur Festlegung des Prozedurenschluessels						
source	<pre><simpleType name="OPS"> <annotation> <documentation>Facette zur Festlegung des Prozedurenschluessels</documentation> </annotation> <restriction base="xs:token"> <pattern value="([135689]\-([0-9]){2}([a-zA-Z0-9]){1}\.([a-zA-Z0-9]{1,2}))*(:[RLBr1b] ?)"/> </restriction> </simpleType></pre>						

simpleType String2

namespace	http://xml.ir-d.de/irdsaa						
type	restriction of token						
properties	base xs:token						
facets	<table border="1"> <thead> <tr> <th>Kind</th> <th>Value</th> <th>Annotation</th> </tr> </thead> <tbody> <tr> <td>pattern</td> <td>([0-9]{2})</td> <td></td> </tr> </tbody> </table>	Kind	Value	Annotation	pattern	([0-9]{2})	
Kind	Value	Annotation					
pattern	([0-9]{2})						
annotation	documentation Facette zur Festlegung des kodierten Entlassungsgrundes						
source	<pre><simpleType name="String2"> <annotation> <documentation>Facette zur Festlegung des kodierten Entlassungsgrundes</documentation> </annotation> <restriction base="xs:token"> <pattern value="([0-9]{2})"/> </restriction> </simpleType></pre>						

simpleType **String20**

namespace	http://xml.ir-d.de/irdsaa						
type	restriction of token						
properties	base xs:token						
facets	<table border="1"> <thead> <tr> <th>Kind</th> <th>Value</th> <th>Annotation</th> </tr> </thead> <tbody> <tr> <td>maxLength</td> <td>20</td> <td></td> </tr> </tbody> </table>	Kind	Value	Annotation	maxLength	20	
Kind	Value	Annotation					
maxLength	20						
annotation	documentation Facette zur Festlegung von: Artikel-, Ident-, Serien-, Lot-Nummer des Produkts						
source	<pre><simpleType name="String20"> <annotation> <documentation>Facette zur Festlegung von: Artikel-, Ident-, Serien-, Lot-Nummer des Produkts</documentation> </annotation> <restriction base="xs:token"> <maxLength value="20"/> </restriction> </simpleType></pre>						

simpleType **Sw**

namespace	http://xml.ir-d.de/irdsaa						
type	restriction of token						
properties	base xs:token						
facets	<table border="1"> <thead> <tr> <th>Kind</th> <th>Value</th> <th>Annotation</th> </tr> </thead> <tbody> <tr> <td>maxLength</td> <td>120</td> <td></td> </tr> </tbody> </table>	Kind	Value	Annotation	maxLength	120	
Kind	Value	Annotation					
maxLength	120						
annotation	documentation Facette für Merkmale der externen Software						
source	<pre><simpleType name="Sw"> <annotation> <documentation>Facette für Merkmale der externen Software</documentation> </annotation> <restriction base="xs:token"> <maxLength value="120"/> </restriction> </simpleType></pre>						

simpleType **Transfnummer**

namespace	http://xml.ir-d.de/irdsaa						
type	restriction of token						
properties	base xs:token						
used by	element SelbstauskunftFallBasis/FAL Transfnummer						
facets	<table border="1"> <thead> <tr> <th>Kind</th> <th>Value</th> <th>Annotation</th> </tr> </thead> <tbody> <tr> <td>pattern</td> <td>([a-z0-9]{64})</td> <td></td> </tr> </tbody> </table>	Kind	Value	Annotation	pattern	([a-z0-9]{64})	
Kind	Value	Annotation					
pattern	([a-z0-9]{64})						
annotation	documentation Facette zur Festlegung der Transfnummer						
source	<pre><simpleType name="Transfnummer"> <annotation></pre>						

	<pre> <documentation>Facette zur Festlegung der Transfervummer</documentation> </annotation> <restriction base="xs:token"> <pattern value="([a-z0-9]{64})"/> </restriction> </simpleType> </pre>
--	--

simpleType **Versionsnummer**

namespace	http://xml.ir-d.de/irdsaa						
type	restriction of token						
properties	base xs:token						
facets	<table border="1"> <thead> <tr> <th>Kind</th> <th>Value</th> <th>Annotation</th> </tr> </thead> <tbody> <tr> <td>maxLength</td> <td>10</td> <td></td> </tr> </tbody> </table>	Kind	Value	Annotation	maxLength	10	
Kind	Value	Annotation					
maxLength	10						
annotation	documentation Facette zur Festlegung der Versionsnummer des gelieferten Datensatzes						
source	<pre> <simpleType name="Versionsnummer"> <annotation> <documentation>Facette zur Festlegung der Versionsnummer des gelieferten Datensatzes</documentation> </annotation> <restriction base="xs:token"> <maxLength value="10"/> </restriction> </simpleType> </pre>						

simpleType **Zahl1**

namespace	http://xml.ir-d.de/irdsaa									
type	restriction of positiveInteger									
properties	base xs:positiveInteger									
facets	<table border="1"> <thead> <tr> <th>Kind</th> <th>Value</th> <th>Annotation</th> </tr> </thead> <tbody> <tr> <td>minInclusive</td> <td>1</td> <td></td> </tr> <tr> <td>maxInclusive</td> <td>9</td> <td></td> </tr> </tbody> </table>	Kind	Value	Annotation	minInclusive	1		maxInclusive	9	
Kind	Value	Annotation								
minInclusive	1									
maxInclusive	9									
annotation	documentation Facette zur Festlegung der 1-stelligen Ganzzahlenwerte									
source	<pre> <simpleType name="Zahl1"> <annotation> <documentation>Facette zur Festlegung der 1-stelligen Ganzzahlenwerte</documentation> </annotation> <restriction base="xs:positiveInteger"> <minInclusive value="1"/> <maxInclusive value="9"/> </restriction> </simpleType> </pre>									

simpleType **Zahl1_1**

namespace	http://xml.ir-d.de/irdsaa
type	restriction of decimal

properties	base xs:decimal															
facets	<table border="1"> <thead> <tr> <th>Kind</th> <th>Value</th> <th>Annotation</th> </tr> </thead> <tbody> <tr> <td>minExclusive</td> <td>0</td> <td></td> </tr> <tr> <td>maxExclusive</td> <td>10</td> <td></td> </tr> <tr> <td>totalDigits</td> <td>1</td> <td></td> </tr> <tr> <td>fractionDigits</td> <td>1</td> <td></td> </tr> </tbody> </table>	Kind	Value	Annotation	minExclusive	0		maxExclusive	10		totalDigits	1		fractionDigits	1	
Kind	Value	Annotation														
minExclusive	0															
maxExclusive	10															
totalDigits	1															
fractionDigits	1															
annotation	documentation Facette zur Festlegung des Formats [N].[N]															
source	<pre><simpleType name="Zahl1_1"> <annotation> <documentation>Facette zur Festlegung des Formats [N].[N]</documentation> </annotation> <restriction base="xs:decimal"> <totalDigits value="1"/> <fractionDigits value="1"/> <minExclusive value="0"/> <maxExclusive value="10"/> </restriction> </simpleType></pre>															

simpleType Zahl2

namespace	http://xml.ir-d.de/irdsaa									
type	restriction of positiveInteger									
properties	base xs:positiveInteger									
facets	<table border="1"> <thead> <tr> <th>Kind</th> <th>Value</th> <th>Annotation</th> </tr> </thead> <tbody> <tr> <td>minInclusive</td> <td>1</td> <td></td> </tr> <tr> <td>maxInclusive</td> <td>99</td> <td></td> </tr> </tbody> </table>	Kind	Value	Annotation	minInclusive	1		maxInclusive	99	
Kind	Value	Annotation								
minInclusive	1									
maxInclusive	99									
annotation	documentation Facette zur Festlegung der 2-stelligen Ganzzahlenwerte									
source	<pre><simpleType name="Zahl2"> <annotation> <documentation>Facette zur Festlegung der 2-stelligen Ganzzahlenwerte</documentation> </annotation> <restriction base="xs:positiveInteger"> <minInclusive value="1"/> <maxInclusive value="99"/> </restriction> </simpleType></pre>									

simpleType Zahl2_1

namespace	http://xml.ir-d.de/irdsaa															
type	restriction of decimal															
properties	base xs:decimal															
facets	<table border="1"> <thead> <tr> <th>Kind</th> <th>Value</th> <th>Annotation</th> </tr> </thead> <tbody> <tr> <td>minExclusive</td> <td>0</td> <td></td> </tr> <tr> <td>maxExclusive</td> <td>100</td> <td></td> </tr> <tr> <td>totalDigits</td> <td>2</td> <td></td> </tr> <tr> <td>fractionDigits</td> <td>1</td> <td></td> </tr> </tbody> </table>	Kind	Value	Annotation	minExclusive	0		maxExclusive	100		totalDigits	2		fractionDigits	1	
Kind	Value	Annotation														
minExclusive	0															
maxExclusive	100															
totalDigits	2															
fractionDigits	1															

annotation	documentation Facette zur Festlegung des Formats [NN].[N]
source	<pre><simpleType name="Zahl2_1"> <annotation> <documentation>Facette zur Festlegung des Formats [NN].[N]</documentation> </annotation> <restriction base="xs:decimal"> <totalDigits value="2"/> <fractionDigits value="1"/> <minExclusive value="0"/> <maxExclusive value="100"/> </restriction> </simpleType></pre>

simpleType Zahl3

namespace	http://xml.ir-d.de/irdsaa									
type	restriction of positiveInteger									
properties	base xs:positiveInteger									
facets	<table border="1"> <thead> <tr> <th>Kind</th> <th>Value</th> <th>Annotation</th> </tr> </thead> <tbody> <tr> <td>minInclusive</td> <td>1</td> <td></td> </tr> <tr> <td>maxInclusive</td> <td>999</td> <td></td> </tr> </tbody> </table>	Kind	Value	Annotation	minInclusive	1		maxInclusive	999	
Kind	Value	Annotation								
minInclusive	1									
maxInclusive	999									
annotation	documentation Facette zur Festlegung der 3-stelligen Ganzzahlenwerte									
source	<pre><simpleType name="Zahl3"> <annotation> <documentation>Facette zur Festlegung der 3-stelligen Ganzzahlenwerte</documentation> </annotation> <restriction base="xs:positiveInteger"> <minInclusive value="1"/> <maxInclusive value="999"/> </restriction> </simpleType></pre>									

simpleType Zahl3_1

namespace	http://xml.ir-d.de/irdsaa															
type	restriction of decimal															
properties	base xs:decimal															
facets	<table border="1"> <thead> <tr> <th>Kind</th> <th>Value</th> <th>Annotation</th> </tr> </thead> <tbody> <tr> <td>minExclusive</td> <td>0</td> <td></td> </tr> <tr> <td>maxExclusive</td> <td>1000</td> <td></td> </tr> <tr> <td>totalDigits</td> <td>3</td> <td></td> </tr> <tr> <td>fractionDigits</td> <td>1</td> <td></td> </tr> </tbody> </table>	Kind	Value	Annotation	minExclusive	0		maxExclusive	1000		totalDigits	3		fractionDigits	1	
Kind	Value	Annotation														
minExclusive	0															
maxExclusive	1000															
totalDigits	3															
fractionDigits	1															
annotation	documentation Facette zur Festlegung des Formats [NNN].[N]															
source	<pre><simpleType name="Zahl3_1"> <annotation> <documentation>Facette zur Festlegung des Formats [NNN].[N]</documentation> </annotation> <restriction base="xs:decimal"></pre>															

	<pre> <totalDigits value="3"/> <fractionDigits value="1"/> <minExclusive value="0"/> <maxExclusive value="1000"/> </restriction> </simpleType> </pre>
--	---

simpleType **Zahl4**

namespace	http://xml.ir-d.de/irdsaa									
type	restriction of positivelnteger									
properties	base xs:positivelnteger									
facets	<table border="1"> <thead> <tr> <th>Kind</th> <th>Value</th> <th>Annotation</th> </tr> </thead> <tbody> <tr> <td>minInclusive</td> <td>1</td> <td></td> </tr> <tr> <td>maxInclusive</td> <td>9999</td> <td></td> </tr> </tbody> </table>	Kind	Value	Annotation	minInclusive	1		maxInclusive	9999	
Kind	Value	Annotation								
minInclusive	1									
maxInclusive	9999									
annotation	documentation Facette zur Festlegung der 4-stelligen Ganzzahlenwerte									
source	<pre> <simpleType name="Zahl4"> <annotation> <documentation>Facette zur Festlegung der 4-stelligen Ganzzahlenwerte</documentation> </annotation> <restriction base="xs:positiveInteger"> <minInclusive value="1"/> <maxInclusive value="9999"/> </restriction> </simpleType> </pre>									

simpleType **Zahl5**

namespace	http://xml.ir-d.de/irdsaa									
type	restriction of positivelnteger									
properties	base xs:positivelnteger									
facets	<table border="1"> <thead> <tr> <th>Kind</th> <th>Value</th> <th>Annotation</th> </tr> </thead> <tbody> <tr> <td>minInclusive</td> <td>1</td> <td></td> </tr> <tr> <td>maxInclusive</td> <td>99999</td> <td></td> </tr> </tbody> </table>	Kind	Value	Annotation	minInclusive	1		maxInclusive	99999	
Kind	Value	Annotation								
minInclusive	1									
maxInclusive	99999									
annotation	documentation Facette zur Festlegung der 5-stelligen Ganzzahlenwerte									
source	<pre> <simpleType name="Zahl5"> <annotation> <documentation>Facette zur Festlegung der 5-stelligen Ganzzahlenwerte</documentation> </annotation> <restriction base="xs:positiveInteger"> <minInclusive value="1"/> <maxInclusive value="99999"/> </restriction> </simpleType> </pre>									

complexType MeldungIrdBasis

diagram	
namespace	http://xml.ir-d.de/irdsaa
children	MEL_IrdIdGesundheitseinrichtung
used by	complexType Selbstauskunft
source	<pre><complexType name="MeldungIrdBasis"> <sequence> <element name="MEL_IrdIdGesundheitseinrichtung" type="IdEinrichtung"/> </sequence> </complexType></pre>

element MeldungIrdBasis/MEL_IrdIdGesundheitseinrichtung

diagram							
type	IdEinrichtung						
properties	content simple						
facets	<table border="1"> <thead> <tr> <th>Kind</th> <th>Value</th> <th>Annotation</th> </tr> </thead> <tbody> <tr> <td>pattern</td> <td>(IRD-GE-[0-9]{8})</td> <td></td> </tr> </tbody> </table>	Kind	Value	Annotation	pattern	(IRD-GE-[0-9]{8})	
Kind	Value	Annotation					
pattern	(IRD-GE-[0-9]{8})						
source	<pre><element name="MEL_IrdIdGesundheitseinrichtung" type="IdEinrichtung"/></pre>						

complexType SelbstauskunftFallBasis

diagram	
namespace	http://xml.ir-d.de/irdsaa
children	FAL_Transfernummer
used by	element Selbstauskunft/fall
source	<pre><complexType name="SelbstauskunftFallBasis"> <sequence> <element name="FAL_Transfernummer" type="Transfernummer"/> </sequence> </complexType></pre>

element SelbstauskunftFallBasis/FAL_Transfernummer

diagram	
---------	--

type	Transfervummer						
properties	content simple						
facets	<table border="1"> <thead> <tr> <th>Kind</th> <th>Value</th> <th>Annotation</th> </tr> </thead> <tbody> <tr> <td>pattern</td> <td>([a-z0-9]{64})</td> <td></td> </tr> </tbody> </table>	Kind	Value	Annotation	pattern	([a-z0-9]{64})	
Kind	Value	Annotation					
pattern	([a-z0-9]{64})						
source	<element name="FAL_Transfervummer" type="Transfervummer"/>						

simpleType DatumText

namespace	http://xml.ir-d.de/emg						
type	restriction of token						
properties	base xs:token						
used by	element ArtikelbeschreibungBasis/ARB Datumimplantierung Explantat						
facets	<table border="1"> <thead> <tr> <th>Kind</th> <th>Value</th> <th>Annotation</th> </tr> </thead> <tbody> <tr> <td>pattern</td> <td>(([0-9]{4})([0-9]{2})?([0-9]{2})?)</td> <td></td> </tr> </tbody> </table>	Kind	Value	Annotation	pattern	(([0-9]{4})([0-9]{2})?([0-9]{2})?)	
Kind	Value	Annotation					
pattern	(([0-9]{4})([0-9]{2})?([0-9]{2})?)						
annotation	documentation Facette zur Festlegung des freien Datumformats: JJJJ[-MM[-TT]]						
source	<pre><simpleType name="DatumText"> <annotation> <documentation>Facette zur Festlegung des freien Datumformats: JJJJ[-MM[-TT]]</documentation> </annotation> <restriction base="xs:token"> <pattern value="((([0-9]{4})([0-9]{2})?([0-9]{2})?)")"/> </restriction> </simpleType></pre>						

simpleType Freitext250

namespace	http://xml.ir-d.de/emg						
type	restriction of token						
properties	base xs:token						
used by	elements ArtikelAortenklappeBasis/AAK HerstellerSonstiger ArtikelBrustimplantatBasis/ABI HerstellerSonstiger ArtikelEndoprotheseBasis/AEP HerstellerSonstiger ArtikelbeschreibungBasis/ARB Artikelbezeichnung OperationEndoprotheseBasis/OEP GrundWechselErlaeuterung VorbehandlungEndoprotheseBasis/VEP VorOpErlaeuterung ZubehoerBrustimplantatBasis/ZBI HerstellerSonstiger ZubehoerEndoprotheseBasis/ZEP HerstellerSonstiger ZubehoerBasis/ZUB Artikelbezeichnung						
facets	<table border="1"> <thead> <tr> <th>Kind</th> <th>Value</th> <th>Annotation</th> </tr> </thead> <tbody> <tr> <td>maxLength</td> <td>250</td> <td></td> </tr> </tbody> </table>	Kind	Value	Annotation	maxLength	250	
Kind	Value	Annotation					
maxLength	250						
annotation	documentation Facette zur Festlegung des Freitextes von 250 Zeichen						
source	<pre><simpleType name="Freitext250"> <annotation> <documentation>Facette zur Festlegung des Freitextes von 250 Zeichen</documentation> </annotation> <restriction base="xs:token"> <maxLength value="250"/> </restriction> </simpleType></pre>						

	<code></simpleType></code>
--	----------------------------------

simpleType **Freitext500**

namespace	http://xml.ir-d.de/emg						
type	restriction of token						
properties	base xs:token						
facets	<table border="1"> <thead> <tr> <th>Kind</th> <th>Value</th> <th>Annotation</th> </tr> </thead> <tbody> <tr> <td>maxLength</td> <td>500</td> <td></td> </tr> </tbody> </table>	Kind	Value	Annotation	maxLength	500	
Kind	Value	Annotation					
maxLength	500						
annotation	documentation Facette zur Festlegung des Freitextes von 500 Zeichen						
source	<pre><simpleType name="Freitext500"> <annotation> <documentation>Facette zur Festlegung des Freitextes von 500 Zeichen</documentation> </annotation> <restriction base="xs:token"> <maxLength value="500"/> </restriction> </simpleType></pre>						

simpleType **HashString**

namespace	http://xml.ir-d.de/emg						
type	restriction of token						
properties	base xs:token						
facets	<table border="1"> <thead> <tr> <th>Kind</th> <th>Value</th> <th>Annotation</th> </tr> </thead> <tbody> <tr> <td>maxLength</td> <td>512</td> <td></td> </tr> </tbody> </table>	Kind	Value	Annotation	maxLength	512	
Kind	Value	Annotation					
maxLength	512						
annotation	documentation Facette zur Festlegung des Hash-Strings der Meldebestätigung						
source	<pre><simpleType name="HashString"> <annotation> <documentation>Facette zur Festlegung des Hash-Strings der Meldebestätigung</documentation> </annotation> <restriction base="xs:token"> <maxLength value="512"/> </restriction> </simpleType></pre>						

simpleType **HashWert**

namespace	http://xml.ir-d.de/emg						
type	restriction of token						
properties	base xs:token						
facets	<table border="1"> <thead> <tr> <th>Kind</th> <th>Value</th> <th>Annotation</th> </tr> </thead> <tbody> <tr> <td>length</td> <td>64</td> <td></td> </tr> </tbody> </table>	Kind	Value	Annotation	length	64	
Kind	Value	Annotation					
length	64						
annotation	documentation Facette zur Festlegung des Hashwertes der Meldebestätigung						
source	<pre><simpleType name="HashWert"></pre>						

	<pre> <annotation> <documentation>Facette zur Festlegung des Hashwertes der Meldebestätigung</documentation> </annotation> <restriction base="xs:token"> <length value="64"/> </restriction> </simpleType> </pre>
--	---

simpleType ICD

namespace	http://xml.ir-d.de/emg						
type	restriction of token						
properties	base xs:token						
used by	elements DiagnoseAortenklappeBasis/DAK IcdSchluessel DiagnoseBrustimplantatBasis/DBI IcdSchluessel DiagnoseEndoprotheseBasis/DEP IcdSchluessel						
facets	<table border="1"> <thead> <tr> <th>Kind</th> <th>Value</th> <th>Annotation</th> </tr> </thead> <tbody> <tr> <td>pattern</td> <td>([a-zA-Z][0-9]{2}(\.[0-9]{1,2})?(:[RLB])?)</td> <td></td> </tr> </tbody> </table>	Kind	Value	Annotation	pattern	([a-zA-Z][0-9]{2}(\.[0-9]{1,2})?(:[RLB])?)	
Kind	Value	Annotation					
pattern	([a-zA-Z][0-9]{2}(\.[0-9]{1,2})?(:[RLB])?)						
annotation	documentation Facette zur Festlegung des ICD Code						
source	<pre> <simpleType name="ICD"> <annotation> <documentation>Facette zur Festlegung des ICD Code</documentation> </annotation> <restriction base="xs:token"> <pattern value="([a-zA-Z][0-9]{2}(\.[0-9]{1,2})?(:[RLB])?)"/> </restriction> </simpleType> </pre>						

simpleType IdEinrichtung

namespace	http://xml.ir-d.de/emg						
type	restriction of token						
properties	base xs:token						
used by	element MeldungBasis/MEL IrdIdGesundheitseinrichtung						
facets	<table border="1"> <thead> <tr> <th>Kind</th> <th>Value</th> <th>Annotation</th> </tr> </thead> <tbody> <tr> <td>pattern</td> <td>(IRD-GE-[0-9]{8})</td> <td></td> </tr> </tbody> </table>	Kind	Value	Annotation	pattern	(IRD-GE-[0-9]{8})	
Kind	Value	Annotation					
pattern	(IRD-GE-[0-9]{8})						
annotation	documentation Facette zur Festlegung der Gesundheitseinrichtung-ID						
source	<pre> <simpleType name="IdEinrichtung"> <annotation> <documentation>Facette zur Festlegung der Gesundheitseinrichtung-ID</documentation> </annotation> <restriction base="xs:token"> <pattern value="(IRD-GE-[0-9]{8})"/> </restriction> </simpleType> </pre>						

simpleType IrdArtikelId

namespace	http://xml.ir-d.de/emg
type	restriction of token
properties	base xs:token
used by	element ArtikelidentifikationBasis/ARI IrdNummer
facets	Kind Value Annotation maxLength 16
annotation	documentation Facette zur Festlegung der IrdNummer
source	<pre><simpleType name="IrdArtikelId"> <annotation> <documentation>Facette zur Festlegung der IrdNummer</documentation> </annotation> <restriction base="xs:token"> <maxLength value="16"/> </restriction> </simpleType></pre>

simpleType IrdSpezVersion

namespace	http://xml.ir-d.de/emg
type	restriction of token
properties	base xs:token
used by	element MeldungBasis/MEL IrdSpezVersion
facets	Kind Value Annotation pattern (([1-9] [1-9][0-9])\.\d{1}[0-9])\.\d{1}[0-9])
annotation	documentation Facette zur Festlegung der Version der IRD-Spezifikation
source	<pre><simpleType name="IrdSpezVersion"> <annotation> <documentation>Facette zur Festlegung der Version der IRD-Spezifikation</documentation> </annotation> <restriction base="xs:token"> <pattern value="(([1-9] [1-9][0-9])\.\d{1}[0-9])\.\d{1}[0-9]"/> </restriction> </simpleType></pre>

simpleType JaLeer

namespace	http://xml.ir-d.de/emg
type	restriction of integer
properties	base xs:integer
used by	elements ArtikelAortenklappeBasis/AAK Dislokation ArtikelAortenklappeBasis/AAK HerstellerUnbekannt ArtikelAortenklappeBasis/AAK ProthesenGroesseUnbekannt ArtikelBrustimplantatBasis/ABI FormUnbekannt ArtikelBrustimplantatBasis/ABI FuellungUnbekannt ArtikelBrustimplantatBasis/ABI HerstellerUnbekannt ArtikelBrustimplantatBasis/ABI OberflaecheUnbekannt ArtikelBrustimplantatBasis/ABI VolumenUnbekannt ArtikelEndoprotheseBasis/AEP HerstellerUnbekannt

	ArtikelbeschreibungBasis/ARB DatumImplantierung ExplantatUnbekannt ArtikelbeschreibungBasis/ARB DatumVerfallUnbekannt ArtikelbeschreibungBasis/ARB LotNummerUnbekannt ArtikelbeschreibungBasis/ARB SerienNummerUnbekannt ArtikelidentifikationBasis/ARI ArtikelkennzeichenUnbekannt OperationAortenklappeBasis/OAK AbklemmzeitUnbekannt OperationAortenklappeBasis/OAK BypasszeitUnbekannt OperationAortenklappeBasis/OAK DeltaPmeanNachOpUnbekannt OperationAortenklappeBasis/OAK DistanzLcaUnbekannt OperationAortenklappeBasis/OAK DistanzRcaUnbekannt OperationAortenklappeBasis/OAK PtcaNachDurchmesserUnbekannt OperationAortenklappeBasis/OAK PtcaVorDurchmesserUnbekannt OperationAortenklappeBasis/OAK ZugangsGefaessUnbekannt PatientenaufnahmeAortenklappeBasis/PAA AkoefUnbekannt PatientenaufnahmeAortenklappeBasis/PAA CtCalciumUnbekannt PatientenaufnahmeAortenklappeBasis/PAA DeltaPmaxUnbekannt PatientenaufnahmeAortenklappeBasis/PAA DeltaPmeanUnbekannt PatientenaufnahmeAortenklappeBasis/PAA DeltaPUnbekannt PatientenaufnahmeKardiologieBasis/PKA KreatininwertUnbekannt PatientenaufnahmeKardiologieBasis/PKA LvefUnbekannt PostoperationAortenklappeBasis/POA AkoefUnbekannt PostoperationAortenklappeBasis/POA DeltaPmaxUnbekannt PostoperationAortenklappeBasis/POA DeltaPmeanUnbekannt PostoperationAortenklappeBasis/POA LvefUnbekannt PostoperationAortenklappeBasis/POA MaxKreatininUnbekannt ZubehoerBrustimplantatBasis/ZBI HerstellerUnbekannt ZubehoerEndoprotheseBasis/ZEP HerstellerUnbekannt ZubehoerBasis/ZUB ArtikelNummerUnbekannt ZubehoerBasis/ZUB LotNummerUnbekannt ZubehoerBasis/ZUB SerienNummerUnbekannt
facets	Kind Value Annotation pattern (1)
annotation	documentation Facette zur Festlegung des Unbekannt-Wertes (Bedeutung 1=true)
source	<pre><simpleType name="JaLeer"> <annotation> <documentation>Facette zur Festlegung des Unbekannt-Wertes (Bedeutung 1=true)</documentation> </annotation> <restriction base="xs:integer"> <pattern value="(1)"/> </restriction> </simpleType></pre>

simpleType **Meldebestaetigung**

namespace	http://xml.ir-d.de/emg
type	restriction of token
properties	base xs:token
facets	Kind Value Annotation length 10
annotation	documentation Facette zur Festlegung der Meldebestätigungslaenge von 10 Zeichen
source	<pre><simpleType name="Meldebestaetigung"> <annotation> <documentation>Facette zur Festlegung der Meldebestätigungslaenge von 10 Zeichen</documentation> </annotation> <restriction base="xs:token"></pre>

	<pre><length value="10"/> </restriction> </simpleType></pre>
--	--

simpleType OPS

namespace	http://xml.ir-d.de/emg
type	restriction of token
properties	base xs:token
used by	elements AusloeserBasis/ALR_ProzedurenSchluessel ProzedurenSchluesselAortenklappeBasis/PAK_ProzedurenSchluessel ProzedurenSchluesselBrustimplantatBasis/PBI_ProzedurenSchluessel ProzedurenSchluesselEndoprotheseBasis/PEP_ProzedurenSchluessel
facets	Kind Value Annotation pattern ((135689)\-([0-9]){2}([a-zA-Z0-9]){1}\.([a-zA-Z0-9]{1,2}))*(:[RLBr1b])?)
annotation	documentation Facette zur Festlegung des Prozedurenschlüssels
source	<pre><simpleType name="OPS"> <annotation> <documentation>Facette zur Festlegung des Prozedurenschlüssels</documentation> </annotation> <restriction base="xs:token"> <pattern value="((135689)\-([0-9]){2}([a-zA-Z0-9]){1}\.([a-zA-Z0-9]{1,2}))*(:[RLBr1b]) ?)"/> </restriction> </simpleType></pre>

simpleType String2

namespace	http://xml.ir-d.de/emg
type	restriction of token
properties	base xs:token
used by	element EntlassungBasis/ENT_GrundSchluessel
facets	Kind Value Annotation pattern ([0-9]{2})
annotation	documentation Facette zur Festlegung des kodierten Entlassungsgrundes
source	<pre><simpleType name="String2"> <annotation> <documentation>Facette zur Festlegung des kodierten Entlassungsgrundes</documentation> </annotation> <restriction base="xs:token"> <pattern value="([0-9]{2})"/> </restriction> </simpleType></pre>

simpleType String20

namespace	http://xml.ir-d.de/emg
type	restriction of token
properties	base xs:token
used by	elements ArtikelbeschreibungBasis/ARB DatumVerfall ArtikelbeschreibungBasis/ARB LotNummer ArtikelbeschreibungBasis/ARB SerienNummer ArtikelidentifikationBasis/ARI Artikelkennzeichen ZubehoerBasis/ZUB ArtikelNummer ZubehoerBasis/ZUB LotNummer ZubehoerBasis/ZUB SerienNummer
facets	Kind Value Annotation maxLength 20
annotation	documentation Facette zur Festlegung von: Artikel-, Ident-, Serien-, Lot-Nummer des Produkts
source	<pre><simpleType name="String20"> <annotation> <documentation>Facette zur Festlegung von: Artikel-, Ident-, Serien-, Lot-Nummer des Produkts</documentation> </annotation> <restriction base="xs:token"> <maxLength value="20"/> </restriction> </simpleType></pre>

simpleType Sw

namespace	http://xml.ir-d.de/emg
type	restriction of token
properties	base xs:token
used by	elements MeldungBasis/MEL SwHersteller MeldungBasis/MEL SwName MeldungBasis/MEL SwVersion
facets	Kind Value Annotation maxLength 120
annotation	documentation Facette für Merkmale der externen Software
source	<pre><simpleType name="Sw"> <annotation> <documentation>Facette für Merkmale der externen Software</documentation> </annotation> <restriction base="xs:token"> <maxLength value="120"/> </restriction> </simpleType></pre>

simpleType Transfernummer

namespace	http://xml.ir-d.de/emg
type	restriction of token
properties	base xs:token
used by	element FallBasis/FAL Transfernummer
facets	Kind Value Annotation pattern ([a-z0-9]{64})

annotation	documentation Facette zur Festlegung der Transferrnummer
source	<pre><simpleType name="Transferrnummer"> <annotation> <documentation>Facette zur Festlegung der Transferrnummer</documentation> </annotation> <restriction base="xs:token"> <pattern value="[a-z0-9]{64}"/> </restriction> </simpleType></pre>

simpleType Versionsnummer

namespace	http://xml.ir-d.de/emg						
type	restriction of token						
properties	base xs:token						
used by	element FallBasis/FAL Versionsnummer						
facets	<table border="1"> <thead> <tr> <th>Kind</th> <th>Value</th> <th>Annotation</th> </tr> </thead> <tbody> <tr> <td>maxLength</td> <td>10</td> <td></td> </tr> </tbody> </table>	Kind	Value	Annotation	maxLength	10	
Kind	Value	Annotation					
maxLength	10						
annotation	documentation Facette zur Festlegung der Versionsnummer des gelieferten Datensatzes						
source	<pre><simpleType name="Versionsnummer"> <annotation> <documentation>Facette zur Festlegung der Versionsnummer des gelieferten Datensatzes</documentation> </annotation> <restriction base="xs:token"> <maxLength value="10"/> </restriction> </simpleType></pre>						

simpleType Zahl1

namespace	http://xml.ir-d.de/emg									
type	restriction of positiveInteger									
properties	base xs:positiveInteger									
used by	elements OperationAortenklappeBasis/OAK LaesionenAnzahl OperationAortenklappeBasis/OAK ProzedurenAnzahl									
facets	<table border="1"> <thead> <tr> <th>Kind</th> <th>Value</th> <th>Annotation</th> </tr> </thead> <tbody> <tr> <td>minInclusive</td> <td>1</td> <td></td> </tr> <tr> <td>maxInclusive</td> <td>9</td> <td></td> </tr> </tbody> </table>	Kind	Value	Annotation	minInclusive	1		maxInclusive	9	
Kind	Value	Annotation								
minInclusive	1									
maxInclusive	9									
annotation	documentation Facette zur Festlegung der 1-stelligen Ganzzahlenwerte									
source	<pre><simpleType name="Zahl1"> <annotation> <documentation>Facette zur Festlegung der 1-stelligen Ganzzahlenwerte</documentation> </annotation> <restriction base="xs:positiveInteger"> <minInclusive value="1"/> <maxInclusive value="9"/> </restriction></pre>									

	<code></simpleType></code>
--	----------------------------------

simpleType Zahl1_1

namespace	http://xml.ir-d.de/emg															
type	restriction of decimal															
properties	base xs:decimal															
used by	elements OperationAortenklappeBasis/OAK Zugangsgefaessdiameter PatientenaufnahmeAortenklappeBasis/PAA Akoef PostoperationAortenklappeBasis/POA Akoef															
facets	<table border="1"> <thead> <tr> <th>Kind</th> <th>Value</th> <th>Annotation</th> </tr> </thead> <tbody> <tr> <td>minExclusive</td> <td>0</td> <td></td> </tr> <tr> <td>maxExclusive</td> <td>10</td> <td></td> </tr> <tr> <td>totalDigits</td> <td>1</td> <td></td> </tr> <tr> <td>fractionDigits</td> <td>1</td> <td></td> </tr> </tbody> </table>	Kind	Value	Annotation	minExclusive	0		maxExclusive	10		totalDigits	1		fractionDigits	1	
Kind	Value	Annotation														
minExclusive	0															
maxExclusive	10															
totalDigits	1															
fractionDigits	1															
annotation	documentation Facette zur Festlegung des Formats [N].[N]															
source	<pre><simpleType name="Zahl1_1"> <annotation> <documentation>Facette zur Festlegung des Formats [N].[N]</documentation> </annotation> <restriction base="xs:decimal"> <totalDigits value="1"/> <fractionDigits value="1"/> <minExclusive value="0"/> <maxExclusive value="10"/> </restriction> </simpleType></pre>															

simpleType Zahl2

namespace	http://xml.ir-d.de/emg									
type	restriction of positiveInteger									
properties	base xs:positiveInteger									
used by	elements ArtikelAortenklappeBasis/AAK ProthesenGroesse OperationAortenklappeBasis/OAK AortenklappenOpAnzahl OperationAortenklappeBasis/OAK NummerEingriff OperationAortenklappeBasis/OAK PtcaNachAnzahl OperationAortenklappeBasis/OAK PtcaNachDurchmesser OperationAortenklappeBasis/OAK PtcaVorAnzahl OperationAortenklappeBasis/OAK PtcaVorDurchmesser									
facets	<table border="1"> <thead> <tr> <th>Kind</th> <th>Value</th> <th>Annotation</th> </tr> </thead> <tbody> <tr> <td>minInclusive</td> <td>1</td> <td></td> </tr> <tr> <td>maxInclusive</td> <td>99</td> <td></td> </tr> </tbody> </table>	Kind	Value	Annotation	minInclusive	1		maxInclusive	99	
Kind	Value	Annotation								
minInclusive	1									
maxInclusive	99									
annotation	documentation Facette zur Festlegung der 2-stelligen Ganzzahlenwerte									
source	<pre><simpleType name="Zahl2"> <annotation> <documentation>Facette zur Festlegung der 2-stelligen Ganzzahlenwerte</documentation> </annotation> <restriction base="xs:positiveInteger"> <minInclusive value="1"/> <maxInclusive value="99"/> </restriction> </simpleType></pre>									

	<pre> </restriction> </simpleType> </pre>
--	---

simpleType Zahl2_1

namespace	http://xml.ir-d.de/emg															
type	restriction of decimal															
properties	base xs:decimal															
used by	elements PatientenaufnahmeKardiologieBasis/PKA KreatininwertMqdl PostoperationAortenklappeBasis/POA MaxKreatininMqDI															
facets	<table border="1"> <thead> <tr> <th>Kind</th> <th>Value</th> <th>Annotation</th> </tr> </thead> <tbody> <tr> <td>minExclusive</td> <td>0</td> <td></td> </tr> <tr> <td>maxExclusive</td> <td>100</td> <td></td> </tr> <tr> <td>totalDigits</td> <td>2</td> <td></td> </tr> <tr> <td>fractionDigits</td> <td>1</td> <td></td> </tr> </tbody> </table>	Kind	Value	Annotation	minExclusive	0		maxExclusive	100		totalDigits	2		fractionDigits	1	
Kind	Value	Annotation														
minExclusive	0															
maxExclusive	100															
totalDigits	2															
fractionDigits	1															
annotation	documentation Facette zur Festlegung des Formats [NN].[N]															
source	<pre> <simpleType name="Zahl2_1"> <annotation> <documentation>Facette zur Festlegung des Formats [NN].[N]</documentation> </annotation> <restriction base="xs:decimal"> <totalDigits value="2"/> <fractionDigits value="1"/> <minExclusive value="0"/> <maxExclusive value="100"/> </restriction> </simpleType> </pre>															

simpleType Zahl3

namespace	http://xml.ir-d.de/emg									
type	restriction of positiveInteger									
properties	base xs:positiveInteger									
used by	elements ArtikelidentifikationBasis/ARI LaufendeNummer OperationAortenklappeBasis/OAK Abklemmzeit OperationAortenklappeBasis/OAK Aortenklappenannulus OperationAortenklappeBasis/OAK Bypasszeit OperationAortenklappeBasis/OAK DeltaPmeanNachOp OperationAortenklappeBasis/OAK DistanzLca OperationAortenklappeBasis/OAK DistanzRca OperationAortenklappeBasis/OAK Eingriffsdauer OperationBasis/OPE LaufendeNummer PatientenaufnahmeAortenklappeBasis/PAA DeltaP PatientenaufnahmeAortenklappeBasis/PAA DeltaPmax PatientenaufnahmeAortenklappeBasis/PAA DeltaPmean PatientenaufnahmeKardiologieBasis/PKA Lvef PostoperationAortenklappeBasis/POA DeltaPmax PostoperationAortenklappeBasis/POA DeltaPmean PostoperationAortenklappeBasis/POA IntensivDauer PostoperationAortenklappeBasis/POA Lvef ZubehoerBasis/ZUB LaufendeNummer									
facets	<table border="1"> <thead> <tr> <th>Kind</th> <th>Value</th> <th>Annotation</th> </tr> </thead> <tbody> <tr> <td>minInclusive</td> <td>1</td> <td></td> </tr> <tr> <td>maxInclusive</td> <td>999</td> <td></td> </tr> </tbody> </table>	Kind	Value	Annotation	minInclusive	1		maxInclusive	999	
Kind	Value	Annotation								
minInclusive	1									
maxInclusive	999									
annotation	documentation Facette zur Festlegung der 3-stelligen Ganzzahlenwerte									
source	<pre> <simpleType name="Zahl3"> </pre>									

	<pre> <annotation> <documentation>Facette zur Festlegung der 3-stelligen Ganzzahlenwerte</documentation> </annotation> <restriction base="xs:positiveInteger"> <minInclusive value="1"/> <maxInclusive value="999"/> </restriction> </simpleType> </pre>
--	--

simpleType **Zahl3_1**

namespace	http://xml.ir-d.de/emg															
type	restriction of decimal															
properties	base xs:decimal															
used by	elements OperationAortenklappeBasis/OAK Durchleuchtungszeit PatientenaufnahmeAortenklappeBasis/PAA StsScore															
facets	<table border="1"> <thead> <tr> <th>Kind</th> <th>Value</th> <th>Annotation</th> </tr> </thead> <tbody> <tr> <td>minExclusive</td> <td>0</td> <td></td> </tr> <tr> <td>maxExclusive</td> <td>1000</td> <td></td> </tr> <tr> <td>totalDigits</td> <td>3</td> <td></td> </tr> <tr> <td>fractionDigits</td> <td>1</td> <td></td> </tr> </tbody> </table>	Kind	Value	Annotation	minExclusive	0		maxExclusive	1000		totalDigits	3		fractionDigits	1	
Kind	Value	Annotation														
minExclusive	0															
maxExclusive	1000															
totalDigits	3															
fractionDigits	1															
annotation	documentation Facette zur Festlegung des Formats [NNN].[N]															
source	<pre> <simpleType name="Zahl3_1"> <annotation> <documentation>Facette zur Festlegung des Formats [NNN].[N]</documentation> </annotation> <restriction base="xs:decimal"> <totalDigits value="3"/> <fractionDigits value="1"/> <minExclusive value="0"/> <maxExclusive value="1000"/> </restriction> </simpleType> </pre>															

simpleType **Zahl4**

namespace	http://xml.ir-d.de/emg									
type	restriction of positiveInteger									
properties	base xs:positiveInteger									
used by	elements PatientenaufnahmeKardiologieBasis/PKA KreatininwertMikromol PostoperationAortenklappeBasis/POA MaxKreatininMikromol									
facets	<table border="1"> <thead> <tr> <th>Kind</th> <th>Value</th> <th>Annotation</th> </tr> </thead> <tbody> <tr> <td>minInclusive</td> <td>1</td> <td></td> </tr> <tr> <td>maxInclusive</td> <td>9999</td> <td></td> </tr> </tbody> </table>	Kind	Value	Annotation	minInclusive	1		maxInclusive	9999	
Kind	Value	Annotation								
minInclusive	1									
maxInclusive	9999									
annotation	documentation Facette zur Festlegung der 4-stelligen Ganzzahlenwerte									
source	<pre> <simpleType name="Zahl4"> <annotation> <documentation>Facette zur Festlegung der 4-stelligen Ganzzahlenwerte</documentation> </annotation> </simpleType> </pre>									

	<pre> </annotation> <restriction base="xs:positiveInteger"> <minInclusive value="1"/> <maxInclusive value="9999"/> </restriction> </simpleType> </pre>
--	--

simpleType **Zahl5**

namespace	http://xml.ir-d.de/emg									
type	restriction of positivelnteger									
properties	base xs:positiveInteger									
used by	elements ArtikelBrustimplantatBasis/ABI IntraoperativesVolumen ArtikelBrustimplantatBasis/ABI Volumen PatientenaufnahmeAortenklappeBasis/PAA CtCalcium ZubehoerEndoprotheseBasis/ZEP Menge									
facets	<table border="1"> <thead> <tr> <th>Kind</th> <th>Value</th> <th>Annotation</th> </tr> </thead> <tbody> <tr> <td>minInclusive</td> <td>1</td> <td></td> </tr> <tr> <td>maxInclusive</td> <td>99999</td> <td></td> </tr> </tbody> </table>	Kind	Value	Annotation	minInclusive	1		maxInclusive	99999	
Kind	Value	Annotation								
minInclusive	1									
maxInclusive	99999									
annotation	documentation Facette zur Festlegung der 5-stelligen Ganzzahlenwerte									
source	<pre> <simpleType name="Zahl5"> <annotation> <documentation>Facette zur Festlegung der 5-stelligen Ganzzahlenwerte</documentation> </annotation> <restriction base="xs:positiveInteger"> <minInclusive value="1"/> <maxInclusive value="99999"/> </restriction> </simpleType> </pre>									

complexType **FallBasis**

diagram	
namespace	http://xml.ir-d.de/emg
children	FAL_Aufnahmedatum FAL_ArtAufenthaltSchluessel FAL_Transfernummer FAL_DatumZeitSatzErstellung FAL_Versionsnummer
used by	complexType Fall

source	<pre> <complexType name="FallBasis"> <sequence> <element name="FAL_Aufnahmedatum" type="xs:date"/> <element name="FAL_ArtAufenthaltSchluessel" type="enum_0065"/> <element name="FAL_Transfernummer" type="Transfernummer"/> <element name="FAL_DatumZeitSatzErstellung" type="xs:dateTime"/> <element name="FAL_Versionsnummer" type="Versionsnummer" minOccurs="0"/> </sequence> </complexType> </pre>
--------	--

element **FallBasis/FAL_Aufnahmedatum**

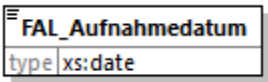
diagram	
type	date
properties	content simple
source	<code><element name="FAL_Aufnahmedatum" type="xs:date"/></code>

element **FallBasis/FAL_ArtAufenthaltSchluessel**

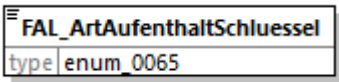
diagram													
type	enum_0065												
properties	content simple												
facets	<table border="1"> <thead> <tr> <th>Kind</th> <th>Value</th> <th>Annotation</th> </tr> </thead> <tbody> <tr> <td>enumeration</td> <td>0065001</td> <td>documentation stationär</td> </tr> <tr> <td>enumeration</td> <td>0065002</td> <td>documentation teilstationär</td> </tr> <tr> <td>enumeration</td> <td>0065003</td> <td>documentation ambulant</td> </tr> </tbody> </table>	Kind	Value	Annotation	enumeration	0065001	documentation stationär	enumeration	0065002	documentation teilstationär	enumeration	0065003	documentation ambulant
Kind	Value	Annotation											
enumeration	0065001	documentation stationär											
enumeration	0065002	documentation teilstationär											
enumeration	0065003	documentation ambulant											
source	<code><element name="FAL_ArtAufenthaltSchluessel" type="enum_0065"/></code>												

element **FallBasis/FAL_Transfernummer**

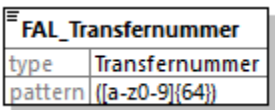
diagram							
type	Transfernummer						
properties	content simple						
facets	<table border="1"> <thead> <tr> <th>Kind</th> <th>Value</th> <th>Annotation</th> </tr> </thead> <tbody> <tr> <td>pattern</td> <td>([a-z0-9]{64})</td> <td></td> </tr> </tbody> </table>	Kind	Value	Annotation	pattern	([a-z0-9]{64})	
Kind	Value	Annotation					
pattern	([a-z0-9]{64})						
source	<code><element name="FAL_Transfernummer" type="Transfernummer"/></code>						

element **FallBasis/FAL_DatumZeitSatzErstellung**

diagram	
type	dateTime
properties	content simple
source	<code><element name="FAL_DatumZeitSatzErstellung" type="xs:dateTime"/></code>

element **FallBasis/FAL_Versionsnummer**

diagram	
type	Versionsnummer
properties	minOcc 0 maxOcc 1 content simple
facets	Kind Value Annotation maxLength 10
source	<code><element name="FAL_Versionsnummer" type="Versionsnummer" minOccurs="0"/></code>

complexType **AusloeserBasis**

diagram	
namespace	http://xml.ir-d.de/emg
children	ALR_ProzedurenSchluessel
used by	element Fall/ausloeser
source	<pre><complexType name="AusloeserBasis"> <sequence> <element name="ALR_ProzedurenSchluessel" type="OPS"/> </sequence> </complexType></pre>

element **AusloeserBasis/ALR_ProzedurenSchluessel**

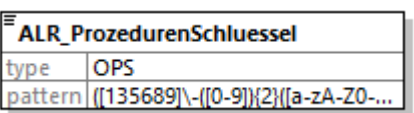
diagram	
type	OPS
properties	content simple
facets	Kind Value Annotation pattern (([135689]\-[0-9]){2})([a-zA-Z0-9]{1}\.([a-zA-Z0-9]{1,2}))*(:[RLBrlb])?

source `<element name="ALR_ProzedurenSchluessel" type="OPS"/>`

complexType **Patientenaufnahme**

<p>diagram</p>	
<p>namespace</p>	<p>http://xml.lir-d.de/emg</p>
<p>type</p>	<p>extension of PatientenaufnahmeBasis</p>
<p>properties</p>	<p>base PatientenaufnahmeBasis</p>
<p>children</p>	<p>PAT Alter PAT Groesse PAT Gewicht PAT GeschlechtSchluessel patientenaufnahmeBrustimplantat patientenaufnahmeKardiologie</p>
<p>used by</p>	<p>element Fall/patientenaufnahme</p>
<p>source</p>	<pre> <complexType name="Patientenaufnahme"> <complexContent> <extension base="PatientenaufnahmeBasis"> <sequence> <element name="patientenaufnahmeBrustimplantat" type="PatientenaufnahmeBrustimplantatBasis" minOccurs="0"/> <element name="patientenaufnahmeKardiologie" type="PatientenaufnahmeKardiologie" minOccurs="0"/> </sequence> </extension> </complexContent> </complexType> </pre>

element **Patientenaufnahme/patientenaufnahmeBrustimplantat**

diagram	
type	PatientenaufnahmeBrustimplantatBasis
properties	minOcc 0 maxOcc 1 content complex
children	PAB AutoimmunerkrankungSchlüssel PAB VerlaufAutoimmunerkrankungSchlüssel
source	<pre><element name="patientenaufnahmeBrustimplantat" type="PatientenaufnahmeBrustimplantatBasis" minOccurs="0"/></pre>

element **Patientenaufnahme/patientenaufnahmeKardiologie**

diagram	
type	PatientenaufnahmeKardiologie

properties	minOcc 0 maxOcc 1 content complex
children	PKA NyhaSchluessel PKA Lvef PKA LvefUnbekannt PKA DiabetesSchluessel PKA NierenersatzSchluessel PKA KreatininwertMgdI PKA KreatininwertMikromol PKA KreatininwertUnbekannt patientenaufnahmeAortenklappe
source	<element name="patientenaufnahmeKardiologie" type="PatientenaufnahmeKardiologie" minOccurs="0"/>

complexType **Operation**

diagram	
namespace	http://xml.ir-d.de/emg
type	extension of OperationBasis
properties	base OperationBasis
children	OPE LaufendeNummer OPE Datum OPE SeitenLokalisationSchluessel OPE AsaSchluessel OPE ImplantattypSchluessel operationBrustimplantat operationEndoprothese operationAortenklappe artikelidentifikation zubehoer
used by	element Fall/operation

source

```
<complexType name="Operation">
  <complexContent>
    <extension base="OperationBasis">
      <sequence>
        <choice>
          <element name="operationBrustimplantat"
type="OperationBrustimplantat"/>
          <element name="operationEndoprothese" type="OperationEndoprothese"/>
          <element name="operationAortenklappe" type="OperationAortenklappe"/>
        </choice>
        <element name="artikelidentifikation" type="Artikelidentifikation"
minOccurs="0" maxOccurs="unbounded"/>
        <element name="zubehoer" type="Zubehoer" minOccurs="0"
maxOccurs="unbounded"/>
      </sequence>
    </extension>
  </complexContent>
</complexType>
```

element **Operation/operationBrustimplantat**

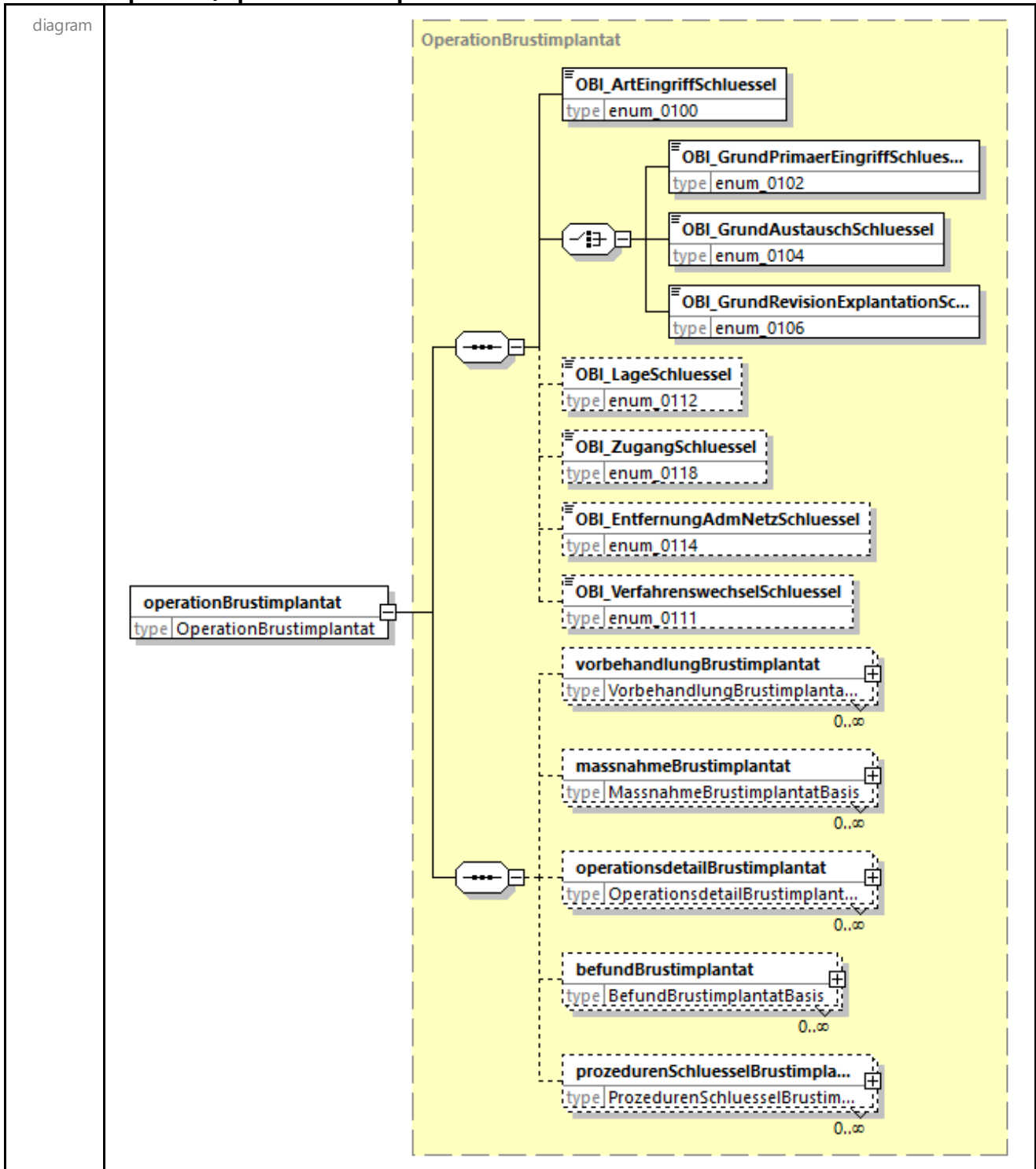

type	OperationBrustimplantat
properties	content complex
children	OBI_ArtEingriffSchluessel OBI_GrundPrimaerEingriffSchluessel OBI_GrundAustauschSchluessel OBI_GrundRevisionExplantationSchluessel OBI_LageSchluessel OBI_ZugangSchluessel OBI_EntfernungAdmNetzSchluessel OBI_VerfahrenswechselSchluessel vorbehandlungBrustimplantat massnahmeBrustimplantat operationsdetailBrustimplantat befundBrustimplantat prozedurenSchluesselBrustimplantat
source	<element name="operationBrustimplantat" type="OperationBrustimplantat"/>

element **Operation/operationEndoprothese**

diagram

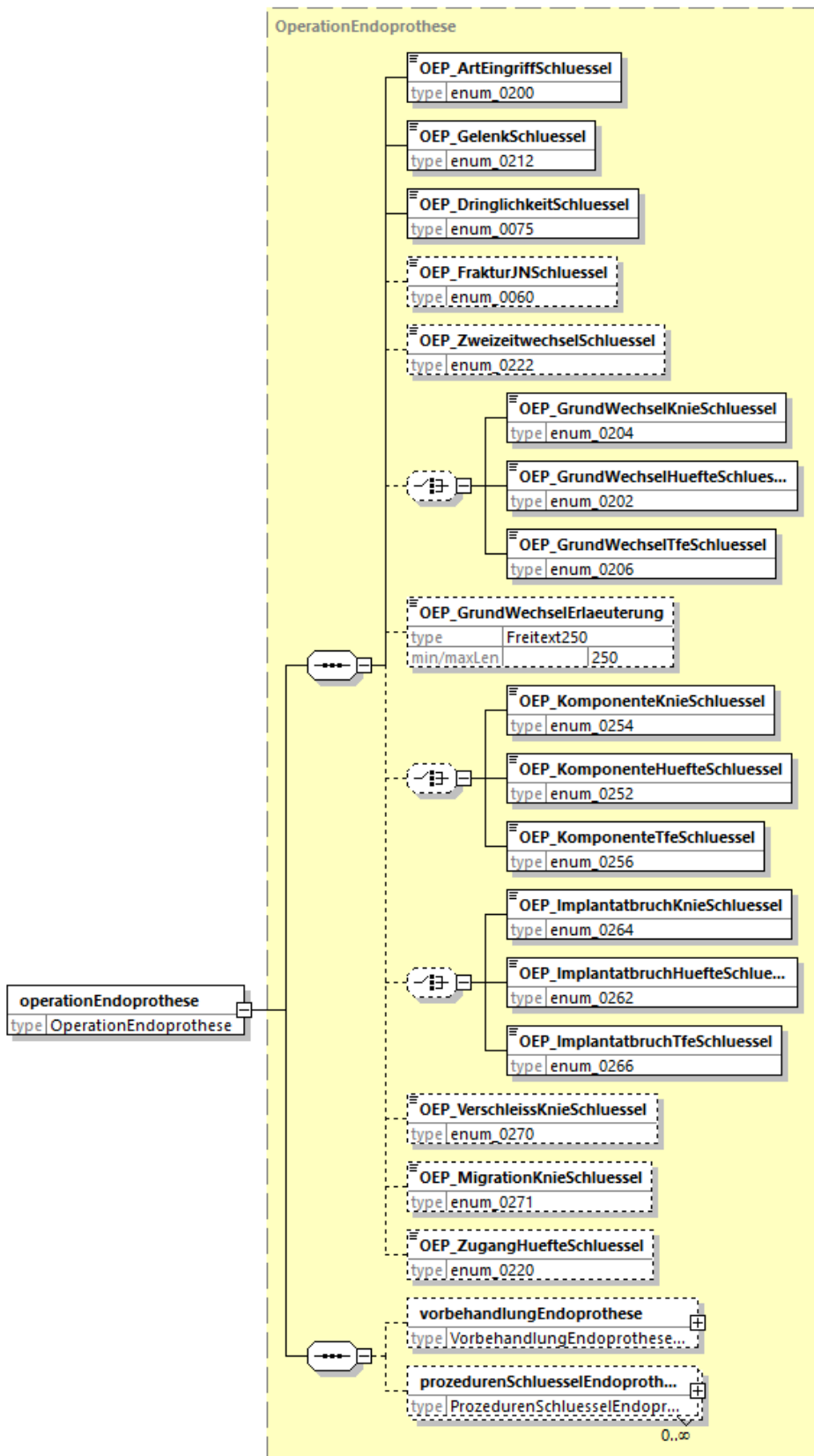

type [OperationEndoprothese](#)

properties	content complex
children	OEP ArtEingriffSchluessel OEP GelenkSchluessel OEP DringlichkeitSchluessel OEP FrakturJNSchluessel OEP ZweizeitwechselSchluessel OEP GrundWechselKnieSchluessel OEP GrundWechselHuefteSchluessel OEP GrundWechselTfeSchluessel OEP GrundWechselErlaeuterung OEP KomponenteKnieSchluessel OEP KomponenteHuefteSchluessel OEP KomponenteTfeSchluessel OEP ImplantatbruchKnieSchluessel OEP ImplantatbruchHuefteSchluessel OEP ImplantatbruchTfeSchluessel OEP VerschleissKnieSchluessel OEP MigrationKnieSchluessel OEP ZugangHuefteSchluessel vorbehandlungEndoprothese prozedurenSchluesselEndoprothese
source	<element name="operationEndoprothese" type="OperationEndoprothese"/>

element **Operation/operationAortenklappe**

diagram

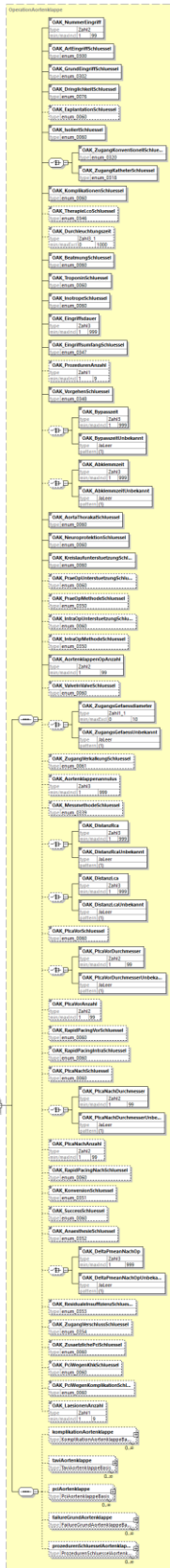

Herzuntersuchung

Herzuntersuchung

Herzuntersuchung

Herzuntersuchung

Herzuntersuchung

Herzuntersuchung

Herzuntersuchung

Herzuntersuchung

Herzuntersuchung

Herzuntersuchung

Herzuntersuchung

Herzuntersuchung

Herzuntersuchung

Herzuntersuchung

Herzuntersuchung

Herzuntersuchung

Herzuntersuchung

Herzuntersuchung

Herzuntersuchung

Herzuntersuchung

Herzuntersuchung

Herzuntersuchung

Herzuntersuchung

Herzuntersuchung

Herzuntersuchung

Herzuntersuchung

Herzuntersuchung

Herzuntersuchung

type	OperationAortenklappe
properties	content complex

children	OAK NummerEingriff OAK ArtEingriffSchluessel OAK GrundEingriffSchluessel OAK DringlichkeitSchluessel OAK ExplantationSchluessel OAK IsoliertSchluessel OAK ZugangKonventionellSchluessel OAK ZugangKatheterSchluessel OAK KomplikationenSchluessel OAK TherapieLcoSchluessel OAK Durchleuchtungszeit OAK BeatmungSchluessel OAK TroponinSchluessel OAK InotropeSchluessel OAK Eingriffsdauer OAK EingriffsumfangSchluessel OAK ProzedurenAnzahl OAK VorgehenSchluessel OAK Bypasszeit OAK BypasszeitUnbekannt OAK Abklemmzeit OAK AbklemmzeitUnbekannt OAK AortaThorakalSchluessel OAK NeuroprotektionSchluessel OAK KreislaufunterstuetzungSchluessel OAK PraeOpUnterstuetzungSchluessel OAK PraeOpMethodeSchluessel OAK IntraOpUnterstuetzungSchluessel OAK IntraOpMethodeSchluessel OAK AortenklappenOpAnzahl OAK ValveInValveSchluessel OAK ZugangsGefaessdiameter OAK ZugangsGefaessUnbekannt OAK ZugangVerkalkungSchluessel OAK Aortenklappenannulus OAK MessmethodeSchluessel OAK DistanzRca OAK DistanzRcaUnbekannt OAK DistanzLca OAK DistanzLcaUnbekannt OAK PtcaVorSchluessel OAK PtcaVorDurchmesser OAK PtcaVorDurchmesserUnbekannt OAK PtcaVorAnzahl OAK RapidPacingVorSchluessel OAK RapidPacingIntraSchluessel OAK PtcaNachSchluessel OAK PtcaNachDurchmesser OAK PtcaNachDurchmesserUnbekannt OAK PtcaNachAnzahl OAK RapidPacingNachSchluessel OAK KonversionSchluessel OAK SuccessSchluessel OAK AnaesthesieSchluessel OAK DeltaPmeanNachOp OAK DeltaPmeanNachOpUnbekannt OAK ResidualeInsuffizienzSchluessel OAK ZugangVerschlussSchluessel OAK ZusaeztlichePciSchluessel OAK PciWegenKhkSchluessel OAK PciWegenKomplikationSchluessel OAK LaesionenAnzahl komplikationAortenklappe taviAortenklappe pciAortenklappe failureGrundAortenklappe prozedurenSchluesselAortenklappe
source	<element name="operationAortenklappe" type="OperationAortenklappe"/>

element **Operation/artikelidentifikation**

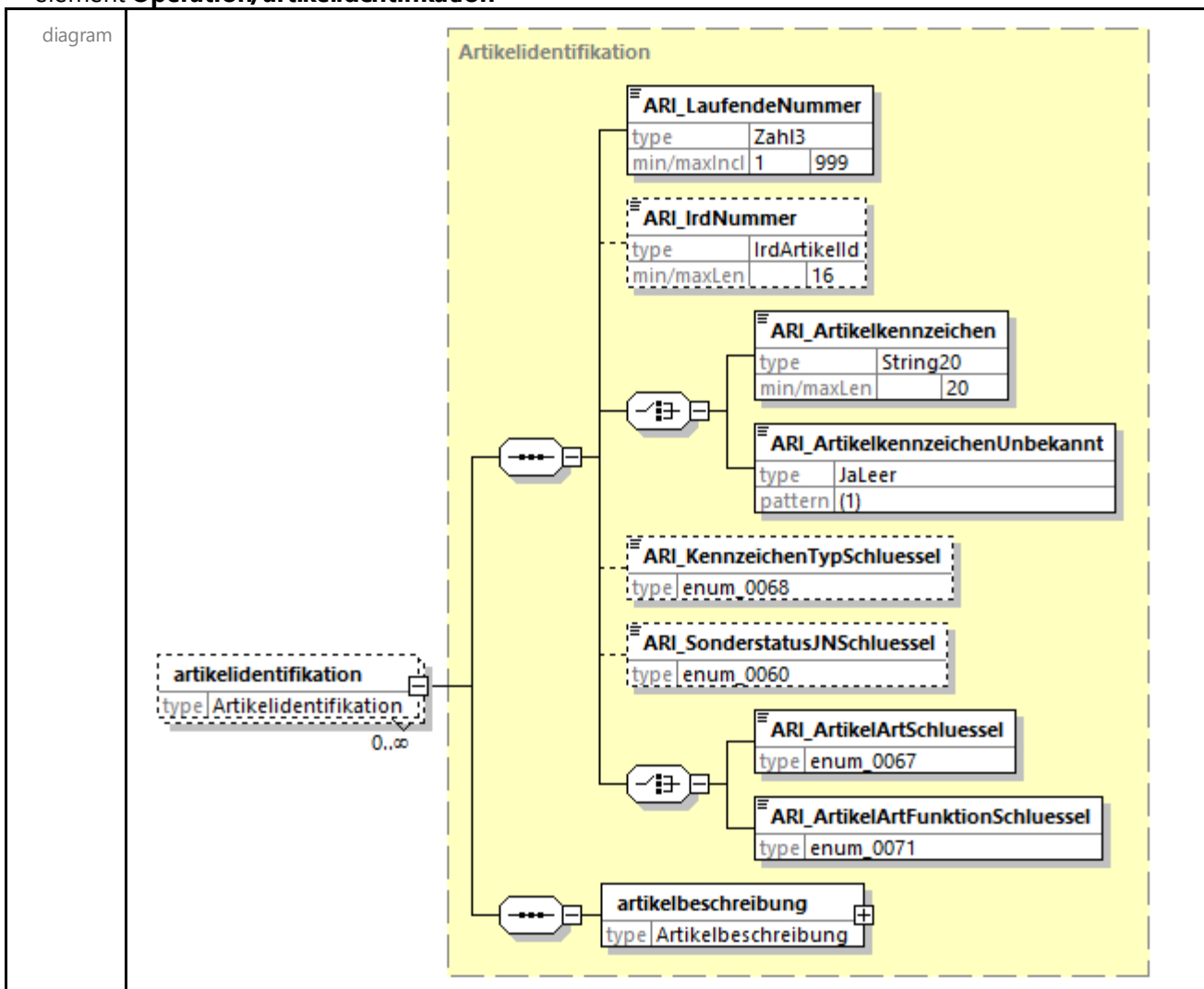

type	Artikelidentifikation
properties	minOcc 0 maxOcc unbounded content complex
children	ARI LaufendeNummer ARI IrdNummer ARI Artikelkennzeichen ARI ArtikelkennzeichenUnbekannt ARI KennzeichenTypSchluessel ARI SonderstatusJNSchluessel ARI ArtikelArtSchluessel ARI ArtikelArtFunktionSchluessel artikelbeschreibung
source	<element name="artikelidentifikation" type="Artikelidentifikation" minOccurs="0" maxOccurs="unbounded"/>

element **Operation/zubehoer**

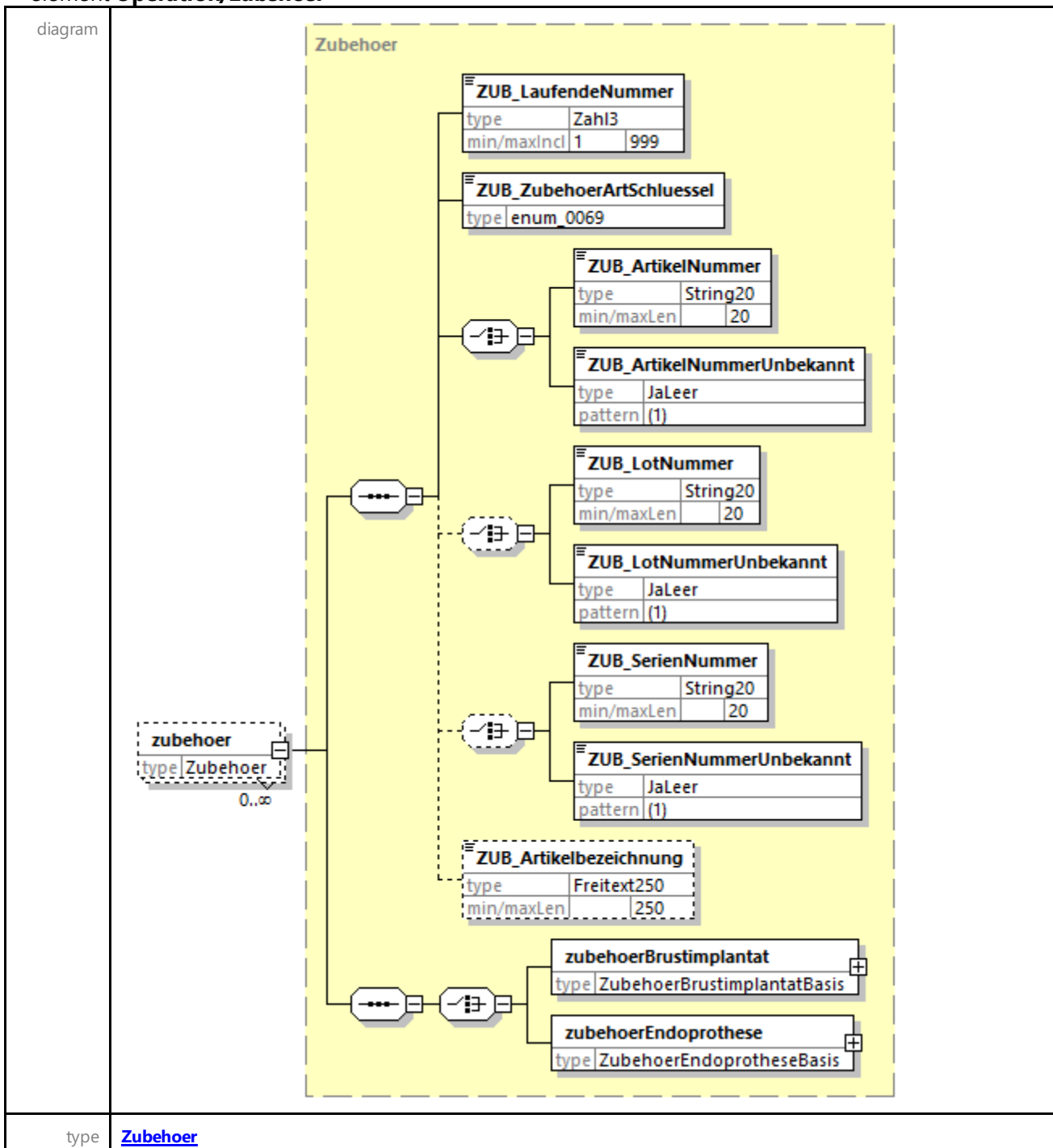

properties	minOcc 0 maxOcc unbounded content complex
children	ZUB LaufendeNummer ZUB ZubehoerArtSchluessel ZUB ArtikelNummer ZUB ArtikelNummerUnbekannt ZUB LotNummer ZUB LotNummerUnbekannt ZUB SerienNummer ZUB SerienNummerUnbekannt ZUB Artikelbezeichnung zubehoerBrustimplantat zubehoerEndoprothese
source	<element name="zubehoer" type="Zubehoer" minOccurs="0" maxOccurs="unbounded"/>

complexType Entlassung

diagram	
namespace	http://xml.ir-d.de/emg
type	extension of EntlassungBasis
properties	base EntlassungBasis
children	ENT Datum ENT GrundSchluessel diagnoseBrustimplantat diagnoseEndoprothese diagnoseAortenklappe
used by	element Fall/entlassung
source	<pre> <complexType name="Entlassung"> <complexContent> <extension base="EntlassungBasis"> <sequence> <element name="diagnoseBrustimplantat" type="DiagnoseBrustimplantatBasis" minOccurs="0" maxOccurs="unbounded"/> <element name="diagnoseEndoprothese" type="DiagnoseEndoprotheseBasis" minOccurs="0" maxOccurs="unbounded"/> <element name="diagnoseAortenklappe" type="DiagnoseAortenklappeBasis" minOccurs="0" maxOccurs="unbounded"/> </sequence> </extension> </complexContent> </complexType> </pre>

element **Entlassung/diagnoseBrustimplantat**

diagram	
type	DiagnoseBrustimplantatBasis
properties	minOcc 0 maxOcc unbounded content complex
children	DBI_IcdSchluessel
source	<code><element name="diagnoseBrustimplantat" type="DiagnoseBrustimplantatBasis" minOccurs="0" maxOccurs="unbounded"/></code>

element **Entlassung/diagnoseEndoprothese**

diagram	
type	DiagnoseEndoprotheseBasis
properties	minOcc 0 maxOcc unbounded content complex
children	DEP_IcdSchluessel
source	<code><element name="diagnoseEndoprothese" type="DiagnoseEndoprotheseBasis" minOccurs="0" maxOccurs="unbounded"/></code>

element **Entlassung/diagnoseAortenklappe**

diagram	
type	DiagnoseAortenklappeBasis
properties	minOcc 0 maxOcc unbounded content complex
children	DAK_IcdSchluessel
source	<code><element name="diagnoseAortenklappe" type="DiagnoseAortenklappeBasis" minOccurs="0" maxOccurs="unbounded"/></code>

complexType PostoperationArtenklappe

diagram

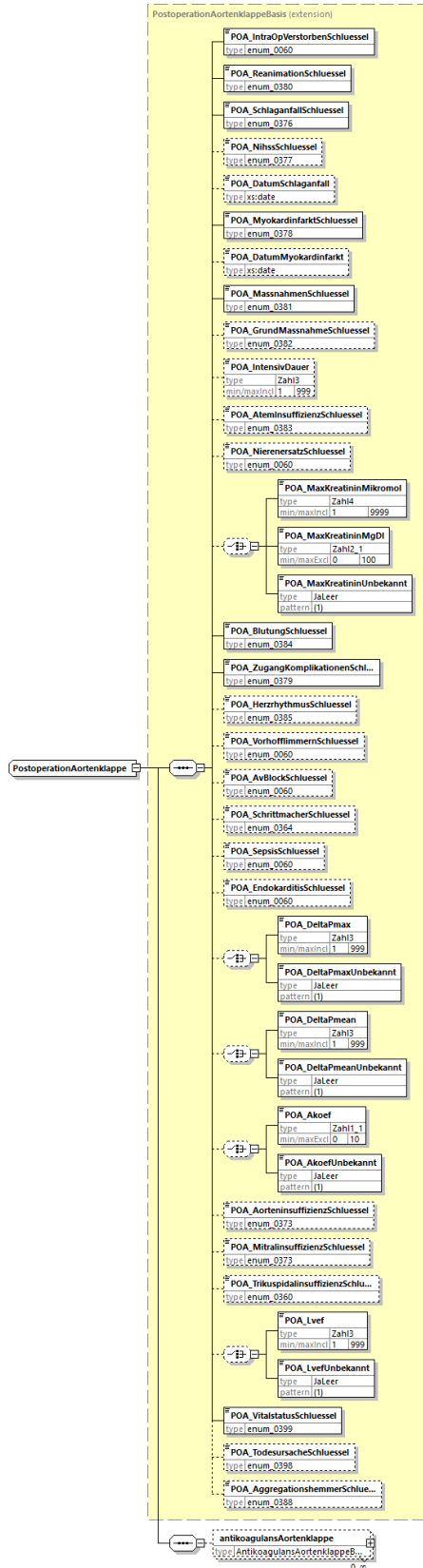

namespace	http://xml.ir-d.de/emg
type	extension of PostoperationArtenklappeBasis

properties	base PostoperationAortenklappeBasis
children	POA IntraOpVerstorbenSchluessel POA ReanimationSchluessel POA SchlaganfallSchluessel POA NihssSchluessel POA DatumSchlaganfall POA MyokardinfarktSchluessel POA DatumMyokardinfarkt POA MassnahmenSchluessel POA GrundMassnahmeSchluessel POA IntensivDauer POA AtemInsuffizienzSchluessel POA NierenersatzSchluessel POA MaxKreatininMikromol POA MaxKreatininMgDL POA MaxKreatininUnbekannt POA BlutungSchluessel POA ZugangKomplikationenSchluessel POA HerzrhythmusSchluessel POA VorhofflimmernSchluessel POA AvBlockSchluessel POA SchrittmacherSchluessel POA SepsisSchluessel POA EndokarditisSchluessel POA DeltaPmax POA DeltaPmaxUnbekannt POA DeltaPmean POA DeltaPmeanUnbekannt POA Akoef POA AkoefUnbekannt POA AorteninsuffizienzSchluessel POA MitralinsuffizienzSchluessel POA TrikuspidalinsuffizienzSchluessel POA Lvef POA LvefUnbekannt POA VitalstatusSchluessel POA TodesursacheSchluessel POA AggregationshemmerSchluessel antikoagulansAortenklappe
used by	element Fall/postoperationAortenklappe
source	<pre><complexType name="PostoperationAortenklappe"> <complexContent> <extension base="PostoperationAortenklappeBasis"> <sequence> <element name="antikoagulansAortenklappe" type="AntikoagulansAortenklappeBasis" minOccurs="0" maxOccurs="unbounded"/> </sequence> </extension> </complexContent> </complexType></pre>

element [PostoperationAortenklappe/antikoagulansAortenklappe](#)

diagram	
type	AntikoagulansAortenklappeBasis
properties	minOcc 0 maxOcc unbounded content complex
children	AKA AntikoagulansSchluessel
source	<pre><element name="antikoagulansAortenklappe" type="AntikoagulansAortenklappeBasis" minOccurs="0" maxOccurs="unbounded"/></pre>

simpleType [enum_0044](#)

namespace	http://xml.ir-d.de/stn		
type	restriction of string		
properties	base xs:string		
facets	Kind	Value	Annotation
	enumeration	0044001	documentation 1= normaler, sonst gesunder Patient
	enumeration	0044002	documentation 2= Patient mit leichter Allgemeinerkrankung
	enumeration	0044003	documentation 3= Patient mit schwerer Allgemeinerkrankung
	enumeration	0044004	documentation

	<p>4= Patient mit schwerer Allgemeinerkrankung, die eine ständige Lebensbedrohung darstellt</p> <p>documentation</p> <p>5= moribunder Patient, der ohne die Operation voraussichtlich nicht überleben wird</p>
enumeration 0044005	
annotation	documentation Kat_ASA
source	<pre> <simpleType name="enum_0044"> <annotation> <documentation>Kat_ASA</documentation> </annotation> <restriction base="xs:string"> <enumeration value="0044001"> <annotation> <documentation>1= normaler, sonst gesunder Patient</documentation> </annotation> </enumeration> <enumeration value="0044002"> <annotation> <documentation>2= Patient mit leichter Allgemeinerkrankung</documentation> </annotation> </enumeration> <enumeration value="0044003"> <annotation> <documentation>3= Patient mit schwerer Allgemeinerkrankung</documentation> </annotation> </enumeration> <enumeration value="0044004"> <annotation> <documentation>4= Patient mit schwerer Allgemeinerkrankung, die eine ständige Lebensbedrohung darstellt</documentation> </annotation> </enumeration> <enumeration value="0044005"> <annotation> <documentation>5= moribunder Patient, der ohne die Operation voraussichtlich nicht überleben wird</documentation> </annotation> </enumeration> </restriction> </simpleType> </pre>

simpleType enum_0050

namespace	http://xml.ir-d.de/stn		
type	restriction of string		
properties	base xs:string		
facets	Kind	Value	Annotation
	enumeration	0050001	documentation rechts
	enumeration	0050002	documentation links
annotation	documentation Kat_RechtsLinks		
source	<pre> <simpleType name="enum_0050"> <annotation> </pre>		

	<pre> <documentation>Kat_RechtsLinks</documentation> </annotation> <restriction base="xs:string"> <enumeration value="0050001"> <annotation> <documentation>rechts</documentation> </annotation> </enumeration> <enumeration value="0050002"> <annotation> <documentation>links</documentation> </annotation> </enumeration> </restriction> </simpleType> </pre>
--	--

simpleType enum_0060

namespace	http://xml.ir-d.de/stn		
type	restriction of string		
properties	base xs:string		
facets	Kind	Value	Annotation
	enumeration	0060001	documentation ja
	enumeration	0060002	documentation nein
annotation	documentation Kat_JaNein		
source	<pre> <simpleType name="enum_0060"> <annotation> <documentation>Kat_JaNein</documentation> </annotation> <restriction base="xs:string"> <enumeration value="0060001"> <annotation> <documentation>ja</documentation> </annotation> </enumeration> <enumeration value="0060002"> <annotation> <documentation>nein</documentation> </annotation> </enumeration> </restriction> </simpleType> </pre>		

simpleType enum_0061

namespace	http://xml.ir-d.de/stn		
type	restriction of string		
properties	base xs:string		
facets	Kind	Value	Annotation
	enumeration	0061001	documentation ja

	enumeration 0061002 documentation nein enumeration 0061099 documentation unbekannt
annotation	documentation Kat_JaNeinUnbekannt
source	<pre> <simpleType name="enum_0061"> <annotation> <documentation>Kat_JaNeinUnbekannt</documentation> </annotation> <restriction base="xs:string"> <enumeration value="0061001"> <annotation> <documentation>ja</documentation> </annotation> </enumeration> <enumeration value="0061002"> <annotation> <documentation>nein</documentation> </annotation> </enumeration> <enumeration value="0061099"> <annotation> <documentation>unbekannt</documentation> </annotation> </enumeration> </restriction> </simpleType> </pre>

simpleType enum 0062

namespace	http://xml.ir-d.de/stn		
type	restriction of string		
properties	base xs:string		
facets	Kind	Value	Annotation
	enumeration	0062001	documentation Stück
	enumeration	0062002	documentation g
	enumeration	0062003	documentation mg
	enumeration	0062004	documentation l
	enumeration	0062005	documentation ml
	enumeration	0062006	documentation cm ³
	enumeration	0062007	documentation mm
	enumeration	0062008	documentation cm
	enumeration	0062009	documentation dm
	enumeration	0062010	documentation m
	enumeration	0062042	documentation andere
annotation	documentation Kat_Einheit		

source

```
<simpleType name="enum_0062">
  <annotation>
    <documentation>Kat_Einheit</documentation>
  </annotation>
  <restriction base="xs:string">
    <enumeration value="0062001">
      <annotation>
        <documentation>Stück</documentation>
      </annotation>
    </enumeration>
    <enumeration value="0062002">
      <annotation>
        <documentation>g</documentation>
      </annotation>
    </enumeration>
    <enumeration value="0062003">
      <annotation>
        <documentation>mg</documentation>
      </annotation>
    </enumeration>
    <enumeration value="0062004">
      <annotation>
        <documentation>l</documentation>
      </annotation>
    </enumeration>
    <enumeration value="0062005">
      <annotation>
        <documentation>ml</documentation>
      </annotation>
    </enumeration>
    <enumeration value="0062006">
      <annotation>
        <documentation>cm3</documentation>
      </annotation>
    </enumeration>
    <enumeration value="0062007">
      <annotation>
        <documentation>mm</documentation>
      </annotation>
    </enumeration>
    <enumeration value="0062008">
      <annotation>
        <documentation>cm</documentation>
      </annotation>
    </enumeration>
    <enumeration value="0062009">
      <annotation>
        <documentation>dm</documentation>
      </annotation>
    </enumeration>
    <enumeration value="0062010">
      <annotation>
        <documentation>m</documentation>
      </annotation>
    </enumeration>
    <enumeration value="0062042">
      <annotation>
        <documentation>andere</documentation>
      </annotation>
    </enumeration>
  </restriction>
</simpleType>
```

	<pre> </enumeration> </restriction> </simpleType> </pre>
--	--

simpleType enum_0065

namespace	http://xml.ir-d.de/stn		
type	restriction of string		
properties	base xs:string		
facets	Kind	Value	Annotation
	enumeration	0065001	documentation stationär
	enumeration	0065002	documentation teilstationär
	enumeration	0065003	documentation ambulant
annotation	documentation Kat_ArtAufenthalt		
source	<pre> <simpleType name="enum_0065"> <annotation> <documentation>Kat_ArtAufenthalt</documentation> </annotation> <restriction base="xs:string"> <enumeration value="0065001"> <annotation> <documentation>stationär</documentation> </annotation> </enumeration> <enumeration value="0065002"> <annotation> <documentation>teilstationär</documentation> </annotation> </enumeration> <enumeration value="0065003"> <annotation> <documentation>ambulant</documentation> </annotation> </enumeration> </restriction> </simpleType> </pre>		

simpleType enum_0067

namespace	http://xml.ir-d.de/stn		
type	restriction of string		
properties	base xs:string		
facets	Kind	Value	Annotation
	enumeration	0067001	documentation Implantat
	enumeration	0067002	documentation Explantat
annotation	documentation Kat_ArtArtikel		
source	<pre> <simpleType name="enum_0067"> </pre>		

	<pre> <annotation> <documentation>Kat_ArtArtikel</documentation> </annotation> <restriction base="xs:string"> <enumeration value="0067001"> <annotation> <documentation>Implantat</documentation> </annotation> </enumeration> <enumeration value="0067002"> <annotation> <documentation>Explantat</documentation> </annotation> </enumeration> </restriction> </simpleType> </pre>
--	---

simpleType enum 0068

namespace	http://xml.ir-d.de/stn		
type	restriction of string		
properties	base xs:string		
facets	Kind	Value	Annotation
	enumeration	0068001	documentation UDI
	enumeration	0068002	documentation Referenz (REF)
	enumeration	0068003	documentation Katalognummer
	enumeration	0068042	documentation sonstiger
annotation	documentation Kat_KennzeichenTyp		
source	<pre> <simpleType name="enum_0068"> <annotation> <documentation>Kat_KennzeichenTyp</documentation> </annotation> <restriction base="xs:string"> <enumeration value="0068001"> <annotation> <documentation>UDI</documentation> </annotation> </enumeration> <enumeration value="0068002"> <annotation> <documentation>Referenz (REF)</documentation> </annotation> </enumeration> <enumeration value="0068003"> <annotation> <documentation>Katalognummer</documentation> </annotation> </enumeration> <enumeration value="0068042"> <annotation> <documentation>sonstiger</documentation> </annotation> </enumeration> </restriction> </simpleType> </pre>		

	<pre> </enumeration> </restriction> </simpleType> </pre>
--	--

simpleType enum_0069

namespace	http://xml.ir-d.de/stn		
type	restriction of string		
properties	base xs:string		
facets	Kind	Value	Annotation
	enumeration	0069001	documentation Implantat
	enumeration	0069002	documentation Explantat
annotation	documentation Kat_ArtZubehoer		
source	<pre> <simpleType name="enum_0069"> <annotation> <documentation>Kat_ArtZubehoer</documentation> </annotation> <restriction base="xs:string"> <enumeration value="0069001"> <annotation> <documentation>Implantat</documentation> </annotation> </enumeration> <enumeration value="0069002"> <annotation> <documentation>Explantat</documentation> </annotation> </enumeration> </restriction> </simpleType> </pre>		

simpleType enum_0070

namespace	http://xml.ir-d.de/stn		
type	restriction of string		
properties	base xs:string		
facets	Kind	Value	Annotation
	enumeration	0070001	documentation weiblich
	enumeration	0070002	documentation männlich
	enumeration	0070003	documentation divers
	enumeration	0070042	documentation unbestimmt
annotation	documentation Kat_Geschlecht		
source	<pre> <simpleType name="enum_0070"> <annotation> <documentation>Kat_Geschlecht</documentation> </annotation> </pre>		

	<pre> <restriction base="xs:string"> <enumeration value="0070001"> <annotation> <documentation>weiblich</documentation> </annotation> </enumeration> <enumeration value="0070002"> <annotation> <documentation>männlich</documentation> </annotation> </enumeration> <enumeration value="0070003"> <annotation> <documentation>divers</documentation> </annotation> </enumeration> <enumeration value="0070042"> <annotation> <documentation>unbestimmt</documentation> </annotation> </enumeration> </restriction> </simpleType> </pre>
--	--

simpleType enum_0071

namespace	http://xml.ir-d.de/stn		
type	restriction of string		
properties	base xs:string		
facets	Kind	Value	Annotation
	enumeration	0071001	documentation Implantat
	enumeration	0071002	documentation Explantat
	enumeration	0071003	documentation Degeneriertes/defektes Produkt, das funktionslos im Körper verbleibt
annotation	documentation Kat ArtikelArtFunktion		
source	<pre> <simpleType name="enum_0071"> <annotation> <documentation>Kat_ArtikelArtFunktion</documentation> </annotation> <restriction base="xs:string"> <enumeration value="0071001"> <annotation> <documentation>Implantat</documentation> </annotation> </enumeration> <enumeration value="0071002"> <annotation> <documentation>Explantat</documentation> </annotation> </enumeration> <enumeration value="0071003"> <annotation> <documentation>Degeneriertes/defektes Produkt, das funktionslos im Körper verbleibt</documentation> </annotation> </enumeration> </restriction> </simpleType> </pre>		

```

</annotation>
</enumeration>
</restriction>
</simpleType>

```

simpleType enum_0075

namespace	http://xml.ir-d.de/stn		
type	restriction of string		
properties	base xs:string		
facets	Kind	Value	Annotation
	enumeration	0075001	documentation elektiv
	enumeration	0075002	documentation dringlich
	enumeration	0075003	documentation Notfall
annotation	documentation Kat_Dringlichkeit		
source	<pre> <simpleType name="enum_0075"> <annotation> <documentation>Kat_Dringlichkeit</documentation> </annotation> <restriction base="xs:string"> <enumeration value="0075001"> <annotation> <documentation>elektiv</documentation> </annotation> </enumeration> <enumeration value="0075002"> <annotation> <documentation>dringlich</documentation> </annotation> </enumeration> <enumeration value="0075003"> <annotation> <documentation>Notfall</documentation> </annotation> </enumeration> </restriction> </simpleType> </pre>		

simpleType enum_0076

namespace	http://xml.ir-d.de/stn		
type	restriction of string		
properties	base xs:string		
facets	Kind	Value	Annotation
	enumeration	0076001	documentation elektiv
	enumeration	0076002	documentation dringlich
	enumeration	0076003	documentation Notfall
	enumeration	0076004	documentation

	Notfall (Reanimation / ultima ratio)
annotation	documentation Kat Dringlichkeit Reanimation
source	<pre> <simpleType name="enum_0076"> <annotation> <documentation>Kat_Dringlichkeit_Reanimation</documentation> </annotation> <restriction base="xs:string"> <enumeration value="0076001"> <annotation> <documentation>elektiv</documentation> </annotation> </enumeration> <enumeration value="0076002"> <annotation> <documentation>dringlich</documentation> </annotation> </enumeration> <enumeration value="0076003"> <annotation> <documentation>Notfall</documentation> </annotation> </enumeration> <enumeration value="0076004"> <annotation> <documentation>Notfall (Reanimation / ultima ratio)</documentation> </annotation> </enumeration> </restriction> </simpleType> </pre>

simpleType enum_0080

namespace	http://xml.ir-d.de/stn		
type	restriction of string		
properties	base xs:string		
facets	Kind	Value	Annotation
	enumeration	0080001	documentation Endoprothese Hüfte/Knie
	enumeration	0080002	documentation Brustimplantat
	enumeration	0080003	documentation Aortenklappenprothese
annotation	documentation Kat_Implantattyp		
source	<pre> <simpleType name="enum_0080"> <annotation> <documentation>Kat_Implantattyp</documentation> </annotation> <restriction base="xs:string"> <enumeration value="0080001"> <annotation> <documentation>Endoprothese Hüfte/Knie</documentation> </annotation> </enumeration> <enumeration value="0080002"> <annotation> </pre>		

	<pre> <documentation>Brustimplantat</documentation> </annotation> </enumeration> <enumeration value="0080003"> <annotation> <documentation>Aortenklappenprothese</documentation> </annotation> </enumeration> </restriction> </simpleType> </pre>
--	---

simpleType enum_0100

namespace	http://xml.ir-d.de/stn		
type	restriction of string		
properties	base xs:string		
facets	Kind	Value	Annotation
	enumeration	0100001	documentation Primäreingriff
	enumeration	0100002	documentation Austausch Expander gegen dauerhaftes Brustimplantat
	enumeration	0100003	documentation Revision
	enumeration	0100004	documentation Nur Explantation
annotation	documentation Kat_BI_ArtEingriff		
source	<pre> <simpleType name="enum_0100"> <annotation> <documentation>Kat_BI_ArtEingriff</documentation> </annotation> <restriction base="xs:string"> <enumeration value="0100001"> <annotation> <documentation>Primäreingriff</documentation> </annotation> </enumeration> <enumeration value="0100002"> <annotation> <documentation>Austausch Expander gegen dauerhaftes Brustimplantat</documentation> </annotation> </enumeration> <enumeration value="0100003"> <annotation> <documentation>Revision</documentation> </annotation> </enumeration> <enumeration value="0100004"> <annotation> <documentation>Nur Explantation</documentation> </annotation> </enumeration> </restriction> </simpleType> </pre>		

simpleType enum_0102

namespace	http://xml.ir-d.de/stn		
type	restriction of string		
properties	base xs:string		
facets	Kind	Value	Annotation
	enumeration	0102001	documentation kosmetische Augmentation
	enumeration	0102002	documentation Rekonstruktion, benigne
	enumeration	0102003	documentation Rekonstruktion nach Mastektomie aufgrund eines Karzinoms
	enumeration	0102004	documentation Rekonstruktion nach risikoreduzierender Mastektomie
annotation	documentation Kat_BI_GrundPrimaereingriff		
source	<pre> <simpleType name="enum_0102"> <annotation> <documentation>Kat_BI_GrundPrimaereingriff</documentation> </annotation> <restriction base="xs:string"> <enumeration value="0102001"> <annotation> <documentation>kosmetische Augmentation</documentation> </annotation> </enumeration> <enumeration value="0102002"> <annotation> <documentation>Rekonstruktion, benigne</documentation> </annotation> </enumeration> <enumeration value="0102003"> <annotation> <documentation>Rekonstruktion nach Mastektomie aufgrund eines Karzinoms</documentation> </annotation> </enumeration> <enumeration value="0102004"> <annotation> <documentation>Rekonstruktion nach risikoreduzierender Mastektomie</documentation> </annotation> </enumeration> </restriction> </simpleType> </pre>		

simpleType enum_0103

namespace	http://xml.ir-d.de/stn		
type	restriction of string		
properties	base xs:string		
facets	Kind	Value	Annotation
	enumeration	0103001	documentation simultane Lappendeckung
	enumeration	0103002	documentation

	<p>enumeration 0103003 simultane Eigenfetttransplantation documentation</p> <p>enumeration 0103005 simultane Mastopexie documentation</p> <p>enumeration 0103006 simultane Mastektomie, Ablatio / hautsparend documentation</p> <p>enumeration 0103007 simultane Mastektomie, nippelerhaltend documentation</p> <p>enumeration 0103008 Axilla-Dissektion documentation Drainage</p>
annotation	documentation Kat_BI_OperationsdetailPrimaereingriff
source	<pre> <simpleType name="enum_0103"> <annotation> <documentation>Kat_BI_OperationsdetailPrimaereingriff</documentation> </annotation> <restriction base="xs:string"> <enumeration value="0103001"> <annotation> <documentation>simultane Lappendeckung</documentation> </annotation> </enumeration> <enumeration value="0103002"> <annotation> <documentation>simultane Eigenfetttransplantation</documentation> </annotation> </enumeration> <enumeration value="0103003"> <annotation> <documentation>simultane Mastopexie</documentation> </annotation> </enumeration> <enumeration value="0103005"> <annotation> <documentation>simultane Mastektomie, Ablatio / hautsparend</documentation> </annotation> </enumeration> <enumeration value="0103006"> <annotation> <documentation>simultane Mastektomie, nippelerhaltend</documentation> </annotation> </enumeration> <enumeration value="0103007"> <annotation> <documentation>Axilla-Dissektion</documentation> </annotation> </enumeration> <enumeration value="0103008"> <annotation> <documentation>Drainage</documentation> </annotation> </enumeration> </restriction> </simpleType> </pre>

simpleType enum_0104

namespace	http://xml.ir-d.de/stn		
type	restriction of string		
properties	base xs:string		
facets	Kind	Value	Annotation
	enumeration	0104001	documentation Austausch Expander gegen dauerhaftes Brustimplantat
annotation	documentation Kat_BI_GrundAustausch		
source	<pre> <simpleType name="enum_0104"> <annotation> <documentation>Kat_BI_GrundAustausch</documentation> </annotation> <restriction base="xs:string"> <enumeration value="0104001"> <annotation> <documentation>Austausch Expander gegen dauerhaftes Brustimplantat</documentation> </annotation> </enumeration> </restriction> </simpleType> </pre>		

simpleType enum_0105

namespace	http://xml.ir-d.de/stn		
type	restriction of string		
properties	base xs:string		
facets	Kind	Value	Annotation
	enumeration	0105001	documentation simultane Lappendeckung
	enumeration	0105002	documentation simultane Eigenfetttransplantation
	enumeration	0105003	documentation simultane Mastopexie
	enumeration	0105008	documentation Drainage
	enumeration	0105009	documentation Kapsulektomie, komplett
	enumeration	0105010	documentation Kapsulektomie, partiell
	enumeration	0105011	documentation Neopocket
annotation	documentation Kat_BI_OperationsdetailAustausch		
source	<pre> <simpleType name="enum_0105"> <annotation> <documentation>Kat_BI_OperationsdetailAustausch</documentation> </annotation> <restriction base="xs:string"> <enumeration value="0105001"> <annotation> <documentation>simultane Lappendeckung</documentation> </annotation> </enumeration> <enumeration value="0105002"> </pre>		

	<pre> <annotation> <documentation>simultane Eigenfetttransplantation</documentation> </annotation> </enumeration> <enumeration value="0105003"> <annotation> <documentation>simultane Mastopexie</documentation> </annotation> </enumeration> <enumeration value="0105008"> <annotation> <documentation>Drainage</documentation> </annotation> </enumeration> <enumeration value="0105009"> <annotation> <documentation>Kapsulektomie, komplett</documentation> </annotation> </enumeration> <enumeration value="0105010"> <annotation> <documentation>Kapsulektomie, partiell</documentation> </annotation> </enumeration> <enumeration value="0105011"> <annotation> <documentation>Neopocket</documentation> </annotation> </enumeration> </restriction> </simpleType> </pre>
--	--

simpleType enum_0106

namespace	http://xml.ir-d.de/stn		
type	restriction of string		
properties	base xs:string		
facets	Kind	Value	Annotation
	enumeration	0106001	documentation Patientenwunsch
	enumeration	0106002	documentation asymptomatisch
	enumeration	0106003	documentation Komplikation
annotation	documentation Kat_BI_GrundRevisionExplantation		
source	<pre> <simpleType name="enum_0106"> <annotation> <documentation>Kat_BI_GrundRevisionExplantation</documentation> </annotation> <restriction base="xs:string"> <enumeration value="0106001"> <annotation> <documentation>Patientenwunsch</documentation> </annotation> </enumeration> <enumeration value="0106002"> </pre>		

	<pre> <annotation> <documentation>asymptomatisch</documentation> </annotation> </enumeration> <enumeration value="0106003"> <annotation> <documentation>Komplikation</documentation> </annotation> </enumeration> </restriction> </simpleType> </pre>
--	---

simpleType enum_0107

namespace	http://xml.ir-d.de/stn		
type	restriction of string		
properties	base xs:string		
facets	Kind	Value	Annotation
	enumeration	0107001	documentation simultane Lappendeckung
	enumeration	0107002	documentation simultane Eigenfetttransplantation
	enumeration	0107003	documentation simultane Mastopexie
	enumeration	0107005	documentation simultane Mastektomie, Ablatio / hautsparend
	enumeration	0107006	documentation simultane Mastektomie, nippelerhaltend
	enumeration	0107007	documentation Axilla-Dissektion
	enumeration	0107008	documentation Drainage
	enumeration	0107009	documentation Kapsulektomie, komplett
	enumeration	0107010	documentation Kapsulektomie, partiell
	enumeration	0107011	documentation Neopocket
annotation	documentation Kat_BI_OperationsdetailRevision		
source	<pre> <simpleType name="enum_0107"> <annotation> <documentation>Kat_BI_OperationsdetailRevision</documentation> </annotation> <restriction base="xs:string"> <enumeration value="0107001"> <annotation> <documentation>simultane Lappendeckung</documentation> </annotation> </enumeration> <enumeration value="0107002"> <annotation> <documentation>simultane Eigenfetttransplantation</documentation> </annotation> </enumeration> <enumeration value="0107003"> <annotation> <documentation>simultane Mastopexie</documentation> </pre>		

```

</annotation>
</enumeration>
<enumeration value="0107005">
  <annotation>
    <documentation>simultane Mastektomie, Ablatio /
hautsparend</documentation>
  </annotation>
</enumeration>
<enumeration value="0107006">
  <annotation>
    <documentation>simultane Mastektomie, nippelerhaltend</documentation>
  </annotation>
</enumeration>
<enumeration value="0107007">
  <annotation>
    <documentation>Axilla-Dissektion</documentation>
  </annotation>
</enumeration>
<enumeration value="0107008">
  <annotation>
    <documentation>Drainage</documentation>
  </annotation>
</enumeration>
<enumeration value="0107009">
  <annotation>
    <documentation>Kapsulektomie, komplett</documentation>
  </annotation>
</enumeration>
<enumeration value="0107010">
  <annotation>
    <documentation>Kapsulektomie, partiell</documentation>
  </annotation>
</enumeration>
<enumeration value="0107011">
  <annotation>
    <documentation>Neopocket</documentation>
  </annotation>
</enumeration>
</restriction>
</simpleType>

```

simpleType **enum_0110**

namespace	http://xml.ir-d.de/stn		
type	restriction of string		
properties	base xs:string		
facets	Kind enumeration	Value 0110001	Annotation documentation Bestrahlung
annotation	documentation Kat_BI_VorbehandlungLokal		
source	<simpleType name="enum_0110"> <annotation> <documentation>Kat_BI_VorbehandlungLokal</documentation> </annotation> <restriction base="xs:string">		

	<pre> <enumeration value="0110001"> <annotation> <documentation>Bestrahlung</documentation> </annotation> </enumeration> </restriction> </simpleType> </pre>
--	--

simpleType enum_0111

namespace	http://xml.ir-d.de/stn		
type	restriction of string		
properties	base xs:string		
facets	Kind	Value	Annotation
	enumeration	0111001	documentation nein
	enumeration	0111002	documentation Lipofilling
	enumeration	0111003	documentation Eigengewebsrekonstruktion
annotation	documentation Kat_BI_Verfahrenswechsel		
source	<pre> <simpleType name="enum_0111"> <annotation> <documentation>Kat_BI_Verfahrenswechsel</documentation> </annotation> <restriction base="xs:string"> <enumeration value="0111001"> <annotation> <documentation>nein</documentation> </annotation> </enumeration> <enumeration value="0111002"> <annotation> <documentation>Lipofilling</documentation> </annotation> </enumeration> <enumeration value="0111003"> <annotation> <documentation>Eigengewebsrekonstruktion</documentation> </annotation> </enumeration> </restriction> </simpleType> </pre>		

simpleType enum_0112

namespace	http://xml.ir-d.de/stn		
type	restriction of string		
properties	base xs:string		
facets	Kind	Value	Annotation
	enumeration	0112001	documentation subglandulär / epipektoral
	enumeration	0112002	documentation

	<p>enumeration 0112003 subpektoral documentation subfaszial</p> <p>enumeration 0112004 documentation sub-flap</p> <p>enumeration 0112005 documentation subkutan</p> <p>enumeration 0112006 documentation dual plane</p> <p>enumeration 0112042 documentation andere</p>
annotation	documentation Kat BI_LageImplantat
source	<pre> <simpleType name="enum_0112"> <annotation> <documentation>Kat_BI_LageImplantat</documentation> </annotation> <restriction base="xs:string"> <enumeration value="0112001"> <annotation> <documentation>subglandulär / epipektoral</documentation> </annotation> </enumeration> <enumeration value="0112002"> <annotation> <documentation>subpektoral</documentation> </annotation> </enumeration> <enumeration value="0112003"> <annotation> <documentation>subfaszial</documentation> </annotation> </enumeration> <enumeration value="0112004"> <annotation> <documentation>sub-flap</documentation> </annotation> </enumeration> <enumeration value="0112005"> <annotation> <documentation>subkutan</documentation> </annotation> </enumeration> <enumeration value="0112006"> <annotation> <documentation>dual plane</documentation> </annotation> </enumeration> <enumeration value="0112042"> <annotation> <documentation>andere</documentation> </annotation> </enumeration> </restriction> </simpleType> </pre>

simpleType enum_0113

namespace	http://xml.ir-d.de/stn		
type	restriction of string		
properties	base xs:string		
facets	Kind	Value	Annotation
	enumeration	0113001	documentation Chemotherapie innerhalb der letzten drei Monate
annotation	documentation Kat_BI_VorbehandlungSystemisch		
source	<pre><simpleType name="enum_0113"> <annotation> <documentation>Kat_BI_VorbehandlungSystemisch</documentation> </annotation> <restriction base="xs:string"> <enumeration value="0113001"> <annotation> <documentation>Chemotherapie innerhalb der letzten drei Monate</documentation> </annotation> </enumeration> </restriction> </simpleType></pre>		

simpleType enum_0114

namespace	http://xml.ir-d.de/stn		
type	restriction of string		
properties	base xs:string		
facets	Kind	Value	Annotation
	enumeration	0114001	documentation vollständig
	enumeration	0114002	documentation nein
	enumeration	0114003	documentation teilweise
	enumeration	0114004	documentation nicht vorhanden
annotation	documentation Kat_BI_EntfernungADMNetz		
source	<pre><simpleType name="enum_0114"> <annotation> <documentation>Kat_BI_EntfernungADMNetz</documentation> </annotation> <restriction base="xs:string"> <enumeration value="0114001"> <annotation> <documentation>vollständig</documentation> </annotation> </enumeration> <enumeration value="0114002"> <annotation> <documentation>nein</documentation> </annotation> </enumeration> <enumeration value="0114003"></pre>		

	<pre> <annotation> <documentation>teilweise</documentation> </annotation> </enumeration> <enumeration value="0114004"> <annotation> <documentation>nicht vorhanden</documentation> </annotation> </enumeration> </restriction> </simpleType> </pre>
--	---

simpleType enum_0116

namespace	http://xml.ir-d.de/stn		
type	restriction of string		
properties	base xs:string		
facets	Kind	Value	Annotation
	enumeration	0116001	documentation Spülung, antibiotisch
	enumeration	0116002	documentation Spülung, antiseptisch
	enumeration	0116003	documentation Spülung, wirkstofffrei
	enumeration	0116004	documentation Spülung, andere
	enumeration	0116005	documentation prä-/perioperative Antibiotika
	enumeration	0116006	documentation postoperative Antibiotika
	enumeration	0116007	documentation Handschuhwechsel vor Implantation
	enumeration	0116008	documentation Implantationshilfe
annotation	documentation Kat_BI_Operationsmassnahme		
source	<pre> <simpleType name="enum_0116"> <annotation> <documentation>Kat_BI_Operationsmassnahme</documentation> </annotation> <restriction base="xs:string"> <enumeration value="0116001"> <annotation> <documentation>Spülung, antibiotisch</documentation> </annotation> </enumeration> <enumeration value="0116002"> <annotation> <documentation>Spülung, antiseptisch</documentation> </annotation> </enumeration> <enumeration value="0116003"> <annotation> <documentation>Spülung, wirkstofffrei</documentation> </annotation> </enumeration> <enumeration value="0116004"> <annotation> </pre>		

	<pre> <documentation>Spülung, andere</documentation> </annotation> </enumeration> <enumeration value="0116005"> <annotation> <documentation>prä-/perioperative Antibiotika</documentation> </annotation> </enumeration> <enumeration value="0116006"> <annotation> <documentation>postoperative Antibiotika</documentation> </annotation> </enumeration> <enumeration value="0116007"> <annotation> <documentation>Handschuhwechsel vor Implantation</documentation> </annotation> </enumeration> <enumeration value="0116008"> <annotation> <documentation>Implantationshilfe</documentation> </annotation> </enumeration> </restriction> </simpleType> </pre>
--	---

simpleType enum_0118

namespace	http://xml.ir-d.de/stn		
type	restriction of string		
properties	base xs:string		
facets	Kind	Value	Annotation
	enumeration	0118001	documentation axillär
	enumeration	0118002	documentation periareolär
	enumeration	0118003	documentation inframammär
	enumeration	0118004	documentation Mastektomienarbe
	enumeration	0118042	documentation anderer
annotation	documentation Kat_BI_Operationszugang		
source	<pre> <simpleType name="enum_0118"> <annotation> <documentation>Kat_BI_Operationszugang</documentation> </annotation> <restriction base="xs:string"> <enumeration value="0118001"> <annotation> <documentation>axillär</documentation> </annotation> </enumeration> <enumeration value="0118002"> <annotation> <documentation>periareolär</documentation> </annotation> </enumeration> </restriction> </simpleType> </pre>		

	<pre> </annotation> </enumeration> <enumeration value="0118003"> <annotation> <documentation>inframammär</documentation> </annotation> </enumeration> <enumeration value="0118004"> <annotation> <documentation>Mastektomienarbe</documentation> </annotation> </enumeration> <enumeration value="0118042"> <annotation> <documentation>anderer</documentation> </annotation> </enumeration> </restriction> </simpleType> </pre>
--	--

simpleType enum_0120

namespace	http://xml.ir-d.de/stn		
type	restriction of string		
properties	base xs:string		
facets	Kind	Value	Annotation
	enumeration	0120001	documentation Expander defekt
annotation	documentation Kat_BI_BefundAustausch		
source	<pre> <simpleType name="enum_0120"> <annotation> <documentation>Kat_BI_BefundAustausch</documentation> </annotation> <restriction base="xs:string"> <enumeration value="0120001"> <annotation> <documentation>Expander defekt</documentation> </annotation> </enumeration> </restriction> </simpleType> </pre>		

simpleType enum_0121

namespace	http://xml.ir-d.de/stn		
type	restriction of string		
properties	base xs:string		
facets	Kind	Value	Annotation
	enumeration	0121001	documentation Infektion
	enumeration	0121002	documentation Serom
	enumeration	0121003	documentation

	<p>enumeration 0121004 Hämatom documentation</p> <p>enumeration 0121005 Kapselfibrose documentation</p> <p>enumeration 0121006 Implantatruptur documentation</p> <p>enumeration 0121007 Fehlpositionierung/Rotation documentation</p> <p>enumeration 0121008 BIA-ALCL/-SCC, Verdacht documentation</p> <p>enumeration 0121009 BIA-ALCL/-SCC, pathologisch bestätigt documentation</p> <p>enumeration 0121010 Brustschmerzen documentation</p> <p>enumeration 0121011 Doppelkapsel documentation</p> <p>enumeration 0121012 Netz-/ADM-bedingte Komplikation, Non-Integration documentation</p> <p>enumeration 0121013 Netz-/ADM-bedingte Komplikation, andere documentation</p> <p>enumeration 0121014 Hautnekrose/exponiertes Implantat documentation</p> <p>enumeration 0121015 BII/ASIA (Brustimplantat assoziierte Symptome), Verdacht documentation</p> <p>enumeration 0121016 Lymphadenopathie documentation</p> <p>Brustkrebs, neu aufgetreten/Rezidiv</p>
annotation	documentation Kat BI BefundKomplett
source	<pre> <simpleType name="enum_0121"> <annotation> <documentation>Kat_BI_BefundKomplett</documentation> </annotation> <restriction base="xs:string"> <enumeration value="0121001"> <annotation> <documentation>Infektion</documentation> </annotation> </enumeration> <enumeration value="0121002"> <annotation> <documentation>Serom</documentation> </annotation> </enumeration> <enumeration value="0121003"> <annotation> <documentation>Hämatom</documentation> </annotation> </enumeration> <enumeration value="0121004"> <annotation> <documentation>Kapselfibrose</documentation> </annotation> </enumeration> <enumeration value="0121005"> <annotation> <documentation>Implantatruptur</documentation> </annotation> </enumeration> <enumeration value="0121006"> <annotation> </pre>

```

    <documentation>Fehlpositionierung/Rotation</documentation>
  </annotation>
</enumeration>
<enumeration value="0121007">
  <annotation>
    <documentation>BIA-ALCL/-SCC, Verdacht</documentation>
  </annotation>
</enumeration>
<enumeration value="0121008">
  <annotation>
    <documentation>BIA-ALCL/-SCC, pathologisch bestätigt</documentation>
  </annotation>
</enumeration>
<enumeration value="0121009">
  <annotation>
    <documentation>Brustschmerzen</documentation>
  </annotation>
</enumeration>
<enumeration value="0121010">
  <annotation>
    <documentation>Doppelkapsel</documentation>
  </annotation>
</enumeration>
<enumeration value="0121011">
  <annotation>
    <documentation>Netz-/ADM-bedingte Komplikation,
Non-Integration</documentation>
  </annotation>
</enumeration>
<enumeration value="0121012">
  <annotation>
    <documentation>Netz-/ADM-bedingte Komplikation, andere</documentation>
  </annotation>
</enumeration>
<enumeration value="0121013">
  <annotation>
    <documentation>Hautnekrose/exponiertes Implantat</documentation>
  </annotation>
</enumeration>
<enumeration value="0121014">
  <annotation>
    <documentation>BII/ASIA (Brustimplantat assoziierte Symptome),
Verdacht</documentation>
  </annotation>
</enumeration>
<enumeration value="0121015">
  <annotation>
    <documentation>Lymphadenopathie</documentation>
  </annotation>
</enumeration>
<enumeration value="0121016">
  <annotation>
    <documentation>Brustkrebs, neu aufgetreten/Rezidiv</documentation>
  </annotation>
</enumeration>
</restriction>
</simpleType>

```

simpleType enum_0122

namespace	http://xml.ir-d.de/stn		
type	restriction of string		
properties	base xs:string		
facets	Kind	Value	Annotation
	enumeration	0122001	documentation ja, ärztlich nachgewiesen
	enumeration	0122002	documentation nein
	enumeration	0122042	documentation unbekannt
annotation	documentation Kat_BI_Autoimmunerkrankung		
source	<pre> <simpleType name="enum_0122"> <annotation> <documentation>Kat_BI_Autoimmunerkrankung</documentation> </annotation> <restriction base="xs:string"> <enumeration value="0122001"> <annotation> <documentation>ja, ärztlich nachgewiesen</documentation> </annotation> </enumeration> <enumeration value="0122002"> <annotation> <documentation>nein</documentation> </annotation> </enumeration> <enumeration value="0122042"> <annotation> <documentation>unbekannt</documentation> </annotation> </enumeration> </restriction> </simpleType> </pre>		

simpleType enum_0123

namespace	http://xml.ir-d.de/stn		
type	restriction of string		
properties	base xs:string		
facets	Kind	Value	Annotation
	enumeration	0123001	documentation neu aufgetreten
	enumeration	0123002	documentation verschlechtert
	enumeration	0123003	documentation keine Veränderung
	enumeration	0123004	documentation nicht relevant, da Primäreingriff
	enumeration	0123042	documentation unbekannt
annotation	documentation Kat_BI_VerlaufAutoimmunerkrankung		

source	<pre> <simpleType name="enum_0123"> <annotation> <documentation>Kat_BI_VerlaufAutoimmunerkrankung</documentation> </annotation> <restriction base="xs:string"> <enumeration value="0123001"> <annotation> <documentation>neu aufgetreten</documentation> </annotation> </enumeration> <enumeration value="0123002"> <annotation> <documentation>verschlechtert</documentation> </annotation> </enumeration> <enumeration value="0123003"> <annotation> <documentation>keine Veränderung</documentation> </annotation> </enumeration> <enumeration value="0123004"> <annotation> <documentation>nicht relevant, da Primäreingriff</documentation> </annotation> </enumeration> <enumeration value="0123042"> <annotation> <documentation>unbekannt</documentation> </annotation> </enumeration> </restriction> </simpleType> </pre>
--------	--

simpleType enum_0124

namespace	http://xml.ir-d.de/stn		
type	restriction of string		
properties	base xs:string		
facets	Kind	Value	Annotation
	enumeration	0124001	documentation Salzlösung
	enumeration	0124002	documentation Silikongel
	enumeration	0124003	documentation Kombination Silikongel und Salzlösung
	enumeration	0124042	documentation sonstige
annotation	documentation Kat_BI_Fuellung		
source	<pre> <simpleType name="enum_0124"> <annotation> <documentation>Kat_BI_Fuellung</documentation> </annotation> <restriction base="xs:string"> <enumeration value="0124001"> <annotation> <documentation>Salzlösung</documentation> </pre>		

	<pre> </annotation> </enumeration> <enumeration value="0124002"> <annotation> <documentation>Silikongel</documentation> </annotation> </enumeration> <enumeration value="0124003"> <annotation> <documentation>Kombination Silikongel und Salzlösung</documentation> </annotation> </enumeration> <enumeration value="0124042"> <annotation> <documentation>sonstige</documentation> </annotation> </enumeration> </restriction> </simpleType> </pre>
--	---

simpleType enum 0126

namespace	http://xml.ir-d.de/stn		
type	restriction of string		
properties	base xs:string		
facets	Kind	Value	Annotation
	enumeration	0126001	documentation anatomisch (tropfenförmig)
	enumeration	0126002	documentation rund (punktsymmetrisch)
	enumeration	0126042	documentation sonstige
annotation	documentation Kat_BI_Form		
source	<pre> <simpleType name="enum_0126"> <annotation> <documentation>Kat_BI_Form</documentation> </annotation> <restriction base="xs:string"> <enumeration value="0126001"> <annotation> <documentation>anatomisch (tropfenförmig)</documentation> </annotation> </enumeration> <enumeration value="0126002"> <annotation> <documentation>rund (punktsymmetrisch)</documentation> </annotation> </enumeration> <enumeration value="0126042"> <annotation> <documentation>sonstige</documentation> </annotation> </enumeration> </restriction> </simpleType> </pre>		

simpleType enum_0128

namespace	http://xml.ir-d.de/stn		
type	restriction of string		
properties	base xs:string		
facets	Kind	Value	Annotation
	enumeration	0128001	documentation glattwandig
	enumeration	0128002	documentation beschichtet
	enumeration	0128003	documentation texturiert
annotation	documentation Kat_BI_Oberflaeche		
source	<pre> <simpleType name="enum_0128"> <annotation> <documentation>Kat_BI_Oberflaeche</documentation> </annotation> <restriction base="xs:string"> <enumeration value="0128001"> <annotation> <documentation>glattwandig</documentation> </annotation> </enumeration> <enumeration value="0128002"> <annotation> <documentation>beschichtet</documentation> </annotation> </enumeration> <enumeration value="0128003"> <annotation> <documentation>texturiert</documentation> </annotation> </enumeration> </restriction> </simpleType> </pre>		

simpleType enum_0130

namespace	http://xml.ir-d.de/stn		
type	restriction of string		
properties	base xs:string		
facets	Kind	Value	Annotation
	enumeration	0130001	documentation Allergan
	enumeration	0130002	documentation Cereplas
	enumeration	0130003	documentation CUI (Cox Uphoff Implants)
	enumeration	0130004	documentation EMSI Biomedical
	enumeration	0130005	documentation Establishment labs
	enumeration	0130006	documentation Eurosilicone

	<p>enumeration 0130007 documentation Nagor</p> <p>enumeration 0130008 documentation Groupe Sebbin</p> <p>enumeration 0130009 documentation Laboratoires Arion</p> <p>enumeration 0130010 documentation Mentor</p> <p>enumeration 0130011 documentation Pérouse Plastie SAS</p> <p>enumeration 0130012 documentation PIP M-Implants</p> <p>enumeration 0130013 documentation Polytech Health & Aesthetics</p> <p>enumeration 0130014 documentation Silimed</p> <p>enumeration 0130015 documentation Surgitek</p> <p>enumeration 0130016 documentation G&G Biotechnology</p> <p>enumeration 0130017 documentation nicht belegter Wert</p> <p>enumeration 0130018 documentation nicht belegter Wert</p> <p>enumeration 0130019 documentation nicht belegter Wert</p> <p>enumeration 0130020 documentation nicht belegter Wert</p> <p>enumeration 0130021 documentation nicht belegter Wert</p> <p>enumeration 0130042 documentation sonstiger</p>
annotation	documentation Kat_BI_Hersteller
source	<pre> <simpleType name="enum_0130"> <annotation> <documentation>Kat_BI_Hersteller</documentation> </annotation> <restriction base="xs:string"> <enumeration value="0130001"> <annotation> <documentation>Allergan</documentation> </annotation> </enumeration> <enumeration value="0130002"> <annotation> <documentation>Cereplas</documentation> </annotation> </enumeration> <enumeration value="0130003"> <annotation> <documentation>CUI (Cox Uphoff Implants)</documentation> </annotation> </enumeration> <enumeration value="0130004"> <annotation> <documentation>EMSI Biomedical</documentation> </annotation> </enumeration> <enumeration value="0130005"> <annotation> <documentation>Establishment labs</documentation> </annotation> </enumeration> </restriction> </simpleType> </pre>

```
</annotation>
</enumeration>
<enumeration value="0130006">
  <annotation>
    <documentation>Eurosilicone</documentation>
  </annotation>
</enumeration>
<enumeration value="0130007">
  <annotation>
    <documentation>Nagor</documentation>
  </annotation>
</enumeration>
<enumeration value="0130008">
  <annotation>
    <documentation>Groupe Sebbin</documentation>
  </annotation>
</enumeration>
<enumeration value="0130009">
  <annotation>
    <documentation>Laboratoires Arion</documentation>
  </annotation>
</enumeration>
<enumeration value="0130010">
  <annotation>
    <documentation>Mentor</documentation>
  </annotation>
</enumeration>
<enumeration value="0130011">
  <annotation>
    <documentation>Pérouse Plastie SAS</documentation>
  </annotation>
</enumeration>
<enumeration value="0130012">
  <annotation>
    <documentation>PIP M-Implants</documentation>
  </annotation>
</enumeration>
<enumeration value="0130013">
  <annotation>
    <documentation>Polytech Health & Aesthetics</documentation>
  </annotation>
</enumeration>
<enumeration value="0130014">
  <annotation>
    <documentation>Silimed</documentation>
  </annotation>
</enumeration>
<enumeration value="0130015">
  <annotation>
    <documentation>Surgitek</documentation>
  </annotation>
</enumeration>
<enumeration value="0130016">
  <annotation>
    <documentation>G&G Biotechnology</documentation>
  </annotation>
</enumeration>
<enumeration value="0130017">
  <annotation>
```

```

    <documentation>nicht belegter Wert</documentation>
  </annotation>
</enumeration>
<enumeration value="0130018">
  <annotation>
    <documentation>nicht belegter Wert</documentation>
  </annotation>
</enumeration>
<enumeration value="0130019">
  <annotation>
    <documentation>nicht belegter Wert</documentation>
  </annotation>
</enumeration>
<enumeration value="0130020">
  <annotation>
    <documentation>nicht belegter Wert</documentation>
  </annotation>
</enumeration>
<enumeration value="0130021">
  <annotation>
    <documentation>nicht belegter Wert</documentation>
  </annotation>
</enumeration>
<enumeration value="0130042">
  <annotation>
    <documentation>sonstiger</documentation>
  </annotation>
</enumeration>
</restriction>
</simpleType>

```

simpleType enum_0131

namespace	http://xml.ir-d.de/stn		
type	restriction of string		
properties	base xs:string		
facets	Kind	Value	Annotation
	enumeration	0131001	documentation Allergan
	enumeration	0131002	documentation Establishment labs
	enumeration	0131003	documentation Eurosilicone
	enumeration	0131004	documentation Galatea
	enumeration	0131005	documentation Integra
	enumeration	0131006	documentation Lifecell
	enumeration	0131007	documentation MBP (Medical Biomaterial Products)
	enumeration	0131008	documentation Mentor
	enumeration	0131009	documentation Novus Scientific
	enumeration	0131042	documentation sonstiger
annotation	documentation		

Kat_BI_ZubehoerHersteller

source

```
<simpleType name="enum_0131">
  <annotation>
    <documentation>Kat_BI_ZubehoerHersteller</documentation>
  </annotation>
  <restriction base="xs:string">
    <enumeration value="0131001">
      <annotation>
        <documentation>Allergan</documentation>
      </annotation>
    </enumeration>
    <enumeration value="0131002">
      <annotation>
        <documentation>Establishment labs</documentation>
      </annotation>
    </enumeration>
    <enumeration value="0131003">
      <annotation>
        <documentation>Eurosilicone</documentation>
      </annotation>
    </enumeration>
    <enumeration value="0131004">
      <annotation>
        <documentation>Galatea</documentation>
      </annotation>
    </enumeration>
    <enumeration value="0131005">
      <annotation>
        <documentation>Integra</documentation>
      </annotation>
    </enumeration>
    <enumeration value="0131006">
      <annotation>
        <documentation>Lifecell</documentation>
      </annotation>
    </enumeration>
    <enumeration value="0131007">
      <annotation>
        <documentation>MBP (Medical Biomaterial Products)</documentation>
      </annotation>
    </enumeration>
    <enumeration value="0131008">
      <annotation>
        <documentation>Mentor</documentation>
      </annotation>
    </enumeration>
    <enumeration value="0131009">
      <annotation>
        <documentation>Novus Scientific</documentation>
      </annotation>
    </enumeration>
    <enumeration value="0131042">
      <annotation>
        <documentation>sonstiger</documentation>
      </annotation>
    </enumeration>
  </restriction>
</simpleType>
```

simpleType enum_0190

namespace	http://xml.ir-d.de/stn		
type	restriction of string		
properties	base xs:string		
facets	Kind	Value	Annotation
	enumeration	0190001	documentation Brustimplantat
	enumeration	0190003	documentation Brustexpander
annotation	documentation Kat_BI_Artikeltyp		
source	<pre> <simpleType name="enum_0190"> <annotation> <documentation>Kat_BI_Artikeltyp</documentation> </annotation> <restriction base="xs:string"> <enumeration value="0190001"> <annotation> <documentation>Brustimplantat</documentation> </annotation> </enumeration> <enumeration value="0190003"> <annotation> <documentation>Brustexpander</documentation> </annotation> </enumeration> </restriction> </simpleType> </pre>		

simpleType enum_0191

namespace	http://xml.ir-d.de/stn		
type	restriction of string		
properties	base xs:string		
facets	Kind	Value	Annotation
	enumeration	0191001	documentation Netz
	enumeration	0191002	documentation ADM
annotation	documentation Kat_BI_ZubehoerTyp		
source	<pre> <simpleType name="enum_0191"> <annotation> <documentation>Kat_BI_ZubehoerTyp</documentation> </annotation> <restriction base="xs:string"> <enumeration value="0191001"> <annotation> <documentation>Netz</documentation> </annotation> </enumeration> <enumeration value="0191002"> </pre>		

	<pre> <annotation> <documentation>ADM</documentation> </annotation> </enumeration> </restriction> </simpleType> </pre>
--	--

simpleType enum_0200

namespace	http://xml.ir-d.de/stn		
type	restriction of string		
properties	base xs:string		
facets	Kind	Value	Annotation
	enumeration	0200001	documentation Erst-OP
	enumeration	0200002	documentation Folgeeingriff
annotation	documentation Kat_EP_ArtEingriff		
source	<pre> <simpleType name="enum_0200"> <annotation> <documentation>Kat_EP_ArtEingriff</documentation> </annotation> <restriction base="xs:string"> <enumeration value="0200001"> <annotation> <documentation>Erst-OP</documentation> </annotation> </enumeration> <enumeration value="0200002"> <annotation> <documentation>Folgeeingriff</documentation> </annotation> </enumeration> </restriction> </simpleType> </pre>		

simpleType enum_0202

namespace	http://xml.ir-d.de/stn		
type	restriction of string		
properties	base xs:string		
facets	Kind	Value	Annotation
	enumeration	0202001	documentation Lockerung
	enumeration	0202002	documentation Infektion, Verdacht auf
	enumeration	0202003	documentation Infektion, gesichert
	enumeration	0202004	documentation Luxation, Inlay aus der Pfanne
	enumeration	0202005	documentation Luxation, Kopf aus Pfanne/Inlay
	enumeration	0202006	documentation Periprothetische Fraktur

	<p>enumeration 0202007 documentation Verschleiß des PE-Inlays</p> <p>enumeration 0202008 documentation Implantatbruch</p> <p>enumeration 0202009 documentation Implantatfehlage/Malalignement</p> <p>enumeration 0202010 documentation Osteolysen bei festem Implantat</p> <p>enumeration 0202011 documentation Progression der Grunderkrankung</p> <p>enumeration 0202012 documentation ARM-D</p> <p>enumeration 0202013 documentation Verdacht auf allergische Reaktion</p> <p>enumeration 0202021 documentation Zustand nach Prothesenentfernung</p> <p>enumeration 0202042 documentation andere Gründe</p>
annotation	documentation Kat_EP_GrundWechselHuefte
source	<pre> <simpleType name="enum_0202"> <annotation> <documentation>Kat_EP_GrundWechselHuefte</documentation> </annotation> <restriction base="xs:string"> <enumeration value="0202001"> <annotation> <documentation>Lockerung</documentation> </annotation> </enumeration> <enumeration value="0202002"> <annotation> <documentation>Infektion, Verdacht auf</documentation> </annotation> </enumeration> <enumeration value="0202003"> <annotation> <documentation>Infektion, gesichert</documentation> </annotation> </enumeration> <enumeration value="0202004"> <annotation> <documentation>Luxation, Inlay aus der Pfanne</documentation> </annotation> </enumeration> <enumeration value="0202005"> <annotation> <documentation>Luxation, Kopf aus Pfanne/Inlay</documentation> </annotation> </enumeration> <enumeration value="0202006"> <annotation> <documentation>Periprothetische Fraktur</documentation> </annotation> </enumeration> <enumeration value="0202007"> <annotation> <documentation>Verschleiß des PE-Inlays</documentation> </annotation> </enumeration> </restriction> </simpleType> </pre>

```

<enumeration value="0202008">
  <annotation>
    <documentation>Implantatbruch</documentation>
  </annotation>
</enumeration>
<enumeration value="0202009">
  <annotation>
    <documentation>Implantatfehllage/Malalignent</documentation>
  </annotation>
</enumeration>
<enumeration value="0202010">
  <annotation>
    <documentation>Osteolysen bei festem Implantat</documentation>
  </annotation>
</enumeration>
<enumeration value="0202011">
  <annotation>
    <documentation>Progression der Grunderkrankung</documentation>
  </annotation>
</enumeration>
<enumeration value="0202012">
  <annotation>
    <documentation>ARMD</documentation>
  </annotation>
</enumeration>
<enumeration value="0202013">
  <annotation>
    <documentation>Verdacht auf allergische Reaktion</documentation>
  </annotation>
</enumeration>
<enumeration value="0202021">
  <annotation>
    <documentation>Zustand nach Prothesenentfernung</documentation>
  </annotation>
</enumeration>
<enumeration value="0202042">
  <annotation>
    <documentation>andere Gründe</documentation>
  </annotation>
</enumeration>
</restriction>
</simpleType>

```

simpleType enum_0204

namespace	http://xml.ir-d.de/stn		
type	restriction of string		
properties	base xs:string		
facets	Kind	Value	Annotation
	enumeration	0204001	documentation Lockerung
	enumeration	0204002	documentation Infektion, Verdacht auf
	enumeration	0204003	documentation Infektion, gesichert
	enumeration	0204006	documentation Periprothetische Fraktur

	<p>enumeration 0204007 documentation Verschleiß</p> <p>enumeration 0204008 documentation Implantatbruch</p> <p>enumeration 0204009 documentation Implantatfehlage/Malalignement</p> <p>enumeration 0204010 documentation Osteolysen bei festem Implantat</p> <p>enumeration 0204011 documentation Progression der Grunderkrankung</p> <p>enumeration 0204012 documentation ARM D</p> <p>enumeration 0204013 documentation Verdacht auf allergische Reaktion</p> <p>enumeration 0204014 documentation Dislokation/Migration von Komponenten</p> <p>enumeration 0204015 documentation Bandinstabilität</p> <p>enumeration 0204016 documentation Bewegungseinschränkung</p> <p>enumeration 0204021 documentation Zustand nach Prothesenentfernung</p> <p>enumeration 0204042 documentation andere Gründe</p>
annotation	documentation Kat_EP_GrundWechselKnie
source	<pre> <simpleType name="enum_0204"> <annotation> <documentation>Kat_EP_GrundWechselKnie</documentation> </annotation> <restriction base="xs:string"> <enumeration value="0204001"> <annotation> <documentation>Lockerung</documentation> </annotation> </enumeration> <enumeration value="0204002"> <annotation> <documentation>Infektion, Verdacht auf</documentation> </annotation> </enumeration> <enumeration value="0204003"> <annotation> <documentation>Infektion, gesichert</documentation> </annotation> </enumeration> <enumeration value="0204006"> <annotation> <documentation>Periprothetische Fraktur</documentation> </annotation> </enumeration> <enumeration value="0204007"> <annotation> <documentation>Verschleiß</documentation> </annotation> </enumeration> <enumeration value="0204008"> <annotation> <documentation>Implantatbruch</documentation> </annotation> </enumeration> </restriction> </simpleType> </pre>

```

<enumeration value="0204009">
  <annotation>
    <documentation>Implantatfehllage/Malalignent</documentation>
  </annotation>
</enumeration>
<enumeration value="0204010">
  <annotation>
    <documentation>Osteolysen bei festem Implantat</documentation>
  </annotation>
</enumeration>
<enumeration value="0204011">
  <annotation>
    <documentation>Progression der Grunderkrankung</documentation>
  </annotation>
</enumeration>
<enumeration value="0204012">
  <annotation>
    <documentation>ARMD</documentation>
  </annotation>
</enumeration>
<enumeration value="0204013">
  <annotation>
    <documentation>Verdacht auf allergische Reaktion</documentation>
  </annotation>
</enumeration>
<enumeration value="0204014">
  <annotation>
    <documentation>Dislokation/Migration von Komponenten</documentation>
  </annotation>
</enumeration>
<enumeration value="0204015">
  <annotation>
    <documentation>Bandinstabilität</documentation>
  </annotation>
</enumeration>
<enumeration value="0204016">
  <annotation>
    <documentation>Bewegungseinschränkung</documentation>
  </annotation>
</enumeration>
<enumeration value="0204021">
  <annotation>
    <documentation>Zustand nach Prothesenentfernung</documentation>
  </annotation>
</enumeration>
<enumeration value="0204042">
  <annotation>
    <documentation>andere Gründe</documentation>
  </annotation>
</enumeration>
</restriction>
</simpleType>

```

simpleType **enum_0206**

namespace	http://xml.ir-d.de/stn
type	restriction of string

properties	base	xs:string	
facets	Kind	Value	Annotation
	enumeration	0206001	documentation Lockerung
	enumeration	0206002	documentation Infektion, Verdacht auf
	enumeration	0206003	documentation Infektion, gesichert
	enumeration	0206004	documentation Luxation, Inlay aus der Pfanne
	enumeration	0206005	documentation Luxation, Kopf aus Pfanne/Inlay
	enumeration	0206006	documentation Periprothetische Fraktur
	enumeration	0206007	documentation Verschleiß
	enumeration	0206008	documentation Implantatbruch
	enumeration	0206009	documentation Implantatfehlage/Malalignement
	enumeration	0206010	documentation Osteolysen bei festem Implantat
	enumeration	0206011	documentation Progression der Grunderkrankung
	enumeration	0206012	documentation ARM-D
	enumeration	0206013	documentation Verdacht auf allergische Reaktion
	enumeration	0206014	documentation Dislokation/Migration von Komponenten
	enumeration	0206015	documentation Bandinstabilität
	enumeration	0206016	documentation Bewegungseinschränkung
	enumeration	0206021	documentation Zustand nach Prothesenentfernung
	enumeration	0206042	documentation andere Gründe
annotation	documentation		Kat_EP_GrundWechselTFE
source	<pre> <simpleType name="enum_0206"> <annotation> <documentation>Kat_EP_GrundWechselTFE</documentation> </annotation> <restriction base="xs:string"> <enumeration value="0206001"> <annotation> <documentation>Lockerung</documentation> </annotation> </enumeration> <enumeration value="0206002"> <annotation> <documentation>Infektion, Verdacht auf</documentation> </annotation> </enumeration> <enumeration value="0206003"> <annotation> <documentation>Infektion, gesichert</documentation> </annotation> </enumeration> <enumeration value="0206004"> <annotation> </pre>		

```
<documentation>Luxation, Inlay aus der Pfanne</documentation>
</annotation>
</enumeration>
<enumeration value="0206005">
  <annotation>
    <documentation>Luxation, Kopf aus Pfanne/Inlay</documentation>
  </annotation>
</enumeration>
<enumeration value="0206006">
  <annotation>
    <documentation>Periprothetische Fraktur</documentation>
  </annotation>
</enumeration>
<enumeration value="0206007">
  <annotation>
    <documentation>Verschleiß</documentation>
  </annotation>
</enumeration>
<enumeration value="0206008">
  <annotation>
    <documentation>Implantatbruch</documentation>
  </annotation>
</enumeration>
<enumeration value="0206009">
  <annotation>
    <documentation>Implantatfehlage/Malalignent</documentation>
  </annotation>
</enumeration>
<enumeration value="0206010">
  <annotation>
    <documentation>Osteolysen bei festem Implantat</documentation>
  </annotation>
</enumeration>
<enumeration value="0206011">
  <annotation>
    <documentation>Progression der Grunderkrankung</documentation>
  </annotation>
</enumeration>
<enumeration value="0206012">
  <annotation>
    <documentation>ARMD</documentation>
  </annotation>
</enumeration>
<enumeration value="0206013">
  <annotation>
    <documentation>Verdacht auf allergische Reaktion</documentation>
  </annotation>
</enumeration>
<enumeration value="0206014">
  <annotation>
    <documentation>Dislokation/Migration von Komponenten</documentation>
  </annotation>
</enumeration>
<enumeration value="0206015">
  <annotation>
    <documentation>Bandinstabilität</documentation>
  </annotation>
</enumeration>
<enumeration value="0206016">
```

	<pre> <annotation> <documentation>Bewegungseinschränkung</documentation> </annotation> </enumeration> <enumeration value="0206021"> <annotation> <documentation>Zustand nach Prothesenentfernung</documentation> </annotation> </enumeration> <enumeration value="0206042"> <annotation> <documentation>andere Gründe</documentation> </annotation> </enumeration> </restriction> </simpleType> </pre>
--	--

simpleType enum_0210

namespace	http://xml.ir-d.de/stn		
type	restriction of string		
properties	base xs:string		
facets	Kind	Value	Annotation
	enumeration	0210001	documentation keine relevante Voroperation
	enumeration	0210002	documentation Osteosynthese/Osteotomie (Becken)
	enumeration	0210003	documentation Osteosynthese/Osteotomie (Femur)
	enumeration	0210004	documentation Osteosynthese/Osteotomie (beides)
	enumeration	0210005	documentation Operation bei Hüftkopfnekrose
	enumeration	0210006	documentation Arthrodese
	enumeration	0210042	documentation andere
annotation	documentation Kat_EP_VoroperationHuefte		
source	<pre> <simpleType name="enum_0210"> <annotation> <documentation>Kat_EP_VoroperationHuefte</documentation> </annotation> <restriction base="xs:string"> <enumeration value="0210001"> <annotation> <documentation>keine relevante Voroperation</documentation> </annotation> </enumeration> <enumeration value="0210002"> <annotation> <documentation>Osteosynthese/Osteotomie (Becken)</documentation> </annotation> </enumeration> <enumeration value="0210003"> <annotation> <documentation>Osteosynthese/Osteotomie (Femur)</documentation> </annotation> </enumeration> </restriction> </simpleType> </pre>		

	<pre> </annotation> </enumeration> <enumeration value="0210004"> <annotation> <documentation>Osteosynthese/Osteotomie (beides)</documentation> </annotation> </enumeration> <enumeration value="0210005"> <annotation> <documentation>Operation bei Hüftkopfnekrose</documentation> </annotation> </enumeration> <enumeration value="0210006"> <annotation> <documentation>Arthrodese</documentation> </annotation> </enumeration> <enumeration value="0210042"> <annotation> <documentation>andere</documentation> </annotation> </enumeration> </restriction> </simpleType> </pre>
--	--

simpleType enum_0211

namespace	http://xml.ir-d.de/stn		
type	restriction of string		
properties	base xs:string		
facets	Kind	Value	Annotation
	enumeration	0211001	documentation keine relevante Voroperation
	enumeration	0211002	documentation Osteosynthese/Osteotomie (Femur)
	enumeration	0211003	documentation Osteosynthese/Osteotomie (Tibia)
	enumeration	0211004	documentation Osteosynthese/Osteotomie (Patella)
	enumeration	0211005	documentation Osteosynthese/Osteotomie (mehrere)
	enumeration	0211006	documentation Kapsel-/Bandapparat
	enumeration	0211007	documentation Arthrodese
	enumeration	0211042	documentation andere
annotation	documentation Kat_EP_VoroperationKnie		
source	<pre> <simpleType name="enum_0211"> <annotation> <documentation>Kat_EP_VoroperationKnie</documentation> </annotation> <restriction base="xs:string"> <enumeration value="0211001"> <annotation> <documentation>keine relevante Voroperation</documentation> </annotation> </pre>		

```

</enumeration>
<enumeration value="0211002">
  <annotation>
    <documentation>Osteosynthese/Osteotomie (Femur)</documentation>
  </annotation>
</enumeration>
<enumeration value="0211003">
  <annotation>
    <documentation>Osteosynthese/Osteotomie (Tibia)</documentation>
  </annotation>
</enumeration>
<enumeration value="0211004">
  <annotation>
    <documentation>Osteosynthese/Osteotomie (Patella)</documentation>
  </annotation>
</enumeration>
<enumeration value="0211005">
  <annotation>
    <documentation>Osteosynthese/Osteotomie (mehrere)</documentation>
  </annotation>
</enumeration>
<enumeration value="0211006">
  <annotation>
    <documentation>Kapsel-/Bandapparat</documentation>
  </annotation>
</enumeration>
<enumeration value="0211007">
  <annotation>
    <documentation>Arthrodesse</documentation>
  </annotation>
</enumeration>
<enumeration value="0211042">
  <annotation>
    <documentation>andere</documentation>
  </annotation>
</enumeration>
</restriction>
</simpleType>

```

simpleType **enum_0212**

namespace	http://xml.ir-d.de/stn		
type	restriction of string		
properties	base xs:string		
facets	Kind	Value	Annotation
	enumeration	0212001	documentation Hüfte
	enumeration	0212002	documentation Knie
	enumeration	0212003	documentation Totaler Femurersatz inkl. Durchsteck-Prothese
annotation	documentation Kat_EP_Gelenk		
source	<simpleType name="enum_0212"> <annotation> <documentation>Kat_EP_Gelenk</documentation> </annotation>		

	<pre> <restriction base="xs:string"> <enumeration value="0212001"> <annotation> <documentation>Hüfte</documentation> </annotation> </enumeration> <enumeration value="0212002"> <annotation> <documentation>Knie</documentation> </annotation> </enumeration> <enumeration value="0212003"> <annotation> <documentation>Totaler Femurersatz inkl. Durchsteck-Prothese</documentation> </annotation> </enumeration> </restriction> </simpleType> </pre>
--	--

simpleType enum 0220

namespace	http://xml.ir-d.de/stn		
type	restriction of string		
properties	base xs:string		
facets	Kind	Value	Annotation
	enumeration	0220001	documentation anterior
	enumeration	0220002	documentation anterolateral
	enumeration	0220003	documentation lateral
	enumeration	0220004	documentation posterior
	enumeration	0220005	documentation posterolateral
	enumeration	0220006	documentation 2-Inzisionen-Zugang
	enumeration	0220042	documentation sonstiges/unbekannt
annotation	documentation Kat_EP_Operationszugang		
source	<pre> <simpleType name="enum_0220"> <annotation> <documentation>Kat_EP_Operationszugang</documentation> </annotation> <restriction base="xs:string"> <enumeration value="0220001"> <annotation> <documentation>anterior</documentation> </annotation> </enumeration> <enumeration value="0220002"> <annotation> <documentation>anterolateral</documentation> </annotation> </enumeration> </pre>		

	<pre> <enumeration value="0220003"> <annotation> <documentation>lateral</documentation> </annotation> </enumeration> <enumeration value="0220004"> <annotation> <documentation>posterior</documentation> </annotation> </enumeration> <enumeration value="0220005"> <annotation> <documentation>posterolateral</documentation> </annotation> </enumeration> <enumeration value="0220006"> <annotation> <documentation>2-Inzisionen-Zugang</documentation> </annotation> </enumeration> <enumeration value="0220042"> <annotation> <documentation>sonstiges/unbekannt</documentation> </annotation> </enumeration> </restriction> </simpleType> </pre>
--	---

simpleType enum_0222

namespace	http://xml.ir-d.de/strn		
type	restriction of string		
properties	base xs:string		
facets	Kind	Value	Annotation
	enumeration	0222001	documentation nein
	enumeration	0222002	documentation ja- Ausbau
	enumeration	0222003	documentation ja- Einbau
annotation	documentation Kat_EP_Zweizeitwechsel		
source	<pre> <simpleType name="enum_0222"> <annotation> <documentation>Kat_EP_Zweizeitwechsel</documentation> </annotation> <restriction base="xs:string"> <enumeration value="0222001"> <annotation> <documentation>nein</documentation> </annotation> </enumeration> <enumeration value="0222002"> <annotation> <documentation>ja- Ausbau</documentation> </annotation> </enumeration> </restriction> </simpleType> </pre>		

```

<enumeration value="0222003">
  <annotation>
    <documentation>ja- Einbau</documentation>
  </annotation>
</enumeration>
</restriction>
</simpleType>

```

simpleType enum_0230

namespace	http://xml.ir-d.de/stn		
type	restriction of string		
properties	base xs:string		
facets	Kind	Value	Annotation
	enumeration	0230001	documentation Smith & Nephew GmbH
	enumeration	0230002	documentation Mathys Orthopädie GmbH
	enumeration	0230003	documentation Ceramtec AG
	enumeration	0230004	documentation Biomet
	enumeration	0230005	documentation Peter Brehm GmbH
	enumeration	0230006	documentation Amplitude GmbH
	enumeration	0230007	documentation Exactech Deutschland
	enumeration	0230008	documentation Globus Medical
	enumeration	0230009	documentation Implantcast GmbH
	enumeration	0230010	documentation DePuy Orthopädie GmbH
	enumeration	0230011	documentation IO-International Orthopaedics
	enumeration	0230012	documentation Joint Replacement Ltd. Instrumentation
	enumeration	0230013	documentation Merete
	enumeration	0230014	documentation S&G Implants GmbH
	enumeration	0230015	documentation Speetec Implantate GmbH
	enumeration	0230016	documentation Stemcup Medical Products GmbH
	enumeration	0230017	documentation Symbios Deutschland GmbH
	enumeration	0230018	documentation Tantum AG
	enumeration	0230019	documentation Tornier GmbH
	enumeration	0230020	documentation MicroPort Orthopedics GmbH
	enumeration	0230021	documentation aap Implanate AG
	enumeration	0230022	documentation AQImplants
	enumeration	0230023	documentation ESKA Orthodynamics GmbH
	enumeration	0230024	documentation

	<p>enumeration 0230025 Atesos medical AG documentation Chiropro GmbH</p> <p>enumeration 0230026 documentation Medacta</p> <p>enumeration 0230027 documentation OHST Medizintechnik AG</p> <p>enumeration 0230028 documentation Lima Deutschland GmbH</p> <p>enumeration 0230029 documentation alloPlus GmbH</p> <p>enumeration 0230030 documentation Heraeus Medical GmbH</p> <p>enumeration 0230031 documentation ImplanTec Deutschland GmbH</p> <p>enumeration 0230032 documentation Falcon Medical GmbH</p> <p>enumeration 0230033 documentation Meril GmbH</p> <p>enumeration 0230034 documentation Zimmer Germany GmbH</p> <p>enumeration 0230035 documentation Stryker GmbH & Co. KG</p> <p>enumeration 0230036 documentation Aesculap AG</p> <p>enumeration 0230037 documentation Waldemar Link GmbH & Co. KG</p> <p>enumeration 0230038 documentation Corin Germany GmbH</p> <p>enumeration 0230039 documentation nicht belegter Wert</p> <p>enumeration 0230040 documentation nicht belegter Wert</p> <p>enumeration 0230041 documentation nicht belegter Wert</p> <p>enumeration 0230042 documentation sonstige</p> <p>enumeration 0230043 documentation nicht belegter Wert</p> <p>enumeration 0230044 documentation nicht belegter Wert</p>
annotation	documentation Kat_EP_Hersteller
source	<pre> <simpleType name="enum_0230"> <annotation> <documentation>Kat_EP_Hersteller</documentation> </annotation> <restriction base="xs:string"> <enumeration value="0230001"> <annotation> <documentation>Smith & Nephew GmbH</documentation> </annotation> </enumeration> <enumeration value="0230002"> <annotation> <documentation>Mathys Orthopädie GmbH</documentation> </annotation> </enumeration> <enumeration value="0230003"> <annotation> <documentation>Ceramtec AG</documentation> </annotation> </enumeration> </restriction> </simpleType> </pre>

```
<enumeration value="0230004">
  <annotation>
    <documentation>Biomet</documentation>
  </annotation>
</enumeration>
<enumeration value="0230005">
  <annotation>
    <documentation>Peter Brehm GmbH</documentation>
  </annotation>
</enumeration>
<enumeration value="0230006">
  <annotation>
    <documentation>Amplitude GmbH</documentation>
  </annotation>
</enumeration>
<enumeration value="0230007">
  <annotation>
    <documentation>Exactech Deutschland</documentation>
  </annotation>
</enumeration>
<enumeration value="0230008">
  <annotation>
    <documentation>Globus Medical</documentation>
  </annotation>
</enumeration>
<enumeration value="0230009">
  <annotation>
    <documentation>Implantcast GmbH</documentation>
  </annotation>
</enumeration>
<enumeration value="0230010">
  <annotation>
    <documentation>DePuy Orthopädie GmbH</documentation>
  </annotation>
</enumeration>
<enumeration value="0230011">
  <annotation>
    <documentation>IO-International Orthopaedics</documentation>
  </annotation>
</enumeration>
<enumeration value="0230012">
  <annotation>
    <documentation>Joint Replacement Ltd. Instrumentation</documentation>
  </annotation>
</enumeration>
<enumeration value="0230013">
  <annotation>
    <documentation>Merete</documentation>
  </annotation>
</enumeration>
<enumeration value="0230014">
  <annotation>
    <documentation>S&G Implants GmbH</documentation>
  </annotation>
</enumeration>
<enumeration value="0230015">
  <annotation>
    <documentation>Speetec Implantate GmbH</documentation>
  </annotation>
</enumeration>
```



```
</enumeration>
<enumeration value="0230016">
  <annotation>
    <documentation>Stemcup Medical Products GmbH</documentation>
  </annotation>
</enumeration>
<enumeration value="0230017">
  <annotation>
    <documentation>Symbios Deutschland GmbH</documentation>
  </annotation>
</enumeration>
<enumeration value="0230018">
  <annotation>
    <documentation>Tantum AG</documentation>
  </annotation>
</enumeration>
<enumeration value="0230019">
  <annotation>
    <documentation>Tornier GmbH</documentation>
  </annotation>
</enumeration>
<enumeration value="0230020">
  <annotation>
    <documentation>MicroPort Orthopedics GmbH</documentation>
  </annotation>
</enumeration>
<enumeration value="0230021">
  <annotation>
    <documentation>aap Implanate AG</documentation>
  </annotation>
</enumeration>
<enumeration value="0230022">
  <annotation>
    <documentation>AQImplants</documentation>
  </annotation>
</enumeration>
<enumeration value="0230023">
  <annotation>
    <documentation>ESKA Orthodynamics GmbH</documentation>
  </annotation>
</enumeration>
<enumeration value="0230024">
  <annotation>
    <documentation>Ateos medical AG</documentation>
  </annotation>
</enumeration>
<enumeration value="0230025">
  <annotation>
    <documentation>Chiropro GmbH</documentation>
  </annotation>
</enumeration>
<enumeration value="0230026">
  <annotation>
    <documentation>Medacta</documentation>
  </annotation>
</enumeration>
<enumeration value="0230027">
  <annotation>
    <documentation>OHST Medizintechnik AG</documentation>
  </annotation>
</enumeration>
```

```
</annotation>
</enumeration>
<enumeration value="0230028">
  <annotation>
    <documentation>Lima Deutschland GmbH</documentation>
  </annotation>
</enumeration>
<enumeration value="0230029">
  <annotation>
    <documentation>alloPlus GmbH</documentation>
  </annotation>
</enumeration>
<enumeration value="0230030">
  <annotation>
    <documentation>Heraeus Medical GmbH</documentation>
  </annotation>
</enumeration>
<enumeration value="0230031">
  <annotation>
    <documentation>ImplanTec Deutschland GmbH</documentation>
  </annotation>
</enumeration>
<enumeration value="0230032">
  <annotation>
    <documentation>Falcon Medical GmbH</documentation>
  </annotation>
</enumeration>
<enumeration value="0230033">
  <annotation>
    <documentation>Meril GmbH</documentation>
  </annotation>
</enumeration>
<enumeration value="0230034">
  <annotation>
    <documentation>Zimmer Germany GmbH</documentation>
  </annotation>
</enumeration>
<enumeration value="0230035">
  <annotation>
    <documentation>Stryker GmbH & Co. KG</documentation>
  </annotation>
</enumeration>
<enumeration value="0230036">
  <annotation>
    <documentation>Aesculap AG</documentation>
  </annotation>
</enumeration>
<enumeration value="0230037">
  <annotation>
    <documentation>Waldemar Link GmbH & Co. KG</documentation>
  </annotation>
</enumeration>
<enumeration value="0230038">
  <annotation>
    <documentation>Corin Germany GmbH</documentation>
  </annotation>
</enumeration>
<enumeration value="0230039">
  <annotation>
```

	<pre> <documentation>nicht belegter Wert</documentation> </annotation> </enumeration> <enumeration value="0230040"> <annotation> <documentation>nicht belegter Wert</documentation> </annotation> </enumeration> <enumeration value="0230041"> <annotation> <documentation>nicht belegter Wert</documentation> </annotation> </enumeration> <enumeration value="0230042"> <annotation> <documentation>sonstige</documentation> </annotation> </enumeration> <enumeration value="0230043"> <annotation> <documentation>nicht belegter Wert</documentation> </annotation> </enumeration> <enumeration value="0230044"> <annotation> <documentation>nicht belegter Wert</documentation> </annotation> </enumeration> </restriction> </simpleType> </pre>
--	---

simpleType enum_0252

namespace	http://xml.ir-d.de/stn		
type	restriction of string		
properties	base xs:string		
facets	Kind	Value	Annotation
	enumeration	0252001	documentation Pfanne
	enumeration	0252002	documentation Schaft
	enumeration	0252003	documentation beides
annotation	documentation Kat_EP_KomponenteHuefte		
source	<pre> <simpleType name="enum_0252"> <annotation> <documentation>Kat_EP_KomponenteHuefte</documentation> </annotation> <restriction base="xs:string"> <enumeration value="0252001"> <annotation> <documentation>Pfanne</documentation> </annotation> </enumeration> <enumeration value="0252002"> <annotation> </pre>		

	<pre> <documentation>Schaft</documentation> </annotation> </enumeration> <enumeration value="0252003"> <annotation> <documentation>beides</documentation> </annotation> </enumeration> </restriction> </simpleType> </pre>
--	--

simpleType enum_0254

namespace	http://xml.ir-d.de/stn		
type	restriction of string		
properties	base xs:string		
facets	Kind	Value	Annotation
	enumeration	0254001	documentation Femur
	enumeration	0254002	documentation Tibia
	enumeration	0254003	documentation Patella
	enumeration	0254004	documentation mehrere
annotation	documentation Kat_EP_KomponenteKnie		
source	<pre> <simpleType name="enum_0254"> <annotation> <documentation>Kat_EP_KomponenteKnie</documentation> </annotation> <restriction base="xs:string"> <enumeration value="0254001"> <annotation> <documentation>Femur</documentation> </annotation> </enumeration> <enumeration value="0254002"> <annotation> <documentation>Tibia</documentation> </annotation> </enumeration> <enumeration value="0254003"> <annotation> <documentation>Patella</documentation> </annotation> </enumeration> <enumeration value="0254004"> <annotation> <documentation>mehrere</documentation> </annotation> </enumeration> </restriction> </simpleType> </pre>		

simpleType enum_0256

namespace	http://xml.ir-d.de/stn		
type	restriction of string		
properties	base xs:string		
facets	Kind	Value	Annotation
	enumeration	0256001	documentation Pfanne
	enumeration	0256002	documentation Schaft
	enumeration	0256003	documentation Pfanne und Schaft
	enumeration	0256004	documentation Femur
	enumeration	0256005	documentation Tibia
	enumeration	0256006	documentation Patella
	enumeration	0256007	documentation mehrere
annotation	documentation Kat_EP_KomponenteTFE		
source	<pre> <simpleType name="enum_0256"> <annotation> <documentation>Kat_EP_KomponenteTFE</documentation> </annotation> <restriction base="xs:string"> <enumeration value="0256001"> <annotation> <documentation>Pfanne</documentation> </annotation> </enumeration> <enumeration value="0256002"> <annotation> <documentation>Schaft</documentation> </annotation> </enumeration> <enumeration value="0256003"> <annotation> <documentation>Pfanne und Schaft</documentation> </annotation> </enumeration> <enumeration value="0256004"> <annotation> <documentation>Femur</documentation> </annotation> </enumeration> <enumeration value="0256005"> <annotation> <documentation>Tibia</documentation> </annotation> </enumeration> <enumeration value="0256006"> <annotation> <documentation>Patella</documentation> </annotation> </enumeration> <enumeration value="0256007"> <annotation> </pre>		

	<pre> <documentation>mehrere</documentation> </annotation> </enumeration> </restriction> </simpleType> </pre>
--	---

simpleType enum_0262

namespace	http://xml.ir-d.de/stn		
type	restriction of string		
properties	base xs:string		
facets	Kind	Value	Annotation
	enumeration	0262001	documentation Pfanne
	enumeration	0262002	documentation Schaft
	enumeration	0262003	documentation Kopf
	enumeration	0262004	documentation Inlay
	enumeration	0262005	documentation Adapter
	enumeration	0262006	documentation mehrere
annotation	documentation Kat_EP_ImplantatbruchHuefte		
source	<pre> <simpleType name="enum_0262"> <annotation> <documentation>Kat_EP_ImplantatbruchHuefte</documentation> </annotation> <restriction base="xs:string"> <enumeration value="0262001"> <annotation> <documentation>Pfanne</documentation> </annotation> </enumeration> <enumeration value="0262002"> <annotation> <documentation>Schaft</documentation> </annotation> </enumeration> <enumeration value="0262003"> <annotation> <documentation>Kopf</documentation> </annotation> </enumeration> <enumeration value="0262004"> <annotation> <documentation>Inlay</documentation> </annotation> </enumeration> <enumeration value="0262005"> <annotation> <documentation>Adapter</documentation> </annotation> </enumeration> <enumeration value="0262006"> </pre>		

	<pre> <annotation> <documentation>mehrere</documentation> </annotation> </enumeration> </restriction> </simpleType> </pre>
--	--

simpleType enum_0264

namespace	http://xml.ir-d.de/stn		
type	restriction of string		
properties	base xs:string		
facets	Kind	Value	Annotation
	enumeration	0264001	documentation Femur
	enumeration	0264002	documentation Tibia
	enumeration	0264003	documentation Inlay
	enumeration	0264004	documentation Adapter
	enumeration	0264005	documentation Verlängerung
	enumeration	0264006	documentation Schrauben
	enumeration	0264007	documentation mehrere
	enumeration	0264042	documentation andere
annotation	documentation Kat_EP_ImplantatbruchKnie		
source	<pre> <simpleType name="enum_0264"> <annotation> <documentation>Kat_EP_ImplantatbruchKnie</documentation> </annotation> <restriction base="xs:string"> <enumeration value="0264001"> <annotation> <documentation>Femur</documentation> </annotation> </enumeration> <enumeration value="0264002"> <annotation> <documentation>Tibia</documentation> </annotation> </enumeration> <enumeration value="0264003"> <annotation> <documentation>Inlay</documentation> </annotation> </enumeration> <enumeration value="0264004"> <annotation> <documentation>Adapter</documentation> </annotation> </enumeration> <enumeration value="0264005"> <annotation> </pre>		

```

        <documentation>Verlängerung</documentation>
    </annotation>
</enumeration>
<enumeration value="0264006">
    <annotation>
        <documentation>Schrauben</documentation>
    </annotation>
</enumeration>
<enumeration value="0264007">
    <annotation>
        <documentation>mehrere</documentation>
    </annotation>
</enumeration>
<enumeration value="0264042">
    <annotation>
        <documentation>andere</documentation>
    </annotation>
</enumeration>
</restriction>
</simpleType>

```

simpleType **enum_0266**

namespace	http://xml.ir-d.de/stn		
type	restriction of string		
properties	base xs:string		
facets	Kind	Value	Annotation
	enumeration	0266001	documentation Pfanne
	enumeration	0266002	documentation Schaft
	enumeration	0266003	documentation Kopf
	enumeration	0266004	documentation Inlay
	enumeration	0266005	documentation Adapter
	enumeration	0266006	documentation Femur
	enumeration	0266007	documentation Tibia
	enumeration	0266008	documentation Verlängerung
	enumeration	0266009	documentation Schrauben
	enumeration	0266010	documentation mehrere
	enumeration	0266042	documentation andere
annotation	documentation Kat_EP_ImplantatbruchTFE		
source	<pre> <simpleType name="enum_0266"> <annotation> <documentation>Kat_EP_ImplantatbruchTFE</documentation> </annotation> <restriction base="xs:string"> <enumeration value="0266001"> <annotation> </pre>		

```
<documentation>Pfanne</documentation>
</annotation>
</enumeration>
<enumeration value="0266002">
  <annotation>
    <documentation>Schaft</documentation>
  </annotation>
</enumeration>
<enumeration value="0266003">
  <annotation>
    <documentation>Kopf</documentation>
  </annotation>
</enumeration>
<enumeration value="0266004">
  <annotation>
    <documentation>Inlay</documentation>
  </annotation>
</enumeration>
<enumeration value="0266005">
  <annotation>
    <documentation>Adapter</documentation>
  </annotation>
</enumeration>
<enumeration value="0266006">
  <annotation>
    <documentation>Femur</documentation>
  </annotation>
</enumeration>
<enumeration value="0266007">
  <annotation>
    <documentation>Tibia</documentation>
  </annotation>
</enumeration>
<enumeration value="0266008">
  <annotation>
    <documentation>Verlängerung</documentation>
  </annotation>
</enumeration>
<enumeration value="0266009">
  <annotation>
    <documentation>Schrauben</documentation>
  </annotation>
</enumeration>
<enumeration value="0266010">
  <annotation>
    <documentation>mehrere</documentation>
  </annotation>
</enumeration>
<enumeration value="0266042">
  <annotation>
    <documentation>andere</documentation>
  </annotation>
</enumeration>
</restriction>
</simpleType>
```

simpleType enum_0270

namespace	http://xml.ir-d.de/stn		
type	restriction of string		
properties	base xs:string		
facets	Kind	Value	Annotation
	enumeration	0270001	documentation PE-Inlay
	enumeration	0270002	documentation patellare Komponente
	enumeration	0270003	documentation beides
annotation	documentation Kat_EP_VerschleissKnie		
source	<pre> <simpleType name="enum_0270"> <annotation> <documentation>Kat_EP_VerschleissKnie</documentation> </annotation> <restriction base="xs:string"> <enumeration value="0270001"> <annotation> <documentation>PE-Inlay</documentation> </annotation> </enumeration> <enumeration value="0270002"> <annotation> <documentation>patellare Komponente</documentation> </annotation> </enumeration> <enumeration value="0270003"> <annotation> <documentation>beides</documentation> </annotation> </enumeration> </restriction> </simpleType> </pre>		

simpleType enum_0271

namespace	http://xml.ir-d.de/stn		
type	restriction of string		
properties	base xs:string		
facets	Kind	Value	Annotation
	enumeration	0271001	documentation Schraube
	enumeration	0271002	documentation Inlay
	enumeration	0271003	documentation patellare Komponente
	enumeration	0271004	documentation Kopplung
	enumeration	0271005	documentation mehrere
	enumeration	0271042	documentation andere
annotation	documentation Kat_EP_MigrationKnie		

source	<pre> <simpleType name="enum_0271"> <annotation> <documentation>Kat_EP_MigrationKnie</documentation> </annotation> <restriction base="xs:string"> <enumeration value="0271001"> <annotation> <documentation>Schraube</documentation> </annotation> </enumeration> <enumeration value="0271002"> <annotation> <documentation>Inlay</documentation> </annotation> </enumeration> <enumeration value="0271003"> <annotation> <documentation>patellare Komponente</documentation> </annotation> </enumeration> <enumeration value="0271004"> <annotation> <documentation>Kopplung</documentation> </annotation> </enumeration> <enumeration value="0271005"> <annotation> <documentation>mehrere</documentation> </annotation> </enumeration> <enumeration value="0271042"> <annotation> <documentation>andere</documentation> </annotation> </enumeration> </restriction> </simpleType> </pre>
--------	---

simpleType enum_0290

namespace	http://xml.ir-d.de/stn		
type	restriction of string		
properties	base xs:string		
facets	Kind	Value	Annotation
	enumeration	0290001	documentation Hüft-Komponente
	enumeration	0290002	documentation Knie-Komponente
	enumeration	0290003	documentation Modulare Komponente (Hüfte/Knie)
annotation	documentation Kat_EP_Artikeltyp		
source	<pre> <simpleType name="enum_0290"> <annotation> <documentation>Kat_EP_Artikeltyp</documentation> </annotation> </pre>		

	<pre> <restriction base="xs:string"> <enumeration value="0290001"> <annotation> <documentation>Hüft-Komponente</documentation> </annotation> </enumeration> <enumeration value="0290002"> <annotation> <documentation>Knie-Komponente</documentation> </annotation> </enumeration> <enumeration value="0290003"> <annotation> <documentation>Modulare Komponente (Hüfte/Knie)</documentation> </annotation> </enumeration> </restriction> </simpleType> </pre>
--	--

simpleType enum_0291

namespace	http://xml.ir-d.de/stn		
type	restriction of string		
properties	base xs:string		
facets	Kind	Value	Annotation
	enumeration	0291001	documentation Knochen-Zement
	enumeration	0291002	documentation sonstiges Zubehör
annotation	documentation Kat_EP_ZubehoerTyp		
source	<pre> <simpleType name="enum_0291"> <annotation> <documentation>Kat_EP_ZubehoerTyp</documentation> </annotation> <restriction base="xs:string"> <enumeration value="0291001"> <annotation> <documentation>Knochen-Zement</documentation> </annotation> </enumeration> <enumeration value="0291002"> <annotation> <documentation>sonstiges Zubehör</documentation> </annotation> </enumeration> </restriction> </simpleType> </pre>		

simpleType enum_0300

namespace	http://xml.ir-d.de/stn		
type	restriction of string		
properties	base xs:string		

facets	<table border="1"> <thead> <tr> <th>Kind</th> <th>Value</th> <th>Annotation</th> </tr> </thead> <tbody> <tr> <td>enumeration</td> <td>0300001</td> <td>documentation konventieller Aortenklappenersatz</td> </tr> <tr> <td>enumeration</td> <td>0300002</td> <td>documentation kathetergestützte Aortenklappenimplantation (TAVI)</td> </tr> </tbody> </table>	Kind	Value	Annotation	enumeration	0300001	documentation konventieller Aortenklappenersatz	enumeration	0300002	documentation kathetergestützte Aortenklappenimplantation (TAVI)
Kind	Value	Annotation								
enumeration	0300001	documentation konventieller Aortenklappenersatz								
enumeration	0300002	documentation kathetergestützte Aortenklappenimplantation (TAVI)								
annotation	documentation Kat_AK_ArtEingriff									
source	<pre> <simpleType name="enum_0300"> <annotation> <documentation>Kat_AK_ArtEingriff</documentation> </annotation> <restriction base="xs:string"> <enumeration value="0300001"> <annotation> <documentation>konventieller Aortenklappenersatz</documentation> </annotation> </enumeration> <enumeration value="0300002"> <annotation> <documentation>kathetergestützte Aortenklappenimplantation (TAVI)</documentation> </annotation> </enumeration> </restriction> </simpleType> </pre>									

simpleType enum_0302

namespace	http://xml.ir-d.de/stn												
type	restriction of string												
properties	base xs:string												
facets	<table border="1"> <thead> <tr> <th>Kind</th> <th>Value</th> <th>Annotation</th> </tr> </thead> <tbody> <tr> <td>enumeration</td> <td>0302001</td> <td>documentation Stenose</td> </tr> <tr> <td>enumeration</td> <td>0302002</td> <td>documentation Insuffizienz</td> </tr> <tr> <td>enumeration</td> <td>0302003</td> <td>documentation Stenose und Insuffizienz</td> </tr> </tbody> </table>	Kind	Value	Annotation	enumeration	0302001	documentation Stenose	enumeration	0302002	documentation Insuffizienz	enumeration	0302003	documentation Stenose und Insuffizienz
Kind	Value	Annotation											
enumeration	0302001	documentation Stenose											
enumeration	0302002	documentation Insuffizienz											
enumeration	0302003	documentation Stenose und Insuffizienz											
annotation	documentation Kat_AK_GrundEingriff												
source	<pre> <simpleType name="enum_0302"> <annotation> <documentation>Kat_AK_GrundEingriff</documentation> </annotation> <restriction base="xs:string"> <enumeration value="0302001"> <annotation> <documentation>Stenose</documentation> </annotation> </enumeration> <enumeration value="0302002"> <annotation> <documentation>Insuffizienz</documentation> </annotation> </enumeration> <enumeration value="0302003"> <annotation> </pre>												

	<pre> <documentation>Stenose und Insuffizienz</documentation> </annotation> </enumeration> </restriction> </simpleType> </pre>
--	--

simpleType enum_0318

namespace	http://xml.ir-d.de/stn		
type	restriction of string		
properties	base xs:string		
facets	Kind	Value	Annotation
	enumeration	0318001	documentation transapikal
	enumeration	0318002	documentation transaortal
	enumeration	0318003	documentation transfemoral
	enumeration	0318004	documentation transaxillär
	enumeration	0318042	documentation anderer Zugangsweg
annotation	documentation Kat_AK_ZugangKatheter		
source	<pre> <simpleType name="enum_0318"> <annotation> <documentation>Kat_AK_ZugangKatheter</documentation> </annotation> <restriction base="xs:string"> <enumeration value="0318001"> <annotation> <documentation>transapikal</documentation> </annotation> </enumeration> <enumeration value="0318002"> <annotation> <documentation>transaortal</documentation> </annotation> </enumeration> <enumeration value="0318003"> <annotation> <documentation>transfemoral</documentation> </annotation> </enumeration> <enumeration value="0318004"> <annotation> <documentation>transaxillär</documentation> </annotation> </enumeration> <enumeration value="0318042"> <annotation> <documentation>anderer Zugangsweg</documentation> </annotation> </enumeration> </restriction> </simpleType> </pre>		

simpleType enum_0320

namespace	http://xml.ir-d.de/stn		
type	restriction of string		
properties	base xs:string		
facets	Kind	Value	Annotation
	enumeration	0320001	documentation konventionelle Sternotomie
	enumeration	0320002	documentation partielle Sternotomie
	enumeration	0320003	documentation parasternaler Zugang
	enumeration	0320042	documentation anderer Zugangsweg
annotation	documentation Kat_AK_ZugangKonventionell		
source	<pre> <simpleType name="enum_0320"> <annotation> <documentation>Kat_AK_ZugangKonventionell</documentation> </annotation> <restriction base="xs:string"> <enumeration value="0320001"> <annotation> <documentation>konventionelle Sternotomie</documentation> </annotation> </enumeration> <enumeration value="0320002"> <annotation> <documentation>partielle Sternotomie</documentation> </annotation> </enumeration> <enumeration value="0320003"> <annotation> <documentation>parasternaler Zugang</documentation> </annotation> </enumeration> <enumeration value="0320042"> <annotation> <documentation>anderer Zugangsweg</documentation> </annotation> </enumeration> </restriction> </simpleType> </pre>		

simpleType enum_0322

namespace	http://xml.ir-d.de/stn		
type	restriction of string		
properties	base xs:string		
facets	Kind	Value	Annotation
	enumeration	0322001	documentation nein
	enumeration	0322002	documentation ja, diätetisch behandelt
	enumeration	0322003	documentation

	enumeration 0322004 ja, orale Medikation documentation enumeration 0322005 ja, mit Insulin behandelt documentation enumeration 0322099 ja, unbehandelt documentation unbekannt
annotation	documentation Kat_AK_Diabetes
source	<pre> <simpleType name="enum_0322"> <annotation> <documentation>Kat_AK_Diabetes</documentation> </annotation> <restriction base="xs:string"> <enumeration value="0322001"> <annotation> <documentation>nein</documentation> </annotation> </enumeration> <enumeration value="0322002"> <annotation> <documentation>ja, diätetisch behandelt</documentation> </annotation> </enumeration> <enumeration value="0322003"> <annotation> <documentation>ja, orale Medikation</documentation> </annotation> </enumeration> <enumeration value="0322004"> <annotation> <documentation>ja, mit Insulin behandelt</documentation> </annotation> </enumeration> <enumeration value="0322005"> <annotation> <documentation>ja, unbehandelt</documentation> </annotation> </enumeration> <enumeration value="0322099"> <annotation> <documentation>unbekannt</documentation> </annotation> </enumeration> </restriction> </simpleType> </pre>

simpleType enum_0324

namespace	http://xml.ir-d.de/stn		
type	restriction of string		
properties	base xs:string		
facets	Kind	Value	Annotation
	enumeration	0324001	documentation (I): Beschwerdefreiheit, normale körperliche Belastbarkeit
	enumeration	0324002	documentation (II): Beschwerden bei stärkerer körperlicher Belastung

	enumeration 0324003 documentation (III): Beschwerden bei leichter körperlicher Belastung enumeration 0324004 documentation (IV): Beschwerden in Ruhe
annotation	documentation Kat_AK_NYHA
source	<pre> <simpleType name="enum_0324"> <annotation> <documentation>Kat_AK_NYHA</documentation> </annotation> <restriction base="xs:string"> <enumeration value="0324001"> <annotation> <documentation>(I): Beschwerdefreiheit, normale körperliche Belastbarkeit</documentation> </annotation> </enumeration> <enumeration value="0324002"> <annotation> <documentation>(II): Beschwerden bei stärkerer körperlicher Belastung</documentation> </annotation> </enumeration> <enumeration value="0324003"> <annotation> <documentation>(III): Beschwerden bei leichter körperlicher Belastung</documentation> </annotation> </enumeration> <enumeration value="0324004"> <annotation> <documentation>(IV): Beschwerden in Ruhe</documentation> </annotation> </enumeration> </restriction> </simpleType> </pre>

simpleType enum_0330

namespace	http://xml.ir-d.de/stn		
type	restriction of string		
properties	base xs:string		
facets	Kind	Value	Annotation
	enumeration	0330001	documentation ATS Medical
	enumeration	0330002	documentation Edwards Lifesciences
	enumeration	0330003	documentation Medtronic
	enumeration	0330004	documentation JenaValve
	enumeration	0330005	documentation Corcym
	enumeration	0330006	documentation St.Jude Medical/Abbott
	enumeration	0330007	documentation Symetis
	enumeration	0330008	documentation

	<p>enumeration 0330009 Direct Flow Medical documentation</p> <p>enumeration 0330010 Boston Scientific documentation nicht belegter Wert</p> <p>enumeration 0330011 documentation nicht belegter Wert</p> <p>enumeration 0330012 documentation nicht belegter Wert</p> <p>enumeration 0330013 documentation nicht belegter Wert</p> <p>enumeration 0330014 documentation nicht belegter Wert</p> <p>enumeration 0330042 documentation sonstiger Hersteller</p>
annotation	documentation Kat_AK_Hersteller
source	<pre> <simpleType name="enum_0330"> <annotation> <documentation>Kat_AK_Hersteller</documentation> </annotation> <restriction base="xs:string"> <enumeration value="0330001"> <annotation> <documentation>ATS Medical</documentation> </annotation> </enumeration> <enumeration value="0330002"> <annotation> <documentation>Edwards Lifesciences</documentation> </annotation> </enumeration> <enumeration value="0330003"> <annotation> <documentation>Medtronic</documentation> </annotation> </enumeration> <enumeration value="0330004"> <annotation> <documentation>JenaValve</documentation> </annotation> </enumeration> <enumeration value="0330005"> <annotation> <documentation>Corcym</documentation> </annotation> </enumeration> <enumeration value="0330006"> <annotation> <documentation>St.Jude Medical/Abbott</documentation> </annotation> </enumeration> <enumeration value="0330007"> <annotation> <documentation>Symetis</documentation> </annotation> </enumeration> <enumeration value="0330008"> <annotation> <documentation>Direct Flow Medical</documentation> </annotation> </enumeration> </restriction> </simpleType> </pre>

```

</annotation>
</enumeration>
<enumeration value="0330009">
  <annotation>
    <documentation>Boston Scientific</documentation>
  </annotation>
</enumeration>
<enumeration value="0330010">
  <annotation>
    <documentation>nicht belegter Wert</documentation>
  </annotation>
</enumeration>
<enumeration value="0330011">
  <annotation>
    <documentation>nicht belegter Wert</documentation>
  </annotation>
</enumeration>
<enumeration value="0330012">
  <annotation>
    <documentation>nicht belegter Wert</documentation>
  </annotation>
</enumeration>
<enumeration value="0330013">
  <annotation>
    <documentation>nicht belegter Wert</documentation>
  </annotation>
</enumeration>
<enumeration value="0330014">
  <annotation>
    <documentation>nicht belegter Wert</documentation>
  </annotation>
</enumeration>
<enumeration value="0330042">
  <annotation>
    <documentation>sonstiger Hersteller</documentation>
  </annotation>
</enumeration>
</restriction>
</simpleType>

```

simpleType enum 0338

namespace	http://xml.ir-d.de/stn		
type	restriction of string		
properties	base xs:string		
facets	Kind	Value	Annotation
	enumeration	0338001	documentation LAD
	enumeration	0338002	documentation RCA
	enumeration	0338003	documentation RCX
	enumeration	0338004	documentation Hauptstamm
annotation	documentation Kat_AK_PCIArterien		
source	<simpleType name="enum_0338">		

	<pre> <annotation> <documentation>Kat_AK_PCIArterien</documentation> </annotation> <restriction base="xs:string"> <enumeration value="0338001"> <annotation> <documentation>LAD</documentation> </annotation> </enumeration> <enumeration value="0338002"> <annotation> <documentation>RCA</documentation> </annotation> </enumeration> <enumeration value="0338003"> <annotation> <documentation>RCX</documentation> </annotation> </enumeration> <enumeration value="0338004"> <annotation> <documentation>Hauptstamm</documentation> </annotation> </enumeration> </restriction> </simpleType> </pre>
--	--

simpleType enum_0339

namespace	http://xml.ir-d.de/stn		
type	restriction of string		
properties	base xs:string		
facets	Kind	Value	Annotation
	enumeration	0339001	documentation TEE
	enumeration	0339002	documentation CT
	enumeration	0339042	documentation andere
annotation	documentation Kat AK AnnulusMessmethode		
source	<pre> <simpleType name="enum_0339"> <annotation> <documentation>Kat_AK_AnnulusMessmethode</documentation> </annotation> <restriction base="xs:string"> <enumeration value="0339001"> <annotation> <documentation>TEE</documentation> </annotation> </enumeration> <enumeration value="0339002"> <annotation> <documentation>CT</documentation> </annotation> </enumeration> <enumeration value="0339042"> </pre>		

	<pre> <annotation> <documentation>andere</documentation> </annotation> </enumeration> </restriction> </simpleType> </pre>
--	---

simpleType enum_0341

namespace	http://xml.ir-d.de/stn		
type	restriction of string		
properties	base xs:string		
facets	Kind	Value	Annotation
	enumeration	0341001	documentation intraprozedural verstorben
	enumeration	0341002	documentation Implantation von mehr als einer Prothese
	enumeration	0341003	documentation gravierende Gefäß- oder Zugangskomplikation (gemäß VARC-3)
	enumeration	0341004	documentation erforderlicher chirurgischer oder interventioneller Eingriff wegen einer Klappenfehlfunktion (gemäß VARC-3)
	enumeration	0341005	documentation >= große strukturelle kardiale Komplikation (gemäß VARC-3)
annotation	documentation Kat_AK_FailureGrund		
source	<pre> <simpleType name="enum_0341"> <annotation> <documentation>Kat_AK_FailureGrund</documentation> </annotation> <restriction base="xs:string"> <enumeration value="0341001"> <annotation> <documentation>intraprozedural verstorben</documentation> </annotation> </enumeration> <enumeration value="0341002"> <annotation> <documentation>Implantation von mehr als einer Prothese</documentation> </annotation> </enumeration> <enumeration value="0341003"> <annotation> <documentation>gravierende Gefäß- oder Zugangskomplikation (gemäß VARC-3)</documentation> </annotation> </enumeration> <enumeration value="0341004"> <annotation> <documentation>erforderlicher chirurgischer oder interventioneller Eingriff wegen einer Klappenfehlfunktion (gemäß VARC-3)</documentation> </annotation> </enumeration> <enumeration value="0341005"> <annotation> <documentation>&gt;= große strukturelle kardiale Komplikation (gemäß VARC-3)</documentation> </annotation> </enumeration> </restriction> </simpleType> </pre>		

	<pre> </annotation> </enumeration> </restriction> </simpleType> </pre>
--	--

simpleType enum_0342

namespace	http://xml.ir-d.de/stn																					
type	restriction of string																					
properties	base xs:string																					
facets	<table border="1"> <thead> <tr> <th>Kind</th> <th>Value</th> <th>Annotation</th> </tr> </thead> <tbody> <tr> <td>enumeration</td> <td>0342001</td> <td>documentation Alter</td> </tr> <tr> <td>enumeration</td> <td>0342002</td> <td>documentation Frailty</td> </tr> <tr> <td>enumeration</td> <td>0342003</td> <td>documentation Hochrisiko</td> </tr> <tr> <td>enumeration</td> <td>0342004</td> <td>documentation Prognose-limitierende Zweiterkrankung</td> </tr> <tr> <td>enumeration</td> <td>0342005</td> <td>documentation Porzellan-Aorta</td> </tr> <tr> <td>enumeration</td> <td>0342042</td> <td>documentation Sonstige</td> </tr> </tbody> </table>	Kind	Value	Annotation	enumeration	0342001	documentation Alter	enumeration	0342002	documentation Frailty	enumeration	0342003	documentation Hochrisiko	enumeration	0342004	documentation Prognose-limitierende Zweiterkrankung	enumeration	0342005	documentation Porzellan-Aorta	enumeration	0342042	documentation Sonstige
Kind	Value	Annotation																				
enumeration	0342001	documentation Alter																				
enumeration	0342002	documentation Frailty																				
enumeration	0342003	documentation Hochrisiko																				
enumeration	0342004	documentation Prognose-limitierende Zweiterkrankung																				
enumeration	0342005	documentation Porzellan-Aorta																				
enumeration	0342042	documentation Sonstige																				
annotation	documentation Kat AK Tavi																					
source	<pre> <simpleType name="enum_0342"> <annotation> <documentation>Kat_AK_Tavi</documentation> </annotation> <restriction base="xs:string"> <enumeration value="0342001"> <annotation> <documentation>Alter</documentation> </annotation> </enumeration> <enumeration value="0342002"> <annotation> <documentation>Frailty</documentation> </annotation> </enumeration> <enumeration value="0342003"> <annotation> <documentation>Hochrisiko</documentation> </annotation> </enumeration> <enumeration value="0342004"> <annotation> <documentation>Prognose-limitierende Zweiterkrankung</documentation> </annotation> </enumeration> <enumeration value="0342005"> <annotation> <documentation>Porzellan-Aorta</documentation> </annotation> </enumeration> <enumeration value="0342042"> <annotation> </pre>																					

```

<documentation>Sonstige</documentation>
</annotation>
</enumeration>
</restriction>
</simpleType>

```

simpleType enum_0343

namespace	http://xml.ir-d.de/stn		
type	restriction of string		
properties	base xs:string		
facets	Kind	Value	Annotation
	enumeration	0343001	documentation Device-Fehlpositionierung
	enumeration	0343002	documentation Koronarostienverschluss
	enumeration	0343003	documentation Aortendissektion
	enumeration	0343004	documentation Aortenregurgitation > = 2. Grades
	enumeration	0343005	documentation Annulus-Ruptur
	enumeration	0343006	documentation Ruptur-/Perforation einer Herzhöhle ohne Therapiebedarf
	enumeration	0343007	documentation Ruptur-/Perforation einer Herzhöhle mit Therapiebedarf
	enumeration	0343008	documentation Perikardtamponade
	enumeration	0343009	documentation kardiale Dekompensation
	enumeration	0343010	documentation Himembolie
	enumeration	0343011	documentation Rhythmusstörungen
	enumeration	0343012	documentation Device-Embolisation
	enumeration	0343013	documentation vaskuläre Komplikation
	enumeration	0343014	documentation Low Cardiac Output
	enumeration	0343015	documentation schwerwiegende Blutungen (intraprozedural)
	enumeration	0343016	documentation lebensbedrohliche Blutungen (intraprozedural)
	enumeration	0343017	documentation Patient verstarb im OP/Katheterlabor
	enumeration	0343042	documentation sonstige intraprozedurale Komplikationen
annotation	documentation Kat_AK_KomplikationTyp		
source	<pre> <simpleType name="enum_0343"> <annotation> <documentation>Kat_AK_KomplikationTyp</documentation> </annotation> <restriction base="xs:string"> <enumeration value="0343001"> <annotation> <documentation>Device-Fehlpositionierung</documentation> </annotation> </enumeration> </restriction> </simpleType> </pre>		

```

</enumeration>
<enumeration value="0343002">
  <annotation>
    <documentation>Koronarostienverschluss</documentation>
  </annotation>
</enumeration>
<enumeration value="0343003">
  <annotation>
    <documentation>Aortendissektion</documentation>
  </annotation>
</enumeration>
<enumeration value="0343004">
  <annotation>
    <documentation>Aortenregurgitation &gt; = 2. Grades</documentation>
  </annotation>
</enumeration>
<enumeration value="0343005">
  <annotation>
    <documentation>Annulus-Ruptur</documentation>
  </annotation>
</enumeration>
<enumeration value="0343006">
  <annotation>
    <documentation>Ruptur-/Perforation einer Herzhöhle ohne
Therapiebedarf</documentation>
  </annotation>
</enumeration>
<enumeration value="0343007">
  <annotation>
    <documentation>Ruptur-/Perforation einer Herzhöhle mit
Therapiebedarf</documentation>
  </annotation>
</enumeration>
<enumeration value="0343008">
  <annotation>
    <documentation>Perikardtamponade</documentation>
  </annotation>
</enumeration>
<enumeration value="0343009">
  <annotation>
    <documentation>kardiale Dekompensation</documentation>
  </annotation>
</enumeration>
<enumeration value="0343010">
  <annotation>
    <documentation>Hirnembolie</documentation>
  </annotation>
</enumeration>
<enumeration value="0343011">
  <annotation>
    <documentation>Rhythmusstörungen</documentation>
  </annotation>
</enumeration>
<enumeration value="0343012">
  <annotation>
    <documentation>Device-Embolisation</documentation>
  </annotation>
</enumeration>
<enumeration value="0343013">

```

	<pre> <annotation> <documentation>vaskuläre Komplikation</documentation> </annotation> </enumeration> <enumeration value="0343014"> <annotation> <documentation>Low Cardiac Output</documentation> </annotation> </enumeration> <enumeration value="0343015"> <annotation> <documentation>schwerwiegende Blutungen (intraprozedural)</documentation> </annotation> </enumeration> <enumeration value="0343016"> <annotation> <documentation>lebensbedrohliche Blutungen (intraprozedural)</documentation> </annotation> </enumeration> <enumeration value="0343017"> <annotation> <documentation>Patient verstarb im OP/Katheterlabor</documentation> </annotation> </enumeration> <enumeration value="0343042"> <annotation> <documentation>sonstige intraprozedurale Komplikationen</documentation> </annotation> </enumeration> </restriction> </simpleType> </pre>
--	--

simpleType enum 0346

namespace	http://xml.lir-d.de/stn		
type	restriction of string		
properties	base xs:string		
facets	Kind	Value	Annotation
	enumeration	0346001	documentation keine Therapie erforderlich
	enumeration	0346002	documentation medikamentös
	enumeration	0346003	documentation IABP
	enumeration	0346004	documentation VAD
	enumeration	0346005	documentation ECMO
	enumeration	0346042	documentation sonstige
annotation	documentation Kat_AK_TherapieLCO		
source	<pre> <simpleType name="enum_0346"> <annotation> </pre>		

	<pre> <documentation>Kat_AK_TherapieLCO</documentation> </annotation> <restriction base="xs:string"> <enumeration value="0346001"> <annotation> <documentation>keine Therapie erforderlich</documentation> </annotation> </enumeration> <enumeration value="0346002"> <annotation> <documentation>medikamentös</documentation> </annotation> </enumeration> <enumeration value="0346003"> <annotation> <documentation>IABP</documentation> </annotation> </enumeration> <enumeration value="0346004"> <annotation> <documentation>VAD</documentation> </annotation> </enumeration> <enumeration value="0346005"> <annotation> <documentation>ECMO</documentation> </annotation> </enumeration> <enumeration value="0346042"> <annotation> <documentation>sonstige</documentation> </annotation> </enumeration> </restriction> </simpleType> </pre>
--	--

simpleType enum 0347

namespace	http://xml.ir-d.de/stn		
type	restriction of string		
properties	base xs:string		
facets	Kind	Value	Annotation
	enumeration	0347001	documentation Einzeleingriff
	enumeration	0347002	documentation Kombinationseingriff mit mehreren Prozeduren
annotation	documentation Kat_AK_Eingriffsumfang		
source	<pre> <simpleType name="enum_0347"> <annotation> <documentation>Kat_AK_Eingriffsumfang</documentation> </annotation> <restriction base="xs:string"> <enumeration value="0347001"> <annotation> <documentation>Einzeleingriff</documentation> </annotation> </pre>		

	<pre> </enumeration> <enumeration value="0347002"> <annotation> <documentation>Kombinationseingriff mit mehreren Prozeduren</documentation> </annotation> </enumeration> </restriction> </simpleType> </pre>
--	--

simpleType enum_0348

namespace	http://xml.ir-d.de/stn		
type	restriction of string		
properties	base xs:string		
facets	Kind	Value	Annotation
	enumeration	0348001	documentation mit HLM
	enumeration	0348002	documentation ohne HLM
	enumeration	0348003	documentation Umstieg von OP ohne HLM auf OP mit HLM
annotation	documentation Kat AK_OPVorgehen		
source	<pre> <simpleType name="enum_0348"> <annotation> <documentation>Kat_AK_OPVorgehen</documentation> </annotation> <restriction base="xs:string"> <enumeration value="0348001"> <annotation> <documentation>mit HLM</documentation> </annotation> </enumeration> <enumeration value="0348002"> <annotation> <documentation>ohne HLM</documentation> </annotation> </enumeration> <enumeration value="0348003"> <annotation> <documentation>Umstieg von OP ohne HLM auf OP mit HLM</documentation> </annotation> </enumeration> </restriction> </simpleType> </pre>		

simpleType enum_0350

namespace	http://xml.ir-d.de/stn		
type	restriction of string		
properties	base xs:string		
facets	Kind	Value	Annotation
	enumeration	0350001	documentation

	enumeration 0350002 IABP documentation Impella enumeration 0350003 documentation vv ECMO enumeration 0350004 documentation va ECMO enumeration 0350042 documentation andere
annotation	documentation Kat_AK_Methode
source	<pre> <simpleType name="enum_0350"> <annotation> <documentation>Kat_AK_Methode</documentation> </annotation> <restriction base="xs:string"> <enumeration value="0350001"> <annotation> <documentation>IABP</documentation> </annotation> </enumeration> <enumeration value="0350002"> <annotation> <documentation>Impella</documentation> </annotation> </enumeration> <enumeration value="0350003"> <annotation> <documentation>vv ECMO</documentation> </annotation> </enumeration> <enumeration value="0350004"> <annotation> <documentation>va ECMO</documentation> </annotation> </enumeration> <enumeration value="0350042"> <annotation> <documentation>andere</documentation> </annotation> </enumeration> </restriction> </simpleType> </pre>

simpleType enum_0351

namespace	http://xml.ir-d.de/stn		
type	restriction of string		
properties	base xs:string		
facets	Kind	Value	Annotation
	enumeration	0351001	documentation nein
	enumeration	0351002	documentation ja, zu Stenotomie
	enumeration	0351003	documentation ja, zu transapikal
	enumeration	0351004	documentation ja, zu transaortal

	<p>enumeration 0351005 documentation ja, zu transfemoral</p> <p>enumeration 0351006 documentation ja, zu transaxillär</p> <p>enumeration 0351007 documentation ja, zu anderem endovaskulären Zugang</p> <p>enumeration 0351042 documentation ja, zu anderem Zugang</p>
annotation	documentation Kat_AK_Konversion
source	<pre> <simpleType name="enum_0351"> <annotation> <documentation>Kat_AK_Konversion</documentation> </annotation> <restriction base="xs:string"> <enumeration value="0351001"> <annotation> <documentation>nein</documentation> </annotation> </enumeration> <enumeration value="0351002"> <annotation> <documentation>ja, zu Sternotomie</documentation> </annotation> </enumeration> <enumeration value="0351003"> <annotation> <documentation>ja, zu transapikal</documentation> </annotation> </enumeration> <enumeration value="0351004"> <annotation> <documentation>ja, zu transaortal</documentation> </annotation> </enumeration> <enumeration value="0351005"> <annotation> <documentation>ja, zu transfemoral</documentation> </annotation> </enumeration> <enumeration value="0351006"> <annotation> <documentation>ja, zu transaxillär</documentation> </annotation> </enumeration> <enumeration value="0351007"> <annotation> <documentation>ja, zu anderem endovaskulären Zugang</documentation> </annotation> </enumeration> <enumeration value="0351042"> <annotation> <documentation>ja, zu anderem Zugang</documentation> </annotation> </enumeration> </restriction> </simpleType> </pre>

simpleType enum_0352

namespace	http://xml.ir-d.de/stn		
type	restriction of string		
properties	base xs:string		
facets	Kind	Value	Annotation
	enumeration	0352001	documentation nein
	enumeration	0352002	documentation ja, Intubationsnarkose
	enumeration	0352003	documentation ja, Maskenbeatmung, incl. LAMA
	enumeration	0352042	documentation ja, unbekannt welche
annotation	documentation Kat_AK_Anaesthesie		
source	<pre> <simpleType name="enum_0352"> <annotation> <documentation>Kat_AK_Anaesthesie</documentation> </annotation> <restriction base="xs:string"> <enumeration value="0352001"> <annotation> <documentation>nein</documentation> </annotation> </enumeration> <enumeration value="0352002"> <annotation> <documentation>ja, Intubationsnarkose</documentation> </annotation> </enumeration> <enumeration value="0352003"> <annotation> <documentation>ja, Maskenbeatmung, incl. LAMA</documentation> </annotation> </enumeration> <enumeration value="0352042"> <annotation> <documentation>ja, unbekannt welche</documentation> </annotation> </enumeration> </restriction> </simpleType> </pre>		

simpleType enum_0353

namespace	http://xml.ir-d.de/stn		
type	restriction of string		
properties	base xs:string		
facets	Kind	Value	Annotation
	enumeration	0353001	documentation keine
	enumeration	0353002	documentation leichtgradig
	enumeration	0353003	documentation mittelgradig
	enumeration	0353004	documentation

	enumeration 0353099 hochgradig documentation nicht bestimmbar
annotation	documentation Kat_AK_ResidualeArteninsuffizienz
source	<pre> <simpleType name="enum_0353"> <annotation> <documentation>Kat_AK_ResidualeArteninsuffizienz</documentation> </annotation> <restriction base="xs:string"> <enumeration value="0353001"> <annotation> <documentation>keine</documentation> </annotation> </enumeration> <enumeration value="0353002"> <annotation> <documentation>leichtgradig</documentation> </annotation> </enumeration> <enumeration value="0353003"> <annotation> <documentation>mittelgradig</documentation> </annotation> </enumeration> <enumeration value="0353004"> <annotation> <documentation>hochgradig</documentation> </annotation> </enumeration> <enumeration value="0353099"> <annotation> <documentation>nicht bestimmbar</documentation> </annotation> </enumeration> </restriction> </simpleType> </pre>

simpleType enum_0354

namespace	http://xml.ir-d.de/stn		
type	restriction of string		
properties	base xs:string		
facets	Kind	Value	Annotation
	enumeration	0354001	documentation chirurgisch-offen
	enumeration	0354002	documentation Verschluss-System
	enumeration	0354042	documentation sonstige
annotation	documentation Kat_AK_Zugangswegverschluss		
source	<pre> <simpleType name="enum_0354"> <annotation> <documentation>Kat_AK_Zugangswegverschluss</documentation> </annotation> <restriction base="xs:string"> </pre>		

	<pre> <enumeration value="0354001"> <annotation> <documentation>chirurgisch-offen</documentation> </annotation> </enumeration> <enumeration value="0354002"> <annotation> <documentation>Verschluss-System</documentation> </annotation> </enumeration> <enumeration value="0354042"> <annotation> <documentation>sonstige</documentation> </annotation> </enumeration> </restriction> </simpleType> </pre>
--	---

simpleType enum 0357

namespace	http://xml.ir-d.de/stn		
type	restriction of string		
properties	base xs:string		
facets	Kind	Value	Annotation
	enumeration	0357001	documentation keine KHK
	enumeration	0357002	documentation 1-Gefäßerkrankung
	enumeration	0357003	documentation 2-Gefäßerkrankung
	enumeration	0357004	documentation 3-Gefäßerkrankung
	enumeration	0357005	documentation keine koronare Bildgebung
annotation	documentation Kat_AK_BefundBildgebung		
source	<pre> <simpleType name="enum_0357"> <annotation> <documentation>Kat_AK_BefundBildgebung</documentation> </annotation> <restriction base="xs:string"> <enumeration value="0357001"> <annotation> <documentation>keine KHK</documentation> </annotation> </enumeration> <enumeration value="0357002"> <annotation> <documentation>1-Gefäßerkrankung</documentation> </annotation> </enumeration> <enumeration value="0357003"> <annotation> <documentation>2-Gefäßerkrankung</documentation> </annotation> </enumeration> <enumeration value="0357004"> </pre>		

	<pre> <annotation> <documentation>3-Gefäßerkrankung</documentation> </annotation> </enumeration> <enumeration value="0357005"> <annotation> <documentation>keine koronare Bildgebung</documentation> </annotation> </enumeration> </restriction> </simpleType> </pre>
--	---

simpleType enum_0358

namespace	http://xml.ir-d.de/stn		
type	restriction of string		
properties	base xs:string		
facets	Kind	Value	Annotation
	enumeration	0358001	documentation 0
	enumeration	0358002	documentation 1
	enumeration	0358003	documentation 2
	enumeration	0358004	documentation 3
	enumeration	0358005	documentation 4
	enumeration	0358006	documentation 5 oder mehr
	enumeration	0358098	documentation genaue Anzahl unbekannt (aber mind. 1)
	enumeration	0358099	documentation unbekannt
annotation	documentation Kat_AK_AnzahlVorOP		
source	<pre> <simpleType name="enum_0358"> <annotation> <documentation>Kat_AK_AnzahlVorOP</documentation> </annotation> <restriction base="xs:string"> <enumeration value="0358001"> <annotation> <documentation>0</documentation> </annotation> </enumeration> <enumeration value="0358002"> <annotation> <documentation>1</documentation> </annotation> </enumeration> <enumeration value="0358003"> <annotation> <documentation>2</documentation> </annotation> </enumeration> <enumeration value="0358004"> <annotation> </pre>		

	<pre> <documentation>3</documentation> </annotation> </enumeration> <enumeration value="0358005"> <annotation> <documentation>4</documentation> </annotation> </enumeration> <enumeration value="0358006"> <annotation> <documentation>5 oder mehr</documentation> </annotation> </enumeration> <enumeration value="0358098"> <annotation> <documentation>genaue Anzahl unbekannt (aber mind. 1)</documentation> </annotation> </enumeration> <enumeration value="0358099"> <annotation> <documentation>unbekannt</documentation> </annotation> </enumeration> </restriction> </simpleType> </pre>
--	--

simpleType enum_0359

namespace	http://xml.ir-d.de/stn		
type	restriction of string		
properties	base xs:string		
facets	Kind	Value	Annotation
	enumeration	0359001	documentation nein
	enumeration	0359002	documentation ja - einseitig
	enumeration	0359003	documentation ja - beidseitig
	enumeration	0359042	documentation unbekannt
annotation	documentation Kat_AK_LVOT		
source	<pre> <simpleType name="enum_0359"> <annotation> <documentation>Kat_AK_LVOT</documentation> </annotation> <restriction base="xs:string"> <enumeration value="0359001"> <annotation> <documentation>nein</documentation> </annotation> </enumeration> <enumeration value="0359002"> <annotation> <documentation>ja - einseitig</documentation> </annotation> </enumeration> </restriction> </simpleType> </pre>		

	<pre> <enumeration value="0359003"> <annotation> <documentation>ja - beidseitig</documentation> </annotation> </enumeration> <enumeration value="0359042"> <annotation> <documentation>unbekannt</documentation> </annotation> </enumeration> </restriction> </simpleType> </pre>
--	---

simpleType enum_0360

namespace	http://xml.ir-d.de/stn		
type	restriction of string		
properties	base xs:string		
facets	Kind	Value	Annotation
	enumeration	0360001	documentation keine
	enumeration	0360002	documentation leichtgradig
	enumeration	0360003	documentation mittelgradig
	enumeration	0360004	documentation hochgradig
	enumeration	0360005	documentation massive
	enumeration	0360006	documentation torrential
	enumeration	0360099	documentation unbekannt
annotation	documentation Kat_AK_TriskupidalInsuffizienz		
source	<pre> <simpleType name="enum_0360"> <annotation> <documentation>Kat_AK_TriskupidalInsuffizienz</documentation> </annotation> <restriction base="xs:string"> <enumeration value="0360001"> <annotation> <documentation>keine</documentation> </annotation> </enumeration> <enumeration value="0360002"> <annotation> <documentation>leichtgradig</documentation> </annotation> </enumeration> <enumeration value="0360003"> <annotation> <documentation>mittelgradig</documentation> </annotation> </enumeration> <enumeration value="0360004"> <annotation> </pre>		

```

    <documentation>hochgradig</documentation>
  </annotation>
</enumeration>
<enumeration value="0360005">
  <annotation>
    <documentation>massive</documentation>
  </annotation>
</enumeration>
<enumeration value="0360006">
  <annotation>
    <documentation>torrential</documentation>
  </annotation>
</enumeration>
<enumeration value="0360099">
  <annotation>
    <documentation>unbekannt</documentation>
  </annotation>
</enumeration>
</restriction>
</simpleType>

```

simpleType **enum_0361**

namespace	http://xml.ir-d.de/stn		
type	restriction of string		
properties	base xs:string		
facets	Kind	Value	Annotation
	enumeration	0361001	documentation nein
	enumeration	0361002	documentation ja, letzte(r) innerhalb der letzten 48 Stunden
	enumeration	0361003	documentation ja, letzte(r) innerhalb der letzten 21 Tage
	enumeration	0361004	documentation ja, letzte(r) länger als 21 Tage
	enumeration	0361098	documentation ja, letzter Zeitpunkt unbekannt
	enumeration	0361099	documentation unbekannt
annotation	documentation Kat_AK_SchockReanimation		
source	<pre> <simpleType name="enum_0361"> <annotation> <documentation>Kat_AK_SchockReanimation</documentation> </annotation> <restriction base="xs:string"> <enumeration value="0361001"> <annotation> <documentation>nein</documentation> </annotation> </enumeration> <enumeration value="0361002"> <annotation> <documentation>ja, letzte(r) innerhalb der letzten 48 Stunden</documentation> </annotation> </enumeration> </pre>		

	<pre> <enumeration value="0361003"> <annotation> <documentation>ja, letzte(r) innerhalb der letzten 21 Tage</documentation> </annotation> </enumeration> <enumeration value="0361004"> <annotation> <documentation>ja, letzte(r) länger als 21 Tage</documentation> </annotation> </enumeration> <enumeration value="0361098"> <annotation> <documentation>ja, letzter Zeitpunkt unbekannt</documentation> </annotation> </enumeration> <enumeration value="0361099"> <annotation> <documentation>unbekannt</documentation> </annotation> </enumeration> </restriction> </simpleType> </pre>
--	--

simpleType enum_0362

namespace	http://xml.ir-d.de/stn		
type	restriction of string		
properties	base xs:string		
facets	Kind	Value	Annotation
	enumeration	0362001	documentation Sinusrhythmus
	enumeration	0362002	documentation Vorhofflimmern
	enumeration	0362042	documentation anderer Herzrhythmus
annotation	documentation Kat AK Herzrhythmus		
source	<pre> <simpleType name="enum_0362"> <annotation> <documentation>Kat_AK_Herzrhythmus</documentation> </annotation> <restriction base="xs:string"> <enumeration value="0362001"> <annotation> <documentation>Sinusrhythmus</documentation> </annotation> </enumeration> <enumeration value="0362002"> <annotation> <documentation>Vorhofflimmern</documentation> </annotation> </enumeration> <enumeration value="0362042"> <annotation> <documentation>anderer Herzrhythmus</documentation> </annotation> </enumeration> </restriction> </simpleType> </pre>		

	<pre> </enumeration> </restriction> </simpleType> </pre>
--	--

simpleType enum_0363

namespace	http://xml.ir-d.de/stn		
type	restriction of string		
properties	base xs:string		
facets	Kind	Value	Annotation
	enumeration	0363001	documentation nein
	enumeration	0363002	documentation paroxysmal
	enumeration	0363003	documentation persistierend
	enumeration	0363004	documentation permanent
annotation	documentation Kat_AK_Vorhofflimmern		
source	<pre> <simpleType name="enum_0363"> <annotation> <documentation>Kat_AK_Vorhofflimmern</documentation> </annotation> <restriction base="xs:string"> <enumeration value="0363001"> <annotation> <documentation>nein</documentation> </annotation> </enumeration> <enumeration value="0363002"> <annotation> <documentation>paroxysmal</documentation> </annotation> </enumeration> <enumeration value="0363003"> <annotation> <documentation>persistierend</documentation> </annotation> </enumeration> <enumeration value="0363004"> <annotation> <documentation>permanent</documentation> </annotation> </enumeration> </restriction> </simpleType> </pre>		

simpleType enum_0364

namespace	http://xml.ir-d.de/stn		
type	restriction of string		
properties	base xs:string		
facets	Kind	Value	Annotation

	enumeration 0364001 documentation nein enumeration 0364002 documentation Schrittmacher ohne CRT-System enumeration 0364003 documentation Schrittmacher mit CRT-System enumeration 0364004 documentation Defibrillator ohne CRT-System enumeration 0364005 documentation Defibrillator mit CRT-System
annotation	documentation Kat_AK_SchrittmacherDefi
source	<pre> <simpleType name="enum_0364"> <annotation> <documentation>Kat_AK_SchrittmacherDefi</documentation> </annotation> <restriction base="xs:string"> <enumeration value="0364001"> <annotation> <documentation>nein</documentation> </annotation> </enumeration> <enumeration value="0364002"> <annotation> <documentation>Schrittmacher ohne CRT-System</documentation> </annotation> </enumeration> <enumeration value="0364003"> <annotation> <documentation>Schrittmacher mit CRT-System</documentation> </annotation> </enumeration> <enumeration value="0364004"> <annotation> <documentation>Defibrillator ohne CRT-System</documentation> </annotation> </enumeration> <enumeration value="0364005"> <annotation> <documentation>Defibrillator mit CRT-System</documentation> </annotation> </enumeration> </restriction> </simpleType> </pre>

simpleType enum_0365

namespace	http://xml.ir-d.de/stn		
type	restriction of string		
properties	base xs:string		
facets	Kind	Value	Annotation
	enumeration	0365001	documentation nein
	enumeration	0365002	documentation ja, operativ
	enumeration	0365003	documentation ja, interventionell

annotation	documentation Kat_AK_MyokardRevaskularisation
source	<pre> <simpleType name="enum_0365"> <annotation> <documentation>Kat_AK_MyokardRevaskularisation</documentation> </annotation> <restriction base="xs:string"> <enumeration value="0365001"> <annotation> <documentation>nein</documentation> </annotation> </enumeration> <enumeration value="0365002"> <annotation> <documentation>ja, operativ</documentation> </annotation> </enumeration> <enumeration value="0365003"> <annotation> <documentation>ja, interventionell</documentation> </annotation> </enumeration> </restriction> </simpleType> </pre>

simpleType **enum_0366**

namespace	http://xml.ir-d.de/stn		
type	restriction of string		
properties	base xs:string		
facets	Kind	Value	Annotation
	enumeration	0366001	documentation nein
	enumeration	0366002	documentation ja, <= 6 Stunden
	enumeration	0366003	documentation ja, > 6 Stunden bis <= 3 Monate
	enumeration	0366004	documentation ja, > 3 Monate
	enumeration	0366099	documentation unbekannt
annotation	documentation Kat_AK_PCI		
source	<pre> <simpleType name="enum_0366"> <annotation> <documentation>Kat_AK_PCI</documentation> </annotation> <restriction base="xs:string"> <enumeration value="0366001"> <annotation> <documentation>nein</documentation> </annotation> </enumeration> <enumeration value="0366002"> <annotation> <documentation>ja, &lt;= 6 Stunden</documentation> </annotation> </pre>		

```

</enumeration>
<enumeration value="0366003">
  <annotation>
    <documentation>ja, &gt; 6 Stunden bis &lt;= 3 Monate</documentation>
  </annotation>
</enumeration>
<enumeration value="0366004">
  <annotation>
    <documentation>ja, &gt; 3 Monate</documentation>
  </annotation>
</enumeration>
<enumeration value="0366099">
  <annotation>
    <documentation>unbekannt</documentation>
  </annotation>
</enumeration>
</restriction>
</simpleType>

```

simpleType **enum_0367**

namespace	http://xml.ir-d.de/stn		
type	restriction of string		
properties	base xs:string		
facets	Kind	Value	Annotation
	enumeration	0367001	documentation keine
	enumeration	0367002	documentation Mediastinitis
	enumeration	0367003	documentation Sepsis
	enumeration	0367004	documentation broncho-pulmonale Infektion
	enumeration	0367005	documentation oto-laryngologische Infektion
	enumeration	0367006	documentation floride Endokarditis
	enumeration	0367007	documentation Peritonitis
	enumeration	0367008	documentation Wundinfektion Thorax
	enumeration	0367009	documentation Pleuraempyem
	enumeration	0367010	documentation Venenkatheterinfektion
	enumeration	0367011	documentation Harnwegsinfektion
	enumeration	0367012	documentation Wundinfektion untere Extremitäten
	enumeration	0367013	documentation HIV-Infektion
	enumeration	0367014	documentation Hepatitis B oder C
	enumeration	0367015	documentation andere Wundinfektion
	enumeration	0367042	documentation sonstige Infektion
annotation	documentation Kat AK Infektion		

source

```
<simpleType name="enum_0367">
  <annotation>
    <documentation>Kat_AK_Infektion</documentation>
  </annotation>
  <restriction base="xs:string">
    <enumeration value="0367001">
      <annotation>
        <documentation>keine</documentation>
      </annotation>
    </enumeration>
    <enumeration value="0367002">
      <annotation>
        <documentation>Mediastinitis</documentation>
      </annotation>
    </enumeration>
    <enumeration value="0367003">
      <annotation>
        <documentation>Sepsis</documentation>
      </annotation>
    </enumeration>
    <enumeration value="0367004">
      <annotation>
        <documentation>broncho-pulmonale Infektion</documentation>
      </annotation>
    </enumeration>
    <enumeration value="0367005">
      <annotation>
        <documentation>oto-laryngologische Infektion</documentation>
      </annotation>
    </enumeration>
    <enumeration value="0367006">
      <annotation>
        <documentation>floride Endokarditis</documentation>
      </annotation>
    </enumeration>
    <enumeration value="0367007">
      <annotation>
        <documentation>Peritonitis</documentation>
      </annotation>
    </enumeration>
    <enumeration value="0367008">
      <annotation>
        <documentation>Wundinfektion Thorax</documentation>
      </annotation>
    </enumeration>
    <enumeration value="0367009">
      <annotation>
        <documentation>Pleuraempyem</documentation>
      </annotation>
    </enumeration>
    <enumeration value="0367010">
      <annotation>
        <documentation>Venenkatheterinfektion</documentation>
      </annotation>
    </enumeration>
    <enumeration value="0367011">
      <annotation>
        <documentation>Harnwegsinfektion</documentation>
      </annotation>
    </enumeration>
  </restriction>
</simpleType>
```

	<pre> </enumeration> <enumeration value="0367012"> <annotation> <documentation>Wundinfektion untere Extremitäten</documentation> </annotation> </enumeration> <enumeration value="0367013"> <annotation> <documentation>HIV-Infektion</documentation> </annotation> </enumeration> <enumeration value="0367014"> <annotation> <documentation>Hepatitis B oder C</documentation> </annotation> </enumeration> <enumeration value="0367015"> <annotation> <documentation>andere Wundinfektion</documentation> </annotation> </enumeration> <enumeration value="0367042"> <annotation> <documentation>sonstige Infektion</documentation> </annotation> </enumeration> </restriction> </simpleType> </pre>
--	--

simpleType enum_0368

namespace	http://xml.ir-d.de/stn		
type	restriction of string		
properties	base xs:string		
facets	Kind	Value	Annotation
	enumeration	0368001	documentation nein
	enumeration	0368002	documentation ja, COPD mit Dauermedikation
	enumeration	0368003	documentation ja, COPD ohne Dauermedikation
	enumeration	0368004	documentation ja, andere Lungenerkrankungen
	enumeration	0368099	documentation unbekannt
annotation	documentation Kat_AK_Lungenerkrankung		
source	<pre> <simpleType name="enum_0368"> <annotation> <documentation>Kat_AK_Lungenerkrankung</documentation> </annotation> <restriction base="xs:string"> <enumeration value="0368001"> <annotation> <documentation>nein</documentation> </annotation> </enumeration> </restriction> </simpleType> </pre>		

	<pre> <enumeration value="0368002"> <annotation> <documentation>ja, COPD mit Dauermedikation</documentation> </annotation> </enumeration> <enumeration value="0368003"> <annotation> <documentation>ja, COPD ohne Dauermedikation</documentation> </annotation> </enumeration> <enumeration value="0368004"> <annotation> <documentation>ja, andere Lungenerkrankungen</documentation> </annotation> </enumeration> <enumeration value="0368099"> <annotation> <documentation>unbekannt</documentation> </annotation> </enumeration> </restriction> </simpleType> </pre>
--	--

simpleType enum_0369

namespace	http://xml.ir-d.de/stn		
type	restriction of string		
properties	base xs:string		
facets	Kind	Value	Annotation
	enumeration	0369001	documentation nein
	enumeration	0369002	documentation akut
	enumeration	0369003	documentation chronisch
annotation	documentation Kat_AK_Nierenersatztherapie		
source	<pre> <simpleType name="enum_0369"> <annotation> <documentation>Kat_AK_Nierenersatztherapie</documentation> </annotation> <restriction base="xs:string"> <enumeration value="0369001"> <annotation> <documentation>nein</documentation> </annotation> </enumeration> <enumeration value="0369002"> <annotation> <documentation>akut</documentation> </annotation> </enumeration> <enumeration value="0369003"> <annotation> <documentation>chronisch</documentation> </annotation> </enumeration> </restriction> </simpleType> </pre>		

	<pre> </restriction> </simpleType> </pre>
--	---

simpleType enum_0370

namespace	http://xml.ir-d.de/stn		
type	restriction of string		
properties	base xs:string		
facets	Kind	Value	Annotation
	enumeration	0370001	documentation Echokardiographie
	enumeration	0370002	documentation Herzkatheter
	enumeration	0370042	documentation andere
annotation	documentation Kat_AK_AKOEFMessmethode		
source	<pre> <simpleType name="enum_0370"> <annotation> <documentation>Kat_AK_AKOEFMessmethode</documentation> </annotation> <restriction base="xs:string"> <enumeration value="0370001"> <annotation> <documentation>Echokardiographie</documentation> </annotation> </enumeration> <enumeration value="0370002"> <annotation> <documentation>Herzkatheter</documentation> </annotation> </enumeration> <enumeration value="0370042"> <annotation> <documentation>andere</documentation> </annotation> </enumeration> </restriction> </simpleType> </pre>		

simpleType enum_0371

namespace	http://xml.ir-d.de/stn		
type	restriction of string		
properties	base xs:string		
facets	Kind	Value	Annotation
	enumeration	0371001	documentation keine
	enumeration	0371002	documentation leicht
	enumeration	0371003	documentation mittel
	enumeration	0371004	documentation schwer
	enumeration	0371099	documentation

	unbekannt
annotation	documentation Kat_AK_Verkalkungsgrad
source	<pre> <simpleType name="enum_0371"> <annotation> <documentation>Kat_AK_Verkalkungsgrad</documentation> </annotation> <restriction base="xs:string"> <enumeration value="0371001"> <annotation> <documentation>keine</documentation> </annotation> </enumeration> <enumeration value="0371002"> <annotation> <documentation>leicht</documentation> </annotation> </enumeration> <enumeration value="0371003"> <annotation> <documentation>mittel</documentation> </annotation> </enumeration> <enumeration value="0371004"> <annotation> <documentation>schwer</documentation> </annotation> </enumeration> <enumeration value="0371099"> <annotation> <documentation>unbekannt</documentation> </annotation> </enumeration> </restriction> </simpleType> </pre>

simpleType enum_0372

namespace	http://xml.ir-d.de/strn		
type	restriction of string		
properties	base xs:string		
facets	Kind	Value	Annotation
	enumeration	0372001	documentation nein
	enumeration	0372002	documentation ja, bicuspide
	enumeration	0372003	documentation ja, unicuspide
	enumeration	0372099	documentation unbekannt
annotation	documentation Kat_AK_BiUnicuspideKlappe		
source	<pre> <simpleType name="enum_0372"> <annotation> <documentation>Kat_AK_BiUnicuspideKlappe</documentation> </annotation> <restriction base="xs:string"> </pre>		

	<pre> <enumeration value="0372001"> <annotation> <documentation>nein</documentation> </annotation> </enumeration> <enumeration value="0372002"> <annotation> <documentation>ja, bicuspide</documentation> </annotation> </enumeration> <enumeration value="0372003"> <annotation> <documentation>ja, unicuspide</documentation> </annotation> </enumeration> <enumeration value="0372099"> <annotation> <documentation>unbekannt</documentation> </annotation> </enumeration> </restriction> </simpleType> </pre>
--	---

simpleType enum 0373

namespace	http://xml.ir-d.de/stn		
type	restriction of string		
properties	base xs:string		
facets	Kind	Value	Annotation
	enumeration	0373001	documentation keine
	enumeration	0373002	documentation leichtgradig
	enumeration	0373003	documentation mittelgradig
	enumeration	0373004	documentation hochgradig
	enumeration	0373099	documentation unbekannt
annotation	documentation Kat_AK_Grad		
source	<pre> <simpleType name="enum_0373"> <annotation> <documentation>Kat_AK_Grad</documentation> </annotation> <restriction base="xs:string"> <enumeration value="0373001"> <annotation> <documentation>keine</documentation> </annotation> </enumeration> <enumeration value="0373002"> <annotation> <documentation>leichtgradig</documentation> </annotation> </enumeration> <enumeration value="0373003"> </pre>		

	<pre> <annotation> <documentation>mittelgradig</documentation> </annotation> </enumeration> <enumeration value="0373004"> <annotation> <documentation>hochgradig</documentation> </annotation> </enumeration> <enumeration value="0373099"> <annotation> <documentation>unbekannt</documentation> </annotation> </enumeration> </restriction> </simpleType> </pre>
--	--

simpleType enum 0374

namespace	http://xml.ir-d.de/stn		
type	restriction of string		
properties	base xs:string		
facets	Kind	Value	Annotation
	enumeration	0374001	documentation nein
	enumeration	0374002	documentation ja, <= 6 Stunden
	enumeration	0374003	documentation ja, > 6 Stunden bis <= 24 Stunden
	enumeration	0374004	documentation ja, > 1 bis 7 Tage
	enumeration	0374005	documentation ja, > 7 bis 21 Tage
	enumeration	0374006	documentation ja, > 21 Tage
annotation	documentation Kat_AK_InfarktAnamnese		
source	<pre> <simpleType name="enum_0374"> <annotation> <documentation>Kat_AK_InfarktAnamnese</documentation> </annotation> <restriction base="xs:string"> <enumeration value="0374001"> <annotation> <documentation>nein</documentation> </annotation> </enumeration> <enumeration value="0374002"> <annotation> <documentation>ja, &lt;= 6 Stunden</documentation> </annotation> </enumeration> <enumeration value="0374003"> <annotation> <documentation>ja, &gt; 6 Stunden bis &lt;= 24 Stunden</documentation> </annotation> </enumeration> </pre>		

	<pre> <enumeration value="0374004"> <annotation> <documentation>ja, &gt; 1 bis 7 Tage</documentation> </annotation> </enumeration> <enumeration value="0374005"> <annotation> <documentation>ja, &gt; 7 bis 21 Tage</documentation> </annotation> </enumeration> <enumeration value="0374006"> <annotation> <documentation>ja, &gt; 21 Tage</documentation> </annotation> </enumeration> </restriction> </simpleType> </pre>
--	--

simpleType enum_0375

namespace	http://xml.ir-d.de/stn		
type	restriction of string		
properties	base xs:string		
facets	Kind	Value	Annotation
	enumeration	0375001	documentation keine Symptome oder Angina
	enumeration	0375002	documentation Symptome, aber keine Ischämiezeichen
	enumeration	0375003	documentation stabile Angina
	enumeration	0375004	documentation instabile Angina
	enumeration	0375005	documentation Infarkt ohne ST-Hebung (Non-STEMI)
	enumeration	0375006	documentation Infarkt mit ST-Hebung (STEMI)
	enumeration	0375042	documentation unbekannt
annotation	documentation Kat_AK_KardialeSymptome		
source	<pre> <simpleType name="enum_0375"> <annotation> <documentation>Kat_AK_KardialeSymptome</documentation> </annotation> <restriction base="xs:string"> <enumeration value="0375001"> <annotation> <documentation>keine Symptome oder Angina</documentation> </annotation> </enumeration> <enumeration value="0375002"> <annotation> <documentation>Symptome, aber keine Ischämiezeichen</documentation> </annotation> </enumeration> <enumeration value="0375003"> <annotation> </pre>		

	<pre> <documentation>stabile Angina</documentation> </annotation> </enumeration> <enumeration value="0375004"> <annotation> <documentation>instabile Angina</documentation> </annotation> </enumeration> <enumeration value="0375005"> <annotation> <documentation>Infarkt ohne ST-Hebung (Non-STEMI)</documentation> </annotation> </enumeration> <enumeration value="0375006"> <annotation> <documentation>Infarkt mit ST-Hebung (STEMI)</documentation> </annotation> </enumeration> <enumeration value="0375042"> <annotation> <documentation>unbekannt</documentation> </annotation> </enumeration> </restriction> </simpleType> </pre>
--	--

simpleType enum_0376

namespace	http://xml.ir-d.de/stn		
type	restriction of string		
properties	base xs:string		
facets	Kind	Value	Annotation
	enumeration	0376001	documentation nein
	enumeration	0376002	documentation ja, ZNS, zerebrovaskuläre Blutung
	enumeration	0376003	documentation ja, ZNS, zerebrovaskuläre Ischämie
	enumeration	0376042	documentation ja, ZNS, andere
annotation	documentation Kat_AK_Schlaganfall		
source	<pre> <simpleType name="enum_0376"> <annotation> <documentation>Kat_AK_Schlaganfall</documentation> </annotation> <restriction base="xs:string"> <enumeration value="0376001"> <annotation> <documentation>nein</documentation> </annotation> </enumeration> <enumeration value="0376002"> <annotation> <documentation>ja, ZNS, zerebrovaskuläre Blutung</documentation> </annotation> </enumeration> </restriction> </simpleType> </pre>		

	<pre> <enumeration value="0376003"> <annotation> <documentation>ja, ZNS, zerebrovaskuläre Ischämie</documentation> </annotation> </enumeration> <enumeration value="0376042"> <annotation> <documentation>ja, ZNS, andere</documentation> </annotation> </enumeration> </restriction> </simpleType> </pre>
--	--

simpleType enum_0377

namespace	http://xml.ir-d.de/stn		
type	restriction of string		
properties	base xs:string		
facets	Kind	Value	Annotation
	enumeration	0377001	documentation ja, mild neurological dysfunction: NIHSS 0-5
	enumeration	0377002	documentation ja, moderate neurological dysfunction: NIHSS 6-14
	enumeration	0377003	documentation ja, severe neurological dysfunction: NIHSS >=15
annotation	documentation Kat_AK_Nihss		
source	<pre> <simpleType name="enum_0377"> <annotation> <documentation>Kat_AK_Nihss</documentation> </annotation> <restriction base="xs:string"> <enumeration value="0377001"> <annotation> <documentation>ja, mild neurological dysfunction: NIHSS 0-5</documentation> </annotation> </enumeration> <enumeration value="0377002"> <annotation> <documentation>ja, moderate neurological dysfunction: NIHSS 6-14</documentation> </annotation> </enumeration> <enumeration value="0377003"> <annotation> <documentation> ja, severe neurological dysfunction: NIHSS &gt;=15</documentation> </annotation> </enumeration> </restriction> </simpleType> </pre>		

simpleType enum_0378

namespace	http://xml.ir-d.de/stn		
type	restriction of string		
properties	base xs:string		
facets	Kind	Value	Annotation
	enumeration	0378001	documentation nein
	enumeration	0378002	documentation ja, < 48h gemäss VARC-3-Definition
	enumeration	0378003	documentation ja, >= 48h - <= 72h gemäß VARC-3-Definition
	enumeration	0378004	documentation ja, > 72 h gemäß VARC-3 Definition
annotation	documentation Kat_AK_Myokardinfarkt		
source	<pre> <simpleType name="enum_0378"> <annotation> <documentation>Kat_AK_Myokardinfarkt</documentation> </annotation> <restriction base="xs:string"> <enumeration value="0378001"> <annotation> <documentation>nein</documentation> </annotation> </enumeration> <enumeration value="0378002"> <annotation> <documentation>ja, &lt; 48h gemäss VARC-3-Definition</documentation> </annotation> </enumeration> <enumeration value="0378003"> <annotation> <documentation>ja, &gt;= 48h - &lt;= 72h gemäß VARC-3-Definition</documentation> </annotation> </enumeration> <enumeration value="0378004"> <annotation> <documentation>ja, &gt; 72 h gemäß VARC-3 Definition</documentation> </annotation> </enumeration> </restriction> </simpleType> </pre>		

simpleType enum_0379

namespace	http://xml.ir-d.de/stn		
type	restriction of string		
properties	base xs:string		
facets	Kind	Value	Annotation
	enumeration	0379001	documentation Keine gefäss- oder zugangsassozierte Komplikationen
	enumeration	0379002	documentation Versagen des perkutanen Verschlusssystems
	enumeration	0379003	documentation Geringfügige Gefäßkomplikationen

	enumeration 0379004 documentation Erhebliche Gefäßkomplikationen
annotation	documentation Kat_AK_ZugangKomplikationen
source	<pre> <simpleType name="enum_0379"> <annotation> <documentation>Kat_AK_ZugangKomplikationen</documentation> </annotation> <restriction base="xs:string"> <enumeration value="0379001"> <annotation> <documentation>Keine gefäss- oder zugangsassoziierte Komplikationen</documentation> </annotation> </enumeration> <enumeration value="0379002"> <annotation> <documentation>Versagen des perkutanen Verschlussystems</documentation> </annotation> </enumeration> <enumeration value="0379003"> <annotation> <documentation>Geringfügige Gefäßkomplikationen</documentation> </annotation> </enumeration> <enumeration value="0379004"> <annotation> <documentation>Erhebliche Gefäßkomplikationen</documentation> </annotation> </enumeration> </restriction> </simpleType> </pre>

simpleType enum_0380

namespace	http://xml.ir-d.de/stn		
type	restriction of string		
properties	base xs:string		
facets	Kind	Value	Annotation
	enumeration	0380001	documentation nein
	enumeration	0380002	documentation ja, intraprozedural
	enumeration	0380003	documentation ja, postprozedural
	enumeration	0380004	documentation ja, Zeitpunkt nicht bekannt
annotation	documentation Kat_AK_Reanimation		
source	<pre> <simpleType name="enum_0380"> <annotation> <documentation>Kat_AK_Reanimation</documentation> </annotation> <restriction base="xs:string"> <enumeration value="0380001"> <annotation> </pre>		

	<pre> <documentation>nein</documentation> </annotation> </enumeration> <enumeration value="0380002"> <annotation> <documentation>ja, intraprozedural</documentation> </annotation> </enumeration> <enumeration value="0380003"> <annotation> <documentation>ja, postprozedural</documentation> </annotation> </enumeration> <enumeration value="0380004"> <annotation> <documentation>ja, Zeitpunkt nicht bekannt</documentation> </annotation> </enumeration> </restriction> </simpleType> </pre>
--	--

simpleType enum_0381

namespace	http://xml.ir-d.de/stn		
type	restriction of string		
properties	base xs:string		
facets	Kind	Value	Annotation
	enumeration	0381001	documentation nein
	enumeration	0381002	documentation Thorakotomie/Rethorakotomie
	enumeration	0381003	documentation kathetergestützte Reintervention
	enumeration	0381004	documentation lokale Reinterventionen
	enumeration	0381005	documentation andere Reintervention
annotation	documentation Kat_AK_Massnahmen		
source	<pre> <simpleType name="enum_0381"> <annotation> <documentation>Kat_AK_Massnahmen</documentation> </annotation> <restriction base="xs:string"> <enumeration value="0381001"> <annotation> <documentation>nein</documentation> </annotation> </enumeration> <enumeration value="0381002"> <annotation> <documentation>Thorakotomie/Rethorakotomie</documentation> </annotation> </enumeration> <enumeration value="0381003"> <annotation> <documentation>kathetergestützte Reintervention</documentation> </pre>		

	<pre> </annotation> </enumeration> <enumeration value="0381004"> <annotation> <documentation>lokale Reinterventionen</documentation> </annotation> </enumeration> <enumeration value="0381005"> <annotation> <documentation>andere Reintervention</documentation> </annotation> </enumeration> </restriction> </simpleType> </pre>
--	--

simpleType enum_0382

namespace	http://xml.ir-d.de/stn		
type	restriction of string		
properties	base xs:string		
facets	Kind	Value	Annotation
	enumeration	0382001	documentation keine Rethorakotomie / kein weiterer Grund
	enumeration	0382002	documentation Blutung/Hämatom
	enumeration	0382003	documentation Low Cardiac Output
	enumeration	0382004	documentation Tamponade
	enumeration	0382005	documentation Graftprobleme, Ischämie
	enumeration	0382006	documentation Wundinfektion, Mediastinitis
	enumeration	0382007	documentation Dissektion
	enumeration	0382008	documentation Prothesendysfunktion
	enumeration	0382009	documentation instabiles Sternum
	enumeration	0382010	documentation Chylothorax
	enumeration	0382011	documentation lokale Revision im Bereich des Zugangsweges
	enumeration	0382042	documentation anderer Grund
annotation	documentation Kat_AK_Komplikation		
source	<pre> <simpleType name="enum_0382"> <annotation> <documentation>Kat_AK_Komplikation</documentation> </annotation> <restriction base="xs:string"> <enumeration value="0382001"> <annotation> <documentation>keine Rethorakotomie / kein weiterer Grund</documentation> </annotation> </enumeration> </pre>		

```

<enumeration value="0382002">
  <annotation>
    <documentation>Blutung/Hämatom</documentation>
  </annotation>
</enumeration>
<enumeration value="0382003">
  <annotation>
    <documentation>Low Cardiac Output</documentation>
  </annotation>
</enumeration>
<enumeration value="0382004">
  <annotation>
    <documentation>Tamponade</documentation>
  </annotation>
</enumeration>
<enumeration value="0382005">
  <annotation>
    <documentation>Graftprobleme, Ischämie</documentation>
  </annotation>
</enumeration>
<enumeration value="0382006">
  <annotation>
    <documentation>Wundinfektion, Mediastinitis</documentation>
  </annotation>
</enumeration>
<enumeration value="0382007">
  <annotation>
    <documentation>Dissektion</documentation>
  </annotation>
</enumeration>
<enumeration value="0382008">
  <annotation>
    <documentation>Prothesendysfunktion</documentation>
  </annotation>
</enumeration>
<enumeration value="0382009">
  <annotation>
    <documentation>instabiles Sternum</documentation>
  </annotation>
</enumeration>
<enumeration value="0382010">
  <annotation>
    <documentation>Chylothorax</documentation>
  </annotation>
</enumeration>
<enumeration value="0382011">
  <annotation>
    <documentation>lokale Revision im Bereich des
Zugangsweges</documentation>
  </annotation>
</enumeration>
<enumeration value="0382042">
  <annotation>
    <documentation>anderer Grund</documentation>
  </annotation>
</enumeration>
</restriction>
</simpleType>

```

simpleType enum_0383

namespace	http://xml.ir-d.de/stn		
type	restriction of string		
properties	base xs:string		
facets	Kind	Value	Annotation
	enumeration	0383001	documentation nein
	enumeration	0383002	documentation ja, mit forcierter Atemtherapie
	enumeration	0383003	documentation ja, Reintubation oder längerfristige Beatmung
	enumeration	0383004	documentation ja, Tracheotomie
annotation	documentation Kat_AK_RespiratorischeInsuffizienz		
source	<pre> <simpleType name="enum_0383"> <annotation> <documentation>Kat_AK_RespiratorischeInsuffizienz</documentation> </annotation> <restriction base="xs:string"> <enumeration value="0383001"> <annotation> <documentation>nein</documentation> </annotation> </enumeration> <enumeration value="0383002"> <annotation> <documentation>ja, mit forcierter Atemtherapie</documentation> </annotation> </enumeration> <enumeration value="0383003"> <annotation> <documentation>ja, Reintubation oder längerfristige Beatmung</documentation> </annotation> </enumeration> <enumeration value="0383004"> <annotation> <documentation>ja, Tracheotomie</documentation> </annotation> </enumeration> </restriction> </simpleType> </pre>		

simpleType enum_0384

namespace	http://xml.ir-d.de/stn		
type	restriction of string		
properties	base xs:string		
facets	Kind	Value	Annotation
	enumeration	0384001	documentation keine Blutungskomplikationen
	enumeration	0384002	documentation Geringfügige Blutung (Minor Bleeding - BARC type 2 or 3a)

	<p>enumeration 0384003 documentation Starke Blutung (Major Bleeding - BARC type 3a)</p> <p>enumeration 0384004 documentation Lebensbedrohliche Blutung (Life-threatening or disabling bleeding - BARC type 3b or 3c or type 5)</p>
annotation	documentation Kat_AK_Blutungskomplikation
source	<pre> <simpleType name="enum_0384"> <annotation> <documentation>Kat_AK_Blutungskomplikation</documentation> </annotation> <restriction base="xs:string"> <enumeration value="0384001"> <annotation> <documentation>keine Blutungskomplikationen</documentation> </annotation> </enumeration> <enumeration value="0384002"> <annotation> <documentation>Geringfügige Blutung (Minor Bleeding - BARC type 2 or 3a)</documentation> </annotation> </enumeration> <enumeration value="0384003"> <annotation> <documentation>Starke Blutung (Major Bleeding - BARC type 3a)</documentation> </annotation> </enumeration> <enumeration value="0384004"> <annotation> <documentation>Lebensbedrohliche Blutung (Life-threatening or disabling bleeding - BARC type 3b or 3c or type 5)</documentation> </annotation> </enumeration> </restriction> </simpleType> </pre>

simpleType enum_0385

namespace	http://xml.ir-d.de/stn		
type	restriction of string		
properties	base xs:string		
facets	Kind	Value	Annotation
	enumeration	0385001	documentation Sinusrhythmus
	enumeration	0385002	documentation Vorhofflimmern
	enumeration	0385003	documentation Patient verstorben (kein Herzrhythmus)
	enumeration	0385042	documentation anderer Rhythmus
annotation	documentation Kat_AK_HerzrhythmusEntlassung		
source	<pre> <simpleType name="enum_0385"> <annotation> <documentation>Kat_AK_HerzrhythmusEntlassung</documentation> </pre>		

	<pre> </annotation> <restriction base="xs:string"> <enumeration value="0385001"> <annotation> <documentation>Sinusrhythmus</documentation> </annotation> </enumeration> <enumeration value="0385002"> <annotation> <documentation>Vorhofflimmern</documentation> </annotation> </enumeration> <enumeration value="0385003"> <annotation> <documentation>Patient verstorben (kein Herzrhythmus)</documentation> </annotation> </enumeration> <enumeration value="0385042"> <annotation> <documentation>anderer Rhythmus</documentation> </annotation> </enumeration> </restriction> </simpleType> </pre>
--	---

simpleType **enum_0388**

namespace	http://xml.ir-d.de/stn		
type	restriction of string		
properties	base xs:string		
facets	Kind	Value	Annotation
	enumeration	0388001	documentation nein
	enumeration	0388002	documentation ASS
	enumeration	0388003	documentation ADP-Rezeptor-Antagonist
	enumeration	0388004	documentation Kombination ASS und ADP-Rezeptor-Antagonist
	enumeration	0388042	documentation ja, andere
	enumeration	0388099	documentation unbekannt
annotation	documentation Kat_AK_Plaettchenaggregationshemmer		
source	<pre> <simpleType name="enum_0388"> <annotation> <documentation>Kat_AK_Plaettchenaggregationshemmer</documentation> </annotation> <restriction base="xs:string"> <enumeration value="0388001"> <annotation> <documentation>nein</documentation> </annotation> </enumeration> <enumeration value="0388002"> <annotation> </pre>		

	<pre> <documentation>ASS</documentation> </annotation> </enumeration> <enumeration value="0388003"> <annotation> <documentation>ADP-Rezeptor-Antagonist</documentation> </annotation> </enumeration> <enumeration value="0388004"> <annotation> <documentation>Kombination ASS und ADP-Rezeptor-Antagonist</documentation> </annotation> </enumeration> <enumeration value="0388042"> <annotation> <documentation>ja, andere</documentation> </annotation> </enumeration> <enumeration value="0388099"> <annotation> <documentation>unbekannt</documentation> </annotation> </enumeration> </restriction> </simpleType> </pre>
--	--

simpleType enum_0389

namespace	http://xml.ir-d.de/stn		
type	restriction of string		
properties	base xs:string		
facets	Kind	Value	Annotation
	enumeration	0389001	documentation nein
	enumeration	0389002	documentation Cumarin-Derivate
	enumeration	0389003	documentation Heparinoide
	enumeration	0389004	documentation orale Thrombinantagonisten
	enumeration	0389005	documentation Kombination Heparinoide und Cumarin-Derivate
	enumeration	0389006	documentation Direkte orale Antikoagulantien (DOAK / NOAK)
	enumeration	0389042	documentation ja, andere
	enumeration	0389099	documentation unbekannt
annotation	documentation Kat AK Antikoagulantien		
source	<pre> <simpleType name="enum_0389"> <annotation> <documentation>Kat_AK_Antikoagulantien</documentation> </annotation> <restriction base="xs:string"> <enumeration value="0389001"> <annotation> </pre>		

```

        <documentation>nein</documentation>
    </annotation>
</enumeration>
<enumeration value="0389002">
    <annotation>
        <documentation>Cumarin-Derivate</documentation>
    </annotation>
</enumeration>
<enumeration value="0389003">
    <annotation>
        <documentation>Heparinoide</documentation>
    </annotation>
</enumeration>
<enumeration value="0389004">
    <annotation>
        <documentation>orale Thrombinantagonisten</documentation>
    </annotation>
</enumeration>
<enumeration value="0389005">
    <annotation>
        <documentation>Kombination Heparinoide und
Cumarin-Derivate</documentation>
    </annotation>
</enumeration>
<enumeration value="0389006">
    <annotation>
        <documentation>Direkte orale Antikoagulantien (DOAK /
NOAK)</documentation>
    </annotation>
</enumeration>
<enumeration value="0389042">
    <annotation>
        <documentation>ja, andere</documentation>
    </annotation>
</enumeration>
<enumeration value="0389099">
    <annotation>
        <documentation>unbekannt</documentation>
    </annotation>
</enumeration>
</restriction>
</simpleType>

```

simpleType **enum_0390**

namespace	http://xml.ir-d.de/stn		
type	restriction of string		
properties	base xs:string		
facets	Kind	Value	Annotation
	enumeration	0390001	documentation biologisches Klappenmodell
	enumeration	0390002	documentation mechanisches Klappenmodell
annotation	documentation Kat_AK_Artikeltyp		
source	<simpleType name="enum_0390"> <annotation>		

	<pre> <documentation>Kat_AK_Artikeltyp</documentation> </annotation> <restriction base="xs:string"> <enumeration value="0390001"> <annotation> <documentation>biologisches Klappenmodell</documentation> </annotation> </enumeration> <enumeration value="0390002"> <annotation> <documentation>mechanisches Klappenmodell</documentation> </annotation> </enumeration> </restriction> </simpleType> </pre>
--	---

simpleType enum 0398

namespace	http://xml.ir-d.de/stn		
type	restriction of string		
properties	base xs:string		
facets	Kind	Value	Annotation
	enumeration	0398001	documentation kardiovaskuläre Ursache
	enumeration	0398002	documentation nicht-kardiovaskuläre Ursache
	enumeration	0398099	documentation Todesursache unbekannt
annotation	documentation Kat_AK_Todesursache		
source	<pre> <simpleType name="enum_0398"> <annotation> <documentation>Kat_AK_Todesursache</documentation> </annotation> <restriction base="xs:string"> <enumeration value="0398001"> <annotation> <documentation>kardiovaskuläre Ursache</documentation> </annotation> </enumeration> <enumeration value="0398002"> <annotation> <documentation>nicht-kardiovaskuläre Ursache</documentation> </annotation> </enumeration> <enumeration value="0398099"> <annotation> <documentation>Todesursache unbekannt</documentation> </annotation> </enumeration> </restriction> </simpleType> </pre>		

simpleType enum_0399

namespace	http://xml.ir-d.de/stn		
type	restriction of string		
properties	base xs:string		
facets	Kind	Value	Annotation
	enumeration	0399001	documentation Patient lebt
	enumeration	0399002	documentation Patient im Krankenhaus verstorben
annotation	documentation Kat_AK_Vitalstatus		
source	<pre> <simpleType name="enum_0399"> <annotation> <documentation>Kat_AK_Vitalstatus</documentation> </annotation> <restriction base="xs:string"> <enumeration value="0399001"> <annotation> <documentation>Patient lebt</documentation> </annotation> </enumeration> <enumeration value="0399002"> <annotation> <documentation>Patient im Krankenhaus verstorben</documentation> </annotation> </enumeration> </restriction> </simpleType> </pre>		

simpleType enum_0044

namespace	http://xml.ir-d.de/irdma		
type	restriction of string		
properties	base xs:string		
facets	Kind	Value	Annotation
	enumeration	0044001	documentation 1= normaler, sonst gesunder Patient
	enumeration	0044002	documentation 2= Patient mit leichter Allgemeinerkrankung
	enumeration	0044003	documentation 3= Patient mit schwerer Allgemeinerkrankung
	enumeration	0044004	documentation 4= Patient mit schwerer Allgemeinerkrankung, die eine ständige Lebensbedrohung darstellt
	enumeration	0044005	documentation 5= moribunder Patient, der ohne die Operation voraussichtlich nicht überleben wird
annotation	documentation Kat_ASA		
source	<pre> <simpleType name="enum_0044"> <annotation> <documentation>Kat_ASA</documentation> </annotation> <restriction base="xs:string"> <enumeration value="0044001"> <annotation> </pre>		

	<pre> <documentation>1= normaler, sonst gesunder Patient</documentation> </annotation> </enumeration> <enumeration value="0044002"> <annotation> <documentation>2= Patient mit leichter Allgemeinerkrankung</documentation> </annotation> </enumeration> <enumeration value="0044003"> <annotation> <documentation>3= Patient mit schwerer Allgemeinerkrankung</documentation> </annotation> </enumeration> <enumeration value="0044004"> <annotation> <documentation>4= Patient mit schwerer Allgemeinerkrankung, die eine ständige Lebensbedrohung darstellt</documentation> </annotation> </enumeration> <enumeration value="0044005"> <annotation> <documentation>5= moribunder Patient, der ohne die Operation voraussichtlich nicht überleben wird</documentation> </annotation> </enumeration> </restriction> </simpleType> </pre>
--	---

simpleType enum_0050

namespace	http://xml.ir-d.de/irdma		
type	restriction of string		
properties	base xs:string		
facets	Kind	Value	Annotation
	enumeration	0050001	documentation rechts
	enumeration	0050002	documentation links
annotation	documentation Kat_RechtsLinks		
source	<pre> <simpleType name="enum_0050"> <annotation> <documentation>Kat_RechtsLinks</documentation> </annotation> <restriction base="xs:string"> <enumeration value="0050001"> <annotation> <documentation>rechts</documentation> </annotation> </enumeration> <enumeration value="0050002"> <annotation> <documentation>links</documentation> </annotation> </enumeration> </restriction> </simpleType> </pre>		

	<pre> </restriction> </simpleType> </pre>
--	---

simpleType enum_0060

namespace	http://xml.ir-d.de/irdma		
type	restriction of string		
properties	base xs:string		
facets	Kind	Value	Annotation
	enumeration	0060001	documentation ja
	enumeration	0060002	documentation nein
annotation	documentation Kat_JaNein		
source	<pre> <simpleType name="enum_0060"> <annotation> <documentation>Kat_JaNein</documentation> </annotation> <restriction base="xs:string"> <enumeration value="0060001"> <annotation> <documentation>ja</documentation> </annotation> </enumeration> <enumeration value="0060002"> <annotation> <documentation>nein</documentation> </annotation> </enumeration> </restriction> </simpleType> </pre>		

simpleType enum_0061

namespace	http://xml.ir-d.de/irdma		
type	restriction of string		
properties	base xs:string		
facets	Kind	Value	Annotation
	enumeration	0061001	documentation ja
	enumeration	0061002	documentation nein
	enumeration	0061099	documentation unbekannt
annotation	documentation Kat_JaNeinUnbekannt		
source	<pre> <simpleType name="enum_0061"> <annotation> <documentation>Kat_JaNeinUnbekannt</documentation> </annotation> <restriction base="xs:string"> <enumeration value="0061001"> <annotation> </pre>		

	<pre> <documentation>ja</documentation> </annotation> </enumeration> <enumeration value="0061002"> <annotation> <documentation>nein</documentation> </annotation> </enumeration> <enumeration value="0061099"> <annotation> <documentation>unbekannt</documentation> </annotation> </enumeration> </restriction> </simpleType> </pre>
--	---

simpleType enum_0062

namespace	http://xml.ir-d.de/irdma		
type	restriction of string		
properties	base xs:string		
facets	Kind	Value	Annotation
	enumeration	0062001	documentation Stück
	enumeration	0062002	documentation g
	enumeration	0062003	documentation mg
	enumeration	0062004	documentation l
	enumeration	0062005	documentation ml
	enumeration	0062006	documentation cm ³
	enumeration	0062007	documentation mm
	enumeration	0062008	documentation cm
	enumeration	0062009	documentation dm
	enumeration	0062010	documentation m
	enumeration	0062042	documentation andere
annotation	documentation Kat Einheit		
source	<pre> <simpleType name="enum_0062"> <annotation> <documentation>Kat_Einheit</documentation> </annotation> <restriction base="xs:string"> <enumeration value="0062001"> <annotation> <documentation>Stück</documentation> </annotation> </enumeration> <enumeration value="0062002"> <annotation> </pre>		

```

    <documentation>g</documentation>
  </annotation>
</enumeration>
<enumeration value="0062003">
  <annotation>
    <documentation>mg</documentation>
  </annotation>
</enumeration>
<enumeration value="0062004">
  <annotation>
    <documentation>l</documentation>
  </annotation>
</enumeration>
<enumeration value="0062005">
  <annotation>
    <documentation>ml</documentation>
  </annotation>
</enumeration>
<enumeration value="0062006">
  <annotation>
    <documentation>cm3</documentation>
  </annotation>
</enumeration>
<enumeration value="0062007">
  <annotation>
    <documentation>mm</documentation>
  </annotation>
</enumeration>
<enumeration value="0062008">
  <annotation>
    <documentation>cm</documentation>
  </annotation>
</enumeration>
<enumeration value="0062009">
  <annotation>
    <documentation>dm</documentation>
  </annotation>
</enumeration>
<enumeration value="0062010">
  <annotation>
    <documentation>m</documentation>
  </annotation>
</enumeration>
<enumeration value="0062042">
  <annotation>
    <documentation>andere</documentation>
  </annotation>
</enumeration>
</restriction>
</simpleType>

```

simpleType enum_0065

namespace	http://xml.ir-d.de/irdma
type	restriction of string
properties	base xs:string

facets	<table border="1"> <thead> <tr> <th>Kind</th> <th>Value</th> <th>Annotation</th> </tr> </thead> <tbody> <tr> <td>enumeration</td> <td>0065001</td> <td>documentation stationär</td> </tr> <tr> <td>enumeration</td> <td>0065002</td> <td>documentation teilstationär</td> </tr> <tr> <td>enumeration</td> <td>0065003</td> <td>documentation ambulant</td> </tr> </tbody> </table>	Kind	Value	Annotation	enumeration	0065001	documentation stationär	enumeration	0065002	documentation teilstationär	enumeration	0065003	documentation ambulant
Kind	Value	Annotation											
enumeration	0065001	documentation stationär											
enumeration	0065002	documentation teilstationär											
enumeration	0065003	documentation ambulant											
annotation	documentation Kat_ArtAufenthalt												
source	<pre><simpleType name="enum_0065"> <annotation> <documentation>Kat_ArtAufenthalt</documentation> </annotation> <restriction base="xs:string"> <enumeration value="0065001"> <annotation> <documentation>stationär</documentation> </annotation> </enumeration> <enumeration value="0065002"> <annotation> <documentation>teilstationär</documentation> </annotation> </enumeration> <enumeration value="0065003"> <annotation> <documentation>ambulant</documentation> </annotation> </enumeration> </restriction> </simpleType></pre>												

simpleType enum_0067

namespace	http://xml.ir-d.de/irdma									
type	restriction of string									
properties	base xs:string									
facets	<table border="1"> <thead> <tr> <th>Kind</th> <th>Value</th> <th>Annotation</th> </tr> </thead> <tbody> <tr> <td>enumeration</td> <td>0067001</td> <td>documentation Implantat</td> </tr> <tr> <td>enumeration</td> <td>0067002</td> <td>documentation Explantat</td> </tr> </tbody> </table>	Kind	Value	Annotation	enumeration	0067001	documentation Implantat	enumeration	0067002	documentation Explantat
Kind	Value	Annotation								
enumeration	0067001	documentation Implantat								
enumeration	0067002	documentation Explantat								
annotation	documentation Kat_ArtArtikel									
source	<pre><simpleType name="enum_0067"> <annotation> <documentation>Kat_ArtArtikel</documentation> </annotation> <restriction base="xs:string"> <enumeration value="0067001"> <annotation> <documentation>Implantat</documentation> </annotation> </enumeration> <enumeration value="0067002"> <annotation> <documentation>Explantat</documentation> </annotation> </enumeration> </restriction> </simpleType></pre>									

	<pre> </annotation> </enumeration> </restriction> </simpleType> </pre>
--	--

simpleType enum_0068

namespace	http://xml.ir-d.de/irdma		
type	restriction of string		
properties	base xs:string		
facets	Kind	Value	Annotation
	enumeration	0068001	documentation UDI
	enumeration	0068002	documentation Referenz (REF)
	enumeration	0068003	documentation Katalognummer
	enumeration	0068042	documentation sonstiger
annotation	documentation Kat_KennzeichenTyp		
source	<pre> <simpleType name="enum_0068"> <annotation> <documentation>Kat_KennzeichenTyp</documentation> </annotation> <restriction base="xs:string"> <enumeration value="0068001"> <annotation> <documentation>UDI</documentation> </annotation> </enumeration> <enumeration value="0068002"> <annotation> <documentation>Referenz (REF)</documentation> </annotation> </enumeration> <enumeration value="0068003"> <annotation> <documentation>Katalognummer</documentation> </annotation> </enumeration> <enumeration value="0068042"> <annotation> <documentation>sonstiger</documentation> </annotation> </enumeration> </restriction> </simpleType> </pre>		

simpleType enum_0069

namespace	http://xml.ir-d.de/irdma		
type	restriction of string		
properties	base xs:string		

facets	<table border="1"> <thead> <tr> <th>Kind</th> <th>Value</th> <th>Annotation</th> </tr> </thead> <tbody> <tr> <td>enumeration</td> <td>0069001</td> <td>documentation Implantat</td> </tr> <tr> <td>enumeration</td> <td>0069002</td> <td>documentation Explantat</td> </tr> </tbody> </table>	Kind	Value	Annotation	enumeration	0069001	documentation Implantat	enumeration	0069002	documentation Explantat
Kind	Value	Annotation								
enumeration	0069001	documentation Implantat								
enumeration	0069002	documentation Explantat								
annotation	documentation Kat_ArtZubehoer									
source	<pre> <simpleType name="enum_0069"> <annotation> <documentation>Kat_ArtZubehoer</documentation> </annotation> <restriction base="xs:string"> <enumeration value="0069001"> <annotation> <documentation>Implantat</documentation> </annotation> </enumeration> <enumeration value="0069002"> <annotation> <documentation>Explantat</documentation> </annotation> </enumeration> </restriction> </simpleType> </pre>									

simpleType enum_0070

namespace	http://xml.ir-d.de/irdma															
type	restriction of string															
properties	base xs:string															
facets	<table border="1"> <thead> <tr> <th>Kind</th> <th>Value</th> <th>Annotation</th> </tr> </thead> <tbody> <tr> <td>enumeration</td> <td>0070001</td> <td>documentation weiblich</td> </tr> <tr> <td>enumeration</td> <td>0070002</td> <td>documentation männlich</td> </tr> <tr> <td>enumeration</td> <td>0070003</td> <td>documentation divers</td> </tr> <tr> <td>enumeration</td> <td>0070042</td> <td>documentation unbestimmt</td> </tr> </tbody> </table>	Kind	Value	Annotation	enumeration	0070001	documentation weiblich	enumeration	0070002	documentation männlich	enumeration	0070003	documentation divers	enumeration	0070042	documentation unbestimmt
Kind	Value	Annotation														
enumeration	0070001	documentation weiblich														
enumeration	0070002	documentation männlich														
enumeration	0070003	documentation divers														
enumeration	0070042	documentation unbestimmt														
annotation	documentation Kat_Geschlecht															
source	<pre> <simpleType name="enum_0070"> <annotation> <documentation>Kat_Geschlecht</documentation> </annotation> <restriction base="xs:string"> <enumeration value="0070001"> <annotation> <documentation>weiblich</documentation> </annotation> </enumeration> <enumeration value="0070002"> <annotation> <documentation>männlich</documentation> </annotation> </enumeration> <enumeration value="0070003"> </pre>															

	<pre> <annotation> <documentation>divers</documentation> </annotation> </enumeration> <enumeration value="0070042"> <annotation> <documentation>unbestimmt</documentation> </annotation> </enumeration> </restriction> </simpleType> </pre>
--	---

simpleType enum_0071

namespace	http://xml.ir-d.de/irdma		
type	restriction of string		
properties	base xs:string		
facets	Kind	Value	Annotation
	enumeration	0071001	documentation Implantat
	enumeration	0071002	documentation Explantat
	enumeration	0071003	documentation Degeneriertes/defektes Produkt, das funktionslos im Körper verbleibt
annotation	documentation Kat_ArtikelArtFunktion		
source	<pre> <simpleType name="enum_0071"> <annotation> <documentation>Kat_ArtikelArtFunktion</documentation> </annotation> <restriction base="xs:string"> <enumeration value="0071001"> <annotation> <documentation>Implantat</documentation> </annotation> </enumeration> <enumeration value="0071002"> <annotation> <documentation>Explantat</documentation> </annotation> </enumeration> <enumeration value="0071003"> <annotation> <documentation>Degeneriertes/defektes Produkt, das funktionslos im Körper verbleibt</documentation> </annotation> </enumeration> </restriction> </simpleType> </pre>		

simpleType enum_0075

namespace	http://xml.ir-d.de/irdma
type	restriction of string

properties	base xs:string												
facets	<table border="1"> <thead> <tr> <th>Kind</th> <th>Value</th> <th>Annotation</th> </tr> </thead> <tbody> <tr> <td>enumeration</td> <td>0075001</td> <td>documentation elektiv</td> </tr> <tr> <td>enumeration</td> <td>0075002</td> <td>documentation dringlich</td> </tr> <tr> <td>enumeration</td> <td>0075003</td> <td>documentation Notfall</td> </tr> </tbody> </table>	Kind	Value	Annotation	enumeration	0075001	documentation elektiv	enumeration	0075002	documentation dringlich	enumeration	0075003	documentation Notfall
Kind	Value	Annotation											
enumeration	0075001	documentation elektiv											
enumeration	0075002	documentation dringlich											
enumeration	0075003	documentation Notfall											
annotation	documentation Kat_Dringlichkeit												
source	<pre> <simpleType name="enum_0075"> <annotation> <documentation>Kat_Dringlichkeit</documentation> </annotation> <restriction base="xs:string"> <enumeration value="0075001"> <annotation> <documentation>elektiv</documentation> </annotation> </enumeration> <enumeration value="0075002"> <annotation> <documentation>dringlich</documentation> </annotation> </enumeration> <enumeration value="0075003"> <annotation> <documentation>Notfall</documentation> </annotation> </enumeration> </restriction> </simpleType> </pre>												

simpleType enum_0076

namespace	http://xml.ir-d.de/irdma															
type	restriction of string															
properties	base xs:string															
facets	<table border="1"> <thead> <tr> <th>Kind</th> <th>Value</th> <th>Annotation</th> </tr> </thead> <tbody> <tr> <td>enumeration</td> <td>0076001</td> <td>documentation elektiv</td> </tr> <tr> <td>enumeration</td> <td>0076002</td> <td>documentation dringlich</td> </tr> <tr> <td>enumeration</td> <td>0076003</td> <td>documentation Notfall</td> </tr> <tr> <td>enumeration</td> <td>0076004</td> <td>documentation Notfall (Reanimation / ultima ratio)</td> </tr> </tbody> </table>	Kind	Value	Annotation	enumeration	0076001	documentation elektiv	enumeration	0076002	documentation dringlich	enumeration	0076003	documentation Notfall	enumeration	0076004	documentation Notfall (Reanimation / ultima ratio)
Kind	Value	Annotation														
enumeration	0076001	documentation elektiv														
enumeration	0076002	documentation dringlich														
enumeration	0076003	documentation Notfall														
enumeration	0076004	documentation Notfall (Reanimation / ultima ratio)														
annotation	documentation Kat_Dringlichkeit_Reanimation															
source	<pre> <simpleType name="enum_0076"> <annotation> <documentation>Kat_Dringlichkeit_Reanimation</documentation> </annotation> <restriction base="xs:string"> <enumeration value="0076001"> <annotation> <documentation>elektiv</documentation> </annotation> </enumeration> </restriction> </simpleType> </pre>															

	<pre> </annotation> </enumeration> <enumeration value="0076002"> <annotation> <documentation>dringlich</documentation> </annotation> </enumeration> <enumeration value="0076003"> <annotation> <documentation>Notfall</documentation> </annotation> </enumeration> <enumeration value="0076004"> <annotation> <documentation>Notfall (Reanimation / ultima ratio)</documentation> </annotation> </enumeration> </restriction> </simpleType> </pre>
--	--

simpleType enum_0080

namespace	http://xml.ir-d.de/irdma		
type	restriction of string		
properties	base xs:string		
facets	Kind	Value	Annotation
	enumeration	0080001	documentation Endoprothese Hüfte/Knie
	enumeration	0080002	documentation Brustimplantat
	enumeration	0080003	documentation Aortenklappenprothese
annotation	documentation Kat_Implantattyp		
source	<pre> <simpleType name="enum_0080"> <annotation> <documentation>Kat_Implantattyp</documentation> </annotation> <restriction base="xs:string"> <enumeration value="0080001"> <annotation> <documentation>Endoprothese Hüfte/Knie</documentation> </annotation> </enumeration> <enumeration value="0080002"> <annotation> <documentation>Brustimplantat</documentation> </annotation> </enumeration> <enumeration value="0080003"> <annotation> <documentation>Aortenklappenprothese</documentation> </annotation> </enumeration> </restriction> </simpleType> </pre>		

simpleType enum_0100

namespace	http://xml.ir-d.de/irdma		
type	restriction of string		
properties	base xs:string		
facets	Kind	Value	Annotation
	enumeration	0100001	documentation Primäreingriff
	enumeration	0100002	documentation Austausch Expander gegen dauerhaftes Brustimplantat
	enumeration	0100003	documentation Revision
	enumeration	0100004	documentation Nur Explantation
annotation	documentation Kat BI_ArtEingriff		
source	<pre> <simpleType name="enum_0100"> <annotation> <documentation>Kat BI_ArtEingriff</documentation> </annotation> <restriction base="xs:string"> <enumeration value="0100001"> <annotation> <documentation>Primäreingriff</documentation> </annotation> </enumeration> <enumeration value="0100002"> <annotation> <documentation>Austausch Expander gegen dauerhaftes Brustimplantat</documentation> </annotation> </enumeration> <enumeration value="0100003"> <annotation> <documentation>Revision</documentation> </annotation> </enumeration> <enumeration value="0100004"> <annotation> <documentation>Nur Explantation</documentation> </annotation> </enumeration> </restriction> </simpleType> </pre>		

simpleType enum_0102

namespace	http://xml.ir-d.de/irdma		
type	restriction of string		
properties	base xs:string		
facets	Kind	Value	Annotation
	enumeration	0102001	documentation kosmetische Augmentation
	enumeration	0102002	documentation

	enumeration 0102003 enumeration 0102004	Rekonstruktion, benigne documentation Rekonstruktion nach Mastektomie aufgrund eines Karzinoms documentation Rekonstruktion nach risikoreduzierender Mastektomie
annotation	documentation Kat_BI_GrundPrimaereingriff	
source	<pre> <simpleType name="enum_0102"> <annotation> <documentation>Kat_BI_GrundPrimaereingriff</documentation> </annotation> <restriction base="xs:string"> <enumeration value="0102001"> <annotation> <documentation>kosmetische Augmentation</documentation> </annotation> </enumeration> <enumeration value="0102002"> <annotation> <documentation>Rekonstruktion, benigne</documentation> </annotation> </enumeration> <enumeration value="0102003"> <annotation> <documentation>Rekonstruktion nach Mastektomie aufgrund eines Karzinoms</documentation> </annotation> </enumeration> <enumeration value="0102004"> <annotation> <documentation>Rekonstruktion nach risikoreduzierender Mastektomie</documentation> </annotation> </enumeration> </restriction> </simpleType> </pre>	

simpleType enum_0103

namespace	http://xml.ir-d.de/irdma		
type	restriction of string		
properties	base	xs:string	
facets	Kind	Value	Annotation
	enumeration	0103001	documentation simultane Lappendeckung
	enumeration	0103002	documentation simultane Eigenfetttransplantation
	enumeration	0103003	documentation simultane Mastopexie
	enumeration	0103005	documentation simultane Mastektomie, Ablatio / hautsparend
	enumeration	0103006	documentation simultane Mastektomie, nippelerhaltend
	enumeration	0103007	documentation Axilla-Dissektion
	enumeration	0103008	documentation Drainage

annotation	documentation Kat_BI_OperationsdetailPrimaereingriff
source	<pre> <simpleType name="enum_0103"> <annotation> <documentation>Kat_BI_OperationsdetailPrimaereingriff</documentation> </annotation> <restriction base="xs:string"> <enumeration value="0103001"> <annotation> <documentation>simultane Lappendeckung</documentation> </annotation> </enumeration> <enumeration value="0103002"> <annotation> <documentation>simultane Eigenfetttransplantation</documentation> </annotation> </enumeration> <enumeration value="0103003"> <annotation> <documentation>simultane Mastopexie</documentation> </annotation> </enumeration> <enumeration value="0103005"> <annotation> <documentation>simultane Mastektomie, Ablatio / hautsparend</documentation> </annotation> </enumeration> <enumeration value="0103006"> <annotation> <documentation>simultane Mastektomie, nippelerhaltend</documentation> </annotation> </enumeration> <enumeration value="0103007"> <annotation> <documentation>Axilla-Dissektion</documentation> </annotation> </enumeration> <enumeration value="0103008"> <annotation> <documentation>Drainage</documentation> </annotation> </enumeration> </restriction> </simpleType> </pre>

simpleType enum_0104

namespace	http://xml.ir-d.de/irdma		
type	restriction of string		
properties	base xs:string		
facets	Kind	Value	Annotation
	enumeration	0104001	documentation Austausch Expander gegen dauerhaftes Brustimplantat
annotation	documentation Kat_BI_GrundAustausch		

source	<pre> <simpleType name="enum_0104"> <annotation> <documentation>Kat_BI_GrundAustausch</documentation> </annotation> <restriction base="xs:string"> <enumeration value="0104001"> <annotation> <documentation>Austausch Expander gegen dauerhaftes Brustimplantat</documentation> </annotation> </enumeration> </restriction> </simpleType> </pre>
--------	---

simpleType enum_0105

namespace	http://xml.ir-d.de/irdma																								
type	restriction of string																								
properties	base xs:string																								
facets	<table border="1"> <thead> <tr> <th>Kind</th> <th>Value</th> <th>Annotation</th> </tr> </thead> <tbody> <tr> <td>enumeration</td> <td>0105001</td> <td>documentation simultane Lappendeckung</td> </tr> <tr> <td>enumeration</td> <td>0105002</td> <td>documentation simultane Eigenfetttransplantation</td> </tr> <tr> <td>enumeration</td> <td>0105003</td> <td>documentation simultane Mastopexie</td> </tr> <tr> <td>enumeration</td> <td>0105008</td> <td>documentation Drainage</td> </tr> <tr> <td>enumeration</td> <td>0105009</td> <td>documentation Kapsulektomie, komplett</td> </tr> <tr> <td>enumeration</td> <td>0105010</td> <td>documentation Kapsulektomie, partiell</td> </tr> <tr> <td>enumeration</td> <td>0105011</td> <td>documentation Neopocket</td> </tr> </tbody> </table>	Kind	Value	Annotation	enumeration	0105001	documentation simultane Lappendeckung	enumeration	0105002	documentation simultane Eigenfetttransplantation	enumeration	0105003	documentation simultane Mastopexie	enumeration	0105008	documentation Drainage	enumeration	0105009	documentation Kapsulektomie, komplett	enumeration	0105010	documentation Kapsulektomie, partiell	enumeration	0105011	documentation Neopocket
Kind	Value	Annotation																							
enumeration	0105001	documentation simultane Lappendeckung																							
enumeration	0105002	documentation simultane Eigenfetttransplantation																							
enumeration	0105003	documentation simultane Mastopexie																							
enumeration	0105008	documentation Drainage																							
enumeration	0105009	documentation Kapsulektomie, komplett																							
enumeration	0105010	documentation Kapsulektomie, partiell																							
enumeration	0105011	documentation Neopocket																							
annotation	documentation Kat_BI_OperationsdetailAustausch																								
source	<pre> <simpleType name="enum_0105"> <annotation> <documentation>Kat_BI_OperationsdetailAustausch</documentation> </annotation> <restriction base="xs:string"> <enumeration value="0105001"> <annotation> <documentation>simultane Lappendeckung</documentation> </annotation> </enumeration> <enumeration value="0105002"> <annotation> <documentation>simultane Eigenfetttransplantation</documentation> </annotation> </enumeration> <enumeration value="0105003"> <annotation> <documentation>simultane Mastopexie</documentation> </annotation> </enumeration> <enumeration value="0105008"> </pre>																								

	<pre> <annotation> <documentation>Drainage</documentation> </annotation> </enumeration> <enumeration value="0105009"> <annotation> <documentation>Kapsulektomie, komplett</documentation> </annotation> </enumeration> <enumeration value="0105010"> <annotation> <documentation>Kapsulektomie, partiell</documentation> </annotation> </enumeration> <enumeration value="0105011"> <annotation> <documentation>Neopocket</documentation> </annotation> </enumeration> </restriction> </simpleType> </pre>
--	--

simpleType enum_0106

namespace	http://xml.ir-d.de/irdma		
type	restriction of string		
properties	base xs:string		
facets	Kind	Value	Annotation
	enumeration	0106001	documentation Patientenwunsch
	enumeration	0106002	documentation asymptomatisch
	enumeration	0106003	documentation Komplikation
annotation	documentation Kat_BI_GrundRevisionExplantation		
source	<pre> <simpleType name="enum_0106"> <annotation> <documentation>Kat_BI_GrundRevisionExplantation</documentation> </annotation> <restriction base="xs:string"> <enumeration value="0106001"> <annotation> <documentation>Patientenwunsch</documentation> </annotation> </enumeration> <enumeration value="0106002"> <annotation> <documentation>asymptomatisch</documentation> </annotation> </enumeration> <enumeration value="0106003"> <annotation> <documentation>Komplikation</documentation> </annotation> </enumeration> </restriction> </pre>		

	<code></simpleType></code>
--	----------------------------------

simpleType enum_0107

namespace	http://xml.ir-d.de/irdma																																	
type	restriction of string																																	
properties	base xs:string																																	
facets	<table><thead><tr><th>Kind</th><th>Value</th><th>Annotation</th></tr></thead><tbody><tr><td>enumeration</td><td>0107001</td><td>documentation simultane Lappendeckung</td></tr><tr><td>enumeration</td><td>0107002</td><td>documentation simultane Eigenfetttransplantation</td></tr><tr><td>enumeration</td><td>0107003</td><td>documentation simultane Mastopexie</td></tr><tr><td>enumeration</td><td>0107005</td><td>documentation simultane Mastektomie, Ablatio / hautsparend</td></tr><tr><td>enumeration</td><td>0107006</td><td>documentation simultane Mastektomie, nippelerhaltend</td></tr><tr><td>enumeration</td><td>0107007</td><td>documentation Axilla-Dissektion</td></tr><tr><td>enumeration</td><td>0107008</td><td>documentation Drainage</td></tr><tr><td>enumeration</td><td>0107009</td><td>documentation Kapsulektomie, komplett</td></tr><tr><td>enumeration</td><td>0107010</td><td>documentation Kapsulektomie, partiell</td></tr><tr><td>enumeration</td><td>0107011</td><td>documentation Neopocket</td></tr></tbody></table>	Kind	Value	Annotation	enumeration	0107001	documentation simultane Lappendeckung	enumeration	0107002	documentation simultane Eigenfetttransplantation	enumeration	0107003	documentation simultane Mastopexie	enumeration	0107005	documentation simultane Mastektomie, Ablatio / hautsparend	enumeration	0107006	documentation simultane Mastektomie, nippelerhaltend	enumeration	0107007	documentation Axilla-Dissektion	enumeration	0107008	documentation Drainage	enumeration	0107009	documentation Kapsulektomie, komplett	enumeration	0107010	documentation Kapsulektomie, partiell	enumeration	0107011	documentation Neopocket
Kind	Value	Annotation																																
enumeration	0107001	documentation simultane Lappendeckung																																
enumeration	0107002	documentation simultane Eigenfetttransplantation																																
enumeration	0107003	documentation simultane Mastopexie																																
enumeration	0107005	documentation simultane Mastektomie, Ablatio / hautsparend																																
enumeration	0107006	documentation simultane Mastektomie, nippelerhaltend																																
enumeration	0107007	documentation Axilla-Dissektion																																
enumeration	0107008	documentation Drainage																																
enumeration	0107009	documentation Kapsulektomie, komplett																																
enumeration	0107010	documentation Kapsulektomie, partiell																																
enumeration	0107011	documentation Neopocket																																
annotation	documentation Kat_BI_OperationsdetailRevision																																	
source	<pre><simpleType name="enum_0107"> <annotation> <documentation>Kat_BI_OperationsdetailRevision</documentation> </annotation> <restriction base="xs:string"> <enumeration value="0107001"> <annotation> <documentation>simultane Lappendeckung</documentation> </annotation> </enumeration> <enumeration value="0107002"> <annotation> <documentation>simultane Eigenfetttransplantation</documentation> </annotation> </enumeration> <enumeration value="0107003"> <annotation> <documentation>simultane Mastopexie</documentation> </annotation> </enumeration> <enumeration value="0107005"> <annotation> <documentation>simultane Mastektomie, Ablatio / hautsparend</documentation> </annotation> </enumeration> <enumeration value="0107006"> <annotation></pre>																																	

	<pre> <documentation>simultane Mastektomie, nippelerhaltend</documentation> </annotation> </enumeration> <enumeration value="0107007"> <annotation> <documentation>Axilla-Dissektion</documentation> </annotation> </enumeration> <enumeration value="0107008"> <annotation> <documentation>Drainage</documentation> </annotation> </enumeration> <enumeration value="0107009"> <annotation> <documentation>Kapsulektomie, komplett</documentation> </annotation> </enumeration> <enumeration value="0107010"> <annotation> <documentation>Kapsulektomie, partiell</documentation> </annotation> </enumeration> <enumeration value="0107011"> <annotation> <documentation>Neopocket</documentation> </annotation> </enumeration> </restriction> </simpleType> </pre>
--	--

simpleType enum_0110

namespace	http://xml.ir-d.de/irdma						
type	restriction of string						
properties	base xs:string						
facets	<table border="1"> <thead> <tr> <th>Kind</th> <th>Value</th> <th>Annotation</th> </tr> </thead> <tbody> <tr> <td>enumeration</td> <td>0110001</td> <td>documentation Bestrahlung</td> </tr> </tbody> </table>	Kind	Value	Annotation	enumeration	0110001	documentation Bestrahlung
Kind	Value	Annotation					
enumeration	0110001	documentation Bestrahlung					
annotation	documentation Kat_BI_VorbehandlungLokal						
source	<pre> <simpleType name="enum_0110"> <annotation> <documentation>Kat_BI_VorbehandlungLokal</documentation> </annotation> <restriction base="xs:string"> <enumeration value="0110001"> <annotation> <documentation>Bestrahlung</documentation> </annotation> </enumeration> </restriction> </simpleType> </pre>						

simpleType enum_0111

namespace	http://xml.ir-d.de/irdma		
type	restriction of string		
properties	base xs:string		
facets	Kind	Value	Annotation
	enumeration	0111001	documentation nein
	enumeration	0111002	documentation Lipofilling
	enumeration	0111003	documentation Eigengewebsrekonstruktion
annotation	documentation Kat_BI_Verfahrenswechsel		
source	<pre> <simpleType name="enum_0111"> <annotation> <documentation>Kat_BI_Verfahrenswechsel</documentation> </annotation> <restriction base="xs:string"> <enumeration value="0111001"> <annotation> <documentation>nein</documentation> </annotation> </enumeration> <enumeration value="0111002"> <annotation> <documentation>Lipofilling</documentation> </annotation> </enumeration> <enumeration value="0111003"> <annotation> <documentation>Eigengewebsrekonstruktion</documentation> </annotation> </enumeration> </restriction> </simpleType> </pre>		

simpleType enum_0112

namespace	http://xml.ir-d.de/irdma		
type	restriction of string		
properties	base xs:string		
facets	Kind	Value	Annotation
	enumeration	0112001	documentation subglandulär / epipektoral
	enumeration	0112002	documentation subpektoral
	enumeration	0112003	documentation subfaszial
	enumeration	0112004	documentation sub-flap
	enumeration	0112005	documentation subkutan
	enumeration	0112006	documentation dual plane
	enumeration	0112042	documentation andere

annotation	documentation Kat_BI_LageImplantat
source	<pre> <simpleType name="enum_0112"> <annotation> <documentation>Kat_BI_LageImplantat</documentation> </annotation> <restriction base="xs:string"> <enumeration value="0112001"> <annotation> <documentation>subglandulär / epipektoral</documentation> </annotation> </enumeration> <enumeration value="0112002"> <annotation> <documentation>subpektoral</documentation> </annotation> </enumeration> <enumeration value="0112003"> <annotation> <documentation>subfaszial</documentation> </annotation> </enumeration> <enumeration value="0112004"> <annotation> <documentation>sub-flap</documentation> </annotation> </enumeration> <enumeration value="0112005"> <annotation> <documentation>subkutan</documentation> </annotation> </enumeration> <enumeration value="0112006"> <annotation> <documentation>dual plane</documentation> </annotation> </enumeration> <enumeration value="0112042"> <annotation> <documentation>andere</documentation> </annotation> </enumeration> </restriction> </simpleType> </pre>

simpleType enum_0113

namespace	http://xml.ir-d.de/irdma		
type	restriction of string		
properties	base xs:string		
facets	Kind enumeration	Value 0113001	Annotation documentation Chemotherapie innerhalb der letzten drei Monate
annotation	documentation Kat_BI_VorbehandlungSystemisch		
source	<simpleType name="enum_0113">		

	<pre> <annotation> <documentation>Kat_BI_VorbehandlungSystemisch</documentation> </annotation> <restriction base="xs:string"> <enumeration value="0113001"> <annotation> <documentation>Chemotherapie innerhalb der letzten drei Monate</documentation> </annotation> </enumeration> </restriction> </simpleType> </pre>
--	--

simpleType enum_0114

namespace	http://xml.ir-d.de/irdma		
type	restriction of string		
properties	base xs:string		
facets	Kind	Value	Annotation
	enumeration	0114001	documentation vollständig
	enumeration	0114002	documentation nein
	enumeration	0114003	documentation teilweise
	enumeration	0114004	documentation nicht vorhanden
annotation	documentation Kat_BI_EntfernungADMNetz		
source	<pre> <simpleType name="enum_0114"> <annotation> <documentation>Kat_BI_EntfernungADMNetz</documentation> </annotation> <restriction base="xs:string"> <enumeration value="0114001"> <annotation> <documentation>vollständig</documentation> </annotation> </enumeration> <enumeration value="0114002"> <annotation> <documentation>nein</documentation> </annotation> </enumeration> <enumeration value="0114003"> <annotation> <documentation>teilweise</documentation> </annotation> </enumeration> <enumeration value="0114004"> <annotation> <documentation>nicht vorhanden</documentation> </annotation> </enumeration> </restriction> </simpleType> </pre>		

simpleType enum 0116

namespace	http://xml.ir-d.de/irdma		
type	restriction of string		
properties	base xs:string		
facets	Kind	Value	Annotation
	enumeration	0116001	documentation Spülung, antibiotisch
	enumeration	0116002	documentation Spülung, antiseptisch
	enumeration	0116003	documentation Spülung, wirkstofffrei
	enumeration	0116004	documentation Spülung, andere
	enumeration	0116005	documentation prä-/perioperative Antibiotika
	enumeration	0116006	documentation postoperative Antibiotika
	enumeration	0116007	documentation Handschuhwechsel vor Implantation
	enumeration	0116008	documentation Implantationshilfe
annotation	documentation Kat_BI_Operationsmassnahme		
source	<pre> <simpleType name="enum_0116"> <annotation> <documentation>Kat_BI_Operationsmassnahme</documentation> </annotation> <restriction base="xs:string"> <enumeration value="0116001"> <annotation> <documentation>Spülung, antibiotisch</documentation> </annotation> </enumeration> <enumeration value="0116002"> <annotation> <documentation>Spülung, antiseptisch</documentation> </annotation> </enumeration> <enumeration value="0116003"> <annotation> <documentation>Spülung, wirkstofffrei</documentation> </annotation> </enumeration> <enumeration value="0116004"> <annotation> <documentation>Spülung, andere</documentation> </annotation> </enumeration> <enumeration value="0116005"> <annotation> <documentation>prä-/perioperative Antibiotika</documentation> </annotation> </enumeration> <enumeration value="0116006"> <annotation> <documentation>postoperative Antibiotika</documentation> </annotation> </enumeration> </restriction> </simpleType> </pre>		

	<pre> </annotation> </enumeration> <enumeration value="0116007"> <annotation> <documentation>Handschuhwechsel vor Implantation</documentation> </annotation> </enumeration> <enumeration value="0116008"> <annotation> <documentation>Implantationshilfe</documentation> </annotation> </enumeration> </restriction> </simpleType> </pre>
--	---

simpleType enum_0118

namespace	http://xml.lir-d.de/irdma		
type	restriction of string		
properties	base xs:string		
facets	Kind	Value	Annotation
	enumeration	0118001	documentation axillär
	enumeration	0118002	documentation periareolär
	enumeration	0118003	documentation inframammär
	enumeration	0118004	documentation Mastektomienarbe
	enumeration	0118042	documentation anderer
annotation	documentation Kat_BI_Operationszugang		
source	<pre> <simpleType name="enum_0118"> <annotation> <documentation>Kat_BI_Operationszugang</documentation> </annotation> <restriction base="xs:string"> <enumeration value="0118001"> <annotation> <documentation>axillär</documentation> </annotation> </enumeration> <enumeration value="0118002"> <annotation> <documentation>periareolär</documentation> </annotation> </enumeration> <enumeration value="0118003"> <annotation> <documentation>inframammär</documentation> </annotation> </enumeration> <enumeration value="0118004"> <annotation> <documentation>Mastektomienarbe</documentation> </annotation> </enumeration> </restriction> </simpleType> </pre>		

	<pre> </enumeration> <enumeration value="0118042"> <annotation> <documentation>anderer</documentation> </annotation> </enumeration> </restriction> </simpleType> </pre>
--	---

simpleType enum_0120

namespace	http://xml.ir-d.de/irdma		
type	restriction of string		
properties	base xs:string		
facets	Kind	Value	Annotation
	enumeration	0120001	documentation Expander defekt
annotation	documentation Kat_BI_BefundAustausch		
source	<pre> <simpleType name="enum_0120"> <annotation> <documentation>Kat_BI_BefundAustausch</documentation> </annotation> <restriction base="xs:string"> <enumeration value="0120001"> <annotation> <documentation>Expander defekt</documentation> </annotation> </enumeration> </restriction> </simpleType> </pre>		

simpleType enum_0121

namespace	http://xml.ir-d.de/irdma		
type	restriction of string		
properties	base xs:string		
facets	Kind	Value	Annotation
	enumeration	0121001	documentation Infektion
	enumeration	0121002	documentation Serom
	enumeration	0121003	documentation Hämatom
	enumeration	0121004	documentation Kapsel fibrose
	enumeration	0121005	documentation Implantatruptur
	enumeration	0121006	documentation Fehlpositionierung/Rotation
	enumeration	0121007	documentation BIA-ALCL/-SCC, Verdacht
	enumeration	0121008	documentation BIA-ALCL/-SCC, pathologisch bestätigt
	enumeration	0121009	documentation

	<p>enumeration 0121010 Brustschmerzen documentation Doppelkapsel</p> <p>enumeration 0121011 documentation Netz-/ADM-bedingte Komplikation, Non-Integration</p> <p>enumeration 0121012 documentation Netz-/ADM-bedingte Komplikation, andere</p> <p>enumeration 0121013 documentation Hautnekrose/exponiertes Implantat</p> <p>enumeration 0121014 documentation BII/ASIA (Brustimplantat assoziierte Symptome), Verdacht</p> <p>enumeration 0121015 documentation Lymphadenopathie</p> <p>enumeration 0121016 documentation Brustkrebs, neu aufgetreten/Rezidiv</p>
annotation	documentation Kat_BI_BefundKomplett
source	<pre> <simpleType name="enum_0121"> <annotation> <documentation>Kat_BI_BefundKomplett</documentation> </annotation> <restriction base="xs:string"> <enumeration value="0121001"> <annotation> <documentation>Infektion</documentation> </annotation> </enumeration> <enumeration value="0121002"> <annotation> <documentation>Serom</documentation> </annotation> </enumeration> <enumeration value="0121003"> <annotation> <documentation>Hämatom</documentation> </annotation> </enumeration> <enumeration value="0121004"> <annotation> <documentation>Kapsel fibrose</documentation> </annotation> </enumeration> <enumeration value="0121005"> <annotation> <documentation>Implantatruptur</documentation> </annotation> </enumeration> <enumeration value="0121006"> <annotation> <documentation>Fehlpositionierung/Rotation</documentation> </annotation> </enumeration> <enumeration value="0121007"> <annotation> <documentation>BIA-ALCL/-SCC, Verdacht</documentation> </annotation> </enumeration> <enumeration value="0121008"> <annotation> <documentation>BIA-ALCL/-SCC, pathologisch bestätigt</documentation> </annotation> </enumeration> </restriction> </simpleType> </pre>

```

</annotation>
</enumeration>
<enumeration value="0121009">
  <annotation>
    <documentation>Brustschmerzen</documentation>
  </annotation>
</enumeration>
<enumeration value="0121010">
  <annotation>
    <documentation>Doppelkapsel</documentation>
  </annotation>
</enumeration>
<enumeration value="0121011">
  <annotation>
    <documentation>Netz-/ADM-bedingte Komplikation,
Non-Integration</documentation>
  </annotation>
</enumeration>
<enumeration value="0121012">
  <annotation>
    <documentation>Netz-/ADM-bedingte Komplikation, andere</documentation>
  </annotation>
</enumeration>
<enumeration value="0121013">
  <annotation>
    <documentation>Hautnekrose/exponiertes Implantat</documentation>
  </annotation>
</enumeration>
<enumeration value="0121014">
  <annotation>
    <documentation>BII/ASIA (Brustimplantat assoziierte Symptome),
Verdacht</documentation>
  </annotation>
</enumeration>
<enumeration value="0121015">
  <annotation>
    <documentation>Lymphadenopathie</documentation>
  </annotation>
</enumeration>
<enumeration value="0121016">
  <annotation>
    <documentation>Brustkrebs, neu aufgetreten/Rezidiv</documentation>
  </annotation>
</enumeration>
</restriction>
</simpleType>

```

simpleType enum_0122

namespace	http://xml.ir-d.de/irdma		
type	restriction of string		
properties	base xs:string		
facets	Kind	Value	Annotation
	enumeration	0122001	documentation ja, ärztlich nachgewiesen
	enumeration	0122002	documentation nein

	enumeration 0122042 documentation unbekannt
annotation	documentation Kat_BI_Autoimmunerkrankung
source	<pre> <simpleType name="enum_0122"> <annotation> <documentation>Kat_BI_Autoimmunerkrankung</documentation> </annotation> <restriction base="xs:string"> <enumeration value="0122001"> <annotation> <documentation>ja, ärztlich nachgewiesen</documentation> </annotation> </enumeration> <enumeration value="0122002"> <annotation> <documentation>nein</documentation> </annotation> </enumeration> <enumeration value="0122042"> <annotation> <documentation>unbekannt</documentation> </annotation> </enumeration> </restriction> </simpleType> </pre>

simpleType enum_0123

namespace	http://xml.ir-d.de/irdma		
type	restriction of string		
properties	base	xs:string	
facets	Kind	Value	Annotation
	enumeration	0123001	documentation neu aufgetreten
	enumeration	0123002	documentation verschlechtert
	enumeration	0123003	documentation keine Veränderung
	enumeration	0123004	documentation nicht relevant, da Primäreingriff
	enumeration	0123042	documentation unbekannt
annotation	documentation Kat_BI_VerlaufAutoimmunerkrankung		
source	<pre> <simpleType name="enum_0123"> <annotation> <documentation>Kat_BI_VerlaufAutoimmunerkrankung</documentation> </annotation> <restriction base="xs:string"> <enumeration value="0123001"> <annotation> <documentation>neu aufgetreten</documentation> </annotation> </enumeration> <enumeration value="0123002"> <annotation> </pre>		

	<pre> <documentation>verschlechtert</documentation> </annotation> </enumeration> <enumeration value="0123003"> <annotation> <documentation>keine Veränderung</documentation> </annotation> </enumeration> <enumeration value="0123004"> <annotation> <documentation>nicht relevant, da Primäreingriff</documentation> </annotation> </enumeration> <enumeration value="0123042"> <annotation> <documentation>unbekannt</documentation> </annotation> </enumeration> </restriction> </simpleType> </pre>
--	---

simpleType enum_0124

namespace	http://xml.ir-d.de/irdma		
type	restriction of string		
properties	base xs:string		
facets	Kind	Value	Annotation
	enumeration	0124001	documentation Salzlösung
	enumeration	0124002	documentation Silikongel
	enumeration	0124003	documentation Kombination Silikongel und Salzlösung
	enumeration	0124042	documentation sonstige
annotation	documentation Kat_BI_Fuellung		
source	<pre> <simpleType name="enum_0124"> <annotation> <documentation>Kat_BI_Fuellung</documentation> </annotation> <restriction base="xs:string"> <enumeration value="0124001"> <annotation> <documentation>Salzlösung</documentation> </annotation> </enumeration> <enumeration value="0124002"> <annotation> <documentation>Silikongel</documentation> </annotation> </enumeration> <enumeration value="0124003"> <annotation> <documentation>Kombination Silikongel und Salzlösung</documentation> </annotation> </enumeration> </restriction> </simpleType> </pre>		

	<pre> <enumeration value="0124042"> <annotation> <documentation>sonstige</documentation> </annotation> </enumeration> </restriction> </simpleType> </pre>
--	---

simpleType enum_0126

namespace	http://xml.ir-d.de/irdma		
type	restriction of string		
properties	base xs:string		
facets	Kind	Value	Annotation
	enumeration	0126001	documentation anatomisch (tropfenförmig)
	enumeration	0126002	documentation rund (punktsymmetrisch)
	enumeration	0126042	documentation sonstige
annotation	documentation Kat_BI_Form		
source	<pre> <simpleType name="enum_0126"> <annotation> <documentation>Kat_BI_Form</documentation> </annotation> <restriction base="xs:string"> <enumeration value="0126001"> <annotation> <documentation>anatomisch (tropfenförmig)</documentation> </annotation> </enumeration> <enumeration value="0126002"> <annotation> <documentation>rund (punktsymmetrisch)</documentation> </annotation> </enumeration> <enumeration value="0126042"> <annotation> <documentation>sonstige</documentation> </annotation> </enumeration> </restriction> </simpleType> </pre>		

simpleType enum_0128

namespace	http://xml.ir-d.de/irdma		
type	restriction of string		
properties	base xs:string		
facets	Kind	Value	Annotation
	enumeration	0128001	documentation glattwandig
	enumeration	0128002	documentation

	enumeration 0128003 documentation beschichtet texturiert
annotation	documentation Kat_BI_Oberflaeche
source	<pre> <simpleType name="enum_0128"> <annotation> <documentation>Kat_BI_Oberflaeche</documentation> </annotation> <restriction base="xs:string"> <enumeration value="0128001"> <annotation> <documentation>glattwandig</documentation> </annotation> </enumeration> <enumeration value="0128002"> <annotation> <documentation>beschichtet</documentation> </annotation> </enumeration> <enumeration value="0128003"> <annotation> <documentation>texturiert</documentation> </annotation> </enumeration> </restriction> </simpleType> </pre>

simpleType enum_0130

namespace	http://xml.ir-d.de/irdma		
type	restriction of string		
properties	base xs:string		
facets	Kind	Value	Annotation
	enumeration	0130001	documentation Allergan
	enumeration	0130002	documentation Cereplas
	enumeration	0130003	documentation CUI (Cox Uphoff Implants)
	enumeration	0130004	documentation EMSI Biomedical
	enumeration	0130005	documentation Establishment labs
	enumeration	0130006	documentation Eurosilicone
	enumeration	0130007	documentation Nagor
	enumeration	0130008	documentation Groupe Sebbin
	enumeration	0130009	documentation Laboratoires Arion
	enumeration	0130010	documentation Mentor
	enumeration	0130011	documentation Pérouse Plastie SAS
	enumeration	0130012	documentation PIP M-Implants
	enumeration	0130013	documentation

	<p>enumeration 0130014 Polytech Health & Aesthetics documentation Sillimed</p> <p>enumeration 0130015 documentation Surgitek</p> <p>enumeration 0130016 documentation G&G Biotechnology</p> <p>enumeration 0130017 documentation nicht belegter Wert</p> <p>enumeration 0130018 documentation nicht belegter Wert</p> <p>enumeration 0130019 documentation nicht belegter Wert</p> <p>enumeration 0130020 documentation nicht belegter Wert</p> <p>enumeration 0130021 documentation nicht belegter Wert</p> <p>enumeration 0130042 documentation sonstiger</p>
annotation	documentation Kat_BI_Hersteller
source	<pre> <simpleType name="enum_0130"> <annotation> <documentation>Kat_BI_Hersteller</documentation> </annotation> <restriction base="xs:string"> <enumeration value="0130001"> <annotation> <documentation>Allergan</documentation> </annotation> </enumeration> <enumeration value="0130002"> <annotation> <documentation>Cereplas</documentation> </annotation> </enumeration> <enumeration value="0130003"> <annotation> <documentation>CUI (Cox Uphoff Implants)</documentation> </annotation> </enumeration> <enumeration value="0130004"> <annotation> <documentation>EMSI Biomedical</documentation> </annotation> </enumeration> <enumeration value="0130005"> <annotation> <documentation>Establishment labs</documentation> </annotation> </enumeration> <enumeration value="0130006"> <annotation> <documentation>Eurosilicone</documentation> </annotation> </enumeration> <enumeration value="0130007"> <annotation> <documentation>Nagor</documentation> </annotation> </enumeration> </restriction> </simpleType> </pre>

```
<enumeration value="0130008">
  <annotation>
    <documentation>Groupe Sebbin</documentation>
  </annotation>
</enumeration>
<enumeration value="0130009">
  <annotation>
    <documentation>Laboratoires Arion</documentation>
  </annotation>
</enumeration>
<enumeration value="0130010">
  <annotation>
    <documentation>Mentor</documentation>
  </annotation>
</enumeration>
<enumeration value="0130011">
  <annotation>
    <documentation>Pérouse Plastie SAS</documentation>
  </annotation>
</enumeration>
<enumeration value="0130012">
  <annotation>
    <documentation>PIP M-Implants</documentation>
  </annotation>
</enumeration>
<enumeration value="0130013">
  <annotation>
    <documentation>Polytech Health & Aesthetics</documentation>
  </annotation>
</enumeration>
<enumeration value="0130014">
  <annotation>
    <documentation>Silimed</documentation>
  </annotation>
</enumeration>
<enumeration value="0130015">
  <annotation>
    <documentation>Surgitek</documentation>
  </annotation>
</enumeration>
<enumeration value="0130016">
  <annotation>
    <documentation>G&G Biotechnology</documentation>
  </annotation>
</enumeration>
<enumeration value="0130017">
  <annotation>
    <documentation>nicht belegter Wert</documentation>
  </annotation>
</enumeration>
<enumeration value="0130018">
  <annotation>
    <documentation>nicht belegter Wert</documentation>
  </annotation>
</enumeration>
<enumeration value="0130019">
  <annotation>
    <documentation>nicht belegter Wert</documentation>
  </annotation>
</enumeration>
```

	<pre> </enumeration> <enumeration value="0130020"> <annotation> <documentation>nicht belegter Wert</documentation> </annotation> </enumeration> <enumeration value="0130021"> <annotation> <documentation>nicht belegter Wert</documentation> </annotation> </enumeration> <enumeration value="0130042"> <annotation> <documentation>sonstiger</documentation> </annotation> </enumeration> </restriction> </simpleType> </pre>
--	---

simpleType **enum_0131**

namespace	http://xml.ir-d.de/irdma		
type	restriction of string		
properties	base xs:string		
facets	Kind	Value	Annotation
	enumeration	0131001	documentation Allergan
	enumeration	0131002	documentation Establishment labs
	enumeration	0131003	documentation Eurosilicone
	enumeration	0131004	documentation Galatea
	enumeration	0131005	documentation Integra
	enumeration	0131006	documentation Lifecell
	enumeration	0131007	documentation MBP (Medical Biomaterial Products)
	enumeration	0131008	documentation Mentor
	enumeration	0131009	documentation Novus Scientific
	enumeration	0131042	documentation sonstiger
annotation	documentation Kat_BI_ZubehoerHersteller		
source	<pre> <simpleType name="enum_0131"> <annotation> <documentation>Kat_BI_ZubehoerHersteller</documentation> </annotation> <restriction base="xs:string"> <enumeration value="0131001"> <annotation> <documentation>Allergan</documentation> </annotation> </enumeration> <enumeration value="0131002"> </pre>		

```

    <annotation>
      <documentation>Establishment labs</documentation>
    </annotation>
  </enumeration>
  <enumeration value="0131003">
    <annotation>
      <documentation>Eurosilicone</documentation>
    </annotation>
  </enumeration>
  <enumeration value="0131004">
    <annotation>
      <documentation>Galatea</documentation>
    </annotation>
  </enumeration>
  <enumeration value="0131005">
    <annotation>
      <documentation>Integra</documentation>
    </annotation>
  </enumeration>
  <enumeration value="0131006">
    <annotation>
      <documentation>Lifecell</documentation>
    </annotation>
  </enumeration>
  <enumeration value="0131007">
    <annotation>
      <documentation>MBP (Medical Biomaterial Products)</documentation>
    </annotation>
  </enumeration>
  <enumeration value="0131008">
    <annotation>
      <documentation>Mentor</documentation>
    </annotation>
  </enumeration>
  <enumeration value="0131009">
    <annotation>
      <documentation>Novus Scientific</documentation>
    </annotation>
  </enumeration>
  <enumeration value="0131042">
    <annotation>
      <documentation>sonstiger</documentation>
    </annotation>
  </enumeration>
</restriction>
</simpleType>

```

simpleType enum_0190

namespace	http://xml.ir-d.de/irdma		
type	restriction of string		
properties	base xs:string		
facets	Kind	Value	Annotation
	enumeration	0190001	documentation Brustimplantat
	enumeration	0190003	documentation Brustexpander

annotation	documentation Kat_BI_Artikeltyp
source	<pre> <simpleType name="enum_0190"> <annotation> <documentation>Kat_BI_Artikeltyp</documentation> </annotation> <restriction base="xs:string"> <enumeration value="0190001"> <annotation> <documentation>Brustimplantat</documentation> </annotation> </enumeration> <enumeration value="0190003"> <annotation> <documentation>Brustexpander</documentation> </annotation> </enumeration> </restriction> </simpleType> </pre>

simpleType enum_0191

namespace	http://xml.ir-d.de/irdma		
type	restriction of string		
properties	base xs:string		
facets	Kind	Value	Annotation
	enumeration	0191001	documentation Netz
	enumeration	0191002	documentation ADM
annotation	documentation Kat_BI_ZubehoerTyp		
source	<pre> <simpleType name="enum_0191"> <annotation> <documentation>Kat_BI_ZubehoerTyp</documentation> </annotation> <restriction base="xs:string"> <enumeration value="0191001"> <annotation> <documentation>Netz</documentation> </annotation> </enumeration> <enumeration value="0191002"> <annotation> <documentation>ADM</documentation> </annotation> </enumeration> </restriction> </simpleType> </pre>		

simpleType enum_0200

namespace	http://xml.ir-d.de/irdma
type	restriction of string

properties	base xs:string									
facets	<table border="1"> <thead> <tr> <th>Kind</th> <th>Value</th> <th>Annotation</th> </tr> </thead> <tbody> <tr> <td>enumeration</td> <td>0200001</td> <td>documentation Erst-OP</td> </tr> <tr> <td>enumeration</td> <td>0200002</td> <td>documentation Folgeeingriff</td> </tr> </tbody> </table>	Kind	Value	Annotation	enumeration	0200001	documentation Erst-OP	enumeration	0200002	documentation Folgeeingriff
Kind	Value	Annotation								
enumeration	0200001	documentation Erst-OP								
enumeration	0200002	documentation Folgeeingriff								
annotation	documentation Kat_EP_ArtEingriff									
source	<pre><simpleType name="enum_0200"> <annotation> <documentation>Kat_EP_ArtEingriff</documentation> </annotation> <restriction base="xs:string"> <enumeration value="0200001"> <annotation> <documentation>Erst-OP</documentation> </annotation> </enumeration> <enumeration value="0200002"> <annotation> <documentation>Folgeeingriff</documentation> </annotation> </enumeration> </restriction> </simpleType></pre>									

simpleType enum_0202

namespace	http://xml.ir-d.de/irdma																																													
type	restriction of string																																													
properties	base xs:string																																													
facets	<table border="1"> <thead> <tr> <th>Kind</th> <th>Value</th> <th>Annotation</th> </tr> </thead> <tbody> <tr> <td>enumeration</td> <td>0202001</td> <td>documentation Lockerung</td> </tr> <tr> <td>enumeration</td> <td>0202002</td> <td>documentation Infektion, Verdacht auf</td> </tr> <tr> <td>enumeration</td> <td>0202003</td> <td>documentation Infektion, gesichert</td> </tr> <tr> <td>enumeration</td> <td>0202004</td> <td>documentation Luxation, Inlay aus der Pfanne</td> </tr> <tr> <td>enumeration</td> <td>0202005</td> <td>documentation Luxation, Kopf aus Pfanne/Inlay</td> </tr> <tr> <td>enumeration</td> <td>0202006</td> <td>documentation Periprothetische Fraktur</td> </tr> <tr> <td>enumeration</td> <td>0202007</td> <td>documentation Verschleiß des PE-Inlays</td> </tr> <tr> <td>enumeration</td> <td>0202008</td> <td>documentation Implantatbruch</td> </tr> <tr> <td>enumeration</td> <td>0202009</td> <td>documentation Implantatfehlage/Malalignent</td> </tr> <tr> <td>enumeration</td> <td>0202010</td> <td>documentation Osteolysen bei festem Implantat</td> </tr> <tr> <td>enumeration</td> <td>0202011</td> <td>documentation Progression der Grunderkrankung</td> </tr> <tr> <td>enumeration</td> <td>0202012</td> <td>documentation ARMED</td> </tr> <tr> <td>enumeration</td> <td>0202013</td> <td>documentation Verdacht auf allergische Reaktion</td> </tr> <tr> <td>enumeration</td> <td>0202021</td> <td>documentation</td> </tr> </tbody> </table>	Kind	Value	Annotation	enumeration	0202001	documentation Lockerung	enumeration	0202002	documentation Infektion, Verdacht auf	enumeration	0202003	documentation Infektion, gesichert	enumeration	0202004	documentation Luxation, Inlay aus der Pfanne	enumeration	0202005	documentation Luxation, Kopf aus Pfanne/Inlay	enumeration	0202006	documentation Periprothetische Fraktur	enumeration	0202007	documentation Verschleiß des PE-Inlays	enumeration	0202008	documentation Implantatbruch	enumeration	0202009	documentation Implantatfehlage/Malalignent	enumeration	0202010	documentation Osteolysen bei festem Implantat	enumeration	0202011	documentation Progression der Grunderkrankung	enumeration	0202012	documentation ARMED	enumeration	0202013	documentation Verdacht auf allergische Reaktion	enumeration	0202021	documentation
Kind	Value	Annotation																																												
enumeration	0202001	documentation Lockerung																																												
enumeration	0202002	documentation Infektion, Verdacht auf																																												
enumeration	0202003	documentation Infektion, gesichert																																												
enumeration	0202004	documentation Luxation, Inlay aus der Pfanne																																												
enumeration	0202005	documentation Luxation, Kopf aus Pfanne/Inlay																																												
enumeration	0202006	documentation Periprothetische Fraktur																																												
enumeration	0202007	documentation Verschleiß des PE-Inlays																																												
enumeration	0202008	documentation Implantatbruch																																												
enumeration	0202009	documentation Implantatfehlage/Malalignent																																												
enumeration	0202010	documentation Osteolysen bei festem Implantat																																												
enumeration	0202011	documentation Progression der Grunderkrankung																																												
enumeration	0202012	documentation ARMED																																												
enumeration	0202013	documentation Verdacht auf allergische Reaktion																																												
enumeration	0202021	documentation																																												

	enumeration 0202042 Zustand nach Prothesenentfernung documentation andere Gründe
annotation	documentation Kat_EP_GrundWechselHuefte
source	<pre> <simpleType name="enum_0202"> <annotation> <documentation>Kat_EP_GrundWechselHuefte</documentation> </annotation> <restriction base="xs:string"> <enumeration value="0202001"> <annotation> <documentation>Lockerung</documentation> </annotation> </enumeration> <enumeration value="0202002"> <annotation> <documentation>Infektion, Verdacht auf</documentation> </annotation> </enumeration> <enumeration value="0202003"> <annotation> <documentation>Infektion, gesichert</documentation> </annotation> </enumeration> <enumeration value="0202004"> <annotation> <documentation>Luxation, Inlay aus der Pfanne</documentation> </annotation> </enumeration> <enumeration value="0202005"> <annotation> <documentation>Luxation, Kopf aus Pfanne/Inlay</documentation> </annotation> </enumeration> <enumeration value="0202006"> <annotation> <documentation>Periprothetische Fraktur</documentation> </annotation> </enumeration> <enumeration value="0202007"> <annotation> <documentation>Verschleiß des PE-Inlays</documentation> </annotation> </enumeration> <enumeration value="0202008"> <annotation> <documentation>Implantatbruch</documentation> </annotation> </enumeration> <enumeration value="0202009"> <annotation> <documentation>Implantatfehllage/Malalignent</documentation> </annotation> </enumeration> <enumeration value="0202010"> <annotation> <documentation>Osteolysen bei festem Implantat</documentation> </annotation> </enumeration> </restriction> </simpleType> </pre>

```

</enumeration>
<enumeration value="0202011">
  <annotation>
    <documentation>Progression der Grunderkrankung</documentation>
  </annotation>
</enumeration>
<enumeration value="0202012">
  <annotation>
    <documentation>ARMD</documentation>
  </annotation>
</enumeration>
<enumeration value="0202013">
  <annotation>
    <documentation>Verdacht auf allergische Reaktion</documentation>
  </annotation>
</enumeration>
<enumeration value="0202021">
  <annotation>
    <documentation>Zustand nach Prothesenentfernung</documentation>
  </annotation>
</enumeration>
<enumeration value="0202042">
  <annotation>
    <documentation>andere Gründe</documentation>
  </annotation>
</enumeration>
</restriction>
</simpleType>

```

simpleType enum_0204

namespace	http://xml.ir-d.de/irdma		
type	restriction of string		
properties	base xs:string		
facets	Kind	Value	Annotation
	enumeration	0204001	documentation Lockerung
	enumeration	0204002	documentation Infektion, Verdacht auf
	enumeration	0204003	documentation Infektion, gesichert
	enumeration	0204006	documentation Periprothetische Fraktur
	enumeration	0204007	documentation Verschleiß
	enumeration	0204008	documentation Implantatbruch
	enumeration	0204009	documentation Implantatfehlage/Malalignent
	enumeration	0204010	documentation Osteolysen bei festem Implantat
	enumeration	0204011	documentation Progression der Grunderkrankung
	enumeration	0204012	documentation ARMD
	enumeration	0204013	documentation Verdacht auf allergische Reaktion
	enumeration	0204014	documentation Dislokation/Migration von Komponenten

	<p>enumeration 0204015 documentation Bandinstabilität</p> <p>enumeration 0204016 documentation Bewegungseinschränkung</p> <p>enumeration 0204021 documentation Zustand nach Prothesenentfernung</p> <p>enumeration 0204042 documentation andere Gründe</p>
annotation	documentation Kat_EP_GrundWechselKnie
source	<pre> <simpleType name="enum_0204"> <annotation> <documentation>Kat_EP_GrundWechselKnie</documentation> </annotation> <restriction base="xs:string"> <enumeration value="0204001"> <annotation> <documentation>Lockerung</documentation> </annotation> </enumeration> <enumeration value="0204002"> <annotation> <documentation>Infektion, Verdacht auf</documentation> </annotation> </enumeration> <enumeration value="0204003"> <annotation> <documentation>Infektion, gesichert</documentation> </annotation> </enumeration> <enumeration value="0204006"> <annotation> <documentation>Periprothetische Fraktur</documentation> </annotation> </enumeration> <enumeration value="0204007"> <annotation> <documentation>Verschleiß</documentation> </annotation> </enumeration> <enumeration value="0204008"> <annotation> <documentation>Implantatbruch</documentation> </annotation> </enumeration> <enumeration value="0204009"> <annotation> <documentation>Implantatfehlage/Malalignent</documentation> </annotation> </enumeration> <enumeration value="0204010"> <annotation> <documentation>Osteolysen bei festem Implantat</documentation> </annotation> </enumeration> <enumeration value="0204011"> <annotation> <documentation>Progression der Grunderkrankung</documentation> </annotation> </enumeration> </restriction> </simpleType> </pre>

```

<enumeration value="0204012">
  <annotation>
    <documentation>ARMD</documentation>
  </annotation>
</enumeration>
<enumeration value="0204013">
  <annotation>
    <documentation>Verdacht auf allergische Reaktion</documentation>
  </annotation>
</enumeration>
<enumeration value="0204014">
  <annotation>
    <documentation>Dislokation/Migration von Komponenten</documentation>
  </annotation>
</enumeration>
<enumeration value="0204015">
  <annotation>
    <documentation>Bandinstabilität</documentation>
  </annotation>
</enumeration>
<enumeration value="0204016">
  <annotation>
    <documentation>Bewegungseinschränkung</documentation>
  </annotation>
</enumeration>
<enumeration value="0204021">
  <annotation>
    <documentation>Zustand nach Prothesenentfernung</documentation>
  </annotation>
</enumeration>
<enumeration value="0204042">
  <annotation>
    <documentation>andere Gründe</documentation>
  </annotation>
</enumeration>
</restriction>
</simpleType>

```

simpleType enum 0206

namespace	http://xml.ir-d.de/irdma		
type	restriction of string		
properties	base xs:string		
facets	Kind	Value	Annotation
	enumeration	0206001	documentation Lockerung
	enumeration	0206002	documentation Infektion, Verdacht auf
	enumeration	0206003	documentation Infektion, gesichert
	enumeration	0206004	documentation Luxation, Inlay aus der Pfanne
	enumeration	0206005	documentation Luxation, Kopf aus Pfanne/Inlay
	enumeration	0206006	documentation Periprothetische Fraktur
	enumeration	0206007	documentation Verschleiß

	<p>enumeration 0206008 documentation Implantatbruch</p> <p>enumeration 0206009 documentation Implantatfehlage/Malalignent</p> <p>enumeration 0206010 documentation Osteolysen bei festem Implantat</p> <p>enumeration 0206011 documentation Progression der Grunderkrankung</p> <p>enumeration 0206012 documentation ARM-D</p> <p>enumeration 0206013 documentation Verdacht auf allergische Reaktion</p> <p>enumeration 0206014 documentation Dislokation/Migration von Komponenten</p> <p>enumeration 0206015 documentation Bandinstabilität</p> <p>enumeration 0206016 documentation Bewegungseinschränkung</p> <p>enumeration 0206021 documentation Zustand nach Prothesenentfernung</p> <p>enumeration 0206042 documentation andere Gründe</p>
annotation	documentation Kat_EP_GrundWechselTFE
source	<pre> <simpleType name="enum_0206"> <annotation> <documentation>Kat_EP_GrundWechselTFE</documentation> </annotation> <restriction base="xs:string"> <enumeration value="0206001"> <annotation> <documentation>Lockerung</documentation> </annotation> </enumeration> <enumeration value="0206002"> <annotation> <documentation>Infektion, Verdacht auf</documentation> </annotation> </enumeration> <enumeration value="0206003"> <annotation> <documentation>Infektion, gesichert</documentation> </annotation> </enumeration> <enumeration value="0206004"> <annotation> <documentation>Luxation, Inlay aus der Pfanne</documentation> </annotation> </enumeration> <enumeration value="0206005"> <annotation> <documentation>Luxation, Kopf aus Pfanne/Inlay</documentation> </annotation> </enumeration> <enumeration value="0206006"> <annotation> <documentation>Periprothetische Fraktur</documentation> </annotation> </enumeration> <enumeration value="0206007"> <annotation> </pre>

```
<documentation>Verschleiß</documentation>
</annotation>
</enumeration>
<enumeration value="0206008">
  <annotation>
    <documentation>Implantatbruch</documentation>
  </annotation>
</enumeration>
<enumeration value="0206009">
  <annotation>
    <documentation>Implantatfehllage/Malalignent</documentation>
  </annotation>
</enumeration>
<enumeration value="0206010">
  <annotation>
    <documentation>Osteolysen bei festem Implantat</documentation>
  </annotation>
</enumeration>
<enumeration value="0206011">
  <annotation>
    <documentation>Progression der Grunderkrankung</documentation>
  </annotation>
</enumeration>
<enumeration value="0206012">
  <annotation>
    <documentation>ARMD</documentation>
  </annotation>
</enumeration>
<enumeration value="0206013">
  <annotation>
    <documentation>Verdacht auf allergische Reaktion</documentation>
  </annotation>
</enumeration>
<enumeration value="0206014">
  <annotation>
    <documentation>Dislokation/Migration von Komponenten</documentation>
  </annotation>
</enumeration>
<enumeration value="0206015">
  <annotation>
    <documentation>Bandinstabilität</documentation>
  </annotation>
</enumeration>
<enumeration value="0206016">
  <annotation>
    <documentation>Bewegungseinschränkung</documentation>
  </annotation>
</enumeration>
<enumeration value="0206021">
  <annotation>
    <documentation>Zustand nach Prothesenentfernung</documentation>
  </annotation>
</enumeration>
<enumeration value="0206042">
  <annotation>
    <documentation>andere Gründe</documentation>
  </annotation>
</enumeration>
</restriction>
```

	<code></simpleType></code>
--	----------------------------------

simpleType enum_0210

namespace	http://xml.ir-d.de/irdma																								
type	restriction of string																								
properties	base xs:string																								
facets	<table><thead><tr><th>Kind</th><th>Value</th><th>Annotation</th></tr></thead><tbody><tr><td>enumeration</td><td>0210001</td><td>documentation keine relevante Voroperation</td></tr><tr><td>enumeration</td><td>0210002</td><td>documentation Osteosynthese/Osteotomie (Becken)</td></tr><tr><td>enumeration</td><td>0210003</td><td>documentation Osteosynthese/Osteotomie (Femur)</td></tr><tr><td>enumeration</td><td>0210004</td><td>documentation Osteosynthese/Osteotomie (beides)</td></tr><tr><td>enumeration</td><td>0210005</td><td>documentation Operation bei Hüftkopfnekrose</td></tr><tr><td>enumeration</td><td>0210006</td><td>documentation Arthrodese</td></tr><tr><td>enumeration</td><td>0210042</td><td>documentation andere</td></tr></tbody></table>	Kind	Value	Annotation	enumeration	0210001	documentation keine relevante Voroperation	enumeration	0210002	documentation Osteosynthese/Osteotomie (Becken)	enumeration	0210003	documentation Osteosynthese/Osteotomie (Femur)	enumeration	0210004	documentation Osteosynthese/Osteotomie (beides)	enumeration	0210005	documentation Operation bei Hüftkopfnekrose	enumeration	0210006	documentation Arthrodese	enumeration	0210042	documentation andere
Kind	Value	Annotation																							
enumeration	0210001	documentation keine relevante Voroperation																							
enumeration	0210002	documentation Osteosynthese/Osteotomie (Becken)																							
enumeration	0210003	documentation Osteosynthese/Osteotomie (Femur)																							
enumeration	0210004	documentation Osteosynthese/Osteotomie (beides)																							
enumeration	0210005	documentation Operation bei Hüftkopfnekrose																							
enumeration	0210006	documentation Arthrodese																							
enumeration	0210042	documentation andere																							
annotation	documentation Kat_EP_VoroperationHuefte																								
source	<pre><simpleType name="enum_0210"> <annotation> <documentation>Kat_EP_VoroperationHuefte</documentation> </annotation> <restriction base="xs:string"> <enumeration value="0210001"> <annotation> <documentation>keine relevante Voroperation</documentation> </annotation> </enumeration> <enumeration value="0210002"> <annotation> <documentation>Osteosynthese/Osteotomie (Becken)</documentation> </annotation> </enumeration> <enumeration value="0210003"> <annotation> <documentation>Osteosynthese/Osteotomie (Femur)</documentation> </annotation> </enumeration> <enumeration value="0210004"> <annotation> <documentation>Osteosynthese/Osteotomie (beides)</documentation> </annotation> </enumeration> <enumeration value="0210005"> <annotation> <documentation>Operation bei Hüftkopfnekrose</documentation> </annotation> </enumeration> <enumeration value="0210006"> <annotation> <documentation>Arthrodese</documentation> </annotation> </enumeration> </restriction> </simpleType></pre>																								

	<pre> </annotation> </enumeration> <enumeration value="0210042"> <annotation> <documentation>andere</documentation> </annotation> </enumeration> </restriction> </simpleType> </pre>
--	--

simpleType enum_0211

namespace	http://xml.ir-d.de/irdma		
type	restriction of string		
properties	base xs:string		
facets	Kind	Value	Annotation
	enumeration	0211001	documentation keine relevante Voroperation
	enumeration	0211002	documentation Osteosynthese/Osteotomie (Femur)
	enumeration	0211003	documentation Osteosynthese/Osteotomie (Tibia)
	enumeration	0211004	documentation Osteosynthese/Osteotomie (Patella)
	enumeration	0211005	documentation Osteosynthese/Osteotomie (mehrere)
	enumeration	0211006	documentation Kapsel-/Bandapparat
	enumeration	0211007	documentation Arthrodese
	enumeration	0211042	documentation andere
annotation	documentation Kat_EP_VoroperationKnie		
source	<pre> <simpleType name="enum_0211"> <annotation> <documentation>Kat_EP_VoroperationKnie</documentation> </annotation> <restriction base="xs:string"> <enumeration value="0211001"> <annotation> <documentation>keine relevante Voroperation</documentation> </annotation> </enumeration> <enumeration value="0211002"> <annotation> <documentation>Osteosynthese/Osteotomie (Femur)</documentation> </annotation> </enumeration> <enumeration value="0211003"> <annotation> <documentation>Osteosynthese/Osteotomie (Tibia)</documentation> </annotation> </enumeration> <enumeration value="0211004"> <annotation> <documentation>Osteosynthese/Osteotomie (Patella)</documentation> </annotation> </enumeration> </restriction> </simpleType> </pre>		

	<pre> </enumeration> <enumeration value="0211005"> <annotation> <documentation>Osteosynthese/Osteotomie (mehrere)</documentation> </annotation> </enumeration> <enumeration value="0211006"> <annotation> <documentation>Kapsel-/Bandapparat</documentation> </annotation> </enumeration> <enumeration value="0211007"> <annotation> <documentation>Arthrodese</documentation> </annotation> </enumeration> <enumeration value="0211042"> <annotation> <documentation>andere</documentation> </annotation> </enumeration> </restriction> </simpleType> </pre>
--	---

simpleType enum_0212

namespace	http://xml.ir-d.de/irdma		
type	restriction of string		
properties	base xs:string		
facets	Kind	Value	Annotation
	enumeration	0212001	documentation Hüfte
	enumeration	0212002	documentation Knie
	enumeration	0212003	documentation Totaler Femurersatz inkl. Durchsteck-Prothese
annotation	documentation Kat EP Gelenk		
source	<pre> <simpleType name="enum_0212"> <annotation> <documentation>Kat_EP_Gelenk</documentation> </annotation> <restriction base="xs:string"> <enumeration value="0212001"> <annotation> <documentation>Hüfte</documentation> </annotation> </enumeration> <enumeration value="0212002"> <annotation> <documentation>Knie</documentation> </annotation> </enumeration> <enumeration value="0212003"> <annotation> <documentation>Totaler Femurersatz inkl. Durchsteck-Prothese</documentation> </pre>		

```

</annotation>
</enumeration>
</restriction>
</simpleType>

```

simpleType enum_0220

namespace	http://xml.ir-d.de/irdma		
type	restriction of string		
properties	base xs:string		
facets	Kind	Value	Annotation
	enumeration	0220001	documentation anterior
	enumeration	0220002	documentation anterolateral
	enumeration	0220003	documentation lateral
	enumeration	0220004	documentation posterior
	enumeration	0220005	documentation posterolateral
	enumeration	0220006	documentation 2-Inzisionen-Zugang
	enumeration	0220042	documentation sonstiges/unbekannt
annotation	documentation Kat_EP_Operationszugang		
source	<pre> <simpleType name="enum_0220"> <annotation> <documentation>Kat_EP_Operationszugang</documentation> </annotation> <restriction base="xs:string"> <enumeration value="0220001"> <annotation> <documentation>anterior</documentation> </annotation> </enumeration> <enumeration value="0220002"> <annotation> <documentation>anterolateral</documentation> </annotation> </enumeration> <enumeration value="0220003"> <annotation> <documentation>lateral</documentation> </annotation> </enumeration> <enumeration value="0220004"> <annotation> <documentation>posterior</documentation> </annotation> </enumeration> <enumeration value="0220005"> <annotation> <documentation>posterolateral</documentation> </annotation> </enumeration> </restriction> </simpleType> </pre>		

	<pre> <enumeration value="0220006"> <annotation> <documentation>2-Inzisionen-Zugang</documentation> </annotation> </enumeration> <enumeration value="0220042"> <annotation> <documentation>sonstiges/unbekannt</documentation> </annotation> </enumeration> </restriction> </simpleType> </pre>
--	---

simpleType enum_0222

namespace	http://xml.ir-d.de/irdma		
type	restriction of string		
properties	base xs:string		
facets	Kind	Value	Annotation
	enumeration	0222001	documentation nein
	enumeration	0222002	documentation ja- Ausbau
	enumeration	0222003	documentation ja- Einbau
annotation	documentation Kat_EP_Zweizeitwechsel		
source	<pre> <simpleType name="enum_0222"> <annotation> <documentation>Kat_EP_Zweizeitwechsel</documentation> </annotation> <restriction base="xs:string"> <enumeration value="0222001"> <annotation> <documentation>nein</documentation> </annotation> </enumeration> <enumeration value="0222002"> <annotation> <documentation>ja- Ausbau</documentation> </annotation> </enumeration> <enumeration value="0222003"> <annotation> <documentation>ja- Einbau</documentation> </annotation> </enumeration> </restriction> </simpleType> </pre>		

simpleType enum_0230

namespace	http://xml.ir-d.de/irdma
type	restriction of string

properties	base xs:string		
facets	Kind	Value	Annotation
	enumeration	0230001	documentation Smith & Nephew GmbH
	enumeration	0230002	documentation Mathys Orthopädie GmbH
	enumeration	0230003	documentation Ceramtec AG
	enumeration	0230004	documentation Biomet
	enumeration	0230005	documentation Peter Brehm GmbH
	enumeration	0230006	documentation Amplitude GmbH
	enumeration	0230007	documentation Exactech Deutschland
	enumeration	0230008	documentation Globus Medical
	enumeration	0230009	documentation Implantcast GmbH
	enumeration	0230010	documentation DePuy Orthopädie GmbH
	enumeration	0230011	documentation IO-International Orthopaedics
	enumeration	0230012	documentation Joint Replacement Ltd. Instrumentation
	enumeration	0230013	documentation Merete
	enumeration	0230014	documentation S&G Implants GmbH
	enumeration	0230015	documentation Speetec Implantate GmbH
	enumeration	0230016	documentation Stemcup Medical Products GmbH
	enumeration	0230017	documentation Symbios Deutschland GmbH
	enumeration	0230018	documentation Tantum AG
	enumeration	0230019	documentation Tomier GmbH
	enumeration	0230020	documentation MicroPort Orthopedics GmbH
	enumeration	0230021	documentation aap Implanate AG
	enumeration	0230022	documentation AQImplants
	enumeration	0230023	documentation ESKA Orthodynamics GmbH
	enumeration	0230024	documentation Ateos medical AG
	enumeration	0230025	documentation Chiropro GmbH
	enumeration	0230026	documentation Medacta
	enumeration	0230027	documentation OHST Medizintechnik AG
	enumeration	0230028	documentation Lima Deutschland GmbH
	enumeration	0230029	documentation alloPlus GmbH
	enumeration	0230030	documentation Heraeus Medical GmbH
	enumeration	0230031	documentation ImplanTec Deutschland GmbH

	<p>enumeration 0230032 documentation Falcon Medical GmbH</p> <p>enumeration 0230033 documentation Meril GmbH</p> <p>enumeration 0230034 documentation Zimmer Germany GmbH</p> <p>enumeration 0230035 documentation Stryker GmbH & Co. KG</p> <p>enumeration 0230036 documentation Aesculap AG</p> <p>enumeration 0230037 documentation Waldemar Link GmbH & Co. KG</p> <p>enumeration 0230038 documentation Corin Germany GmbH</p> <p>enumeration 0230039 documentation nicht belegter Wert</p> <p>enumeration 0230040 documentation nicht belegter Wert</p> <p>enumeration 0230041 documentation nicht belegter Wert</p> <p>enumeration 0230042 documentation sonstige</p> <p>enumeration 0230043 documentation nicht belegter Wert</p> <p>enumeration 0230044 documentation nicht belegter Wert</p>
annotation	documentation Kat_EP_Hersteller
source	<pre> <simpleType name="enum_0230"> <annotation> <documentation>Kat_EP_Hersteller</documentation> </annotation> <restriction base="xs:string"> <enumeration value="0230001"> <annotation> <documentation>Smith & Nephew GmbH</documentation> </annotation> </enumeration> <enumeration value="0230002"> <annotation> <documentation>Mathys Orthopädie GmbH</documentation> </annotation> </enumeration> <enumeration value="0230003"> <annotation> <documentation>Ceramtec AG</documentation> </annotation> </enumeration> <enumeration value="0230004"> <annotation> <documentation>Biomet</documentation> </annotation> </enumeration> <enumeration value="0230005"> <annotation> <documentation>Peter Brehm GmbH</documentation> </annotation> </enumeration> <enumeration value="0230006"> <annotation> <documentation>Amplitude GmbH</documentation> </annotation> </enumeration> </restriction> </simpleType> </pre>

```
</annotation>
</enumeration>
<enumeration value="0230007">
  <annotation>
    <documentation>Exactech Deutschland</documentation>
  </annotation>
</enumeration>
<enumeration value="0230008">
  <annotation>
    <documentation>Globus Medical</documentation>
  </annotation>
</enumeration>
<enumeration value="0230009">
  <annotation>
    <documentation>Implantcast GmbH</documentation>
  </annotation>
</enumeration>
<enumeration value="0230010">
  <annotation>
    <documentation>DePuy Orthopädie GmbH</documentation>
  </annotation>
</enumeration>
<enumeration value="0230011">
  <annotation>
    <documentation>IO-International Orthopaedics</documentation>
  </annotation>
</enumeration>
<enumeration value="0230012">
  <annotation>
    <documentation>Joint Replacement Ltd. Instrumentation</documentation>
  </annotation>
</enumeration>
<enumeration value="0230013">
  <annotation>
    <documentation>Merete</documentation>
  </annotation>
</enumeration>
<enumeration value="0230014">
  <annotation>
    <documentation>S&G Implants GmbH</documentation>
  </annotation>
</enumeration>
<enumeration value="0230015">
  <annotation>
    <documentation>Speetec Implantate GmbH</documentation>
  </annotation>
</enumeration>
<enumeration value="0230016">
  <annotation>
    <documentation>Stemcup Medical Products GmbH</documentation>
  </annotation>
</enumeration>
<enumeration value="0230017">
  <annotation>
    <documentation>Symbios Deutschland GmbH</documentation>
  </annotation>
</enumeration>
<enumeration value="0230018">
  <annotation>
```



```
<documentation>Tantum AG</documentation>
</annotation>
</enumeration>
<enumeration value="0230019">
  <annotation>
    <documentation>Tornier GmbH</documentation>
  </annotation>
</enumeration>
<enumeration value="0230020">
  <annotation>
    <documentation>MicroPort Orthopedics GmbH</documentation>
  </annotation>
</enumeration>
<enumeration value="0230021">
  <annotation>
    <documentation>aap Implanate AG</documentation>
  </annotation>
</enumeration>
<enumeration value="0230022">
  <annotation>
    <documentation>AQImplants</documentation>
  </annotation>
</enumeration>
<enumeration value="0230023">
  <annotation>
    <documentation>ESKA Orthodynamics GmbH</documentation>
  </annotation>
</enumeration>
<enumeration value="0230024">
  <annotation>
    <documentation>Ateos medical AG</documentation>
  </annotation>
</enumeration>
<enumeration value="0230025">
  <annotation>
    <documentation>Chiropro GmbH</documentation>
  </annotation>
</enumeration>
<enumeration value="0230026">
  <annotation>
    <documentation>Medacta</documentation>
  </annotation>
</enumeration>
<enumeration value="0230027">
  <annotation>
    <documentation>OHST Medizintechnik AG</documentation>
  </annotation>
</enumeration>
<enumeration value="0230028">
  <annotation>
    <documentation>Lima Deutschland GmbH</documentation>
  </annotation>
</enumeration>
<enumeration value="0230029">
  <annotation>
    <documentation>alloPlus GmbH</documentation>
  </annotation>
</enumeration>
<enumeration value="0230030">
```

```
<annotation>
  <documentation>Heraeus Medical GmbH</documentation>
</annotation>
</enumeration>
<enumeration value="0230031">
  <annotation>
    <documentation>ImplanTec Deutschland GmbH</documentation>
  </annotation>
</enumeration>
<enumeration value="0230032">
  <annotation>
    <documentation>Falcon Medical GmbH</documentation>
  </annotation>
</enumeration>
<enumeration value="0230033">
  <annotation>
    <documentation>Meril GmbH</documentation>
  </annotation>
</enumeration>
<enumeration value="0230034">
  <annotation>
    <documentation>Zimmer Germany GmbH</documentation>
  </annotation>
</enumeration>
<enumeration value="0230035">
  <annotation>
    <documentation>Stryker GmbH & Co. KG</documentation>
  </annotation>
</enumeration>
<enumeration value="0230036">
  <annotation>
    <documentation>Aesculap AG</documentation>
  </annotation>
</enumeration>
<enumeration value="0230037">
  <annotation>
    <documentation>Waldemar Link GmbH & Co. KG</documentation>
  </annotation>
</enumeration>
<enumeration value="0230038">
  <annotation>
    <documentation>Corin Germany GmbH</documentation>
  </annotation>
</enumeration>
<enumeration value="0230039">
  <annotation>
    <documentation>nicht belegter Wert</documentation>
  </annotation>
</enumeration>
<enumeration value="0230040">
  <annotation>
    <documentation>nicht belegter Wert</documentation>
  </annotation>
</enumeration>
<enumeration value="0230041">
  <annotation>
    <documentation>nicht belegter Wert</documentation>
  </annotation>
</enumeration>
```

	<pre> <enumeration value="0230042"> <annotation> <documentation>sonstige</documentation> </annotation> </enumeration> <enumeration value="0230043"> <annotation> <documentation>nicht belegter Wert</documentation> </annotation> </enumeration> <enumeration value="0230044"> <annotation> <documentation>nicht belegter Wert</documentation> </annotation> </enumeration> </restriction> </simpleType> </pre>
--	---

simpleType enum 0252

namespace	http://xml.ir-d.de/irdma		
type	restriction of string		
properties	base xs:string		
facets	Kind	Value	Annotation
	enumeration	0252001	documentation Pfanne
	enumeration	0252002	documentation Schaft
	enumeration	0252003	documentation beides
annotation	documentation Kat EP KomponenteHuefte		
source	<pre> <simpleType name="enum_0252"> <annotation> <documentation>Kat_EP_KomponenteHuefte</documentation> </annotation> <restriction base="xs:string"> <enumeration value="0252001"> <annotation> <documentation>Pfanne</documentation> </annotation> </enumeration> <enumeration value="0252002"> <annotation> <documentation>Schaft</documentation> </annotation> </enumeration> <enumeration value="0252003"> <annotation> <documentation>beides</documentation> </annotation> </enumeration> </restriction> </simpleType> </pre>		

simpleType enum_0254

namespace	http://xml.ir-d.de/irdma		
type	restriction of string		
properties	base xs:string		
facets	Kind	Value	Annotation
	enumeration	0254001	documentation Femur
	enumeration	0254002	documentation Tibia
	enumeration	0254003	documentation Patella
	enumeration	0254004	documentation mehrere
annotation	documentation Kat_EP_KomponenteKnie		
source	<pre> <simpleType name="enum_0254"> <annotation> <documentation>Kat_EP_KomponenteKnie</documentation> </annotation> <restriction base="xs:string"> <enumeration value="0254001"> <annotation> <documentation>Femur</documentation> </annotation> </enumeration> <enumeration value="0254002"> <annotation> <documentation>Tibia</documentation> </annotation> </enumeration> <enumeration value="0254003"> <annotation> <documentation>Patella</documentation> </annotation> </enumeration> <enumeration value="0254004"> <annotation> <documentation>mehrere</documentation> </annotation> </enumeration> </restriction> </simpleType> </pre>		

simpleType enum_0256

namespace	http://xml.ir-d.de/irdma		
type	restriction of string		
properties	base xs:string		
facets	Kind	Value	Annotation
	enumeration	0256001	documentation Pfanne
	enumeration	0256002	documentation Schaft
	enumeration	0256003	documentation Pfanne und Schaft
	enumeration	0256004	documentation

	<p>enumeration 0256005 Femur documentation Tibia</p> <p>enumeration 0256006 documentation Patella</p> <p>enumeration 0256007 documentation mehrere</p>
annotation	documentation Kat_EP_KomponenteTFE
source	<pre> <simpleType name="enum_0256"> <annotation> <documentation>Kat_EP_KomponenteTFE</documentation> </annotation> <restriction base="xs:string"> <enumeration value="0256001"> <annotation> <documentation>Pfanne</documentation> </annotation> </enumeration> <enumeration value="0256002"> <annotation> <documentation>Schaft</documentation> </annotation> </enumeration> <enumeration value="0256003"> <annotation> <documentation>Pfanne und Schaft</documentation> </annotation> </enumeration> <enumeration value="0256004"> <annotation> <documentation>Femur</documentation> </annotation> </enumeration> <enumeration value="0256005"> <annotation> <documentation>Tibia</documentation> </annotation> </enumeration> <enumeration value="0256006"> <annotation> <documentation>Patella</documentation> </annotation> </enumeration> <enumeration value="0256007"> <annotation> <documentation>mehrere</documentation> </annotation> </enumeration> </restriction> </simpleType> </pre>

simpleType enum_0262

namespace	http://xml.ir-d.de/irdma
type	restriction of string
properties	base xs:string

facets	<table border="1"> <thead> <tr> <th>Kind</th> <th>Value</th> <th>Annotation</th> </tr> </thead> <tbody> <tr> <td>enumeration</td> <td>0262001</td> <td>documentation Pfanne</td> </tr> <tr> <td>enumeration</td> <td>0262002</td> <td>documentation Schaft</td> </tr> <tr> <td>enumeration</td> <td>0262003</td> <td>documentation Kopf</td> </tr> <tr> <td>enumeration</td> <td>0262004</td> <td>documentation Inlay</td> </tr> <tr> <td>enumeration</td> <td>0262005</td> <td>documentation Adapter</td> </tr> <tr> <td>enumeration</td> <td>0262006</td> <td>documentation mehrere</td> </tr> </tbody> </table>	Kind	Value	Annotation	enumeration	0262001	documentation Pfanne	enumeration	0262002	documentation Schaft	enumeration	0262003	documentation Kopf	enumeration	0262004	documentation Inlay	enumeration	0262005	documentation Adapter	enumeration	0262006	documentation mehrere
Kind	Value	Annotation																				
enumeration	0262001	documentation Pfanne																				
enumeration	0262002	documentation Schaft																				
enumeration	0262003	documentation Kopf																				
enumeration	0262004	documentation Inlay																				
enumeration	0262005	documentation Adapter																				
enumeration	0262006	documentation mehrere																				
annotation	documentation Kat_EP_ImplantatbruchHuefte																					
source	<pre> <simpleType name="enum_0262"> <annotation> <documentation>Kat_EP_ImplantatbruchHuefte</documentation> </annotation> <restriction base="xs:string"> <enumeration value="0262001"> <annotation> <documentation>Pfanne</documentation> </annotation> </enumeration> <enumeration value="0262002"> <annotation> <documentation>Schaft</documentation> </annotation> </enumeration> <enumeration value="0262003"> <annotation> <documentation>Kopf</documentation> </annotation> </enumeration> <enumeration value="0262004"> <annotation> <documentation>Inlay</documentation> </annotation> </enumeration> <enumeration value="0262005"> <annotation> <documentation>Adapter</documentation> </annotation> </enumeration> <enumeration value="0262006"> <annotation> <documentation>mehrere</documentation> </annotation> </enumeration> </restriction> </simpleType> </pre>																					

simpleType enum_0264

namespace	http://xml.ir-d.de/irdma
type	restriction of string

properties	base xs:string																											
facets	<table border="1"> <thead> <tr> <th>Kind</th> <th>Value</th> <th>Annotation</th> </tr> </thead> <tbody> <tr> <td>enumeration</td> <td>0264001</td> <td>documentation Femur</td> </tr> <tr> <td>enumeration</td> <td>0264002</td> <td>documentation Tibia</td> </tr> <tr> <td>enumeration</td> <td>0264003</td> <td>documentation Inlay</td> </tr> <tr> <td>enumeration</td> <td>0264004</td> <td>documentation Adapter</td> </tr> <tr> <td>enumeration</td> <td>0264005</td> <td>documentation Verlängerung</td> </tr> <tr> <td>enumeration</td> <td>0264006</td> <td>documentation Schrauben</td> </tr> <tr> <td>enumeration</td> <td>0264007</td> <td>documentation mehrere</td> </tr> <tr> <td>enumeration</td> <td>0264042</td> <td>documentation andere</td> </tr> </tbody> </table>	Kind	Value	Annotation	enumeration	0264001	documentation Femur	enumeration	0264002	documentation Tibia	enumeration	0264003	documentation Inlay	enumeration	0264004	documentation Adapter	enumeration	0264005	documentation Verlängerung	enumeration	0264006	documentation Schrauben	enumeration	0264007	documentation mehrere	enumeration	0264042	documentation andere
Kind	Value	Annotation																										
enumeration	0264001	documentation Femur																										
enumeration	0264002	documentation Tibia																										
enumeration	0264003	documentation Inlay																										
enumeration	0264004	documentation Adapter																										
enumeration	0264005	documentation Verlängerung																										
enumeration	0264006	documentation Schrauben																										
enumeration	0264007	documentation mehrere																										
enumeration	0264042	documentation andere																										
annotation	documentation Kat_EP_ImplantatbruchKnie																											
source	<pre> <simpleType name="enum_0264"> <annotation> <documentation>Kat_EP_ImplantatbruchKnie</documentation> </annotation> <restriction base="xs:string"> <enumeration value="0264001"> <annotation> <documentation>Femur</documentation> </annotation> </enumeration> <enumeration value="0264002"> <annotation> <documentation>Tibia</documentation> </annotation> </enumeration> <enumeration value="0264003"> <annotation> <documentation>Inlay</documentation> </annotation> </enumeration> <enumeration value="0264004"> <annotation> <documentation>Adapter</documentation> </annotation> </enumeration> <enumeration value="0264005"> <annotation> <documentation>Verlängerung</documentation> </annotation> </enumeration> <enumeration value="0264006"> <annotation> <documentation>Schrauben</documentation> </annotation> </enumeration> <enumeration value="0264007"> <annotation> <documentation>mehrere</documentation> </annotation> </enumeration> </restriction> </simpleType> </pre>																											

	<pre> <enumeration value="0264042"> <annotation> <documentation>andere</documentation> </annotation> </enumeration> </restriction> </simpleType> </pre>
--	---

simpleType enum_0266

namespace	http://xml.ir-d.de/irdma		
type	restriction of string		
properties	base xs:string		
facets	Kind	Value	Annotation
	enumeration	0266001	documentation Pfanne
	enumeration	0266002	documentation Schaft
	enumeration	0266003	documentation Kopf
	enumeration	0266004	documentation Inlay
	enumeration	0266005	documentation Adapter
	enumeration	0266006	documentation Femur
	enumeration	0266007	documentation Tibia
	enumeration	0266008	documentation Verlängerung
	enumeration	0266009	documentation Schrauben
	enumeration	0266010	documentation mehrere
	enumeration	0266042	documentation andere
annotation	documentation Kat_EP_ImplantatbruchTFE		
source	<pre> <simpleType name="enum_0266"> <annotation> <documentation>Kat_EP_ImplantatbruchTFE</documentation> </annotation> <restriction base="xs:string"> <enumeration value="0266001"> <annotation> <documentation>Pfanne</documentation> </annotation> </enumeration> <enumeration value="0266002"> <annotation> <documentation>Schaft</documentation> </annotation> </enumeration> <enumeration value="0266003"> <annotation> <documentation>Kopf</documentation> </annotation> </enumeration> </restriction> </simpleType> </pre>		

```

<enumeration value="0266004">
  <annotation>
    <documentation>Inlay</documentation>
  </annotation>
</enumeration>
<enumeration value="0266005">
  <annotation>
    <documentation>Adapter</documentation>
  </annotation>
</enumeration>
<enumeration value="0266006">
  <annotation>
    <documentation>Femur</documentation>
  </annotation>
</enumeration>
<enumeration value="0266007">
  <annotation>
    <documentation>Tibia</documentation>
  </annotation>
</enumeration>
<enumeration value="0266008">
  <annotation>
    <documentation>Verlängerung</documentation>
  </annotation>
</enumeration>
<enumeration value="0266009">
  <annotation>
    <documentation>Schrauben</documentation>
  </annotation>
</enumeration>
<enumeration value="0266010">
  <annotation>
    <documentation>mehrere</documentation>
  </annotation>
</enumeration>
<enumeration value="0266042">
  <annotation>
    <documentation>andere</documentation>
  </annotation>
</enumeration>
</restriction>
</simpleType>

```

simpleType enum_0270

namespace	http://xml.ir-d.de/irdma		
type	restriction of string		
properties	base xs:string		
facets	Kind	Value	Annotation
	enumeration	0270001	documentation PE-Inlay
	enumeration	0270002	documentation patellare Komponente
	enumeration	0270003	documentation beides
annotation	documentation Kat_EP_VerschleissKnie		

source	<pre> <simpleType name="enum_0270"> <annotation> <documentation>Kat_EP_VerschleissKnie</documentation> </annotation> <restriction base="xs:string"> <enumeration value="0270001"> <annotation> <documentation>PE-Inlay</documentation> </annotation> </enumeration> <enumeration value="0270002"> <annotation> <documentation>patellare Komponente</documentation> </annotation> </enumeration> <enumeration value="0270003"> <annotation> <documentation>beides</documentation> </annotation> </enumeration> </restriction> </simpleType> </pre>
--------	---

simpleType enum_0271

namespace	http://xml.ir-d.de/irdma		
type	restriction of string		
properties	base xs:string		
facets	Kind	Value	Annotation
	enumeration	0271001	documentation Schraube
	enumeration	0271002	documentation Inlay
	enumeration	0271003	documentation patellare Komponente
	enumeration	0271004	documentation Kopplung
	enumeration	0271005	documentation mehrere
	enumeration	0271042	documentation andere
annotation	documentation Kat_EP_MigrationKnie		
source	<pre> <simpleType name="enum_0271"> <annotation> <documentation>Kat_EP_MigrationKnie</documentation> </annotation> <restriction base="xs:string"> <enumeration value="0271001"> <annotation> <documentation>Schraube</documentation> </annotation> </enumeration> <enumeration value="0271002"> <annotation> <documentation>Inlay</documentation> </annotation> </enumeration> </restriction> </simpleType> </pre>		

	<pre> </enumeration> <enumeration value="0271003"> <annotation> <documentation>patellare Komponente</documentation> </annotation> </enumeration> <enumeration value="0271004"> <annotation> <documentation>Kopplung</documentation> </annotation> </enumeration> <enumeration value="0271005"> <annotation> <documentation>mehrere</documentation> </annotation> </enumeration> <enumeration value="0271042"> <annotation> <documentation>andere</documentation> </annotation> </enumeration> </restriction> </simpleType> </pre>
--	---

simpleType enum_0290

namespace	http://xml.ir-d.de/irdma		
type	restriction of string		
properties	base xs:string		
facets	Kind	Value	Annotation
	enumeration	0290001	documentation Hüft-Komponente
	enumeration	0290002	documentation Knie-Komponente
	enumeration	0290003	documentation Modulare Komponente (Hüfte/Knie)
annotation	documentation Kat EP Artikeltyp		
source	<pre> <simpleType name="enum_0290"> <annotation> <documentation>Kat_EP_Artikeltyp</documentation> </annotation> <restriction base="xs:string"> <enumeration value="0290001"> <annotation> <documentation>Hüft-Komponente</documentation> </annotation> </enumeration> <enumeration value="0290002"> <annotation> <documentation>Knie-Komponente</documentation> </annotation> </enumeration> <enumeration value="0290003"> <annotation> <documentation>Modulare Komponente (Hüfte/Knie)</documentation> </annotation> </enumeration> </restriction> </simpleType> </pre>		

	<pre> </enumeration> </restriction> </simpleType> </pre>
--	--

simpleType enum_0291

namespace	http://xml.ir-d.de/irdma		
type	restriction of string		
properties	base xs:string		
facets	Kind	Value	Annotation
	enumeration	0291001	documentation Knochen-Zement
	enumeration	0291002	documentation sonstiges Zubehör
annotation	documentation Kat_EP_ZubehoerTyp		
source	<pre> <simpleType name="enum_0291"> <annotation> <documentation>Kat_EP_ZubehoerTyp</documentation> </annotation> <restriction base="xs:string"> <enumeration value="0291001"> <annotation> <documentation>Knochen-Zement</documentation> </annotation> </enumeration> <enumeration value="0291002"> <annotation> <documentation>sonstiges Zubehör</documentation> </annotation> </enumeration> </restriction> </simpleType> </pre>		

simpleType enum_0300

namespace	http://xml.ir-d.de/irdma		
type	restriction of string		
properties	base xs:string		
facets	Kind	Value	Annotation
	enumeration	0300001	documentation konventioneller Aortenklappenersatz
	enumeration	0300002	documentation kathetergestützte Aortenklappenimplantation (TAVI)
annotation	documentation Kat_AK_ArtEingriff		
source	<pre> <simpleType name="enum_0300"> <annotation> <documentation>Kat_AK_ArtEingriff</documentation> </annotation> <restriction base="xs:string"> <enumeration value="0300001"> <annotation> <documentation>konventioneller Aortenklappenersatz</documentation> </annotation> </enumeration> </restriction> </simpleType> </pre>		

	<pre> </annotation> </enumeration> <enumeration value="0300002"> <annotation> <documentation>kathetergestützte Aortenklappenimplantation (TAVI)</documentation> </annotation> </enumeration> </restriction> </simpleType> </pre>
--	--

simpleType enum_0302

namespace	http://xml.ir-d.de/irdma		
type	restriction of string		
properties	base xs:string		
facets	Kind	Value	Annotation
	enumeration	0302001	documentation Stenose
	enumeration	0302002	documentation Insuffizienz
	enumeration	0302003	documentation Stenose und Insuffizienz
annotation	documentation Kat_AK_GrundEingriff		
source	<pre> <simpleType name="enum_0302"> <annotation> <documentation>Kat_AK_GrundEingriff</documentation> </annotation> <restriction base="xs:string"> <enumeration value="0302001"> <annotation> <documentation>Stenose</documentation> </annotation> </enumeration> <enumeration value="0302002"> <annotation> <documentation>Insuffizienz</documentation> </annotation> </enumeration> <enumeration value="0302003"> <annotation> <documentation>Stenose und Insuffizienz</documentation> </annotation> </enumeration> </restriction> </simpleType> </pre>		

simpleType enum_0318

namespace	http://xml.ir-d.de/irdma		
type	restriction of string		
properties	base xs:string		

facets	<table border="1"> <thead> <tr> <th>Kind</th> <th>Value</th> <th>Annotation</th> </tr> </thead> <tbody> <tr> <td>enumeration</td> <td>0318001</td> <td>documentation transapikal</td> </tr> <tr> <td>enumeration</td> <td>0318002</td> <td>documentation transaortal</td> </tr> <tr> <td>enumeration</td> <td>0318003</td> <td>documentation transfemorale</td> </tr> <tr> <td>enumeration</td> <td>0318004</td> <td>documentation transaxillär</td> </tr> <tr> <td>enumeration</td> <td>0318042</td> <td>documentation anderer Zugangsweg</td> </tr> </tbody> </table>	Kind	Value	Annotation	enumeration	0318001	documentation transapikal	enumeration	0318002	documentation transaortal	enumeration	0318003	documentation transfemorale	enumeration	0318004	documentation transaxillär	enumeration	0318042	documentation anderer Zugangsweg
Kind	Value	Annotation																	
enumeration	0318001	documentation transapikal																	
enumeration	0318002	documentation transaortal																	
enumeration	0318003	documentation transfemorale																	
enumeration	0318004	documentation transaxillär																	
enumeration	0318042	documentation anderer Zugangsweg																	
annotation	documentation Kat AK ZugangKatheter																		
source	<pre> <simpleType name="enum_0318"> <annotation> <documentation>Kat_AK_ZugangKatheter</documentation> </annotation> <restriction base="xs:string"> <enumeration value="0318001"> <annotation> <documentation>transapikal</documentation> </annotation> </enumeration> <enumeration value="0318002"> <annotation> <documentation>transaortal</documentation> </annotation> </enumeration> <enumeration value="0318003"> <annotation> <documentation>transfemorale</documentation> </annotation> </enumeration> <enumeration value="0318004"> <annotation> <documentation>transaxillär</documentation> </annotation> </enumeration> <enumeration value="0318042"> <annotation> <documentation>anderer Zugangsweg</documentation> </annotation> </enumeration> </restriction> </simpleType> </pre>																		

simpleType enum_0320

namespace	http://xml.ir-d.de/irdma												
type	restriction of string												
properties	base xs:string												
facets	<table border="1"> <thead> <tr> <th>Kind</th> <th>Value</th> <th>Annotation</th> </tr> </thead> <tbody> <tr> <td>enumeration</td> <td>0320001</td> <td>documentation konventionelle Sternotomie</td> </tr> <tr> <td>enumeration</td> <td>0320002</td> <td>documentation partielle Sternotomie</td> </tr> <tr> <td>enumeration</td> <td>0320003</td> <td>documentation parasternaler Zugang</td> </tr> </tbody> </table>	Kind	Value	Annotation	enumeration	0320001	documentation konventionelle Sternotomie	enumeration	0320002	documentation partielle Sternotomie	enumeration	0320003	documentation parasternaler Zugang
Kind	Value	Annotation											
enumeration	0320001	documentation konventionelle Sternotomie											
enumeration	0320002	documentation partielle Sternotomie											
enumeration	0320003	documentation parasternaler Zugang											

	enumeration 0320042 documentation anderer Zugangsweg
annotation	documentation Kat_AK_ZugangKonventionell
source	<pre> <simpleType name="enum_0320"> <annotation> <documentation>Kat_AK_ZugangKonventionell</documentation> </annotation> <restriction base="xs:string"> <enumeration value="0320001"> <annotation> <documentation>konventionelle Sternotomie</documentation> </annotation> </enumeration> <enumeration value="0320002"> <annotation> <documentation>partielle Sternotomie</documentation> </annotation> </enumeration> <enumeration value="0320003"> <annotation> <documentation>parasternaler Zugang</documentation> </annotation> </enumeration> <enumeration value="0320042"> <annotation> <documentation>anderer Zugangsweg</documentation> </annotation> </enumeration> </restriction> </simpleType> </pre>

simpleType enum_0322

namespace	http://xml.ir-d.de/irdma		
type	restriction of string		
properties	base xs:string		
facets	Kind	Value	Annotation
	enumeration	0322001	documentation nein
	enumeration	0322002	documentation ja, diätetisch behandelt
	enumeration	0322003	documentation ja, orale Medikation
	enumeration	0322004	documentation ja, mit Insulin behandelt
	enumeration	0322005	documentation ja, unbehandelt
	enumeration	0322099	documentation unbekannt
annotation	documentation Kat_AK_Diabetes		
source	<pre> <simpleType name="enum_0322"> <annotation> <documentation>Kat_AK_Diabetes</documentation> </annotation> <restriction base="xs:string"> </pre>		

	<pre> <enumeration value="0322001"> <annotation> <documentation>nein</documentation> </annotation> </enumeration> <enumeration value="0322002"> <annotation> <documentation>ja, diätetisch behandelt</documentation> </annotation> </enumeration> <enumeration value="0322003"> <annotation> <documentation>ja, orale Medikation</documentation> </annotation> </enumeration> <enumeration value="0322004"> <annotation> <documentation>ja, mit Insulin behandelt</documentation> </annotation> </enumeration> <enumeration value="0322005"> <annotation> <documentation>ja, unbehandelt</documentation> </annotation> </enumeration> <enumeration value="0322099"> <annotation> <documentation>unbekannt</documentation> </annotation> </enumeration> </restriction> </simpleType> </pre>
--	--

simpleType enum_0324

namespace	http://xml.ir-d.de/irdma		
type	restriction of string		
properties	base xs:string		
facets	Kind	Value	Annotation
	enumeration	0324001	documentation (I): Beschwerdefreiheit, normale körperliche Belastbarkeit
	enumeration	0324002	documentation (II): Beschwerden bei stärkerer körperlicher Belastung
	enumeration	0324003	documentation (III): Beschwerden bei leichter körperlicher Belastung
	enumeration	0324004	documentation (IV): Beschwerden in Ruhe
annotation	documentation Kat_AK_NYHA		
source	<pre> <simpleType name="enum_0324"> <annotation> <documentation>Kat_AK_NYHA</documentation> </annotation> <restriction base="xs:string"> <enumeration value="0324001"> <annotation> <documentation>(I): Beschwerdefreiheit, normale körperliche </pre>		

	<pre> Belastbarkeit</documentation> </annotation> </enumeration> <enumeration value="0324002"> <annotation> <documentation>(II): Beschwerden bei stärkerer körperlicher Belastung</documentation> </annotation> </enumeration> <enumeration value="0324003"> <annotation> <documentation>(III): Beschwerden bei leichter körperlicher Belastung</documentation> </annotation> </enumeration> <enumeration value="0324004"> <annotation> <documentation>(IV): Beschwerden in Ruhe</documentation> </annotation> </enumeration> </restriction> </simpleType> </pre>
--	---

simpleType **enum_0330**

namespace	http://xml.ir-d.de/irdma		
type	restriction of string		
properties	base xs:string		
facets	Kind	Value	Annotation
	enumeration	0330001	documentation ATS Medical
	enumeration	0330002	documentation Edwards Lifesciences
	enumeration	0330003	documentation Medtronic
	enumeration	0330004	documentation JenaValve
	enumeration	0330005	documentation Corcym
	enumeration	0330006	documentation St.Jude Medical/Abbott
	enumeration	0330007	documentation Symetis
	enumeration	0330008	documentation Direct Flow Medical
	enumeration	0330009	documentation Boston Scientific
	enumeration	0330010	documentation nicht belegter Wert
	enumeration	0330011	documentation nicht belegter Wert
	enumeration	0330012	documentation nicht belegter Wert
	enumeration	0330013	documentation nicht belegter Wert
	enumeration	0330014	documentation nicht belegter Wert
	enumeration	0330042	documentation sonstiger Hersteller

annotation	documentation Kat_AK_Hersteller
source	<pre> <simpleType name="enum_0330"> <annotation> <documentation>Kat_AK_Hersteller</documentation> </annotation> <restriction base="xs:string"> <enumeration value="0330001"> <annotation> <documentation>ATS Medical</documentation> </annotation> </enumeration> <enumeration value="0330002"> <annotation> <documentation>Edwards Lifesciences</documentation> </annotation> </enumeration> <enumeration value="0330003"> <annotation> <documentation>Medtronic</documentation> </annotation> </enumeration> <enumeration value="0330004"> <annotation> <documentation>JenaValve</documentation> </annotation> </enumeration> <enumeration value="0330005"> <annotation> <documentation>Corcym</documentation> </annotation> </enumeration> <enumeration value="0330006"> <annotation> <documentation>St.Jude Medical/Abbott</documentation> </annotation> </enumeration> <enumeration value="0330007"> <annotation> <documentation>Symetis</documentation> </annotation> </enumeration> <enumeration value="0330008"> <annotation> <documentation>Direct Flow Medical</documentation> </annotation> </enumeration> <enumeration value="0330009"> <annotation> <documentation>Boston Scientific</documentation> </annotation> </enumeration> <enumeration value="0330010"> <annotation> <documentation>nicht belegter Wert</documentation> </annotation> </enumeration> <enumeration value="0330011"> <annotation> </pre>

	<pre> <documentation>nicht belegter Wert</documentation> </annotation> </enumeration> <enumeration value="0330012"> <annotation> <documentation>nicht belegter Wert</documentation> </annotation> </enumeration> <enumeration value="0330013"> <annotation> <documentation>nicht belegter Wert</documentation> </annotation> </enumeration> <enumeration value="0330014"> <annotation> <documentation>nicht belegter Wert</documentation> </annotation> </enumeration> <enumeration value="0330042"> <annotation> <documentation>sonstiger Hersteller</documentation> </annotation> </enumeration> </restriction> </simpleType> </pre>
--	--

simpleType enum_0338

namespace	http://xml.ir-d.de/irdma		
type	restriction of string		
properties	base xs:string		
facets	Kind	Value	Annotation
	enumeration	0338001	documentation LAD
	enumeration	0338002	documentation RCA
	enumeration	0338003	documentation RCX
	enumeration	0338004	documentation Hauptstamm
annotation	documentation Kat_AK_PCIArterien		
source	<pre> <simpleType name="enum_0338"> <annotation> <documentation>Kat_AK_PCIArterien</documentation> </annotation> <restriction base="xs:string"> <enumeration value="0338001"> <annotation> <documentation>LAD</documentation> </annotation> </enumeration> <enumeration value="0338002"> <annotation> <documentation>RCA</documentation> </annotation> </enumeration> </restriction> </simpleType> </pre>		

	<pre> <enumeration value="0338003"> <annotation> <documentation>RCX</documentation> </annotation> </enumeration> <enumeration value="0338004"> <annotation> <documentation>Hauptstamm</documentation> </annotation> </enumeration> </restriction> </simpleType> </pre>
--	--

simpleType enum_0339

namespace	http://xml.ir-d.de/irdma		
type	restriction of string		
properties	base xs:string		
facets	Kind	Value	Annotation
	enumeration	0339001	documentation TEE
	enumeration	0339002	documentation CT
	enumeration	0339042	documentation andere
annotation	documentation Kat_AK_AnnulusMessmethode		
source	<pre> <simpleType name="enum_0339"> <annotation> <documentation>Kat_AK_AnnulusMessmethode</documentation> </annotation> <restriction base="xs:string"> <enumeration value="0339001"> <annotation> <documentation>TEE</documentation> </annotation> </enumeration> <enumeration value="0339002"> <annotation> <documentation>CT</documentation> </annotation> </enumeration> <enumeration value="0339042"> <annotation> <documentation>andere</documentation> </annotation> </enumeration> </restriction> </simpleType> </pre>		

simpleType enum_0341

namespace	http://xml.ir-d.de/irdma
type	restriction of string

properties	base xs:string																		
facets	<table border="1"> <thead> <tr> <th>Kind</th> <th>Value</th> <th>Annotation</th> </tr> </thead> <tbody> <tr> <td>enumeration</td> <td>0341001</td> <td>documentation intraprozedural verstorben</td> </tr> <tr> <td>enumeration</td> <td>0341002</td> <td>documentation Implantation von mehr als einer Prothese</td> </tr> <tr> <td>enumeration</td> <td>0341003</td> <td>documentation gravierende Gefäß- oder Zugangskomplikation (gemäß VARC-3)</td> </tr> <tr> <td>enumeration</td> <td>0341004</td> <td>documentation erforderlicher chirurgischer oder interventioneller Eingriff wegen einer Klappenfehlfunktion (gemäß VARC-3)</td> </tr> <tr> <td>enumeration</td> <td>0341005</td> <td>documentation &gt;= große strukturelle kardiale Komplikation (gemäß VARC-3)</td> </tr> </tbody> </table>	Kind	Value	Annotation	enumeration	0341001	documentation intraprozedural verstorben	enumeration	0341002	documentation Implantation von mehr als einer Prothese	enumeration	0341003	documentation gravierende Gefäß- oder Zugangskomplikation (gemäß VARC-3)	enumeration	0341004	documentation erforderlicher chirurgischer oder interventioneller Eingriff wegen einer Klappenfehlfunktion (gemäß VARC-3)	enumeration	0341005	documentation >= große strukturelle kardiale Komplikation (gemäß VARC-3)
Kind	Value	Annotation																	
enumeration	0341001	documentation intraprozedural verstorben																	
enumeration	0341002	documentation Implantation von mehr als einer Prothese																	
enumeration	0341003	documentation gravierende Gefäß- oder Zugangskomplikation (gemäß VARC-3)																	
enumeration	0341004	documentation erforderlicher chirurgischer oder interventioneller Eingriff wegen einer Klappenfehlfunktion (gemäß VARC-3)																	
enumeration	0341005	documentation >= große strukturelle kardiale Komplikation (gemäß VARC-3)																	
annotation	documentation Kat_AK_FailureGrund																		
source	<pre> <simpleType name="enum_0341"> <annotation> <documentation>Kat_AK_FailureGrund</documentation> </annotation> <restriction base="xs:string"> <enumeration value="0341001"> <annotation> <documentation>intraprozedural verstorben</documentation> </annotation> </enumeration> <enumeration value="0341002"> <annotation> <documentation>Implantation von mehr als einer Prothese</documentation> </annotation> </enumeration> <enumeration value="0341003"> <annotation> <documentation>gravierende Gefäß- oder Zugangskomplikation (gemäß VARC-3)</documentation> </annotation> </enumeration> <enumeration value="0341004"> <annotation> <documentation>erforderlicher chirurgischer oder interventioneller Eingriff wegen einer Klappenfehlfunktion (gemäß VARC-3)</documentation> </annotation> </enumeration> <enumeration value="0341005"> <annotation> <documentation>&gt;= große strukturelle kardiale Komplikation (gemäß VARC-3)</documentation> </annotation> </enumeration> </restriction> </simpleType> </pre>																		

simpleType enum_0342

namespace	http://xml.ir-d.de/irdma
type	restriction of string
properties	base xs:string

facets	<table border="1"> <thead> <tr> <th>Kind</th> <th>Value</th> <th>Annotation</th> </tr> </thead> <tbody> <tr> <td>enumeration</td> <td>0342001</td> <td>documentation Alter</td> </tr> <tr> <td>enumeration</td> <td>0342002</td> <td>documentation Frailty</td> </tr> <tr> <td>enumeration</td> <td>0342003</td> <td>documentation Hochrisiko</td> </tr> <tr> <td>enumeration</td> <td>0342004</td> <td>documentation Prognose-limitierende Zweiterkrankung</td> </tr> <tr> <td>enumeration</td> <td>0342005</td> <td>documentation Porzellan-Aorta</td> </tr> <tr> <td>enumeration</td> <td>0342042</td> <td>documentation Sonstige</td> </tr> </tbody> </table>	Kind	Value	Annotation	enumeration	0342001	documentation Alter	enumeration	0342002	documentation Frailty	enumeration	0342003	documentation Hochrisiko	enumeration	0342004	documentation Prognose-limitierende Zweiterkrankung	enumeration	0342005	documentation Porzellan-Aorta	enumeration	0342042	documentation Sonstige
Kind	Value	Annotation																				
enumeration	0342001	documentation Alter																				
enumeration	0342002	documentation Frailty																				
enumeration	0342003	documentation Hochrisiko																				
enumeration	0342004	documentation Prognose-limitierende Zweiterkrankung																				
enumeration	0342005	documentation Porzellan-Aorta																				
enumeration	0342042	documentation Sonstige																				
annotation	documentation Kat_AK_Tavi																					
source	<pre> <simpleType name="enum_0342"> <annotation> <documentation>Kat_AK_Tavi</documentation> </annotation> <restriction base="xs:string"> <enumeration value="0342001"> <annotation> <documentation>Alter</documentation> </annotation> </enumeration> <enumeration value="0342002"> <annotation> <documentation>Frailty</documentation> </annotation> </enumeration> <enumeration value="0342003"> <annotation> <documentation>Hochrisiko</documentation> </annotation> </enumeration> <enumeration value="0342004"> <annotation> <documentation>Prognose-limitierende Zweiterkrankung</documentation> </annotation> </enumeration> <enumeration value="0342005"> <annotation> <documentation>Porzellan-Aorta</documentation> </annotation> </enumeration> <enumeration value="0342042"> <annotation> <documentation>Sonstige</documentation> </annotation> </enumeration> </restriction> </simpleType> </pre>																					

simpleType enum_0343

namespace	http://xml.ir-d.de/irdma
type	restriction of string

properties	base xs:string																																																									
facets	<table border="1"> <thead> <tr> <th>Kind</th> <th>Value</th> <th>Annotation</th> </tr> </thead> <tbody> <tr> <td>enumeration</td> <td>0343001</td> <td>documentation Device-Fehlpositionierung</td> </tr> <tr> <td>enumeration</td> <td>0343002</td> <td>documentation Koronarostienverschluss</td> </tr> <tr> <td>enumeration</td> <td>0343003</td> <td>documentation Aortendissektion</td> </tr> <tr> <td>enumeration</td> <td>0343004</td> <td>documentation Aortenregurgitation &gt; = 2. Grades</td> </tr> <tr> <td>enumeration</td> <td>0343005</td> <td>documentation Annulus-Ruptur</td> </tr> <tr> <td>enumeration</td> <td>0343006</td> <td>documentation Ruptur-/Perforation einer Herzhöhle ohne Therapiebedarf</td> </tr> <tr> <td>enumeration</td> <td>0343007</td> <td>documentation Ruptur-/Perforation einer Herzhöhle mit Therapiebedarf</td> </tr> <tr> <td>enumeration</td> <td>0343008</td> <td>documentation Perikardtamponade</td> </tr> <tr> <td>enumeration</td> <td>0343009</td> <td>documentation kardiale Dekompensation</td> </tr> <tr> <td>enumeration</td> <td>0343010</td> <td>documentation Himembolie</td> </tr> <tr> <td>enumeration</td> <td>0343011</td> <td>documentation Rhythmusstörungen</td> </tr> <tr> <td>enumeration</td> <td>0343012</td> <td>documentation Device-Embolisation</td> </tr> <tr> <td>enumeration</td> <td>0343013</td> <td>documentation vaskuläre Komplikation</td> </tr> <tr> <td>enumeration</td> <td>0343014</td> <td>documentation Low Cardiac Output</td> </tr> <tr> <td>enumeration</td> <td>0343015</td> <td>documentation schwerwiegende Blutungen (intraprozedural)</td> </tr> <tr> <td>enumeration</td> <td>0343016</td> <td>documentation lebensbedrohliche Blutungen (intraprozedural)</td> </tr> <tr> <td>enumeration</td> <td>0343017</td> <td>documentation Patient verstarb im OP/Katheterlabor</td> </tr> <tr> <td>enumeration</td> <td>0343042</td> <td>documentation sonstige intraprozedurale Komplikationen</td> </tr> </tbody> </table>	Kind	Value	Annotation	enumeration	0343001	documentation Device-Fehlpositionierung	enumeration	0343002	documentation Koronarostienverschluss	enumeration	0343003	documentation Aortendissektion	enumeration	0343004	documentation Aortenregurgitation > = 2. Grades	enumeration	0343005	documentation Annulus-Ruptur	enumeration	0343006	documentation Ruptur-/Perforation einer Herzhöhle ohne Therapiebedarf	enumeration	0343007	documentation Ruptur-/Perforation einer Herzhöhle mit Therapiebedarf	enumeration	0343008	documentation Perikardtamponade	enumeration	0343009	documentation kardiale Dekompensation	enumeration	0343010	documentation Himembolie	enumeration	0343011	documentation Rhythmusstörungen	enumeration	0343012	documentation Device-Embolisation	enumeration	0343013	documentation vaskuläre Komplikation	enumeration	0343014	documentation Low Cardiac Output	enumeration	0343015	documentation schwerwiegende Blutungen (intraprozedural)	enumeration	0343016	documentation lebensbedrohliche Blutungen (intraprozedural)	enumeration	0343017	documentation Patient verstarb im OP/Katheterlabor	enumeration	0343042	documentation sonstige intraprozedurale Komplikationen
Kind	Value	Annotation																																																								
enumeration	0343001	documentation Device-Fehlpositionierung																																																								
enumeration	0343002	documentation Koronarostienverschluss																																																								
enumeration	0343003	documentation Aortendissektion																																																								
enumeration	0343004	documentation Aortenregurgitation > = 2. Grades																																																								
enumeration	0343005	documentation Annulus-Ruptur																																																								
enumeration	0343006	documentation Ruptur-/Perforation einer Herzhöhle ohne Therapiebedarf																																																								
enumeration	0343007	documentation Ruptur-/Perforation einer Herzhöhle mit Therapiebedarf																																																								
enumeration	0343008	documentation Perikardtamponade																																																								
enumeration	0343009	documentation kardiale Dekompensation																																																								
enumeration	0343010	documentation Himembolie																																																								
enumeration	0343011	documentation Rhythmusstörungen																																																								
enumeration	0343012	documentation Device-Embolisation																																																								
enumeration	0343013	documentation vaskuläre Komplikation																																																								
enumeration	0343014	documentation Low Cardiac Output																																																								
enumeration	0343015	documentation schwerwiegende Blutungen (intraprozedural)																																																								
enumeration	0343016	documentation lebensbedrohliche Blutungen (intraprozedural)																																																								
enumeration	0343017	documentation Patient verstarb im OP/Katheterlabor																																																								
enumeration	0343042	documentation sonstige intraprozedurale Komplikationen																																																								
annotation	documentation Kat_AK_KomplikationTyp																																																									
source	<pre> <simpleType name="enum_0343"> <annotation> <documentation>Kat_AK_KomplikationTyp</documentation> </annotation> <restriction base="xs:string"> <enumeration value="0343001"> <annotation> <documentation>Device-Fehlpositionierung</documentation> </annotation> </enumeration> <enumeration value="0343002"> <annotation> <documentation>Koronarostienverschluss</documentation> </annotation> </enumeration> <enumeration value="0343003"> <annotation> <documentation>Aortendissektion</documentation> </annotation> </enumeration> <enumeration value="0343004"> <annotation> </pre>																																																									

```

    <documentation>Aortenregurgitation &gt; = 2. Grades</documentation>
  </annotation>
</enumeration>
<enumeration value="0343005">
  <annotation>
    <documentation>Annulus-Ruptur</documentation>
  </annotation>
</enumeration>
<enumeration value="0343006">
  <annotation>
    <documentation>Ruptur-/Perforation einer Herzhöhle ohne
Therapiebedarf</documentation>
  </annotation>
</enumeration>
<enumeration value="0343007">
  <annotation>
    <documentation>Ruptur-/Perforation einer Herzhöhle mit
Therapiebedarf</documentation>
  </annotation>
</enumeration>
<enumeration value="0343008">
  <annotation>
    <documentation>Perikardtamponade</documentation>
  </annotation>
</enumeration>
<enumeration value="0343009">
  <annotation>
    <documentation>kardiale Dekompensation</documentation>
  </annotation>
</enumeration>
<enumeration value="0343010">
  <annotation>
    <documentation>Hirnembolie</documentation>
  </annotation>
</enumeration>
<enumeration value="0343011">
  <annotation>
    <documentation>Rhythmusstörungen</documentation>
  </annotation>
</enumeration>
<enumeration value="0343012">
  <annotation>
    <documentation>Device-Embolisation</documentation>
  </annotation>
</enumeration>
<enumeration value="0343013">
  <annotation>
    <documentation>vaskuläre Komplikation</documentation>
  </annotation>
</enumeration>
<enumeration value="0343014">
  <annotation>
    <documentation>Low Cardiac Output</documentation>
  </annotation>
</enumeration>
<enumeration value="0343015">
  <annotation>
    <documentation>schwerwiegende Blutungen
(intraprozedural)</documentation>

```

	<pre> </annotation> </enumeration> <enumeration value="0343016"> <annotation> <documentation>lebensbedrohliche Blutungen (intraprozedural)</documentation> </annotation> </enumeration> <enumeration value="0343017"> <annotation> <documentation>Patient verstarb im OP/Katheterlabor</documentation> </annotation> </enumeration> <enumeration value="0343042"> <annotation> <documentation>sonstige intraprozedurale Komplikationen</documentation> </annotation> </enumeration> </restriction> </simpleType> </pre>
--	---

simpleType enum 0346

namespace	http://xml.ir-d.de/irdma		
type	restriction of string		
properties	base xs:string		
facets	Kind	Value	Annotation
	enumeration	0346001	documentation keine Therapie erforderlich
	enumeration	0346002	documentation medikamentös
	enumeration	0346003	documentation IABP
	enumeration	0346004	documentation VAD
	enumeration	0346005	documentation ECMO
	enumeration	0346042	documentation sonstige
annotation	documentation Kat_AK_TherapieLCO		
source	<pre> <simpleType name="enum_0346"> <annotation> <documentation>Kat_AK_TherapieLCO</documentation> </annotation> <restriction base="xs:string"> <enumeration value="0346001"> <annotation> <documentation>keine Therapie erforderlich</documentation> </annotation> </enumeration> <enumeration value="0346002"> <annotation> <documentation>medikamentös</documentation> </annotation> </enumeration> </pre>		

	<pre> <enumeration value="0346003"> <annotation> <documentation>IABP</documentation> </annotation> </enumeration> <enumeration value="0346004"> <annotation> <documentation>VAD</documentation> </annotation> </enumeration> <enumeration value="0346005"> <annotation> <documentation>ECMO</documentation> </annotation> </enumeration> <enumeration value="0346042"> <annotation> <documentation>sonstige</documentation> </annotation> </enumeration> </restriction> </simpleType> </pre>
--	--

simpleType enum_0347

namespace	http://xml.ir-d.de/irdma		
type	restriction of string		
properties	base xs:string		
facets	Kind	Value	Annotation
	enumeration	0347001	documentation Einzeleingriff
	enumeration	0347002	documentation Kombinationseingriff mit mehreren Prozeduren
annotation	documentation Kat_AK_Eingriffsumfang		
source	<pre> <simpleType name="enum_0347"> <annotation> <documentation>Kat_AK_Eingriffsumfang</documentation> </annotation> <restriction base="xs:string"> <enumeration value="0347001"> <annotation> <documentation>Einzeleingriff</documentation> </annotation> </enumeration> <enumeration value="0347002"> <annotation> <documentation>Kombinationseingriff mit mehreren Prozeduren</documentation> </annotation> </enumeration> </restriction> </simpleType> </pre>		

simpleType enum_0348

namespace	http://xml.ir-d.de/irdma		
type	restriction of string		
properties	base xs:string		
facets	Kind	Value	Annotation
	enumeration	0348001	documentation mit HLM
	enumeration	0348002	documentation ohne HLM
	enumeration	0348003	documentation Umstieg von OP ohne HLM auf OP mit HLM
annotation	documentation Kat_AK_OPVorgehen		
source	<pre> <simpleType name="enum_0348"> <annotation> <documentation>Kat_AK_OPVorgehen</documentation> </annotation> <restriction base="xs:string"> <enumeration value="0348001"> <annotation> <documentation>mit HLM</documentation> </annotation> </enumeration> <enumeration value="0348002"> <annotation> <documentation>ohne HLM</documentation> </annotation> </enumeration> <enumeration value="0348003"> <annotation> <documentation>Umstieg von OP ohne HLM auf OP mit HLM</documentation> </annotation> </enumeration> </restriction> </simpleType> </pre>		

simpleType enum_0350

namespace	http://xml.ir-d.de/irdma		
type	restriction of string		
properties	base xs:string		
facets	Kind	Value	Annotation
	enumeration	0350001	documentation IABP
	enumeration	0350002	documentation Impella
	enumeration	0350003	documentation vv ECMO
	enumeration	0350004	documentation va ECMO
	enumeration	0350042	documentation andere
annotation	documentation Kat_AK_Methode		
source	<pre> <simpleType name="enum_0350"> <annotation> </pre>		

```

<documentation>Kat_AK_Methode</documentation>
</annotation>
<restriction base="xs:string">
  <enumeration value="0350001">
    <annotation>
      <documentation>IABP</documentation>
    </annotation>
  </enumeration>
  <enumeration value="0350002">
    <annotation>
      <documentation>Impella</documentation>
    </annotation>
  </enumeration>
  <enumeration value="0350003">
    <annotation>
      <documentation>vv ECMO</documentation>
    </annotation>
  </enumeration>
  <enumeration value="0350004">
    <annotation>
      <documentation>va ECMO</documentation>
    </annotation>
  </enumeration>
  <enumeration value="0350042">
    <annotation>
      <documentation>andere</documentation>
    </annotation>
  </enumeration>
</restriction>
</simpleType>

```

simpleType enum_0351

namespace	http://xml.ir-d.de/irdma		
type	restriction of string		
properties	base xs:string		
facets	Kind	Value	Annotation
	enumeration	0351001	documentation nein
	enumeration	0351002	documentation ja, zu Stenotomie
	enumeration	0351003	documentation ja, zu transapikal
	enumeration	0351004	documentation ja, zu transaortal
	enumeration	0351005	documentation ja, zu transfemoral
	enumeration	0351006	documentation ja, zu transaxillär
	enumeration	0351007	documentation ja, zu anderem endovaskulären Zugang
	enumeration	0351042	documentation ja, zu anderem Zugang
annotation	documentation Kat_AK_Konversion		
source	<pre> <simpleType name="enum_0351"> <annotation> <documentation>Kat AK Konversion</documentation> </pre>		

```

</annotation>
<restriction base="xs:string">
  <enumeration value="0351001">
    <annotation>
      <documentation>nein</documentation>
    </annotation>
  </enumeration>
  <enumeration value="0351002">
    <annotation>
      <documentation>ja, zu Sternotomie</documentation>
    </annotation>
  </enumeration>
  <enumeration value="0351003">
    <annotation>
      <documentation>ja, zu transapikal</documentation>
    </annotation>
  </enumeration>
  <enumeration value="0351004">
    <annotation>
      <documentation>ja, zu transaortal</documentation>
    </annotation>
  </enumeration>
  <enumeration value="0351005">
    <annotation>
      <documentation>ja, zu transfemoral</documentation>
    </annotation>
  </enumeration>
  <enumeration value="0351006">
    <annotation>
      <documentation>ja, zu transaxillär</documentation>
    </annotation>
  </enumeration>
  <enumeration value="0351007">
    <annotation>
      <documentation>ja, zu anderem endovaskulären Zugang</documentation>
    </annotation>
  </enumeration>
  <enumeration value="0351042">
    <annotation>
      <documentation>ja, zu anderem Zugang</documentation>
    </annotation>
  </enumeration>
</restriction>
</simpleType>

```

simpleType enum_0352

namespace	http://xml.ir-d.de/irdma		
type	restriction of string		
properties	base xs:string		
facets	Kind	Value	Annotation
	enumeration	0352001	documentation nein
	enumeration	0352002	documentation ja, Intubationsnarkose
	enumeration	0352003	documentation ja, Maskenbeatmung, incl. LAMA

	enumeration 0352042 documentation ja, unbekannt welche
annotation	documentation Kat_AK_Anaesthesie
source	<pre> <simpleType name="enum_0352"> <annotation> <documentation>Kat_AK_Anaesthesie</documentation> </annotation> <restriction base="xs:string"> <enumeration value="0352001"> <annotation> <documentation>nein</documentation> </annotation> </enumeration> <enumeration value="0352002"> <annotation> <documentation>ja, Intubationsnarkose</documentation> </annotation> </enumeration> <enumeration value="0352003"> <annotation> <documentation>ja, Maskenbeatmung, incl. LAMA</documentation> </annotation> </enumeration> <enumeration value="0352042"> <annotation> <documentation>ja, unbekannt welche</documentation> </annotation> </enumeration> </restriction> </simpleType> </pre>

simpleType enum_0353

namespace	http://xml.ir-d.de/irdma		
type	restriction of string		
properties	base xs:string		
facets	Kind	Value	Annotation
	enumeration	0353001	documentation keine
	enumeration	0353002	documentation leichtgradig
	enumeration	0353003	documentation mittelgradig
	enumeration	0353004	documentation hochgradig
	enumeration	0353099	documentation nicht bestimmbar
annotation	documentation Kat_AK_ResidualeAorteninsuffizienz		
source	<pre> <simpleType name="enum_0353"> <annotation> <documentation>Kat_AK_ResidualeAorteninsuffizienz</documentation> </annotation> <restriction base="xs:string"> <enumeration value="0353001"> <annotation> </pre>		

	<pre> <documentation>keine</documentation> </annotation> </enumeration> <enumeration value="0353002"> <annotation> <documentation>leichtgradig</documentation> </annotation> </enumeration> <enumeration value="0353003"> <annotation> <documentation>mittelgradig</documentation> </annotation> </enumeration> <enumeration value="0353004"> <annotation> <documentation>hochgradig</documentation> </annotation> </enumeration> <enumeration value="0353099"> <annotation> <documentation>nicht bestimmbar</documentation> </annotation> </enumeration> </restriction> </simpleType> </pre>
--	---

simpleType enum_0354

namespace	http://xml.ir-d.de/irdma		
type	restriction of string		
properties	base xs:string		
facets	Kind	Value	Annotation
	enumeration	0354001	documentation chirurgisch-offen
	enumeration	0354002	documentation Verschluss-System
	enumeration	0354042	documentation sonstige
annotation	documentation Kat AK Zugangswegverschluss		
source	<pre> <simpleType name="enum_0354"> <annotation> <documentation>Kat_AK_Zugangswegverschluss</documentation> </annotation> <restriction base="xs:string"> <enumeration value="0354001"> <annotation> <documentation>chirurgisch-offen</documentation> </annotation> </enumeration> <enumeration value="0354002"> <annotation> <documentation>Verschluss-System</documentation> </annotation> </enumeration> <enumeration value="0354042"> <annotation> </pre>		

	<pre> <documentation>sonstige</documentation> </annotation> </enumeration> </restriction> </simpleType> </pre>
--	--

simpleType enum_0357

namespace	http://xml.ir-d.de/irdma		
type	restriction of string		
properties	base xs:string		
facets	Kind	Value	Annotation
	enumeration	0357001	documentation keine KHK
	enumeration	0357002	documentation 1-Gefäßerkrankung
	enumeration	0357003	documentation 2-Gefäßerkrankung
	enumeration	0357004	documentation 3-Gefäßerkrankung
	enumeration	0357005	documentation keine koronare Bildgebung
annotation	documentation Kat_AK_BefundBildgebung		
source	<pre> <simpleType name="enum_0357"> <annotation> <documentation>Kat_AK_BefundBildgebung</documentation> </annotation> <restriction base="xs:string"> <enumeration value="0357001"> <annotation> <documentation>keine KHK</documentation> </annotation> </enumeration> <enumeration value="0357002"> <annotation> <documentation>1-Gefäßerkrankung</documentation> </annotation> </enumeration> <enumeration value="0357003"> <annotation> <documentation>2-Gefäßerkrankung</documentation> </annotation> </enumeration> <enumeration value="0357004"> <annotation> <documentation>3-Gefäßerkrankung</documentation> </annotation> </enumeration> <enumeration value="0357005"> <annotation> <documentation>keine koronare Bildgebung</documentation> </annotation> </enumeration> </restriction> </simpleType> </pre>		

simpleType enum_0358

namespace	http://xml.ir-d.de/irdma		
type	restriction of string		
properties	base xs:string		
facets	Kind	Value	Annotation
	enumeration	0358001	documentation 0
	enumeration	0358002	documentation 1
	enumeration	0358003	documentation 2
	enumeration	0358004	documentation 3
	enumeration	0358005	documentation 4
	enumeration	0358006	documentation 5 oder mehr
	enumeration	0358098	documentation genaue Anzahl unbekannt (aber mind. 1)
	enumeration	0358099	documentation unbekannt
annotation	documentation Kat_AK_AnzahlVorOP		
source	<pre> <simpleType name="enum_0358"> <annotation> <documentation>Kat_AK_AnzahlVorOP</documentation> </annotation> <restriction base="xs:string"> <enumeration value="0358001"> <annotation> <documentation>0</documentation> </annotation> </enumeration> <enumeration value="0358002"> <annotation> <documentation>1</documentation> </annotation> </enumeration> <enumeration value="0358003"> <annotation> <documentation>2</documentation> </annotation> </enumeration> <enumeration value="0358004"> <annotation> <documentation>3</documentation> </annotation> </enumeration> <enumeration value="0358005"> <annotation> <documentation>4</documentation> </annotation> </enumeration> <enumeration value="0358006"> <annotation> <documentation>5 oder mehr</documentation> </annotation> </enumeration> </restriction> </simpleType> </pre>		

	<pre> </enumeration> <enumeration value="0358098"> <annotation> <documentation>genaue Anzahl unbekannt (aber mind. 1)</documentation> </annotation> </enumeration> <enumeration value="0358099"> <annotation> <documentation>unbekannt</documentation> </annotation> </enumeration> </restriction> </simpleType> </pre>
--	---

simpleType enum_0359

namespace	http://xml.ir-d.de/irdma		
type	restriction of string		
properties	base xs:string		
facets	Kind	Value	Annotation
	enumeration	0359001	documentation nein
	enumeration	0359002	documentation ja - einseitig
	enumeration	0359003	documentation ja - beidseitig
	enumeration	0359042	documentation unbekannt
annotation	documentation Kat_AK_LVOT		
source	<pre> <simpleType name="enum_0359"> <annotation> <documentation>Kat_AK_LVOT</documentation> </annotation> <restriction base="xs:string"> <enumeration value="0359001"> <annotation> <documentation>nein</documentation> </annotation> </enumeration> <enumeration value="0359002"> <annotation> <documentation>ja - einseitig</documentation> </annotation> </enumeration> <enumeration value="0359003"> <annotation> <documentation>ja - beidseitig</documentation> </annotation> </enumeration> <enumeration value="0359042"> <annotation> <documentation>unbekannt</documentation> </annotation> </enumeration> </restriction> </simpleType> </pre>		

simpleType enum 0360

namespace	http://xml.ir-d.de/irdma		
type	restriction of string		
properties	base xs:string		
facets	Kind	Value	Annotation
	enumeration	0360001	documentation keine
	enumeration	0360002	documentation leichtgradig
	enumeration	0360003	documentation mittelgradig
	enumeration	0360004	documentation hochgradig
	enumeration	0360005	documentation massive
	enumeration	0360006	documentation torrential
	enumeration	0360099	documentation unbekannt
annotation	documentation Kat_AK_TriskupidalInsuffizienz		
source	<pre> <simpleType name="enum_0360"> <annotation> <documentation>Kat_AK_TriskupidalInsuffizienz</documentation> </annotation> <restriction base="xs:string"> <enumeration value="0360001"> <annotation> <documentation>keine</documentation> </annotation> </enumeration> <enumeration value="0360002"> <annotation> <documentation>leichtgradig</documentation> </annotation> </enumeration> <enumeration value="0360003"> <annotation> <documentation>mittelgradig</documentation> </annotation> </enumeration> <enumeration value="0360004"> <annotation> <documentation>hochgradig</documentation> </annotation> </enumeration> <enumeration value="0360005"> <annotation> <documentation>massive</documentation> </annotation> </enumeration> <enumeration value="0360006"> <annotation> <documentation>torrential</documentation> </annotation> </enumeration> </restriction> </simpleType> </pre>		

	<pre> <enumeration value="0360099"> <annotation> <documentation>unbekannt</documentation> </annotation> </enumeration> </restriction> </simpleType> </pre>
--	--

simpleType enum_0361

namespace	http://xml.ir-d.de/irdma		
type	restriction of string		
properties	base xs:string		
facets	Kind	Value	Annotation
	enumeration	0361001	documentation nein
	enumeration	0361002	documentation ja, letzte(r) innerhalb der letzten 48 Stunden
	enumeration	0361003	documentation ja, letzte(r) innerhalb der letzten 21 Tage
	enumeration	0361004	documentation ja, letzte(r) länger als 21 Tage
	enumeration	0361098	documentation ja, letzter Zeitpunkt unbekannt
	enumeration	0361099	documentation unbekannt
annotation	documentation Kat AK SchockReanimation		
source	<pre> <simpleType name="enum_0361"> <annotation> <documentation>Kat_AK_SchockReanimation</documentation> </annotation> <restriction base="xs:string"> <enumeration value="0361001"> <annotation> <documentation>nein</documentation> </annotation> </enumeration> <enumeration value="0361002"> <annotation> <documentation>ja, letzte(r) innerhalb der letzten 48 Stunden</documentation> </annotation> </enumeration> <enumeration value="0361003"> <annotation> <documentation>ja, letzte(r) innerhalb der letzten 21 Tage</documentation> </annotation> </enumeration> <enumeration value="0361004"> <annotation> <documentation>ja, letzte(r) länger als 21 Tage</documentation> </annotation> </enumeration> <enumeration value="0361098"> <annotation> </pre>		

	<pre> <documentation>ja, letzter Zeitpunkt unbekannt</documentation> </annotation> </enumeration> <enumeration value="0361099"> <annotation> <documentation>unbekannt</documentation> </annotation> </enumeration> </restriction> </simpleType> </pre>
--	--

simpleType enum_0362

namespace	http://xml.ir-d.de/irdma		
type	restriction of string		
properties	base xs:string		
facets	Kind	Value	Annotation
	enumeration	0362001	documentation Sinusrhythmus
	enumeration	0362002	documentation Vorhofflimmern
	enumeration	0362042	documentation anderer Herzrhythmus
annotation	documentation Kat_AK_Herzrhythmus		
source	<pre> <simpleType name="enum_0362"> <annotation> <documentation>Kat_AK_Herzrhythmus</documentation> </annotation> <restriction base="xs:string"> <enumeration value="0362001"> <annotation> <documentation>Sinusrhythmus</documentation> </annotation> </enumeration> <enumeration value="0362002"> <annotation> <documentation>Vorhofflimmern</documentation> </annotation> </enumeration> <enumeration value="0362042"> <annotation> <documentation>anderer Herzrhythmus</documentation> </annotation> </enumeration> </restriction> </simpleType> </pre>		

simpleType enum_0363

namespace	http://xml.ir-d.de/irdma		
type	restriction of string		
properties	base xs:string		

facets	<table border="1"> <thead> <tr> <th>Kind</th> <th>Value</th> <th>Annotation</th> </tr> </thead> <tbody> <tr> <td>enumeration</td> <td>0363001</td> <td>documentation nein</td> </tr> <tr> <td>enumeration</td> <td>0363002</td> <td>documentation paroxysmal</td> </tr> <tr> <td>enumeration</td> <td>0363003</td> <td>documentation persistierend</td> </tr> <tr> <td>enumeration</td> <td>0363004</td> <td>documentation permanent</td> </tr> </tbody> </table>	Kind	Value	Annotation	enumeration	0363001	documentation nein	enumeration	0363002	documentation paroxysmal	enumeration	0363003	documentation persistierend	enumeration	0363004	documentation permanent
Kind	Value	Annotation														
enumeration	0363001	documentation nein														
enumeration	0363002	documentation paroxysmal														
enumeration	0363003	documentation persistierend														
enumeration	0363004	documentation permanent														
annotation	documentation Kat_AK_Vorhofflimmern															
source	<pre> <simpleType name="enum_0363"> <annotation> <documentation>Kat_AK_Vorhofflimmern</documentation> </annotation> <restriction base="xs:string"> <enumeration value="0363001"> <annotation> <documentation>nein</documentation> </annotation> </enumeration> <enumeration value="0363002"> <annotation> <documentation>paroxysmal</documentation> </annotation> </enumeration> <enumeration value="0363003"> <annotation> <documentation>persistierend</documentation> </annotation> </enumeration> <enumeration value="0363004"> <annotation> <documentation>permanent</documentation> </annotation> </enumeration> </restriction> </simpleType> </pre>															

simpleType **enum_0364**

namespace	http://xml.ir-d.de/irdma																		
type	restriction of string																		
properties	base xs:string																		
facets	<table border="1"> <thead> <tr> <th>Kind</th> <th>Value</th> <th>Annotation</th> </tr> </thead> <tbody> <tr> <td>enumeration</td> <td>0364001</td> <td>documentation nein</td> </tr> <tr> <td>enumeration</td> <td>0364002</td> <td>documentation Schrittmacher ohne CRT-System</td> </tr> <tr> <td>enumeration</td> <td>0364003</td> <td>documentation Schrittmacher mit CRT-System</td> </tr> <tr> <td>enumeration</td> <td>0364004</td> <td>documentation Defibrillator ohne CRT-System</td> </tr> <tr> <td>enumeration</td> <td>0364005</td> <td>documentation Defibrillator mit CRT-System</td> </tr> </tbody> </table>	Kind	Value	Annotation	enumeration	0364001	documentation nein	enumeration	0364002	documentation Schrittmacher ohne CRT-System	enumeration	0364003	documentation Schrittmacher mit CRT-System	enumeration	0364004	documentation Defibrillator ohne CRT-System	enumeration	0364005	documentation Defibrillator mit CRT-System
Kind	Value	Annotation																	
enumeration	0364001	documentation nein																	
enumeration	0364002	documentation Schrittmacher ohne CRT-System																	
enumeration	0364003	documentation Schrittmacher mit CRT-System																	
enumeration	0364004	documentation Defibrillator ohne CRT-System																	
enumeration	0364005	documentation Defibrillator mit CRT-System																	
annotation	documentation Kat_AK_SchrittmacherDefi																		

source	<pre> <simpleType name="enum_0364"> <annotation> <documentation>Kat_AK_SchrittmacherDefi</documentation> </annotation> <restriction base="xs:string"> <enumeration value="0364001"> <annotation> <documentation>nein</documentation> </annotation> </enumeration> <enumeration value="0364002"> <annotation> <documentation>Schrittmacher ohne CRT-System</documentation> </annotation> </enumeration> <enumeration value="0364003"> <annotation> <documentation>Schrittmacher mit CRT-System</documentation> </annotation> </enumeration> <enumeration value="0364004"> <annotation> <documentation>Defibrillator ohne CRT-System</documentation> </annotation> </enumeration> <enumeration value="0364005"> <annotation> <documentation>Defibrillator mit CRT-System</documentation> </annotation> </enumeration> </restriction> </simpleType> </pre>
--------	---

simpleType enum_0365

namespace	http://xml.ir-d.de/irdma		
type	restriction of string		
properties	base xs:string		
facets	Kind	Value	Annotation
	enumeration	0365001	documentation nein
	enumeration	0365002	documentation ja, operativ
	enumeration	0365003	documentation ja, interventionell
annotation	documentation Kat_AK_MyokardRevaskularisation		
source	<pre> <simpleType name="enum_0365"> <annotation> <documentation>Kat_AK_MyokardRevaskularisation</documentation> </annotation> <restriction base="xs:string"> <enumeration value="0365001"> <annotation> <documentation>nein</documentation> </annotation> </enumeration> </restriction> </simpleType> </pre>		

	<pre> </enumeration> <enumeration value="0365002"> <annotation> <documentation>ja, operativ</documentation> </annotation> </enumeration> <enumeration value="0365003"> <annotation> <documentation>ja, interventionell</documentation> </annotation> </enumeration> </restriction> </simpleType> </pre>
--	---

simpleType enum_0366

namespace	http://xml.ir-d.de/irdma		
type	restriction of string		
properties	base xs:string		
facets	Kind	Value	Annotation
	enumeration	0366001	documentation nein
	enumeration	0366002	documentation ja, <= 6 Stunden
	enumeration	0366003	documentation ja, > 6 Stunden bis <= 3 Monate
	enumeration	0366004	documentation ja, > 3 Monate
	enumeration	0366099	documentation unbekannt
annotation	documentation Kat_AK_PCI		
source	<pre> <simpleType name="enum_0366"> <annotation> <documentation>Kat_AK_PCI</documentation> </annotation> <restriction base="xs:string"> <enumeration value="0366001"> <annotation> <documentation>nein</documentation> </annotation> </enumeration> <enumeration value="0366002"> <annotation> <documentation>ja, &lt;= 6 Stunden</documentation> </annotation> </enumeration> <enumeration value="0366003"> <annotation> <documentation>ja, &gt; 6 Stunden bis &lt;= 3 Monate</documentation> </annotation> </enumeration> <enumeration value="0366004"> <annotation> <documentation>ja, &gt; 3 Monate</documentation> </annotation> </enumeration> </restriction> </simpleType> </pre>		

	<pre> <enumeration value="0366099"> <annotation> <documentation>unbekannt</documentation> </annotation> </enumeration> </restriction> </simpleType> </pre>
--	--

simpleType **enum_0367**

namespace	http://xml.ir-d.de/irdma		
type	restriction of string		
properties	base xs:string		
facets	Kind	Value	Annotation
	enumeration	0367001	documentation keine
	enumeration	0367002	documentation Mediastinitis
	enumeration	0367003	documentation Sepsis
	enumeration	0367004	documentation broncho-pulmonale Infektion
	enumeration	0367005	documentation oto-laryngologische Infektion
	enumeration	0367006	documentation floride Endokarditis
	enumeration	0367007	documentation Peritonitis
	enumeration	0367008	documentation Wundinfektion Thorax
	enumeration	0367009	documentation Pleuraempyem
	enumeration	0367010	documentation Venenkatheterinfektion
	enumeration	0367011	documentation Harnwegsinfektion
	enumeration	0367012	documentation Wundinfektion untere Extremitäten
	enumeration	0367013	documentation HIV-Infektion
	enumeration	0367014	documentation Hepatitis B oder C
	enumeration	0367015	documentation andere Wundinfektion
	enumeration	0367042	documentation sonstige Infektion
annotation	documentation Kat_AK_Infektion		
source	<pre> <simpleType name="enum_0367"> <annotation> <documentation>Kat_AK_Infektion</documentation> </annotation> <restriction base="xs:string"> <enumeration value="0367001"> <annotation> <documentation>keine</documentation> </annotation> </enumeration> <enumeration value="0367002"> </pre>		

```
<annotation>
  <documentation>Mediastinitis</documentation>
</annotation>
</enumeration>
<enumeration value="0367003">
  <annotation>
    <documentation>Sepsis</documentation>
  </annotation>
</enumeration>
<enumeration value="0367004">
  <annotation>
    <documentation>broncho-pulmonale Infektion</documentation>
  </annotation>
</enumeration>
<enumeration value="0367005">
  <annotation>
    <documentation>oto-laryngologische Infektion</documentation>
  </annotation>
</enumeration>
<enumeration value="0367006">
  <annotation>
    <documentation>floride Endokarditis</documentation>
  </annotation>
</enumeration>
<enumeration value="0367007">
  <annotation>
    <documentation>Peritonitis</documentation>
  </annotation>
</enumeration>
<enumeration value="0367008">
  <annotation>
    <documentation>Wundinfektion Thorax</documentation>
  </annotation>
</enumeration>
<enumeration value="0367009">
  <annotation>
    <documentation>Pleuraempyem</documentation>
  </annotation>
</enumeration>
<enumeration value="0367010">
  <annotation>
    <documentation>Venenkatheterinfektion</documentation>
  </annotation>
</enumeration>
<enumeration value="0367011">
  <annotation>
    <documentation>Harnwegsinfektion</documentation>
  </annotation>
</enumeration>
<enumeration value="0367012">
  <annotation>
    <documentation>Wundinfektion untere Extremitäten</documentation>
  </annotation>
</enumeration>
<enumeration value="0367013">
  <annotation>
    <documentation>HIV-Infektion</documentation>
  </annotation>
</enumeration>
```

	<pre> <enumeration value="0367014"> <annotation> <documentation>Hepatitis B oder C</documentation> </annotation> </enumeration> <enumeration value="0367015"> <annotation> <documentation>andere Wundinfektion</documentation> </annotation> </enumeration> <enumeration value="0367042"> <annotation> <documentation>sonstige Infektion</documentation> </annotation> </enumeration> </restriction> </simpleType> </pre>
--	---

simpleType enum 0368

namespace	http://xml.ir-d.de/irdma		
type	restriction of string		
properties	base xs:string		
facets	Kind	Value	Annotation
	enumeration	0368001	documentation nein
	enumeration	0368002	documentation ja, COPD mit Dauermedikation
	enumeration	0368003	documentation ja, COPD ohne Dauermedikation
	enumeration	0368004	documentation ja, andere Lungenerkrankungen
	enumeration	0368099	documentation unbekannt
annotation	documentation Kat_AK_Lungenerkrankung		
source	<pre> <simpleType name="enum_0368"> <annotation> <documentation>Kat_AK_Lungenerkrankung</documentation> </annotation> <restriction base="xs:string"> <enumeration value="0368001"> <annotation> <documentation>nein</documentation> </annotation> </enumeration> <enumeration value="0368002"> <annotation> <documentation>ja, COPD mit Dauermedikation</documentation> </annotation> </enumeration> <enumeration value="0368003"> <annotation> <documentation>ja, COPD ohne Dauermedikation</documentation> </annotation> </enumeration> <enumeration value="0368004"> </pre>		

	<pre> <annotation> <documentation>ja, andere Lungenerkrankungen</documentation> </annotation> </enumeration> <enumeration value="0368099"> <annotation> <documentation>unbekannt</documentation> </annotation> </enumeration> </restriction> </simpleType> </pre>
--	---

simpleType enum_0369

namespace	http://xml.ir-d.de/irdma		
type	restriction of string		
properties	base xs:string		
facets	Kind	Value	Annotation
	enumeration	0369001	documentation nein
	enumeration	0369002	documentation akut
	enumeration	0369003	documentation chronisch
annotation	documentation Kat_AK_Nierenersatztherapie		
source	<pre> <simpleType name="enum_0369"> <annotation> <documentation>Kat_AK_Nierenersatztherapie</documentation> </annotation> <restriction base="xs:string"> <enumeration value="0369001"> <annotation> <documentation>nein</documentation> </annotation> </enumeration> <enumeration value="0369002"> <annotation> <documentation>akut</documentation> </annotation> </enumeration> <enumeration value="0369003"> <annotation> <documentation>chronisch</documentation> </annotation> </enumeration> </restriction> </simpleType> </pre>		

simpleType enum_0370

namespace	http://xml.ir-d.de/irdma		
type	restriction of string		
properties	base xs:string		

facets	<table border="1"> <thead> <tr> <th>Kind</th> <th>Value</th> <th>Annotation</th> </tr> </thead> <tbody> <tr> <td>enumeration</td> <td>0370001</td> <td>documentation Echokardiographie</td> </tr> <tr> <td>enumeration</td> <td>0370002</td> <td>documentation Herzkatheter</td> </tr> <tr> <td>enumeration</td> <td>0370042</td> <td>documentation andere</td> </tr> </tbody> </table>	Kind	Value	Annotation	enumeration	0370001	documentation Echokardiographie	enumeration	0370002	documentation Herzkatheter	enumeration	0370042	documentation andere
Kind	Value	Annotation											
enumeration	0370001	documentation Echokardiographie											
enumeration	0370002	documentation Herzkatheter											
enumeration	0370042	documentation andere											
annotation	documentation Kat_AK_AKOEFMessmethode												
source	<pre> <simpleType name="enum_0370"> <annotation> <documentation>Kat_AK_AKOEFMessmethode</documentation> </annotation> <restriction base="xs:string"> <enumeration value="0370001"> <annotation> <documentation>Echokardiographie</documentation> </annotation> </enumeration> <enumeration value="0370002"> <annotation> <documentation>Herzkatheter</documentation> </annotation> </enumeration> <enumeration value="0370042"> <annotation> <documentation>andere</documentation> </annotation> </enumeration> </restriction> </simpleType> </pre>												

simpleType enum_0371

namespace	http://xml.ir-d.de/irdma																		
type	restriction of string																		
properties	base xs:string																		
facets	<table border="1"> <thead> <tr> <th>Kind</th> <th>Value</th> <th>Annotation</th> </tr> </thead> <tbody> <tr> <td>enumeration</td> <td>0371001</td> <td>documentation keine</td> </tr> <tr> <td>enumeration</td> <td>0371002</td> <td>documentation leicht</td> </tr> <tr> <td>enumeration</td> <td>0371003</td> <td>documentation mittel</td> </tr> <tr> <td>enumeration</td> <td>0371004</td> <td>documentation schwer</td> </tr> <tr> <td>enumeration</td> <td>0371099</td> <td>documentation unbekannt</td> </tr> </tbody> </table>	Kind	Value	Annotation	enumeration	0371001	documentation keine	enumeration	0371002	documentation leicht	enumeration	0371003	documentation mittel	enumeration	0371004	documentation schwer	enumeration	0371099	documentation unbekannt
Kind	Value	Annotation																	
enumeration	0371001	documentation keine																	
enumeration	0371002	documentation leicht																	
enumeration	0371003	documentation mittel																	
enumeration	0371004	documentation schwer																	
enumeration	0371099	documentation unbekannt																	
annotation	documentation Kat_AK_Verkalkungsgrad																		
source	<pre> <simpleType name="enum_0371"> <annotation> <documentation>Kat_AK_Verkalkungsgrad</documentation> </annotation> <restriction base="xs:string"> <enumeration value="0371001"> <annotation> <documentation>keine</documentation> </annotation> </enumeration> </restriction> </simpleType> </pre>																		

	<pre> </annotation> </enumeration> <enumeration value="0371002"> <annotation> <documentation>leicht</documentation> </annotation> </enumeration> <enumeration value="0371003"> <annotation> <documentation>mittel</documentation> </annotation> </enumeration> <enumeration value="0371004"> <annotation> <documentation>schwer</documentation> </annotation> </enumeration> <enumeration value="0371099"> <annotation> <documentation>unbekannt</documentation> </annotation> </enumeration> </restriction> </simpleType> </pre>
--	---

simpleType enum_0372

namespace	http://xml.ir-d.de/irdma		
type	restriction of string		
properties	base xs:string		
facets	Kind	Value	Annotation
	enumeration	0372001	documentation nein
	enumeration	0372002	documentation ja, bicuspide
	enumeration	0372003	documentation ja, unicuspide
	enumeration	0372099	documentation unbekannt
annotation	documentation Kat_AK_BiUnicuspideKlappe		
source	<pre> <simpleType name="enum_0372"> <annotation> <documentation>Kat_AK_BiUnicuspideKlappe</documentation> </annotation> <restriction base="xs:string"> <enumeration value="0372001"> <annotation> <documentation>nein</documentation> </annotation> </enumeration> <enumeration value="0372002"> <annotation> <documentation>ja, bicuspide</documentation> </annotation> </enumeration> <enumeration value="0372003"> </pre>		

	<pre> <annotation> <documentation>ja, unicuspide</documentation> </annotation> </enumeration> <enumeration value="0372099"> <annotation> <documentation>unbekannt</documentation> </annotation> </enumeration> </restriction> </simpleType> </pre>
--	--

simpleType enum_0373

namespace	http://xml.ir-d.de/irdma		
type	restriction of string		
properties	base xs:string		
facets	Kind	Value	Annotation
	enumeration	0373001	documentation keine
	enumeration	0373002	documentation leichtgradig
	enumeration	0373003	documentation mittelgradig
	enumeration	0373004	documentation hochgradig
	enumeration	0373099	documentation unbekannt
annotation	documentation Kat_AK_Grad		
source	<pre> <simpleType name="enum_0373"> <annotation> <documentation>Kat_AK_Grad</documentation> </annotation> <restriction base="xs:string"> <enumeration value="0373001"> <annotation> <documentation>keine</documentation> </annotation> </enumeration> <enumeration value="0373002"> <annotation> <documentation>leichtgradig</documentation> </annotation> </enumeration> <enumeration value="0373003"> <annotation> <documentation>mittelgradig</documentation> </annotation> </enumeration> <enumeration value="0373004"> <annotation> <documentation>hochgradig</documentation> </annotation> </enumeration> <enumeration value="0373099"> <annotation> </pre>		

	<pre> <documentation>unbekannt</documentation> </annotation> </enumeration> </restriction> </simpleType> </pre>
--	---

simpleType enum_0374

namespace	http://xml.ir-d.de/irdma		
type	restriction of string		
properties	base xs:string		
facets	Kind	Value	Annotation
	enumeration	0374001	documentation nein
	enumeration	0374002	documentation ja, <= 6 Stunden
	enumeration	0374003	documentation ja, > 6 Stunden bis <= 24 Stunden
	enumeration	0374004	documentation ja, > 1 bis 7 Tage
	enumeration	0374005	documentation ja, > 7 bis 21 Tage
	enumeration	0374006	documentation ja, > 21 Tage
annotation	documentation Kat_AK_InfarktAnamnese		
source	<pre> <simpleType name="enum_0374"> <annotation> <documentation>Kat_AK_InfarktAnamnese</documentation> </annotation> <restriction base="xs:string"> <enumeration value="0374001"> <annotation> <documentation>nein</documentation> </annotation> </enumeration> <enumeration value="0374002"> <annotation> <documentation>ja, &lt;= 6 Stunden</documentation> </annotation> </enumeration> <enumeration value="0374003"> <annotation> <documentation>ja, &gt; 6 Stunden bis &lt;= 24 Stunden</documentation> </annotation> </enumeration> <enumeration value="0374004"> <annotation> <documentation>ja, &gt; 1 bis 7 Tage</documentation> </annotation> </enumeration> <enumeration value="0374005"> <annotation> <documentation>ja, &gt; 7 bis 21 Tage</documentation> </annotation> </enumeration> <enumeration value="0374006"> </pre>		

	<pre> <annotation> <documentation>ja, &gt; 21 Tage</documentation> </annotation> </enumeration> </restriction> </simpleType> </pre>
--	---

simpleType enum_0375

namespace	http://xml.ir-d.de/irdma		
type	restriction of string		
properties	base xs:string		
facets	Kind	Value	Annotation
	enumeration	0375001	documentation keine Symptome oder Angina
	enumeration	0375002	documentation Symptome, aber keine Ischämiezeichen
	enumeration	0375003	documentation stabile Angina
	enumeration	0375004	documentation instabile Angina
	enumeration	0375005	documentation Infarkt ohne ST-Hebung (Non-STEMI)
	enumeration	0375006	documentation Infarkt mit ST-Hebung (STEMI)
	enumeration	0375042	documentation unbekannt
annotation	documentation Kat_AK_KardialeSymptome		
source	<pre> <simpleType name="enum_0375"> <annotation> <documentation>Kat_AK_KardialeSymptome</documentation> </annotation> <restriction base="xs:string"> <enumeration value="0375001"> <annotation> <documentation>keine Symptome oder Angina</documentation> </annotation> </enumeration> <enumeration value="0375002"> <annotation> <documentation>Symptome, aber keine Ischämiezeichen</documentation> </annotation> </enumeration> <enumeration value="0375003"> <annotation> <documentation>stabile Angina</documentation> </annotation> </enumeration> <enumeration value="0375004"> <annotation> <documentation>instabile Angina</documentation> </annotation> </enumeration> <enumeration value="0375005"> <annotation> <documentation>Infarkt ohne ST-Hebung (Non-STEMI)</documentation> </pre>		

	<pre> </annotation> </enumeration> <enumeration value="0375006"> <annotation> <documentation>Infarkt mit ST-Hebung (STEMI)</documentation> </annotation> </enumeration> <enumeration value="0375042"> <annotation> <documentation>unbekannt</documentation> </annotation> </enumeration> </restriction> </simpleType> </pre>
--	--

simpleType enum_0376

namespace	http://xml.lir-d.de/irdma		
type	restriction of string		
properties	base xs:string		
facets	Kind	Value	Annotation
	enumeration	0376001	documentation nein
	enumeration	0376002	documentation ja, ZNS, zerebrovaskuläre Blutung
	enumeration	0376003	documentation ja, ZNS, zerebrovaskuläre Ischämie
	enumeration	0376042	documentation ja, ZNS, andere
annotation	documentation Kat_AK_Schlaganfall		
source	<pre> <simpleType name="enum_0376"> <annotation> <documentation>Kat_AK_Schlaganfall</documentation> </annotation> <restriction base="xs:string"> <enumeration value="0376001"> <annotation> <documentation>nein</documentation> </annotation> </enumeration> <enumeration value="0376002"> <annotation> <documentation>ja, ZNS, zerebrovaskuläre Blutung</documentation> </annotation> </enumeration> <enumeration value="0376003"> <annotation> <documentation>ja, ZNS, zerebrovaskuläre Ischämie</documentation> </annotation> </enumeration> <enumeration value="0376042"> <annotation> <documentation>ja, ZNS, andere</documentation> </annotation> </enumeration> </restriction> </pre>		

	<code></simpleType></code>
--	----------------------------------

simpleType enum_0377

namespace	http://xml.ir-d.de/irdma		
type	restriction of string		
properties	base xs:string		
facets	Kind	Value	Annotation
	enumeration	0377001	documentation ja, mild neurological dysfunction: NIHSS 0-5
	enumeration	0377002	documentation ja, moderate neurological dysfunction: NIHSS 6-14
	enumeration	0377003	documentation ja, severe neurological dysfunction: NIHSS >=15
annotation	documentation Kat_AK_Nihss		
source	<pre> <simpleType name="enum_0377"> <annotation> <documentation>Kat_AK_Nihss</documentation> </annotation> <restriction base="xs:string"> <enumeration value="0377001"> <annotation> <documentation>ja, mild neurological dysfunction: NIHSS 0-5</documentation> </annotation> </enumeration> <enumeration value="0377002"> <annotation> <documentation>ja, moderate neurological dysfunction: NIHSS 6-14</documentation> </annotation> </enumeration> <enumeration value="0377003"> <annotation> <documentation> ja, severe neurological dysfunction: NIHSS &gt;=15</documentation> </annotation> </enumeration> </restriction> </simpleType> </pre>		

simpleType enum_0378

namespace	http://xml.ir-d.de/irdma		
type	restriction of string		
properties	base xs:string		
facets	Kind	Value	Annotation
	enumeration	0378001	documentation nein
	enumeration	0378002	documentation ja, < 48h gemäss VARC-3-Definition
	enumeration	0378003	documentation ja, >= 48h - <= 72h gemäß VARC-3-Definition
	enumeration	0378004	documentation

	ja, > 72 h gemäß VARC-3 Definition
annotation	documentation Kat_AK_Myokardinfarkt
source	<pre> <simpleType name="enum_0378"> <annotation> <documentation>Kat_AK_Myokardinfarkt</documentation> </annotation> <restriction base="xs:string"> <enumeration value="0378001"> <annotation> <documentation>nein</documentation> </annotation> </enumeration> <enumeration value="0378002"> <annotation> <documentation>ja, &lt; 48h gemäss VARC-3-Definition</documentation> </annotation> </enumeration> <enumeration value="0378003"> <annotation> <documentation>ja, &gt;= 48h - &lt;= 72h gemäß VARC-3-Definition</documentation> </annotation> </enumeration> <enumeration value="0378004"> <annotation> <documentation>ja, &gt; 72 h gemäß VARC-3 Definition</documentation> </annotation> </enumeration> </restriction> </simpleType> </pre>

simpleType enum_0379

namespace	http://xml.ir-d.de/irdma		
type	restriction of string		
properties	base xs:string		
facets	Kind	Value	Annotation
	enumeration	0379001	documentation Keine gefäss- oder zugangsassozierte Komplikationen
	enumeration	0379002	documentation Versagen des perkutanen Verschlusssystems
	enumeration	0379003	documentation Geringfügige Gefäßkomplikationen
	enumeration	0379004	documentation Erhebliche Gefäßkomplikationen
annotation	documentation Kat_AK_ZugangKomplikationen		
source	<pre> <simpleType name="enum_0379"> <annotation> <documentation>Kat_AK_ZugangKomplikationen</documentation> </annotation> <restriction base="xs:string"> <enumeration value="0379001"> <annotation> <documentation>Keine gefäss- oder zugangsassozierte Komplikationen</documentation> </annotation> </enumeration> </restriction> </simpleType> </pre>		

	<pre> </annotation> </enumeration> <enumeration value="0379002"> <annotation> <documentation>Versagen des perkutanen Verschlussystems</documentation> </annotation> </enumeration> <enumeration value="0379003"> <annotation> <documentation>Geringfügige Gefäßkomplikationen</documentation> </annotation> </enumeration> <enumeration value="0379004"> <annotation> <documentation>Erhebliche Gefäßkomplikationen</documentation> </annotation> </enumeration> </restriction> </simpleType> </pre>
--	--

simpleType enum_0380

namespace	http://xml.ir-d.de/irdma		
type	restriction of string		
properties	base xs:string		
facets	Kind	Value	Annotation
	enumeration	0380001	documentation nein
	enumeration	0380002	documentation ja, intraprozedural
	enumeration	0380003	documentation ja, postprozedural
	enumeration	0380004	documentation ja, Zeitpunkt nicht bekannt
annotation	documentation Kat_AK_Reanimation		
source	<pre> <simpleType name="enum_0380"> <annotation> <documentation>Kat_AK_Reanimation</documentation> </annotation> <restriction base="xs:string"> <enumeration value="0380001"> <annotation> <documentation>nein</documentation> </annotation> </enumeration> <enumeration value="0380002"> <annotation> <documentation>ja, intraprozedural</documentation> </annotation> </enumeration> <enumeration value="0380003"> <annotation> <documentation>ja, postprozedural</documentation> </annotation> </enumeration> </restriction> </simpleType> </pre>		

	<pre> <enumeration value="0380004"> <annotation> <documentation>ja, Zeitpunkt nicht bekannt</documentation> </annotation> </enumeration> </restriction> </simpleType> </pre>
--	--

simpleType enum_0381

namespace	http://xml.ir-d.de/irdma		
type	restriction of string		
properties	base xs:string		
facets	Kind	Value	Annotation
	enumeration	0381001	documentation nein
	enumeration	0381002	documentation Thorakotomie/Rethorakotomie
	enumeration	0381003	documentation kathetergestützte Reintervention
	enumeration	0381004	documentation lokale Reinterventionen
	enumeration	0381005	documentation andere Reintervention
annotation	documentation Kat_AK_Massnahmen		
source	<pre> <simpleType name="enum_0381"> <annotation> <documentation>Kat_AK_Massnahmen</documentation> </annotation> <restriction base="xs:string"> <enumeration value="0381001"> <annotation> <documentation>nein</documentation> </annotation> </enumeration> <enumeration value="0381002"> <annotation> <documentation>Thorakotomie/Rethorakotomie</documentation> </annotation> </enumeration> <enumeration value="0381003"> <annotation> <documentation>kathetergestützte Reintervention</documentation> </annotation> </enumeration> <enumeration value="0381004"> <annotation> <documentation>lokale Reinterventionen</documentation> </annotation> </enumeration> <enumeration value="0381005"> <annotation> <documentation>andere Reintervention</documentation> </annotation> </enumeration> </restriction> </pre>		

	<code></simpleType></code>
--	----------------------------------

simpleType enum_0382

namespace	http://xml.ir-d.de/irdma																																							
type	restriction of string																																							
properties	base xs:string																																							
facets	<table><thead><tr><th>Kind</th><th>Value</th><th>Annotation</th></tr></thead><tbody><tr><td>enumeration</td><td>0382001</td><td>documentation keine Rethorakotomie / kein weiterer Grund</td></tr><tr><td>enumeration</td><td>0382002</td><td>documentation Blutung/Hämatom</td></tr><tr><td>enumeration</td><td>0382003</td><td>documentation Low Cardiac Output</td></tr><tr><td>enumeration</td><td>0382004</td><td>documentation Tamponade</td></tr><tr><td>enumeration</td><td>0382005</td><td>documentation Graftprobleme, Ischämie</td></tr><tr><td>enumeration</td><td>0382006</td><td>documentation Wundinfektion, Mediastinitis</td></tr><tr><td>enumeration</td><td>0382007</td><td>documentation Dissektion</td></tr><tr><td>enumeration</td><td>0382008</td><td>documentation Prothesendysfunktion</td></tr><tr><td>enumeration</td><td>0382009</td><td>documentation instabiles Sternum</td></tr><tr><td>enumeration</td><td>0382010</td><td>documentation Chylothorax</td></tr><tr><td>enumeration</td><td>0382011</td><td>documentation lokale Revision im Bereich des Zugangsweges</td></tr><tr><td>enumeration</td><td>0382042</td><td>documentation anderer Grund</td></tr></tbody></table>	Kind	Value	Annotation	enumeration	0382001	documentation keine Rethorakotomie / kein weiterer Grund	enumeration	0382002	documentation Blutung/Hämatom	enumeration	0382003	documentation Low Cardiac Output	enumeration	0382004	documentation Tamponade	enumeration	0382005	documentation Graftprobleme, Ischämie	enumeration	0382006	documentation Wundinfektion, Mediastinitis	enumeration	0382007	documentation Dissektion	enumeration	0382008	documentation Prothesendysfunktion	enumeration	0382009	documentation instabiles Sternum	enumeration	0382010	documentation Chylothorax	enumeration	0382011	documentation lokale Revision im Bereich des Zugangsweges	enumeration	0382042	documentation anderer Grund
Kind	Value	Annotation																																						
enumeration	0382001	documentation keine Rethorakotomie / kein weiterer Grund																																						
enumeration	0382002	documentation Blutung/Hämatom																																						
enumeration	0382003	documentation Low Cardiac Output																																						
enumeration	0382004	documentation Tamponade																																						
enumeration	0382005	documentation Graftprobleme, Ischämie																																						
enumeration	0382006	documentation Wundinfektion, Mediastinitis																																						
enumeration	0382007	documentation Dissektion																																						
enumeration	0382008	documentation Prothesendysfunktion																																						
enumeration	0382009	documentation instabiles Sternum																																						
enumeration	0382010	documentation Chylothorax																																						
enumeration	0382011	documentation lokale Revision im Bereich des Zugangsweges																																						
enumeration	0382042	documentation anderer Grund																																						
annotation	documentation Kat_AK_Komplikation																																							
source	<pre><simpleType name="enum_0382"> <annotation> <documentation>Kat_AK_Komplikation</documentation> </annotation> <restriction base="xs:string"> <enumeration value="0382001"> <annotation> <documentation>keine Rethorakotomie / kein weiterer Grund</documentation> </annotation> </enumeration> <enumeration value="0382002"> <annotation> <documentation>Blutung/Hämatom</documentation> </annotation> </enumeration> <enumeration value="0382003"> <annotation> <documentation>Low Cardiac Output</documentation> </annotation> </enumeration> <enumeration value="0382004"> <annotation> <documentation>Tamponade</documentation> </annotation> </enumeration> </restriction> </simpleType></pre>																																							

```

</annotation>
</enumeration>
<enumeration value="0382005">
  <annotation>
    <documentation>Graftprobleme, Ischämie</documentation>
  </annotation>
</enumeration>
<enumeration value="0382006">
  <annotation>
    <documentation>Wundinfektion, Mediastinitis</documentation>
  </annotation>
</enumeration>
<enumeration value="0382007">
  <annotation>
    <documentation>Dissektion</documentation>
  </annotation>
</enumeration>
<enumeration value="0382008">
  <annotation>
    <documentation>Prothesendysfunktion</documentation>
  </annotation>
</enumeration>
<enumeration value="0382009">
  <annotation>
    <documentation>instabiles Sternum</documentation>
  </annotation>
</enumeration>
<enumeration value="0382010">
  <annotation>
    <documentation>Chylothorax</documentation>
  </annotation>
</enumeration>
<enumeration value="0382011">
  <annotation>
    <documentation>lokale Revision im Bereich des
Zugangsweges</documentation>
  </annotation>
</enumeration>
<enumeration value="0382042">
  <annotation>
    <documentation>anderer Grund</documentation>
  </annotation>
</enumeration>
</restriction>
</simpleType>

```

simpleType enum_0383

namespace	http://xml.ir-d.de/irdma		
type	restriction of string		
properties	base xs:string		
facets	Kind	Value	Annotation
	enumeration	0383001	documentation nein
	enumeration	0383002	documentation ja, mit forcierter Atemtherapie
	enumeration	0383003	documentation

	enumeration 0383004 ja, Reintubation oder längerfristige Beatmung documentation ja, Tracheotomie
annotation	documentation Kat_AK_RespiratorischeInsuffizienz
source	<pre> <simpleType name="enum_0383"> <annotation> <documentation>Kat_AK_RespiratorischeInsuffizienz</documentation> </annotation> <restriction base="xs:string"> <enumeration value="0383001"> <annotation> <documentation>nein</documentation> </annotation> </enumeration> <enumeration value="0383002"> <annotation> <documentation>ja, mit forcierter Atemtherapie</documentation> </annotation> </enumeration> <enumeration value="0383003"> <annotation> <documentation>ja, Reintubation oder längerfristige Beatmung</documentation> </annotation> </enumeration> <enumeration value="0383004"> <annotation> <documentation>ja, Tracheotomie</documentation> </annotation> </enumeration> </restriction> </simpleType> </pre>

simpleType enum 0384

namespace	http://xml.ir-d.de/irdma		
type	restriction of string		
properties	base xs:string		
facets	Kind	Value	Annotation
	enumeration	0384001	documentation keine Blutungskomplikationen
	enumeration	0384002	documentation Geringfügige Blutung (Minor Bleeding - BARC type 2 or 3a)
	enumeration	0384003	documentation Starke Blutung (Major Bleeding - BARC type 3a)
	enumeration	0384004	documentation Lebensbedrohliche Blutung (Life-threatening or disabling bleeding - BARC type 3b or 3c or type 5)
annotation	documentation Kat_AK_Blutungskomplikation		
source	<pre> <simpleType name="enum_0384"> <annotation> <documentation>Kat_AK_Blutungskomplikation</documentation> </annotation> <restriction base="xs:string"> <enumeration value="0384001"> </pre>		

	<pre> <annotation> <documentation>keine Blutungskomplikationen</documentation> </annotation> </enumeration> <enumeration value="0384002"> <annotation> <documentation>Geringfügige Blutung (Minor Bleeding - BARC type 2 or 3a)</documentation> </annotation> </enumeration> <enumeration value="0384003"> <annotation> <documentation>Starke Blutung (Major Bleeding - BARC type 3a)</documentation> </annotation> </enumeration> <enumeration value="0384004"> <annotation> <documentation>Lebensbedrohliche Blutung (Life-threatening or disabling bleeding - BARC type 3b or 3c or type 5)</documentation> </annotation> </enumeration> </restriction> </simpleType> </pre>
--	---

simpleType enum_0385

namespace	http://xml.ir-d.de/irdma		
type	restriction of string		
properties	base xs:string		
facets	Kind	Value	Annotation
	enumeration	0385001	documentation Sinusrhythmus
	enumeration	0385002	documentation Vorhofflimmern
	enumeration	0385003	documentation Patient verstorben (kein Herzrhythmus)
	enumeration	0385042	documentation anderer Rhythmus
annotation	documentation Kat_AK_HerzrhythmusEntlassung		
source	<pre> <simpleType name="enum_0385"> <annotation> <documentation>Kat_AK_HerzrhythmusEntlassung</documentation> </annotation> <restriction base="xs:string"> <enumeration value="0385001"> <annotation> <documentation>Sinusrhythmus</documentation> </annotation> </enumeration> <enumeration value="0385002"> <annotation> <documentation>Vorhofflimmern</documentation> </annotation> </enumeration> <enumeration value="0385003"> </pre>		

	<pre> <annotation> <documentation>Patient verstorben (kein Herzrhythmus)</documentation> </annotation> </enumeration> <enumeration value="0385042"> <annotation> <documentation>anderer Rhythmus</documentation> </annotation> </enumeration> </restriction> </simpleType> </pre>
--	---

simpleType enum_0388

namespace	http://xml.ir-d.de/irdma		
type	restriction of string		
properties	base xs:string		
facets	Kind	Value	Annotation
	enumeration	0388001	documentation nein
	enumeration	0388002	documentation ASS
	enumeration	0388003	documentation ADP-Rezeptor-Antagonist
	enumeration	0388004	documentation Kombination ASS und ADP-Rezeptor-Antagonist
	enumeration	0388042	documentation ja, andere
	enumeration	0388099	documentation unbekannt
annotation	documentation Kat_AK_Plaettchenaggregationshemmer		
source	<pre> <simpleType name="enum_0388"> <annotation> <documentation>Kat_AK_Plaettchenaggregationshemmer</documentation> </annotation> <restriction base="xs:string"> <enumeration value="0388001"> <annotation> <documentation>nein</documentation> </annotation> </enumeration> <enumeration value="0388002"> <annotation> <documentation>ASS</documentation> </annotation> </enumeration> <enumeration value="0388003"> <annotation> <documentation>ADP-Rezeptor-Antagonist</documentation> </annotation> </enumeration> <enumeration value="0388004"> <annotation> <documentation>Kombination ASS und ADP-Rezeptor-Antagonist</documentation> </annotation> </enumeration> </restriction> </simpleType> </pre>		

	<pre> </enumeration> <enumeration value="0388042"> <annotation> <documentation>ja, andere</documentation> </annotation> </enumeration> <enumeration value="0388099"> <annotation> <documentation>unbekannt</documentation> </annotation> </enumeration> </restriction> </simpleType> </pre>
--	---

simpleType enum_0389

namespace	http://xml.ir-d.de/irdma		
type	restriction of string		
properties	base xs:string		
facets	Kind	Value	Annotation
	enumeration	0389001	documentation nein
	enumeration	0389002	documentation Cumarin-Derivate
	enumeration	0389003	documentation Heparinoide
	enumeration	0389004	documentation orale Thrombinantagonisten
	enumeration	0389005	documentation Kombination Heparinoide und Cumarin-Derivate
	enumeration	0389006	documentation Direkte orale Antikoagulantien (DOAK / NOAK)
	enumeration	0389042	documentation ja, andere
	enumeration	0389099	documentation unbekannt
annotation	documentation Kat_AK_Antikoagulantien		
source	<pre> <simpleType name="enum_0389"> <annotation> <documentation>Kat_AK_Antikoagulantien</documentation> </annotation> <restriction base="xs:string"> <enumeration value="0389001"> <annotation> <documentation>nein</documentation> </annotation> </enumeration> <enumeration value="0389002"> <annotation> <documentation>Cumarin-Derivate</documentation> </annotation> </enumeration> <enumeration value="0389003"> <annotation> <documentation>Heparinoide</documentation> </annotation> </enumeration> </pre>		

	<pre> <enumeration value="0389004"> <annotation> <documentation>orale Thrombinantagonisten</documentation> </annotation> </enumeration> <enumeration value="0389005"> <annotation> <documentation>Kombination Heparinoide und Cumarin-Derivate</documentation> </annotation> </enumeration> <enumeration value="0389006"> <annotation> <documentation>Direkte orale Antikoagulantien (DOAK / NOAK)</documentation> </annotation> </enumeration> <enumeration value="0389042"> <annotation> <documentation>ja, andere</documentation> </annotation> </enumeration> <enumeration value="0389099"> <annotation> <documentation>unbekannt</documentation> </annotation> </enumeration> </restriction> </simpleType> </pre>
--	--

simpleType enum_0390

namespace	http://xml.ir-d.de/irdma		
type	restriction of string		
properties	base xs:string		
facets	Kind	Value	Annotation
	enumeration	0390001	documentation biologisches Klappenmodell
	enumeration	0390002	documentation mechanisches Klappenmodell
annotation	documentation Kat_AK_Artikeltyp		
source	<pre> <simpleType name="enum_0390"> <annotation> <documentation>Kat_AK_Artikeltyp</documentation> </annotation> <restriction base="xs:string"> <enumeration value="0390001"> <annotation> <documentation>biologisches Klappenmodell</documentation> </annotation> </enumeration> <enumeration value="0390002"> <annotation> <documentation>mechanisches Klappenmodell</documentation> </annotation> </enumeration> </restriction> </simpleType> </pre>		

	<pre> </restriction> </simpleType> </pre>
--	---

simpleType enum_0398

namespace	http://xml.ir-d.de/irdma		
type	restriction of string		
properties	base xs:string		
facets	Kind	Value	Annotation
	enumeration	0398001	documentation kardiovaskuläre Ursache
	enumeration	0398002	documentation nicht-kardiovaskuläre Ursache
	enumeration	0398099	documentation Todesursache unbekannt
annotation	documentation Kat_AK_Todesursache		
source	<pre> <simpleType name="enum_0398"> <annotation> <documentation>Kat_AK_Todesursache</documentation> </annotation> <restriction base="xs:string"> <enumeration value="0398001"> <annotation> <documentation>kardiovaskuläre Ursache</documentation> </annotation> </enumeration> <enumeration value="0398002"> <annotation> <documentation>nicht-kardiovaskuläre Ursache</documentation> </annotation> </enumeration> <enumeration value="0398099"> <annotation> <documentation>Todesursache unbekannt</documentation> </annotation> </enumeration> </restriction> </simpleType> </pre>		

simpleType enum_0399

namespace	http://xml.ir-d.de/irdma		
type	restriction of string		
properties	base xs:string		
facets	Kind	Value	Annotation
	enumeration	0399001	documentation Patient lebt
	enumeration	0399002	documentation Patient im Krankenhaus verstorben
annotation	documentation Kat_AK_Vitalstatus		
source	<pre> <simpleType name="enum_0399"> <annotation> </pre>		

	<pre> <documentation>Kat_AK_Vitalstatus</documentation> </annotation> <restriction base="xs:string"> <enumeration value="0399001"> <annotation> <documentation>Patient lebt</documentation> </annotation> </enumeration> <enumeration value="0399002"> <annotation> <documentation>Patient im Krankenhaus verstorben</documentation> </annotation> </enumeration> </restriction> </simpleType> </pre>
--	---

simpleType enum 0044

namespace	http://xml.ir-d.de/irdsa		
type	restriction of string		
properties	base xs:string		
facets	Kind	Value	Annotation
	enumeration	0044001	documentation 1= normaler, sonst gesunder Patient
	enumeration	0044002	documentation 2= Patient mit leichter Allgemeinerkrankung
	enumeration	0044003	documentation 3= Patient mit schwerer Allgemeinerkrankung
	enumeration	0044004	documentation 4= Patient mit schwerer Allgemeinerkrankung, die eine ständige Lebensbedrohung darstellt
	enumeration	0044005	documentation 5= moribunder Patient, der ohne die Operation voraussichtlich nicht überleben wird
annotation	documentation Kat_ASA		
source	<pre> <simpleType name="enum_0044"> <annotation> <documentation>Kat_ASA</documentation> </annotation> <restriction base="xs:string"> <enumeration value="0044001"> <annotation> <documentation>1= normaler, sonst gesunder Patient</documentation> </annotation> </enumeration> <enumeration value="0044002"> <annotation> <documentation>2= Patient mit leichter Allgemeinerkrankung</documentation> </annotation> </enumeration> <enumeration value="0044003"> <annotation> <documentation>3= Patient mit schwerer Allgemeinerkrankung</documentation> </annotation> </enumeration> </pre>		

	<pre> <enumeration value="0044004"> <annotation> <documentation>4= Patient mit schwerer Allgemeinerkrankung, die eine ständige Lebensbedrohung darstellt</documentation> </annotation> </enumeration> <enumeration value="0044005"> <annotation> <documentation>5= moribunder Patient, der ohne die Operation voraussichtlich nicht überleben wird</documentation> </annotation> </enumeration> </restriction> </simpleType> </pre>
--	---

simpleType enum_0050

namespace	http://xml.ir-d.de/irdsa		
type	restriction of string		
properties	base xs:string		
facets	Kind	Value	Annotation
	enumeration	0050001	documentation rechts
	enumeration	0050002	documentation links
annotation	documentation Kat_RechtsLinks		
source	<pre> <simpleType name="enum_0050"> <annotation> <documentation>Kat_RechtsLinks</documentation> </annotation> <restriction base="xs:string"> <enumeration value="0050001"> <annotation> <documentation>rechts</documentation> </annotation> </enumeration> <enumeration value="0050002"> <annotation> <documentation>links</documentation> </annotation> </enumeration> </restriction> </simpleType> </pre>		

simpleType enum_0060

namespace	http://xml.ir-d.de/irdsa		
type	restriction of string		
properties	base xs:string		
facets	Kind	Value	Annotation
	enumeration	0060001	documentation ja
	enumeration	0060002	documentation

	nein
annotation	documentation Kat JaNein
source	<pre> <simpleType name="enum_0060"> <annotation> <documentation>Kat_JaNein</documentation> </annotation> <restriction base="xs:string"> <enumeration value="0060001"> <annotation> <documentation>ja</documentation> </annotation> </enumeration> <enumeration value="0060002"> <annotation> <documentation>nein</documentation> </annotation> </enumeration> </restriction> </simpleType> </pre>

simpleType enum_0061

namespace	http://xml.ir-d.de/irdsa		
type	restriction of string		
properties	base xs:string		
facets	Kind	Value	Annotation
	enumeration	0061001	documentation ja
	enumeration	0061002	documentation nein
	enumeration	0061099	documentation unbekannt
annotation	documentation Kat_JaNeinUnbekannt		
source	<pre> <simpleType name="enum_0061"> <annotation> <documentation>Kat_JaNeinUnbekannt</documentation> </annotation> <restriction base="xs:string"> <enumeration value="0061001"> <annotation> <documentation>ja</documentation> </annotation> </enumeration> <enumeration value="0061002"> <annotation> <documentation>nein</documentation> </annotation> </enumeration> <enumeration value="0061099"> <annotation> <documentation>unbekannt</documentation> </annotation> </enumeration> </restriction> </pre>		

	<code></simpleType></code>
--	----------------------------------

simpleType enum_0062

namespace	http://xml.ir-d.de/irdsa																																				
type	restriction of string																																				
properties	base xs:string																																				
facets	<table><thead><tr><th>Kind</th><th>Value</th><th>Annotation</th></tr></thead><tbody><tr><td>enumeration</td><td>0062001</td><td>documentation Stück</td></tr><tr><td>enumeration</td><td>0062002</td><td>documentation g</td></tr><tr><td>enumeration</td><td>0062003</td><td>documentation mg</td></tr><tr><td>enumeration</td><td>0062004</td><td>documentation l</td></tr><tr><td>enumeration</td><td>0062005</td><td>documentation ml</td></tr><tr><td>enumeration</td><td>0062006</td><td>documentation cm³</td></tr><tr><td>enumeration</td><td>0062007</td><td>documentation mm</td></tr><tr><td>enumeration</td><td>0062008</td><td>documentation cm</td></tr><tr><td>enumeration</td><td>0062009</td><td>documentation dm</td></tr><tr><td>enumeration</td><td>0062010</td><td>documentation m</td></tr><tr><td>enumeration</td><td>0062042</td><td>documentation andere</td></tr></tbody></table>	Kind	Value	Annotation	enumeration	0062001	documentation Stück	enumeration	0062002	documentation g	enumeration	0062003	documentation mg	enumeration	0062004	documentation l	enumeration	0062005	documentation ml	enumeration	0062006	documentation cm ³	enumeration	0062007	documentation mm	enumeration	0062008	documentation cm	enumeration	0062009	documentation dm	enumeration	0062010	documentation m	enumeration	0062042	documentation andere
Kind	Value	Annotation																																			
enumeration	0062001	documentation Stück																																			
enumeration	0062002	documentation g																																			
enumeration	0062003	documentation mg																																			
enumeration	0062004	documentation l																																			
enumeration	0062005	documentation ml																																			
enumeration	0062006	documentation cm ³																																			
enumeration	0062007	documentation mm																																			
enumeration	0062008	documentation cm																																			
enumeration	0062009	documentation dm																																			
enumeration	0062010	documentation m																																			
enumeration	0062042	documentation andere																																			
annotation	documentation Kat_Einheit																																				
source	<pre><simpleType name="enum_0062"> <annotation> <documentation>Kat_Einheit</documentation> </annotation> <restriction base="xs:string"> <enumeration value="0062001"> <annotation> <documentation>Stück</documentation> </annotation> </enumeration> <enumeration value="0062002"> <annotation> <documentation>g</documentation> </annotation> </enumeration> <enumeration value="0062003"> <annotation> <documentation>mg</documentation> </annotation> </enumeration> <enumeration value="0062004"> <annotation> <documentation>l</documentation> </annotation> </enumeration> <enumeration value="0062005"></pre>																																				

```

    <annotation>
      <documentation>ml</documentation>
    </annotation>
  </enumeration>
  <enumeration value="0062006">
    <annotation>
      <documentation>cm3</documentation>
    </annotation>
  </enumeration>
  <enumeration value="0062007">
    <annotation>
      <documentation>mm</documentation>
    </annotation>
  </enumeration>
  <enumeration value="0062008">
    <annotation>
      <documentation>cm</documentation>
    </annotation>
  </enumeration>
  <enumeration value="0062009">
    <annotation>
      <documentation>dm</documentation>
    </annotation>
  </enumeration>
  <enumeration value="0062010">
    <annotation>
      <documentation>m</documentation>
    </annotation>
  </enumeration>
  <enumeration value="0062042">
    <annotation>
      <documentation>andere</documentation>
    </annotation>
  </enumeration>
</restriction>
</simpleType>

```

simpleType enum_0065

namespace	http://xml.ir-d.de/irdsa		
type	restriction of string		
properties	base xs:string		
facets	Kind	Value	Annotation
	enumeration	0065001	documentation stationär
	enumeration	0065002	documentation teilstationär
	enumeration	0065003	documentation ambulant
annotation	documentation Kat_ArtAufenthalt		
source	<pre> <simpleType name="enum_0065"> <annotation> <documentation>Kat_ArtAufenthalt</documentation> </annotation> <restriction base="xs:string"> <enumeration value="0065001"> </pre>		

	<pre> <annotation> <documentation>stationär</documentation> </annotation> </enumeration> <enumeration value="0065002"> <annotation> <documentation>teilstationär</documentation> </annotation> </enumeration> <enumeration value="0065003"> <annotation> <documentation>ambulant</documentation> </annotation> </enumeration> </restriction> </simpleType> </pre>
--	---

simpleType enum_0067

namespace	http://xml.ir-d.de/irdsa		
type	restriction of string		
properties	base xs:string		
facets	Kind	Value	Annotation
	enumeration	0067001	documentation Implantat
	enumeration	0067002	documentation Explantat
annotation	documentation Kat_ArtArtikel		
source	<pre> <simpleType name="enum_0067"> <annotation> <documentation>Kat_ArtArtikel</documentation> </annotation> <restriction base="xs:string"> <enumeration value="0067001"> <annotation> <documentation>Implantat</documentation> </annotation> </enumeration> <enumeration value="0067002"> <annotation> <documentation>Explantat</documentation> </annotation> </enumeration> </restriction> </simpleType> </pre>		

simpleType enum_0068

namespace	http://xml.ir-d.de/irdsa		
type	restriction of string		
properties	base xs:string		
facets	Kind	Value	Annotation
	enumeration	0068001	documentation

	enumeration 0068002 UDI documentation Referenz (REF) enumeration 0068003 documentation Katalognummer enumeration 0068042 documentation sonstiger
annotation	documentation Kat_KennzeichenTyp
source	<pre> <simpleType name="enum_0068"> <annotation> <documentation>Kat_KennzeichenTyp</documentation> </annotation> <restriction base="xs:string"> <enumeration value="0068001"> <annotation> <documentation>UDI</documentation> </annotation> </enumeration> <enumeration value="0068002"> <annotation> <documentation>Referenz (REF)</documentation> </annotation> </enumeration> <enumeration value="0068003"> <annotation> <documentation>Katalognummer</documentation> </annotation> </enumeration> <enumeration value="0068042"> <annotation> <documentation>sonstiger</documentation> </annotation> </enumeration> </restriction> </simpleType> </pre>

simpleType enum 0069

namespace	http://xml.ir-d.de/irdsa		
type	restriction of string		
properties	base xs:string		
facets	Kind	Value	Annotation
	enumeration	0069001	documentation Implantat
	enumeration	0069002	documentation Explantat
annotation	documentation Kat_ArtZubehoer		
source	<pre> <simpleType name="enum_0069"> <annotation> <documentation>Kat_ArtZubehoer</documentation> </annotation> <restriction base="xs:string"> <enumeration value="0069001"> <annotation> <documentation>Implantat</documentation> </annotation> </enumeration> </restriction> </simpleType> </pre>		

	<pre> </annotation> </enumeration> <enumeration value="0069002"> <annotation> <documentation>Explantat</documentation> </annotation> </enumeration> </restriction> </simpleType> </pre>
--	---

simpleType enum_0070

namespace	http://xml.ir-d.de/irdsa		
type	restriction of string		
properties	base xs:string		
facets	Kind	Value	Annotation
	enumeration	0070001	documentation weiblich
	enumeration	0070002	documentation männlich
	enumeration	0070003	documentation divers
	enumeration	0070042	documentation unbestimmt
annotation	documentation Kat_Geschlecht		
source	<pre> <simpleType name="enum_0070"> <annotation> <documentation>Kat_Geschlecht</documentation> </annotation> <restriction base="xs:string"> <enumeration value="0070001"> <annotation> <documentation>weiblich</documentation> </annotation> </enumeration> <enumeration value="0070002"> <annotation> <documentation>männlich</documentation> </annotation> </enumeration> <enumeration value="0070003"> <annotation> <documentation>divers</documentation> </annotation> </enumeration> <enumeration value="0070042"> <annotation> <documentation>unbestimmt</documentation> </annotation> </enumeration> </restriction> </simpleType> </pre>		

simpleType enum_0071

namespace	http://xml.ir-d.de/irdsa		
type	restriction of string		
properties	base xs:string		
facets	Kind	Value	Annotation
	enumeration	0071001	documentation Implantat
	enumeration	0071002	documentation Explantat
	enumeration	0071003	documentation Degeneriertes/defektes Produkt, das funktionslos im Körper verbleibt
annotation	documentation Kat_ArtikelArtFunktion		
source	<pre> <simpleType name="enum_0071"> <annotation> <documentation>Kat_ArtikelArtFunktion</documentation> </annotation> <restriction base="xs:string"> <enumeration value="0071001"> <annotation> <documentation>Implantat</documentation> </annotation> </enumeration> <enumeration value="0071002"> <annotation> <documentation>Explantat</documentation> </annotation> </enumeration> <enumeration value="0071003"> <annotation> <documentation>Degeneriertes/defektes Produkt, das funktionslos im Körper verbleibt</documentation> </annotation> </enumeration> </restriction> </simpleType> </pre>		

simpleType enum_0075

namespace	http://xml.ir-d.de/irdsa		
type	restriction of string		
properties	base xs:string		
facets	Kind	Value	Annotation
	enumeration	0075001	documentation elektiv
	enumeration	0075002	documentation dringlich
	enumeration	0075003	documentation Notfall
annotation	documentation Kat_Dringlichkeit		
source	<pre> <simpleType name="enum_0075"> <annotation> <documentation>Kat_Dringlichkeit</documentation> </annotation> </pre>		

	<pre> <restriction base="xs:string"> <enumeration value="0075001"> <annotation> <documentation>elektiv</documentation> </annotation> </enumeration> <enumeration value="0075002"> <annotation> <documentation>dringlich</documentation> </annotation> </enumeration> <enumeration value="0075003"> <annotation> <documentation>Notfall</documentation> </annotation> </enumeration> </restriction> </simpleType> </pre>
--	---

simpleType **enum_0076**

namespace	http://xml.ir-d.de/irdsa		
type	restriction of string		
properties	base xs:string		
facets	Kind	Value	Annotation
	enumeration	0076001	documentation elektiv
	enumeration	0076002	documentation dringlich
	enumeration	0076003	documentation Notfall
	enumeration	0076004	documentation Notfall (Reanimation / ultima ratio)
annotation	documentation Kat_Dringlichkeit_Reanimation		
source	<pre> <simpleType name="enum_0076"> <annotation> <documentation>Kat_Dringlichkeit_Reanimation</documentation> </annotation> <restriction base="xs:string"> <enumeration value="0076001"> <annotation> <documentation>elektiv</documentation> </annotation> </enumeration> <enumeration value="0076002"> <annotation> <documentation>dringlich</documentation> </annotation> </enumeration> <enumeration value="0076003"> <annotation> <documentation>Notfall</documentation> </annotation> </enumeration> <enumeration value="0076004"> <annotation> </pre>		

	<pre> <documentation>Notfall (Reanimation / ultima ratio)</documentation> </annotation> </enumeration> </restriction> </simpleType> </pre>
--	--

simpleType enum_0080

namespace	http://xml.ir-d.de/irdsa		
type	restriction of string		
properties	base xs:string		
facets	Kind	Value	Annotation
	enumeration	0080001	documentation Endoprothese Hüfte/Knie
	enumeration	0080002	documentation Brustimplantat
	enumeration	0080003	documentation Aortenklappenprothese
annotation	documentation Kat_Implantattyp		
source	<pre> <simpleType name="enum_0080"> <annotation> <documentation>Kat_Implantattyp</documentation> </annotation> <restriction base="xs:string"> <enumeration value="0080001"> <annotation> <documentation>Endoprothese Hüfte/Knie</documentation> </annotation> </enumeration> <enumeration value="0080002"> <annotation> <documentation>Brustimplantat</documentation> </annotation> </enumeration> <enumeration value="0080003"> <annotation> <documentation>Aortenklappenprothese</documentation> </annotation> </enumeration> </restriction> </simpleType> </pre>		

simpleType enum_0100

namespace	http://xml.ir-d.de/irdsa		
type	restriction of string		
properties	base xs:string		
facets	Kind	Value	Annotation
	enumeration	0100001	documentation Primäreingriff
	enumeration	0100002	documentation Austausch Expander gegen dauerhaftes Brustimplantat
	enumeration	0100003	documentation Revision

	enumeration 0100004 documentation Nur Explantation
annotation	documentation Kat_BI_ArtEingriff
source	<pre> <simpleType name="enum_0100"> <annotation> <documentation>Kat_BI_ArtEingriff</documentation> </annotation> <restriction base="xs:string"> <enumeration value="0100001"> <annotation> <documentation>Primäreingriff</documentation> </annotation> </enumeration> <enumeration value="0100002"> <annotation> <documentation>Austausch Expander gegen dauerhaftes Brustimplantat</documentation> </annotation> </enumeration> <enumeration value="0100003"> <annotation> <documentation>Revision</documentation> </annotation> </enumeration> <enumeration value="0100004"> <annotation> <documentation>Nur Explantation</documentation> </annotation> </enumeration> </restriction> </simpleType> </pre>

simpleType enum_0102

namespace	http://xml.ir-d.de/irdsa		
type	restriction of string		
properties	base xs:string		
facets	Kind	Value	Annotation
	enumeration	0102001	documentation kosmetische Augmentation
	enumeration	0102002	documentation Rekonstruktion, benigne
	enumeration	0102003	documentation Rekonstruktion nach Mastektomie aufgrund eines Karzinoms
	enumeration	0102004	documentation Rekonstruktion nach risikoreduzierender Mastektomie
annotation	documentation Kat_BI_GrundPrimaereingriff		
source	<pre> <simpleType name="enum_0102"> <annotation> <documentation>Kat_BI_GrundPrimaereingriff</documentation> </annotation> <restriction base="xs:string"> <enumeration value="0102001"> <annotation> <documentation>kosmetische Augmentation</documentation> </pre>		

	<pre> </annotation> </enumeration> <enumeration value="0102002"> <annotation> <documentation>Rekonstruktion, benigne</documentation> </annotation> </enumeration> <enumeration value="0102003"> <annotation> <documentation>Rekonstruktion nach Mastektomie aufgrund eines Karzinoms</documentation> </annotation> </enumeration> <enumeration value="0102004"> <annotation> <documentation>Rekonstruktion nach risikoreduzierender Mastektomie</documentation> </annotation> </enumeration> </restriction> </simpleType> </pre>
--	--

simpleType enum_0103

namespace	http://xml.ir-d.de/irdsa		
type	restriction of string		
properties	base xs:string		
facets	Kind	Value	Annotation
	enumeration	0103001	documentation simultane Lappendeckung
	enumeration	0103002	documentation simultane Eigenfetttransplantation
	enumeration	0103003	documentation simultane Mastopexie
	enumeration	0103005	documentation simultane Mastektomie, Ablatio / hautsparend
	enumeration	0103006	documentation simultane Mastektomie, nippelerhaltend
	enumeration	0103007	documentation Axilla-Dissektion
	enumeration	0103008	documentation Drainage
annotation	documentation Kat_BI_OperationsdetailPrimaereingriff		
source	<pre> <simpleType name="enum_0103"> <annotation> <documentation>Kat_BI_OperationsdetailPrimaereingriff</documentation> </annotation> <restriction base="xs:string"> <enumeration value="0103001"> <annotation> <documentation>simultane Lappendeckung</documentation> </annotation> </enumeration> <enumeration value="0103002"> <annotation> <documentation>simultane Eigenfetttransplantation</documentation> </pre>		

	<pre> </annotation> </enumeration> <enumeration value="0103003"> <annotation> <documentation>simultane Mastopexie</documentation> </annotation> </enumeration> <enumeration value="0103005"> <annotation> <documentation>simultane Mastektomie, Ablatio / hautsparend</documentation> </annotation> </enumeration> <enumeration value="0103006"> <annotation> <documentation>simultane Mastektomie, nippelerhaltend</documentation> </annotation> </enumeration> <enumeration value="0103007"> <annotation> <documentation>Axilla-Dissektion</documentation> </annotation> </enumeration> <enumeration value="0103008"> <annotation> <documentation>Drainage</documentation> </annotation> </enumeration> </restriction> </simpleType> </pre>
--	---

simpleType enum_0104

namespace	http://xml.ir-d.de/irdsa						
type	restriction of string						
properties	base xs:string						
facets	<table border="1"> <thead> <tr> <th>Kind</th> <th>Value</th> <th>Annotation</th> </tr> </thead> <tbody> <tr> <td>enumeration</td> <td>0104001</td> <td>documentation Austausch Expander gegen dauerhaftes Brustimplantat</td> </tr> </tbody> </table>	Kind	Value	Annotation	enumeration	0104001	documentation Austausch Expander gegen dauerhaftes Brustimplantat
Kind	Value	Annotation					
enumeration	0104001	documentation Austausch Expander gegen dauerhaftes Brustimplantat					
annotation	documentation Kat_BI_GrundAustausch						
source	<pre> <simpleType name="enum_0104"> <annotation> <documentation>Kat_BI_GrundAustausch</documentation> </annotation> <restriction base="xs:string"> <enumeration value="0104001"> <annotation> <documentation>Austausch Expander gegen dauerhaftes Brustimplantat</documentation> </annotation> </enumeration> </restriction> </simpleType> </pre>						

simpleType enum_0105

namespace	http://xml.ir-d.de/irdsa		
type	restriction of string		
properties	base xs:string		
facets	Kind	Value	Annotation
	enumeration	0105001	documentation simultane Lappendeckung
	enumeration	0105002	documentation simultane Eigenfetttransplantation
	enumeration	0105003	documentation simultane Mastopexie
	enumeration	0105008	documentation Drainage
	enumeration	0105009	documentation Kapsulektomie, komplett
	enumeration	0105010	documentation Kapsulektomie, partiell
	enumeration	0105011	documentation Neopocket
annotation	documentation Kat_BI_OperationsdetailAustausch		
source	<pre> <simpleType name="enum_0105"> <annotation> <documentation>Kat_BI_OperationsdetailAustausch</documentation> </annotation> <restriction base="xs:string"> <enumeration value="0105001"> <annotation> <documentation>simultane Lappendeckung</documentation> </annotation> </enumeration> <enumeration value="0105002"> <annotation> <documentation>simultane Eigenfetttransplantation</documentation> </annotation> </enumeration> <enumeration value="0105003"> <annotation> <documentation>simultane Mastopexie</documentation> </annotation> </enumeration> <enumeration value="0105008"> <annotation> <documentation>Drainage</documentation> </annotation> </enumeration> <enumeration value="0105009"> <annotation> <documentation>Kapsulektomie, komplett</documentation> </annotation> </enumeration> <enumeration value="0105010"> <annotation> <documentation>Kapsulektomie, partiell</documentation> </annotation> </enumeration> <enumeration value="0105011"> <annotation> </pre>		

	<pre> <documentation>Neopocket</documentation> </annotation> </enumeration> </restriction> </simpleType> </pre>
--	---

simpleType enum_0106

namespace	http://xml.ir-d.de/irdsa		
type	restriction of string		
properties	base xs:string		
facets	Kind	Value	Annotation
	enumeration	0106001	documentation Patientenwunsch
	enumeration	0106002	documentation asymptomatisch
	enumeration	0106003	documentation Komplikation
annotation	documentation Kat_BI_GrundRevisionExplantation		
source	<pre> <simpleType name="enum_0106"> <annotation> <documentation>Kat_BI_GrundRevisionExplantation</documentation> </annotation> <restriction base="xs:string"> <enumeration value="0106001"> <annotation> <documentation>Patientenwunsch</documentation> </annotation> </enumeration> <enumeration value="0106002"> <annotation> <documentation>asymptomatisch</documentation> </annotation> </enumeration> <enumeration value="0106003"> <annotation> <documentation>Komplikation</documentation> </annotation> </enumeration> </restriction> </simpleType> </pre>		

simpleType enum_0107

namespace	http://xml.ir-d.de/irdsa		
type	restriction of string		
properties	base xs:string		
facets	Kind	Value	Annotation
	enumeration	0107001	documentation simultane Lappendeckung
	enumeration	0107002	documentation simultane Eigenfetttransplantation
	enumeration	0107003	documentation simultane Mastopexie

	<p>enumeration 0107005 documentation simultane Mastektomie, Ablatio / hautsparend</p> <p>enumeration 0107006 documentation simultane Mastektomie, nippelerhaltend</p> <p>enumeration 0107007 documentation Axilla-Dissektion</p> <p>enumeration 0107008 documentation Drainage</p> <p>enumeration 0107009 documentation Kapsulektomie, komplett</p> <p>enumeration 0107010 documentation Kapsulektomie, partiell</p> <p>enumeration 0107011 documentation Neopocket</p>
annotation	documentation Kat_BI_OperationsdetailRevision
source	<pre> <simpleType name="enum_0107"> <annotation> <documentation>Kat_BI_OperationsdetailRevision</documentation> </annotation> <restriction base="xs:string"> <enumeration value="0107001"> <annotation> <documentation>simultane Lappendeckung</documentation> </annotation> </enumeration> <enumeration value="0107002"> <annotation> <documentation>simultane Eigenfetttransplantation</documentation> </annotation> </enumeration> <enumeration value="0107003"> <annotation> <documentation>simultane Mastopexie</documentation> </annotation> </enumeration> <enumeration value="0107005"> <annotation> <documentation>simultane Mastektomie, Ablatio / hautsparend</documentation> </annotation> </enumeration> <enumeration value="0107006"> <annotation> <documentation>simultane Mastektomie, nippelerhaltend</documentation> </annotation> </enumeration> <enumeration value="0107007"> <annotation> <documentation>Axilla-Dissektion</documentation> </annotation> </enumeration> <enumeration value="0107008"> <annotation> <documentation>Drainage</documentation> </annotation> </enumeration> <enumeration value="0107009"> <annotation> <documentation>Kapsulektomie, komplett</documentation> </annotation> </enumeration> </restriction> </simpleType> </pre>

	<pre> </annotation> </enumeration> <enumeration value="0107010"> <annotation> <documentation>Kapsulektomie, partiell</documentation> </annotation> </enumeration> <enumeration value="0107011"> <annotation> <documentation>Neopocket</documentation> </annotation> </enumeration> </restriction> </simpleType> </pre>
--	--

simpleType enum_0110

namespace	http://xml.ir-d.de/irdsa						
type	restriction of string						
properties	base xs:string						
facets	<table border="1"> <thead> <tr> <th>Kind</th> <th>Value</th> <th>Annotation</th> </tr> </thead> <tbody> <tr> <td>enumeration</td> <td>0110001</td> <td>documentation Bestrahlung</td> </tr> </tbody> </table>	Kind	Value	Annotation	enumeration	0110001	documentation Bestrahlung
Kind	Value	Annotation					
enumeration	0110001	documentation Bestrahlung					
annotation	documentation Kat_BI_VorbehandlungLokal						
source	<pre> <simpleType name="enum_0110"> <annotation> <documentation>Kat_BI_VorbehandlungLokal</documentation> </annotation> <restriction base="xs:string"> <enumeration value="0110001"> <annotation> <documentation>Bestrahlung</documentation> </annotation> </enumeration> </restriction> </simpleType> </pre>						

simpleType enum_0111

namespace	http://xml.ir-d.de/irdsa												
type	restriction of string												
properties	base xs:string												
facets	<table border="1"> <thead> <tr> <th>Kind</th> <th>Value</th> <th>Annotation</th> </tr> </thead> <tbody> <tr> <td>enumeration</td> <td>0111001</td> <td>documentation nein</td> </tr> <tr> <td>enumeration</td> <td>0111002</td> <td>documentation Lipofilling</td> </tr> <tr> <td>enumeration</td> <td>0111003</td> <td>documentation Eigengewebstrekonstruktion</td> </tr> </tbody> </table>	Kind	Value	Annotation	enumeration	0111001	documentation nein	enumeration	0111002	documentation Lipofilling	enumeration	0111003	documentation Eigengewebstrekonstruktion
Kind	Value	Annotation											
enumeration	0111001	documentation nein											
enumeration	0111002	documentation Lipofilling											
enumeration	0111003	documentation Eigengewebstrekonstruktion											
annotation	documentation Kat_BI_Verfahrenswechsel												
source	<pre> <simpleType name="enum_0111"> <annotation> </pre>												

	<pre> <documentation>Kat_BI_Verfahrenswechsel</documentation> </annotation> <restriction base="xs:string"> <enumeration value="0111001"> <annotation> <documentation>nein</documentation> </annotation> </enumeration> <enumeration value="0111002"> <annotation> <documentation>Lipofilling</documentation> </annotation> </enumeration> <enumeration value="0111003"> <annotation> <documentation>Eigengewebsrekonstruktion</documentation> </annotation> </enumeration> </restriction> </simpleType> </pre>
--	--

simpleType enum_0112

namespace	http://xml.ir-d.de/irdsa		
type	restriction of string		
properties	base xs:string		
facets	Kind	Value	Annotation
	enumeration	0112001	documentation subglandulär / epipektoral
	enumeration	0112002	documentation subpektoral
	enumeration	0112003	documentation subfaszial
	enumeration	0112004	documentation sub-flap
	enumeration	0112005	documentation subkutan
	enumeration	0112006	documentation dual plane
	enumeration	0112042	documentation andere
annotation	documentation Kat_BI_LageImplantat		
source	<pre> <simpleType name="enum_0112"> <annotation> <documentation>Kat_BI_LageImplantat</documentation> </annotation> <restriction base="xs:string"> <enumeration value="0112001"> <annotation> <documentation>subglandulär / epipektoral</documentation> </annotation> </enumeration> <enumeration value="0112002"> <annotation> <documentation>subpektoral</documentation> </annotation> </enumeration> </restriction> </simpleType> </pre>		

	<pre> </enumeration> <enumeration value="0112003"> <annotation> <documentation>subfaszial</documentation> </annotation> </enumeration> <enumeration value="0112004"> <annotation> <documentation>sub-flap</documentation> </annotation> </enumeration> <enumeration value="0112005"> <annotation> <documentation>subkutan</documentation> </annotation> </enumeration> <enumeration value="0112006"> <annotation> <documentation>dual plane</documentation> </annotation> </enumeration> <enumeration value="0112042"> <annotation> <documentation>andere</documentation> </annotation> </enumeration> </restriction> </simpleType> </pre>
--	--

simpleType enum_0113

namespace	http://xml.ir-d.de/irdsa						
type	restriction of string						
properties	base xs:string						
facets	<table border="1"> <thead> <tr> <th>Kind</th> <th>Value</th> <th>Annotation</th> </tr> </thead> <tbody> <tr> <td>enumeration</td> <td>0113001</td> <td>documentation Chemotherapie innerhalb der letzten drei Monate</td> </tr> </tbody> </table>	Kind	Value	Annotation	enumeration	0113001	documentation Chemotherapie innerhalb der letzten drei Monate
Kind	Value	Annotation					
enumeration	0113001	documentation Chemotherapie innerhalb der letzten drei Monate					
annotation	documentation Kat_BI_VorbehandlungSystemisch						
source	<pre> <simpleType name="enum_0113"> <annotation> <documentation>Kat_BI_VorbehandlungSystemisch</documentation> </annotation> <restriction base="xs:string"> <enumeration value="0113001"> <annotation> <documentation>Chemotherapie innerhalb der letzten drei Monate</documentation> </annotation> </enumeration> </restriction> </simpleType> </pre>						

simpleType enum_0114

namespace	http://xml.ir-d.de/irdsa		
type	restriction of string		
properties	base xs:string		
facets	Kind	Value	Annotation
	enumeration	0114001	documentation vollständig
	enumeration	0114002	documentation nein
	enumeration	0114003	documentation teilweise
	enumeration	0114004	documentation nicht vorhanden
annotation	documentation Kat_BI_EntfernungADMNetz		
source	<pre> <simpleType name="enum_0114"> <annotation> <documentation>Kat_BI_EntfernungADMNetz</documentation> </annotation> <restriction base="xs:string"> <enumeration value="0114001"> <annotation> <documentation>vollständig</documentation> </annotation> </enumeration> <enumeration value="0114002"> <annotation> <documentation>nein</documentation> </annotation> </enumeration> <enumeration value="0114003"> <annotation> <documentation>teilweise</documentation> </annotation> </enumeration> <enumeration value="0114004"> <annotation> <documentation>nicht vorhanden</documentation> </annotation> </enumeration> </restriction> </simpleType> </pre>		

simpleType enum_0116

namespace	http://xml.ir-d.de/irdsa		
type	restriction of string		
properties	base xs:string		
facets	Kind	Value	Annotation
	enumeration	0116001	documentation Spülung, antibiotisch
	enumeration	0116002	documentation Spülung, antiseptisch
	enumeration	0116003	documentation Spülung, wirkstofffrei
	enumeration	0116004	documentation

	<p>enumeration 0116005 Spülung, andere documentation</p> <p>enumeration 0116006 prä-/perioperative Antibiotika documentation</p> <p>enumeration 0116007 postoperative Antibiotika documentation</p> <p>enumeration 0116008 Handschuhwechsel vor Implantation documentation Implantationshilfe</p>
annotation	documentation Kat_BI_Operationsmassnahme
source	<pre> <simpleType name="enum_0116"> <annotation> <documentation>Kat_BI_Operationsmassnahme</documentation> </annotation> <restriction base="xs:string"> <enumeration value="0116001"> <annotation> <documentation>Spülung, antibiotisch</documentation> </annotation> </enumeration> <enumeration value="0116002"> <annotation> <documentation>Spülung, antiseptisch</documentation> </annotation> </enumeration> <enumeration value="0116003"> <annotation> <documentation>Spülung, wirkstofffrei</documentation> </annotation> </enumeration> <enumeration value="0116004"> <annotation> <documentation>Spülung, andere</documentation> </annotation> </enumeration> <enumeration value="0116005"> <annotation> <documentation>prä-/perioperative Antibiotika</documentation> </annotation> </enumeration> <enumeration value="0116006"> <annotation> <documentation>postoperative Antibiotika</documentation> </annotation> </enumeration> <enumeration value="0116007"> <annotation> <documentation>Handschuhwechsel vor Implantation</documentation> </annotation> </enumeration> <enumeration value="0116008"> <annotation> <documentation>Implantationshilfe</documentation> </annotation> </enumeration> </restriction> </simpleType> </pre>

simpleType enum_0118

namespace	http://xml.ir-d.de/irdsa		
type	restriction of string		
properties	base xs:string		
facets	Kind	Value	Annotation
	enumeration	0118001	documentation axillär
	enumeration	0118002	documentation periareolär
	enumeration	0118003	documentation inframammär
	enumeration	0118004	documentation Mastektomienarbe
	enumeration	0118042	documentation anderer
annotation	documentation Kat_BI_Operationszugang		
source	<pre> <simpleType name="enum_0118"> <annotation> <documentation>Kat_BI_Operationszugang</documentation> </annotation> <restriction base="xs:string"> <enumeration value="0118001"> <annotation> <documentation>axillär</documentation> </annotation> </enumeration> <enumeration value="0118002"> <annotation> <documentation>periareolär</documentation> </annotation> </enumeration> <enumeration value="0118003"> <annotation> <documentation>inframammär</documentation> </annotation> </enumeration> <enumeration value="0118004"> <annotation> <documentation>Mastektomienarbe</documentation> </annotation> </enumeration> <enumeration value="0118042"> <annotation> <documentation>anderer</documentation> </annotation> </enumeration> </restriction> </simpleType> </pre>		

simpleType enum_0120

namespace	http://xml.ir-d.de/irdsa
type	restriction of string

properties	base xs:string						
facets	<table border="1"> <thead> <tr> <th>Kind</th> <th>Value</th> <th>Annotation</th> </tr> </thead> <tbody> <tr> <td>enumeration</td> <td>0120001</td> <td>documentation Expander defekt</td> </tr> </tbody> </table>	Kind	Value	Annotation	enumeration	0120001	documentation Expander defekt
Kind	Value	Annotation					
enumeration	0120001	documentation Expander defekt					
annotation	documentation Kat_BI_BefundAustausch						
source	<pre><simpleType name="enum_0120"> <annotation> <documentation>Kat_BI_BefundAustausch</documentation> </annotation> <restriction base="xs:string"> <enumeration value="0120001"> <annotation> <documentation>Expander defekt</documentation> </annotation> </enumeration> </restriction> </simpleType></pre>						

simpleType enum 0121

namespace	http://xml.ir-d.de/irdsa																																																			
type	restriction of string																																																			
properties	base xs:string																																																			
facets	<table border="1"> <thead> <tr> <th>Kind</th> <th>Value</th> <th>Annotation</th> </tr> </thead> <tbody> <tr> <td>enumeration</td> <td>0121001</td> <td>documentation Infektion</td> </tr> <tr> <td>enumeration</td> <td>0121002</td> <td>documentation Serom</td> </tr> <tr> <td>enumeration</td> <td>0121003</td> <td>documentation Hämatom</td> </tr> <tr> <td>enumeration</td> <td>0121004</td> <td>documentation Kapsel fibrose</td> </tr> <tr> <td>enumeration</td> <td>0121005</td> <td>documentation Implantatruptur</td> </tr> <tr> <td>enumeration</td> <td>0121006</td> <td>documentation Fehlpositionierung/Rotation</td> </tr> <tr> <td>enumeration</td> <td>0121007</td> <td>documentation BIA-ALCL/-SCC, Verdacht</td> </tr> <tr> <td>enumeration</td> <td>0121008</td> <td>documentation BIA-ALCL/-SCC, pathologisch bestätigt</td> </tr> <tr> <td>enumeration</td> <td>0121009</td> <td>documentation Brustschmerzen</td> </tr> <tr> <td>enumeration</td> <td>0121010</td> <td>documentation Doppelkapsel</td> </tr> <tr> <td>enumeration</td> <td>0121011</td> <td>documentation Netz-/ADM-bedingte Komplikation, Non-Integration</td> </tr> <tr> <td>enumeration</td> <td>0121012</td> <td>documentation Netz-/ADM-bedingte Komplikation, andere</td> </tr> <tr> <td>enumeration</td> <td>0121013</td> <td>documentation Hautnekrose/exponiertes Implantat</td> </tr> <tr> <td>enumeration</td> <td>0121014</td> <td>documentation BII/ASIA (Brustimplantat assoziierte Symptome), Verdacht</td> </tr> <tr> <td>enumeration</td> <td>0121015</td> <td>documentation Lymphadenopathie</td> </tr> <tr> <td>enumeration</td> <td>0121016</td> <td>documentation Brustkrebs, neu aufgetreten/Rezidiv</td> </tr> </tbody> </table>	Kind	Value	Annotation	enumeration	0121001	documentation Infektion	enumeration	0121002	documentation Serom	enumeration	0121003	documentation Hämatom	enumeration	0121004	documentation Kapsel fibrose	enumeration	0121005	documentation Implantatruptur	enumeration	0121006	documentation Fehlpositionierung/Rotation	enumeration	0121007	documentation BIA-ALCL/-SCC, Verdacht	enumeration	0121008	documentation BIA-ALCL/-SCC, pathologisch bestätigt	enumeration	0121009	documentation Brustschmerzen	enumeration	0121010	documentation Doppelkapsel	enumeration	0121011	documentation Netz-/ADM-bedingte Komplikation, Non-Integration	enumeration	0121012	documentation Netz-/ADM-bedingte Komplikation, andere	enumeration	0121013	documentation Hautnekrose/exponiertes Implantat	enumeration	0121014	documentation BII/ASIA (Brustimplantat assoziierte Symptome), Verdacht	enumeration	0121015	documentation Lymphadenopathie	enumeration	0121016	documentation Brustkrebs, neu aufgetreten/Rezidiv
Kind	Value	Annotation																																																		
enumeration	0121001	documentation Infektion																																																		
enumeration	0121002	documentation Serom																																																		
enumeration	0121003	documentation Hämatom																																																		
enumeration	0121004	documentation Kapsel fibrose																																																		
enumeration	0121005	documentation Implantatruptur																																																		
enumeration	0121006	documentation Fehlpositionierung/Rotation																																																		
enumeration	0121007	documentation BIA-ALCL/-SCC, Verdacht																																																		
enumeration	0121008	documentation BIA-ALCL/-SCC, pathologisch bestätigt																																																		
enumeration	0121009	documentation Brustschmerzen																																																		
enumeration	0121010	documentation Doppelkapsel																																																		
enumeration	0121011	documentation Netz-/ADM-bedingte Komplikation, Non-Integration																																																		
enumeration	0121012	documentation Netz-/ADM-bedingte Komplikation, andere																																																		
enumeration	0121013	documentation Hautnekrose/exponiertes Implantat																																																		
enumeration	0121014	documentation BII/ASIA (Brustimplantat assoziierte Symptome), Verdacht																																																		
enumeration	0121015	documentation Lymphadenopathie																																																		
enumeration	0121016	documentation Brustkrebs, neu aufgetreten/Rezidiv																																																		
annotation	documentation Kat_BI_BefundKomplett																																																			

source

```
<simpleType name="enum_0121">
  <annotation>
    <documentation>Kat_BI_BefundKomplett</documentation>
  </annotation>
  <restriction base="xs:string">
    <enumeration value="0121001">
      <annotation>
        <documentation>Infektion</documentation>
      </annotation>
    </enumeration>
    <enumeration value="0121002">
      <annotation>
        <documentation>Serom</documentation>
      </annotation>
    </enumeration>
    <enumeration value="0121003">
      <annotation>
        <documentation>Hämatom</documentation>
      </annotation>
    </enumeration>
    <enumeration value="0121004">
      <annotation>
        <documentation>Kapsel Fibrose</documentation>
      </annotation>
    </enumeration>
    <enumeration value="0121005">
      <annotation>
        <documentation>Implantatruptur</documentation>
      </annotation>
    </enumeration>
    <enumeration value="0121006">
      <annotation>
        <documentation>Fehlpositionierung/Rotation</documentation>
      </annotation>
    </enumeration>
    <enumeration value="0121007">
      <annotation>
        <documentation>BIA-ALCL/-SCC, Verdacht</documentation>
      </annotation>
    </enumeration>
    <enumeration value="0121008">
      <annotation>
        <documentation>BIA-ALCL/-SCC, pathologisch bestätigt</documentation>
      </annotation>
    </enumeration>
    <enumeration value="0121009">
      <annotation>
        <documentation>Brustschmerzen</documentation>
      </annotation>
    </enumeration>
    <enumeration value="0121010">
      <annotation>
        <documentation>Doppelkapsel</documentation>
      </annotation>
    </enumeration>
    <enumeration value="0121011">
      <annotation>
        <documentation>Netz-/ADM-bedingte Komplikation,
Non-Integration</documentation>
      </annotation>
    </enumeration>
  </restriction>
</simpleType>
```

	<pre> </annotation> </enumeration> <enumeration value="0121012"> <annotation> <documentation>Netz-/ADM-bedingte Komplikation, andere</documentation> </annotation> </enumeration> <enumeration value="0121013"> <annotation> <documentation>Hautnekrose/exponiertes Implantat</documentation> </annotation> </enumeration> <enumeration value="0121014"> <annotation> <documentation>BII/ASIA (Brustimplantat assoziierte Symptome), Verdacht</documentation> </annotation> </enumeration> <enumeration value="0121015"> <annotation> <documentation>Lymphadenopathie</documentation> </annotation> </enumeration> <enumeration value="0121016"> <annotation> <documentation>Brustkrebs, neu aufgetreten/Rezidiv</documentation> </annotation> </enumeration> </restriction> </simpleType> </pre>
--	---

simpleType enum_0122

namespace	http://xml.ir-d.de/irdsa		
type	restriction of string		
properties	base xs:string		
facets	Kind	Value	Annotation
	enumeration	0122001	documentation ja, ärztlich nachgewiesen
	enumeration	0122002	documentation nein
	enumeration	0122042	documentation unbekannt
annotation	documentation Kat_BI_Autoimmunerkrankung		
source	<pre> <simpleType name="enum_0122"> <annotation> <documentation>Kat_BI_Autoimmunerkrankung</documentation> </annotation> <restriction base="xs:string"> <enumeration value="0122001"> <annotation> <documentation>ja, ärztlich nachgewiesen</documentation> </annotation> </enumeration> <enumeration value="0122002"> <annotation> </pre>		

	<pre> <documentation>nein</documentation> </annotation> </enumeration> <enumeration value="0122042"> <annotation> <documentation>unbekannt</documentation> </annotation> </enumeration> </restriction> </simpleType> </pre>
--	---

simpleType enum_0123

namespace	http://xml.ir-d.de/irdsa		
type	restriction of string		
properties	base xs:string		
facets	Kind	Value	Annotation
	enumeration	0123001	documentation neu aufgetreten
	enumeration	0123002	documentation verschlechtert
	enumeration	0123003	documentation keine Veränderung
	enumeration	0123004	documentation nicht relevant, da Primäreingriff
	enumeration	0123042	documentation unbekannt
annotation	documentation Kat_BI_VerlaufAutoimmunerkrankung		
source	<pre> <simpleType name="enum_0123"> <annotation> <documentation>Kat_BI_VerlaufAutoimmunerkrankung</documentation> </annotation> <restriction base="xs:string"> <enumeration value="0123001"> <annotation> <documentation>neu aufgetreten</documentation> </annotation> </enumeration> <enumeration value="0123002"> <annotation> <documentation>verschlechtert</documentation> </annotation> </enumeration> <enumeration value="0123003"> <annotation> <documentation>keine Veränderung</documentation> </annotation> </enumeration> <enumeration value="0123004"> <annotation> <documentation>nicht relevant, da Primäreingriff</documentation> </annotation> </enumeration> <enumeration value="0123042"> <annotation> <documentation>unbekannt</documentation> </annotation> </enumeration> </restriction> </simpleType> </pre>		

	<pre> </annotation> </enumeration> </restriction> </simpleType> </pre>
--	--

simpleType enum_0124

namespace	http://xml.ir-d.de/irdsa															
type	restriction of string															
properties	base xs:string															
facets	<table border="1"> <thead> <tr> <th>Kind</th> <th>Value</th> <th>Annotation</th> </tr> </thead> <tbody> <tr> <td>enumeration</td> <td>0124001</td> <td>documentation Salzlösung</td> </tr> <tr> <td>enumeration</td> <td>0124002</td> <td>documentation Silikongel</td> </tr> <tr> <td>enumeration</td> <td>0124003</td> <td>documentation Kombination Silikongel und Salzlösung</td> </tr> <tr> <td>enumeration</td> <td>0124042</td> <td>documentation sonstige</td> </tr> </tbody> </table>	Kind	Value	Annotation	enumeration	0124001	documentation Salzlösung	enumeration	0124002	documentation Silikongel	enumeration	0124003	documentation Kombination Silikongel und Salzlösung	enumeration	0124042	documentation sonstige
Kind	Value	Annotation														
enumeration	0124001	documentation Salzlösung														
enumeration	0124002	documentation Silikongel														
enumeration	0124003	documentation Kombination Silikongel und Salzlösung														
enumeration	0124042	documentation sonstige														
annotation	documentation Kat_BI_Fuellung															
source	<pre> <simpleType name="enum_0124"> <annotation> <documentation>Kat_BI_Fuellung</documentation> </annotation> <restriction base="xs:string"> <enumeration value="0124001"> <annotation> <documentation>Salzlösung</documentation> </annotation> </enumeration> <enumeration value="0124002"> <annotation> <documentation>Silikongel</documentation> </annotation> </enumeration> <enumeration value="0124003"> <annotation> <documentation>Kombination Silikongel und Salzlösung</documentation> </annotation> </enumeration> <enumeration value="0124042"> <annotation> <documentation>sonstige</documentation> </annotation> </enumeration> </restriction> </simpleType> </pre>															

simpleType enum_0126

namespace	http://xml.ir-d.de/irdsa
type	restriction of string
properties	base xs:string

facets	<table border="1"> <thead> <tr> <th>Kind</th> <th>Value</th> <th>Annotation</th> </tr> </thead> <tbody> <tr> <td>enumeration</td> <td>0126001</td> <td>documentation anatomisch (tropfenförmig)</td> </tr> <tr> <td>enumeration</td> <td>0126002</td> <td>documentation rund (punktsymmetrisch)</td> </tr> <tr> <td>enumeration</td> <td>0126042</td> <td>documentation sonstige</td> </tr> </tbody> </table>	Kind	Value	Annotation	enumeration	0126001	documentation anatomisch (tropfenförmig)	enumeration	0126002	documentation rund (punktsymmetrisch)	enumeration	0126042	documentation sonstige
Kind	Value	Annotation											
enumeration	0126001	documentation anatomisch (tropfenförmig)											
enumeration	0126002	documentation rund (punktsymmetrisch)											
enumeration	0126042	documentation sonstige											
annotation	documentation Kat_BI_Form												
source	<pre><simpleType name="enum_0126"> <annotation> <documentation>Kat_BI_Form</documentation> </annotation> <restriction base="xs:string"> <enumeration value="0126001"> <annotation> <documentation>anatomisch (tropfenförmig)</documentation> </annotation> </enumeration> <enumeration value="0126002"> <annotation> <documentation>rund (punktsymmetrisch)</documentation> </annotation> </enumeration> <enumeration value="0126042"> <annotation> <documentation>sonstige</documentation> </annotation> </enumeration> </restriction> </simpleType></pre>												

simpleType enum_0128

namespace	http://xml.ir-d.de/irdsa												
type	restriction of string												
properties	base xs:string												
facets	<table border="1"> <thead> <tr> <th>Kind</th> <th>Value</th> <th>Annotation</th> </tr> </thead> <tbody> <tr> <td>enumeration</td> <td>0128001</td> <td>documentation glattwandig</td> </tr> <tr> <td>enumeration</td> <td>0128002</td> <td>documentation beschichtet</td> </tr> <tr> <td>enumeration</td> <td>0128003</td> <td>documentation texturiert</td> </tr> </tbody> </table>	Kind	Value	Annotation	enumeration	0128001	documentation glattwandig	enumeration	0128002	documentation beschichtet	enumeration	0128003	documentation texturiert
Kind	Value	Annotation											
enumeration	0128001	documentation glattwandig											
enumeration	0128002	documentation beschichtet											
enumeration	0128003	documentation texturiert											
annotation	documentation Kat_BI_Oberflaeche												
source	<pre><simpleType name="enum_0128"> <annotation> <documentation>Kat_BI_Oberflaeche</documentation> </annotation> <restriction base="xs:string"> <enumeration value="0128001"> <annotation> <documentation>glattwandig</documentation> </annotation> </enumeration> <enumeration value="0128002"></pre>												

	<pre> <annotation> <documentation>beschichtet</documentation> </annotation> </enumeration> <enumeration value="0128003"> <annotation> <documentation>texturiert</documentation> </annotation> </enumeration> </restriction> </simpleType> </pre>
--	--

simpleType enum_0130

namespace	http://xml.ir-d.de/irdsa		
type	restriction of string		
properties	base xs:string		
facets	Kind	Value	Annotation
	enumeration	0130001	documentation Allergan
	enumeration	0130002	documentation Cereplas
	enumeration	0130003	documentation CUI (Cox Uphoff Implants)
	enumeration	0130004	documentation EMSI Biomedical
	enumeration	0130005	documentation Establishment labs
	enumeration	0130006	documentation Eurosilicone
	enumeration	0130007	documentation Nagor
	enumeration	0130008	documentation Groupe Sebbin
	enumeration	0130009	documentation Laboratoires Arion
	enumeration	0130010	documentation Mentor
	enumeration	0130011	documentation Pérouse Plastie SAS
	enumeration	0130012	documentation PIP M-Implants
	enumeration	0130013	documentation Polytech Health & Aesthetics
	enumeration	0130014	documentation Silimed
	enumeration	0130015	documentation Surgitek
	enumeration	0130016	documentation G&G Biotechnology
	enumeration	0130017	documentation nicht belegter Wert
	enumeration	0130018	documentation nicht belegter Wert
	enumeration	0130019	documentation nicht belegter Wert
	enumeration	0130020	documentation nicht belegter Wert
	enumeration	0130021	documentation nicht belegter Wert

	enumeration 0130042 documentation sonstiger
annotation	documentation Kat_BI_Hersteller
source	<pre> <simpleType name="enum_0130"> <annotation> <documentation>Kat_BI_Hersteller</documentation> </annotation> <restriction base="xs:string"> <enumeration value="0130001"> <annotation> <documentation>Allergan</documentation> </annotation> </enumeration> <enumeration value="0130002"> <annotation> <documentation>Cereplas</documentation> </annotation> </enumeration> <enumeration value="0130003"> <annotation> <documentation>CUI (Cox Uphoff Implants)</documentation> </annotation> </enumeration> <enumeration value="0130004"> <annotation> <documentation>EMSI Biomedical</documentation> </annotation> </enumeration> <enumeration value="0130005"> <annotation> <documentation>Establishment labs</documentation> </annotation> </enumeration> <enumeration value="0130006"> <annotation> <documentation>Eurosilicone</documentation> </annotation> </enumeration> <enumeration value="0130007"> <annotation> <documentation>Nagor</documentation> </annotation> </enumeration> <enumeration value="0130008"> <annotation> <documentation>Groupe Sebbin</documentation> </annotation> </enumeration> <enumeration value="0130009"> <annotation> <documentation>Laboratoires Arion</documentation> </annotation> </enumeration> <enumeration value="0130010"> <annotation> <documentation>Mentor</documentation> </annotation> </enumeration> </restriction> </simpleType> </pre>

```
<enumeration value="0130011">
  <annotation>
    <documentation>Pérouse Plastie SAS</documentation>
  </annotation>
</enumeration>
<enumeration value="0130012">
  <annotation>
    <documentation>PIP M-Implants</documentation>
  </annotation>
</enumeration>
<enumeration value="0130013">
  <annotation>
    <documentation>Polytech Health & Aesthetics</documentation>
  </annotation>
</enumeration>
<enumeration value="0130014">
  <annotation>
    <documentation>Silimed</documentation>
  </annotation>
</enumeration>
<enumeration value="0130015">
  <annotation>
    <documentation>Surgitek</documentation>
  </annotation>
</enumeration>
<enumeration value="0130016">
  <annotation>
    <documentation>G&G Biotechnology</documentation>
  </annotation>
</enumeration>
<enumeration value="0130017">
  <annotation>
    <documentation>nicht belegter Wert</documentation>
  </annotation>
</enumeration>
<enumeration value="0130018">
  <annotation>
    <documentation>nicht belegter Wert</documentation>
  </annotation>
</enumeration>
<enumeration value="0130019">
  <annotation>
    <documentation>nicht belegter Wert</documentation>
  </annotation>
</enumeration>
<enumeration value="0130020">
  <annotation>
    <documentation>nicht belegter Wert</documentation>
  </annotation>
</enumeration>
<enumeration value="0130021">
  <annotation>
    <documentation>nicht belegter Wert</documentation>
  </annotation>
</enumeration>
<enumeration value="0130042">
  <annotation>
    <documentation>sonstiger</documentation>
  </annotation>
</enumeration>
```

	<pre> </enumeration> </restriction> </simpleType> </pre>
--	--

simpleType enum_0131

namespace	http://xml.ir-d.de/irdsa		
type	restriction of string		
properties	base xs:string		
facets	Kind	Value	Annotation
	enumeration	0131001	documentation Allergan
	enumeration	0131002	documentation Establishment labs
	enumeration	0131003	documentation Eurosilicone
	enumeration	0131004	documentation Galatea
	enumeration	0131005	documentation Integra
	enumeration	0131006	documentation Lifecell
	enumeration	0131007	documentation MBP (Medical Biomaterial Products)
	enumeration	0131008	documentation Mentor
	enumeration	0131009	documentation Novus Scientific
	enumeration	0131042	documentation sonstiger
annotation	documentation Kat_BI_ZubehoerHersteller		
source	<pre> <simpleType name="enum_0131"> <annotation> <documentation>Kat_BI_ZubehoerHersteller</documentation> </annotation> <restriction base="xs:string"> <enumeration value="0131001"> <annotation> <documentation>Allergan</documentation> </annotation> </enumeration> <enumeration value="0131002"> <annotation> <documentation>Establishment labs</documentation> </annotation> </enumeration> <enumeration value="0131003"> <annotation> <documentation>Eurosilicone</documentation> </annotation> </enumeration> <enumeration value="0131004"> <annotation> <documentation>Galatea</documentation> </annotation> </enumeration> <enumeration value="0131005"> </pre>		

	<pre> <annotation> <documentation>Integra</documentation> </annotation> </enumeration> <enumeration value="0131006"> <annotation> <documentation>Lifecell</documentation> </annotation> </enumeration> <enumeration value="0131007"> <annotation> <documentation>MBP (Medical Biomaterial Products)</documentation> </annotation> </enumeration> <enumeration value="0131008"> <annotation> <documentation>Mentor</documentation> </annotation> </enumeration> <enumeration value="0131009"> <annotation> <documentation>Novus Scientific</documentation> </annotation> </enumeration> <enumeration value="0131042"> <annotation> <documentation>sonstiger</documentation> </annotation> </enumeration> </restriction> </simpleType> </pre>
--	---

simpleType enum_0190

namespace	http://xml.ir-d.de/irdsa		
type	restriction of string		
properties	base xs:string		
facets	Kind	Value	Annotation
	enumeration	0190001	documentation Brustimplantat
	enumeration	0190003	documentation Brustexpander
annotation	documentation Kat_BI_Artikeltyp		
source	<pre> <simpleType name="enum_0190"> <annotation> <documentation>Kat_BI_Artikeltyp</documentation> </annotation> <restriction base="xs:string"> <enumeration value="0190001"> <annotation> <documentation>Brustimplantat</documentation> </annotation> </enumeration> <enumeration value="0190003"> <annotation> <documentation>Brustexpander</documentation> </annotation> </enumeration> </restriction> </simpleType> </pre>		

	<pre> </annotation> </enumeration> </restriction> </simpleType> </pre>
--	--

simpleType enum_0191

namespace	http://xml.ir-d.de/irdsa									
type	restriction of string									
properties	base xs:string									
facets	<table border="1"> <thead> <tr> <th>Kind</th> <th>Value</th> <th>Annotation</th> </tr> </thead> <tbody> <tr> <td>enumeration</td> <td>0191001</td> <td>documentation Netz</td> </tr> <tr> <td>enumeration</td> <td>0191002</td> <td>documentation ADM</td> </tr> </tbody> </table>	Kind	Value	Annotation	enumeration	0191001	documentation Netz	enumeration	0191002	documentation ADM
Kind	Value	Annotation								
enumeration	0191001	documentation Netz								
enumeration	0191002	documentation ADM								
annotation	documentation Kat_BI_ZubehoerTyp									
source	<pre> <simpleType name="enum_0191"> <annotation> <documentation>Kat_BI_ZubehoerTyp</documentation> </annotation> <restriction base="xs:string"> <enumeration value="0191001"> <annotation> <documentation>Netz</documentation> </annotation> </enumeration> <enumeration value="0191002"> <annotation> <documentation>ADM</documentation> </annotation> </enumeration> </restriction> </simpleType> </pre>									

simpleType enum_0200

namespace	http://xml.ir-d.de/irdsa									
type	restriction of string									
properties	base xs:string									
facets	<table border="1"> <thead> <tr> <th>Kind</th> <th>Value</th> <th>Annotation</th> </tr> </thead> <tbody> <tr> <td>enumeration</td> <td>0200001</td> <td>documentation Erst-OP</td> </tr> <tr> <td>enumeration</td> <td>0200002</td> <td>documentation Folgeeingriff</td> </tr> </tbody> </table>	Kind	Value	Annotation	enumeration	0200001	documentation Erst-OP	enumeration	0200002	documentation Folgeeingriff
Kind	Value	Annotation								
enumeration	0200001	documentation Erst-OP								
enumeration	0200002	documentation Folgeeingriff								
annotation	documentation Kat_EP_ArtEingriff									
source	<pre> <simpleType name="enum_0200"> <annotation> <documentation>Kat_EP_ArtEingriff</documentation> </annotation> <restriction base="xs:string"> <enumeration value="0200001"> <annotation> </pre>									

	<pre> <documentation>Erst-OP</documentation> </annotation> </enumeration> <enumeration value="020002"> <annotation> <documentation>Folgeeingriff</documentation> </annotation> </enumeration> </restriction> </simpleType> </pre>
--	---

simpleType enum_0202

namespace	http://xml.ir-d.de/irdsa		
type	restriction of string		
properties	base xs:string		
facets	Kind	Value	Annotation
	enumeration	0202001	documentation Lockerung
	enumeration	0202002	documentation Infektion, Verdacht auf
	enumeration	0202003	documentation Infektion, gesichert
	enumeration	0202004	documentation Luxation, Inlay aus der Pfanne
	enumeration	0202005	documentation Luxation, Kopf aus Pfanne/Inlay
	enumeration	0202006	documentation Periprothetische Fraktur
	enumeration	0202007	documentation Verschleiß des PE-Inlays
	enumeration	0202008	documentation Implantatbruch
	enumeration	0202009	documentation Implantatfehlage/Malalignent
	enumeration	0202010	documentation Osteolysen bei festem Implantat
	enumeration	0202011	documentation Progression der Grunderkrankung
	enumeration	0202012	documentation ARMED
	enumeration	0202013	documentation Verdacht auf allergische Reaktion
	enumeration	0202021	documentation Zustand nach Prothesenentfernung
	enumeration	0202042	documentation andere Gründe
annotation	documentation Kat_EP_GrundWechselHuefte		
source	<pre> <simpleType name="enum_0202"> <annotation> <documentation>Kat_EP_GrundWechselHuefte</documentation> </annotation> <restriction base="xs:string"> <enumeration value="0202001"> <annotation> <documentation>Lockerung</documentation> </annotation> </enumeration> </pre>		

```
<enumeration value="0202002">
  <annotation>
    <documentation>Infektion, Verdacht auf</documentation>
  </annotation>
</enumeration>
<enumeration value="0202003">
  <annotation>
    <documentation>Infektion, gesichert</documentation>
  </annotation>
</enumeration>
<enumeration value="0202004">
  <annotation>
    <documentation>Luxation, Inlay aus der Pfanne</documentation>
  </annotation>
</enumeration>
<enumeration value="0202005">
  <annotation>
    <documentation>Luxation, Kopf aus Pfanne/Inlay</documentation>
  </annotation>
</enumeration>
<enumeration value="0202006">
  <annotation>
    <documentation>Periprothetische Fraktur</documentation>
  </annotation>
</enumeration>
<enumeration value="0202007">
  <annotation>
    <documentation>Verschleiß des PE-Inlays</documentation>
  </annotation>
</enumeration>
<enumeration value="0202008">
  <annotation>
    <documentation>Implantatbruch</documentation>
  </annotation>
</enumeration>
<enumeration value="0202009">
  <annotation>
    <documentation>Implantatfehllage/Malalignent</documentation>
  </annotation>
</enumeration>
<enumeration value="0202010">
  <annotation>
    <documentation>Osteolysen bei festem Implantat</documentation>
  </annotation>
</enumeration>
<enumeration value="0202011">
  <annotation>
    <documentation>Progression der Grunderkrankung</documentation>
  </annotation>
</enumeration>
<enumeration value="0202012">
  <annotation>
    <documentation>ARMD</documentation>
  </annotation>
</enumeration>
<enumeration value="0202013">
  <annotation>
    <documentation>Verdacht auf allergische Reaktion</documentation>
  </annotation>
</enumeration>
```

	<pre> </enumeration> <enumeration value="0202021"> <annotation> <documentation>Zustand nach Prothesenentfernung</documentation> </annotation> </enumeration> <enumeration value="0202042"> <annotation> <documentation>andere Gründe</documentation> </annotation> </enumeration> </restriction> </simpleType> </pre>
--	---

simpleType enum_0204

namespace	http://xml.ir-d.de/irdsa		
type	restriction of string		
properties	base xs:string		
facets	Kind	Value	Annotation
	enumeration	0204001	documentation Lockerung
	enumeration	0204002	documentation Infektion, Verdacht auf
	enumeration	0204003	documentation Infektion, gesichert
	enumeration	0204006	documentation Periprothetische Fraktur
	enumeration	0204007	documentation Verschleiß
	enumeration	0204008	documentation Implantatbruch
	enumeration	0204009	documentation Implantatfehlage/Malalignent
	enumeration	0204010	documentation Osteolysen bei festem Implantat
	enumeration	0204011	documentation Progression der Grunderkrankung
	enumeration	0204012	documentation ARMD
	enumeration	0204013	documentation Verdacht auf allergische Reaktion
	enumeration	0204014	documentation Dislokation/Migration von Komponenten
	enumeration	0204015	documentation Bandinstabilität
	enumeration	0204016	documentation Bewegungseinschränkung
	enumeration	0204021	documentation Zustand nach Prothesenentfernung
	enumeration	0204042	documentation andere Gründe
annotation	documentation Kat_EP_GrundWechselKnie		
source	<pre> <simpleType name="enum_0204"> <annotation> <documentation>Kat_EP_GrundWechselKnie</documentation> </annotation> <restriction base="xs:string"> </pre>		

```
<enumeration value="0204001">
  <annotation>
    <documentation>Lockerung</documentation>
  </annotation>
</enumeration>
<enumeration value="0204002">
  <annotation>
    <documentation>Infektion, Verdacht auf</documentation>
  </annotation>
</enumeration>
<enumeration value="0204003">
  <annotation>
    <documentation>Infektion, gesichert</documentation>
  </annotation>
</enumeration>
<enumeration value="0204006">
  <annotation>
    <documentation>Periprothetische Fraktur</documentation>
  </annotation>
</enumeration>
<enumeration value="0204007">
  <annotation>
    <documentation>Verschleiß</documentation>
  </annotation>
</enumeration>
<enumeration value="0204008">
  <annotation>
    <documentation>Implantatbruch</documentation>
  </annotation>
</enumeration>
<enumeration value="0204009">
  <annotation>
    <documentation>Implantatfehllage/Malalignent</documentation>
  </annotation>
</enumeration>
<enumeration value="0204010">
  <annotation>
    <documentation>Osteolysen bei festem Implantat</documentation>
  </annotation>
</enumeration>
<enumeration value="0204011">
  <annotation>
    <documentation>Progression der Grunderkrankung</documentation>
  </annotation>
</enumeration>
<enumeration value="0204012">
  <annotation>
    <documentation>ARMD</documentation>
  </annotation>
</enumeration>
<enumeration value="0204013">
  <annotation>
    <documentation>Verdacht auf allergische Reaktion</documentation>
  </annotation>
</enumeration>
<enumeration value="0204014">
  <annotation>
    <documentation>Dislokation/Migration von Komponenten</documentation>
  </annotation>
</enumeration>
```

```

</enumeration>
<enumeration value="0204015">
  <annotation>
    <documentation>Bandinstabilität</documentation>
  </annotation>
</enumeration>
<enumeration value="0204016">
  <annotation>
    <documentation>Bewegungseinschränkung</documentation>
  </annotation>
</enumeration>
<enumeration value="0204021">
  <annotation>
    <documentation>Zustand nach Prothesenentfernung</documentation>
  </annotation>
</enumeration>
<enumeration value="0204042">
  <annotation>
    <documentation>andere Gründe</documentation>
  </annotation>
</enumeration>
</restriction>
</simpleType>

```

simpleType enum_0206

namespace	http://xml.ir-d.de/irdsa		
type	restriction of string		
properties	base xs:string		
facets	Kind	Value	Annotation
	enumeration	0206001	documentation Lockerung
	enumeration	0206002	documentation Infektion, Verdacht auf
	enumeration	0206003	documentation Infektion, gesichert
	enumeration	0206004	documentation Luxation, Inlay aus der Pfanne
	enumeration	0206005	documentation Luxation, Kopf aus Pfanne/Inlay
	enumeration	0206006	documentation Periprothetische Fraktur
	enumeration	0206007	documentation Verschleiß
	enumeration	0206008	documentation Implantatbruch
	enumeration	0206009	documentation Implantatfehlhage/Malalignent
	enumeration	0206010	documentation Osteolysen bei festem Implantat
	enumeration	0206011	documentation Progression der Grunderkrankung
	enumeration	0206012	documentation ARMD
	enumeration	0206013	documentation Verdacht auf allergische Reaktion
	enumeration	0206014	documentation Dislokation/Migration von Komponenten
	enumeration	0206015	documentation

	<p>enumeration 0206016 Bandinstabilität documentation Bewegungseinschränkung</p> <p>enumeration 0206021 documentation Zustand nach Prothesenentfernung</p> <p>enumeration 0206042 documentation andere Gründe</p>
annotation	documentation Kat_EP_GrundWechselTFE
source	<pre> <simpleType name="enum_0206"> <annotation> <documentation>Kat_EP_GrundWechselTFE</documentation> </annotation> <restriction base="xs:string"> <enumeration value="0206001"> <annotation> <documentation>Lockerung</documentation> </annotation> </enumeration> <enumeration value="0206002"> <annotation> <documentation>Infektion, Verdacht auf</documentation> </annotation> </enumeration> <enumeration value="0206003"> <annotation> <documentation>Infektion, gesichert</documentation> </annotation> </enumeration> <enumeration value="0206004"> <annotation> <documentation>Luxation, Inlay aus der Pfanne</documentation> </annotation> </enumeration> <enumeration value="0206005"> <annotation> <documentation>Luxation, Kopf aus Pfanne/Inlay</documentation> </annotation> </enumeration> <enumeration value="0206006"> <annotation> <documentation>Periprothetische Fraktur</documentation> </annotation> </enumeration> <enumeration value="0206007"> <annotation> <documentation>Verschleiß</documentation> </annotation> </enumeration> <enumeration value="0206008"> <annotation> <documentation>Implantatbruch</documentation> </annotation> </enumeration> <enumeration value="0206009"> <annotation> <documentation>Implantatfehllage/Malalignment</documentation> </annotation> </enumeration> </restriction> </simpleType> </pre>

```

<enumeration value="0206010">
  <annotation>
    <documentation>Osteolysen bei festem Implantat</documentation>
  </annotation>
</enumeration>
<enumeration value="0206011">
  <annotation>
    <documentation>Progression der Grunderkrankung</documentation>
  </annotation>
</enumeration>
<enumeration value="0206012">
  <annotation>
    <documentation>ARMD</documentation>
  </annotation>
</enumeration>
<enumeration value="0206013">
  <annotation>
    <documentation>Verdacht auf allergische Reaktion</documentation>
  </annotation>
</enumeration>
<enumeration value="0206014">
  <annotation>
    <documentation>Dislokation/Migration von Komponenten</documentation>
  </annotation>
</enumeration>
<enumeration value="0206015">
  <annotation>
    <documentation>Bandinstabilität</documentation>
  </annotation>
</enumeration>
<enumeration value="0206016">
  <annotation>
    <documentation>Bewegungseinschränkung</documentation>
  </annotation>
</enumeration>
<enumeration value="0206021">
  <annotation>
    <documentation>Zustand nach Prothesenentfernung</documentation>
  </annotation>
</enumeration>
<enumeration value="0206042">
  <annotation>
    <documentation>andere Gründe</documentation>
  </annotation>
</enumeration>
</restriction>
</simpleType>

```

simpleType enum_0210

namespace	http://xml.ir-d.de/irdsa		
type	restriction of string		
properties	base xs:string		
facets	Kind	Value	Annotation
	enumeration	0210001	documentation keine relevante Voroperation
	enumeration	0210002	documentation

	<p>enumeration 0210003 Osteosynthese/Osteotomie (Becken) documentation</p> <p>enumeration 0210004 Osteosynthese/Osteotomie (Femur) documentation</p> <p>enumeration 0210005 Osteosynthese/Osteotomie (beides) documentation</p> <p>enumeration 0210006 Operation bei Hüftkopfnekrose documentation</p> <p>enumeration 0210042 Arthrodese documentation andere</p>
annotation	documentation Kat_EP_VoroperationHuefte
source	<pre> <simpleType name="enum_0210"> <annotation> <documentation>Kat_EP_VoroperationHuefte</documentation> </annotation> <restriction base="xs:string"> <enumeration value="0210001"> <annotation> <documentation>keine relevante Voroperation</documentation> </annotation> </enumeration> <enumeration value="0210002"> <annotation> <documentation>Osteosynthese/Osteotomie (Becken)</documentation> </annotation> </enumeration> <enumeration value="0210003"> <annotation> <documentation>Osteosynthese/Osteotomie (Femur)</documentation> </annotation> </enumeration> <enumeration value="0210004"> <annotation> <documentation>Osteosynthese/Osteotomie (beides)</documentation> </annotation> </enumeration> <enumeration value="0210005"> <annotation> <documentation>Operation bei Hüftkopfnekrose</documentation> </annotation> </enumeration> <enumeration value="0210006"> <annotation> <documentation>Arthrodese</documentation> </annotation> </enumeration> <enumeration value="0210042"> <annotation> <documentation>andere</documentation> </annotation> </enumeration> </restriction> </simpleType> </pre>

simpleType enum_0211

namespace	http://xml.ir-d.de/irdsa		
type	restriction of string		
properties	base xs:string		
facets	Kind	Value	Annotation
	enumeration	0211001	documentation keine relevante Voroperation
	enumeration	0211002	documentation Osteosynthese/Osteotomie (Femur)
	enumeration	0211003	documentation Osteosynthese/Osteotomie (Tibia)
	enumeration	0211004	documentation Osteosynthese/Osteotomie (Patella)
	enumeration	0211005	documentation Osteosynthese/Osteotomie (mehrere)
	enumeration	0211006	documentation Kapsel-/Bandapparat
	enumeration	0211007	documentation Arthrodese
	enumeration	0211042	documentation andere
annotation	documentation Kat_EP_VoroperationKnie		
source	<pre> <simpleType name="enum_0211"> <annotation> <documentation>Kat_EP_VoroperationKnie</documentation> </annotation> <restriction base="xs:string"> <enumeration value="0211001"> <annotation> <documentation>keine relevante Voroperation</documentation> </annotation> </enumeration> <enumeration value="0211002"> <annotation> <documentation>Osteosynthese/Osteotomie (Femur)</documentation> </annotation> </enumeration> <enumeration value="0211003"> <annotation> <documentation>Osteosynthese/Osteotomie (Tibia)</documentation> </annotation> </enumeration> <enumeration value="0211004"> <annotation> <documentation>Osteosynthese/Osteotomie (Patella)</documentation> </annotation> </enumeration> <enumeration value="0211005"> <annotation> <documentation>Osteosynthese/Osteotomie (mehrere)</documentation> </annotation> </enumeration> <enumeration value="0211006"> <annotation> <documentation>Kapsel-/Bandapparat</documentation> </annotation> </enumeration> </restriction> </simpleType> </pre>		

	<pre> <enumeration value="0211007"> <annotation> <documentation>Arthrodesese</documentation> </annotation> </enumeration> <enumeration value="0211042"> <annotation> <documentation>andere</documentation> </annotation> </enumeration> </restriction> </simpleType> </pre>
--	---

simpleType enum_0212

namespace	http://xml.ir-d.de/irdsa		
type	restriction of string		
properties	base xs:string		
facets	Kind	Value	Annotation
	enumeration	0212001	documentation Hüfte
	enumeration	0212002	documentation Knie
	enumeration	0212003	documentation Totaler Femurersatz inkl. Durchsteck-Prothese
annotation	documentation Kat_EP_Gelenk		
source	<pre> <simpleType name="enum_0212"> <annotation> <documentation>Kat_EP_Gelenk</documentation> </annotation> <restriction base="xs:string"> <enumeration value="0212001"> <annotation> <documentation>Hüfte</documentation> </annotation> </enumeration> <enumeration value="0212002"> <annotation> <documentation>Knie</documentation> </annotation> </enumeration> <enumeration value="0212003"> <annotation> <documentation>Totaler Femurersatz inkl. Durchsteck-Prothese</documentation> </annotation> </enumeration> </restriction> </simpleType> </pre>		

simpleType enum_0220

namespace	http://xml.ir-d.de/irdsa
type	restriction of string

properties	base xs:string																								
facets	<table border="1"> <thead> <tr> <th>Kind</th> <th>Value</th> <th>Annotation</th> </tr> </thead> <tbody> <tr> <td>enumeration</td> <td>0220001</td> <td>documentation anterior</td> </tr> <tr> <td>enumeration</td> <td>0220002</td> <td>documentation anterolateral</td> </tr> <tr> <td>enumeration</td> <td>0220003</td> <td>documentation lateral</td> </tr> <tr> <td>enumeration</td> <td>0220004</td> <td>documentation posterior</td> </tr> <tr> <td>enumeration</td> <td>0220005</td> <td>documentation posterolateral</td> </tr> <tr> <td>enumeration</td> <td>0220006</td> <td>documentation 2-Inzisionen-Zugang</td> </tr> <tr> <td>enumeration</td> <td>0220042</td> <td>documentation sonstiges/unbekannt</td> </tr> </tbody> </table>	Kind	Value	Annotation	enumeration	0220001	documentation anterior	enumeration	0220002	documentation anterolateral	enumeration	0220003	documentation lateral	enumeration	0220004	documentation posterior	enumeration	0220005	documentation posterolateral	enumeration	0220006	documentation 2-Inzisionen-Zugang	enumeration	0220042	documentation sonstiges/unbekannt
Kind	Value	Annotation																							
enumeration	0220001	documentation anterior																							
enumeration	0220002	documentation anterolateral																							
enumeration	0220003	documentation lateral																							
enumeration	0220004	documentation posterior																							
enumeration	0220005	documentation posterolateral																							
enumeration	0220006	documentation 2-Inzisionen-Zugang																							
enumeration	0220042	documentation sonstiges/unbekannt																							
annotation	documentation Kat_EP_Operationszugang																								
source	<pre> <simpleType name="enum_0220"> <annotation> <documentation>Kat_EP_Operationszugang</documentation> </annotation> <restriction base="xs:string"> <enumeration value="0220001"> <annotation> <documentation>anterior</documentation> </annotation> </enumeration> <enumeration value="0220002"> <annotation> <documentation>anterolateral</documentation> </annotation> </enumeration> <enumeration value="0220003"> <annotation> <documentation>lateral</documentation> </annotation> </enumeration> <enumeration value="0220004"> <annotation> <documentation>posterior</documentation> </annotation> </enumeration> <enumeration value="0220005"> <annotation> <documentation>posterolateral</documentation> </annotation> </enumeration> <enumeration value="0220006"> <annotation> <documentation>2-Inzisionen-Zugang</documentation> </annotation> </enumeration> <enumeration value="0220042"> <annotation> <documentation>sonstiges/unbekannt</documentation> </annotation> </enumeration> </restriction> </pre>																								

	<code></simpleType></code>
--	----------------------------------

simpleType enum_0222

namespace	http://xml.ir-d.de/irdsa		
type	restriction of string		
properties	base xs:string		
facets	Kind	Value	Annotation
	enumeration	0222001	documentation nein
	enumeration	0222002	documentation ja- Ausbau
	enumeration	0222003	documentation ja- Einbau
annotation	documentation Kat_EP_Zweizeitwechsel		
source	<pre> <simpleType name="enum_0222"> <annotation> <documentation>Kat_EP_Zweizeitwechsel</documentation> </annotation> <restriction base="xs:string"> <enumeration value="0222001"> <annotation> <documentation>nein</documentation> </annotation> </enumeration> <enumeration value="0222002"> <annotation> <documentation>ja- Ausbau</documentation> </annotation> </enumeration> <enumeration value="0222003"> <annotation> <documentation>ja- Einbau</documentation> </annotation> </enumeration> </restriction> </simpleType> </pre>		

simpleType enum_0230

namespace	http://xml.ir-d.de/irdsa		
type	restriction of string		
properties	base xs:string		
facets	Kind	Value	Annotation
	enumeration	0230001	documentation Smith & Nephew GmbH
	enumeration	0230002	documentation Mathys Orthopädie GmbH
	enumeration	0230003	documentation Ceramtec AG
	enumeration	0230004	documentation Biomet
	enumeration	0230005	documentation Peter Brehm GmbH

enumeration	0230006	documentation Amplitude GmbH
enumeration	0230007	documentation Exactech Deutschland
enumeration	0230008	documentation Globus Medical
enumeration	0230009	documentation Implantcast GmbH
enumeration	0230010	documentation DePuy Orthopädie GmbH
enumeration	0230011	documentation IO-International Orthopaedics
enumeration	0230012	documentation Joint Replacement Ltd. Instrumentation
enumeration	0230013	documentation Merete
enumeration	0230014	documentation S&G Implants GmbH
enumeration	0230015	documentation Speetec Implantate GmbH
enumeration	0230016	documentation Stemcup Medical Products GmbH
enumeration	0230017	documentation Symbios Deutschland GmbH
enumeration	0230018	documentation Tantum AG
enumeration	0230019	documentation Tornier GmbH
enumeration	0230020	documentation MicroPort Orthopedics GmbH
enumeration	0230021	documentation aap Implanate AG
enumeration	0230022	documentation AQImplants
enumeration	0230023	documentation ESKA Orthodynamics GmbH
enumeration	0230024	documentation Ateos medical AG
enumeration	0230025	documentation Chiropro GmbH
enumeration	0230026	documentation Medacta
enumeration	0230027	documentation OHST Medizintechnik AG
enumeration	0230028	documentation Lima Deutschland GmbH
enumeration	0230029	documentation alloPlus GmbH
enumeration	0230030	documentation Heraeus Medical GmbH
enumeration	0230031	documentation ImplanTec Deutschland GmbH
enumeration	0230032	documentation Falcon Medical GmbH
enumeration	0230033	documentation Meril GmbH
enumeration	0230034	documentation Zimmer Germany GmbH
enumeration	0230035	documentation Stryker GmbH & Co. KG
enumeration	0230036	documentation Aesculap AG
enumeration	0230037	documentation Waldemar Link GmbH & Co. KG
enumeration	0230038	documentation

	<p>enumeration 0230039 Corin Germany GmbH documentation nicht belegter Wert</p> <p>enumeration 0230040 documentation nicht belegter Wert</p> <p>enumeration 0230041 documentation nicht belegter Wert</p> <p>enumeration 0230042 documentation sonstige</p> <p>enumeration 0230043 documentation nicht belegter Wert</p> <p>enumeration 0230044 documentation nicht belegter Wert</p>
annotation	documentation Kat_EP_Hersteller
source	<pre> <simpleType name="enum_0230"> <annotation> <documentation>Kat_EP_Hersteller</documentation> </annotation> <restriction base="xs:string"> <enumeration value="0230001"> <annotation> <documentation>Smith & Nephew GmbH</documentation> </annotation> </enumeration> <enumeration value="0230002"> <annotation> <documentation>Mathys Orthopädie GmbH</documentation> </annotation> </enumeration> <enumeration value="0230003"> <annotation> <documentation>Ceramtec AG</documentation> </annotation> </enumeration> <enumeration value="0230004"> <annotation> <documentation>Biomet</documentation> </annotation> </enumeration> <enumeration value="0230005"> <annotation> <documentation>Peter Brehm GmbH</documentation> </annotation> </enumeration> <enumeration value="0230006"> <annotation> <documentation>Amplitude GmbH</documentation> </annotation> </enumeration> <enumeration value="0230007"> <annotation> <documentation>Exactech Deutschland</documentation> </annotation> </enumeration> <enumeration value="0230008"> <annotation> <documentation>Globus Medical</documentation> </annotation> </enumeration> </restriction> </simpleType> </pre>

```
<enumeration value="0230009">
  <annotation>
    <documentation>Implantcast GmbH</documentation>
  </annotation>
</enumeration>
<enumeration value="0230010">
  <annotation>
    <documentation>DePuy Orthopädie GmbH</documentation>
  </annotation>
</enumeration>
<enumeration value="0230011">
  <annotation>
    <documentation>IO-International Orthopaedics</documentation>
  </annotation>
</enumeration>
<enumeration value="0230012">
  <annotation>
    <documentation>Joint Replacement Ltd. Instrumentation</documentation>
  </annotation>
</enumeration>
<enumeration value="0230013">
  <annotation>
    <documentation>Merete</documentation>
  </annotation>
</enumeration>
<enumeration value="0230014">
  <annotation>
    <documentation>S&G Implants GmbH</documentation>
  </annotation>
</enumeration>
<enumeration value="0230015">
  <annotation>
    <documentation>Speetec Implantate GmbH</documentation>
  </annotation>
</enumeration>
<enumeration value="0230016">
  <annotation>
    <documentation>Stemcup Medical Products GmbH</documentation>
  </annotation>
</enumeration>
<enumeration value="0230017">
  <annotation>
    <documentation>Symbios Deutschland GmbH</documentation>
  </annotation>
</enumeration>
<enumeration value="0230018">
  <annotation>
    <documentation>Tantum AG</documentation>
  </annotation>
</enumeration>
<enumeration value="0230019">
  <annotation>
    <documentation>Tornier GmbH</documentation>
  </annotation>
</enumeration>
<enumeration value="0230020">
  <annotation>
    <documentation>MicroPort Orthopedics GmbH</documentation>
  </annotation>
</enumeration>
```



```
</enumeration>
<enumeration value="0230021">
  <annotation>
    <documentation>aap Implanate AG</documentation>
  </annotation>
</enumeration>
<enumeration value="0230022">
  <annotation>
    <documentation>AQImplants</documentation>
  </annotation>
</enumeration>
<enumeration value="0230023">
  <annotation>
    <documentation>ESKA Orthodynamics GmbH</documentation>
  </annotation>
</enumeration>
<enumeration value="0230024">
  <annotation>
    <documentation>Atecos medical AG</documentation>
  </annotation>
</enumeration>
<enumeration value="0230025">
  <annotation>
    <documentation>Chiropro GmbH</documentation>
  </annotation>
</enumeration>
<enumeration value="0230026">
  <annotation>
    <documentation>Medacta</documentation>
  </annotation>
</enumeration>
<enumeration value="0230027">
  <annotation>
    <documentation>OHST Medizintechnik AG</documentation>
  </annotation>
</enumeration>
<enumeration value="0230028">
  <annotation>
    <documentation>Lima Deutschland GmbH</documentation>
  </annotation>
</enumeration>
<enumeration value="0230029">
  <annotation>
    <documentation>alloPlus GmbH</documentation>
  </annotation>
</enumeration>
<enumeration value="0230030">
  <annotation>
    <documentation>Heraeus Medical GmbH</documentation>
  </annotation>
</enumeration>
<enumeration value="0230031">
  <annotation>
    <documentation>ImplanTec Deutschland GmbH</documentation>
  </annotation>
</enumeration>
<enumeration value="0230032">
  <annotation>
    <documentation>Falcon Medical GmbH</documentation>
  </annotation>
</enumeration>
```

```
</annotation>
</enumeration>
<enumeration value="0230033">
  <annotation>
    <documentation>Meril GmbH</documentation>
  </annotation>
</enumeration>
<enumeration value="0230034">
  <annotation>
    <documentation>Zimmer Germany GmbH</documentation>
  </annotation>
</enumeration>
<enumeration value="0230035">
  <annotation>
    <documentation>Stryker GmbH & Co. KG</documentation>
  </annotation>
</enumeration>
<enumeration value="0230036">
  <annotation>
    <documentation>Aesculap AG</documentation>
  </annotation>
</enumeration>
<enumeration value="0230037">
  <annotation>
    <documentation>Waldemar Link GmbH & Co. KG</documentation>
  </annotation>
</enumeration>
<enumeration value="0230038">
  <annotation>
    <documentation>Corin Germany GmbH</documentation>
  </annotation>
</enumeration>
<enumeration value="0230039">
  <annotation>
    <documentation>nicht belegter Wert</documentation>
  </annotation>
</enumeration>
<enumeration value="0230040">
  <annotation>
    <documentation>nicht belegter Wert</documentation>
  </annotation>
</enumeration>
<enumeration value="0230041">
  <annotation>
    <documentation>nicht belegter Wert</documentation>
  </annotation>
</enumeration>
<enumeration value="0230042">
  <annotation>
    <documentation>sonstige</documentation>
  </annotation>
</enumeration>
<enumeration value="0230043">
  <annotation>
    <documentation>nicht belegter Wert</documentation>
  </annotation>
</enumeration>
<enumeration value="0230044">
  <annotation>
```

	<pre> <documentation>nicht belegter Wert</documentation> </annotation> </enumeration> </restriction> </simpleType> </pre>
--	---

simpleType enum_0252

namespace	http://xml.ir-d.de/irdsa		
type	restriction of string		
properties	base xs:string		
facets	Kind	Value	Annotation
	enumeration	0252001	documentation Pfanne
	enumeration	0252002	documentation Schaft
	enumeration	0252003	documentation beides
annotation	documentation Kat_EP_KomponenteHuefte		
source	<pre> <simpleType name="enum_0252"> <annotation> <documentation>Kat_EP_KomponenteHuefte</documentation> </annotation> <restriction base="xs:string"> <enumeration value="0252001"> <annotation> <documentation>Pfanne</documentation> </annotation> </enumeration> <enumeration value="0252002"> <annotation> <documentation>Schaft</documentation> </annotation> </enumeration> <enumeration value="0252003"> <annotation> <documentation>beides</documentation> </annotation> </enumeration> </restriction> </simpleType> </pre>		

simpleType enum_0254

namespace	http://xml.ir-d.de/irdsa		
type	restriction of string		
properties	base xs:string		
facets	Kind	Value	Annotation
	enumeration	0254001	documentation Femur
	enumeration	0254002	documentation Tibia
	enumeration	0254003	documentation Patella

	enumeration 0254004 documentation mehrere
annotation	documentation Kat_EP_KomponenteKnie
source	<pre> <simpleType name="enum_0254"> <annotation> <documentation>Kat_EP_KomponenteKnie</documentation> </annotation> <restriction base="xs:string"> <enumeration value="0254001"> <annotation> <documentation>Femur</documentation> </annotation> </enumeration> <enumeration value="0254002"> <annotation> <documentation>Tibia</documentation> </annotation> </enumeration> <enumeration value="0254003"> <annotation> <documentation>Patella</documentation> </annotation> </enumeration> <enumeration value="0254004"> <annotation> <documentation>mehrere</documentation> </annotation> </enumeration> </restriction> </simpleType> </pre>

simpleType enum_0256

namespace	http://xml.ir-d.de/irdsa		
type	restriction of string		
properties	base xs:string		
facets	Kind	Value	Annotation
	enumeration	0256001	documentation Pfanne
	enumeration	0256002	documentation Schaft
	enumeration	0256003	documentation Pfanne und Schaft
	enumeration	0256004	documentation Femur
	enumeration	0256005	documentation Tibia
	enumeration	0256006	documentation Patella
	enumeration	0256007	documentation mehrere
annotation	documentation Kat_EP_KomponenteTFE		
source	<pre> <simpleType name="enum_0256"> <annotation> <documentation>Kat_EP_KomponenteTFE</documentation> </pre>		

```

</annotation>
<restriction base="xs:string">
  <enumeration value="0256001">
    <annotation>
      <documentation>Pfanne</documentation>
    </annotation>
  </enumeration>
  <enumeration value="0256002">
    <annotation>
      <documentation>Schaft</documentation>
    </annotation>
  </enumeration>
  <enumeration value="0256003">
    <annotation>
      <documentation>Pfanne und Schaft</documentation>
    </annotation>
  </enumeration>
  <enumeration value="0256004">
    <annotation>
      <documentation>Femur</documentation>
    </annotation>
  </enumeration>
  <enumeration value="0256005">
    <annotation>
      <documentation>Tibia</documentation>
    </annotation>
  </enumeration>
  <enumeration value="0256006">
    <annotation>
      <documentation>Patella</documentation>
    </annotation>
  </enumeration>
  <enumeration value="0256007">
    <annotation>
      <documentation>mehrere</documentation>
    </annotation>
  </enumeration>
</restriction>
</simpleType>

```

simpleType enum 0262

namespace	http://xml.ir-d.de/irdsa		
type	restriction of string		
properties	base xs:string		
facets	Kind	Value	Annotation
	enumeration	0262001	documentation Pfanne
	enumeration	0262002	documentation Schaft
	enumeration	0262003	documentation Kopf
	enumeration	0262004	documentation Inlay
	enumeration	0262005	documentation Adapter
	enumeration	0262006	documentation

	mehrere
annotation	documentation Kat_EP_ImplantatbruchHuefte
source	<pre> <simpleType name="enum_0262"> <annotation> <documentation>Kat_EP_ImplantatbruchHuefte</documentation> </annotation> <restriction base="xs:string"> <enumeration value="0262001"> <annotation> <documentation>Pfanne</documentation> </annotation> </enumeration> <enumeration value="0262002"> <annotation> <documentation>Schaft</documentation> </annotation> </enumeration> <enumeration value="0262003"> <annotation> <documentation>Kopf</documentation> </annotation> </enumeration> <enumeration value="0262004"> <annotation> <documentation>Inlay</documentation> </annotation> </enumeration> <enumeration value="0262005"> <annotation> <documentation>Adapter</documentation> </annotation> </enumeration> <enumeration value="0262006"> <annotation> <documentation>mehrere</documentation> </annotation> </enumeration> </restriction> </simpleType> </pre>

simpleType enum_0264

namespace	http://xml.ir-d.de/irdsa		
type	restriction of string		
properties	base xs:string		
facets	Kind	Value	Annotation
	enumeration	0264001	documentation Femur
	enumeration	0264002	documentation Tibia
	enumeration	0264003	documentation Inlay
	enumeration	0264004	documentation Adapter
	enumeration	0264005	documentation Verlängerung

	enumeration 0264006 documentation Schrauben enumeration 0264007 documentation mehrere enumeration 0264042 documentation andere
annotation	documentation Kat_EP_ImplantatbruchKnie
source	<pre> <simpleType name="enum_0264"> <annotation> <documentation>Kat_EP_ImplantatbruchKnie</documentation> </annotation> <restriction base="xs:string"> <enumeration value="0264001"> <annotation> <documentation>Femur</documentation> </annotation> </enumeration> <enumeration value="0264002"> <annotation> <documentation>Tibia</documentation> </annotation> </enumeration> <enumeration value="0264003"> <annotation> <documentation>Inlay</documentation> </annotation> </enumeration> <enumeration value="0264004"> <annotation> <documentation>Adapter</documentation> </annotation> </enumeration> <enumeration value="0264005"> <annotation> <documentation>Verlängerung</documentation> </annotation> </enumeration> <enumeration value="0264006"> <annotation> <documentation>Schrauben</documentation> </annotation> </enumeration> <enumeration value="0264007"> <annotation> <documentation>mehrere</documentation> </annotation> </enumeration> <enumeration value="0264042"> <annotation> <documentation>andere</documentation> </annotation> </enumeration> </restriction> </simpleType> </pre>

simpleType enum_0266

namespace	http://xml.ir-d.de/irdsa		
type	restriction of string		
properties	base xs:string		
facets	Kind	Value	Annotation
	enumeration	0266001	documentation Pfanne
	enumeration	0266002	documentation Schaft
	enumeration	0266003	documentation Kopf
	enumeration	0266004	documentation Inlay
	enumeration	0266005	documentation Adapter
	enumeration	0266006	documentation Femur
	enumeration	0266007	documentation Tibia
	enumeration	0266008	documentation Verlängerung
	enumeration	0266009	documentation Schrauben
	enumeration	0266010	documentation mehrere
	enumeration	0266042	documentation andere
annotation	documentation Kat_EP_ImplantatbruchTFE		
source	<pre> <simpleType name="enum_0266"> <annotation> <documentation>Kat_EP_ImplantatbruchTFE</documentation> </annotation> <restriction base="xs:string"> <enumeration value="0266001"> <annotation> <documentation>Pfanne</documentation> </annotation> </enumeration> <enumeration value="0266002"> <annotation> <documentation>Schaft</documentation> </annotation> </enumeration> <enumeration value="0266003"> <annotation> <documentation>Kopf</documentation> </annotation> </enumeration> <enumeration value="0266004"> <annotation> <documentation>Inlay</documentation> </annotation> </enumeration> <enumeration value="0266005"> <annotation> <documentation>Adapter</documentation> </annotation> </enumeration> </restriction> </pre>		

	<pre> <enumeration value="0266006"> <annotation> <documentation>Femur</documentation> </annotation> </enumeration> <enumeration value="0266007"> <annotation> <documentation>Tibia</documentation> </annotation> </enumeration> <enumeration value="0266008"> <annotation> <documentation>Verlängerung</documentation> </annotation> </enumeration> <enumeration value="0266009"> <annotation> <documentation>Schrauben</documentation> </annotation> </enumeration> <enumeration value="0266010"> <annotation> <documentation>mehrere</documentation> </annotation> </enumeration> <enumeration value="0266042"> <annotation> <documentation>andere</documentation> </annotation> </enumeration> </restriction> </simpleType> </pre>
--	---

simpleType enum_0270

namespace	http://xml.ir-d.de/irdsa		
type	restriction of string		
properties	base xs:string		
facets	Kind	Value	Annotation
	enumeration	0270001	documentation PE-Inlay
	enumeration	0270002	documentation patellare Komponente
	enumeration	0270003	documentation beides
annotation	documentation Kat_EP_VerschleissKnie		
source	<pre> <simpleType name="enum_0270"> <annotation> <documentation>Kat_EP_VerschleissKnie</documentation> </annotation> <restriction base="xs:string"> <enumeration value="0270001"> <annotation> <documentation>PE-Inlay</documentation> </annotation> </enumeration> </pre>		

	<pre> <enumeration value="0270002"> <annotation> <documentation>patellare Komponente</documentation> </annotation> </enumeration> <enumeration value="0270003"> <annotation> <documentation>beides</documentation> </annotation> </enumeration> </restriction> </simpleType> </pre>
--	---

simpleType enum_0271

namespace	http://xml.ir-d.de/irdsa		
type	restriction of string		
properties	base xs:string		
facets	Kind	Value	Annotation
	enumeration	0271001	documentation Schraube
	enumeration	0271002	documentation Inlay
	enumeration	0271003	documentation patellare Komponente
	enumeration	0271004	documentation Kopplung
	enumeration	0271005	documentation mehrere
	enumeration	0271042	documentation andere
annotation	documentation Kat_EP_MigrationKnie		
source	<pre> <simpleType name="enum_0271"> <annotation> <documentation>Kat_EP_MigrationKnie</documentation> </annotation> <restriction base="xs:string"> <enumeration value="0271001"> <annotation> <documentation>Schraube</documentation> </annotation> </enumeration> <enumeration value="0271002"> <annotation> <documentation>Inlay</documentation> </annotation> </enumeration> <enumeration value="0271003"> <annotation> <documentation>patellare Komponente</documentation> </annotation> </enumeration> <enumeration value="0271004"> <annotation> <documentation>Kopplung</documentation> </annotation> </pre>		

	<pre> </enumeration> <enumeration value="0271005"> <annotation> <documentation>mehrere</documentation> </annotation> </enumeration> <enumeration value="0271042"> <annotation> <documentation>andere</documentation> </annotation> </enumeration> </restriction> </simpleType> </pre>
--	---

simpleType enum_0290

namespace	http://xml.ir-d.de/irdsa		
type	restriction of string		
properties	base xs:string		
facets	Kind	Value	Annotation
	enumeration	0290001	documentation Hüft-Komponente
	enumeration	0290002	documentation Knie-Komponente
	enumeration	0290003	documentation Modulare Komponente (Hüfte/Knie)
annotation	documentation Kat_EP_Artikeltyp		
source	<pre> <simpleType name="enum_0290"> <annotation> <documentation>Kat_EP_Artikeltyp</documentation> </annotation> <restriction base="xs:string"> <enumeration value="0290001"> <annotation> <documentation>Hüft-Komponente</documentation> </annotation> </enumeration> <enumeration value="0290002"> <annotation> <documentation>Knie-Komponente</documentation> </annotation> </enumeration> <enumeration value="0290003"> <annotation> <documentation>Modulare Komponente (Hüfte/Knie)</documentation> </annotation> </enumeration> </restriction> </simpleType> </pre>		

simpleType enum_0291

namespace	http://xml.ir-d.de/irdsa
type	restriction of string

properties	base xs:string									
facets	<table border="1"> <thead> <tr> <th>Kind</th> <th>Value</th> <th>Annotation</th> </tr> </thead> <tbody> <tr> <td>enumeration</td> <td>0291001</td> <td>documentation Knochen-Zement</td> </tr> <tr> <td>enumeration</td> <td>0291002</td> <td>documentation sonstiges Zubehör</td> </tr> </tbody> </table>	Kind	Value	Annotation	enumeration	0291001	documentation Knochen-Zement	enumeration	0291002	documentation sonstiges Zubehör
Kind	Value	Annotation								
enumeration	0291001	documentation Knochen-Zement								
enumeration	0291002	documentation sonstiges Zubehör								
annotation	documentation Kat_EP_ZubehoerTyp									
source	<pre><simpleType name="enum_0291"> <annotation> <documentation>Kat_EP_ZubehoerTyp</documentation> </annotation> <restriction base="xs:string"> <enumeration value="0291001"> <annotation> <documentation>Knochen-Zement</documentation> </annotation> </enumeration> <enumeration value="0291002"> <annotation> <documentation>sonstiges Zubehör</documentation> </annotation> </enumeration> </restriction> </simpleType></pre>									

simpleType enum_0300

namespace	http://xml.ir-d.de/irdsa									
type	restriction of string									
properties	base xs:string									
facets	<table border="1"> <thead> <tr> <th>Kind</th> <th>Value</th> <th>Annotation</th> </tr> </thead> <tbody> <tr> <td>enumeration</td> <td>0300001</td> <td>documentation konventioneller Aortenklappenersatz</td> </tr> <tr> <td>enumeration</td> <td>0300002</td> <td>documentation kathetergestützte Aortenklappenimplantation (TAVI)</td> </tr> </tbody> </table>	Kind	Value	Annotation	enumeration	0300001	documentation konventioneller Aortenklappenersatz	enumeration	0300002	documentation kathetergestützte Aortenklappenimplantation (TAVI)
Kind	Value	Annotation								
enumeration	0300001	documentation konventioneller Aortenklappenersatz								
enumeration	0300002	documentation kathetergestützte Aortenklappenimplantation (TAVI)								
annotation	documentation Kat_AK_ArtEingriff									
source	<pre><simpleType name="enum_0300"> <annotation> <documentation>Kat_AK_ArtEingriff</documentation> </annotation> <restriction base="xs:string"> <enumeration value="0300001"> <annotation> <documentation>konventioneller Aortenklappenersatz</documentation> </annotation> </enumeration> <enumeration value="0300002"> <annotation> <documentation>kathetergestützte Aortenklappenimplantation (TAVI)</documentation> </annotation> </enumeration> </restriction> </simpleType></pre>									

simpleType enum 0302

namespace	http://xml.ir-d.de/irdsa		
type	restriction of string		
properties	base xs:string		
facets	Kind	Value	Annotation
	enumeration	0302001	documentation Stenose
	enumeration	0302002	documentation Insuffizienz
	enumeration	0302003	documentation Stenose und Insuffizienz
annotation	documentation Kat_AK_GrundEingriff		
source	<pre> <simpleType name="enum_0302"> <annotation> <documentation>Kat_AK_GrundEingriff</documentation> </annotation> <restriction base="xs:string"> <enumeration value="0302001"> <annotation> <documentation>Stenose</documentation> </annotation> </enumeration> <enumeration value="0302002"> <annotation> <documentation>Insuffizienz</documentation> </annotation> </enumeration> <enumeration value="0302003"> <annotation> <documentation>Stenose und Insuffizienz</documentation> </annotation> </enumeration> </restriction> </simpleType> </pre>		

simpleType enum 0318

namespace	http://xml.ir-d.de/irdsa		
type	restriction of string		
properties	base xs:string		
facets	Kind	Value	Annotation
	enumeration	0318001	documentation transapikal
	enumeration	0318002	documentation transaortal
	enumeration	0318003	documentation transfemoral
	enumeration	0318004	documentation transaxillär
	enumeration	0318042	documentation anderer Zugangsweg
annotation	documentation Kat_AK_ZugangKatheter		

source	<pre> <simpleType name="enum_0318"> <annotation> <documentation>Kat_AK_ZugangKatheter</documentation> </annotation> <restriction base="xs:string"> <enumeration value="0318001"> <annotation> <documentation>transapikal</documentation> </annotation> </enumeration> <enumeration value="0318002"> <annotation> <documentation>transaortal</documentation> </annotation> </enumeration> <enumeration value="0318003"> <annotation> <documentation>transfemorale</documentation> </annotation> </enumeration> <enumeration value="0318004"> <annotation> <documentation>transaxillär</documentation> </annotation> </enumeration> <enumeration value="0318042"> <annotation> <documentation>anderer Zugangsweg</documentation> </annotation> </enumeration> </restriction> </simpleType> </pre>
--------	---

simpleType enum_0320

namespace	http://xml.ir-d.de/irdsa		
type	restriction of string		
properties	base xs:string		
facets	Kind	Value	Annotation
	enumeration	0320001	documentation konventionelle Sternotomie
	enumeration	0320002	documentation partielle Sternotomie
	enumeration	0320003	documentation parasternaler Zugang
	enumeration	0320042	documentation anderer Zugangsweg
annotation	documentation Kat_AK_ZugangKonventionell		
source	<pre> <simpleType name="enum_0320"> <annotation> <documentation>Kat_AK_ZugangKonventionell</documentation> </annotation> <restriction base="xs:string"> <enumeration value="0320001"> <annotation> <documentation>konventionelle Sternotomie</documentation> </pre>		

	<pre> </annotation> </enumeration> <enumeration value="0320002"> <annotation> <documentation>partielle Sternotomie</documentation> </annotation> </enumeration> <enumeration value="0320003"> <annotation> <documentation>parasternaler Zugang</documentation> </annotation> </enumeration> <enumeration value="0320042"> <annotation> <documentation>anderer Zugangsweg</documentation> </annotation> </enumeration> </restriction> </simpleType> </pre>
--	---

simpleType enum 0322

namespace	http://xml.ir-d.de/irdsa		
type	restriction of string		
properties	base xs:string		
facets	Kind	Value	Annotation
	enumeration	0322001	documentation nein
	enumeration	0322002	documentation ja, diätetisch behandelt
	enumeration	0322003	documentation ja, orale Medikation
	enumeration	0322004	documentation ja, mit Insulin behandelt
	enumeration	0322005	documentation ja, unbehandelt
	enumeration	0322099	documentation unbekannt
annotation	documentation Kat_AK_Diabetes		
source	<pre> <simpleType name="enum_0322"> <annotation> <documentation>Kat_AK_Diabetes</documentation> </annotation> <restriction base="xs:string"> <enumeration value="0322001"> <annotation> <documentation>nein</documentation> </annotation> </enumeration> <enumeration value="0322002"> <annotation> <documentation>ja, diätetisch behandelt</documentation> </annotation> </enumeration> <enumeration value="0322003"> <annotation> </pre>		

	<pre> <documentation>ja, orale Medikation</documentation> </annotation> </enumeration> <enumeration value="0322004"> <annotation> <documentation>ja, mit Insulin behandelt</documentation> </annotation> </enumeration> <enumeration value="0322005"> <annotation> <documentation>ja, unbehandelt</documentation> </annotation> </enumeration> <enumeration value="0322099"> <annotation> <documentation>unbekannt</documentation> </annotation> </enumeration> </restriction> </simpleType> </pre>
--	---

simpleType enum_0324

namespace	http://xml.ir-d.de/irdsa		
type	restriction of string		
properties	base xs:string		
facets	Kind	Value	Annotation
	enumeration	0324001	documentation (I): Beschwerdefreiheit, normale körperliche Belastbarkeit
	enumeration	0324002	documentation (II): Beschwerden bei stärkerer körperlicher Belastung
	enumeration	0324003	documentation (III): Beschwerden bei leichter körperlicher Belastung
	enumeration	0324004	documentation (IV): Beschwerden in Ruhe
annotation	documentation Kat_AK_NYHA		
source	<pre> <simpleType name="enum_0324"> <annotation> <documentation>Kat_AK_NYHA</documentation> </annotation> <restriction base="xs:string"> <enumeration value="0324001"> <annotation> <documentation>(I): Beschwerdefreiheit, normale körperliche Belastbarkeit</documentation> </annotation> </enumeration> <enumeration value="0324002"> <annotation> <documentation>(II): Beschwerden bei stärkerer körperlicher Belastung</documentation> </annotation> </enumeration> <enumeration value="0324003"> <annotation> <documentation>(III): Beschwerden bei leichter körperlicher </pre>		

	<pre> Belastung</documentation> </annotation> </enumeration> <enumeration value="0324004"> <annotation> <documentation>(IV): Beschwerden in Ruhe</documentation> </annotation> </enumeration> </restriction> </simpleType> </pre>
--	---

simpleType enum_0330

namespace	http://xml.ir-d.de/irdsa		
type	restriction of string		
properties	base xs:string		
facets	Kind	Value	Annotation
	enumeration	0330001	documentation ATS Medical
	enumeration	0330002	documentation Edwards Lifesciences
	enumeration	0330003	documentation Medtronic
	enumeration	0330004	documentation JenaValve
	enumeration	0330005	documentation Corcym
	enumeration	0330006	documentation StJude Medical/Abbott
	enumeration	0330007	documentation Symetis
	enumeration	0330008	documentation Direct Flow Medical
	enumeration	0330009	documentation Boston Scientific
	enumeration	0330010	documentation nicht belegter Wert
	enumeration	0330011	documentation nicht belegter Wert
	enumeration	0330012	documentation nicht belegter Wert
	enumeration	0330013	documentation nicht belegter Wert
	enumeration	0330014	documentation nicht belegter Wert
	enumeration	0330042	documentation sonstiger Hersteller
annotation	documentation Kat_AK_Hersteller		
source	<pre> <simpleType name="enum_0330"> <annotation> <documentation>Kat_AK_Hersteller</documentation> </annotation> <restriction base="xs:string"> <enumeration value="0330001"> <annotation> <documentation>ATS Medical</documentation> </annotation> </enumeration> </pre>		

```
<enumeration value="0330002">
  <annotation>
    <documentation>Edwards Lifesciences</documentation>
  </annotation>
</enumeration>
<enumeration value="0330003">
  <annotation>
    <documentation>Medtronic</documentation>
  </annotation>
</enumeration>
<enumeration value="0330004">
  <annotation>
    <documentation>JenaValve</documentation>
  </annotation>
</enumeration>
<enumeration value="0330005">
  <annotation>
    <documentation>Corcym</documentation>
  </annotation>
</enumeration>
<enumeration value="0330006">
  <annotation>
    <documentation>St.Jude Medical/Abbott</documentation>
  </annotation>
</enumeration>
<enumeration value="0330007">
  <annotation>
    <documentation>Symetis</documentation>
  </annotation>
</enumeration>
<enumeration value="0330008">
  <annotation>
    <documentation>Direct Flow Medical</documentation>
  </annotation>
</enumeration>
<enumeration value="0330009">
  <annotation>
    <documentation>Boston Scientific</documentation>
  </annotation>
</enumeration>
<enumeration value="0330010">
  <annotation>
    <documentation>nicht belegter Wert</documentation>
  </annotation>
</enumeration>
<enumeration value="0330011">
  <annotation>
    <documentation>nicht belegter Wert</documentation>
  </annotation>
</enumeration>
<enumeration value="0330012">
  <annotation>
    <documentation>nicht belegter Wert</documentation>
  </annotation>
</enumeration>
<enumeration value="0330013">
  <annotation>
    <documentation>nicht belegter Wert</documentation>
  </annotation>
</enumeration>
```

	<pre> </enumeration> <enumeration value="0330014"> <annotation> <documentation>nicht belegter Wert</documentation> </annotation> </enumeration> <enumeration value="0330042"> <annotation> <documentation>sonstiger Hersteller</documentation> </annotation> </enumeration> </restriction> </simpleType> </pre>
--	---

simpleType enum_0338

namespace	http://xml.ir-d.de/irdsa		
type	restriction of string		
properties	base xs:string		
facets	Kind	Value	Annotation
	enumeration	0338001	documentation LAD
	enumeration	0338002	documentation RCA
	enumeration	0338003	documentation RCX
	enumeration	0338004	documentation Hauptstamm
annotation	documentation Kat_AK_PCIArterien		
source	<pre> <simpleType name="enum_0338"> <annotation> <documentation>Kat_AK_PCIArterien</documentation> </annotation> <restriction base="xs:string"> <enumeration value="0338001"> <annotation> <documentation>LAD</documentation> </annotation> </enumeration> <enumeration value="0338002"> <annotation> <documentation>RCA</documentation> </annotation> </enumeration> <enumeration value="0338003"> <annotation> <documentation>RCX</documentation> </annotation> </enumeration> <enumeration value="0338004"> <annotation> <documentation>Hauptstamm</documentation> </annotation> </enumeration> </restriction> </simpleType> </pre>		

simpleType enum 0339

namespace	http://xml.ir-d.de/irdsa		
type	restriction of string		
properties	base xs:string		
facets	Kind	Value	Annotation
	enumeration	0339001	documentation TEE
	enumeration	0339002	documentation CT
	enumeration	0339042	documentation andere
annotation	documentation Kat_AK_AnnulusMessmethode		
source	<pre> <simpleType name="enum_0339"> <annotation> <documentation>Kat_AK_AnnulusMessmethode</documentation> </annotation> <restriction base="xs:string"> <enumeration value="0339001"> <annotation> <documentation>TEE</documentation> </annotation> </enumeration> <enumeration value="0339002"> <annotation> <documentation>CT</documentation> </annotation> </enumeration> <enumeration value="0339042"> <annotation> <documentation>andere</documentation> </annotation> </enumeration> </restriction> </simpleType> </pre>		

simpleType enum 0341

namespace	http://xml.ir-d.de/irdsa		
type	restriction of string		
properties	base xs:string		
facets	Kind	Value	Annotation
	enumeration	0341001	documentation intraprozedural verstorben
	enumeration	0341002	documentation Implantation von mehr als einer Prothese
	enumeration	0341003	documentation gravierende Gefäß- oder Zugangskomplikation (gemäß VARC-3)
	enumeration	0341004	documentation erforderlicher chirurgischer oder interventioneller Eingriff wegen einer Klappenfehlfunktion (gemäß VARC-3)
	enumeration	0341005	documentation >= große strukturelle kardiale Komplikation (gemäß VARC-3)

annotation	documentation Kat_AK_FailureGrund
source	<pre> <simpleType name="enum_0341"> <annotation> <documentation>Kat_AK_FailureGrund</documentation> </annotation> <restriction base="xs:string"> <enumeration value="0341001"> <annotation> <documentation>intraprozedural verstorben</documentation> </annotation> </enumeration> <enumeration value="0341002"> <annotation> <documentation>Implantation von mehr als einer Prothese</documentation> </annotation> </enumeration> <enumeration value="0341003"> <annotation> <documentation>gravierende Gefäß- oder Zugangskomplikation (gemäß VARC-3)</documentation> </annotation> </enumeration> <enumeration value="0341004"> <annotation> <documentation>erforderlicher chirurgischer oder interventioneller Eingriff wegen einer Klappenfehlfunktion (gemäß VARC-3)</documentation> </annotation> </enumeration> <enumeration value="0341005"> <annotation> <documentation>&gt;= große strukturelle kardiale Komplikation (gemäß VARC-3)</documentation> </annotation> </enumeration> </restriction> </simpleType> </pre>

simpleType enum_0342

namespace	http://xml.ir-d.de/irdsa		
type	restriction of string		
properties	base xs:string		
facets	Kind	Value	Annotation
	enumeration	0342001	documentation Alter
	enumeration	0342002	documentation Frailty
	enumeration	0342003	documentation Hochrisiko
	enumeration	0342004	documentation Prognose-limitierende Zweiterkrankung
	enumeration	0342005	documentation Porzellan-Aorta
	enumeration	0342042	documentation Sonstige
annotation	documentation		

	Kat_AK_Tavi
source	<pre> <simpleType name="enum_0342"> <annotation> <documentation>Kat_AK_Tavi</documentation> </annotation> <restriction base="xs:string"> <enumeration value="0342001"> <annotation> <documentation>Alter</documentation> </annotation> </enumeration> <enumeration value="0342002"> <annotation> <documentation>Frailty</documentation> </annotation> </enumeration> <enumeration value="0342003"> <annotation> <documentation>Hochrisiko</documentation> </annotation> </enumeration> <enumeration value="0342004"> <annotation> <documentation>Prognose-limitierende Zweiterkrankung</documentation> </annotation> </enumeration> <enumeration value="0342005"> <annotation> <documentation>Porzellan-Aorta</documentation> </annotation> </enumeration> <enumeration value="0342042"> <annotation> <documentation>Sonstige</documentation> </annotation> </enumeration> </restriction> </simpleType> </pre>

simpleType enum_0343

namespace	http://xml.ir-d.de/irdsa		
type	restriction of string		
properties	base	xs:string	
facets	Kind	Value	Annotation
	enumeration	0343001	documentation Device-Fehlpositionierung
	enumeration	0343002	documentation Koronarostienverschluss
	enumeration	0343003	documentation Aortendissektion
	enumeration	0343004	documentation Aortenregurgitation > = 2. Grades
	enumeration	0343005	documentation Annulus-Ruptur
	enumeration	0343006	documentation Ruptur-/Perforation einer Herzhöhle ohne Therapiebedarf

	<p>enumeration 0343007 documentation Ruptur-/Perforation einer Herzhöhle mit Therapiebedarf</p> <p>enumeration 0343008 documentation Perikardtamponade</p> <p>enumeration 0343009 documentation kardiale Dekompensation</p> <p>enumeration 0343010 documentation Hirnembolie</p> <p>enumeration 0343011 documentation Rhythmusstörungen</p> <p>enumeration 0343012 documentation Device-Embolisation</p> <p>enumeration 0343013 documentation vaskuläre Komplikation</p> <p>enumeration 0343014 documentation Low Cardiac Output</p> <p>enumeration 0343015 documentation schwerwiegende Blutungen (intraprozedural)</p> <p>enumeration 0343016 documentation lebensbedrohliche Blutungen (intraprozedural)</p> <p>enumeration 0343017 documentation Patient verstarb im OP/Katheterlabor</p> <p>enumeration 0343042 documentation sonstige intraprozedurale Komplikationen</p>
annotation	documentation Kat_AK_KomplikationTyp
source	<pre> <simpleType name="enum_0343"> <annotation> <documentation>Kat_AK_KomplikationTyp</documentation> </annotation> <restriction base="xs:string"> <enumeration value="0343001"> <annotation> <documentation>Device-Fehlpositionierung</documentation> </annotation> </enumeration> <enumeration value="0343002"> <annotation> <documentation>Koronarostienverschluss</documentation> </annotation> </enumeration> <enumeration value="0343003"> <annotation> <documentation>Aortendissektion</documentation> </annotation> </enumeration> <enumeration value="0343004"> <annotation> <documentation>Aortenregurgitation &gt; = 2. Grades</documentation> </annotation> </enumeration> <enumeration value="0343005"> <annotation> <documentation>Annulus-Ruptur</documentation> </annotation> </enumeration> <enumeration value="0343006"> <annotation> <documentation>Ruptur-/Perforation einer Herzhöhle ohne Therapiebedarf</documentation> </annotation> </enumeration> </restriction> </simpleType> </pre>

```

</enumeration>
<enumeration value="0343007">
  <annotation>
    <documentation>Ruptur-/Perforation einer Herzhöhle mit
Therapiebedarf</documentation>
  </annotation>
</enumeration>
<enumeration value="0343008">
  <annotation>
    <documentation>Perikardtamponade</documentation>
  </annotation>
</enumeration>
<enumeration value="0343009">
  <annotation>
    <documentation>kardiale Dekompensation</documentation>
  </annotation>
</enumeration>
<enumeration value="0343010">
  <annotation>
    <documentation>Hirnembolie</documentation>
  </annotation>
</enumeration>
<enumeration value="0343011">
  <annotation>
    <documentation>Rhythmusstörungen</documentation>
  </annotation>
</enumeration>
<enumeration value="0343012">
  <annotation>
    <documentation>Device-Embolisation</documentation>
  </annotation>
</enumeration>
<enumeration value="0343013">
  <annotation>
    <documentation>vaskuläre Komplikation</documentation>
  </annotation>
</enumeration>
<enumeration value="0343014">
  <annotation>
    <documentation>Low Cardiac Output</documentation>
  </annotation>
</enumeration>
<enumeration value="0343015">
  <annotation>
    <documentation>schwerwiegende Blutungen
(intraprozedural)</documentation>
  </annotation>
</enumeration>
<enumeration value="0343016">
  <annotation>
    <documentation>lebensbedrohliche Blutungen
(intraprozedural)</documentation>
  </annotation>
</enumeration>
<enumeration value="0343017">
  <annotation>
    <documentation>Patient verstarb im OP/Katheterlabor</documentation>
  </annotation>
</enumeration>

```

	<pre> <enumeration value="0343042"> <annotation> <documentation>sonstige intraprozedurale Komplikationen</documentation> </annotation> </enumeration> </restriction> </simpleType> </pre>
--	---

simpleType enum_0346

namespace	http://xml.ir-d.de/irdsa		
type	restriction of string		
properties	base xs:string		
facets	Kind	Value	Annotation
	enumeration	0346001	documentation keine Therapie erforderlich
	enumeration	0346002	documentation medikamentös
	enumeration	0346003	documentation IABP
	enumeration	0346004	documentation VAD
	enumeration	0346005	documentation ECMO
	enumeration	0346042	documentation sonstige
annotation	documentation Kat_AK_TherapieLCO		
source	<pre> <simpleType name="enum_0346"> <annotation> <documentation>Kat_AK_TherapieLCO</documentation> </annotation> <restriction base="xs:string"> <enumeration value="0346001"> <annotation> <documentation>keine Therapie erforderlich</documentation> </annotation> </enumeration> <enumeration value="0346002"> <annotation> <documentation>medikamentös</documentation> </annotation> </enumeration> <enumeration value="0346003"> <annotation> <documentation>IABP</documentation> </annotation> </enumeration> <enumeration value="0346004"> <annotation> <documentation>VAD</documentation> </annotation> </enumeration> <enumeration value="0346005"> <annotation> <documentation>ECMO</documentation> </annotation> </enumeration> </restriction> </simpleType> </pre>		

	<pre> </annotation> </enumeration> <enumeration value="0346042"> <annotation> <documentation>sonstige</documentation> </annotation> </enumeration> </restriction> </simpleType> </pre>
--	--

simpleType enum_0347

namespace	http://xml.ir-d.de/irdsa		
type	restriction of string		
properties	base xs:string		
facets	Kind	Value	Annotation
	enumeration	0347001	documentation Einzeleingriff
	enumeration	0347002	documentation Kombinationseingriff mit mehreren Prozeduren
annotation	documentation Kat_AK_Eingriffsumfang		
source	<pre> <simpleType name="enum_0347"> <annotation> <documentation>Kat_AK_Eingriffsumfang</documentation> </annotation> <restriction base="xs:string"> <enumeration value="0347001"> <annotation> <documentation>Einzeleingriff</documentation> </annotation> </enumeration> <enumeration value="0347002"> <annotation> <documentation>Kombinationseingriff mit mehreren Prozeduren</documentation> </annotation> </enumeration> </restriction> </simpleType> </pre>		

simpleType enum_0348

namespace	http://xml.ir-d.de/irdsa		
type	restriction of string		
properties	base xs:string		
facets	Kind	Value	Annotation
	enumeration	0348001	documentation mit HLM
	enumeration	0348002	documentation ohne HLM
	enumeration	0348003	documentation Umstieg von OP ohne HLM auf OP mit HLM
annotation	documentation Kat_AK_OPVorgehen		

source	<pre> <simpleType name="enum_0348"> <annotation> <documentation>Kat_AK_OPVorgehen</documentation> </annotation> <restriction base="xs:string"> <enumeration value="0348001"> <annotation> <documentation>mit HLM</documentation> </annotation> </enumeration> <enumeration value="0348002"> <annotation> <documentation>ohne HLM</documentation> </annotation> </enumeration> <enumeration value="0348003"> <annotation> <documentation>Umstieg von OP ohne HLM auf OP mit HLM</documentation> </annotation> </enumeration> </restriction> </simpleType> </pre>
--------	---

simpleType enum_0350

namespace	http://xml.ir-d.de/irdsa		
type	restriction of string		
properties	base xs:string		
facets	Kind	Value	Annotation
	enumeration	0350001	documentation IABP
	enumeration	0350002	documentation Impella
	enumeration	0350003	documentation vv ECMO
	enumeration	0350004	documentation va ECMO
	enumeration	0350042	documentation andere
annotation	documentation Kat_AK_Methode		
source	<pre> <simpleType name="enum_0350"> <annotation> <documentation>Kat_AK_Methode</documentation> </annotation> <restriction base="xs:string"> <enumeration value="0350001"> <annotation> <documentation>IABP</documentation> </annotation> </enumeration> <enumeration value="0350002"> <annotation> <documentation>Impella</documentation> </annotation> </enumeration> <enumeration value="0350003"> </pre>		

	<pre> <annotation> <documentation>vv ECMO</documentation> </annotation> </enumeration> <enumeration value="0350004"> <annotation> <documentation>va ECMO</documentation> </annotation> </enumeration> <enumeration value="0350042"> <annotation> <documentation>andere</documentation> </annotation> </enumeration> </restriction> </simpleType> </pre>
--	---

simpleType enum_0351

namespace	http://xml.ir-d.de/irdsa		
type	restriction of string		
properties	base xs:string		
facets	Kind	Value	Annotation
	enumeration	0351001	documentation nein
	enumeration	0351002	documentation ja, zu Sternotomie
	enumeration	0351003	documentation ja, zu transapikal
	enumeration	0351004	documentation ja, zu transaortal
	enumeration	0351005	documentation ja, zu transfemoral
	enumeration	0351006	documentation ja, zu transaxillär
	enumeration	0351007	documentation ja, zu anderem endovaskulären Zugang
	enumeration	0351042	documentation ja, zu anderem Zugang
annotation	documentation Kat_AK_Konversion		
source	<pre> <simpleType name="enum_0351"> <annotation> <documentation>Kat_AK_Konversion</documentation> </annotation> <restriction base="xs:string"> <enumeration value="0351001"> <annotation> <documentation>nein</documentation> </annotation> </enumeration> <enumeration value="0351002"> <annotation> <documentation>ja, zu Sternotomie</documentation> </annotation> </enumeration> <enumeration value="0351003"> <annotation> </pre>		

	<pre> <documentation>ja, zu transapikal</documentation> </annotation> </enumeration> <enumeration value="0351004"> <annotation> <documentation>ja, zu transaortal</documentation> </annotation> </enumeration> <enumeration value="0351005"> <annotation> <documentation>ja, zu transfemoral</documentation> </annotation> </enumeration> <enumeration value="0351006"> <annotation> <documentation>ja, zu transaxillär</documentation> </annotation> </enumeration> <enumeration value="0351007"> <annotation> <documentation>ja, zu anderem endovaskulären Zugang</documentation> </annotation> </enumeration> <enumeration value="0351042"> <annotation> <documentation>ja, zu anderem Zugang</documentation> </annotation> </enumeration> </restriction> </simpleType> </pre>
--	---

simpleType enum_0352

namespace	http://xml.ir-d.de/irdsa		
type	restriction of string		
properties	base xs:string		
facets	Kind	Value	Annotation
	enumeration	0352001	documentation nein
	enumeration	0352002	documentation ja, Intubationsnarkose
	enumeration	0352003	documentation ja, Maskenbeatmung, incl. LAMA
	enumeration	0352042	documentation ja, unbekannt welche
annotation	documentation Kat_AK_Anaesthesie		
source	<pre> <simpleType name="enum_0352"> <annotation> <documentation>Kat_AK_Anaesthesie</documentation> </annotation> <restriction base="xs:string"> <enumeration value="0352001"> <annotation> <documentation>nein</documentation> </annotation> </enumeration> </pre>		

	<pre> <enumeration value="0352002"> <annotation> <documentation>ja, Intubationsnarkose</documentation> </annotation> </enumeration> <enumeration value="0352003"> <annotation> <documentation>ja, Maskenbeatmung, incl. LAMA</documentation> </annotation> </enumeration> <enumeration value="0352042"> <annotation> <documentation>ja, unbekannt welche</documentation> </annotation> </enumeration> </restriction> </simpleType> </pre>
--	---

simpleType enum 0353

namespace	http://xml.ir-d.de/irdsa		
type	restriction of string		
properties	base xs:string		
facets	Kind	Value	Annotation
	enumeration	0353001	documentation keine
	enumeration	0353002	documentation leichtgradig
	enumeration	0353003	documentation mittelgradig
	enumeration	0353004	documentation hochgradig
	enumeration	0353099	documentation nicht bestimmbar
annotation	documentation Kat_AK_ResidualeArteninsuffizienz		
source	<pre> <simpleType name="enum_0353"> <annotation> <documentation>Kat_AK_ResidualeArteninsuffizienz</documentation> </annotation> <restriction base="xs:string"> <enumeration value="0353001"> <annotation> <documentation>keine</documentation> </annotation> </enumeration> <enumeration value="0353002"> <annotation> <documentation>leichtgradig</documentation> </annotation> </enumeration> <enumeration value="0353003"> <annotation> <documentation>mittelgradig</documentation> </annotation> </enumeration> <enumeration value="0353004"> </pre>		

	<pre> <annotation> <documentation>hochgradig</documentation> </annotation> </enumeration> <enumeration value="0353099"> <annotation> <documentation>nicht bestimmbar</documentation> </annotation> </enumeration> </restriction> </simpleType> </pre>
--	---

simpleType enum_0354

namespace	http://xml.ir-d.de/irdsa		
type	restriction of string		
properties	base xs:string		
facets	Kind	Value	Annotation
	enumeration	0354001	documentation chirurgisch-offen
	enumeration	0354002	documentation Verschluss-System
	enumeration	0354042	documentation sonstige
annotation	documentation Kat_AK_Zugangswegverschluss		
source	<pre> <simpleType name="enum_0354"> <annotation> <documentation>Kat_AK_Zugangswegverschluss</documentation> </annotation> <restriction base="xs:string"> <enumeration value="0354001"> <annotation> <documentation>chirurgisch-offen</documentation> </annotation> </enumeration> <enumeration value="0354002"> <annotation> <documentation>Verschluss-System</documentation> </annotation> </enumeration> <enumeration value="0354042"> <annotation> <documentation>sonstige</documentation> </annotation> </enumeration> </restriction> </simpleType> </pre>		

simpleType enum_0357

namespace	http://xml.ir-d.de/irdsa		
type	restriction of string		
properties	base xs:string		

facets	<table border="1"> <thead> <tr> <th>Kind</th> <th>Value</th> <th>Annotation</th> </tr> </thead> <tbody> <tr> <td>enumeration</td> <td>0357001</td> <td>documentation keine KHK</td> </tr> <tr> <td>enumeration</td> <td>0357002</td> <td>documentation 1-Gefäßerkrankung</td> </tr> <tr> <td>enumeration</td> <td>0357003</td> <td>documentation 2-Gefäßerkrankung</td> </tr> <tr> <td>enumeration</td> <td>0357004</td> <td>documentation 3-Gefäßerkrankung</td> </tr> <tr> <td>enumeration</td> <td>0357005</td> <td>documentation keine koronare Bildgebung</td> </tr> </tbody> </table>	Kind	Value	Annotation	enumeration	0357001	documentation keine KHK	enumeration	0357002	documentation 1-Gefäßerkrankung	enumeration	0357003	documentation 2-Gefäßerkrankung	enumeration	0357004	documentation 3-Gefäßerkrankung	enumeration	0357005	documentation keine koronare Bildgebung
Kind	Value	Annotation																	
enumeration	0357001	documentation keine KHK																	
enumeration	0357002	documentation 1-Gefäßerkrankung																	
enumeration	0357003	documentation 2-Gefäßerkrankung																	
enumeration	0357004	documentation 3-Gefäßerkrankung																	
enumeration	0357005	documentation keine koronare Bildgebung																	
annotation	documentation Kat AK BefundBildgebung																		
source	<pre> <simpleType name="enum_0357"> <annotation> <documentation>Kat_AK_BefundBildgebung</documentation> </annotation> <restriction base="xs:string"> <enumeration value="0357001"> <annotation> <documentation>keine KHK</documentation> </annotation> </enumeration> <enumeration value="0357002"> <annotation> <documentation>1-Gefäßerkrankung</documentation> </annotation> </enumeration> <enumeration value="0357003"> <annotation> <documentation>2-Gefäßerkrankung</documentation> </annotation> </enumeration> <enumeration value="0357004"> <annotation> <documentation>3-Gefäßerkrankung</documentation> </annotation> </enumeration> <enumeration value="0357005"> <annotation> <documentation>keine koronare Bildgebung</documentation> </annotation> </enumeration> </restriction> </simpleType> </pre>																		

simpleType enum_0358

namespace	http://xml.ir-d.de/irdsa												
type	restriction of string												
properties	base xs:string												
facets	<table border="1"> <thead> <tr> <th>Kind</th> <th>Value</th> <th>Annotation</th> </tr> </thead> <tbody> <tr> <td>enumeration</td> <td>0358001</td> <td>documentation 0</td> </tr> <tr> <td>enumeration</td> <td>0358002</td> <td>documentation 1</td> </tr> <tr> <td>enumeration</td> <td>0358003</td> <td>documentation 2</td> </tr> </tbody> </table>	Kind	Value	Annotation	enumeration	0358001	documentation 0	enumeration	0358002	documentation 1	enumeration	0358003	documentation 2
Kind	Value	Annotation											
enumeration	0358001	documentation 0											
enumeration	0358002	documentation 1											
enumeration	0358003	documentation 2											

	enumeration 0358004 documentation 3 enumeration 0358005 documentation 4 enumeration 0358006 documentation 5 oder mehr enumeration 0358098 documentation genaue Anzahl unbekannt (aber mind. 1) enumeration 0358099 documentation unbekannt
annotation	documentation Kat_AK_AnzahlVorOP
source	<pre> <simpleType name="enum_0358"> <annotation> <documentation>Kat_AK_AnzahlVorOP</documentation> </annotation> <restriction base="xs:string"> <enumeration value="0358001"> <annotation> <documentation>0</documentation> </annotation> </enumeration> <enumeration value="0358002"> <annotation> <documentation>1</documentation> </annotation> </enumeration> <enumeration value="0358003"> <annotation> <documentation>2</documentation> </annotation> </enumeration> <enumeration value="0358004"> <annotation> <documentation>3</documentation> </annotation> </enumeration> <enumeration value="0358005"> <annotation> <documentation>4</documentation> </annotation> </enumeration> <enumeration value="0358006"> <annotation> <documentation>5 oder mehr</documentation> </annotation> </enumeration> <enumeration value="0358098"> <annotation> <documentation>genaue Anzahl unbekannt (aber mind. 1)</documentation> </annotation> </enumeration> <enumeration value="0358099"> <annotation> <documentation>unbekannt</documentation> </annotation> </enumeration> </restriction> </simpleType> </pre>

simpleType enum 0359

namespace	http://xml.ir-d.de/irdsa		
type	restriction of string		
properties	base xs:string		
facets	Kind	Value	Annotation
	enumeration	0359001	documentation nein
	enumeration	0359002	documentation ja - einseitig
	enumeration	0359003	documentation ja - beidseitig
	enumeration	0359042	documentation unbekannt
annotation	documentation Kat AK LVOT		
source	<pre> <simpleType name="enum_0359"> <annotation> <documentation>Kat_AK_LVOT</documentation> </annotation> <restriction base="xs:string"> <enumeration value="0359001"> <annotation> <documentation>nein</documentation> </annotation> </enumeration> <enumeration value="0359002"> <annotation> <documentation>ja - einseitig</documentation> </annotation> </enumeration> <enumeration value="0359003"> <annotation> <documentation>ja - beidseitig</documentation> </annotation> </enumeration> <enumeration value="0359042"> <annotation> <documentation>unbekannt</documentation> </annotation> </enumeration> </restriction> </simpleType> </pre>		

simpleType enum 0360

namespace	http://xml.ir-d.de/irdsa		
type	restriction of string		
properties	base xs:string		
facets	Kind	Value	Annotation
	enumeration	0360001	documentation keine
	enumeration	0360002	documentation leichtgradig

	enumeration 0360003 documentation mittelgradig enumeration 0360004 documentation hochgradig enumeration 0360005 documentation massive enumeration 0360006 documentation torrential enumeration 0360099 documentation unbekannt
annotation	documentation Kat_AK_TriskupidallInsuffizienz
source	<pre> <simpleType name="enum_0360"> <annotation> <documentation>Kat_AK_TriskupidallInsuffizienz</documentation> </annotation> <restriction base="xs:string"> <enumeration value="0360001"> <annotation> <documentation>keine</documentation> </annotation> </enumeration> <enumeration value="0360002"> <annotation> <documentation>leichtgradig</documentation> </annotation> </enumeration> <enumeration value="0360003"> <annotation> <documentation>mittelgradig</documentation> </annotation> </enumeration> <enumeration value="0360004"> <annotation> <documentation>hochgradig</documentation> </annotation> </enumeration> <enumeration value="0360005"> <annotation> <documentation>massive</documentation> </annotation> </enumeration> <enumeration value="0360006"> <annotation> <documentation>torrential</documentation> </annotation> </enumeration> <enumeration value="0360099"> <annotation> <documentation>unbekannt</documentation> </annotation> </enumeration> </restriction> </simpleType> </pre>

simpleType enum_0361

namespace	http://xml.ir-d.de/irdsa
-----------	--------------------------

type	restriction of string		
properties	base xs:string		
facets	Kind	Value	Annotation
	enumeration	0361001	documentation nein
	enumeration	0361002	documentation ja, letzte(r) innerhalb der letzten 48 Stunden
	enumeration	0361003	documentation ja, letzte(r) innerhalb der letzten 21 Tage
	enumeration	0361004	documentation ja, letzte(r) länger als 21 Tage
	enumeration	0361098	documentation ja, letzter Zeitpunkt unbekannt
	enumeration	0361099	documentation unbekannt
annotation	documentation Kat_AK_SchockReanimation		
source	<pre> <simpleType name="enum_0361"> <annotation> <documentation>Kat_AK_SchockReanimation</documentation> </annotation> <restriction base="xs:string"> <enumeration value="0361001"> <annotation> <documentation>nein</documentation> </annotation> </enumeration> <enumeration value="0361002"> <annotation> <documentation>ja, letzte(r) innerhalb der letzten 48 Stunden</documentation> </annotation> </enumeration> <enumeration value="0361003"> <annotation> <documentation>ja, letzte(r) innerhalb der letzten 21 Tage</documentation> </annotation> </enumeration> <enumeration value="0361004"> <annotation> <documentation>ja, letzte(r) länger als 21 Tage</documentation> </annotation> </enumeration> <enumeration value="0361098"> <annotation> <documentation>ja, letzter Zeitpunkt unbekannt</documentation> </annotation> </enumeration> <enumeration value="0361099"> <annotation> <documentation>unbekannt</documentation> </annotation> </enumeration> </restriction> </simpleType> </pre>		

simpleType enum_0362

namespace	http://xml.ir-d.de/irdsa		
type	restriction of string		
properties	base xs:string		
facets	Kind	Value	Annotation
	enumeration	0362001	documentation Sinusrhythmus
	enumeration	0362002	documentation Vorhofflimmern
	enumeration	0362042	documentation anderer Herzrhythmus
annotation	documentation Kat_AK_Herzrhythmus		
source	<pre> <simpleType name="enum_0362"> <annotation> <documentation>Kat_AK_Herzrhythmus</documentation> </annotation> <restriction base="xs:string"> <enumeration value="0362001"> <annotation> <documentation>Sinusrhythmus</documentation> </annotation> </enumeration> <enumeration value="0362002"> <annotation> <documentation>Vorhofflimmern</documentation> </annotation> </enumeration> <enumeration value="0362042"> <annotation> <documentation>anderer Herzrhythmus</documentation> </annotation> </enumeration> </restriction> </simpleType> </pre>		

simpleType enum_0363

namespace	http://xml.ir-d.de/irdsa		
type	restriction of string		
properties	base xs:string		
facets	Kind	Value	Annotation
	enumeration	0363001	documentation nein
	enumeration	0363002	documentation paroxysmal
	enumeration	0363003	documentation persistierend
	enumeration	0363004	documentation permanent
annotation	documentation Kat_AK_Vorhofflimmern		
source	<pre> <simpleType name="enum_0363"> <annotation> <documentation>Kat AK Vorhofflimmern</documentation> </annotation> </pre>		

	<pre> </annotation> <restriction base="xs:string"> <enumeration value="0363001"> <annotation> <documentation>nein</documentation> </annotation> </enumeration> <enumeration value="0363002"> <annotation> <documentation>paroxysmal</documentation> </annotation> </enumeration> <enumeration value="0363003"> <annotation> <documentation>persistierend</documentation> </annotation> </enumeration> <enumeration value="0363004"> <annotation> <documentation>permanent</documentation> </annotation> </enumeration> </restriction> </simpleType> </pre>
--	--

simpleType enum_0364

namespace	http://xml.ir-d.de/irdsa		
type	restriction of string		
properties	base xs:string		
facets	Kind	Value	Annotation
	enumeration	0364001	documentation nein
	enumeration	0364002	documentation Schrittmacher ohne CRT-System
	enumeration	0364003	documentation Schrittmacher mit CRT-System
	enumeration	0364004	documentation Defibrillator ohne CRT-System
	enumeration	0364005	documentation Defibrillator mit CRT-System
annotation	documentation Kat_AK_SchrittmacherDefi		
source	<pre> <simpleType name="enum_0364"> <annotation> <documentation>Kat_AK_SchrittmacherDefi</documentation> </annotation> <restriction base="xs:string"> <enumeration value="0364001"> <annotation> <documentation>nein</documentation> </annotation> </enumeration> <enumeration value="0364002"> <annotation> <documentation>Schrittmacher ohne CRT-System</documentation> </annotation> </enumeration> </restriction> </simpleType> </pre>		

	<pre> </enumeration> <enumeration value="0364003"> <annotation> <documentation>Schrittmacher mit CRT-System</documentation> </annotation> </enumeration> <enumeration value="0364004"> <annotation> <documentation>Defibrillator ohne CRT-System</documentation> </annotation> </enumeration> <enumeration value="0364005"> <annotation> <documentation>Defibrillator mit CRT-System</documentation> </annotation> </enumeration> </restriction> </simpleType> </pre>
--	---

simpleType enum_0365

namespace	http://xml.ir-d.de/irdsa		
type	restriction of string		
properties	base xs:string		
facets	Kind	Value	Annotation
	enumeration	0365001	documentation nein
	enumeration	0365002	documentation ja, operativ
	enumeration	0365003	documentation ja, interventionell
annotation	documentation Kat AK MyokardRevaskularisation		
source	<pre> <simpleType name="enum_0365"> <annotation> <documentation>Kat_AK_MyokardRevaskularisation</documentation> </annotation> <restriction base="xs:string"> <enumeration value="0365001"> <annotation> <documentation>nein</documentation> </annotation> </enumeration> <enumeration value="0365002"> <annotation> <documentation>ja, operativ</documentation> </annotation> </enumeration> <enumeration value="0365003"> <annotation> <documentation>ja, interventionell</documentation> </annotation> </enumeration> </restriction> </simpleType> </pre>		

simpleType enum_0366

namespace	http://xml.ir-d.de/irdsa		
type	restriction of string		
properties	base xs:string		
facets	Kind	Value	Annotation
	enumeration	0366001	documentation nein
	enumeration	0366002	documentation ja, <= 6 Stunden
	enumeration	0366003	documentation ja, > 6 Stunden bis <= 3 Monate
	enumeration	0366004	documentation ja, > 3 Monate
	enumeration	0366099	documentation unbekannt
annotation	documentation Kat_AK_PCI		
source	<pre> <simpleType name="enum_0366"> <annotation> <documentation>Kat_AK_PCI</documentation> </annotation> <restriction base="xs:string"> <enumeration value="0366001"> <annotation> <documentation>nein</documentation> </annotation> </enumeration> <enumeration value="0366002"> <annotation> <documentation>ja, &lt;= 6 Stunden</documentation> </annotation> </enumeration> <enumeration value="0366003"> <annotation> <documentation>ja, &gt; 6 Stunden bis &lt;= 3 Monate</documentation> </annotation> </enumeration> <enumeration value="0366004"> <annotation> <documentation>ja, &gt; 3 Monate</documentation> </annotation> </enumeration> <enumeration value="0366099"> <annotation> <documentation>unbekannt</documentation> </annotation> </enumeration> </restriction> </simpleType> </pre>		

simpleType enum_0367

namespace	http://xml.ir-d.de/irdsa
type	restriction of string

properties	base xs:string																																																			
facets	<table border="1"> <thead> <tr> <th>Kind</th> <th>Value</th> <th>Annotation</th> </tr> </thead> <tbody> <tr> <td>enumeration</td> <td>0367001</td> <td>documentation keine</td> </tr> <tr> <td>enumeration</td> <td>0367002</td> <td>documentation Mediastinitis</td> </tr> <tr> <td>enumeration</td> <td>0367003</td> <td>documentation Sepsis</td> </tr> <tr> <td>enumeration</td> <td>0367004</td> <td>documentation broncho-pulmonale Infektion</td> </tr> <tr> <td>enumeration</td> <td>0367005</td> <td>documentation oto-laryngologische Infektion</td> </tr> <tr> <td>enumeration</td> <td>0367006</td> <td>documentation floride Endokarditis</td> </tr> <tr> <td>enumeration</td> <td>0367007</td> <td>documentation Peritonitis</td> </tr> <tr> <td>enumeration</td> <td>0367008</td> <td>documentation Wundinfektion Thorax</td> </tr> <tr> <td>enumeration</td> <td>0367009</td> <td>documentation Pleuraempyem</td> </tr> <tr> <td>enumeration</td> <td>0367010</td> <td>documentation Venenkatheterinfektion</td> </tr> <tr> <td>enumeration</td> <td>0367011</td> <td>documentation Harnwegsinfektion</td> </tr> <tr> <td>enumeration</td> <td>0367012</td> <td>documentation Wundinfektion untere Extremitäten</td> </tr> <tr> <td>enumeration</td> <td>0367013</td> <td>documentation HIV-Infektion</td> </tr> <tr> <td>enumeration</td> <td>0367014</td> <td>documentation Hepatitis B oder C</td> </tr> <tr> <td>enumeration</td> <td>0367015</td> <td>documentation andere Wundinfektion</td> </tr> <tr> <td>enumeration</td> <td>0367042</td> <td>documentation sonstige Infektion</td> </tr> </tbody> </table>	Kind	Value	Annotation	enumeration	0367001	documentation keine	enumeration	0367002	documentation Mediastinitis	enumeration	0367003	documentation Sepsis	enumeration	0367004	documentation broncho-pulmonale Infektion	enumeration	0367005	documentation oto-laryngologische Infektion	enumeration	0367006	documentation floride Endokarditis	enumeration	0367007	documentation Peritonitis	enumeration	0367008	documentation Wundinfektion Thorax	enumeration	0367009	documentation Pleuraempyem	enumeration	0367010	documentation Venenkatheterinfektion	enumeration	0367011	documentation Harnwegsinfektion	enumeration	0367012	documentation Wundinfektion untere Extremitäten	enumeration	0367013	documentation HIV-Infektion	enumeration	0367014	documentation Hepatitis B oder C	enumeration	0367015	documentation andere Wundinfektion	enumeration	0367042	documentation sonstige Infektion
Kind	Value	Annotation																																																		
enumeration	0367001	documentation keine																																																		
enumeration	0367002	documentation Mediastinitis																																																		
enumeration	0367003	documentation Sepsis																																																		
enumeration	0367004	documentation broncho-pulmonale Infektion																																																		
enumeration	0367005	documentation oto-laryngologische Infektion																																																		
enumeration	0367006	documentation floride Endokarditis																																																		
enumeration	0367007	documentation Peritonitis																																																		
enumeration	0367008	documentation Wundinfektion Thorax																																																		
enumeration	0367009	documentation Pleuraempyem																																																		
enumeration	0367010	documentation Venenkatheterinfektion																																																		
enumeration	0367011	documentation Harnwegsinfektion																																																		
enumeration	0367012	documentation Wundinfektion untere Extremitäten																																																		
enumeration	0367013	documentation HIV-Infektion																																																		
enumeration	0367014	documentation Hepatitis B oder C																																																		
enumeration	0367015	documentation andere Wundinfektion																																																		
enumeration	0367042	documentation sonstige Infektion																																																		
annotation	documentation Kat_AK_Infektion																																																			
source	<pre> <simpleType name="enum_0367"> <annotation> <documentation>Kat_AK_Infektion</documentation> </annotation> <restriction base="xs:string"> <enumeration value="0367001"> <annotation> <documentation>keine</documentation> </annotation> </enumeration> <enumeration value="0367002"> <annotation> <documentation>Mediastinitis</documentation> </annotation> </enumeration> <enumeration value="0367003"> <annotation> <documentation>Sepsis</documentation> </annotation> </enumeration> <enumeration value="0367004"> <annotation> <documentation>broncho-pulmonale Infektion</documentation> </annotation> </enumeration> </restriction> </simpleType> </pre>																																																			

```
<enumeration value="0367005">
  <annotation>
    <documentation>oto-laryngologische Infektion</documentation>
  </annotation>
</enumeration>
<enumeration value="0367006">
  <annotation>
    <documentation>floride Endokarditis</documentation>
  </annotation>
</enumeration>
<enumeration value="0367007">
  <annotation>
    <documentation>Peritonitis</documentation>
  </annotation>
</enumeration>
<enumeration value="0367008">
  <annotation>
    <documentation>Wundinfektion Thorax</documentation>
  </annotation>
</enumeration>
<enumeration value="0367009">
  <annotation>
    <documentation>Pleuraempyem</documentation>
  </annotation>
</enumeration>
<enumeration value="0367010">
  <annotation>
    <documentation>Venenkatheterinfektion</documentation>
  </annotation>
</enumeration>
<enumeration value="0367011">
  <annotation>
    <documentation>Harnwegsinfektion</documentation>
  </annotation>
</enumeration>
<enumeration value="0367012">
  <annotation>
    <documentation>Wundinfektion untere Extremitäten</documentation>
  </annotation>
</enumeration>
<enumeration value="0367013">
  <annotation>
    <documentation>HIV-Infektion</documentation>
  </annotation>
</enumeration>
<enumeration value="0367014">
  <annotation>
    <documentation>Hepatitis B oder C</documentation>
  </annotation>
</enumeration>
<enumeration value="0367015">
  <annotation>
    <documentation>andere Wundinfektion</documentation>
  </annotation>
</enumeration>
<enumeration value="0367042">
  <annotation>
    <documentation>sonstige Infektion</documentation>
  </annotation>
</enumeration>
```

```

</enumeration>
</restriction>
</simpleType>

```

simpleType enum_0368

namespace	http://xml.ir-d.de/irdsa		
type	restriction of string		
properties	base xs:string		
facets	Kind	Value	Annotation
	enumeration	0368001	documentation nein
	enumeration	0368002	documentation ja, COPD mit Dauermedikation
	enumeration	0368003	documentation ja, COPD ohne Dauermedikation
	enumeration	0368004	documentation ja, andere Lungenerkrankungen
	enumeration	0368099	documentation unbekannt
annotation	documentation Kat_AK_Lungenerkrankung		
source	<pre> <simpleType name="enum_0368"> <annotation> <documentation>Kat_AK_Lungenerkrankung</documentation> </annotation> <restriction base="xs:string"> <enumeration value="0368001"> <annotation> <documentation>nein</documentation> </annotation> </enumeration> <enumeration value="0368002"> <annotation> <documentation>ja, COPD mit Dauermedikation</documentation> </annotation> </enumeration> <enumeration value="0368003"> <annotation> <documentation>ja, COPD ohne Dauermedikation</documentation> </annotation> </enumeration> <enumeration value="0368004"> <annotation> <documentation>ja, andere Lungenerkrankungen</documentation> </annotation> </enumeration> <enumeration value="0368099"> <annotation> <documentation>unbekannt</documentation> </annotation> </enumeration> </restriction> </simpleType> </pre>		

simpleType enum_0369

namespace	http://xml.ir-d.de/irdsa		
type	restriction of string		
properties	base xs:string		
facets	Kind	Value	Annotation
	enumeration	0369001	documentation nein
	enumeration	0369002	documentation akut
	enumeration	0369003	documentation chronisch
annotation	documentation Kat_AK_Nierenersatztherapie		
source	<pre> <simpleType name="enum_0369"> <annotation> <documentation>Kat_AK_Nierenersatztherapie</documentation> </annotation> <restriction base="xs:string"> <enumeration value="0369001"> <annotation> <documentation>nein</documentation> </annotation> </enumeration> <enumeration value="0369002"> <annotation> <documentation>akut</documentation> </annotation> </enumeration> <enumeration value="0369003"> <annotation> <documentation>chronisch</documentation> </annotation> </enumeration> </restriction> </simpleType> </pre>		

simpleType enum_0370

namespace	http://xml.ir-d.de/irdsa		
type	restriction of string		
properties	base xs:string		
facets	Kind	Value	Annotation
	enumeration	0370001	documentation Echokardiographie
	enumeration	0370002	documentation Herzkatheter
	enumeration	0370042	documentation andere
annotation	documentation Kat_AK_AKOEFMessmethode		
source	<pre> <simpleType name="enum_0370"> <annotation> <documentation>Kat_AK_AKOEFMessmethode</documentation> </annotation> <restriction base="xs:string"> </pre>		

	<pre> <enumeration value="0370001"> <annotation> <documentation>Echokardiographie</documentation> </annotation> </enumeration> <enumeration value="0370002"> <annotation> <documentation>Herzkatheter</documentation> </annotation> </enumeration> <enumeration value="0370042"> <annotation> <documentation>andere</documentation> </annotation> </enumeration> </restriction> </simpleType> </pre>
--	--

simpleType enum 0371

namespace	http://xml.ir-d.de/irdsa		
type	restriction of string		
properties	base xs:string		
facets	Kind	Value	Annotation
	enumeration	0371001	documentation keine
	enumeration	0371002	documentation leicht
	enumeration	0371003	documentation mittel
	enumeration	0371004	documentation schwer
	enumeration	0371099	documentation unbekannt
annotation	documentation Kat_AK_Verkalkungsgrad		
source	<pre> <simpleType name="enum_0371"> <annotation> <documentation>Kat_AK_Verkalkungsgrad</documentation> </annotation> <restriction base="xs:string"> <enumeration value="0371001"> <annotation> <documentation>keine</documentation> </annotation> </enumeration> <enumeration value="0371002"> <annotation> <documentation>leicht</documentation> </annotation> </enumeration> <enumeration value="0371003"> <annotation> <documentation>mittel</documentation> </annotation> </enumeration> <enumeration value="0371004"> </pre>		

	<pre> <annotation> <documentation>schwer</documentation> </annotation> </enumeration> <enumeration value="0371099"> <annotation> <documentation>unbekannt</documentation> </annotation> </enumeration> </restriction> </simpleType> </pre>
--	--

simpleType enum_0372

namespace	http://xml.ir-d.de/irdsa		
type	restriction of string		
properties	base xs:string		
facets	Kind	Value	Annotation
	enumeration	0372001	documentation nein
	enumeration	0372002	documentation ja, bicuspide
	enumeration	0372003	documentation ja, unicuspide
	enumeration	0372099	documentation unbekannt
annotation	documentation Kat_AK_BiUnicuspideKlappe		
source	<pre> <simpleType name="enum_0372"> <annotation> <documentation>Kat_AK_BiUnicuspideKlappe</documentation> </annotation> <restriction base="xs:string"> <enumeration value="0372001"> <annotation> <documentation>nein</documentation> </annotation> </enumeration> <enumeration value="0372002"> <annotation> <documentation>ja, bicuspide</documentation> </annotation> </enumeration> <enumeration value="0372003"> <annotation> <documentation>ja, unicuspide</documentation> </annotation> </enumeration> <enumeration value="0372099"> <annotation> <documentation>unbekannt</documentation> </annotation> </enumeration> </restriction> </simpleType> </pre>		

simpleType enum_0373

namespace	http://xml.ir-d.de/irdsa		
type	restriction of string		
properties	base xs:string		
facets	Kind	Value	Annotation
	enumeration	0373001	documentation keine
	enumeration	0373002	documentation leichtgradig
	enumeration	0373003	documentation mittelgradig
	enumeration	0373004	documentation hochgradig
	enumeration	0373099	documentation unbekannt
annotation	documentation Kat_AK_Grad		
source	<pre> <simpleType name="enum_0373"> <annotation> <documentation>Kat_AK_Grad</documentation> </annotation> <restriction base="xs:string"> <enumeration value="0373001"> <annotation> <documentation>keine</documentation> </annotation> </enumeration> <enumeration value="0373002"> <annotation> <documentation>leichtgradig</documentation> </annotation> </enumeration> <enumeration value="0373003"> <annotation> <documentation>mittelgradig</documentation> </annotation> </enumeration> <enumeration value="0373004"> <annotation> <documentation>hochgradig</documentation> </annotation> </enumeration> <enumeration value="0373099"> <annotation> <documentation>unbekannt</documentation> </annotation> </enumeration> </restriction> </simpleType> </pre>		

simpleType enum_0374

namespace	http://xml.ir-d.de/irdsa
type	restriction of string

properties	base xs:string																					
facets	<table border="1"> <thead> <tr> <th>Kind</th> <th>Value</th> <th>Annotation</th> </tr> </thead> <tbody> <tr> <td>enumeration</td> <td>0374001</td> <td>documentation nein</td> </tr> <tr> <td>enumeration</td> <td>0374002</td> <td>documentation ja, &lt;= 6 Stunden</td> </tr> <tr> <td>enumeration</td> <td>0374003</td> <td>documentation ja, &gt; 6 Stunden bis &lt;= 24 Stunden</td> </tr> <tr> <td>enumeration</td> <td>0374004</td> <td>documentation ja, &gt; 1 bis 7 Tage</td> </tr> <tr> <td>enumeration</td> <td>0374005</td> <td>documentation ja, &gt; 7 bis 21 Tage</td> </tr> <tr> <td>enumeration</td> <td>0374006</td> <td>documentation ja, &gt; 21 Tage</td> </tr> </tbody> </table>	Kind	Value	Annotation	enumeration	0374001	documentation nein	enumeration	0374002	documentation ja, <= 6 Stunden	enumeration	0374003	documentation ja, > 6 Stunden bis <= 24 Stunden	enumeration	0374004	documentation ja, > 1 bis 7 Tage	enumeration	0374005	documentation ja, > 7 bis 21 Tage	enumeration	0374006	documentation ja, > 21 Tage
Kind	Value	Annotation																				
enumeration	0374001	documentation nein																				
enumeration	0374002	documentation ja, <= 6 Stunden																				
enumeration	0374003	documentation ja, > 6 Stunden bis <= 24 Stunden																				
enumeration	0374004	documentation ja, > 1 bis 7 Tage																				
enumeration	0374005	documentation ja, > 7 bis 21 Tage																				
enumeration	0374006	documentation ja, > 21 Tage																				
annotation	documentation Kat_AK_InfarktAnamnese																					
source	<pre> <simpleType name="enum_0374"> <annotation> <documentation>Kat_AK_InfarktAnamnese</documentation> </annotation> <restriction base="xs:string"> <enumeration value="0374001"> <annotation> <documentation>nein</documentation> </annotation> </enumeration> <enumeration value="0374002"> <annotation> <documentation>ja, &lt;= 6 Stunden</documentation> </annotation> </enumeration> <enumeration value="0374003"> <annotation> <documentation>ja, &gt; 6 Stunden bis &lt;= 24 Stunden</documentation> </annotation> </enumeration> <enumeration value="0374004"> <annotation> <documentation>ja, &gt; 1 bis 7 Tage</documentation> </annotation> </enumeration> <enumeration value="0374005"> <annotation> <documentation>ja, &gt; 7 bis 21 Tage</documentation> </annotation> </enumeration> <enumeration value="0374006"> <annotation> <documentation>ja, &gt; 21 Tage</documentation> </annotation> </enumeration> </restriction> </simpleType> </pre>																					

simpleType **enum_0375**

namespace	http://xml.ir-d.de/irdsa
-----------	--------------------------

type	restriction of string		
properties	base xs:string		
facets	Kind	Value	Annotation
	enumeration	0375001	documentation keine Symptome oder Angina
	enumeration	0375002	documentation Symptome, aber keine Ischämiezeichen
	enumeration	0375003	documentation stabile Angina
	enumeration	0375004	documentation instabile Angina
	enumeration	0375005	documentation Infarkt ohne ST-Hebung (Non-STEMI)
	enumeration	0375006	documentation Infarkt mit ST-Hebung (STEMI)
	enumeration	0375042	documentation unbekannt
annotation	documentation Kat_AK_KardialeSymptome		
source	<pre> <simpleType name="enum_0375"> <annotation> <documentation>Kat_AK_KardialeSymptome</documentation> </annotation> <restriction base="xs:string"> <enumeration value="0375001"> <annotation> <documentation>keine Symptome oder Angina</documentation> </annotation> </enumeration> <enumeration value="0375002"> <annotation> <documentation>Symptome, aber keine Ischämiezeichen</documentation> </annotation> </enumeration> <enumeration value="0375003"> <annotation> <documentation>stabile Angina</documentation> </annotation> </enumeration> <enumeration value="0375004"> <annotation> <documentation>instabile Angina</documentation> </annotation> </enumeration> <enumeration value="0375005"> <annotation> <documentation>Infarkt ohne ST-Hebung (Non-STEMI)</documentation> </annotation> </enumeration> <enumeration value="0375006"> <annotation> <documentation>Infarkt mit ST-Hebung (STEMI)</documentation> </annotation> </enumeration> <enumeration value="0375042"> <annotation> <documentation>unbekannt</documentation> </annotation> </enumeration> </restriction> </simpleType> </pre>		

	<pre> </restriction> </simpleType> </pre>
--	---

simpleType enum_0376

namespace	http://xml.ir-d.de/irdsa		
type	restriction of string		
properties	base xs:string		
facets	Kind	Value	Annotation
	enumeration	0376001	documentation nein
	enumeration	0376002	documentation ja, ZNS, zerebrovaskuläre Blutung
	enumeration	0376003	documentation ja, ZNS, zerebrovaskuläre Ischämie
	enumeration	0376042	documentation ja, ZNS, andere
annotation	documentation Kat_AK_Schlaganfall		
source	<pre> <simpleType name="enum_0376"> <annotation> <documentation>Kat_AK_Schlaganfall</documentation> </annotation> <restriction base="xs:string"> <enumeration value="0376001"> <annotation> <documentation>nein</documentation> </annotation> </enumeration> <enumeration value="0376002"> <annotation> <documentation>ja, ZNS, zerebrovaskuläre Blutung</documentation> </annotation> </enumeration> <enumeration value="0376003"> <annotation> <documentation>ja, ZNS, zerebrovaskuläre Ischämie</documentation> </annotation> </enumeration> <enumeration value="0376042"> <annotation> <documentation>ja, ZNS, andere</documentation> </annotation> </enumeration> </restriction> </simpleType> </pre>		

simpleType enum_0377

namespace	http://xml.ir-d.de/irdsa		
type	restriction of string		
properties	base xs:string		
facets	Kind	Value	Annotation
	enumeration	0377001	documentation

	<p>enumeration 0377002 ja, mild neurological dysfunction: NIHSS 0-5 documentation</p> <p>enumeration 0377003 ja, moderate neurological dysfunction: NIHSS 6-14 documentation</p> <p>ja, severe neurological dysfunction: NIHSS &gt;=15</p>
annotation	documentation Kat_AK_Nihss
source	<pre> <simpleType name="enum_0377"> <annotation> <documentation>Kat_AK_Nihss</documentation> </annotation> <restriction base="xs:string"> <enumeration value="0377001"> <annotation> <documentation>ja, mild neurological dysfunction: NIHSS 0-5</documentation> </annotation> </enumeration> <enumeration value="0377002"> <annotation> <documentation>ja, moderate neurological dysfunction: NIHSS 6-14</documentation> </annotation> </enumeration> <enumeration value="0377003"> <annotation> <documentation> ja, severe neurological dysfunction: NIHSS &gt;=15</documentation> </annotation> </enumeration> </restriction> </simpleType> </pre>

simpleType enum_0378

namespace	http://xml.ir-d.de/irdsa		
type	restriction of string		
properties	base xs:string		
facets	Kind	Value	Annotation
	enumeration	0378001	documentation nein
	enumeration	0378002	documentation ja, < 48h gemäss VARC-3-Definition
	enumeration	0378003	documentation ja, >= 48h - <= 72h gemäß VARC-3-Definition
	enumeration	0378004	documentation ja, > 72 h gemäß VARC-3 Definition
annotation	documentation Kat_AK_Myokardinfarkt		
source	<pre> <simpleType name="enum_0378"> <annotation> <documentation>Kat_AK_Myokardinfarkt</documentation> </annotation> <restriction base="xs:string"> <enumeration value="0378001"> <annotation> <documentation>nein</documentation> </pre>		

```

</annotation>
</enumeration>
<enumeration value="0378002">
  <annotation>
    <documentation>ja, &lt; 48h gemäss VARC-3-Definition</documentation>
  </annotation>
</enumeration>
<enumeration value="0378003">
  <annotation>
    <documentation>ja, &gt;= 48h - &lt;= 72h gemäß
VARC-3-Definition</documentation>
  </annotation>
</enumeration>
<enumeration value="0378004">
  <annotation>
    <documentation>ja, &gt; 72 h gemäß VARC-3 Definition</documentation>
  </annotation>
</enumeration>
</restriction>
</simpleType>

```

simpleType **enum_0379**

namespace	http://xml.ir-d.de/irdsa		
type	restriction of string		
properties	base xs:string		
facets	Kind	Value	Annotation
	enumeration	0379001	documentation Keine gefäss- oder zugangsassoziierte Komplikationen
	enumeration	0379002	documentation Versagen des perkutanen Verschlusssystems
	enumeration	0379003	documentation Geringfügige Gefäßkomplikationen
	enumeration	0379004	documentation Erhebliche Gefäßkomplikationen
annotation	documentation Kat_AK_ZugangKomplikationen		
source	<pre> <simpleType name="enum_0379"> <annotation> <documentation>Kat_AK_ZugangKomplikationen</documentation> </annotation> <restriction base="xs:string"> <enumeration value="0379001"> <annotation> <documentation>Keine gefäss- oder zugangsassoziierte Komplikationen</documentation> </annotation> </enumeration> <enumeration value="0379002"> <annotation> <documentation>Versagen des perkutanen Verschlusssystems</documentation> </annotation> </enumeration> <enumeration value="0379003"> <annotation> <documentation>Geringfügige Gefäßkomplikationen</documentation> </pre>		

	<pre> </annotation> </enumeration> <enumeration value="0379004"> <annotation> <documentation>Erhebliche Gefäßkomplikationen</documentation> </annotation> </enumeration> </restriction> </simpleType> </pre>
--	--

simpleType enum_0380

namespace	http://xml.ir-d.de/irdsa		
type	restriction of string		
properties	base xs:string		
facets	Kind	Value	Annotation
	enumeration	0380001	documentation nein
	enumeration	0380002	documentation ja, intraprozedural
	enumeration	0380003	documentation ja, postprozedural
	enumeration	0380004	documentation ja, Zeitpunkt nicht bekannt
annotation	documentation Kat_AK_Reanimation		
source	<pre> <simpleType name="enum_0380"> <annotation> <documentation>Kat_AK_Reanimation</documentation> </annotation> <restriction base="xs:string"> <enumeration value="0380001"> <annotation> <documentation>nein</documentation> </annotation> </enumeration> <enumeration value="0380002"> <annotation> <documentation>ja, intraprozedural</documentation> </annotation> </enumeration> <enumeration value="0380003"> <annotation> <documentation>ja, postprozedural</documentation> </annotation> </enumeration> <enumeration value="0380004"> <annotation> <documentation>ja, Zeitpunkt nicht bekannt</documentation> </annotation> </enumeration> </restriction> </simpleType> </pre>		

simpleType enum_0381

namespace	http://xml.ir-d.de/irdsa		
type	restriction of string		
properties	base xs:string		
facets	Kind	Value	Annotation
	enumeration	0381001	documentation nein
	enumeration	0381002	documentation Thorakotomie/Rethorakotomie
	enumeration	0381003	documentation kathetergestützte Reintervention
	enumeration	0381004	documentation lokale Reinterventionen
	enumeration	0381005	documentation andere Reintervention
annotation	documentation Kat_AK_Massnahmen		
source	<pre> <simpleType name="enum_0381"> <annotation> <documentation>Kat_AK_Massnahmen</documentation> </annotation> <restriction base="xs:string"> <enumeration value="0381001"> <annotation> <documentation>nein</documentation> </annotation> </enumeration> <enumeration value="0381002"> <annotation> <documentation>Thorakotomie/Rethorakotomie</documentation> </annotation> </enumeration> <enumeration value="0381003"> <annotation> <documentation>kathetergestützte Reintervention</documentation> </annotation> </enumeration> <enumeration value="0381004"> <annotation> <documentation>lokale Reinterventionen</documentation> </annotation> </enumeration> <enumeration value="0381005"> <annotation> <documentation>andere Reintervention</documentation> </annotation> </enumeration> </restriction> </simpleType> </pre>		

simpleType enum_0382

namespace	http://xml.ir-d.de/irdsa		
type	restriction of string		
properties	base xs:string		

facets	<table border="1"> <thead> <tr> <th data-bbox="293 199 432 226">Kind</th> <th data-bbox="432 199 555 226">Value</th> <th data-bbox="555 199 1434 226">Annotation</th> </tr> </thead> <tbody> <tr> <td data-bbox="293 226 432 253">enumeration</td> <td data-bbox="432 226 555 253">0382001</td> <td data-bbox="555 226 1434 280">documentation keine Rethorakotomie / kein weiterer Grund</td> </tr> <tr> <td data-bbox="293 280 432 306">enumeration</td> <td data-bbox="432 280 555 306">0382002</td> <td data-bbox="555 280 1434 333">documentation Blutung/Hämatom</td> </tr> <tr> <td data-bbox="293 333 432 360">enumeration</td> <td data-bbox="432 333 555 360">0382003</td> <td data-bbox="555 333 1434 387">documentation Low Cardiac Output</td> </tr> <tr> <td data-bbox="293 387 432 414">enumeration</td> <td data-bbox="432 387 555 414">0382004</td> <td data-bbox="555 387 1434 441">documentation Tamponade</td> </tr> <tr> <td data-bbox="293 441 432 468">enumeration</td> <td data-bbox="432 441 555 468">0382005</td> <td data-bbox="555 441 1434 495">documentation Graftprobleme, Ischämie</td> </tr> <tr> <td data-bbox="293 495 432 521">enumeration</td> <td data-bbox="432 495 555 521">0382006</td> <td data-bbox="555 495 1434 548">documentation Wundinfektion, Mediastinitis</td> </tr> <tr> <td data-bbox="293 548 432 575">enumeration</td> <td data-bbox="432 548 555 575">0382007</td> <td data-bbox="555 548 1434 602">documentation Dissektion</td> </tr> <tr> <td data-bbox="293 602 432 629">enumeration</td> <td data-bbox="432 602 555 629">0382008</td> <td data-bbox="555 602 1434 656">documentation Prothesendysfunktion</td> </tr> <tr> <td data-bbox="293 656 432 683">enumeration</td> <td data-bbox="432 656 555 683">0382009</td> <td data-bbox="555 656 1434 710">documentation instabiles Sternum</td> </tr> <tr> <td data-bbox="293 710 432 736">enumeration</td> <td data-bbox="432 710 555 736">0382010</td> <td data-bbox="555 710 1434 763">documentation Chylothorax</td> </tr> <tr> <td data-bbox="293 763 432 790">enumeration</td> <td data-bbox="432 763 555 790">0382011</td> <td data-bbox="555 763 1434 817">documentation lokale Revision im Bereich des Zugangsweges</td> </tr> <tr> <td data-bbox="293 817 432 844">enumeration</td> <td data-bbox="432 817 555 844">0382042</td> <td data-bbox="555 817 1434 871">documentation anderer Grund</td> </tr> </tbody> </table>	Kind	Value	Annotation	enumeration	0382001	documentation keine Rethorakotomie / kein weiterer Grund	enumeration	0382002	documentation Blutung/Hämatom	enumeration	0382003	documentation Low Cardiac Output	enumeration	0382004	documentation Tamponade	enumeration	0382005	documentation Graftprobleme, Ischämie	enumeration	0382006	documentation Wundinfektion, Mediastinitis	enumeration	0382007	documentation Dissektion	enumeration	0382008	documentation Prothesendysfunktion	enumeration	0382009	documentation instabiles Sternum	enumeration	0382010	documentation Chylothorax	enumeration	0382011	documentation lokale Revision im Bereich des Zugangsweges	enumeration	0382042	documentation anderer Grund
Kind	Value	Annotation																																						
enumeration	0382001	documentation keine Rethorakotomie / kein weiterer Grund																																						
enumeration	0382002	documentation Blutung/Hämatom																																						
enumeration	0382003	documentation Low Cardiac Output																																						
enumeration	0382004	documentation Tamponade																																						
enumeration	0382005	documentation Graftprobleme, Ischämie																																						
enumeration	0382006	documentation Wundinfektion, Mediastinitis																																						
enumeration	0382007	documentation Dissektion																																						
enumeration	0382008	documentation Prothesendysfunktion																																						
enumeration	0382009	documentation instabiles Sternum																																						
enumeration	0382010	documentation Chylothorax																																						
enumeration	0382011	documentation lokale Revision im Bereich des Zugangsweges																																						
enumeration	0382042	documentation anderer Grund																																						
annotation	documentation Kat_AK_Komplikation																																							
source	<pre data-bbox="280 972 1270 2024"> <simpleType name="enum_0382"> <annotation> <documentation>Kat_AK_Komplikation</documentation> </annotation> <restriction base="xs:string"> <enumeration value="0382001"> <annotation> <documentation>keine Rethorakotomie / kein weiterer Grund</documentation> </annotation> </enumeration> <enumeration value="0382002"> <annotation> <documentation>Blutung/Hämatom</documentation> </annotation> </enumeration> <enumeration value="0382003"> <annotation> <documentation>Low Cardiac Output</documentation> </annotation> </enumeration> <enumeration value="0382004"> <annotation> <documentation>Tamponade</documentation> </annotation> </enumeration> <enumeration value="0382005"> <annotation> <documentation>Graftprobleme, Ischämie</documentation> </annotation> </enumeration> <enumeration value="0382006"> <annotation> <documentation>Wundinfektion, Mediastinitis</documentation> </annotation> </enumeration> </restriction> </simpleType> </pre>																																							

```

</annotation>
</enumeration>
<enumeration value="0382007">
  <annotation>
    <documentation>Dissektion</documentation>
  </annotation>
</enumeration>
<enumeration value="0382008">
  <annotation>
    <documentation>Prothesendysfunktion</documentation>
  </annotation>
</enumeration>
<enumeration value="0382009">
  <annotation>
    <documentation>instabiles Sternum</documentation>
  </annotation>
</enumeration>
<enumeration value="0382010">
  <annotation>
    <documentation>Chylothorax</documentation>
  </annotation>
</enumeration>
<enumeration value="0382011">
  <annotation>
    <documentation>lokale Revision im Bereich des
Zugangsweges</documentation>
  </annotation>
</enumeration>
<enumeration value="0382042">
  <annotation>
    <documentation>anderer Grund</documentation>
  </annotation>
</enumeration>
</restriction>
</simpleType>

```

simpleType enum 0383

namespace	http://xml.ir-d.de/irdsa		
type	restriction of string		
properties	base xs:string		
facets	Kind	Value	Annotation
	enumeration	0383001	documentation nein
	enumeration	0383002	documentation ja, mit forcierter Atemtherapie
	enumeration	0383003	documentation ja, Reintubation oder längerfristige Beatmung
	enumeration	0383004	documentation ja, Tracheotomie
annotation	documentation Kat_AK_RespiratorischeInsuffizienz		
source	<pre> <simpleType name="enum_0383"> <annotation> <documentation>Kat_AK_RespiratorischeInsuffizienz</documentation> </annotation> <restriction base="xs:string"> </pre>		

	<pre> <enumeration value="0383001"> <annotation> <documentation>nein</documentation> </annotation> </enumeration> <enumeration value="0383002"> <annotation> <documentation>ja, mit forcierter Atemtherapie</documentation> </annotation> </enumeration> <enumeration value="0383003"> <annotation> <documentation>ja, Reintubation oder längerfristige Beatmung</documentation> </annotation> </enumeration> <enumeration value="0383004"> <annotation> <documentation>ja, Tracheotomie</documentation> </annotation> </enumeration> </restriction> </simpleType> </pre>
--	---

simpleType enum_0384

namespace	http://xml.ir-d.de/irdsa		
type	restriction of string		
properties	base xs:string		
facets	Kind	Value	Annotation
	enumeration	0384001	documentation keine Blutungskomplikationen
	enumeration	0384002	documentation Geringfügige Blutung (Minor Bleeding - BARC type 2 or 3a)
	enumeration	0384003	documentation Starke Blutung (Major Bleeding - BARC type 3a)
	enumeration	0384004	documentation Lebensbedrohliche Blutung (Life-threatening or disabling bleeding - BARC type 3b or 3c or type 5)
annotation	documentation Kat_AK_Blutungskomplikation		
source	<pre> <simpleType name="enum_0384"> <annotation> <documentation>Kat_AK_Blutungskomplikation</documentation> </annotation> <restriction base="xs:string"> <enumeration value="0384001"> <annotation> <documentation>keine Blutungskomplikationen</documentation> </annotation> </enumeration> <enumeration value="0384002"> <annotation> <documentation>Geringfügige Blutung (Minor Bleeding - BARC type 2 or 3a)</documentation> </annotation> </enumeration> </restriction> </pre>		

	<pre> <enumeration value="0384003"> <annotation> <documentation>Starke Blutung (Major Bleeding - BARC type 3a)</documentation> </annotation> </enumeration> <enumeration value="0384004"> <annotation> <documentation>Lebensbedrohliche Blutung (Life-threatening or disabling bleeding - BARC type 3b or 3c or type 5)</documentation> </annotation> </enumeration> </restriction> </simpleType> </pre>
--	--

simpleType enum_0385

namespace	http://xml.lir-d.de/irdsa		
type	restriction of string		
properties	base xs:string		
facets	Kind	Value	Annotation
	enumeration	0385001	documentation Sinusrhythmus
	enumeration	0385002	documentation Vorhofflimmern
	enumeration	0385003	documentation Patient verstorben (kein Herzrhythmus)
	enumeration	0385042	documentation anderer Rhythmus
annotation	documentation Kat_AK_HerzrhythmusEntlassung		
source	<pre> <simpleType name="enum_0385"> <annotation> <documentation>Kat_AK_HerzrhythmusEntlassung</documentation> </annotation> <restriction base="xs:string"> <enumeration value="0385001"> <annotation> <documentation>Sinusrhythmus</documentation> </annotation> </enumeration> <enumeration value="0385002"> <annotation> <documentation>Vorhofflimmern</documentation> </annotation> </enumeration> <enumeration value="0385003"> <annotation> <documentation>Patient verstorben (kein Herzrhythmus)</documentation> </annotation> </enumeration> <enumeration value="0385042"> <annotation> <documentation>anderer Rhythmus</documentation> </annotation> </enumeration> </restriction> </pre>		

	<code></simpleType></code>
--	----------------------------------

simpleType **enum_0388**

namespace	http://xml.ir-d.de/irdsa																					
type	restriction of string																					
properties	base xs:string																					
facets	<table><thead><tr><th>Kind</th><th>Value</th><th>Annotation</th></tr></thead><tbody><tr><td>enumeration</td><td>0388001</td><td>documentation nein</td></tr><tr><td>enumeration</td><td>0388002</td><td>documentation ASS</td></tr><tr><td>enumeration</td><td>0388003</td><td>documentation ADP-Rezeptor-Antagonist</td></tr><tr><td>enumeration</td><td>0388004</td><td>documentation Kombination ASS und ADP-Rezeptor-Antagonist</td></tr><tr><td>enumeration</td><td>0388042</td><td>documentation ja, andere</td></tr><tr><td>enumeration</td><td>0388099</td><td>documentation unbekannt</td></tr></tbody></table>	Kind	Value	Annotation	enumeration	0388001	documentation nein	enumeration	0388002	documentation ASS	enumeration	0388003	documentation ADP-Rezeptor-Antagonist	enumeration	0388004	documentation Kombination ASS und ADP-Rezeptor-Antagonist	enumeration	0388042	documentation ja, andere	enumeration	0388099	documentation unbekannt
Kind	Value	Annotation																				
enumeration	0388001	documentation nein																				
enumeration	0388002	documentation ASS																				
enumeration	0388003	documentation ADP-Rezeptor-Antagonist																				
enumeration	0388004	documentation Kombination ASS und ADP-Rezeptor-Antagonist																				
enumeration	0388042	documentation ja, andere																				
enumeration	0388099	documentation unbekannt																				
annotation	documentation Kat AK Plaettchenaggregationshemmer																					
source	<pre><simpleType name="enum_0388"> <annotation> <documentation>Kat_AK_Plaettchenaggregationshemmer</documentation> </annotation> <restriction base="xs:string"> <enumeration value="0388001"> <annotation> <documentation>nein</documentation> </annotation> </enumeration> <enumeration value="0388002"> <annotation> <documentation>ASS</documentation> </annotation> </enumeration> <enumeration value="0388003"> <annotation> <documentation>ADP-Rezeptor-Antagonist</documentation> </annotation> </enumeration> <enumeration value="0388004"> <annotation> <documentation>Kombination ASS und ADP-Rezeptor-Antagonist</documentation> </annotation> </enumeration> <enumeration value="0388042"> <annotation> <documentation>ja, andere</documentation> </annotation> </enumeration> <enumeration value="0388099"> <annotation> <documentation>unbekannt</documentation> </annotation> </enumeration> </restriction> </simpleType></pre>																					

```

</enumeration>
</restriction>
</simpleType>

```

simpleType enum_0389

namespace	http://xml.ir-d.de/irdsa		
type	restriction of string		
properties	base xs:string		
facets	Kind	Value	Annotation
	enumeration	0389001	documentation nein
	enumeration	0389002	documentation Cumarin-Derivate
	enumeration	0389003	documentation Heparinoide
	enumeration	0389004	documentation orale Thrombinantagonisten
	enumeration	0389005	documentation Kombination Heparinoide und Cumarin-Derivate
	enumeration	0389006	documentation Direkte orale Antikoagulantien (DOAK / NOAK)
	enumeration	0389042	documentation ja, andere
	enumeration	0389099	documentation unbekannt
annotation	documentation Kat_AK_Antikoagulantien		
source	<pre> <simpleType name="enum_0389"> <annotation> <documentation>Kat_AK_Antikoagulantien</documentation> </annotation> <restriction base="xs:string"> <enumeration value="0389001"> <annotation> <documentation>nein</documentation> </annotation> </enumeration> <enumeration value="0389002"> <annotation> <documentation>Cumarin-Derivate</documentation> </annotation> </enumeration> <enumeration value="0389003"> <annotation> <documentation>Heparinoide</documentation> </annotation> </enumeration> <enumeration value="0389004"> <annotation> <documentation>orale Thrombinantagonisten</documentation> </annotation> </enumeration> <enumeration value="0389005"> <annotation> <documentation>Kombination Heparinoide und Cumarin-Derivate</documentation> </annotation> </enumeration> </restriction> </simpleType> </pre>		

	<pre> </enumeration> <enumeration value="0389006"> <annotation> <documentation>Direkte orale Antikoagulantien (DOAK / NOAK)</documentation> </annotation> </enumeration> <enumeration value="0389042"> <annotation> <documentation>ja, andere</documentation> </annotation> </enumeration> <enumeration value="0389099"> <annotation> <documentation>unbekannt</documentation> </annotation> </enumeration> </restriction> </simpleType> </pre>
--	---

simpleType enum_0390

namespace	http://xml.ir-d.de/irdsa		
type	restriction of string		
properties	base xs:string		
facets	Kind	Value	Annotation
	enumeration	0390001	documentation biologisches Klappenmodell
	enumeration	0390002	documentation mechanisches Klappenmodell
annotation	documentation Kat_AK_Artikeltyp		
source	<pre> <simpleType name="enum_0390"> <annotation> <documentation>Kat_AK_Artikeltyp</documentation> </annotation> <restriction base="xs:string"> <enumeration value="0390001"> <annotation> <documentation>biologisches Klappenmodell</documentation> </annotation> </enumeration> <enumeration value="0390002"> <annotation> <documentation>mechanisches Klappenmodell</documentation> </annotation> </enumeration> </restriction> </simpleType> </pre>		

simpleType enum_0398

namespace	http://xml.ir-d.de/irdsa
type	restriction of string

properties	base xs:string												
facets	<table border="1"> <thead> <tr> <th>Kind</th> <th>Value</th> <th>Annotation</th> </tr> </thead> <tbody> <tr> <td>enumeration</td> <td>0398001</td> <td>documentation kardiovaskuläre Ursache</td> </tr> <tr> <td>enumeration</td> <td>0398002</td> <td>documentation nicht-kardiovaskuläre Ursache</td> </tr> <tr> <td>enumeration</td> <td>0398099</td> <td>documentation Todesursache unbekannt</td> </tr> </tbody> </table>	Kind	Value	Annotation	enumeration	0398001	documentation kardiovaskuläre Ursache	enumeration	0398002	documentation nicht-kardiovaskuläre Ursache	enumeration	0398099	documentation Todesursache unbekannt
Kind	Value	Annotation											
enumeration	0398001	documentation kardiovaskuläre Ursache											
enumeration	0398002	documentation nicht-kardiovaskuläre Ursache											
enumeration	0398099	documentation Todesursache unbekannt											
annotation	documentation Kat AK Todesursache												
source	<pre><simpleType name="enum_0398"> <annotation> <documentation>Kat_AK_Todesursache</documentation> </annotation> <restriction base="xs:string"> <enumeration value="0398001"> <annotation> <documentation>kardiovaskuläre Ursache</documentation> </annotation> </enumeration> <enumeration value="0398002"> <annotation> <documentation>nicht-kardiovaskuläre Ursache</documentation> </annotation> </enumeration> <enumeration value="0398099"> <annotation> <documentation>Todesursache unbekannt</documentation> </annotation> </enumeration> </restriction> </simpleType></pre>												

simpleType enum_0399

namespace	http://xml.ir-d.de/irdsa									
type	restriction of string									
properties	base xs:string									
facets	<table border="1"> <thead> <tr> <th>Kind</th> <th>Value</th> <th>Annotation</th> </tr> </thead> <tbody> <tr> <td>enumeration</td> <td>0399001</td> <td>documentation Patient lebt</td> </tr> <tr> <td>enumeration</td> <td>0399002</td> <td>documentation Patient im Krankenhaus verstorben</td> </tr> </tbody> </table>	Kind	Value	Annotation	enumeration	0399001	documentation Patient lebt	enumeration	0399002	documentation Patient im Krankenhaus verstorben
Kind	Value	Annotation								
enumeration	0399001	documentation Patient lebt								
enumeration	0399002	documentation Patient im Krankenhaus verstorben								
annotation	documentation Kat AK Vitalstatus									
source	<pre><simpleType name="enum_0399"> <annotation> <documentation>Kat_AK_Vitalstatus</documentation> </annotation> <restriction base="xs:string"> <enumeration value="0399001"> <annotation> <documentation>Patient lebt</documentation> </annotation> </enumeration> <enumeration value="0399002"></pre>									

	<pre> <annotation> <documentation>Patient im Krankenhaus verstorben</documentation> </annotation> </enumeration> </restriction> </simpleType> </pre>
--	--

simpleType enum_0044

namespace	http://xml.ir-d.de/sak		
type	restriction of string		
properties	base xs:string		
facets	Kind	Value	Annotation
	enumeration	0044001	documentation 1= normaler, sonst gesunder Patient
	enumeration	0044002	documentation 2= Patient mit leichter Allgemeinerkrankung
	enumeration	0044003	documentation 3= Patient mit schwerer Allgemeinerkrankung
	enumeration	0044004	documentation 4= Patient mit schwerer Allgemeinerkrankung, die eine ständige Lebensbedrohung darstellt
	enumeration	0044005	documentation 5= moribunder Patient, der ohne die Operation voraussichtlich nicht überleben wird
annotation	documentation Kat_ASA		
source	<pre> <simpleType name="enum_0044"> <annotation> <documentation>Kat_ASA</documentation> </annotation> <restriction base="xs:string"> <enumeration value="0044001"> <annotation> <documentation>1= normaler, sonst gesunder Patient</documentation> </annotation> </enumeration> <enumeration value="0044002"> <annotation> <documentation>2= Patient mit leichter Allgemeinerkrankung</documentation> </annotation> </enumeration> <enumeration value="0044003"> <annotation> <documentation>3= Patient mit schwerer Allgemeinerkrankung</documentation> </annotation> </enumeration> <enumeration value="0044004"> <annotation> <documentation>4= Patient mit schwerer Allgemeinerkrankung, die eine ständige Lebensbedrohung darstellt</documentation> </annotation> </enumeration> <enumeration value="0044005"> <annotation> <documentation>5= moribunder Patient, der ohne die Operation </pre>		

	<pre> voraussichtlich nicht überleben wird</documentation> </annotation> </enumeration> </restriction> </simpleType> </pre>
--	---

simpleType enum_0050

namespace	http://xml.ir-d.de/sak		
type	restriction of string		
properties	base xs:string		
facets	Kind	Value	Annotation
	enumeration	0050001	documentation rechts
	enumeration	0050002	documentation links
annotation	documentation Kat_RechtsLinks		
source	<pre> <simpleType name="enum_0050"> <annotation> <documentation>Kat_RechtsLinks</documentation> </annotation> <restriction base="xs:string"> <enumeration value="0050001"> <annotation> <documentation>rechts</documentation> </annotation> </enumeration> <enumeration value="0050002"> <annotation> <documentation>links</documentation> </annotation> </enumeration> </restriction> </simpleType> </pre>		

simpleType enum_0060

namespace	http://xml.ir-d.de/sak		
type	restriction of string		
properties	base xs:string		
facets	Kind	Value	Annotation
	enumeration	0060001	documentation ja
	enumeration	0060002	documentation nein
annotation	documentation Kat_JaNein		
source	<pre> <simpleType name="enum_0060"> <annotation> <documentation>Kat_JaNein</documentation> </annotation> <restriction base="xs:string"> <enumeration value="0060001"> </pre>		

	<pre> <annotation> <documentation>ja</documentation> </annotation> </enumeration> <enumeration value="0060002"> <annotation> <documentation>nein</documentation> </annotation> </enumeration> </restriction> </simpleType> </pre>
--	---

simpleType enum_0061

namespace	http://xml.ir-d.de/sak		
type	restriction of string		
properties	base xs:string		
facets	Kind	Value	Annotation
	enumeration	0061001	documentation ja
	enumeration	0061002	documentation nein
	enumeration	0061099	documentation unbekannt
annotation	documentation Kat_JaNeinUnbekannt		
source	<pre> <simpleType name="enum_0061"> <annotation> <documentation>Kat_JaNeinUnbekannt</documentation> </annotation> <restriction base="xs:string"> <enumeration value="0061001"> <annotation> <documentation>ja</documentation> </annotation> </enumeration> <enumeration value="0061002"> <annotation> <documentation>nein</documentation> </annotation> </enumeration> <enumeration value="0061099"> <annotation> <documentation>unbekannt</documentation> </annotation> </enumeration> </restriction> </simpleType> </pre>		

simpleType enum_0062

namespace	http://xml.ir-d.de/sak		
type	restriction of string		
properties	base xs:string		

facets	<table border="1"> <thead> <tr> <th data-bbox="293 199 432 226">Kind</th> <th data-bbox="432 199 555 226">Value</th> <th data-bbox="555 199 1434 226">Annotation</th> </tr> </thead> <tbody> <tr> <td data-bbox="293 226 432 277">enumeration</td> <td data-bbox="432 226 555 277">0062001</td> <td data-bbox="555 226 1434 277">documentation Stück</td> </tr> <tr> <td data-bbox="293 277 432 329">enumeration</td> <td data-bbox="432 277 555 329">0062002</td> <td data-bbox="555 277 1434 329">documentation g</td> </tr> <tr> <td data-bbox="293 329 432 380">enumeration</td> <td data-bbox="432 329 555 380">0062003</td> <td data-bbox="555 329 1434 380">documentation mg</td> </tr> <tr> <td data-bbox="293 380 432 432">enumeration</td> <td data-bbox="432 380 555 432">0062004</td> <td data-bbox="555 380 1434 432">documentation l</td> </tr> <tr> <td data-bbox="293 432 432 483">enumeration</td> <td data-bbox="432 432 555 483">0062005</td> <td data-bbox="555 432 1434 483">documentation ml</td> </tr> <tr> <td data-bbox="293 483 432 535">enumeration</td> <td data-bbox="432 483 555 535">0062006</td> <td data-bbox="555 483 1434 535">documentation cm³</td> </tr> <tr> <td data-bbox="293 535 432 586">enumeration</td> <td data-bbox="432 535 555 586">0062007</td> <td data-bbox="555 535 1434 586">documentation mm</td> </tr> <tr> <td data-bbox="293 586 432 638">enumeration</td> <td data-bbox="432 586 555 638">0062008</td> <td data-bbox="555 586 1434 638">documentation cm</td> </tr> <tr> <td data-bbox="293 638 432 689">enumeration</td> <td data-bbox="432 638 555 689">0062009</td> <td data-bbox="555 638 1434 689">documentation dm</td> </tr> <tr> <td data-bbox="293 689 432 741">enumeration</td> <td data-bbox="432 689 555 741">0062010</td> <td data-bbox="555 689 1434 741">documentation m</td> </tr> <tr> <td data-bbox="293 741 432 846">enumeration</td> <td data-bbox="432 741 555 846">0062042</td> <td data-bbox="555 741 1434 846">documentation andere</td> </tr> </tbody> </table>	Kind	Value	Annotation	enumeration	0062001	documentation Stück	enumeration	0062002	documentation g	enumeration	0062003	documentation mg	enumeration	0062004	documentation l	enumeration	0062005	documentation ml	enumeration	0062006	documentation cm ³	enumeration	0062007	documentation mm	enumeration	0062008	documentation cm	enumeration	0062009	documentation dm	enumeration	0062010	documentation m	enumeration	0062042	documentation andere
Kind	Value	Annotation																																			
enumeration	0062001	documentation Stück																																			
enumeration	0062002	documentation g																																			
enumeration	0062003	documentation mg																																			
enumeration	0062004	documentation l																																			
enumeration	0062005	documentation ml																																			
enumeration	0062006	documentation cm ³																																			
enumeration	0062007	documentation mm																																			
enumeration	0062008	documentation cm																																			
enumeration	0062009	documentation dm																																			
enumeration	0062010	documentation m																																			
enumeration	0062042	documentation andere																																			
annotation	documentation Kat_Einheit																																				
source	<pre data-bbox="280 913 962 2031"> <simpleType name="enum_0062"> <annotation> <documentation>Kat_Einheit</documentation> </annotation> <restriction base="xs:string"> <enumeration value="0062001"> <annotation> <documentation>Stück</documentation> </annotation> </enumeration> <enumeration value="0062002"> <annotation> <documentation>g</documentation> </annotation> </enumeration> <enumeration value="0062003"> <annotation> <documentation>mg</documentation> </annotation> </enumeration> <enumeration value="0062004"> <annotation> <documentation>l</documentation> </annotation> </enumeration> <enumeration value="0062005"> <annotation> <documentation>ml</documentation> </annotation> </enumeration> <enumeration value="0062006"> <annotation> <documentation>cm³</documentation> </annotation> </enumeration> <enumeration value="0062007"> </pre>																																				

	<pre> <annotation> <documentation>mm</documentation> </annotation> </enumeration> <enumeration value="0062008"> <annotation> <documentation>cm</documentation> </annotation> </enumeration> <enumeration value="0062009"> <annotation> <documentation>dm</documentation> </annotation> </enumeration> <enumeration value="0062010"> <annotation> <documentation>m</documentation> </annotation> </enumeration> <enumeration value="0062042"> <annotation> <documentation>andere</documentation> </annotation> </enumeration> </restriction> </simpleType> </pre>
--	--

simpleType enum_0065

namespace	http://xml.ir-d.de/sak		
type	restriction of string		
properties	base xs:string		
facets	Kind	Value	Annotation
	enumeration	0065001	documentation stationär
	enumeration	0065002	documentation teilstationär
	enumeration	0065003	documentation ambulant
annotation	documentation Kat ArtAufenthalt		
source	<pre> <simpleType name="enum_0065"> <annotation> <documentation>Kat_ArtAufenthalt</documentation> </annotation> <restriction base="xs:string"> <enumeration value="0065001"> <annotation> <documentation>stationär</documentation> </annotation> </enumeration> <enumeration value="0065002"> <annotation> <documentation>teilstationär</documentation> </annotation> </enumeration> <enumeration value="0065003"> </pre>		

	<pre> <annotation> <documentation>ambulant</documentation> </annotation> </enumeration> </restriction> </simpleType> </pre>
--	---

simpleType enum_0067

namespace	http://xml.ir-d.de/sak		
type	restriction of string		
properties	base xs:string		
facets	Kind	Value	Annotation
	enumeration	0067001	documentation Implantat
	enumeration	0067002	documentation Explantat
annotation	documentation Kat_ArtArtikel		
source	<pre> <simpleType name="enum_0067"> <annotation> <documentation>Kat_ArtArtikel</documentation> </annotation> <restriction base="xs:string"> <enumeration value="0067001"> <annotation> <documentation>Implantat</documentation> </annotation> </enumeration> <enumeration value="0067002"> <annotation> <documentation>Explantat</documentation> </annotation> </enumeration> </restriction> </simpleType> </pre>		

simpleType enum_0068

namespace	http://xml.ir-d.de/sak		
type	restriction of string		
properties	base xs:string		
facets	Kind	Value	Annotation
	enumeration	0068001	documentation UDI
	enumeration	0068002	documentation Referenz (REF)
	enumeration	0068003	documentation Katalognummer
	enumeration	0068042	documentation sonstiger
annotation	documentation Kat_KennzeichenTyp		
source	<pre> <simpleType name="enum_0068"> </pre>		

	<pre> <annotation> <documentation>Kat_KennzeichenTyp</documentation> </annotation> <restriction base="xs:string"> <enumeration value="0068001"> <annotation> <documentation>UDI</documentation> </annotation> </enumeration> <enumeration value="0068002"> <annotation> <documentation>Referenz (REF)</documentation> </annotation> </enumeration> <enumeration value="0068003"> <annotation> <documentation>Katalognummer</documentation> </annotation> </enumeration> <enumeration value="0068042"> <annotation> <documentation>sonstiger</documentation> </annotation> </enumeration> </restriction> </simpleType> </pre>
--	--

simpleType enum_0069

namespace	http://xml.ir-d.de/sak		
type	restriction of string		
properties	base xs:string		
facets	Kind	Value	Annotation
	enumeration	0069001	documentation Implantat
	enumeration	0069002	documentation Explantat
annotation	documentation Kat_ArtZubehoer		
source	<pre> <simpleType name="enum_0069"> <annotation> <documentation>Kat_ArtZubehoer</documentation> </annotation> <restriction base="xs:string"> <enumeration value="0069001"> <annotation> <documentation>Implantat</documentation> </annotation> </enumeration> <enumeration value="0069002"> <annotation> <documentation>Explantat</documentation> </annotation> </enumeration> </restriction> </simpleType> </pre>		

simpleType enum_0070

namespace	http://xml.ir-d.de/sak		
type	restriction of string		
properties	base xs:string		
facets	Kind	Value	Annotation
	enumeration	0070001	documentation weiblich
	enumeration	0070002	documentation männlich
	enumeration	0070003	documentation divers
	enumeration	0070042	documentation unbestimmt
annotation	documentation Kat Geschlecht		
source	<pre> <simpleType name="enum_0070"> <annotation> <documentation>Kat_Geschlecht</documentation> </annotation> <restriction base="xs:string"> <enumeration value="0070001"> <annotation> <documentation>weiblich</documentation> </annotation> </enumeration> <enumeration value="0070002"> <annotation> <documentation>männlich</documentation> </annotation> </enumeration> <enumeration value="0070003"> <annotation> <documentation>divers</documentation> </annotation> </enumeration> <enumeration value="0070042"> <annotation> <documentation>unbestimmt</documentation> </annotation> </enumeration> </restriction> </simpleType> </pre>		

simpleType enum_0071

namespace	http://xml.ir-d.de/sak		
type	restriction of string		
properties	base xs:string		
facets	Kind	Value	Annotation
	enumeration	0071001	documentation Implantat
	enumeration	0071002	documentation Explantat

	enumeration 0071003 documentation Degeneriertes/defektes Produkt, das funktionslos im Körper verbleibt
annotation	documentation Kat_ArtikelArtFunktion
source	<pre> <simpleType name="enum_0071"> <annotation> <documentation>Kat_ArtikelArtFunktion</documentation> </annotation> <restriction base="xs:string"> <enumeration value="0071001"> <annotation> <documentation>Implantat</documentation> </annotation> </enumeration> <enumeration value="0071002"> <annotation> <documentation>Explantat</documentation> </annotation> </enumeration> <enumeration value="0071003"> <annotation> <documentation>Degeneriertes/defektes Produkt, das funktionslos im Körper verbleibt</documentation> </annotation> </enumeration> </restriction> </simpleType> </pre>

simpleType enum_0075

namespace	http://xml.ir-d.de/sak		
type	restriction of string		
properties	base xs:string		
facets	Kind	Value	Annotation
	enumeration	0075001	documentation elektiv
	enumeration	0075002	documentation dringlich
	enumeration	0075003	documentation Notfall
annotation	documentation Kat_Dringlichkeit		
source	<pre> <simpleType name="enum_0075"> <annotation> <documentation>Kat_Dringlichkeit</documentation> </annotation> <restriction base="xs:string"> <enumeration value="0075001"> <annotation> <documentation>elektiv</documentation> </annotation> </enumeration> <enumeration value="0075002"> <annotation> <documentation>dringlich</documentation> </annotation> </enumeration> </restriction> </simpleType> </pre>		

	<pre> <enumeration value="0075003"> <annotation> <documentation>Notfall</documentation> </annotation> </enumeration> </restriction> </simpleType> </pre>
--	--

simpleType enum_0076

namespace	http://xml.ir-d.de/sak		
type	restriction of string		
properties	base xs:string		
facets	Kind	Value	Annotation
	enumeration	0076001	documentation elektiv
	enumeration	0076002	documentation dringlich
	enumeration	0076003	documentation Notfall
	enumeration	0076004	documentation Notfall (Reanimation / ultima ratio)
annotation	documentation Kat_Dringlichkeit_Reanimation		
source	<pre> <simpleType name="enum_0076"> <annotation> <documentation>Kat_Dringlichkeit_Reanimation</documentation> </annotation> <restriction base="xs:string"> <enumeration value="0076001"> <annotation> <documentation>elektiv</documentation> </annotation> </enumeration> <enumeration value="0076002"> <annotation> <documentation>dringlich</documentation> </annotation> </enumeration> <enumeration value="0076003"> <annotation> <documentation>Notfall</documentation> </annotation> </enumeration> <enumeration value="0076004"> <annotation> <documentation>Notfall (Reanimation / ultima ratio)</documentation> </annotation> </enumeration> </restriction> </simpleType> </pre>		

simpleType enum_0080

namespace	http://xml.ir-d.de/sak
-----------	------------------------

type	restriction of string												
properties	base xs:string												
facets	<table border="1"> <thead> <tr> <th>Kind</th> <th>Value</th> <th>Annotation</th> </tr> </thead> <tbody> <tr> <td>enumeration</td> <td>0080001</td> <td>documentation Endoprothese Hüfte/Knie</td> </tr> <tr> <td>enumeration</td> <td>0080002</td> <td>documentation Brustimplantat</td> </tr> <tr> <td>enumeration</td> <td>0080003</td> <td>documentation Aortenklappenprothese</td> </tr> </tbody> </table>	Kind	Value	Annotation	enumeration	0080001	documentation Endoprothese Hüfte/Knie	enumeration	0080002	documentation Brustimplantat	enumeration	0080003	documentation Aortenklappenprothese
Kind	Value	Annotation											
enumeration	0080001	documentation Endoprothese Hüfte/Knie											
enumeration	0080002	documentation Brustimplantat											
enumeration	0080003	documentation Aortenklappenprothese											
annotation	documentation Kat_Implantattyp												
source	<pre> <simpleType name="enum_0080"> <annotation> <documentation>Kat_Implantattyp</documentation> </annotation> <restriction base="xs:string"> <enumeration value="0080001"> <annotation> <documentation>Endoprothese Hüfte/Knie</documentation> </annotation> </enumeration> <enumeration value="0080002"> <annotation> <documentation>Brustimplantat</documentation> </annotation> </enumeration> <enumeration value="0080003"> <annotation> <documentation>Aortenklappenprothese</documentation> </annotation> </enumeration> </restriction> </simpleType> </pre>												

simpleType **enum_0100**

namespace	http://xml.ir-d.de/sak															
type	restriction of string															
properties	base xs:string															
facets	<table border="1"> <thead> <tr> <th>Kind</th> <th>Value</th> <th>Annotation</th> </tr> </thead> <tbody> <tr> <td>enumeration</td> <td>0100001</td> <td>documentation Primäreingriff</td> </tr> <tr> <td>enumeration</td> <td>0100002</td> <td>documentation Austausch Expander gegen dauerhaftes Brustimplantat</td> </tr> <tr> <td>enumeration</td> <td>0100003</td> <td>documentation Revision</td> </tr> <tr> <td>enumeration</td> <td>0100004</td> <td>documentation Nur Explantation</td> </tr> </tbody> </table>	Kind	Value	Annotation	enumeration	0100001	documentation Primäreingriff	enumeration	0100002	documentation Austausch Expander gegen dauerhaftes Brustimplantat	enumeration	0100003	documentation Revision	enumeration	0100004	documentation Nur Explantation
Kind	Value	Annotation														
enumeration	0100001	documentation Primäreingriff														
enumeration	0100002	documentation Austausch Expander gegen dauerhaftes Brustimplantat														
enumeration	0100003	documentation Revision														
enumeration	0100004	documentation Nur Explantation														
annotation	documentation Kat_BI_ArtEingriff															
source	<pre> <simpleType name="enum_0100"> <annotation> <documentation>Kat_BI_ArtEingriff</documentation> </annotation> <restriction base="xs:string"> <enumeration value="0100001"> </pre>															

	<pre> <annotation> <documentation>Primäreingriff</documentation> </annotation> </enumeration> <enumeration value="0100002"> <annotation> <documentation>Austausch Expander gegen dauerhaftes Brustimplantat</documentation> </annotation> </enumeration> <enumeration value="0100003"> <annotation> <documentation>Revision</documentation> </annotation> </enumeration> <enumeration value="0100004"> <annotation> <documentation>Nur Explantation</documentation> </annotation> </enumeration> </restriction> </simpleType> </pre>
--	--

simpleType enum_0102

namespace	http://xml.ir-d.de/sak		
type	restriction of string		
properties	base xs:string		
facets	Kind	Value	Annotation
	enumeration	0102001	documentation kosmetische Augmentation
	enumeration	0102002	documentation Rekonstruktion, benigne
	enumeration	0102003	documentation Rekonstruktion nach Mastektomie aufgrund eines Karzinoms
	enumeration	0102004	documentation Rekonstruktion nach risikoreduzierender Mastektomie
annotation	documentation Kat_BI_GrundPrimaereingriff		
source	<pre> <simpleType name="enum_0102"> <annotation> <documentation>Kat_BI_GrundPrimaereingriff</documentation> </annotation> <restriction base="xs:string"> <enumeration value="0102001"> <annotation> <documentation>kosmetische Augmentation</documentation> </annotation> </enumeration> <enumeration value="0102002"> <annotation> <documentation>Rekonstruktion, benigne</documentation> </annotation> </enumeration> <enumeration value="0102003"> <annotation> <documentation>Rekonstruktion nach Mastektomie aufgrund eines </pre>		

	<pre> Karzinoms</documentation> </annotation> </enumeration> <enumeration value="0102004"> <annotation> <documentation>Rekonstruktion nach risikoreduzierender Mastektomie</documentation> </annotation> </enumeration> </restriction> </simpleType> </pre>
--	---

simpleType enum_0103

namespace	http://xml.ir-d.de/sak		
type	restriction of string		
properties	base xs:string		
facets	Kind	Value	Annotation
	enumeration	0103001	documentation simultane Lappendeckung
	enumeration	0103002	documentation simultane Eigenfetttransplantation
	enumeration	0103003	documentation simultane Mastopexie
	enumeration	0103005	documentation simultane Mastektomie, Ablatio / hautsparend
	enumeration	0103006	documentation simultane Mastektomie, nippelerhaltend
	enumeration	0103007	documentation Axilla-Dissektion
	enumeration	0103008	documentation Drainage
annotation	documentation Kat_BI_OperationsdetailPrimaereingriff		
source	<pre> <simpleType name="enum_0103"> <annotation> <documentation>Kat_BI_OperationsdetailPrimaereingriff</documentation> </annotation> <restriction base="xs:string"> <enumeration value="0103001"> <annotation> <documentation>simultane Lappendeckung</documentation> </annotation> </enumeration> <enumeration value="0103002"> <annotation> <documentation>simultane Eigenfetttransplantation</documentation> </annotation> </enumeration> <enumeration value="0103003"> <annotation> <documentation>simultane Mastopexie</documentation> </annotation> </enumeration> <enumeration value="0103005"> <annotation> <documentation>simultane Mastektomie, Ablatio / </pre>		

	<pre> hautsparend</documentation> </annotation> </enumeration> <enumeration value="0103006"> <annotation> <documentation>simultane Mastektomie, nippelerhaltend</documentation> </annotation> </enumeration> <enumeration value="0103007"> <annotation> <documentation>Axilla-Dissektion</documentation> </annotation> </enumeration> <enumeration value="0103008"> <annotation> <documentation>Drainage</documentation> </annotation> </enumeration> </restriction> </simpleType> </pre>
--	---

simpleType enum_0104

namespace	http://xml.ir-d.de/sak		
type	restriction of string		
properties	base xs:string		
facets	Kind	Value	Annotation
	enumeration	0104001	documentation Austausch Expander gegen dauerhaftes Brustimplantat
annotation	documentation Kat_BI_GrundAustausch		
source	<pre> <simpleType name="enum_0104"> <annotation> <documentation>Kat_BI_GrundAustausch</documentation> </annotation> <restriction base="xs:string"> <enumeration value="0104001"> <annotation> <documentation>Austausch Expander gegen dauerhaftes Brustimplantat</documentation> </annotation> </enumeration> </restriction> </simpleType> </pre>		

simpleType enum_0105

namespace	http://xml.ir-d.de/sak		
type	restriction of string		
properties	base xs:string		
facets	Kind	Value	Annotation
	enumeration	0105001	documentation simultane Lappendeckung
	enumeration	0105002	documentation

	<p>enumeration 0105003 simultane Eigenfetttransplantation documentation</p> <p>enumeration 0105008 simultane Mastopexie documentation</p> <p>enumeration 0105009 Drainage documentation</p> <p>enumeration 0105010 Kapsulektomie, komplett documentation</p> <p>enumeration 0105011 Kapsulektomie, partiell documentation</p> <p>Neopocket</p>
annotation	<p>documentation Kat_BI_OperationsdetailAustausch</p>
source	<pre> <simpleType name="enum_0105"> <annotation> <documentation>Kat_BI_OperationsdetailAustausch</documentation> </annotation> <restriction base="xs:string"> <enumeration value="0105001"> <annotation> <documentation>simultane Lappendeckung</documentation> </annotation> </enumeration> <enumeration value="0105002"> <annotation> <documentation>simultane Eigenfetttransplantation</documentation> </annotation> </enumeration> <enumeration value="0105003"> <annotation> <documentation>simultane Mastopexie</documentation> </annotation> </enumeration> <enumeration value="0105008"> <annotation> <documentation>Drainage</documentation> </annotation> </enumeration> <enumeration value="0105009"> <annotation> <documentation>Kapsulektomie, komplett</documentation> </annotation> </enumeration> <enumeration value="0105010"> <annotation> <documentation>Kapsulektomie, partiell</documentation> </annotation> </enumeration> <enumeration value="0105011"> <annotation> <documentation>Neopocket</documentation> </annotation> </enumeration> </restriction> </simpleType> </pre>

simpleType enum_0106

namespace	http://xml.ir-d.de/sak		
type	restriction of string		
properties	base xs:string		
facets	Kind	Value	Annotation
	enumeration	0106001	documentation Patientenwunsch
	enumeration	0106002	documentation asymptomatisch
	enumeration	0106003	documentation Komplikation
annotation	documentation Kat_BI_GrundRevisionExplantation		
source	<pre> <simpleType name="enum_0106"> <annotation> <documentation>Kat_BI_GrundRevisionExplantation</documentation> </annotation> <restriction base="xs:string"> <enumeration value="0106001"> <annotation> <documentation>Patientenwunsch</documentation> </annotation> </enumeration> <enumeration value="0106002"> <annotation> <documentation>asymptomatisch</documentation> </annotation> </enumeration> <enumeration value="0106003"> <annotation> <documentation>Komplikation</documentation> </annotation> </enumeration> </restriction> </simpleType> </pre>		

simpleType enum_0107

namespace	http://xml.ir-d.de/sak		
type	restriction of string		
properties	base xs:string		
facets	Kind	Value	Annotation
	enumeration	0107001	documentation simultane Lappendeckung
	enumeration	0107002	documentation simultane Eigenfetttransplantation
	enumeration	0107003	documentation simultane Mastopexie
	enumeration	0107005	documentation simultane Mastektomie, Ablatio / hautsparend
	enumeration	0107006	documentation simultane Mastektomie, nippelerhaltend
	enumeration	0107007	documentation Axilla-Dissektion
	enumeration	0107008	documentation Drainage

	<p>enumeration 0107009 documentation Kapsulektomie, komplett</p> <p>enumeration 0107010 documentation Kapsulektomie, partiell</p> <p>enumeration 0107011 documentation Neopocket</p>
annotation	documentation Kat_BI_OperationsdetailRevision
source	<pre> <simpleType name="enum_0107"> <annotation> <documentation>Kat_BI_OperationsdetailRevision</documentation> </annotation> <restriction base="xs:string"> <enumeration value="0107001"> <annotation> <documentation>simultane Lappendeckung</documentation> </annotation> </enumeration> <enumeration value="0107002"> <annotation> <documentation>simultane Eigenfetttransplantation</documentation> </annotation> </enumeration> <enumeration value="0107003"> <annotation> <documentation>simultane Mastopexie</documentation> </annotation> </enumeration> <enumeration value="0107005"> <annotation> <documentation>simultane Mastektomie, Ablatio / hautsparend</documentation> </annotation> </enumeration> <enumeration value="0107006"> <annotation> <documentation>simultane Mastektomie, nippelerhaltend</documentation> </annotation> </enumeration> <enumeration value="0107007"> <annotation> <documentation>Axilla-Dissektion</documentation> </annotation> </enumeration> <enumeration value="0107008"> <annotation> <documentation>Drainage</documentation> </annotation> </enumeration> <enumeration value="0107009"> <annotation> <documentation>Kapsulektomie, komplett</documentation> </annotation> </enumeration> <enumeration value="0107010"> <annotation> <documentation>Kapsulektomie, partiell</documentation> </annotation> </enumeration> </restriction> </simpleType> </pre>

	<pre> <enumeration value="0107011"> <annotation> <documentation>Neopocket</documentation> </annotation> </enumeration> </restriction> </simpleType> </pre>
--	--

simpleType enum_0110

namespace	http://xml.ir-d.de/sak		
type	restriction of string		
properties	base xs:string		
facets	Kind	Value	Annotation
	enumeration	0110001	documentation Bestrahlung
annotation	documentation Kat_BI_VorbehandlungLokal		
source	<pre> <simpleType name="enum_0110"> <annotation> <documentation>Kat_BI_VorbehandlungLokal</documentation> </annotation> <restriction base="xs:string"> <enumeration value="0110001"> <annotation> <documentation>Bestrahlung</documentation> </annotation> </enumeration> </restriction> </simpleType> </pre>		

simpleType enum_0111

namespace	http://xml.ir-d.de/sak		
type	restriction of string		
properties	base xs:string		
facets	Kind	Value	Annotation
	enumeration	0111001	documentation nein
	enumeration	0111002	documentation Lipofilling
	enumeration	0111003	documentation Eigengewebstrekonstruktion
annotation	documentation Kat_BI_Verfahrenswechsel		
source	<pre> <simpleType name="enum_0111"> <annotation> <documentation>Kat_BI_Verfahrenswechsel</documentation> </annotation> <restriction base="xs:string"> <enumeration value="0111001"> <annotation> <documentation>nein</documentation> </annotation> </enumeration> </restriction> </simpleType> </pre>		

	<pre> </enumeration> <enumeration value="0111002"> <annotation> <documentation>Lipofilling</documentation> </annotation> </enumeration> <enumeration value="0111003"> <annotation> <documentation>Eigengewebsrekonstruktion</documentation> </annotation> </enumeration> </restriction> </simpleType> </pre>
--	--

simpleType enum_0112

namespace	http://xml.ir-d.de/sak		
type	restriction of string		
properties	base xs:string		
facets	Kind	Value	Annotation
	enumeration	0112001	documentation subglandulär / epipektoral
	enumeration	0112002	documentation subpektoral
	enumeration	0112003	documentation subfaszial
	enumeration	0112004	documentation sub-flap
	enumeration	0112005	documentation subkutan
	enumeration	0112006	documentation dual plane
	enumeration	0112042	documentation andere
annotation	documentation Kat_BI_LageImplantat		
source	<pre> <simpleType name="enum_0112"> <annotation> <documentation>Kat_BI_LageImplantat</documentation> </annotation> <restriction base="xs:string"> <enumeration value="0112001"> <annotation> <documentation>subglandulär / epipektoral</documentation> </annotation> </enumeration> <enumeration value="0112002"> <annotation> <documentation>subpektoral</documentation> </annotation> </enumeration> <enumeration value="0112003"> <annotation> <documentation>subfaszial</documentation> </annotation> </enumeration> <enumeration value="0112004"> </pre>		

	<pre> <annotation> <documentation>sub-flap</documentation> </annotation> </enumeration> <enumeration value="0112005"> <annotation> <documentation>subkutan</documentation> </annotation> </enumeration> <enumeration value="0112006"> <annotation> <documentation>dual plane</documentation> </annotation> </enumeration> <enumeration value="0112042"> <annotation> <documentation>andere</documentation> </annotation> </enumeration> </restriction> </simpleType> </pre>
--	---

simpleType enum_0113

namespace	http://xml.ir-d.de/sak		
type	restriction of string		
properties	base xs:string		
facets	Kind	Value	Annotation
	enumeration	0113001	documentation Chemotherapie innerhalb der letzten drei Monate
annotation	documentation Kat_BI_VorbehandlungSystemisch		
source	<pre> <simpleType name="enum_0113"> <annotation> <documentation>Kat_BI_VorbehandlungSystemisch</documentation> </annotation> <restriction base="xs:string"> <enumeration value="0113001"> <annotation> <documentation>Chemotherapie innerhalb der letzten drei Monate</documentation> </annotation> </enumeration> </restriction> </simpleType> </pre>		

simpleType enum_0114

namespace	http://xml.ir-d.de/sak		
type	restriction of string		
properties	base xs:string		
facets	Kind	Value	Annotation
	enumeration	0114001	documentation vollständig

	enumeration 0114002 documentation nein enumeration 0114003 documentation teilweise enumeration 0114004 documentation nicht vorhanden
annotation	documentation Kat_BI_EntfernungADMNetz
source	<pre> <simpleType name="enum_0114"> <annotation> <documentation>Kat_BI_EntfernungADMNetz</documentation> </annotation> <restriction base="xs:string"> <enumeration value="0114001"> <annotation> <documentation>vollständig</documentation> </annotation> </enumeration> <enumeration value="0114002"> <annotation> <documentation>nein</documentation> </annotation> </enumeration> <enumeration value="0114003"> <annotation> <documentation>teilweise</documentation> </annotation> </enumeration> <enumeration value="0114004"> <annotation> <documentation>nicht vorhanden</documentation> </annotation> </enumeration> </restriction> </simpleType> </pre>

simpleType enum_0116

namespace	http://xml.ir-d.de/sak		
type	restriction of string		
properties	base xs:string		
facets	Kind	Value	Annotation
	enumeration	0116001	documentation Spülung, antibiotisch
	enumeration	0116002	documentation Spülung, antiseptisch
	enumeration	0116003	documentation Spülung, wirkstofffrei
	enumeration	0116004	documentation Spülung, andere
	enumeration	0116005	documentation prä-/perioperative Antibiotika
	enumeration	0116006	documentation postoperative Antibiotika
	enumeration	0116007	documentation Handschuhwechsel vor Implantation
	enumeration	0116008	documentation Implantationshilfe

annotation	documentation Kat_BI_Operationsmassnahme
source	<pre> <simpleType name="enum_0116"> <annotation> <documentation>Kat_BI_Operationsmassnahme</documentation> </annotation> <restriction base="xs:string"> <enumeration value="0116001"> <annotation> <documentation>Spülung, antibiotisch</documentation> </annotation> </enumeration> <enumeration value="0116002"> <annotation> <documentation>Spülung, antiseptisch</documentation> </annotation> </enumeration> <enumeration value="0116003"> <annotation> <documentation>Spülung, wirkstofffrei</documentation> </annotation> </enumeration> <enumeration value="0116004"> <annotation> <documentation>Spülung, andere</documentation> </annotation> </enumeration> <enumeration value="0116005"> <annotation> <documentation>prä-/perioperative Antibiotika</documentation> </annotation> </enumeration> <enumeration value="0116006"> <annotation> <documentation>postoperative Antibiotika</documentation> </annotation> </enumeration> <enumeration value="0116007"> <annotation> <documentation>Handschuhwechsel vor Implantation</documentation> </annotation> </enumeration> <enumeration value="0116008"> <annotation> <documentation>Implantationshilfe</documentation> </annotation> </enumeration> </restriction> </simpleType> </pre>

simpleType enum_0118

namespace	http://xml.ir-d.de/sak		
type	restriction of string		
properties	base	xs:string	
facets	Kind	Value	Annotation

	enumeration 0118001 documentation axillär enumeration 0118002 documentation periareolär enumeration 0118003 documentation inframammär enumeration 0118004 documentation Mastektomienarbe enumeration 0118042 documentation anderer
annotation	documentation Kat_BI_Operationszugang
source	<pre> <simpleType name="enum_0118"> <annotation> <documentation>Kat_BI_Operationszugang</documentation> </annotation> <restriction base="xs:string"> <enumeration value="0118001"> <annotation> <documentation>axillär</documentation> </annotation> </enumeration> <enumeration value="0118002"> <annotation> <documentation>periareolär</documentation> </annotation> </enumeration> <enumeration value="0118003"> <annotation> <documentation>inframammär</documentation> </annotation> </enumeration> <enumeration value="0118004"> <annotation> <documentation>Mastektomienarbe</documentation> </annotation> </enumeration> <enumeration value="0118042"> <annotation> <documentation>anderer</documentation> </annotation> </enumeration> </restriction> </simpleType> </pre>

simpleType enum_0120

namespace	http://xml.ir-d.de/sak		
type	restriction of string		
properties	base xs:string		
facets	Kind	Value	Annotation
	enumeration	0120001	documentation Expander defekt
annotation	documentation Kat_BI_BefundAustausch		
source	<pre> <simpleType name="enum_0120"> <annotation> </pre>		

	<pre> <documentation>Kat_BI_BefundAustausch</documentation> </annotation> <restriction base="xs:string"> <enumeration value="0120001"> <annotation> <documentation>Expander defekt</documentation> </annotation> </enumeration> </restriction> </simpleType> </pre>
--	---

simpleType enum_0121

namespace	http://xml.ir-d.de/sak		
type	restriction of string		
properties	base xs:string		
facets	Kind	Value	Annotation
	enumeration	0121001	documentation Infektion
	enumeration	0121002	documentation Serom
	enumeration	0121003	documentation Hämatom
	enumeration	0121004	documentation Kapselfibrose
	enumeration	0121005	documentation Implantatruptur
	enumeration	0121006	documentation Fehlpositionierung/Rotation
	enumeration	0121007	documentation BIA-ALCL/-SCC, Verdacht
	enumeration	0121008	documentation BIA-ALCL/-SCC, pathologisch bestätigt
	enumeration	0121009	documentation Brustschmerzen
	enumeration	0121010	documentation Doppelkapsel
	enumeration	0121011	documentation Netz-/ADM-bedingte Komplikation, Non-Integration
	enumeration	0121012	documentation Netz-/ADM-bedingte Komplikation, andere
	enumeration	0121013	documentation Hautnekrose/exponiertes Implantat
	enumeration	0121014	documentation BII/ASIA (Brustimplantat assoziierte Symptome), Verdacht
	enumeration	0121015	documentation Lymphadenopathie
	enumeration	0121016	documentation Brustkrebs, neu aufgetreten/Rezidiv
annotation	documentation Kat_BI_BefundKomplett		
source	<pre> <simpleType name="enum_0121"> <annotation> <documentation>Kat_BI_BefundKomplett</documentation> </annotation> <restriction base="xs:string"> <enumeration value="0121001"> <annotation> <documentation>Infektion</documentation> </pre>		

```

</annotation>
</enumeration>
<enumeration value="0121002">
  <annotation>
    <documentation>Serom</documentation>
  </annotation>
</enumeration>
<enumeration value="0121003">
  <annotation>
    <documentation>Hämatom</documentation>
  </annotation>
</enumeration>
<enumeration value="0121004">
  <annotation>
    <documentation>Kapsel fibrose</documentation>
  </annotation>
</enumeration>
<enumeration value="0121005">
  <annotation>
    <documentation>Implantatruptur</documentation>
  </annotation>
</enumeration>
<enumeration value="0121006">
  <annotation>
    <documentation>Fehlpositionierung/Rotation</documentation>
  </annotation>
</enumeration>
<enumeration value="0121007">
  <annotation>
    <documentation>BIA-ALCL/-SCC, Verdacht</documentation>
  </annotation>
</enumeration>
<enumeration value="0121008">
  <annotation>
    <documentation>BIA-ALCL/-SCC, pathologisch bestätigt</documentation>
  </annotation>
</enumeration>
<enumeration value="0121009">
  <annotation>
    <documentation>Brustschmerzen</documentation>
  </annotation>
</enumeration>
<enumeration value="0121010">
  <annotation>
    <documentation>Doppelkapsel</documentation>
  </annotation>
</enumeration>
<enumeration value="0121011">
  <annotation>
    <documentation>Netz-/ADM-bedingte Komplikation,
Non-Integration</documentation>
  </annotation>
</enumeration>
<enumeration value="0121012">
  <annotation>
    <documentation>Netz-/ADM-bedingte Komplikation, andere</documentation>
  </annotation>
</enumeration>
<enumeration value="0121013">

```

	<pre> <annotation> <documentation>Hautnekrose/exponiertes Implantat</documentation> </annotation> </enumeration> <enumeration value="0121014"> <annotation> <documentation>BII/ASIA (Brustimplantat assoziierte Symptome), Verdacht</documentation> </annotation> </enumeration> <enumeration value="0121015"> <annotation> <documentation>Lymphadenopathie</documentation> </annotation> </enumeration> <enumeration value="0121016"> <annotation> <documentation>Brustkrebs, neu aufgetreten/Rezidiv</documentation> </annotation> </enumeration> </restriction> </simpleType> </pre>
--	---

simpleType enum_0122

namespace	http://xml.ir-d.de/sak		
type	restriction of string		
properties	base xs:string		
facets	Kind	Value	Annotation
	enumeration	0122001	documentation ja, ärztlich nachgewiesen
	enumeration	0122002	documentation nein
	enumeration	0122042	documentation unbekannt
annotation	documentation Kat_BI_Autoimmunerkrankung		
source	<pre> <simpleType name="enum_0122"> <annotation> <documentation>Kat_BI_Autoimmunerkrankung</documentation> </annotation> <restriction base="xs:string"> <enumeration value="0122001"> <annotation> <documentation>ja, ärztlich nachgewiesen</documentation> </annotation> </enumeration> <enumeration value="0122002"> <annotation> <documentation>nein</documentation> </annotation> </enumeration> <enumeration value="0122042"> <annotation> <documentation>unbekannt</documentation> </annotation> </enumeration> </restriction> </simpleType> </pre>		

	<pre> </restriction> </simpleType> </pre>
--	---

simpleType enum_0123

namespace	http://xml.ir-d.de/sak		
type	restriction of string		
properties	base xs:string		
facets	Kind	Value	Annotation
	enumeration	0123001	documentation neu aufgetreten
	enumeration	0123002	documentation verschlechtert
	enumeration	0123003	documentation keine Veränderung
	enumeration	0123004	documentation nicht relevant, da Primäreingriff
	enumeration	0123042	documentation unbekannt
annotation	documentation Kat_BI_VerlaufAutoimmunerkrankung		
source	<pre> <simpleType name="enum_0123"> <annotation> <documentation>Kat_BI_VerlaufAutoimmunerkrankung</documentation> </annotation> <restriction base="xs:string"> <enumeration value="0123001"> <annotation> <documentation>neu aufgetreten</documentation> </annotation> </enumeration> <enumeration value="0123002"> <annotation> <documentation>verschlechtert</documentation> </annotation> </enumeration> <enumeration value="0123003"> <annotation> <documentation>keine Veränderung</documentation> </annotation> </enumeration> <enumeration value="0123004"> <annotation> <documentation>nicht relevant, da Primäreingriff</documentation> </annotation> </enumeration> <enumeration value="0123042"> <annotation> <documentation>unbekannt</documentation> </annotation> </enumeration> </restriction> </simpleType> </pre>		

simpleType enum_0124

namespace	http://xml.ir-d.de/sak		
type	restriction of string		
properties	base xs:string		
facets	Kind	Value	Annotation
	enumeration	0124001	documentation Salzlösung
	enumeration	0124002	documentation Silikongel
	enumeration	0124003	documentation Kombination Silikongel und Salzlösung
	enumeration	0124042	documentation sonstige
annotation	documentation Kat_BI_Fuellung		
source	<pre> <simpleType name="enum_0124"> <annotation> <documentation>Kat_BI_Fuellung</documentation> </annotation> <restriction base="xs:string"> <enumeration value="0124001"> <annotation> <documentation>Salzlösung</documentation> </annotation> </enumeration> <enumeration value="0124002"> <annotation> <documentation>Silikongel</documentation> </annotation> </enumeration> <enumeration value="0124003"> <annotation> <documentation>Kombination Silikongel und Salzlösung</documentation> </annotation> </enumeration> <enumeration value="0124042"> <annotation> <documentation>sonstige</documentation> </annotation> </enumeration> </restriction> </simpleType> </pre>		

simpleType enum_0126

namespace	http://xml.ir-d.de/sak		
type	restriction of string		
properties	base xs:string		
facets	Kind	Value	Annotation
	enumeration	0126001	documentation anatomisch (tropfenförmig)
	enumeration	0126002	documentation rund (punktsymmetrisch)
	enumeration	0126042	documentation sonstige

annotation	documentation Kat_BI_Form
source	<pre> <simpleType name="enum_0126"> <annotation> <documentation>Kat_BI_Form</documentation> </annotation> <restriction base="xs:string"> <enumeration value="0126001"> <annotation> <documentation>anatomisch (tropfenförmig)</documentation> </annotation> </enumeration> <enumeration value="0126002"> <annotation> <documentation>rund (punktsymmetrisch)</documentation> </annotation> </enumeration> <enumeration value="0126042"> <annotation> <documentation>sonstige</documentation> </annotation> </enumeration> </restriction> </simpleType> </pre>

simpleType **enum_0128**

namespace	http://xml.ir-d.de/sak		
type	restriction of string		
properties	base xs:string		
facets	Kind	Value	Annotation
	enumeration	0128001	documentation glattwandig
	enumeration	0128002	documentation beschichtet
	enumeration	0128003	documentation texturiert
annotation	documentation Kat_BI_Oberflaeche		
source	<pre> <simpleType name="enum_0128"> <annotation> <documentation>Kat_BI_Oberflaeche</documentation> </annotation> <restriction base="xs:string"> <enumeration value="0128001"> <annotation> <documentation>glattwandig</documentation> </annotation> </enumeration> <enumeration value="0128002"> <annotation> <documentation>beschichtet</documentation> </annotation> </enumeration> <enumeration value="0128003"> <annotation> <documentation>texturiert</documentation> </annotation> </enumeration> </restriction> </simpleType> </pre>		

```

</annotation>
</enumeration>
</restriction>
</simpleType>

```

simpleType enum_0130

namespace	http://xml.ir-d.de/sak		
type	restriction of string		
properties	base xs:string		
facets	Kind	Value	Annotation
	enumeration	0130001	documentation Allergan
	enumeration	0130002	documentation Cereplas
	enumeration	0130003	documentation CUI (Cox Uphoff Implants)
	enumeration	0130004	documentation EMSI Biomedical
	enumeration	0130005	documentation Establishment labs
	enumeration	0130006	documentation Eurosilicone
	enumeration	0130007	documentation Nagor
	enumeration	0130008	documentation Groupe Sebbin
	enumeration	0130009	documentation Laboratoires Arion
	enumeration	0130010	documentation Mentor
	enumeration	0130011	documentation Pérouse Plastie SAS
	enumeration	0130012	documentation PIP M-Implants
	enumeration	0130013	documentation Polytech Health & Aesthetics
	enumeration	0130014	documentation Silimed
	enumeration	0130015	documentation Surgitek
	enumeration	0130016	documentation G&G Biotechnology
	enumeration	0130017	documentation nicht belegter Wert
	enumeration	0130018	documentation nicht belegter Wert
	enumeration	0130019	documentation nicht belegter Wert
	enumeration	0130020	documentation nicht belegter Wert
	enumeration	0130021	documentation nicht belegter Wert
	enumeration	0130042	documentation sonstiger
annotation	documentation Kat_BI_Hersteller		
source	<pre> <simpleType name="enum_0130"> <annotation> <documentation>Kat BI Hersteller</documentation> </pre>		

```
</annotation>
<restriction base="xs:string">
  <enumeration value="0130001">
    <annotation>
      <documentation>Allergan</documentation>
    </annotation>
  </enumeration>
  <enumeration value="0130002">
    <annotation>
      <documentation>Cereplas</documentation>
    </annotation>
  </enumeration>
  <enumeration value="0130003">
    <annotation>
      <documentation>CUI (Cox Uphoff Implants)</documentation>
    </annotation>
  </enumeration>
  <enumeration value="0130004">
    <annotation>
      <documentation>EMSI Biomedical</documentation>
    </annotation>
  </enumeration>
  <enumeration value="0130005">
    <annotation>
      <documentation>Establishment labs</documentation>
    </annotation>
  </enumeration>
  <enumeration value="0130006">
    <annotation>
      <documentation>Eurosilicone</documentation>
    </annotation>
  </enumeration>
  <enumeration value="0130007">
    <annotation>
      <documentation>Nagor</documentation>
    </annotation>
  </enumeration>
  <enumeration value="0130008">
    <annotation>
      <documentation>Groupe Sebbin</documentation>
    </annotation>
  </enumeration>
  <enumeration value="0130009">
    <annotation>
      <documentation>Laboratoires Arion</documentation>
    </annotation>
  </enumeration>
  <enumeration value="0130010">
    <annotation>
      <documentation>Mentor</documentation>
    </annotation>
  </enumeration>
  <enumeration value="0130011">
    <annotation>
      <documentation>Pérouse Plastie SAS</documentation>
    </annotation>
  </enumeration>
  <enumeration value="0130012">
    <annotation>
```

```
<documentation>PIP M-Implants</documentation>
</annotation>
</enumeration>
<enumeration value="0130013">
  <annotation>
    <documentation>Polytech Health & Aesthetics</documentation>
  </annotation>
</enumeration>
<enumeration value="0130014">
  <annotation>
    <documentation>Silimed</documentation>
  </annotation>
</enumeration>
<enumeration value="0130015">
  <annotation>
    <documentation>Surgitek</documentation>
  </annotation>
</enumeration>
<enumeration value="0130016">
  <annotation>
    <documentation>G&G Biotechnology</documentation>
  </annotation>
</enumeration>
<enumeration value="0130017">
  <annotation>
    <documentation>nicht belegter Wert</documentation>
  </annotation>
</enumeration>
<enumeration value="0130018">
  <annotation>
    <documentation>nicht belegter Wert</documentation>
  </annotation>
</enumeration>
<enumeration value="0130019">
  <annotation>
    <documentation>nicht belegter Wert</documentation>
  </annotation>
</enumeration>
<enumeration value="0130020">
  <annotation>
    <documentation>nicht belegter Wert</documentation>
  </annotation>
</enumeration>
<enumeration value="0130021">
  <annotation>
    <documentation>nicht belegter Wert</documentation>
  </annotation>
</enumeration>
<enumeration value="0130042">
  <annotation>
    <documentation>sonstiger</documentation>
  </annotation>
</enumeration>
</restriction>
</simpleType>
```

simpleType enum_0131

namespace	http://xml.ir-d.de/sak		
type	restriction of string		
properties	base xs:string		
facets	Kind	Value	Annotation
	enumeration	0131001	documentation Allergan
	enumeration	0131002	documentation Establishment labs
	enumeration	0131003	documentation Eurosilicone
	enumeration	0131004	documentation Galatea
	enumeration	0131005	documentation Integra
	enumeration	0131006	documentation Lifecell
	enumeration	0131007	documentation MBP (Medical Biomaterial Products)
	enumeration	0131008	documentation Mentor
	enumeration	0131009	documentation Novus Scientific
	enumeration	0131042	documentation sonstiger
annotation	documentation Kat_BI_ZubehoerHersteller		
source	<pre> <simpleType name="enum_0131"> <annotation> <documentation>Kat_BI_ZubehoerHersteller</documentation> </annotation> <restriction base="xs:string"> <enumeration value="0131001"> <annotation> <documentation>Allergan</documentation> </annotation> </enumeration> <enumeration value="0131002"> <annotation> <documentation>Establishment labs</documentation> </annotation> </enumeration> <enumeration value="0131003"> <annotation> <documentation>Eurosilicone</documentation> </annotation> </enumeration> <enumeration value="0131004"> <annotation> <documentation>Galatea</documentation> </annotation> </enumeration> <enumeration value="0131005"> <annotation> <documentation>Integra</documentation> </annotation> </enumeration> <enumeration value="0131006"> <annotation> </pre>		

	<pre> <documentation>Lifecell</documentation> </annotation> </enumeration> <enumeration value="0131007"> <annotation> <documentation>MBP (Medical Biomaterial Products)</documentation> </annotation> </enumeration> <enumeration value="0131008"> <annotation> <documentation>Mentor</documentation> </annotation> </enumeration> <enumeration value="0131009"> <annotation> <documentation>Novus Scientific</documentation> </annotation> </enumeration> <enumeration value="0131042"> <annotation> <documentation>sonstiger</documentation> </annotation> </enumeration> </restriction> </simpleType> </pre>
--	---

simpleType enum_0190

namespace	http://xml.ir-d.de/sak		
type	restriction of string		
properties	base xs:string		
facets	Kind	Value	Annotation
	enumeration	0190001	documentation Brustimplantat
	enumeration	0190003	documentation Brustexpander
annotation	documentation Kat_BI_Artikeltyp		
source	<pre> <simpleType name="enum_0190"> <annotation> <documentation>Kat_BI_Artikeltyp</documentation> </annotation> <restriction base="xs:string"> <enumeration value="0190001"> <annotation> <documentation>Brustimplantat</documentation> </annotation> </enumeration> <enumeration value="0190003"> <annotation> <documentation>Brustexpander</documentation> </annotation> </enumeration> </restriction> </simpleType> </pre>		

simpleType enum_0191

namespace	http://xml.ir-d.de/sak		
type	restriction of string		
properties	base xs:string		
facets	Kind	Value	Annotation
	enumeration	0191001	documentation Netz
	enumeration	0191002	documentation ADM
annotation	documentation Kat_BI_ZubehoerTyp		
source	<pre> <simpleType name="enum_0191"> <annotation> <documentation>Kat_BI_ZubehoerTyp</documentation> </annotation> <restriction base="xs:string"> <enumeration value="0191001"> <annotation> <documentation>Netz</documentation> </annotation> </enumeration> <enumeration value="0191002"> <annotation> <documentation>ADM</documentation> </annotation> </enumeration> </restriction> </simpleType> </pre>		

simpleType enum_0200

namespace	http://xml.ir-d.de/sak		
type	restriction of string		
properties	base xs:string		
facets	Kind	Value	Annotation
	enumeration	0200001	documentation Erst-OP
	enumeration	0200002	documentation Folgeeingriff
annotation	documentation Kat_EP_ArtEingriff		
source	<pre> <simpleType name="enum_0200"> <annotation> <documentation>Kat_EP_ArtEingriff</documentation> </annotation> <restriction base="xs:string"> <enumeration value="0200001"> <annotation> <documentation>Erst-OP</documentation> </annotation> </enumeration> <enumeration value="0200002"> <annotation> <documentation>Folgeeingriff</documentation> </annotation> </enumeration> </restriction> </simpleType> </pre>		

```

</annotation>
</enumeration>
</restriction>
</simpleType>

```

simpleType enum_0202

namespace	http://xml.ir-d.de/sak		
type	restriction of string		
properties	base xs:string		
facets	Kind	Value	Annotation
	enumeration	0202001	documentation Lockerung
	enumeration	0202002	documentation Infektion, Verdacht auf
	enumeration	0202003	documentation Infektion, gesichert
	enumeration	0202004	documentation Luxation, Inlay aus der Pfanne
	enumeration	0202005	documentation Luxation, Kopf aus Pfanne/Inlay
	enumeration	0202006	documentation Periprothetische Fraktur
	enumeration	0202007	documentation Verschleiß des PE-Inlays
	enumeration	0202008	documentation Implantatbruch
	enumeration	0202009	documentation Implantatfehlage/Malalignent
	enumeration	0202010	documentation Osteolysen bei festem Implantat
	enumeration	0202011	documentation Progression der Grunderkrankung
	enumeration	0202012	documentation ARMD
	enumeration	0202013	documentation Verdacht auf allergische Reaktion
	enumeration	0202021	documentation Zustand nach Prothesenentfernung
	enumeration	0202042	documentation andere Gründe
annotation	documentation Kat_EP_GrundWechselHuefte		
source	<pre> <simpleType name="enum_0202"> <annotation> <documentation>Kat_EP_GrundWechselHuefte</documentation> </annotation> <restriction base="xs:string"> <enumeration value="0202001"> <annotation> <documentation>Lockerung</documentation> </annotation> </enumeration> <enumeration value="0202002"> <annotation> <documentation>Infektion, Verdacht auf</documentation> </annotation> </enumeration> <enumeration value="0202003"> </pre>		

```
<annotation>
  <documentation>Infektion, gesichert</documentation>
</annotation>
</enumeration>
<enumeration value="0202004">
  <annotation>
    <documentation>Luxation, Inlay aus der Pfanne</documentation>
  </annotation>
</enumeration>
<enumeration value="0202005">
  <annotation>
    <documentation>Luxation, Kopf aus Pfanne/Inlay</documentation>
  </annotation>
</enumeration>
<enumeration value="0202006">
  <annotation>
    <documentation>Periprothetische Fraktur</documentation>
  </annotation>
</enumeration>
<enumeration value="0202007">
  <annotation>
    <documentation>Verschleiß des PE-Inlays</documentation>
  </annotation>
</enumeration>
<enumeration value="0202008">
  <annotation>
    <documentation>Implantatbruch</documentation>
  </annotation>
</enumeration>
<enumeration value="0202009">
  <annotation>
    <documentation>Implantatfehllage/Malalignent</documentation>
  </annotation>
</enumeration>
<enumeration value="0202010">
  <annotation>
    <documentation>Osteolysen bei festem Implantat</documentation>
  </annotation>
</enumeration>
<enumeration value="0202011">
  <annotation>
    <documentation>Progression der Grunderkrankung</documentation>
  </annotation>
</enumeration>
<enumeration value="0202012">
  <annotation>
    <documentation>ARMD</documentation>
  </annotation>
</enumeration>
<enumeration value="0202013">
  <annotation>
    <documentation>Verdacht auf allergische Reaktion</documentation>
  </annotation>
</enumeration>
<enumeration value="0202021">
  <annotation>
    <documentation>Zustand nach Prothesenentfernung</documentation>
  </annotation>
</enumeration>
```

	<pre> <enumeration value="02042"> <annotation> <documentation>andere Gründe</documentation> </annotation> </enumeration> </restriction> </simpleType> </pre>
--	--

simpleType enum_0204

namespace	http://xml.ir-d.de/sak		
type	restriction of string		
properties	base xs:string		
facets	Kind	Value	Annotation
	enumeration	0204001	documentation Lockerung
	enumeration	0204002	documentation Infektion, Verdacht auf
	enumeration	0204003	documentation Infektion, gesichert
	enumeration	0204006	documentation Periprothetische Fraktur
	enumeration	0204007	documentation Verschleiß
	enumeration	0204008	documentation Implantatbruch
	enumeration	0204009	documentation Implantatfehlage/Malalignent
	enumeration	0204010	documentation Osteolysen bei festem Implantat
	enumeration	0204011	documentation Progression der Grunderkrankung
	enumeration	0204012	documentation ARMD
	enumeration	0204013	documentation Verdacht auf allergische Reaktion
	enumeration	0204014	documentation Dislokation/Migration von Komponenten
	enumeration	0204015	documentation Bandinstabilität
	enumeration	0204016	documentation Bewegungseinschränkung
	enumeration	0204021	documentation Zustand nach Prothesenentfernung
	enumeration	0204042	documentation andere Gründe
annotation	documentation Kat_EP_GrundWechselKnie		
source	<pre> <simpleType name="enum_0204"> <annotation> <documentation>Kat_EP_GrundWechselKnie</documentation> </annotation> <restriction base="xs:string"> <enumeration value="0204001"> <annotation> <documentation>Lockerung</documentation> </annotation> </enumeration> <enumeration value="0204002"> </pre>		

```
<annotation>
  <documentation>Infektion, Verdacht auf</documentation>
</annotation>
</enumeration>
<enumeration value="0204003">
  <annotation>
    <documentation>Infektion, gesichert</documentation>
  </annotation>
</enumeration>
<enumeration value="0204006">
  <annotation>
    <documentation>Periprothetische Fraktur</documentation>
  </annotation>
</enumeration>
<enumeration value="0204007">
  <annotation>
    <documentation>Verschleiß</documentation>
  </annotation>
</enumeration>
<enumeration value="0204008">
  <annotation>
    <documentation>Implantatbruch</documentation>
  </annotation>
</enumeration>
<enumeration value="0204009">
  <annotation>
    <documentation>Implantatfehlage/Malalignent</documentation>
  </annotation>
</enumeration>
<enumeration value="0204010">
  <annotation>
    <documentation>Osteolysen bei festem Implantat</documentation>
  </annotation>
</enumeration>
<enumeration value="0204011">
  <annotation>
    <documentation>Progression der Grunderkrankung</documentation>
  </annotation>
</enumeration>
<enumeration value="0204012">
  <annotation>
    <documentation>ARMD</documentation>
  </annotation>
</enumeration>
<enumeration value="0204013">
  <annotation>
    <documentation>Verdacht auf allergische Reaktion</documentation>
  </annotation>
</enumeration>
<enumeration value="0204014">
  <annotation>
    <documentation>Dislokation/Migration von Komponenten</documentation>
  </annotation>
</enumeration>
<enumeration value="0204015">
  <annotation>
    <documentation>Bandinstabilität</documentation>
  </annotation>
</enumeration>
```

```

<enumeration value="0204016">
  <annotation>
    <documentation>Bewegungseinschränkung</documentation>
  </annotation>
</enumeration>
<enumeration value="0204021">
  <annotation>
    <documentation>Zustand nach Prothesenentfernung</documentation>
  </annotation>
</enumeration>
<enumeration value="0204042">
  <annotation>
    <documentation>andere Gründe</documentation>
  </annotation>
</enumeration>
</restriction>
</simpleType>

```

simpleType enum 0206

namespace	http://xml.ir-d.de/sak		
type	restriction of string		
properties	base xs:string		
facets	Kind	Value	Annotation
	enumeration	0206001	documentation Lockerung
	enumeration	0206002	documentation Infektion, Verdacht auf
	enumeration	0206003	documentation Infektion, gesichert
	enumeration	0206004	documentation Luxation, Inlay aus der Pfanne
	enumeration	0206005	documentation Luxation, Kopf aus Pfanne/Inlay
	enumeration	0206006	documentation Periprothetische Fraktur
	enumeration	0206007	documentation Verschleiß
	enumeration	0206008	documentation Implantatbruch
	enumeration	0206009	documentation Implantatfehlage/Malalignement
	enumeration	0206010	documentation Osteolysen bei festem Implantat
	enumeration	0206011	documentation Progression der Grunderkrankung
	enumeration	0206012	documentation ARM-D
	enumeration	0206013	documentation Verdacht auf allergische Reaktion
	enumeration	0206014	documentation Dislokation/Migration von Komponenten
	enumeration	0206015	documentation Bandinstabilität
	enumeration	0206016	documentation Bewegungseinschränkung
	enumeration	0206021	documentation Zustand nach Prothesenentfernung
	enumeration	0206042	documentation andere Gründe

annotation	documentation Kat_EP_GrundWechselTFE
source	<pre> <simpleType name="enum_0206"> <annotation> <documentation>Kat_EP_GrundWechselTFE</documentation> </annotation> <restriction base="xs:string"> <enumeration value="0206001"> <annotation> <documentation>Lockerung</documentation> </annotation> </enumeration> <enumeration value="0206002"> <annotation> <documentation>Infektion, Verdacht auf</documentation> </annotation> </enumeration> <enumeration value="0206003"> <annotation> <documentation>Infektion, gesichert</documentation> </annotation> </enumeration> <enumeration value="0206004"> <annotation> <documentation>Luxation, Inlay aus der Pfanne</documentation> </annotation> </enumeration> <enumeration value="0206005"> <annotation> <documentation>Luxation, Kopf aus Pfanne/Inlay</documentation> </annotation> </enumeration> <enumeration value="0206006"> <annotation> <documentation>Periprothetische Fraktur</documentation> </annotation> </enumeration> <enumeration value="0206007"> <annotation> <documentation>Verschleiß</documentation> </annotation> </enumeration> <enumeration value="0206008"> <annotation> <documentation>Implantatbruch</documentation> </annotation> </enumeration> <enumeration value="0206009"> <annotation> <documentation>Implantatfehllage/Malalignent</documentation> </annotation> </enumeration> <enumeration value="0206010"> <annotation> <documentation>Osteolysen bei festem Implantat</documentation> </annotation> </enumeration> <enumeration value="0206011"> <annotation> </pre>

```

    <documentation>Progression der Grunderkrankung</documentation>
  </annotation>
</enumeration>
<enumeration value="0206012">
  <annotation>
    <documentation>ARMD</documentation>
  </annotation>
</enumeration>
<enumeration value="0206013">
  <annotation>
    <documentation>Verdacht auf allergische Reaktion</documentation>
  </annotation>
</enumeration>
<enumeration value="0206014">
  <annotation>
    <documentation>Dislokation/Migration von Komponenten</documentation>
  </annotation>
</enumeration>
<enumeration value="0206015">
  <annotation>
    <documentation>Bandinstabilität</documentation>
  </annotation>
</enumeration>
<enumeration value="0206016">
  <annotation>
    <documentation>Bewegungseinschränkung</documentation>
  </annotation>
</enumeration>
<enumeration value="0206021">
  <annotation>
    <documentation>Zustand nach Prothesenentfernung</documentation>
  </annotation>
</enumeration>
<enumeration value="0206042">
  <annotation>
    <documentation>andere Gründe</documentation>
  </annotation>
</enumeration>
</restriction>
</simpleType>

```

simpleType enum_0210

namespace	http://xml.ir-d.de/sak		
type	restriction of string		
properties	base xs:string		
facets	Kind	Value	Annotation
	enumeration	0210001	documentation keine relevante Voroperation
	enumeration	0210002	documentation Osteosynthese/Osteotomie (Becken)
	enumeration	0210003	documentation Osteosynthese/Osteotomie (Femur)
	enumeration	0210004	documentation Osteosynthese/Osteotomie (beides)
	enumeration	0210005	documentation Operation bei Hüftkopfnekrose

	enumeration 0210006 documentation Arthrodese
	enumeration 0210042 documentation andere
annotation	documentation Kat_EP_VoroperationHuefte
source	<pre> <simpleType name="enum_0210"> <annotation> <documentation>Kat_EP_VoroperationHuefte</documentation> </annotation> <restriction base="xs:string"> <enumeration value="0210001"> <annotation> <documentation>keine relevante Voroperation</documentation> </annotation> </enumeration> <enumeration value="0210002"> <annotation> <documentation>Osteosynthese/Osteotomie (Becken)</documentation> </annotation> </enumeration> <enumeration value="0210003"> <annotation> <documentation>Osteosynthese/Osteotomie (Femur)</documentation> </annotation> </enumeration> <enumeration value="0210004"> <annotation> <documentation>Osteosynthese/Osteotomie (beides)</documentation> </annotation> </enumeration> <enumeration value="0210005"> <annotation> <documentation>Operation bei Hüftkopfnekrose</documentation> </annotation> </enumeration> <enumeration value="0210006"> <annotation> <documentation>Arthrodese</documentation> </annotation> </enumeration> <enumeration value="0210042"> <annotation> <documentation>andere</documentation> </annotation> </enumeration> </restriction> </simpleType> </pre>

simpleType enum_0211

namespace	http://xml.ir-d.de/sak		
type	restriction of string		
properties	base xs:string		
facets	Kind enumeration	Value 0211001	Annotation documentation keine relevante Voroperation

	<p>enumeration 0211002 documentation Osteosynthese/Osteotomie (Femur)</p> <p>enumeration 0211003 documentation Osteosynthese/Osteotomie (Tibia)</p> <p>enumeration 0211004 documentation Osteosynthese/Osteotomie (Patella)</p> <p>enumeration 0211005 documentation Osteosynthese/Osteotomie (mehrere)</p> <p>enumeration 0211006 documentation Kapsel-/Bandapparat</p> <p>enumeration 0211007 documentation Arthrodese</p> <p>enumeration 0211042 documentation andere</p>
annotation	documentation Kat_EP_VoroperationKnie
source	<pre> <simpleType name="enum_0211"> <annotation> <documentation>Kat_EP_VoroperationKnie</documentation> </annotation> <restriction base="xs:string"> <enumeration value="0211001"> <annotation> <documentation>keine relevante Voroperation</documentation> </annotation> </enumeration> <enumeration value="0211002"> <annotation> <documentation>Osteosynthese/Osteotomie (Femur)</documentation> </annotation> </enumeration> <enumeration value="0211003"> <annotation> <documentation>Osteosynthese/Osteotomie (Tibia)</documentation> </annotation> </enumeration> <enumeration value="0211004"> <annotation> <documentation>Osteosynthese/Osteotomie (Patella)</documentation> </annotation> </enumeration> <enumeration value="0211005"> <annotation> <documentation>Osteosynthese/Osteotomie (mehrere)</documentation> </annotation> </enumeration> <enumeration value="0211006"> <annotation> <documentation>Kapsel-/Bandapparat</documentation> </annotation> </enumeration> <enumeration value="0211007"> <annotation> <documentation>Arthrodese</documentation> </annotation> </enumeration> <enumeration value="0211042"> <annotation> <documentation>andere</documentation> </annotation> </enumeration> </restriction> </simpleType> </pre>

	<pre> </enumeration> </restriction> </simpleType> </pre>
--	--

simpleType enum_0212

namespace	http://xml.ir-d.de/sak		
type	restriction of string		
properties	base xs:string		
facets	Kind	Value	Annotation
	enumeration	0212001	documentation Hüfte
	enumeration	0212002	documentation Knie
	enumeration	0212003	documentation Totaler Femurersatz inkl. Durchsteck-Prothese
annotation	documentation Kat_EP_Gelenk		
source	<pre> <simpleType name="enum_0212"> <annotation> <documentation>Kat_EP_Gelenk</documentation> </annotation> <restriction base="xs:string"> <enumeration value="0212001"> <annotation> <documentation>Hüfte</documentation> </annotation> </enumeration> <enumeration value="0212002"> <annotation> <documentation>Knie</documentation> </annotation> </enumeration> <enumeration value="0212003"> <annotation> <documentation>Totaler Femurersatz inkl. Durchsteck-Prothese</documentation> </annotation> </enumeration> </restriction> </simpleType> </pre>		

simpleType enum_0220

namespace	http://xml.ir-d.de/sak		
type	restriction of string		
properties	base xs:string		
facets	Kind	Value	Annotation
	enumeration	0220001	documentation anterior
	enumeration	0220002	documentation anterolateral
	enumeration	0220003	documentation lateral
	enumeration	0220004	documentation

	<p>enumeration 0220005 posterior documentation posterolateral</p> <p>enumeration 0220006 documentation 2-Inzisionen-Zugang</p> <p>enumeration 0220042 documentation sonstiges/unbekannt</p>
annotation	documentation Kat_EP_Operationszugang
source	<pre> <simpleType name="enum_0220"> <annotation> <documentation>Kat_EP_Operationszugang</documentation> </annotation> <restriction base="xs:string"> <enumeration value="0220001"> <annotation> <documentation>anterior</documentation> </annotation> </enumeration> <enumeration value="0220002"> <annotation> <documentation>anterolateral</documentation> </annotation> </enumeration> <enumeration value="0220003"> <annotation> <documentation>lateral</documentation> </annotation> </enumeration> <enumeration value="0220004"> <annotation> <documentation>posterior</documentation> </annotation> </enumeration> <enumeration value="0220005"> <annotation> <documentation>posterolateral</documentation> </annotation> </enumeration> <enumeration value="0220006"> <annotation> <documentation>2-Inzisionen-Zugang</documentation> </annotation> </enumeration> <enumeration value="0220042"> <annotation> <documentation>sonstiges/unbekannt</documentation> </annotation> </enumeration> </restriction> </simpleType> </pre>

simpleType enum_0222

namespace	http://xml.ir-d.de/sak
type	restriction of string
properties	base xs:string

facets	<table border="1"> <thead> <tr> <th>Kind</th> <th>Value</th> <th>Annotation</th> </tr> </thead> <tbody> <tr> <td>enumeration</td> <td>0222001</td> <td>documentation nein</td> </tr> <tr> <td>enumeration</td> <td>0222002</td> <td>documentation ja- Ausbau</td> </tr> <tr> <td>enumeration</td> <td>0222003</td> <td>documentation ja- Einbau</td> </tr> </tbody> </table>	Kind	Value	Annotation	enumeration	0222001	documentation nein	enumeration	0222002	documentation ja- Ausbau	enumeration	0222003	documentation ja- Einbau
Kind	Value	Annotation											
enumeration	0222001	documentation nein											
enumeration	0222002	documentation ja- Ausbau											
enumeration	0222003	documentation ja- Einbau											
annotation	documentation Kat_EP_Zweizeitwechsel												
source	<pre> <simpleType name="enum_0222"> <annotation> <documentation>Kat_EP_Zweizeitwechsel</documentation> </annotation> <restriction base="xs:string"> <enumeration value="0222001"> <annotation> <documentation>nein</documentation> </annotation> </enumeration> <enumeration value="0222002"> <annotation> <documentation>ja- Ausbau</documentation> </annotation> </enumeration> <enumeration value="0222003"> <annotation> <documentation>ja- Einbau</documentation> </annotation> </enumeration> </restriction> </simpleType> </pre>												

simpleType enum_0230

namespace	http://xml.ir-d.de/sak																																				
type	restriction of string																																				
properties	base xs:string																																				
facets	<table border="1"> <thead> <tr> <th>Kind</th> <th>Value</th> <th>Annotation</th> </tr> </thead> <tbody> <tr> <td>enumeration</td> <td>0230001</td> <td>documentation Smith & Nephew GmbH</td> </tr> <tr> <td>enumeration</td> <td>0230002</td> <td>documentation Mathys Orthopädie GmbH</td> </tr> <tr> <td>enumeration</td> <td>0230003</td> <td>documentation Ceramtec AG</td> </tr> <tr> <td>enumeration</td> <td>0230004</td> <td>documentation Biomet</td> </tr> <tr> <td>enumeration</td> <td>0230005</td> <td>documentation Peter Brehm GmbH</td> </tr> <tr> <td>enumeration</td> <td>0230006</td> <td>documentation Amplitude GmbH</td> </tr> <tr> <td>enumeration</td> <td>0230007</td> <td>documentation Exactech Deutschland</td> </tr> <tr> <td>enumeration</td> <td>0230008</td> <td>documentation Globus Medical</td> </tr> <tr> <td>enumeration</td> <td>0230009</td> <td>documentation Implantcast GmbH</td> </tr> <tr> <td>enumeration</td> <td>0230010</td> <td>documentation DePuy Orthopädie GmbH</td> </tr> <tr> <td>enumeration</td> <td>0230011</td> <td>documentation</td> </tr> </tbody> </table>	Kind	Value	Annotation	enumeration	0230001	documentation Smith & Nephew GmbH	enumeration	0230002	documentation Mathys Orthopädie GmbH	enumeration	0230003	documentation Ceramtec AG	enumeration	0230004	documentation Biomet	enumeration	0230005	documentation Peter Brehm GmbH	enumeration	0230006	documentation Amplitude GmbH	enumeration	0230007	documentation Exactech Deutschland	enumeration	0230008	documentation Globus Medical	enumeration	0230009	documentation Implantcast GmbH	enumeration	0230010	documentation DePuy Orthopädie GmbH	enumeration	0230011	documentation
Kind	Value	Annotation																																			
enumeration	0230001	documentation Smith & Nephew GmbH																																			
enumeration	0230002	documentation Mathys Orthopädie GmbH																																			
enumeration	0230003	documentation Ceramtec AG																																			
enumeration	0230004	documentation Biomet																																			
enumeration	0230005	documentation Peter Brehm GmbH																																			
enumeration	0230006	documentation Amplitude GmbH																																			
enumeration	0230007	documentation Exactech Deutschland																																			
enumeration	0230008	documentation Globus Medical																																			
enumeration	0230009	documentation Implantcast GmbH																																			
enumeration	0230010	documentation DePuy Orthopädie GmbH																																			
enumeration	0230011	documentation																																			

	enumeration	0230012	IO-International Orthopaedics documentation Joint Replacement Ltd. Instrumentation
	enumeration	0230013	documentation Merete
	enumeration	0230014	documentation S&G Implants GmbH
	enumeration	0230015	documentation Speetec Implantate GmbH
	enumeration	0230016	documentation Stemcup Medical Products GmbH
	enumeration	0230017	documentation Symbios Deutschland GmbH
	enumeration	0230018	documentation Tantum AG
	enumeration	0230019	documentation Tomier GmbH
	enumeration	0230020	documentation MicroPort Orthopedics GmbH
	enumeration	0230021	documentation aap Implanate AG
	enumeration	0230022	documentation AQImplants
	enumeration	0230023	documentation ESKA Orthodynamics GmbH
	enumeration	0230024	documentation Atecos medical AG
	enumeration	0230025	documentation Chiropro GmbH
	enumeration	0230026	documentation Medacta
	enumeration	0230027	documentation OHST Medizintechnik AG
	enumeration	0230028	documentation Lima Deutschland GmbH
	enumeration	0230029	documentation alloPlus GmbH
	enumeration	0230030	documentation Heraeus Medical GmbH
	enumeration	0230031	documentation ImplanTec Deutschland GmbH
	enumeration	0230032	documentation Falcon Medical GmbH
	enumeration	0230033	documentation Meril GmbH
	enumeration	0230034	documentation Zimmer Germany GmbH
	enumeration	0230035	documentation Stryker GmbH & Co. KG
	enumeration	0230036	documentation Aesculap AG
	enumeration	0230037	documentation Waldemar Link GmbH & Co. KG
	enumeration	0230038	documentation Corin Germany GmbH
	enumeration	0230039	documentation nicht belegter Wert
	enumeration	0230040	documentation nicht belegter Wert
	enumeration	0230041	documentation nicht belegter Wert
	enumeration	0230042	documentation sonstige
	enumeration	0230043	documentation nicht belegter Wert

	enumeration 0230044 documentation nicht belegter Wert
annotation	documentation Kat_EP_Hersteller
source	<pre> <simpleType name="enum_0230"> <annotation> <documentation>Kat_EP_Hersteller</documentation> </annotation> <restriction base="xs:string"> <enumeration value="0230001"> <annotation> <documentation>Smith & Nephew GmbH</documentation> </annotation> </enumeration> <enumeration value="0230002"> <annotation> <documentation>Mathys Orthopädie GmbH</documentation> </annotation> </enumeration> <enumeration value="0230003"> <annotation> <documentation>Ceramtec AG</documentation> </annotation> </enumeration> <enumeration value="0230004"> <annotation> <documentation>Biomet</documentation> </annotation> </enumeration> <enumeration value="0230005"> <annotation> <documentation>Peter Brehm GmbH</documentation> </annotation> </enumeration> <enumeration value="0230006"> <annotation> <documentation>Amplitude GmbH</documentation> </annotation> </enumeration> <enumeration value="0230007"> <annotation> <documentation>Exactech Deutschland</documentation> </annotation> </enumeration> <enumeration value="0230008"> <annotation> <documentation>Globus Medical</documentation> </annotation> </enumeration> <enumeration value="0230009"> <annotation> <documentation>Implantcast GmbH</documentation> </annotation> </enumeration> <enumeration value="0230010"> <annotation> <documentation>DePuy Orthopädie GmbH</documentation> </annotation> </enumeration> </restriction> </simpleType> </pre>

```
<enumeration value="0230011">
  <annotation>
    <documentation>IO-International Orthopaedics</documentation>
  </annotation>
</enumeration>
<enumeration value="0230012">
  <annotation>
    <documentation>Joint Replacement Ltd. Instrumentation</documentation>
  </annotation>
</enumeration>
<enumeration value="0230013">
  <annotation>
    <documentation>Merete</documentation>
  </annotation>
</enumeration>
<enumeration value="0230014">
  <annotation>
    <documentation>S&amp;G Implants GmbH</documentation>
  </annotation>
</enumeration>
<enumeration value="0230015">
  <annotation>
    <documentation>Speetec Implantate GmbH</documentation>
  </annotation>
</enumeration>
<enumeration value="0230016">
  <annotation>
    <documentation>Stemcup Medical Products GmbH</documentation>
  </annotation>
</enumeration>
<enumeration value="0230017">
  <annotation>
    <documentation>Symbios Deutschland GmbH</documentation>
  </annotation>
</enumeration>
<enumeration value="0230018">
  <annotation>
    <documentation>Tantum AG</documentation>
  </annotation>
</enumeration>
<enumeration value="0230019">
  <annotation>
    <documentation>Tornier GmbH</documentation>
  </annotation>
</enumeration>
<enumeration value="0230020">
  <annotation>
    <documentation>MicroPort Orthopedics GmbH</documentation>
  </annotation>
</enumeration>
<enumeration value="0230021">
  <annotation>
    <documentation>aap Implanate AG</documentation>
  </annotation>
</enumeration>
<enumeration value="0230022">
  <annotation>
    <documentation>AQImplants</documentation>
  </annotation>
</enumeration>
```



```
</enumeration>
<enumeration value="0230023">
  <annotation>
    <documentation>ESKA Orthodynamics GmbH</documentation>
  </annotation>
</enumeration>
<enumeration value="0230024">
  <annotation>
    <documentation>Atecos medical AG</documentation>
  </annotation>
</enumeration>
<enumeration value="0230025">
  <annotation>
    <documentation>Chiropro GmbH</documentation>
  </annotation>
</enumeration>
<enumeration value="0230026">
  <annotation>
    <documentation>Medacta</documentation>
  </annotation>
</enumeration>
<enumeration value="0230027">
  <annotation>
    <documentation>OHST Medizintechnik AG</documentation>
  </annotation>
</enumeration>
<enumeration value="0230028">
  <annotation>
    <documentation>Lima Deutschland GmbH</documentation>
  </annotation>
</enumeration>
<enumeration value="0230029">
  <annotation>
    <documentation>alloPlus GmbH</documentation>
  </annotation>
</enumeration>
<enumeration value="0230030">
  <annotation>
    <documentation>Heraeus Medical GmbH</documentation>
  </annotation>
</enumeration>
<enumeration value="0230031">
  <annotation>
    <documentation>ImplanTec Deutschland GmbH</documentation>
  </annotation>
</enumeration>
<enumeration value="0230032">
  <annotation>
    <documentation>Falcon Medical GmbH</documentation>
  </annotation>
</enumeration>
<enumeration value="0230033">
  <annotation>
    <documentation>Meril GmbH</documentation>
  </annotation>
</enumeration>
<enumeration value="0230034">
  <annotation>
    <documentation>Zimmer Germany GmbH</documentation>
  </annotation>
</enumeration>
```

```

</annotation>
</enumeration>
<enumeration value="0230035">
  <annotation>
    <documentation>Stryker GmbH & Co. KG</documentation>
  </annotation>
</enumeration>
<enumeration value="0230036">
  <annotation>
    <documentation>Aesculap AG</documentation>
  </annotation>
</enumeration>
<enumeration value="0230037">
  <annotation>
    <documentation>Waldemar Link GmbH & Co. KG</documentation>
  </annotation>
</enumeration>
<enumeration value="0230038">
  <annotation>
    <documentation>Corin Germany GmbH</documentation>
  </annotation>
</enumeration>
<enumeration value="0230039">
  <annotation>
    <documentation>nicht belegter Wert</documentation>
  </annotation>
</enumeration>
<enumeration value="0230040">
  <annotation>
    <documentation>nicht belegter Wert</documentation>
  </annotation>
</enumeration>
<enumeration value="0230041">
  <annotation>
    <documentation>nicht belegter Wert</documentation>
  </annotation>
</enumeration>
<enumeration value="0230042">
  <annotation>
    <documentation>sonstige</documentation>
  </annotation>
</enumeration>
<enumeration value="0230043">
  <annotation>
    <documentation>nicht belegter Wert</documentation>
  </annotation>
</enumeration>
<enumeration value="0230044">
  <annotation>
    <documentation>nicht belegter Wert</documentation>
  </annotation>
</enumeration>
</restriction>
</simpleType>

```

simpleType enum_0252

namespace	http://xml.ir-d.de/sak
-----------	------------------------

type	restriction of string												
properties	base xs:string												
facets	<table border="1"> <thead> <tr> <th>Kind</th> <th>Value</th> <th>Annotation</th> </tr> </thead> <tbody> <tr> <td>enumeration</td> <td>0252001</td> <td>documentation Pfanne</td> </tr> <tr> <td>enumeration</td> <td>0252002</td> <td>documentation Schaft</td> </tr> <tr> <td>enumeration</td> <td>0252003</td> <td>documentation beides</td> </tr> </tbody> </table>	Kind	Value	Annotation	enumeration	0252001	documentation Pfanne	enumeration	0252002	documentation Schaft	enumeration	0252003	documentation beides
Kind	Value	Annotation											
enumeration	0252001	documentation Pfanne											
enumeration	0252002	documentation Schaft											
enumeration	0252003	documentation beides											
annotation	documentation Kat_EP_KomponenteHuefte												
source	<pre> <simpleType name="enum_0252"> <annotation> <documentation>Kat_EP_KomponenteHuefte</documentation> </annotation> <restriction base="xs:string"> <enumeration value="0252001"> <annotation> <documentation>Pfanne</documentation> </annotation> </enumeration> <enumeration value="0252002"> <annotation> <documentation>Schaft</documentation> </annotation> </enumeration> <enumeration value="0252003"> <annotation> <documentation>beides</documentation> </annotation> </enumeration> </restriction> </simpleType> </pre>												

simpleType **enum_0254**

namespace	http://xml.ir-d.de/sak															
type	restriction of string															
properties	base xs:string															
facets	<table border="1"> <thead> <tr> <th>Kind</th> <th>Value</th> <th>Annotation</th> </tr> </thead> <tbody> <tr> <td>enumeration</td> <td>0254001</td> <td>documentation Femur</td> </tr> <tr> <td>enumeration</td> <td>0254002</td> <td>documentation Tibia</td> </tr> <tr> <td>enumeration</td> <td>0254003</td> <td>documentation Patella</td> </tr> <tr> <td>enumeration</td> <td>0254004</td> <td>documentation mehrere</td> </tr> </tbody> </table>	Kind	Value	Annotation	enumeration	0254001	documentation Femur	enumeration	0254002	documentation Tibia	enumeration	0254003	documentation Patella	enumeration	0254004	documentation mehrere
Kind	Value	Annotation														
enumeration	0254001	documentation Femur														
enumeration	0254002	documentation Tibia														
enumeration	0254003	documentation Patella														
enumeration	0254004	documentation mehrere														
annotation	documentation Kat_EP_KomponenteKnie															
source	<pre> <simpleType name="enum_0254"> <annotation> <documentation>Kat_EP_KomponenteKnie</documentation> </annotation> <restriction base="xs:string"> <enumeration value="0254001"> </pre>															

	<pre> <annotation> <documentation>Femur</documentation> </annotation> </enumeration> <enumeration value="0254002"> <annotation> <documentation>Tibia</documentation> </annotation> </enumeration> <enumeration value="0254003"> <annotation> <documentation>Patella</documentation> </annotation> </enumeration> <enumeration value="0254004"> <annotation> <documentation>mehrere</documentation> </annotation> </enumeration> </restriction> </simpleType> </pre>
--	---

simpleType enum_0256

namespace	http://xml.ir-d.de/sak		
type	restriction of string		
properties	base xs:string		
facets	Kind	Value	Annotation
	enumeration	0256001	documentation Pfanne
	enumeration	0256002	documentation Schaft
	enumeration	0256003	documentation Pfanne und Schaft
	enumeration	0256004	documentation Femur
	enumeration	0256005	documentation Tibia
	enumeration	0256006	documentation Patella
	enumeration	0256007	documentation mehrere
annotation	documentation Kat_EP_KomponenteTFE		
source	<pre> <simpleType name="enum_0256"> <annotation> <documentation>Kat_EP_KomponenteTFE</documentation> </annotation> <restriction base="xs:string"> <enumeration value="0256001"> <annotation> <documentation>Pfanne</documentation> </annotation> </enumeration> <enumeration value="0256002"> <annotation> <documentation>Schaft</documentation> </annotation> </enumeration> </restriction> </simpleType> </pre>		

	<pre> </annotation> </enumeration> <enumeration value="0256003"> <annotation> <documentation>Pfanne und Schaft</documentation> </annotation> </enumeration> <enumeration value="0256004"> <annotation> <documentation>Femur</documentation> </annotation> </enumeration> <enumeration value="0256005"> <annotation> <documentation>Tibia</documentation> </annotation> </enumeration> <enumeration value="0256006"> <annotation> <documentation>Patella</documentation> </annotation> </enumeration> <enumeration value="0256007"> <annotation> <documentation>mehrere</documentation> </annotation> </enumeration> </restriction> </simpleType> </pre>
--	---

simpleType enum_0262

namespace	http://xml.ir-d.de/sak		
type	restriction of string		
properties	base xs:string		
facets	Kind	Value	Annotation
	enumeration	0262001	documentation Pfanne
	enumeration	0262002	documentation Schaft
	enumeration	0262003	documentation Kopf
	enumeration	0262004	documentation Inlay
	enumeration	0262005	documentation Adapter
	enumeration	0262006	documentation mehrere
annotation	documentation Kat_EP_ImplantatbruchHuefte		
source	<pre> <simpleType name="enum_0262"> <annotation> <documentation>Kat_EP_ImplantatbruchHuefte</documentation> </annotation> <restriction base="xs:string"> <enumeration value="0262001"> <annotation> </pre>		

```

        <documentation>Pfanne</documentation>
    </annotation>
</enumeration>
<enumeration value="0262002">
    <annotation>
        <documentation>Schaft</documentation>
    </annotation>
</enumeration>
<enumeration value="0262003">
    <annotation>
        <documentation>Kopf</documentation>
    </annotation>
</enumeration>
<enumeration value="0262004">
    <annotation>
        <documentation>Inlay</documentation>
    </annotation>
</enumeration>
<enumeration value="0262005">
    <annotation>
        <documentation>Adapter</documentation>
    </annotation>
</enumeration>
<enumeration value="0262006">
    <annotation>
        <documentation>mehrere</documentation>
    </annotation>
</enumeration>
</restriction>
</simpleType>

```

simpleType enum_0264

namespace	http://xml.ir-d.de/sak		
type	restriction of string		
properties	base xs:string		
facets	Kind	Value	Annotation
	enumeration	0264001	documentation Femur
	enumeration	0264002	documentation Tibia
	enumeration	0264003	documentation Inlay
	enumeration	0264004	documentation Adapter
	enumeration	0264005	documentation Verlängerung
	enumeration	0264006	documentation Schrauben
	enumeration	0264007	documentation mehrere
	enumeration	0264042	documentation andere
annotation	documentation Kat_EP_ImplantatbruchKnie		
source	<pre> <simpleType name="enum_0264"> <annotation> <documentation>Kat EP ImplantatbruchKnie</documentation> </pre>		

```

</annotation>
<restriction base="xs:string">
  <enumeration value="0264001">
    <annotation>
      <documentation>Femur</documentation>
    </annotation>
  </enumeration>
  <enumeration value="0264002">
    <annotation>
      <documentation>Tibia</documentation>
    </annotation>
  </enumeration>
  <enumeration value="0264003">
    <annotation>
      <documentation>Inlay</documentation>
    </annotation>
  </enumeration>
  <enumeration value="0264004">
    <annotation>
      <documentation>Adapter</documentation>
    </annotation>
  </enumeration>
  <enumeration value="0264005">
    <annotation>
      <documentation>Verlängerung</documentation>
    </annotation>
  </enumeration>
  <enumeration value="0264006">
    <annotation>
      <documentation>Schrauben</documentation>
    </annotation>
  </enumeration>
  <enumeration value="0264007">
    <annotation>
      <documentation>mehrere</documentation>
    </annotation>
  </enumeration>
  <enumeration value="0264042">
    <annotation>
      <documentation>andere</documentation>
    </annotation>
  </enumeration>
</restriction>
</simpleType>

```

simpleType enum_0266

namespace	http://xml.ir-d.de/sak		
type	restriction of string		
properties	base xs:string		
facets	Kind	Value	Annotation
	enumeration	0266001	documentation Pfanne
	enumeration	0266002	documentation Schaft
	enumeration	0266003	documentation Kopf

	<p>enumeration 0266004 documentation Inlay</p> <p>enumeration 0266005 documentation Adapter</p> <p>enumeration 0266006 documentation Femur</p> <p>enumeration 0266007 documentation Tibia</p> <p>enumeration 0266008 documentation Verlängerung</p> <p>enumeration 0266009 documentation Schrauben</p> <p>enumeration 0266010 documentation mehrere</p> <p>enumeration 0266042 documentation andere</p>
annotation	documentation Kat_EP_ImplantatbruchTFE
source	<pre> <simpleType name="enum_0266"> <annotation> <documentation>Kat_EP_ImplantatbruchTFE</documentation> </annotation> <restriction base="xs:string"> <enumeration value="0266001"> <annotation> <documentation>Pfanne</documentation> </annotation> </enumeration> <enumeration value="0266002"> <annotation> <documentation>Schaft</documentation> </annotation> </enumeration> <enumeration value="0266003"> <annotation> <documentation>Kopf</documentation> </annotation> </enumeration> <enumeration value="0266004"> <annotation> <documentation>Inlay</documentation> </annotation> </enumeration> <enumeration value="0266005"> <annotation> <documentation>Adapter</documentation> </annotation> </enumeration> <enumeration value="0266006"> <annotation> <documentation>Femur</documentation> </annotation> </enumeration> <enumeration value="0266007"> <annotation> <documentation>Tibia</documentation> </annotation> </enumeration> <enumeration value="0266008"> <annotation> </pre>

	<pre> <documentation>Verlängerung</documentation> </annotation> </enumeration> <enumeration value="0266009"> <annotation> <documentation>Schrauben</documentation> </annotation> </enumeration> <enumeration value="0266010"> <annotation> <documentation>mehrere</documentation> </annotation> </enumeration> <enumeration value="0266042"> <annotation> <documentation>andere</documentation> </annotation> </enumeration> </restriction> </simpleType> </pre>
--	--

simpleType enum_0270

namespace	http://xml.ir-d.de/sak		
type	restriction of string		
properties	base xs:string		
facets	Kind	Value	Annotation
	enumeration	0270001	documentation PE-Inlay
	enumeration	0270002	documentation patellare Komponente
	enumeration	0270003	documentation beides
annotation	documentation Kat_EP_VerschleissKnie		
source	<pre> <simpleType name="enum_0270"> <annotation> <documentation>Kat_EP_VerschleissKnie</documentation> </annotation> <restriction base="xs:string"> <enumeration value="0270001"> <annotation> <documentation>PE-Inlay</documentation> </annotation> </enumeration> <enumeration value="0270002"> <annotation> <documentation>patellare Komponente</documentation> </annotation> </enumeration> <enumeration value="0270003"> <annotation> <documentation>beides</documentation> </annotation> </enumeration> </restriction> </pre>		

	<code></simpleType></code>
--	----------------------------------

simpleType enum_0271

namespace	http://xml.ir-d.de/sak																					
type	restriction of string																					
properties	base xs:string																					
facets	<table><thead><tr><th>Kind</th><th>Value</th><th>Annotation</th></tr></thead><tbody><tr><td>enumeration</td><td>0271001</td><td>documentation Schraube</td></tr><tr><td>enumeration</td><td>0271002</td><td>documentation Inlay</td></tr><tr><td>enumeration</td><td>0271003</td><td>documentation patellare Komponente</td></tr><tr><td>enumeration</td><td>0271004</td><td>documentation Kopplung</td></tr><tr><td>enumeration</td><td>0271005</td><td>documentation mehrere</td></tr><tr><td>enumeration</td><td>0271042</td><td>documentation andere</td></tr></tbody></table>	Kind	Value	Annotation	enumeration	0271001	documentation Schraube	enumeration	0271002	documentation Inlay	enumeration	0271003	documentation patellare Komponente	enumeration	0271004	documentation Kopplung	enumeration	0271005	documentation mehrere	enumeration	0271042	documentation andere
Kind	Value	Annotation																				
enumeration	0271001	documentation Schraube																				
enumeration	0271002	documentation Inlay																				
enumeration	0271003	documentation patellare Komponente																				
enumeration	0271004	documentation Kopplung																				
enumeration	0271005	documentation mehrere																				
enumeration	0271042	documentation andere																				
annotation	documentation Kat_EP_MigrationKnie																					
source	<pre><simpleType name="enum_0271"> <annotation> <documentation>Kat_EP_MigrationKnie</documentation> </annotation> <restriction base="xs:string"> <enumeration value="0271001"> <annotation> <documentation>Schraube</documentation> </annotation> </enumeration> <enumeration value="0271002"> <annotation> <documentation>Inlay</documentation> </annotation> </enumeration> <enumeration value="0271003"> <annotation> <documentation>patellare Komponente</documentation> </annotation> </enumeration> <enumeration value="0271004"> <annotation> <documentation>Kopplung</documentation> </annotation> </enumeration> <enumeration value="0271005"> <annotation> <documentation>mehrere</documentation> </annotation> </enumeration> <enumeration value="0271042"> <annotation> <documentation>andere</documentation> </annotation> </enumeration> </restriction> </simpleType></pre>																					

	<pre> </restriction> </simpleType> </pre>
--	---

simpleType enum_0290

namespace	http://xml.ir-d.de/sak		
type	restriction of string		
properties	base xs:string		
facets	Kind	Value	Annotation
	enumeration	0290001	documentation Hüft-Komponente
	enumeration	0290002	documentation Knie-Komponente
	enumeration	0290003	documentation Modulare Komponente (Hüfte/Knie)
annotation	documentation Kat_EP_Artikeltyp		
source	<pre> <simpleType name="enum_0290"> <annotation> <documentation>Kat_EP_Artikeltyp</documentation> </annotation> <restriction base="xs:string"> <enumeration value="0290001"> <annotation> <documentation>Hüft-Komponente</documentation> </annotation> </enumeration> <enumeration value="0290002"> <annotation> <documentation>Knie-Komponente</documentation> </annotation> </enumeration> <enumeration value="0290003"> <annotation> <documentation>Modulare Komponente (Hüfte/Knie)</documentation> </annotation> </enumeration> </restriction> </simpleType> </pre>		

simpleType enum_0291

namespace	http://xml.ir-d.de/sak		
type	restriction of string		
properties	base xs:string		
facets	Kind	Value	Annotation
	enumeration	0291001	documentation Knochen-Zement
	enumeration	0291002	documentation sonstiges Zubehör
annotation	documentation Kat_EP_ZubehoerTyp		
source	<pre> <simpleType name="enum_0291"> <annotation> </pre>		

	<pre> <documentation>Kat_EP_ZubehoerTyp</documentation> </annotation> <restriction base="xs:string"> <enumeration value="0291001"> <annotation> <documentation>Knochen-Zement</documentation> </annotation> </enumeration> <enumeration value="0291002"> <annotation> <documentation>sonstiges Zubehör</documentation> </annotation> </enumeration> </restriction> </simpleType> </pre>
--	---

simpleType enum_0300

namespace	http://xml.ir-d.de/sak		
type	restriction of string		
properties	base xs:string		
facets	Kind	Value	Annotation
	enumeration	0300001	documentation konventieller Aortenklappenersatz
	enumeration	0300002	documentation kathetergestützte Aortenklappenimplantation (TAVI)
annotation	documentation Kat_AK_ArtEingriff		
source	<pre> <simpleType name="enum_0300"> <annotation> <documentation>Kat_AK_ArtEingriff</documentation> </annotation> <restriction base="xs:string"> <enumeration value="0300001"> <annotation> <documentation>konventieller Aortenklappenersatz</documentation> </annotation> </enumeration> <enumeration value="0300002"> <annotation> <documentation>kathetergestützte Aortenklappenimplantation (TAVI)</documentation> </annotation> </enumeration> </restriction> </simpleType> </pre>		

simpleType enum_0302

namespace	http://xml.ir-d.de/sak		
type	restriction of string		
properties	base xs:string		
facets	Kind	Value	Annotation
	enumeration	0302001	documentation

	enumeration 0302002 Stenose documentation Insuffizienz
	enumeration 0302003 documentation Stenose und Insuffizienz
annotation	documentation Kat_AK_GrundEingriff
source	<pre> <simpleType name="enum_0302"> <annotation> <documentation>Kat_AK_GrundEingriff</documentation> </annotation> <restriction base="xs:string"> <enumeration value="0302001"> <annotation> <documentation>Stenose</documentation> </annotation> </enumeration> <enumeration value="0302002"> <annotation> <documentation>Insuffizienz</documentation> </annotation> </enumeration> <enumeration value="0302003"> <annotation> <documentation>Stenose und Insuffizienz</documentation> </annotation> </enumeration> </restriction> </simpleType> </pre>

simpleType enum 0318

namespace	http://xml.ir-d.de/sak		
type	restriction of string		
properties	base xs:string		
facets	Kind	Value	Annotation
	enumeration	0318001	documentation transapikal
	enumeration	0318002	documentation transaortal
	enumeration	0318003	documentation transfemoral
	enumeration	0318004	documentation transaxillär
	enumeration	0318042	documentation anderer Zugangsweg
annotation	documentation Kat_AK_ZugangKatheter		
source	<pre> <simpleType name="enum_0318"> <annotation> <documentation>Kat_AK_ZugangKatheter</documentation> </annotation> <restriction base="xs:string"> <enumeration value="0318001"> <annotation> <documentation>transapikal</documentation> </annotation> </pre>		

	<pre> </enumeration> <enumeration value="0318002"> <annotation> <documentation>transaortal</documentation> </annotation> </enumeration> <enumeration value="0318003"> <annotation> <documentation>transfemoral</documentation> </annotation> </enumeration> <enumeration value="0318004"> <annotation> <documentation>transaxillär</documentation> </annotation> </enumeration> <enumeration value="0318042"> <annotation> <documentation>anderer Zugangsweg</documentation> </annotation> </enumeration> </restriction> </simpleType> </pre>
--	---

simpleType enum_0320

namespace	http://xml.ir-d.de/sak		
type	restriction of string		
properties	base xs:string		
facets	Kind	Value	Annotation
	enumeration	0320001	documentation konventionelle Sternotomie
	enumeration	0320002	documentation partielle Sternotomie
	enumeration	0320003	documentation parastemaler Zugang
	enumeration	0320042	documentation anderer Zugangsweg
annotation	documentation Kat_AK_ZugangKonventionell		
source	<pre> <simpleType name="enum_0320"> <annotation> <documentation>Kat_AK_ZugangKonventionell</documentation> </annotation> <restriction base="xs:string"> <enumeration value="0320001"> <annotation> <documentation>konventionelle Sternotomie</documentation> </annotation> </enumeration> <enumeration value="0320002"> <annotation> <documentation>partielle Sternotomie</documentation> </annotation> </enumeration> <enumeration value="0320003"> <annotation> </pre>		

	<pre> <documentation>parasternaler Zugang</documentation> </annotation> </enumeration> <enumeration value="032004"> <annotation> <documentation>anderer Zugangsweg</documentation> </annotation> </enumeration> </restriction> </simpleType> </pre>
--	---

simpleType enum_0322

namespace	http://xml.ir-d.de/sak		
type	restriction of string		
properties	base xs:string		
facets	Kind	Value	Annotation
	enumeration	0322001	documentation nein
	enumeration	0322002	documentation ja, diätetisch behandelt
	enumeration	0322003	documentation ja, orale Medikation
	enumeration	0322004	documentation ja, mit Insulin behandelt
	enumeration	0322005	documentation ja, unbehandelt
	enumeration	0322099	documentation unbekannt
annotation	documentation Kat_AK_Diabetes		
source	<pre> <simpleType name="enum_0322"> <annotation> <documentation>Kat_AK_Diabetes</documentation> </annotation> <restriction base="xs:string"> <enumeration value="0322001"> <annotation> <documentation>nein</documentation> </annotation> </enumeration> <enumeration value="0322002"> <annotation> <documentation>ja, diätetisch behandelt</documentation> </annotation> </enumeration> <enumeration value="0322003"> <annotation> <documentation>ja, orale Medikation</documentation> </annotation> </enumeration> <enumeration value="0322004"> <annotation> <documentation>ja, mit Insulin behandelt</documentation> </annotation> </enumeration> <enumeration value="0322005"> </pre>		

	<pre> <annotation> <documentation>ja, unbehandelt</documentation> </annotation> </enumeration> <enumeration value="0322099"> <annotation> <documentation>unbekannt</documentation> </annotation> </enumeration> </restriction> </simpleType> </pre>
--	---

simpleType enum_0324

namespace	http://xml.ir-d.de/sak		
type	restriction of string		
properties	base xs:string		
facets	Kind	Value	Annotation
	enumeration	0324001	documentation (I): Beschwerdefreiheit, normale körperliche Belastbarkeit
	enumeration	0324002	documentation (II): Beschwerden bei stärkerer körperlicher Belastung
	enumeration	0324003	documentation (III): Beschwerden bei leichter körperlicher Belastung
	enumeration	0324004	documentation (IV): Beschwerden in Ruhe
annotation	documentation Kat_AK_NYHA		
source	<pre> <simpleType name="enum_0324"> <annotation> <documentation>Kat_AK_NYHA</documentation> </annotation> <restriction base="xs:string"> <enumeration value="0324001"> <annotation> <documentation>(I): Beschwerdefreiheit, normale körperliche Belastbarkeit</documentation> </annotation> </enumeration> <enumeration value="0324002"> <annotation> <documentation>(II): Beschwerden bei stärkerer körperlicher Belastung</documentation> </annotation> </enumeration> <enumeration value="0324003"> <annotation> <documentation>(III): Beschwerden bei leichter körperlicher Belastung</documentation> </annotation> </enumeration> <enumeration value="0324004"> <annotation> <documentation>(IV): Beschwerden in Ruhe</documentation> </annotation> </enumeration> </restriction> </pre>		

	<code></simpleType></code>
--	----------------------------------

simpleType enum_0330

namespace	http://xml.ir-d.de/sak																																																
type	restriction of string																																																
properties	base xs:string																																																
facets	<table><thead><tr><th>Kind</th><th>Value</th><th>Annotation</th></tr></thead><tbody><tr><td>enumeration</td><td>0330001</td><td>documentation ATS Medical</td></tr><tr><td>enumeration</td><td>0330002</td><td>documentation Edwards Lifesciences</td></tr><tr><td>enumeration</td><td>0330003</td><td>documentation Medtronic</td></tr><tr><td>enumeration</td><td>0330004</td><td>documentation JenaValve</td></tr><tr><td>enumeration</td><td>0330005</td><td>documentation Corcym</td></tr><tr><td>enumeration</td><td>0330006</td><td>documentation StJude Medical/Abbott</td></tr><tr><td>enumeration</td><td>0330007</td><td>documentation Symetis</td></tr><tr><td>enumeration</td><td>0330008</td><td>documentation Direct Flow Medical</td></tr><tr><td>enumeration</td><td>0330009</td><td>documentation Boston Scientific</td></tr><tr><td>enumeration</td><td>0330010</td><td>documentation nicht belegter Wert</td></tr><tr><td>enumeration</td><td>0330011</td><td>documentation nicht belegter Wert</td></tr><tr><td>enumeration</td><td>0330012</td><td>documentation nicht belegter Wert</td></tr><tr><td>enumeration</td><td>0330013</td><td>documentation nicht belegter Wert</td></tr><tr><td>enumeration</td><td>0330014</td><td>documentation nicht belegter Wert</td></tr><tr><td>enumeration</td><td>0330042</td><td>documentation sonstiger Hersteller</td></tr></tbody></table>	Kind	Value	Annotation	enumeration	0330001	documentation ATS Medical	enumeration	0330002	documentation Edwards Lifesciences	enumeration	0330003	documentation Medtronic	enumeration	0330004	documentation JenaValve	enumeration	0330005	documentation Corcym	enumeration	0330006	documentation StJude Medical/Abbott	enumeration	0330007	documentation Symetis	enumeration	0330008	documentation Direct Flow Medical	enumeration	0330009	documentation Boston Scientific	enumeration	0330010	documentation nicht belegter Wert	enumeration	0330011	documentation nicht belegter Wert	enumeration	0330012	documentation nicht belegter Wert	enumeration	0330013	documentation nicht belegter Wert	enumeration	0330014	documentation nicht belegter Wert	enumeration	0330042	documentation sonstiger Hersteller
Kind	Value	Annotation																																															
enumeration	0330001	documentation ATS Medical																																															
enumeration	0330002	documentation Edwards Lifesciences																																															
enumeration	0330003	documentation Medtronic																																															
enumeration	0330004	documentation JenaValve																																															
enumeration	0330005	documentation Corcym																																															
enumeration	0330006	documentation StJude Medical/Abbott																																															
enumeration	0330007	documentation Symetis																																															
enumeration	0330008	documentation Direct Flow Medical																																															
enumeration	0330009	documentation Boston Scientific																																															
enumeration	0330010	documentation nicht belegter Wert																																															
enumeration	0330011	documentation nicht belegter Wert																																															
enumeration	0330012	documentation nicht belegter Wert																																															
enumeration	0330013	documentation nicht belegter Wert																																															
enumeration	0330014	documentation nicht belegter Wert																																															
enumeration	0330042	documentation sonstiger Hersteller																																															
annotation	documentation Kat_AK_Hersteller																																																
source	<pre><simpleType name="enum_0330"> <annotation> <documentation>Kat_AK_Hersteller</documentation> </annotation> <restriction base="xs:string"> <enumeration value="0330001"> <annotation> <documentation>ATS Medical</documentation> </annotation> </enumeration> <enumeration value="0330002"> <annotation> <documentation>Edwards Lifesciences</documentation> </annotation> </enumeration> <enumeration value="0330003"> <annotation> <documentation>Medtronic</documentation> </annotation> </enumeration> </restriction> </simpleType></pre>																																																

```
</enumeration>
<enumeration value="0330004">
  <annotation>
    <documentation>JenaValve</documentation>
  </annotation>
</enumeration>
<enumeration value="0330005">
  <annotation>
    <documentation>Corcym</documentation>
  </annotation>
</enumeration>
<enumeration value="0330006">
  <annotation>
    <documentation>St.Jude Medical/Abbott</documentation>
  </annotation>
</enumeration>
<enumeration value="0330007">
  <annotation>
    <documentation>Symetis</documentation>
  </annotation>
</enumeration>
<enumeration value="0330008">
  <annotation>
    <documentation>Direct Flow Medical</documentation>
  </annotation>
</enumeration>
<enumeration value="0330009">
  <annotation>
    <documentation>Boston Scientific</documentation>
  </annotation>
</enumeration>
<enumeration value="0330010">
  <annotation>
    <documentation>nicht belegter Wert</documentation>
  </annotation>
</enumeration>
<enumeration value="0330011">
  <annotation>
    <documentation>nicht belegter Wert</documentation>
  </annotation>
</enumeration>
<enumeration value="0330012">
  <annotation>
    <documentation>nicht belegter Wert</documentation>
  </annotation>
</enumeration>
<enumeration value="0330013">
  <annotation>
    <documentation>nicht belegter Wert</documentation>
  </annotation>
</enumeration>
<enumeration value="0330014">
  <annotation>
    <documentation>nicht belegter Wert</documentation>
  </annotation>
</enumeration>
<enumeration value="0330042">
  <annotation>
    <documentation>sonstiger Hersteller</documentation>
  </annotation>
</enumeration>
```

	<pre> </annotation> </enumeration> </restriction> </simpleType> </pre>
--	--

simpleType enum_0338

namespace	http://xml.ir-d.de/sak		
type	restriction of string		
properties	base xs:string		
facets	Kind	Value	Annotation
	enumeration	0338001	documentation LAD
	enumeration	0338002	documentation RCA
	enumeration	0338003	documentation RCX
	enumeration	0338004	documentation Hauptstamm
annotation	documentation Kat_AK_PCIArterien		
source	<pre> <simpleType name="enum_0338"> <annotation> <documentation>Kat_AK_PCIArterien</documentation> </annotation> <restriction base="xs:string"> <enumeration value="0338001"> <annotation> <documentation>LAD</documentation> </annotation> </enumeration> <enumeration value="0338002"> <annotation> <documentation>RCA</documentation> </annotation> </enumeration> <enumeration value="0338003"> <annotation> <documentation>RCX</documentation> </annotation> </enumeration> <enumeration value="0338004"> <annotation> <documentation>Hauptstamm</documentation> </annotation> </enumeration> </restriction> </simpleType> </pre>		

simpleType enum_0339

namespace	http://xml.ir-d.de/sak		
type	restriction of string		
properties	base xs:string		

facets	<table border="1"> <thead> <tr> <th>Kind</th> <th>Value</th> <th>Annotation</th> </tr> </thead> <tbody> <tr> <td>enumeration</td> <td>0339001</td> <td>documentation TEE</td> </tr> <tr> <td>enumeration</td> <td>0339002</td> <td>documentation CT</td> </tr> <tr> <td>enumeration</td> <td>0339042</td> <td>documentation andere</td> </tr> </tbody> </table>	Kind	Value	Annotation	enumeration	0339001	documentation TEE	enumeration	0339002	documentation CT	enumeration	0339042	documentation andere
Kind	Value	Annotation											
enumeration	0339001	documentation TEE											
enumeration	0339002	documentation CT											
enumeration	0339042	documentation andere											
annotation	documentation Kat_AK_AnnulusMessmethode												
source	<pre> <simpleType name="enum_0339"> <annotation> <documentation>Kat_AK_AnnulusMessmethode</documentation> </annotation> <restriction base="xs:string"> <enumeration value="0339001"> <annotation> <documentation>TEE</documentation> </annotation> </enumeration> <enumeration value="0339002"> <annotation> <documentation>CT</documentation> </annotation> </enumeration> <enumeration value="0339042"> <annotation> <documentation>andere</documentation> </annotation> </enumeration> </restriction> </simpleType> </pre>												

simpleType enum_0341

namespace	http://xml.ir-d.de/sak																		
type	restriction of string																		
properties	base xs:string																		
facets	<table border="1"> <thead> <tr> <th>Kind</th> <th>Value</th> <th>Annotation</th> </tr> </thead> <tbody> <tr> <td>enumeration</td> <td>0341001</td> <td>documentation intraprozedural verstorben</td> </tr> <tr> <td>enumeration</td> <td>0341002</td> <td>documentation Implantation von mehr als einer Prothese</td> </tr> <tr> <td>enumeration</td> <td>0341003</td> <td>documentation gravierende Gefäß- oder Zugangskomplikation (gemäß VARC-3)</td> </tr> <tr> <td>enumeration</td> <td>0341004</td> <td>documentation erforderlicher chirurgischer oder interventioneller Eingriff wegen einer Klappenfehlfunktion (gemäß VARC-3)</td> </tr> <tr> <td>enumeration</td> <td>0341005</td> <td>documentation &qt= große strukturelle kardiale Komplikation (gemäß VARC-3)</td> </tr> </tbody> </table>	Kind	Value	Annotation	enumeration	0341001	documentation intraprozedural verstorben	enumeration	0341002	documentation Implantation von mehr als einer Prothese	enumeration	0341003	documentation gravierende Gefäß- oder Zugangskomplikation (gemäß VARC-3)	enumeration	0341004	documentation erforderlicher chirurgischer oder interventioneller Eingriff wegen einer Klappenfehlfunktion (gemäß VARC-3)	enumeration	0341005	documentation &qt= große strukturelle kardiale Komplikation (gemäß VARC-3)
Kind	Value	Annotation																	
enumeration	0341001	documentation intraprozedural verstorben																	
enumeration	0341002	documentation Implantation von mehr als einer Prothese																	
enumeration	0341003	documentation gravierende Gefäß- oder Zugangskomplikation (gemäß VARC-3)																	
enumeration	0341004	documentation erforderlicher chirurgischer oder interventioneller Eingriff wegen einer Klappenfehlfunktion (gemäß VARC-3)																	
enumeration	0341005	documentation &qt= große strukturelle kardiale Komplikation (gemäß VARC-3)																	
annotation	documentation Kat_AK_FailureGrund																		
source	<pre> <simpleType name="enum_0341"> <annotation> <documentation>Kat_AK_FailureGrund</documentation> </annotation> <restriction base="xs:string"> <enumeration value="0341001"> <annotation> </pre>																		

	<pre> <documentation>intraprozedural verstorben</documentation> </annotation> </enumeration> <enumeration value="0341002"> <annotation> <documentation>Implantation von mehr als einer Prothese</documentation> </annotation> </enumeration> <enumeration value="0341003"> <annotation> <documentation>gravierende Gefäß- oder Zugangskomplikation (gemäß VARC-3)</documentation> </annotation> </enumeration> <enumeration value="0341004"> <annotation> <documentation>erforderlicher chirurgischer oder interventioneller Eingriff wegen einer Klappenfehlfunktion (gemäß VARC-3)</documentation> </annotation> </enumeration> <enumeration value="0341005"> <annotation> <documentation>&gt;= große strukturelle kardiale Komplikation (gemäß VARC-3)</documentation> </annotation> </enumeration> </restriction> </simpleType> </pre>
--	--

simpleType enum_0342

namespace	http://xml.ir-d.de/sak		
type	restriction of string		
properties	base xs:string		
facets	Kind	Value	Annotation
	enumeration	0342001	documentation Alter
	enumeration	0342002	documentation Frailty
	enumeration	0342003	documentation Hochrisiko
	enumeration	0342004	documentation Prognose-limitierende Zweiterkrankung
	enumeration	0342005	documentation Porzellan-Aorta
	enumeration	0342042	documentation Sonstige
annotation	documentation Kat_AK_Tavi		
source	<pre> <simpleType name="enum_0342"> <annotation> <documentation>Kat_AK_Tavi</documentation> </annotation> <restriction base="xs:string"> <enumeration value="0342001"> <annotation> <documentation>Alter</documentation> </pre>		

```

</annotation>
</enumeration>
<enumeration value="0342002">
  <annotation>
    <documentation>Frailty</documentation>
  </annotation>
</enumeration>
<enumeration value="0342003">
  <annotation>
    <documentation>Hochrisiko</documentation>
  </annotation>
</enumeration>
<enumeration value="0342004">
  <annotation>
    <documentation>Prognose-limitierende Zweiterkrankung</documentation>
  </annotation>
</enumeration>
<enumeration value="0342005">
  <annotation>
    <documentation>Porzellan-Aorta</documentation>
  </annotation>
</enumeration>
<enumeration value="0342042">
  <annotation>
    <documentation>Sonstige</documentation>
  </annotation>
</enumeration>
</restriction>
</simpleType>

```

simpleType enum_0343

namespace	http://xml.ir-d.de/sak		
type	restriction of string		
properties	base xs:string		
facets	Kind	Value	Annotation
	enumeration	0343001	documentation Device-Fehlpositionierung
	enumeration	0343002	documentation Koronarostienverschluss
	enumeration	0343003	documentation Aortendissektion
	enumeration	0343004	documentation Aortenregurgitation > = 2. Grades
	enumeration	0343005	documentation Annulus-Ruptur
	enumeration	0343006	documentation Ruptur-/Perforation einer Herzhöhle ohne Therapiebedarf
	enumeration	0343007	documentation Ruptur-/Perforation einer Herzhöhle mit Therapiebedarf
	enumeration	0343008	documentation Perikardtamponade
	enumeration	0343009	documentation kardiale Dekompensation
	enumeration	0343010	documentation Himembolie
	enumeration	0343011	documentation Rhythmusstörungen

	<p>enumeration 0343012 documentation Device-Embolisation</p> <p>enumeration 0343013 documentation vaskuläre Komplikation</p> <p>enumeration 0343014 documentation Low Cardiac Output</p> <p>enumeration 0343015 documentation schwerwiegende Blutungen (intraprozedural)</p> <p>enumeration 0343016 documentation lebensbedrohliche Blutungen (intraprozedural)</p> <p>enumeration 0343017 documentation Patient verstarb im OP/Katheterlabor</p> <p>enumeration 0343042 documentation sonstige intraprozedurale Komplikationen</p>
annotation	documentation Kat_AK_KomplikationTyp
source	<pre> <simpleType name="enum_0343"> <annotation> <documentation>Kat_AK_KomplikationTyp</documentation> </annotation> <restriction base="xs:string"> <enumeration value="0343001"> <annotation> <documentation>Device-Fehlpositionierung</documentation> </annotation> </enumeration> <enumeration value="0343002"> <annotation> <documentation>Koronarostienverschluss</documentation> </annotation> </enumeration> <enumeration value="0343003"> <annotation> <documentation>Aortendissektion</documentation> </annotation> </enumeration> <enumeration value="0343004"> <annotation> <documentation>Aortenregurgitation &gt; = 2. Grades</documentation> </annotation> </enumeration> <enumeration value="0343005"> <annotation> <documentation>Annulus-Ruptur</documentation> </annotation> </enumeration> <enumeration value="0343006"> <annotation> <documentation>Ruptur-/Perforation einer Herzhöhle ohne Therapiebedarf</documentation> </annotation> </enumeration> <enumeration value="0343007"> <annotation> <documentation>Ruptur-/Perforation einer Herzhöhle mit Therapiebedarf</documentation> </annotation> </enumeration> <enumeration value="0343008"> <annotation> </pre>

```

    <documentation>Perikardtamponade</documentation>
  </annotation>
</enumeration>
<enumeration value="0343009">
  <annotation>
    <documentation>kardiale Dekompensation</documentation>
  </annotation>
</enumeration>
<enumeration value="0343010">
  <annotation>
    <documentation>Hirnembolie</documentation>
  </annotation>
</enumeration>
<enumeration value="0343011">
  <annotation>
    <documentation>Rhythmusstörungen</documentation>
  </annotation>
</enumeration>
<enumeration value="0343012">
  <annotation>
    <documentation>Device-Embolisation</documentation>
  </annotation>
</enumeration>
<enumeration value="0343013">
  <annotation>
    <documentation>vaskuläre Komplikation</documentation>
  </annotation>
</enumeration>
<enumeration value="0343014">
  <annotation>
    <documentation>Low Cardiac Output</documentation>
  </annotation>
</enumeration>
<enumeration value="0343015">
  <annotation>
    <documentation>schwerwiegende Blutungen
(intraprozedural)</documentation>
  </annotation>
</enumeration>
<enumeration value="0343016">
  <annotation>
    <documentation>lebensbedrohliche Blutungen
(intraprozedural)</documentation>
  </annotation>
</enumeration>
<enumeration value="0343017">
  <annotation>
    <documentation>Patient verstarb im OP/Katheterlabor</documentation>
  </annotation>
</enumeration>
<enumeration value="0343042">
  <annotation>
    <documentation>sonstige intraprozedurale
Komplikationen</documentation>
  </annotation>
</enumeration>
</restriction>
</simpleType>

```

simpleType enum_0346

namespace	http://xml.ir-d.de/sak		
type	restriction of string		
properties	base xs:string		
facets	Kind	Value	Annotation
	enumeration	0346001	documentation keine Therapie erforderlich
	enumeration	0346002	documentation medikamentös
	enumeration	0346003	documentation IABP
	enumeration	0346004	documentation VAD
	enumeration	0346005	documentation ECMO
	enumeration	0346042	documentation sonstige
annotation	documentation Kat_AK_TherapieLCO		
source	<pre> <simpleType name="enum_0346"> <annotation> <documentation>Kat_AK_TherapieLCO</documentation> </annotation> <restriction base="xs:string"> <enumeration value="0346001"> <annotation> <documentation>keine Therapie erforderlich</documentation> </annotation> </enumeration> <enumeration value="0346002"> <annotation> <documentation>medikamentös</documentation> </annotation> </enumeration> <enumeration value="0346003"> <annotation> <documentation>IABP</documentation> </annotation> </enumeration> <enumeration value="0346004"> <annotation> <documentation>VAD</documentation> </annotation> </enumeration> <enumeration value="0346005"> <annotation> <documentation>ECMO</documentation> </annotation> </enumeration> <enumeration value="0346042"> <annotation> <documentation>sonstige</documentation> </annotation> </enumeration> </restriction> </simpleType> </pre>		

simpleType enum 0347

namespace	http://xml.ir-d.de/sak		
type	restriction of string		
properties	base xs:string		
facets	Kind	Value	Annotation
	enumeration	0347001	documentation Einzeleingriff
	enumeration	0347002	documentation Kombinationseingriff mit mehreren Prozeduren
annotation	documentation Kat_AK_Eingriffsumfang		
source	<pre> <simpleType name="enum_0347"> <annotation> <documentation>Kat_AK_Eingriffsumfang</documentation> </annotation> <restriction base="xs:string"> <enumeration value="0347001"> <annotation> <documentation>Einzeleingriff</documentation> </annotation> </enumeration> <enumeration value="0347002"> <annotation> <documentation>Kombinationseingriff mit mehreren Prozeduren</documentation> </annotation> </enumeration> </restriction> </simpleType> </pre>		

simpleType enum_0348

namespace	http://xml.ir-d.de/sak		
type	restriction of string		
properties	base xs:string		
facets	Kind	Value	Annotation
	enumeration	0348001	documentation mit HLM
	enumeration	0348002	documentation ohne HLM
	enumeration	0348003	documentation Umstieg von OP ohne HLM auf OP mit HLM
annotation	documentation Kat_AK_OPVorgehen		
source	<pre> <simpleType name="enum_0348"> <annotation> <documentation>Kat_AK_OPVorgehen</documentation> </annotation> <restriction base="xs:string"> <enumeration value="0348001"> <annotation> <documentation>mit HLM</documentation> </annotation> </enumeration> </restriction> </simpleType> </pre>		

	<pre> </enumeration> <enumeration value="0348002"> <annotation> <documentation>ohne HLM</documentation> </annotation> </enumeration> <enumeration value="0348003"> <annotation> <documentation>Umstieg von OP ohne HLM auf OP mit HLM</documentation> </annotation> </enumeration> </restriction> </simpleType> </pre>
--	--

simpleType enum_0350

namespace	http://xml.ir-d.de/sak		
type	restriction of string		
properties	base xs:string		
facets	Kind	Value	Annotation
	enumeration	0350001	documentation IABP
	enumeration	0350002	documentation Impella
	enumeration	0350003	documentation vv ECMO
	enumeration	0350004	documentation va ECMO
	enumeration	0350042	documentation andere
annotation	documentation Kat_AK_Methode		
source	<pre> <simpleType name="enum_0350"> <annotation> <documentation>Kat_AK_Methode</documentation> </annotation> <restriction base="xs:string"> <enumeration value="0350001"> <annotation> <documentation>IABP</documentation> </annotation> </enumeration> <enumeration value="0350002"> <annotation> <documentation>Impella</documentation> </annotation> </enumeration> <enumeration value="0350003"> <annotation> <documentation>vv ECMO</documentation> </annotation> </enumeration> <enumeration value="0350004"> <annotation> <documentation>va ECMO</documentation> </annotation> </enumeration> </restriction> </simpleType> </pre>		

	<pre> <enumeration value="0350042"> <annotation> <documentation>andere</documentation> </annotation> </enumeration> </restriction> </simpleType> </pre>
--	---

simpleType enum_0351

namespace	http://xml.ir-d.de/sak		
type	restriction of string		
properties	base xs:string		
facets	Kind	Value	Annotation
	enumeration	0351001	documentation nein
	enumeration	0351002	documentation ja, zu Sternotomie
	enumeration	0351003	documentation ja, zu transapikal
	enumeration	0351004	documentation ja, zu transaortal
	enumeration	0351005	documentation ja, zu transfemoral
	enumeration	0351006	documentation ja, zu transaxillär
	enumeration	0351007	documentation ja, zu anderem endovaskulären Zugang
	enumeration	0351042	documentation ja, zu anderem Zugang
annotation	documentation Kat_AK_Konversion		
source	<pre> <simpleType name="enum_0351"> <annotation> <documentation>Kat_AK_Konversion</documentation> </annotation> <restriction base="xs:string"> <enumeration value="0351001"> <annotation> <documentation>nein</documentation> </annotation> </enumeration> <enumeration value="0351002"> <annotation> <documentation>ja, zu Sternotomie</documentation> </annotation> </enumeration> <enumeration value="0351003"> <annotation> <documentation>ja, zu transapikal</documentation> </annotation> </enumeration> <enumeration value="0351004"> <annotation> <documentation>ja, zu transaortal</documentation> </annotation> </enumeration> <enumeration value="0351005"> </pre>		

	<pre> <annotation> <documentation>ja, zu transfemoral</documentation> </annotation> </enumeration> <enumeration value="0351006"> <annotation> <documentation>ja, zu transaxillär</documentation> </annotation> </enumeration> <enumeration value="0351007"> <annotation> <documentation>ja, zu anderem endovaskulären Zugang</documentation> </annotation> </enumeration> <enumeration value="0351042"> <annotation> <documentation>ja, zu anderem Zugang</documentation> </annotation> </enumeration> </restriction> </simpleType> </pre>
--	--

simpleType enum 0352

namespace	http://xml.ir-d.de/sak		
type	restriction of string		
properties	base xs:string		
facets	Kind	Value	Annotation
	enumeration	0352001	documentation nein
	enumeration	0352002	documentation ja, Intubationsnarkose
	enumeration	0352003	documentation ja, Maskenbeatmung, incl. LAMA
	enumeration	0352042	documentation ja, unbekannt welche
annotation	documentation Kat_AK_Anaesthesie		
source	<pre> <simpleType name="enum_0352"> <annotation> <documentation>Kat_AK_Anaesthesie</documentation> </annotation> <restriction base="xs:string"> <enumeration value="0352001"> <annotation> <documentation>nein</documentation> </annotation> </enumeration> <enumeration value="0352002"> <annotation> <documentation>ja, Intubationsnarkose</documentation> </annotation> </enumeration> <enumeration value="0352003"> <annotation> <documentation>ja, Maskenbeatmung, incl. LAMA</documentation> </annotation> </enumeration> </restriction> </simpleType> </pre>		

	<pre> </enumeration> <enumeration value="0352042"> <annotation> <documentation>ja, unbekannt welche</documentation> </annotation> </enumeration> </restriction> </simpleType> </pre>
--	--

simpleType enum_0353

namespace	http://xml.ir-d.de/sak		
type	restriction of string		
properties	base xs:string		
facets	Kind	Value	Annotation
	enumeration	0353001	documentation keine
	enumeration	0353002	documentation leichtgradig
	enumeration	0353003	documentation mittelgradig
	enumeration	0353004	documentation hochgradig
	enumeration	0353099	documentation nicht bestimmbar
annotation	documentation Kat_AK_ResidualeArteninsuffizienz		
source	<pre> <simpleType name="enum_0353"> <annotation> <documentation>Kat_AK_ResidualeArteninsuffizienz</documentation> </annotation> <restriction base="xs:string"> <enumeration value="0353001"> <annotation> <documentation>keine</documentation> </annotation> </enumeration> <enumeration value="0353002"> <annotation> <documentation>leichtgradig</documentation> </annotation> </enumeration> <enumeration value="0353003"> <annotation> <documentation>mittelgradig</documentation> </annotation> </enumeration> <enumeration value="0353004"> <annotation> <documentation>hochgradig</documentation> </annotation> </enumeration> <enumeration value="0353099"> <annotation> <documentation>nicht bestimmbar</documentation> </annotation> </enumeration> </restriction> </simpleType> </pre>		

	<pre> </restriction> </simpleType> </pre>
--	---

simpleType enum_0354

namespace	http://xml.ir-d.de/sak		
type	restriction of string		
properties	base xs:string		
facets	Kind	Value	Annotation
	enumeration	0354001	documentation chirurgisch-offen
	enumeration	0354002	documentation Verschluss-System
	enumeration	0354042	documentation sonstige
annotation	documentation Kat_AK_Zugangswegverschluss		
source	<pre> <simpleType name="enum_0354"> <annotation> <documentation>Kat_AK_Zugangswegverschluss</documentation> </annotation> <restriction base="xs:string"> <enumeration value="0354001"> <annotation> <documentation>chirurgisch-offen</documentation> </annotation> </enumeration> <enumeration value="0354002"> <annotation> <documentation>Verschluss-System</documentation> </annotation> </enumeration> <enumeration value="0354042"> <annotation> <documentation>sonstige</documentation> </annotation> </enumeration> </restriction> </simpleType> </pre>		

simpleType enum_0357

namespace	http://xml.ir-d.de/sak		
type	restriction of string		
properties	base xs:string		
facets	Kind	Value	Annotation
	enumeration	0357001	documentation keine KHK
	enumeration	0357002	documentation 1-Gefäßerkrankung
	enumeration	0357003	documentation 2-Gefäßerkrankung
	enumeration	0357004	documentation 3-Gefäßerkrankung
	enumeration	0357005	documentation

	keine koronare Bildgebung
annotation	documentation Kat_AK_BefundBildgebung
source	<pre> <simpleType name="enum_0357"> <annotation> <documentation>Kat_AK_BefundBildgebung</documentation> </annotation> <restriction base="xs:string"> <enumeration value="0357001"> <annotation> <documentation>keine KHK</documentation> </annotation> </enumeration> <enumeration value="0357002"> <annotation> <documentation>1-Gefäßerkrankung</documentation> </annotation> </enumeration> <enumeration value="0357003"> <annotation> <documentation>2-Gefäßerkrankung</documentation> </annotation> </enumeration> <enumeration value="0357004"> <annotation> <documentation>3-Gefäßerkrankung</documentation> </annotation> </enumeration> <enumeration value="0357005"> <annotation> <documentation>keine koronare Bildgebung</documentation> </annotation> </enumeration> </restriction> </simpleType> </pre>

simpleType enum_0358

namespace	http://xml.ir-d.de/sak		
type	restriction of string		
properties	base xs:string		
facets	Kind	Value	Annotation
	enumeration	0358001	documentation 0
	enumeration	0358002	documentation 1
	enumeration	0358003	documentation 2
	enumeration	0358004	documentation 3
	enumeration	0358005	documentation 4
	enumeration	0358006	documentation 5 oder mehr
	enumeration	0358098	documentation genaue Anzahl unbekannt (aber mind. 1)
	enumeration	0358099	documentation unbekannt

annotation	documentation Kat_AK_AnzahlVorOP
source	<pre> <simpleType name="enum_0358"> <annotation> <documentation>Kat_AK_AnzahlVorOP</documentation> </annotation> <restriction base="xs:string"> <enumeration value="0358001"> <annotation> <documentation>0</documentation> </annotation> </enumeration> <enumeration value="0358002"> <annotation> <documentation>1</documentation> </annotation> </enumeration> <enumeration value="0358003"> <annotation> <documentation>2</documentation> </annotation> </enumeration> <enumeration value="0358004"> <annotation> <documentation>3</documentation> </annotation> </enumeration> <enumeration value="0358005"> <annotation> <documentation>4</documentation> </annotation> </enumeration> <enumeration value="0358006"> <annotation> <documentation>5 oder mehr</documentation> </annotation> </enumeration> <enumeration value="0358098"> <annotation> <documentation>genaue Anzahl unbekannt (aber mind. 1)</documentation> </annotation> </enumeration> <enumeration value="0358099"> <annotation> <documentation>unbekannt</documentation> </annotation> </enumeration> </restriction> </simpleType> </pre>

simpleType enum_0359

namespace	http://xml.ir-d.de/sak
type	restriction of string
properties	base xs:string
facets	Kind Value Annotation

	enumeration 0359001 documentation nein enumeration 0359002 documentation ja - einseitig enumeration 0359003 documentation ja - beidseitig enumeration 0359042 documentation unbekannt
annotation	documentation Kat_AK_LVOT
source	<pre> <simpleType name="enum_0359"> <annotation> <documentation>Kat_AK_LVOT</documentation> </annotation> <restriction base="xs:string"> <enumeration value="0359001"> <annotation> <documentation>nein</documentation> </annotation> </enumeration> <enumeration value="0359002"> <annotation> <documentation>ja - einseitig</documentation> </annotation> </enumeration> <enumeration value="0359003"> <annotation> <documentation>ja - beidseitig</documentation> </annotation> </enumeration> <enumeration value="0359042"> <annotation> <documentation>unbekannt</documentation> </annotation> </enumeration> </restriction> </simpleType> </pre>

simpleType enum_0360

namespace	http://xml.ir-d.de/sak		
type	restriction of string		
properties	base xs:string		
facets	Kind	Value	Annotation
	enumeration	0360001	documentation keine
	enumeration	0360002	documentation leichtgradig
	enumeration	0360003	documentation mittelgradig
	enumeration	0360004	documentation hochgradig
	enumeration	0360005	documentation massive
	enumeration	0360006	documentation torrential
	enumeration	0360099	documentation unbekannt

annotation	documentation Kat_AK_TriskupidalInsuffizienz
source	<pre> <simpleType name="enum_0360"> <annotation> <documentation>Kat_AK_TriskupidalInsuffizienz</documentation> </annotation> <restriction base="xs:string"> <enumeration value="0360001"> <annotation> <documentation>keine</documentation> </annotation> </enumeration> <enumeration value="0360002"> <annotation> <documentation>leichtgradig</documentation> </annotation> </enumeration> <enumeration value="0360003"> <annotation> <documentation>mittelgradig</documentation> </annotation> </enumeration> <enumeration value="0360004"> <annotation> <documentation>hochgradig</documentation> </annotation> </enumeration> <enumeration value="0360005"> <annotation> <documentation>massive</documentation> </annotation> </enumeration> <enumeration value="0360006"> <annotation> <documentation>torrential</documentation> </annotation> </enumeration> <enumeration value="0360099"> <annotation> <documentation>unbekannt</documentation> </annotation> </enumeration> </restriction> </simpleType> </pre>

simpleType enum 0361

namespace	http://xml.ir-d.de/sak		
type	restriction of string		
properties	base xs:string		
facets	Kind	Value	Annotation
	enumeration	0361001	documentation nein
	enumeration	0361002	documentation ja, letzte(r) innerhalb der letzten 48 Stunden
	enumeration	0361003	documentation ja, letzte(r) innerhalb der letzten 21 Tage

	enumeration 0361004 documentation ja, letzte(r) länger als 21 Tage enumeration 0361098 documentation ja, letzter Zeitpunkt unbekannt enumeration 0361099 documentation unbekannt
annotation	documentation Kat_AK_SchockReanimation
source	<pre> <simpleType name="enum_0361"> <annotation> <documentation>Kat_AK_SchockReanimation</documentation> </annotation> <restriction base="xs:string"> <enumeration value="0361001"> <annotation> <documentation>nein</documentation> </annotation> </enumeration> <enumeration value="0361002"> <annotation> <documentation>ja, letzte(r) innerhalb der letzten 48 Stunden</documentation> </annotation> </enumeration> <enumeration value="0361003"> <annotation> <documentation>ja, letzte(r) innerhalb der letzten 21 Tage</documentation> </annotation> </enumeration> <enumeration value="0361004"> <annotation> <documentation>ja, letzte(r) länger als 21 Tage</documentation> </annotation> </enumeration> <enumeration value="0361098"> <annotation> <documentation>ja, letzter Zeitpunkt unbekannt</documentation> </annotation> </enumeration> <enumeration value="0361099"> <annotation> <documentation>unbekannt</documentation> </annotation> </enumeration> </restriction> </simpleType> </pre>

simpleType enum_0362

namespace	http://xml.ir-d.de/sak		
type	restriction of string		
properties	base xs:string		
facets	Kind	Value	Annotation
	enumeration	0362001	documentation Sinusrhythmus
	enumeration	0362002	documentation

	enumeration 0362042 Vorhofflimmern documentation anderer Herzrhythmus
annotation	documentation Kat_AK_Herzrhythmus
source	<pre> <simpleType name="enum_0362"> <annotation> <documentation>Kat_AK_Herzrhythmus</documentation> </annotation> <restriction base="xs:string"> <enumeration value="0362001"> <annotation> <documentation>Sinusrhythmus</documentation> </annotation> </enumeration> <enumeration value="0362002"> <annotation> <documentation>Vorhofflimmern</documentation> </annotation> </enumeration> <enumeration value="0362042"> <annotation> <documentation>anderer Herzrhythmus</documentation> </annotation> </enumeration> </restriction> </simpleType> </pre>

simpleType enum_0363

namespace	http://xml.ir-d.de/sak		
type	restriction of string		
properties	base xs:string		
facets	Kind	Value	Annotation
	enumeration	0363001	documentation nein
	enumeration	0363002	documentation paroxysmal
	enumeration	0363003	documentation persistierend
	enumeration	0363004	documentation permanent
annotation	documentation Kat_AK_Vorhofflimmern		
source	<pre> <simpleType name="enum_0363"> <annotation> <documentation>Kat_AK_Vorhofflimmern</documentation> </annotation> <restriction base="xs:string"> <enumeration value="0363001"> <annotation> <documentation>nein</documentation> </annotation> </enumeration> <enumeration value="0363002"> <annotation> <documentation>paroxysmal</documentation> </pre>		

	<pre> </annotation> </enumeration> <enumeration value="0363003"> <annotation> <documentation>persistierend</documentation> </annotation> </enumeration> <enumeration value="0363004"> <annotation> <documentation>permanent</documentation> </annotation> </enumeration> </restriction> </simpleType> </pre>
--	--

simpleType enum_0364

namespace	http://xml.lir-d.de/sak		
type	restriction of string		
properties	base xs:string		
facets	Kind	Value	Annotation
	enumeration	0364001	documentation nein
	enumeration	0364002	documentation Schrittmacher ohne CRT-System
	enumeration	0364003	documentation Schrittmacher mit CRT-System
	enumeration	0364004	documentation Defibrillator ohne CRT-System
	enumeration	0364005	documentation Defibrillator mit CRT-System
annotation	documentation Kat_AK_SchrittmacherDefi		
source	<pre> <simpleType name="enum_0364"> <annotation> <documentation>Kat_AK_SchrittmacherDefi</documentation> </annotation> <restriction base="xs:string"> <enumeration value="0364001"> <annotation> <documentation>nein</documentation> </annotation> </enumeration> <enumeration value="0364002"> <annotation> <documentation>Schrittmacher ohne CRT-System</documentation> </annotation> </enumeration> <enumeration value="0364003"> <annotation> <documentation>Schrittmacher mit CRT-System</documentation> </annotation> </enumeration> <enumeration value="0364004"> <annotation> <documentation>Defibrillator ohne CRT-System</documentation> </annotation> </enumeration> </restriction> </simpleType> </pre>		

	<pre> </enumeration> <enumeration value="0364005"> <annotation> <documentation>Defibrillator mit CRT-System</documentation> </annotation> </enumeration> </restriction> </simpleType> </pre>
--	--

simpleType enum_0365

namespace	http://xml.ir-d.de/sak		
type	restriction of string		
properties	base xs:string		
facets	Kind	Value	Annotation
	enumeration	0365001	documentation nein
	enumeration	0365002	documentation ja, operativ
	enumeration	0365003	documentation ja, interventionell
annotation	documentation Kat_AK_MyokardRevaskularisation		
source	<pre> <simpleType name="enum_0365"> <annotation> <documentation>Kat_AK_MyokardRevaskularisation</documentation> </annotation> <restriction base="xs:string"> <enumeration value="0365001"> <annotation> <documentation>nein</documentation> </annotation> </enumeration> <enumeration value="0365002"> <annotation> <documentation>ja, operativ</documentation> </annotation> </enumeration> <enumeration value="0365003"> <annotation> <documentation>ja, interventionell</documentation> </annotation> </enumeration> </restriction> </simpleType> </pre>		

simpleType enum_0366

namespace	http://xml.ir-d.de/sak		
type	restriction of string		
properties	base xs:string		
facets	Kind	Value	Annotation
	enumeration	0366001	documentation nein

	enumeration 0366002 documentation ja, <= 6 Stunden enumeration 0366003 documentation ja, > 6 Stunden bis <= 3 Monate enumeration 0366004 documentation ja, > 3 Monate enumeration 0366099 documentation unbekannt
annotation	documentation Kat_AK_PCI
source	<pre> <simpleType name="enum_0366"> <annotation> <documentation>Kat_AK_PCI</documentation> </annotation> <restriction base="xs:string"> <enumeration value="0366001"> <annotation> <documentation>nein</documentation> </annotation> </enumeration> <enumeration value="0366002"> <annotation> <documentation>ja, &lt;= 6 Stunden</documentation> </annotation> </enumeration> <enumeration value="0366003"> <annotation> <documentation>ja, &gt; 6 Stunden bis &lt;= 3 Monate</documentation> </annotation> </enumeration> <enumeration value="0366004"> <annotation> <documentation>ja, &gt; 3 Monate</documentation> </annotation> </enumeration> <enumeration value="0366099"> <annotation> <documentation>unbekannt</documentation> </annotation> </enumeration> </restriction> </simpleType> </pre>

simpleType enum_0367

namespace	http://xml.ir-d.de/sak		
type	restriction of string		
properties	base xs:string		
facets	Kind	Value	Annotation
	enumeration	0367001	documentation keine
	enumeration	0367002	documentation Mediastinitis
	enumeration	0367003	documentation Sepsis
	enumeration	0367004	documentation broncho-pulmonale Infektion
	enumeration	0367005	documentation

	<p>enumeration 0367006 oto-laryngologische Infektion documentation floride Endokarditis</p> <p>enumeration 0367007 documentation Peritonitis</p> <p>enumeration 0367008 documentation Wundinfektion Thorax</p> <p>enumeration 0367009 documentation Pleuraempyem</p> <p>enumeration 0367010 documentation Venenkatheterinfektion</p> <p>enumeration 0367011 documentation Harnwegsinfektion</p> <p>enumeration 0367012 documentation Wundinfektion untere Extremitäten</p> <p>enumeration 0367013 documentation HIV-Infektion</p> <p>enumeration 0367014 documentation Hepatitis B oder C</p> <p>enumeration 0367015 documentation andere Wundinfektion</p> <p>enumeration 0367042 documentation sonstige Infektion</p>
annotation	documentation Kat_AK_Infektion
source	<pre> <simpleType name="enum_0367"> <annotation> <documentation>Kat_AK_Infektion</documentation> </annotation> <restriction base="xs:string"> <enumeration value="0367001"> <annotation> <documentation>keine</documentation> </annotation> </enumeration> <enumeration value="0367002"> <annotation> <documentation>Mediastinitis</documentation> </annotation> </enumeration> <enumeration value="0367003"> <annotation> <documentation>Sepsis</documentation> </annotation> </enumeration> <enumeration value="0367004"> <annotation> <documentation>broncho-pulmonale Infektion</documentation> </annotation> </enumeration> <enumeration value="0367005"> <annotation> <documentation>oto-laryngologische Infektion</documentation> </annotation> </enumeration> <enumeration value="0367006"> <annotation> <documentation>floride Endokarditis</documentation> </annotation> </enumeration> <enumeration value="0367007"> </pre>

```

    <annotation>
      <documentation>Peritonitis</documentation>
    </annotation>
  </enumeration>
  <enumeration value="0367008">
    <annotation>
      <documentation>Wundinfektion Thorax</documentation>
    </annotation>
  </enumeration>
  <enumeration value="0367009">
    <annotation>
      <documentation>Pleuraempyem</documentation>
    </annotation>
  </enumeration>
  <enumeration value="0367010">
    <annotation>
      <documentation>Venenkatheterinfektion</documentation>
    </annotation>
  </enumeration>
  <enumeration value="0367011">
    <annotation>
      <documentation>Harnwegsinfektion</documentation>
    </annotation>
  </enumeration>
  <enumeration value="0367012">
    <annotation>
      <documentation>Wundinfektion untere Extremitäten</documentation>
    </annotation>
  </enumeration>
  <enumeration value="0367013">
    <annotation>
      <documentation>HIV-Infektion</documentation>
    </annotation>
  </enumeration>
  <enumeration value="0367014">
    <annotation>
      <documentation>Hepatitis B oder C</documentation>
    </annotation>
  </enumeration>
  <enumeration value="0367015">
    <annotation>
      <documentation>andere Wundinfektion</documentation>
    </annotation>
  </enumeration>
  <enumeration value="0367042">
    <annotation>
      <documentation>sonstige Infektion</documentation>
    </annotation>
  </enumeration>
</restriction>
</simpleType>

```

simpleType enum_0368

namespace	http://xml.ir-d.de/sak
type	restriction of string

properties	base xs:string																		
facets	<table border="1"> <thead> <tr> <th>Kind</th> <th>Value</th> <th>Annotation</th> </tr> </thead> <tbody> <tr> <td>enumeration</td> <td>0368001</td> <td>documentation nein</td> </tr> <tr> <td>enumeration</td> <td>0368002</td> <td>documentation ja, COPD mit Dauermedikation</td> </tr> <tr> <td>enumeration</td> <td>0368003</td> <td>documentation ja, COPD ohne Dauermedikation</td> </tr> <tr> <td>enumeration</td> <td>0368004</td> <td>documentation ja, andere Lungenerkrankungen</td> </tr> <tr> <td>enumeration</td> <td>0368099</td> <td>documentation unbekannt</td> </tr> </tbody> </table>	Kind	Value	Annotation	enumeration	0368001	documentation nein	enumeration	0368002	documentation ja, COPD mit Dauermedikation	enumeration	0368003	documentation ja, COPD ohne Dauermedikation	enumeration	0368004	documentation ja, andere Lungenerkrankungen	enumeration	0368099	documentation unbekannt
Kind	Value	Annotation																	
enumeration	0368001	documentation nein																	
enumeration	0368002	documentation ja, COPD mit Dauermedikation																	
enumeration	0368003	documentation ja, COPD ohne Dauermedikation																	
enumeration	0368004	documentation ja, andere Lungenerkrankungen																	
enumeration	0368099	documentation unbekannt																	
annotation	documentation Kat_AK_Lungenerkrankung																		
source	<pre> <simpleType name="enum_0368"> <annotation> <documentation>Kat_AK_Lungenerkrankung</documentation> </annotation> <restriction base="xs:string"> <enumeration value="0368001"> <annotation> <documentation>nein</documentation> </annotation> </enumeration> <enumeration value="0368002"> <annotation> <documentation>ja, COPD mit Dauermedikation</documentation> </annotation> </enumeration> <enumeration value="0368003"> <annotation> <documentation>ja, COPD ohne Dauermedikation</documentation> </annotation> </enumeration> <enumeration value="0368004"> <annotation> <documentation>ja, andere Lungenerkrankungen</documentation> </annotation> </enumeration> <enumeration value="0368099"> <annotation> <documentation>unbekannt</documentation> </annotation> </enumeration> </restriction> </simpleType> </pre>																		

simpleType enum_0369

namespace	http://xml.ir-d.de/sak									
type	restriction of string									
properties	base xs:string									
facets	<table border="1"> <thead> <tr> <th>Kind</th> <th>Value</th> <th>Annotation</th> </tr> </thead> <tbody> <tr> <td>enumeration</td> <td>0369001</td> <td>documentation nein</td> </tr> <tr> <td>enumeration</td> <td>0369002</td> <td>documentation akut</td> </tr> </tbody> </table>	Kind	Value	Annotation	enumeration	0369001	documentation nein	enumeration	0369002	documentation akut
Kind	Value	Annotation								
enumeration	0369001	documentation nein								
enumeration	0369002	documentation akut								

	enumeration 0369003 documentation chronisch
annotation	documentation Kat_AK_Nierenersatztherapie
source	<pre> <simpleType name="enum_0369"> <annotation> <documentation>Kat_AK_Nierenersatztherapie</documentation> </annotation> <restriction base="xs:string"> <enumeration value="0369001"> <annotation> <documentation>nein</documentation> </annotation> </enumeration> <enumeration value="0369002"> <annotation> <documentation>akut</documentation> </annotation> </enumeration> <enumeration value="0369003"> <annotation> <documentation>chronisch</documentation> </annotation> </enumeration> </restriction> </simpleType> </pre>

simpleType enum_0370

namespace	http://xml.ir-d.de/sak		
type	restriction of string		
properties	base xs:string		
facets	Kind	Value	Annotation
	enumeration	0370001	documentation Echokardiographie
	enumeration	0370002	documentation Herzkatheter
	enumeration	0370042	documentation andere
annotation	documentation Kat_AK_AKOEFMessmethode		
source	<pre> <simpleType name="enum_0370"> <annotation> <documentation>Kat_AK_AKOEFMessmethode</documentation> </annotation> <restriction base="xs:string"> <enumeration value="0370001"> <annotation> <documentation>Echokardiographie</documentation> </annotation> </enumeration> <enumeration value="0370002"> <annotation> <documentation>Herzkatheter</documentation> </annotation> </enumeration> <enumeration value="0370042"> </pre>		

	<pre> <annotation> <documentation>andere</documentation> </annotation> </enumeration> </restriction> </simpleType> </pre>
--	---

simpleType enum_0371

namespace	http://xml.ir-d.de/sak		
type	restriction of string		
properties	base xs:string		
facets	Kind	Value	Annotation
	enumeration	0371001	documentation keine
	enumeration	0371002	documentation leicht
	enumeration	0371003	documentation mittel
	enumeration	0371004	documentation schwer
	enumeration	0371099	documentation unbekannt
annotation	documentation Kat_AK_Verkalkungsgrad		
source	<pre> <simpleType name="enum_0371"> <annotation> <documentation>Kat_AK_Verkalkungsgrad</documentation> </annotation> <restriction base="xs:string"> <enumeration value="0371001"> <annotation> <documentation>keine</documentation> </annotation> </enumeration> <enumeration value="0371002"> <annotation> <documentation>leicht</documentation> </annotation> </enumeration> <enumeration value="0371003"> <annotation> <documentation>mittel</documentation> </annotation> </enumeration> <enumeration value="0371004"> <annotation> <documentation>schwer</documentation> </annotation> </enumeration> <enumeration value="0371099"> <annotation> <documentation>unbekannt</documentation> </annotation> </enumeration> </restriction> </simpleType> </pre>		

simpleType enum 0372

namespace	http://xml.ir-d.de/sak		
type	restriction of string		
properties	base xs:string		
facets	Kind	Value	Annotation
	enumeration	0372001	documentation nein
	enumeration	0372002	documentation ja, bicuspide
	enumeration	0372003	documentation ja, unicuspide
	enumeration	0372099	documentation unbekannt
annotation	documentation Kat AK BiUnicuspideKlappe		
source	<pre> <simpleType name="enum_0372"> <annotation> <documentation>Kat_AK_BiUnicuspideKlappe</documentation> </annotation> <restriction base="xs:string"> <enumeration value="0372001"> <annotation> <documentation>nein</documentation> </annotation> </enumeration> <enumeration value="0372002"> <annotation> <documentation>ja, bicuspide</documentation> </annotation> </enumeration> <enumeration value="0372003"> <annotation> <documentation>ja, unicuspide</documentation> </annotation> </enumeration> <enumeration value="0372099"> <annotation> <documentation>unbekannt</documentation> </annotation> </enumeration> </restriction> </simpleType> </pre>		

simpleType enum 0373

namespace	http://xml.ir-d.de/sak		
type	restriction of string		
properties	base xs:string		
facets	Kind	Value	Annotation
	enumeration	0373001	documentation keine
	enumeration	0373002	documentation leichtgradig

	enumeration 0373003 documentation mittelgradig enumeration 0373004 documentation hochgradig enumeration 0373099 documentation unbekannt
annotation	documentation Kat_AK_Grad
source	<pre> <simpleType name="enum_0373"> <annotation> <documentation>Kat_AK_Grad</documentation> </annotation> <restriction base="xs:string"> <enumeration value="0373001"> <annotation> <documentation>keine</documentation> </annotation> </enumeration> <enumeration value="0373002"> <annotation> <documentation>leichtgradig</documentation> </annotation> </enumeration> <enumeration value="0373003"> <annotation> <documentation>mittelgradig</documentation> </annotation> </enumeration> <enumeration value="0373004"> <annotation> <documentation>hochgradig</documentation> </annotation> </enumeration> <enumeration value="0373099"> <annotation> <documentation>unbekannt</documentation> </annotation> </enumeration> </restriction> </simpleType> </pre>

simpleType enum_0374

namespace	http://xml.lir-d.de/sak		
type	restriction of string		
properties	base xs:string		
facets	Kind	Value	Annotation
	enumeration	0374001	documentation nein
	enumeration	0374002	documentation ja, <= 6 Stunden
	enumeration	0374003	documentation ja, > 6 Stunden bis <= 24 Stunden
	enumeration	0374004	documentation ja, > 1 bis 7 Tage
	enumeration	0374005	documentation ja, > 7 bis 21 Tage
	enumeration	0374006	documentation

	ja, > 21 Tage
annotation	documentation Kat AK InfarktAnamnese
source	<pre> <simpleType name="enum_0374"> <annotation> <documentation>Kat_AK_InfarktAnamnese</documentation> </annotation> <restriction base="xs:string"> <enumeration value="0374001"> <annotation> <documentation>nein</documentation> </annotation> </enumeration> <enumeration value="0374002"> <annotation> <documentation>ja, <= 6 Stunden</documentation> </annotation> </enumeration> <enumeration value="0374003"> <annotation> <documentation>ja, > 6 Stunden bis <= 24 Stunden</documentation> </annotation> </enumeration> <enumeration value="0374004"> <annotation> <documentation>ja, > 1 bis 7 Tage</documentation> </annotation> </enumeration> <enumeration value="0374005"> <annotation> <documentation>ja, > 7 bis 21 Tage</documentation> </annotation> </enumeration> <enumeration value="0374006"> <annotation> <documentation>ja, > 21 Tage</documentation> </annotation> </enumeration> </restriction> </simpleType> </pre>

simpleType enum_0375

namespace	http://xml.ir-d.de/sak		
type	restriction of string		
properties	base xs:string		
facets	Kind	Value	Annotation
	enumeration	0375001	documentation keine Symptome oder Angina
	enumeration	0375002	documentation Symptome, aber keine Ischämiezeichen
	enumeration	0375003	documentation stabile Angina
	enumeration	0375004	documentation instabile Angina
	enumeration	0375005	documentation Infarkt ohne ST-Hebung (Non-STEMI)

	enumeration 0375006 documentation Infarkt mit ST-Hebung (STEMI)
	enumeration 0375042 documentation unbekannt
annotation	documentation Kat_AK_KardialeSymptome
source	<pre> <simpleType name="enum_0375"> <annotation> <documentation>Kat_AK_KardialeSymptome</documentation> </annotation> <restriction base="xs:string"> <enumeration value="0375001"> <annotation> <documentation>keine Symptome oder Angina</documentation> </annotation> </enumeration> <enumeration value="0375002"> <annotation> <documentation>Symptome, aber keine Ischämiezeichen</documentation> </annotation> </enumeration> <enumeration value="0375003"> <annotation> <documentation>stabile Angina</documentation> </annotation> </enumeration> <enumeration value="0375004"> <annotation> <documentation>instabile Angina</documentation> </annotation> </enumeration> <enumeration value="0375005"> <annotation> <documentation>Infarkt ohne ST-Hebung (Non-STEMI)</documentation> </annotation> </enumeration> <enumeration value="0375006"> <annotation> <documentation>Infarkt mit ST-Hebung (STEMI)</documentation> </annotation> </enumeration> <enumeration value="0375042"> <annotation> <documentation>unbekannt</documentation> </annotation> </enumeration> </restriction> </simpleType> </pre>

simpleType enum_0376

namespace	http://xml.ir-d.de/sak		
type	restriction of string		
properties	base xs:string		
facets	Kind enumeration	Value 0376001	Annotation documentation nein

	enumeration 0376002 documentation ja, ZNS, zerebrovaskuläre Blutung enumeration 0376003 documentation ja, ZNS, zerebrovaskuläre Ischämie enumeration 0376042 documentation ja, ZNS, andere
annotation	documentation Kat_AK_Schlaganfall
source	<pre> <simpleType name="enum_0376"> <annotation> <documentation>Kat_AK_Schlaganfall</documentation> </annotation> <restriction base="xs:string"> <enumeration value="0376001"> <annotation> <documentation>nein</documentation> </annotation> </enumeration> <enumeration value="0376002"> <annotation> <documentation>ja, ZNS, zerebrovaskuläre Blutung</documentation> </annotation> </enumeration> <enumeration value="0376003"> <annotation> <documentation>ja, ZNS, zerebrovaskuläre Ischämie</documentation> </annotation> </enumeration> <enumeration value="0376042"> <annotation> <documentation>ja, ZNS, andere</documentation> </annotation> </enumeration> </restriction> </simpleType> </pre>

simpleType enum_0377

namespace	http://xml.ir-d.de/sak		
type	restriction of string		
properties	base xs:string		
facets	Kind	Value	Annotation
	enumeration	0377001	documentation ja, mild neurological dysfunction: NIHSS 0-5
	enumeration	0377002	documentation ja, moderate neurological dysfunction: NIHSS 6-14
	enumeration	0377003	documentation ja, severe neurological dysfunction: NIHSS >=15
annotation	documentation Kat_AK_Nihss		
source	<pre> <simpleType name="enum_0377"> <annotation> <documentation>Kat_AK_Nihss</documentation> </annotation> <restriction base="xs:string"> <enumeration value="0377001"> <annotation> </pre>		

	<pre> <documentation>ja, mild neurological dysfunction: NIHSS 0-5</documentation> </annotation> </enumeration> <enumeration value="0377002"> <annotation> <documentation>ja, moderate neurological dysfunction: NIHSS 6-14</documentation> </annotation> </enumeration> <enumeration value="0377003"> <annotation> <documentation> ja, severe neurological dysfunction: NIHSS &gt;=15</documentation> </annotation> </enumeration> </restriction> </simpleType> </pre>
--	--

simpleType **enum_0378**

namespace	http://xml.ir-d.de/sak		
type	restriction of string		
properties	base xs:string		
facets	Kind	Value	Annotation
	enumeration	0378001	documentation nein
	enumeration	0378002	documentation ja, < 48h gemäss VARC-3-Definition
	enumeration	0378003	documentation ja, >= 48h - <= 72h gemäß VARC-3-Definition
	enumeration	0378004	documentation ja, > 72 h gemäß VARC-3 Definition
annotation	documentation Kat_AK_Myokardinfarkt		
source	<pre> <simpleType name="enum_0378"> <annotation> <documentation>Kat_AK_Myokardinfarkt</documentation> </annotation> <restriction base="xs:string"> <enumeration value="0378001"> <annotation> <documentation>nein</documentation> </annotation> </enumeration> <enumeration value="0378002"> <annotation> <documentation>ja, &lt; 48h gemäss VARC-3-Definition</documentation> </annotation> </enumeration> <enumeration value="0378003"> <annotation> <documentation>ja, &gt;= 48h - &lt;= 72h gemäß VARC-3-Definition</documentation> </annotation> </enumeration> <enumeration value="0378004"> </pre>		

	<pre> <annotation> <documentation>ja, &gt; 72 h gemäß VARC-3 Definition</documentation> </annotation> </enumeration> </restriction> </simpleType> </pre>
--	--

simpleType enum_0379

namespace	http://xml.ir-d.de/sak		
type	restriction of string		
properties	base xs:string		
facets	Kind	Value	Annotation
	enumeration	0379001	documentation Keine gefäss- oder zugangsassozierte Komplikationen
	enumeration	0379002	documentation Versagen des perkutanen Verschlusssystems
	enumeration	0379003	documentation Geringfügige Gefäßkomplikationen
	enumeration	0379004	documentation Erhebliche Gefäßkomplikationen
annotation	documentation Kat_AK_ZugangKomplikationen		
source	<pre> <simpleType name="enum_0379"> <annotation> <documentation>Kat_AK_ZugangKomplikationen</documentation> </annotation> <restriction base="xs:string"> <enumeration value="0379001"> <annotation> <documentation>Keine gefäss- oder zugangsassozierte Komplikationen</documentation> </annotation> </enumeration> <enumeration value="0379002"> <annotation> <documentation>Versagen des perkutanen Verschlusssystems</documentation> </annotation> </enumeration> <enumeration value="0379003"> <annotation> <documentation>Geringfügige Gefäßkomplikationen</documentation> </annotation> </enumeration> <enumeration value="0379004"> <annotation> <documentation>Erhebliche Gefäßkomplikationen</documentation> </annotation> </enumeration> </restriction> </simpleType> </pre>		

simpleType enum_0380

namespace	http://xml.ir-d.de/sak		
type	restriction of string		
properties	base xs:string		
facets	Kind	Value	Annotation
	enumeration	0380001	documentation nein
	enumeration	0380002	documentation ja, intraprozedural
	enumeration	0380003	documentation ja, postprozedural
	enumeration	0380004	documentation ja, Zeitpunkt nicht bekannt
annotation	documentation Kat_AK_Reanimation		
source	<pre> <simpleType name="enum_0380"> <annotation> <documentation>Kat_AK_Reanimation</documentation> </annotation> <restriction base="xs:string"> <enumeration value="0380001"> <annotation> <documentation>nein</documentation> </annotation> </enumeration> <enumeration value="0380002"> <annotation> <documentation>ja, intraprozedural</documentation> </annotation> </enumeration> <enumeration value="0380003"> <annotation> <documentation>ja, postprozedural</documentation> </annotation> </enumeration> <enumeration value="0380004"> <annotation> <documentation>ja, Zeitpunkt nicht bekannt</documentation> </annotation> </enumeration> </restriction> </simpleType> </pre>		

simpleType enum_0381

namespace	http://xml.ir-d.de/sak		
type	restriction of string		
properties	base xs:string		
facets	Kind	Value	Annotation
	enumeration	0381001	documentation nein
	enumeration	0381002	documentation Thorakotomie/Rethorakotomie
	enumeration	0381003	documentation kathetergestützte Reintervention
	enumeration	0381004	documentation

	enumeration 0381005 lokale Reinterventionen documentation andere Reintervention
annotation	documentation Kat_AK_Massnahmen
source	<pre> <simpleType name="enum_0381"> <annotation> <documentation>Kat_AK_Massnahmen</documentation> </annotation> <restriction base="xs:string"> <enumeration value="0381001"> <annotation> <documentation>nein</documentation> </annotation> </enumeration> <enumeration value="0381002"> <annotation> <documentation>Thorakotomie/Rethorakotomie</documentation> </annotation> </enumeration> <enumeration value="0381003"> <annotation> <documentation>kathetergestützte Reintervention</documentation> </annotation> </enumeration> <enumeration value="0381004"> <annotation> <documentation>lokale Reinterventionen</documentation> </annotation> </enumeration> <enumeration value="0381005"> <annotation> <documentation>andere Reintervention</documentation> </annotation> </enumeration> </restriction> </simpleType> </pre>

simpleType enum_0382

namespace	http://xml.ir-d.de/sak		
type	restriction of string		
properties	base xs:string		
facets	Kind	Value	Annotation
	enumeration	0382001	documentation keine Rethorakotomie / kein weiterer Grund
	enumeration	0382002	documentation Blutung/Hämatom
	enumeration	0382003	documentation Low Cardiac Output
	enumeration	0382004	documentation Tamponade
	enumeration	0382005	documentation Graftprobleme, Ischämie
	enumeration	0382006	documentation Wundinfektion, Mediastinitis
	enumeration	0382007	documentation Dissektion

	<p>enumeration 0382008 documentation Prothesendysfunktion</p> <p>enumeration 0382009 documentation instabiles Sternum</p> <p>enumeration 0382010 documentation Chylothorax</p> <p>enumeration 0382011 documentation lokale Revision im Bereich des Zugangsweges</p> <p>enumeration 0382042 documentation anderer Grund</p>
annotation	documentation Kat_AK_Komplikation
source	<pre> <simpleType name="enum_0382"> <annotation> <documentation>Kat_AK_Komplikation</documentation> </annotation> <restriction base="xs:string"> <enumeration value="0382001"> <annotation> <documentation>keine Rethorakotomie / kein weiterer Grund</documentation> </annotation> </enumeration> <enumeration value="0382002"> <annotation> <documentation>Blutung/Hämatom</documentation> </annotation> </enumeration> <enumeration value="0382003"> <annotation> <documentation>Low Cardiac Output</documentation> </annotation> </enumeration> <enumeration value="0382004"> <annotation> <documentation>Tamponade</documentation> </annotation> </enumeration> <enumeration value="0382005"> <annotation> <documentation>Graftprobleme, Ischämie</documentation> </annotation> </enumeration> <enumeration value="0382006"> <annotation> <documentation>Wundinfektion, Mediastinitis</documentation> </annotation> </enumeration> <enumeration value="0382007"> <annotation> <documentation>Dissektion</documentation> </annotation> </enumeration> <enumeration value="0382008"> <annotation> <documentation>Prothesendysfunktion</documentation> </annotation> </enumeration> <enumeration value="0382009"> <annotation> </pre>

	<pre> <documentation>instabiles Sternum</documentation> </annotation> </enumeration> <enumeration value="0382010"> <annotation> <documentation>Chylothorax</documentation> </annotation> </enumeration> <enumeration value="0382011"> <annotation> <documentation>lokale Revision im Bereich des Zugangsweges</documentation> </annotation> </enumeration> <enumeration value="0382042"> <annotation> <documentation>anderer Grund</documentation> </annotation> </enumeration> </restriction> </simpleType> </pre>
--	---

simpleType enum 0383

namespace	http://xml.ir-d.de/sak		
type	restriction of string		
properties	base xs:string		
facets	Kind	Value	Annotation
	enumeration	0383001	documentation nein
	enumeration	0383002	documentation ja, mit forcierter Atemtherapie
	enumeration	0383003	documentation ja, Reintubation oder längerfristige Beatmung
	enumeration	0383004	documentation ja, Tracheotomie
annotation	documentation Kat_AK_RespiratorischeInsuffizienz		
source	<pre> <simpleType name="enum_0383"> <annotation> <documentation>Kat_AK_RespiratorischeInsuffizienz</documentation> </annotation> <restriction base="xs:string"> <enumeration value="0383001"> <annotation> <documentation>nein</documentation> </annotation> </enumeration> <enumeration value="0383002"> <annotation> <documentation>ja, mit forcierter Atemtherapie</documentation> </annotation> </enumeration> <enumeration value="0383003"> <annotation> <documentation>ja, Reintubation oder längerfristige Beatmung</documentation> </pre>		

	<pre> </annotation> </enumeration> <enumeration value="0383004"> <annotation> <documentation>ja, Tracheotomie</documentation> </annotation> </enumeration> </restriction> </simpleType> </pre>
--	--

simpleType enum_0384

namespace	http://xml.ir-d.de/sak		
type	restriction of string		
properties	base xs:string		
facets	Kind	Value	Annotation
	enumeration	0384001	documentation keine Blutungskomplikationen
	enumeration	0384002	documentation Geringfügige Blutung (Minor Bleeding - BARC type 2 or 3a)
	enumeration	0384003	documentation Starke Blutung (Major Bleeding - BARC type 3a)
	enumeration	0384004	documentation Lebensbedrohliche Blutung (Life-threatening or disabling bleeding - BARC type 3b or 3c or type 5)
annotation	documentation Kat_AK_Blutungskomplikation		
source	<pre> <simpleType name="enum_0384"> <annotation> <documentation>Kat_AK_Blutungskomplikation</documentation> </annotation> <restriction base="xs:string"> <enumeration value="0384001"> <annotation> <documentation>keine Blutungskomplikationen</documentation> </annotation> </enumeration> <enumeration value="0384002"> <annotation> <documentation>Geringfügige Blutung (Minor Bleeding - BARC type 2 or 3a)</documentation> </annotation> </enumeration> <enumeration value="0384003"> <annotation> <documentation>Starke Blutung (Major Bleeding - BARC type 3a)</documentation> </annotation> </enumeration> <enumeration value="0384004"> <annotation> <documentation>Lebensbedrohliche Blutung (Life-threatening or disabling bleeding - BARC type 3b or 3c or type 5)</documentation> </annotation> </enumeration> </restriction> </simpleType> </pre>		

simpleType enum 0385

namespace	http://xml.ir-d.de/sak		
type	restriction of string		
properties	base xs:string		
facets	Kind	Value	Annotation
	enumeration	0385001	documentation Sinusrhythmus
	enumeration	0385002	documentation Vorhofflimmern
	enumeration	0385003	documentation Patient verstorben (kein Herzrhythmus)
	enumeration	0385042	documentation anderer Rhythmus
annotation	documentation Kat AK HerzrhythmusEntlassung		
source	<pre> <simpleType name="enum_0385"> <annotation> <documentation>Kat_AK_HerzrhythmusEntlassung</documentation> </annotation> <restriction base="xs:string"> <enumeration value="0385001"> <annotation> <documentation>Sinusrhythmus</documentation> </annotation> </enumeration> <enumeration value="0385002"> <annotation> <documentation>Vorhofflimmern</documentation> </annotation> </enumeration> <enumeration value="0385003"> <annotation> <documentation>Patient verstorben (kein Herzrhythmus)</documentation> </annotation> </enumeration> <enumeration value="0385042"> <annotation> <documentation>anderer Rhythmus</documentation> </annotation> </enumeration> </restriction> </simpleType> </pre>		

simpleType enum 0388

namespace	http://xml.ir-d.de/sak		
type	restriction of string		
properties	base xs:string		
facets	Kind	Value	Annotation
	enumeration	0388001	documentation nein
	enumeration	0388002	documentation ASS

	enumeration 0388003 documentation ADP-Rezeptor-Antagonist enumeration 0388004 documentation Kombination ASS und ADP-Rezeptor-Antagonist enumeration 0388042 documentation ja, andere enumeration 0388099 documentation unbekannt
annotation	documentation Kat_AK_Plaettchenaggregationshemmer
source	<pre> <simpleType name="enum_0388"> <annotation> <documentation>Kat_AK_Plaettchenaggregationshemmer</documentation> </annotation> <restriction base="xs:string"> <enumeration value="0388001"> <annotation> <documentation>nein</documentation> </annotation> </enumeration> <enumeration value="0388002"> <annotation> <documentation>ASS</documentation> </annotation> </enumeration> <enumeration value="0388003"> <annotation> <documentation>ADP-Rezeptor-Antagonist</documentation> </annotation> </enumeration> <enumeration value="0388004"> <annotation> <documentation>Kombination ASS und ADP-Rezeptor-Antagonist</documentation> </annotation> </enumeration> <enumeration value="0388042"> <annotation> <documentation>ja, andere</documentation> </annotation> </enumeration> <enumeration value="0388099"> <annotation> <documentation>unbekannt</documentation> </annotation> </enumeration> </restriction> </simpleType> </pre>

simpleType enum_0389

namespace	http://xml.ir-d.de/sak		
type	restriction of string		
properties	base xs:string		
facets	Kind	Value	Annotation
	enumeration	0389001	documentation nein

	<p>enumeration 0389002 documentation Cumarin-Derivate</p> <p>enumeration 0389003 documentation Heparinoide</p> <p>enumeration 0389004 documentation orale Thrombinantagonisten</p> <p>enumeration 0389005 documentation Kombination Heparinoide und Cumarin-Derivate</p> <p>enumeration 0389006 documentation Direkte orale Antikoagulantien (DOAK / NOAK)</p> <p>enumeration 0389042 documentation ja, andere</p> <p>enumeration 0389099 documentation unbekannt</p>
annotation	documentation Kat_AK_Antikoagulantien
source	<pre> <simpleType name="enum_0389"> <annotation> <documentation>Kat_AK_Antikoagulantien</documentation> </annotation> <restriction base="xs:string"> <enumeration value="0389001"> <annotation> <documentation>nein</documentation> </annotation> </enumeration> <enumeration value="0389002"> <annotation> <documentation>Cumarin-Derivate</documentation> </annotation> </enumeration> <enumeration value="0389003"> <annotation> <documentation>Heparinoide</documentation> </annotation> </enumeration> <enumeration value="0389004"> <annotation> <documentation>orale Thrombinantagonisten</documentation> </annotation> </enumeration> <enumeration value="0389005"> <annotation> <documentation>Kombination Heparinoide und Cumarin-Derivate</documentation> </annotation> </enumeration> <enumeration value="0389006"> <annotation> <documentation>Direkte orale Antikoagulantien (DOAK / NOAK)</documentation> </annotation> </enumeration> <enumeration value="0389042"> <annotation> <documentation>ja, andere</documentation> </annotation> </enumeration> <enumeration value="0389099"> <annotation> </pre>

	<pre> <documentation>unbekannt</documentation> </annotation> </enumeration> </restriction> </simpleType> </pre>
--	---

simpleType enum_0390

namespace	http://xml.ir-d.de/sak		
type	restriction of string		
properties	base xs:string		
facets	Kind	Value	Annotation
	enumeration	0390001	documentation biologisches Klappenmodell
	enumeration	0390002	documentation mechanisches Klappenmodell
annotation	documentation Kat_AK_Artikeltyp		
source	<pre> <simpleType name="enum_0390"> <annotation> <documentation>Kat_AK_Artikeltyp</documentation> </annotation> <restriction base="xs:string"> <enumeration value="0390001"> <annotation> <documentation>biologisches Klappenmodell</documentation> </annotation> </enumeration> <enumeration value="0390002"> <annotation> <documentation>mechanisches Klappenmodell</documentation> </annotation> </enumeration> </restriction> </simpleType> </pre>		

simpleType enum_0398

namespace	http://xml.ir-d.de/sak		
type	restriction of string		
properties	base xs:string		
facets	Kind	Value	Annotation
	enumeration	0398001	documentation kardiovaskuläre Ursache
	enumeration	0398002	documentation nicht-kardiovaskuläre Ursache
	enumeration	0398099	documentation Todesursache unbekannt
annotation	documentation Kat_AK_Todesursache		
source	<pre> <simpleType name="enum_0398"> <annotation> <documentation>Kat_AK_Todesursache</documentation> </annotation> </pre>		

	<pre> <restriction base="xs:string"> <enumeration value="0398001"> <annotation> <documentation>kardiovaskuläre Ursache</documentation> </annotation> </enumeration> <enumeration value="0398002"> <annotation> <documentation>nicht-kardiovaskuläre Ursache</documentation> </annotation> </enumeration> <enumeration value="0398099"> <annotation> <documentation>Todesursache unbekannt</documentation> </annotation> </enumeration> </restriction> </simpleType> </pre>
--	--

simpleType enum_0399

namespace	http://xml.ir-d.de/sak		
type	restriction of string		
properties	base xs:string		
facets	Kind	Value	Annotation
	enumeration	0399001	documentation Patient lebt
	enumeration	0399002	documentation Patient im Krankenhaus verstorben
annotation	documentation Kat_AK_Vitalstatus		
source	<pre> <simpleType name="enum_0399"> <annotation> <documentation>Kat_AK_Vitalstatus</documentation> </annotation> <restriction base="xs:string"> <enumeration value="0399001"> <annotation> <documentation>Patient lebt</documentation> </annotation> </enumeration> <enumeration value="0399002"> <annotation> <documentation>Patient im Krankenhaus verstorben</documentation> </annotation> </enumeration> </restriction> </simpleType> </pre>		

simpleType enum_0044

namespace	http://xml.ir-d.de/irdsaa		
type	restriction of string		
properties	base xs:string		

facets	Kind	Value	Annotation
	enumeration	0044001	documentation 1= normaler, sonst gesunder Patient
	enumeration	0044002	documentation 2= Patient mit leichter Allgemeinerkrankung
	enumeration	0044003	documentation 3= Patient mit schwerer Allgemeinerkrankung
	enumeration	0044004	documentation 4= Patient mit schwerer Allgemeinerkrankung, die eine ständige Lebensbedrohung darstellt
enumeration	0044005	documentation 5= moribunder Patient, der ohne die Operation voraussichtlich nicht überleben wird	
annotation	documentation Kat_ASA		
source	<pre> <simpleType name="enum_0044"> <annotation> <documentation>Kat_ASA</documentation> </annotation> <restriction base="xs:string"> <enumeration value="0044001"> <annotation> <documentation>1= normaler, sonst gesunder Patient</documentation> </annotation> </enumeration> <enumeration value="0044002"> <annotation> <documentation>2= Patient mit leichter Allgemeinerkrankung</documentation> </annotation> </enumeration> <enumeration value="0044003"> <annotation> <documentation>3= Patient mit schwerer Allgemeinerkrankung</documentation> </annotation> </enumeration> <enumeration value="0044004"> <annotation> <documentation>4= Patient mit schwerer Allgemeinerkrankung, die eine ständige Lebensbedrohung darstellt</documentation> </annotation> </enumeration> <enumeration value="0044005"> <annotation> <documentation>5= moribunder Patient, der ohne die Operation voraussichtlich nicht überleben wird</documentation> </annotation> </enumeration> </restriction> </simpleType> </pre>		

simpleType enum_0050

namespace	http://xml.ir-d.de/irdsaa		
type	restriction of string		
properties	base xs:string		
facets	Kind	Value	Annotation

	enumeration 0050001 documentation rechts
	enumeration 0050002 documentation links
annotation	documentation Kat_RechtsLinks
source	<pre> <simpleType name="enum_0050"> <annotation> <documentation>Kat_RechtsLinks</documentation> </annotation> <restriction base="xs:string"> <enumeration value="0050001"> <annotation> <documentation>rechts</documentation> </annotation> </enumeration> <enumeration value="0050002"> <annotation> <documentation>links</documentation> </annotation> </enumeration> </restriction> </simpleType> </pre>

simpleType enum_0060

namespace	http://xml.ir-d.de/irdsaa									
type	restriction of string									
properties	base xs:string									
facets	<table border="1"> <thead> <tr> <th>Kind</th> <th>Value</th> <th>Annotation</th> </tr> </thead> <tbody> <tr> <td>enumeration</td> <td>0060001</td> <td>documentation ja</td> </tr> <tr> <td>enumeration</td> <td>0060002</td> <td>documentation nein</td> </tr> </tbody> </table>	Kind	Value	Annotation	enumeration	0060001	documentation ja	enumeration	0060002	documentation nein
Kind	Value	Annotation								
enumeration	0060001	documentation ja								
enumeration	0060002	documentation nein								
annotation	documentation Kat_JaNein									
source	<pre> <simpleType name="enum_0060"> <annotation> <documentation>Kat_JaNein</documentation> </annotation> <restriction base="xs:string"> <enumeration value="0060001"> <annotation> <documentation>ja</documentation> </annotation> </enumeration> <enumeration value="0060002"> <annotation> <documentation>nein</documentation> </annotation> </enumeration> </restriction> </simpleType> </pre>									

simpleType enum_0061

namespace	http://xml.ir-d.de/irdsaa		
type	restriction of string		
properties	base xs:string		
facets	Kind	Value	Annotation
	enumeration	0061001	documentation ja
	enumeration	0061002	documentation nein
	enumeration	0061099	documentation unbekannt
annotation	documentation Kat_JaNeinUnbekannt		
source	<pre> <simpleType name="enum_0061"> <annotation> <documentation>Kat_JaNeinUnbekannt</documentation> </annotation> <restriction base="xs:string"> <enumeration value="0061001"> <annotation> <documentation>ja</documentation> </annotation> </enumeration> <enumeration value="0061002"> <annotation> <documentation>nein</documentation> </annotation> </enumeration> <enumeration value="0061099"> <annotation> <documentation>unbekannt</documentation> </annotation> </enumeration> </restriction> </simpleType> </pre>		

simpleType enum_0062

namespace	http://xml.ir-d.de/irdsaa		
type	restriction of string		
properties	base xs:string		
facets	Kind	Value	Annotation
	enumeration	0062001	documentation Stück
	enumeration	0062002	documentation g
	enumeration	0062003	documentation mg
	enumeration	0062004	documentation l
	enumeration	0062005	documentation ml
	enumeration	0062006	documentation cm ³
	enumeration	0062007	documentation mm

	enumeration 0062008 documentation cm enumeration 0062009 documentation dm enumeration 0062010 documentation m enumeration 0062042 documentation andere
annotation	documentation Kat_Einheit
source	<pre> <simpleType name="enum_0062"> <annotation> <documentation>Kat_Einheit</documentation> </annotation> <restriction base="xs:string"> <enumeration value="0062001"> <annotation> <documentation>Stück</documentation> </annotation> </enumeration> <enumeration value="0062002"> <annotation> <documentation>g</documentation> </annotation> </enumeration> <enumeration value="0062003"> <annotation> <documentation>mg</documentation> </annotation> </enumeration> <enumeration value="0062004"> <annotation> <documentation>l</documentation> </annotation> </enumeration> <enumeration value="0062005"> <annotation> <documentation>ml</documentation> </annotation> </enumeration> <enumeration value="0062006"> <annotation> <documentation>cm³</documentation> </annotation> </enumeration> <enumeration value="0062007"> <annotation> <documentation>mm</documentation> </annotation> </enumeration> <enumeration value="0062008"> <annotation> <documentation>cm</documentation> </annotation> </enumeration> <enumeration value="0062009"> <annotation> <documentation>dm</documentation> </annotation> </enumeration> </restriction> </simpleType> </pre>

	<pre> <enumeration value="0062010"> <annotation> <documentation>m</documentation> </annotation> </enumeration> <enumeration value="0062042"> <annotation> <documentation>andere</documentation> </annotation> </enumeration> </restriction> </simpleType> </pre>
--	--

simpleType enum_0065

namespace	http://xml.ir-d.de/irdsaa		
type	restriction of string		
properties	base xs:string		
facets	Kind	Value	Annotation
	enumeration	0065001	documentation stationär
	enumeration	0065002	documentation teilstationär
	enumeration	0065003	documentation ambulant
annotation	documentation Kat_ArtAufenthalt		
source	<pre> <simpleType name="enum_0065"> <annotation> <documentation>Kat_ArtAufenthalt</documentation> </annotation> <restriction base="xs:string"> <enumeration value="0065001"> <annotation> <documentation>stationär</documentation> </annotation> </enumeration> <enumeration value="0065002"> <annotation> <documentation>teilstationär</documentation> </annotation> </enumeration> <enumeration value="0065003"> <annotation> <documentation>ambulant</documentation> </annotation> </enumeration> </restriction> </simpleType> </pre>		

simpleType enum_0067

namespace	http://xml.ir-d.de/irdsaa
type	restriction of string

properties	base xs:string									
facets	<table border="1"> <thead> <tr> <th>Kind</th> <th>Value</th> <th>Annotation</th> </tr> </thead> <tbody> <tr> <td>enumeration</td> <td>0067001</td> <td>documentation Implantat</td> </tr> <tr> <td>enumeration</td> <td>0067002</td> <td>documentation Explantat</td> </tr> </tbody> </table>	Kind	Value	Annotation	enumeration	0067001	documentation Implantat	enumeration	0067002	documentation Explantat
Kind	Value	Annotation								
enumeration	0067001	documentation Implantat								
enumeration	0067002	documentation Explantat								
annotation	documentation Kat_ArtArtikel									
source	<pre><simpleType name="enum_0067"> <annotation> <documentation>Kat_ArtArtikel</documentation> </annotation> <restriction base="xs:string"> <enumeration value="0067001"> <annotation> <documentation>Implantat</documentation> </annotation> </enumeration> <enumeration value="0067002"> <annotation> <documentation>Explantat</documentation> </annotation> </enumeration> </restriction> </simpleType></pre>									

simpleType enum_0068

namespace	http://xml.ir-d.de/irdsaa															
type	restriction of string															
properties	base xs:string															
facets	<table border="1"> <thead> <tr> <th>Kind</th> <th>Value</th> <th>Annotation</th> </tr> </thead> <tbody> <tr> <td>enumeration</td> <td>0068001</td> <td>documentation UDI</td> </tr> <tr> <td>enumeration</td> <td>0068002</td> <td>documentation Referenz (REF)</td> </tr> <tr> <td>enumeration</td> <td>0068003</td> <td>documentation Katalognummer</td> </tr> <tr> <td>enumeration</td> <td>0068042</td> <td>documentation sonstiger</td> </tr> </tbody> </table>	Kind	Value	Annotation	enumeration	0068001	documentation UDI	enumeration	0068002	documentation Referenz (REF)	enumeration	0068003	documentation Katalognummer	enumeration	0068042	documentation sonstiger
Kind	Value	Annotation														
enumeration	0068001	documentation UDI														
enumeration	0068002	documentation Referenz (REF)														
enumeration	0068003	documentation Katalognummer														
enumeration	0068042	documentation sonstiger														
annotation	documentation Kat_KennzeichenTyp															
source	<pre><simpleType name="enum_0068"> <annotation> <documentation>Kat_KennzeichenTyp</documentation> </annotation> <restriction base="xs:string"> <enumeration value="0068001"> <annotation> <documentation>UDI</documentation> </annotation> </enumeration> <enumeration value="0068002"> <annotation> <documentation>Referenz (REF)</documentation> </annotation> </enumeration> </restriction> </simpleType></pre>															

	<pre> <enumeration value="0068003"> <annotation> <documentation>Katalognummer</documentation> </annotation> </enumeration> <enumeration value="0068042"> <annotation> <documentation>sonstiger</documentation> </annotation> </enumeration> </restriction> </simpleType> </pre>
--	---

simpleType enum_0069

namespace	http://xml.ir-d.de/irdsaa		
type	restriction of string		
properties	base xs:string		
facets	Kind	Value	Annotation
	enumeration	0069001	documentation Implantat
	enumeration	0069002	documentation Explantat
annotation	documentation Kat_ArtZubehoer		
source	<pre> <simpleType name="enum_0069"> <annotation> <documentation>Kat_ArtZubehoer</documentation> </annotation> <restriction base="xs:string"> <enumeration value="0069001"> <annotation> <documentation>Implantat</documentation> </annotation> </enumeration> <enumeration value="0069002"> <annotation> <documentation>Explantat</documentation> </annotation> </enumeration> </restriction> </simpleType> </pre>		

simpleType enum_0070

namespace	http://xml.ir-d.de/irdsaa		
type	restriction of string		
properties	base xs:string		
facets	Kind	Value	Annotation
	enumeration	0070001	documentation weiblich
	enumeration	0070002	documentation männlich
	enumeration	0070003	documentation

	enumeration 0070042 divers documentation unbestimmt
annotation	documentation Kat_Geschlecht
source	<pre> <simpleType name="enum_0070"> <annotation> <documentation>Kat_Geschlecht</documentation> </annotation> <restriction base="xs:string"> <enumeration value="0070001"> <annotation> <documentation>weiblich</documentation> </annotation> </enumeration> <enumeration value="0070002"> <annotation> <documentation>männlich</documentation> </annotation> </enumeration> <enumeration value="0070003"> <annotation> <documentation>divers</documentation> </annotation> </enumeration> <enumeration value="0070042"> <annotation> <documentation>unbestimmt</documentation> </annotation> </enumeration> </restriction> </simpleType> </pre>

simpleType enum 0071

namespace	http://xml.ir-d.de/irdsaa		
type	restriction of string		
properties	base xs:string		
facets	Kind	Value	Annotation
	enumeration	0071001	documentation Implantat
	enumeration	0071002	documentation Explantat
	enumeration	0071003	documentation Degeneriertes/defektes Produkt, das funktionslos im Körper verbleibt
annotation	documentation Kat_ArtikelArtFunktion		
source	<pre> <simpleType name="enum_0071"> <annotation> <documentation>Kat_ArtikelArtFunktion</documentation> </annotation> <restriction base="xs:string"> <enumeration value="0071001"> <annotation> <documentation>Implantat</documentation> </annotation> </enumeration> </pre>		

	<pre> <enumeration value="0071002"> <annotation> <documentation>Explantat</documentation> </annotation> </enumeration> <enumeration value="0071003"> <annotation> <documentation>Degeneriertes/defektes Produkt, das funktionslos im Körper verbleibt</documentation> </annotation> </enumeration> </restriction> </simpleType> </pre>
--	--

simpleType enum_0075

namespace	http://xml.ir-d.de/irdsaa		
type	restriction of string		
properties	base xs:string		
facets	Kind	Value	Annotation
	enumeration	0075001	documentation elektiv
	enumeration	0075002	documentation dringlich
	enumeration	0075003	documentation Notfall
annotation	documentation Kat_Dringlichkeit		
source	<pre> <simpleType name="enum_0075"> <annotation> <documentation>Kat_Dringlichkeit</documentation> </annotation> <restriction base="xs:string"> <enumeration value="0075001"> <annotation> <documentation>elektiv</documentation> </annotation> </enumeration> <enumeration value="0075002"> <annotation> <documentation>dringlich</documentation> </annotation> </enumeration> <enumeration value="0075003"> <annotation> <documentation>Notfall</documentation> </annotation> </enumeration> </restriction> </simpleType> </pre>		

simpleType enum_0076

namespace	http://xml.ir-d.de/irdsaa
type	restriction of string

properties	base xs:string															
facets	<table border="1"> <thead> <tr> <th>Kind</th> <th>Value</th> <th>Annotation</th> </tr> </thead> <tbody> <tr> <td>enumeration</td> <td>0076001</td> <td>documentation elektiv</td> </tr> <tr> <td>enumeration</td> <td>0076002</td> <td>documentation dringlich</td> </tr> <tr> <td>enumeration</td> <td>0076003</td> <td>documentation Notfall</td> </tr> <tr> <td>enumeration</td> <td>0076004</td> <td>documentation Notfall (Reanimation / ultima ratio)</td> </tr> </tbody> </table>	Kind	Value	Annotation	enumeration	0076001	documentation elektiv	enumeration	0076002	documentation dringlich	enumeration	0076003	documentation Notfall	enumeration	0076004	documentation Notfall (Reanimation / ultima ratio)
Kind	Value	Annotation														
enumeration	0076001	documentation elektiv														
enumeration	0076002	documentation dringlich														
enumeration	0076003	documentation Notfall														
enumeration	0076004	documentation Notfall (Reanimation / ultima ratio)														
annotation	documentation Kat_Dringlichkeit_Reanimation															
source	<pre><simpleType name="enum_0076"> <annotation> <documentation>Kat_Dringlichkeit_Reanimation</documentation> </annotation> <restriction base="xs:string"> <enumeration value="0076001"> <annotation> <documentation>elektiv</documentation> </annotation> </enumeration> <enumeration value="0076002"> <annotation> <documentation>dringlich</documentation> </annotation> </enumeration> <enumeration value="0076003"> <annotation> <documentation>Notfall</documentation> </annotation> </enumeration> <enumeration value="0076004"> <annotation> <documentation>Notfall (Reanimation / ultima ratio)</documentation> </annotation> </enumeration> </restriction> </simpleType></pre>															

simpleType enum_0080

namespace	http://xml.ir-d.de/irdsaa												
type	restriction of string												
properties	base xs:string												
facets	<table border="1"> <thead> <tr> <th>Kind</th> <th>Value</th> <th>Annotation</th> </tr> </thead> <tbody> <tr> <td>enumeration</td> <td>0080001</td> <td>documentation Endoprothese Hüfte/Knie</td> </tr> <tr> <td>enumeration</td> <td>0080002</td> <td>documentation Brustimplantat</td> </tr> <tr> <td>enumeration</td> <td>0080003</td> <td>documentation Aortenklappenprothese</td> </tr> </tbody> </table>	Kind	Value	Annotation	enumeration	0080001	documentation Endoprothese Hüfte/Knie	enumeration	0080002	documentation Brustimplantat	enumeration	0080003	documentation Aortenklappenprothese
Kind	Value	Annotation											
enumeration	0080001	documentation Endoprothese Hüfte/Knie											
enumeration	0080002	documentation Brustimplantat											
enumeration	0080003	documentation Aortenklappenprothese											
annotation	documentation Kat_Implantattyp												
source	<pre><simpleType name="enum_0080"> <annotation> <documentation>Kat_Implantattyp</documentation> </annotation></pre>												

	<pre> </annotation> <restriction base="xs:string"> <enumeration value="0080001"> <annotation> <documentation>Endoprothese Hüfte/Knie</documentation> </annotation> </enumeration> <enumeration value="0080002"> <annotation> <documentation>Brustimplantat</documentation> </annotation> </enumeration> <enumeration value="0080003"> <annotation> <documentation>Aortenklappenprothese</documentation> </annotation> </enumeration> </restriction> </simpleType> </pre>
--	--

simpleType enum_0100

namespace	http://xml.ir-d.de/irdsaa		
type	restriction of string		
properties	base xs:string		
facets	Kind	Value	Annotation
	enumeration	0100001	documentation Primäreingriff
	enumeration	0100002	documentation Austausch Expander gegen dauerhaftes Brustimplantat
	enumeration	0100003	documentation Revision
	enumeration	0100004	documentation Nur Explantation
annotation	documentation Kat_BI_ArtEingriff		
source	<pre> <simpleType name="enum_0100"> <annotation> <documentation>Kat_BI_ArtEingriff</documentation> </annotation> <restriction base="xs:string"> <enumeration value="0100001"> <annotation> <documentation>Primäreingriff</documentation> </annotation> </enumeration> <enumeration value="0100002"> <annotation> <documentation>Austausch Expander gegen dauerhaftes Brustimplantat</documentation> </annotation> </enumeration> <enumeration value="0100003"> <annotation> <documentation>Revision</documentation> </annotation> </enumeration> </restriction> </pre>		

	<pre> <enumeration value="0100004"> <annotation> <documentation>Nur Explantation</documentation> </annotation> </enumeration> </restriction> </simpleType> </pre>
--	---

simpleType enum_0102

namespace	http://xml.ir-d.de/irdsaa		
type	restriction of string		
properties	base xs:string		
facets	Kind	Value	Annotation
	enumeration	0102001	documentation kosmetische Augmentation
	enumeration	0102002	documentation Rekonstruktion, benigne
	enumeration	0102003	documentation Rekonstruktion nach Mastektomie aufgrund eines Karzinoms
	enumeration	0102004	documentation Rekonstruktion nach risikoreduzierender Mastektomie
annotation	documentation Kat_BI_GrundPrimaereingriff		
source	<pre> <simpleType name="enum_0102"> <annotation> <documentation>Kat_BI_GrundPrimaereingriff</documentation> </annotation> <restriction base="xs:string"> <enumeration value="0102001"> <annotation> <documentation>kosmetische Augmentation</documentation> </annotation> </enumeration> <enumeration value="0102002"> <annotation> <documentation>Rekonstruktion, benigne</documentation> </annotation> </enumeration> <enumeration value="0102003"> <annotation> <documentation>Rekonstruktion nach Mastektomie aufgrund eines Karzinoms</documentation> </annotation> </enumeration> <enumeration value="0102004"> <annotation> <documentation>Rekonstruktion nach risikoreduzierender Mastektomie</documentation> </annotation> </enumeration> </restriction> </simpleType> </pre>		

simpleType enum_0103

namespace	http://xml.ir-d.de/irdsaa		
type	restriction of string		
properties	base xs:string		
facets	Kind	Value	Annotation
	enumeration	0103001	documentation simultane Lappendeckung
	enumeration	0103002	documentation simultane Eigenfetttransplantation
	enumeration	0103003	documentation simultane Mastopexie
	enumeration	0103005	documentation simultane Mastektomie, Ablatio / hautsparend
	enumeration	0103006	documentation simultane Mastektomie, nippelerhaltend
	enumeration	0103007	documentation Axilla-Dissektion
	enumeration	0103008	documentation Drainage
annotation	documentation Kat_BI_OperationsdetailPrimaereingriff		
source	<pre> <simpleType name="enum_0103"> <annotation> <documentation>Kat_BI_OperationsdetailPrimaereingriff</documentation> </annotation> <restriction base="xs:string"> <enumeration value="0103001"> <annotation> <documentation>simultane Lappendeckung</documentation> </annotation> </enumeration> <enumeration value="0103002"> <annotation> <documentation>simultane Eigenfetttransplantation</documentation> </annotation> </enumeration> <enumeration value="0103003"> <annotation> <documentation>simultane Mastopexie</documentation> </annotation> </enumeration> <enumeration value="0103005"> <annotation> <documentation>simultane Mastektomie, Ablatio / hautsparend</documentation> </annotation> </enumeration> <enumeration value="0103006"> <annotation> <documentation>simultane Mastektomie, nippelerhaltend</documentation> </annotation> </enumeration> <enumeration value="0103007"> <annotation> <documentation>Axilla-Dissektion</documentation> </annotation> </enumeration> <enumeration value="0103008"> </pre>		

	<pre> <annotation> <documentation>Drainage</documentation> </annotation> </enumeration> </restriction> </simpleType> </pre>
--	---

simpleType enum_0104

namespace	http://xml.ir-d.de/irdsaa		
type	restriction of string		
properties	base xs:string		
facets	Kind	Value	Annotation
	enumeration	0104001	documentation Austausch Expander gegen dauerhaftes Brustimplantat
annotation	documentation Kat_BI_GrundAustausch		
source	<pre> <simpleType name="enum_0104"> <annotation> <documentation>Kat_BI_GrundAustausch</documentation> </annotation> <restriction base="xs:string"> <enumeration value="0104001"> <annotation> <documentation>Austausch Expander gegen dauerhaftes Brustimplantat</documentation> </annotation> </enumeration> </restriction> </simpleType> </pre>		

simpleType enum_0105

namespace	http://xml.ir-d.de/irdsaa		
type	restriction of string		
properties	base xs:string		
facets	Kind	Value	Annotation
	enumeration	0105001	documentation simultane Lappendeckung
	enumeration	0105002	documentation simultane Eigenfetttransplantation
	enumeration	0105003	documentation simultane Mastopexie
	enumeration	0105008	documentation Drainage
	enumeration	0105009	documentation Kapsulektomie, komplett
	enumeration	0105010	documentation Kapsulektomie, partiell
	enumeration	0105011	documentation Neopocket
annotation	documentation Kat_BI_OperationsdetailAustausch		
source	<pre> <simpleType name="enum_0105"> <annotation> </pre>		

```

<documentation>Kat_BI_OperationsdetailAustausch</documentation>
</annotation>
<restriction base="xs:string">
  <enumeration value="0105001">
    <annotation>
      <documentation>simultane Lappendeckung</documentation>
    </annotation>
  </enumeration>
  <enumeration value="0105002">
    <annotation>
      <documentation>simultane Eigenfetttransplantation</documentation>
    </annotation>
  </enumeration>
  <enumeration value="0105003">
    <annotation>
      <documentation>simultane Mastopexie</documentation>
    </annotation>
  </enumeration>
  <enumeration value="0105008">
    <annotation>
      <documentation>Drainage</documentation>
    </annotation>
  </enumeration>
  <enumeration value="0105009">
    <annotation>
      <documentation>Kapsulektomie, komplett</documentation>
    </annotation>
  </enumeration>
  <enumeration value="0105010">
    <annotation>
      <documentation>Kapsulektomie, partiell</documentation>
    </annotation>
  </enumeration>
  <enumeration value="0105011">
    <annotation>
      <documentation>Neopocket</documentation>
    </annotation>
  </enumeration>
</restriction>
</simpleType>

```

simpleType enum_0106

namespace	http://xml.ir-d.de/irdsaa		
type	restriction of string		
properties	base xs:string		
facets	Kind	Value	Annotation
	enumeration	0106001	documentation Patientenwunsch
	enumeration	0106002	documentation asymptomatisch
	enumeration	0106003	documentation Komplikation
annotation	documentation Kat_BI_GrundRevisionExplantation		
source	<simpleType name="enum_0106"> <annotation>		

	<pre> <documentation>Kat_BI_GrundRevisionExplantation</documentation> </annotation> <restriction base="xs:string"> <enumeration value="0106001"> <annotation> <documentation>Patientenwunsch</documentation> </annotation> </enumeration> <enumeration value="0106002"> <annotation> <documentation>asymptomatisch</documentation> </annotation> </enumeration> <enumeration value="0106003"> <annotation> <documentation>Komplikation</documentation> </annotation> </enumeration> </restriction> </simpleType> </pre>
--	---

simpleType **enum_0107**

namespace	http://xml.ir-d.de/irdsaa		
type	restriction of string		
properties	base xs:string		
facets	Kind	Value	Annotation
	enumeration	0107001	documentation simultane Lappendeckung
	enumeration	0107002	documentation simultane Eigenfettransplantation
	enumeration	0107003	documentation simultane Mastopexie
	enumeration	0107005	documentation simultane Mastektomie, Ablatio / hautsparend
	enumeration	0107006	documentation simultane Mastektomie, nippelerhaltend
	enumeration	0107007	documentation Axilla-Dissektion
	enumeration	0107008	documentation Drainage
	enumeration	0107009	documentation Kapsulektomie, komplett
	enumeration	0107010	documentation Kapsulektomie, partiell
	enumeration	0107011	documentation Neopocket
annotation	documentation Kat_BI_OperationsdetailRevision		
source	<pre> <simpleType name="enum_0107"> <annotation> <documentation>Kat_BI_OperationsdetailRevision</documentation> </annotation> <restriction base="xs:string"> <enumeration value="0107001"> <annotation> <documentation>simultane Lappendeckung</documentation> </annotation> </pre>		

```

</enumeration>
<enumeration value="0107002">
  <annotation>
    <documentation>simultane Eigenfetttransplantation</documentation>
  </annotation>
</enumeration>
<enumeration value="0107003">
  <annotation>
    <documentation>simultane Mastopexie</documentation>
  </annotation>
</enumeration>
<enumeration value="0107005">
  <annotation>
    <documentation>simultane Mastektomie, Ablatio /
hautsparend</documentation>
  </annotation>
</enumeration>
<enumeration value="0107006">
  <annotation>
    <documentation>simultane Mastektomie, nippelerhaltend</documentation>
  </annotation>
</enumeration>
<enumeration value="0107007">
  <annotation>
    <documentation>Axilla-Dissektion</documentation>
  </annotation>
</enumeration>
<enumeration value="0107008">
  <annotation>
    <documentation>Drainage</documentation>
  </annotation>
</enumeration>
<enumeration value="0107009">
  <annotation>
    <documentation>Kapsulektomie, komplett</documentation>
  </annotation>
</enumeration>
<enumeration value="0107010">
  <annotation>
    <documentation>Kapsulektomie, partiell</documentation>
  </annotation>
</enumeration>
<enumeration value="0107011">
  <annotation>
    <documentation>Neopocket</documentation>
  </annotation>
</enumeration>
</restriction>
</simpleType>

```

simpleType enum_0110

namespace	http://xml.ir-d.de/irdsaa
type	restriction of string
properties	base xs:string
facets	Kind Value Annotation

	enumeration 0110001 documentation Bestrahlung
annotation	documentation Kat_BI_VorbehandlungLokal
source	<pre> <simpleType name="enum_0110"> <annotation> <documentation>Kat_BI_VorbehandlungLokal</documentation> </annotation> <restriction base="xs:string"> <enumeration value="0110001"> <annotation> <documentation>Bestrahlung</documentation> </annotation> </enumeration> </restriction> </simpleType> </pre>

simpleType enum_0111

namespace	http://xml.ir-d.de/irdsaa		
type	restriction of string		
properties	base xs:string		
facets	Kind	Value	Annotation
	enumeration	0111001	documentation nein
	enumeration	0111002	documentation Lipofilling
	enumeration	0111003	documentation Eigengewebsrekonstruktion
annotation	documentation Kat_BI_Verfahrenswechsel		
source	<pre> <simpleType name="enum_0111"> <annotation> <documentation>Kat_BI_Verfahrenswechsel</documentation> </annotation> <restriction base="xs:string"> <enumeration value="0111001"> <annotation> <documentation>nein</documentation> </annotation> </enumeration> <enumeration value="0111002"> <annotation> <documentation>Lipofilling</documentation> </annotation> </enumeration> <enumeration value="0111003"> <annotation> <documentation>Eigengewebsrekonstruktion</documentation> </annotation> </enumeration> </restriction> </simpleType> </pre>		

simpleType enum_0112

namespace	http://xml.ir-d.de/irdsaa		
type	restriction of string		
properties	base xs:string		
facets	Kind	Value	Annotation
	enumeration	0112001	documentation subglandulär / epipektoral
	enumeration	0112002	documentation subpektoral
	enumeration	0112003	documentation subfaszial
	enumeration	0112004	documentation sub-flap
	enumeration	0112005	documentation subkutan
	enumeration	0112006	documentation dual plane
	enumeration	0112042	documentation andere
annotation	documentation Kat_BI_LageImplantat		
source	<pre> <simpleType name="enum_0112"> <annotation> <documentation>Kat_BI_LageImplantat</documentation> </annotation> <restriction base="xs:string"> <enumeration value="0112001"> <annotation> <documentation>subglandulär / epipektoral</documentation> </annotation> </enumeration> <enumeration value="0112002"> <annotation> <documentation>subpektoral</documentation> </annotation> </enumeration> <enumeration value="0112003"> <annotation> <documentation>subfaszial</documentation> </annotation> </enumeration> <enumeration value="0112004"> <annotation> <documentation>sub-flap</documentation> </annotation> </enumeration> <enumeration value="0112005"> <annotation> <documentation>subkutan</documentation> </annotation> </enumeration> <enumeration value="0112006"> <annotation> <documentation>dual plane</documentation> </annotation> </enumeration> <enumeration value="0112042"> <annotation> </pre>		

	<pre> <documentation>andere</documentation> </annotation> </enumeration> </restriction> </simpleType> </pre>
--	--

simpleType enum_0113

namespace	http://xml.ir-d.de/irdsaa		
type	restriction of string		
properties	base xs:string		
facets	Kind	Value	Annotation
	enumeration	0113001	documentation Chemotherapie innerhalb der letzten drei Monate
annotation	documentation Kat_BI_VorbehandlungSystemisch		
source	<pre> <simpleType name="enum_0113"> <annotation> <documentation>Kat_BI_VorbehandlungSystemisch</documentation> </annotation> <restriction base="xs:string"> <enumeration value="0113001"> <annotation> <documentation>Chemotherapie innerhalb der letzten drei Monate</documentation> </annotation> </enumeration> </restriction> </simpleType> </pre>		

simpleType enum_0114

namespace	http://xml.ir-d.de/irdsaa		
type	restriction of string		
properties	base xs:string		
facets	Kind	Value	Annotation
	enumeration	0114001	documentation vollständig
	enumeration	0114002	documentation nein
	enumeration	0114003	documentation teilweise
	enumeration	0114004	documentation nicht vorhanden
annotation	documentation Kat_BI_EntfernungADMNetz		
source	<pre> <simpleType name="enum_0114"> <annotation> <documentation>Kat_BI_EntfernungADMNetz</documentation> </annotation> <restriction base="xs:string"> <enumeration value="0114001"> <annotation> <documentation>vollständig</documentation> </pre>		

	<pre> </annotation> </enumeration> <enumeration value="0114002"> <annotation> <documentation>nein</documentation> </annotation> </enumeration> <enumeration value="0114003"> <annotation> <documentation>teilweise</documentation> </annotation> </enumeration> <enumeration value="0114004"> <annotation> <documentation>nicht vorhanden</documentation> </annotation> </enumeration> </restriction> </simpleType> </pre>
--	--

simpleType enum_0116

namespace	http://xml.ir-d.de/irdsaa		
type	restriction of string		
properties	base xs:string		
facets	Kind	Value	Annotation
	enumeration	0116001	documentation Spülung, antibiotisch
	enumeration	0116002	documentation Spülung, antiseptisch
	enumeration	0116003	documentation Spülung, wirkstofffrei
	enumeration	0116004	documentation Spülung, andere
	enumeration	0116005	documentation prä-/perioperative Antibiotika
	enumeration	0116006	documentation postoperative Antibiotika
	enumeration	0116007	documentation Handschuhwechsel vor Implantation
	enumeration	0116008	documentation Implantationshilfe
annotation	documentation Kat_BI_Operationsmassnahme		
source	<pre> <simpleType name="enum_0116"> <annotation> <documentation>Kat_BI_Operationsmassnahme</documentation> </annotation> <restriction base="xs:string"> <enumeration value="0116001"> <annotation> <documentation>Spülung, antibiotisch</documentation> </annotation> </enumeration> <enumeration value="0116002"> <annotation> <documentation>Spülung, antiseptisch</documentation> </annotation> </enumeration> </restriction> </simpleType> </pre>		

	<pre> </enumeration> <enumeration value="0116003"> <annotation> <documentation>Spülung, wirkstofffrei</documentation> </annotation> </enumeration> <enumeration value="0116004"> <annotation> <documentation>Spülung, andere</documentation> </annotation> </enumeration> <enumeration value="0116005"> <annotation> <documentation>prä-/perioperative Antibiotika</documentation> </annotation> </enumeration> <enumeration value="0116006"> <annotation> <documentation>postoperative Antibiotika</documentation> </annotation> </enumeration> <enumeration value="0116007"> <annotation> <documentation>Handschuhwechsel vor Implantation</documentation> </annotation> </enumeration> <enumeration value="0116008"> <annotation> <documentation>Implantationshilfe</documentation> </annotation> </enumeration> </restriction> </simpleType> </pre>
--	---

simpleType enum_0118

namespace	http://xml.lir-d.de/irdsaa		
type	restriction of string		
properties	base xs:string		
facets	Kind	Value	Annotation
	enumeration	0118001	documentation axillär
	enumeration	0118002	documentation periareolär
	enumeration	0118003	documentation inframammär
	enumeration	0118004	documentation Mastektomienarbe
	enumeration	0118042	documentation anderer
annotation	documentation Kat_BI_Operationszugang		
source	<pre> <simpleType name="enum_0118"> <annotation> <documentation>Kat_BI_Operationszugang</documentation> </annotation> <restriction base="xs:string"> </pre>		

	<pre> <enumeration value="0118001"> <annotation> <documentation>axillär</documentation> </annotation> </enumeration> <enumeration value="0118002"> <annotation> <documentation>periareolär</documentation> </annotation> </enumeration> <enumeration value="0118003"> <annotation> <documentation>inframammär</documentation> </annotation> </enumeration> <enumeration value="0118004"> <annotation> <documentation>Mastektomienarbe</documentation> </annotation> </enumeration> <enumeration value="0118042"> <annotation> <documentation>anderer</documentation> </annotation> </enumeration> </restriction> </simpleType> </pre>
--	---

simpleType enum_0120

namespace	http://xml.ir-d.de/irdsaa		
type	restriction of string		
properties	base xs:string		
facets	Kind	Value	Annotation
	enumeration	0120001	documentation Expander defekt
annotation	documentation Kat_BI_BefundAustausch		
source	<pre> <simpleType name="enum_0120"> <annotation> <documentation>Kat_BI_BefundAustausch</documentation> </annotation> <restriction base="xs:string"> <enumeration value="0120001"> <annotation> <documentation>Expander defekt</documentation> </annotation> </enumeration> </restriction> </simpleType> </pre>		

simpleType enum_0121

namespace	http://xml.ir-d.de/irdsaa
-----------	---------------------------

type	restriction of string		
properties	base xs:string		
facets	Kind	Value	Annotation
	enumeration	0121001	documentation Infektion
	enumeration	0121002	documentation Serom
	enumeration	0121003	documentation Hämatom
	enumeration	0121004	documentation Kapsel­fibrose
	enumeration	0121005	documentation Implantat­ruptur
	enumeration	0121006	documentation Fehl­positionierung/Rotation
	enumeration	0121007	documentation BIA-ALCL/-SCC, Verdacht
	enumeration	0121008	documentation BIA-ALCL/-SCC, pathologisch bestätigt
	enumeration	0121009	documentation Brustschmerzen
	enumeration	0121010	documentation Doppelkapsel
	enumeration	0121011	documentation Netz-/ADM-bedingte Komplikation, Non-Integration
	enumeration	0121012	documentation Netz-/ADM-bedingte Komplikation, andere
	enumeration	0121013	documentation Hautnekrose/exponiertes Implantat
	enumeration	0121014	documentation BII/ASIA (Brustimplantat assoziierte Symptome), Verdacht
	enumeration	0121015	documentation Lymphadenopathie
	enumeration	0121016	documentation Brustkrebs, neu aufgetreten/Rezidiv
annotation	documentation Kat_BI_BefundKomplett		
source	<pre> <simpleType name="enum_0121"> <annotation> <documentation>Kat_BI_BefundKomplett</documentation> </annotation> <restriction base="xs:string"> <enumeration value="0121001"> <annotation> <documentation>Infektion</documentation> </annotation> </enumeration> <enumeration value="0121002"> <annotation> <documentation>Serom</documentation> </annotation> </enumeration> <enumeration value="0121003"> <annotation> <documentation>Hämatom</documentation> </annotation> </enumeration> <enumeration value="0121004"> <annotation> <documentation>Kapsel­fibrose</documentation> </annotation> </pre>		

```

</enumeration>
<enumeration value="0121005">
  <annotation>
    <documentation>Implantatruptur</documentation>
  </annotation>
</enumeration>
<enumeration value="0121006">
  <annotation>
    <documentation>Fehlpositionierung/Rotation</documentation>
  </annotation>
</enumeration>
<enumeration value="0121007">
  <annotation>
    <documentation>BIA-ALCL/-SCC, Verdacht</documentation>
  </annotation>
</enumeration>
<enumeration value="0121008">
  <annotation>
    <documentation>BIA-ALCL/-SCC, pathologisch bestätigt</documentation>
  </annotation>
</enumeration>
<enumeration value="0121009">
  <annotation>
    <documentation>Brustschmerzen</documentation>
  </annotation>
</enumeration>
<enumeration value="0121010">
  <annotation>
    <documentation>Doppelkapsel</documentation>
  </annotation>
</enumeration>
<enumeration value="0121011">
  <annotation>
    <documentation>Netz-/ADM-bedingte Komplikation,
Non-Integration</documentation>
  </annotation>
</enumeration>
<enumeration value="0121012">
  <annotation>
    <documentation>Netz-/ADM-bedingte Komplikation, andere</documentation>
  </annotation>
</enumeration>
<enumeration value="0121013">
  <annotation>
    <documentation>Hautnekrose/exponiertes Implantat</documentation>
  </annotation>
</enumeration>
<enumeration value="0121014">
  <annotation>
    <documentation>BII/ASIA (Brustimplantat assoziierte Symptome),
Verdacht</documentation>
  </annotation>
</enumeration>
<enumeration value="0121015">
  <annotation>
    <documentation>Lymphadenopathie</documentation>
  </annotation>
</enumeration>
<enumeration value="0121016">

```

	<pre> <annotation> <documentation>Brustkrebs, neu aufgetreten/Rezidiv</documentation> </annotation> </enumeration> </restriction> </simpleType> </pre>
--	--

simpleType enum_0122

namespace	http://xml.ir-d.de/irdsaa		
type	restriction of string		
properties	base xs:string		
facets	Kind	Value	Annotation
	enumeration	0122001	documentation ja, ärztlich nachgewiesen
	enumeration	0122002	documentation nein
	enumeration	0122042	documentation unbekannt
annotation	documentation Kat_BI_Autoimmunerkrankung		
source	<pre> <simpleType name="enum_0122"> <annotation> <documentation>Kat_BI_Autoimmunerkrankung</documentation> </annotation> <restriction base="xs:string"> <enumeration value="0122001"> <annotation> <documentation>ja, ärztlich nachgewiesen</documentation> </annotation> </enumeration> <enumeration value="0122002"> <annotation> <documentation>nein</documentation> </annotation> </enumeration> <enumeration value="0122042"> <annotation> <documentation>unbekannt</documentation> </annotation> </enumeration> </restriction> </simpleType> </pre>		

simpleType enum_0123

namespace	http://xml.ir-d.de/irdsaa		
type	restriction of string		
properties	base xs:string		
facets	Kind	Value	Annotation
	enumeration	0123001	documentation neu aufgetreten
	enumeration	0123002	documentation verschlechtert
	enumeration	0123003	documentation

	<p>enumeration 0123004 keine Veränderung documentation nicht relevant, da Primäreingriff</p> <p>enumeration 0123042 documentation unbekannt</p>
annotation	documentation Kat_BI_VerlaufAutoimmunerkrankung
source	<pre> <simpleType name="enum_0123"> <annotation> <documentation>Kat_BI_VerlaufAutoimmunerkrankung</documentation> </annotation> <restriction base="xs:string"> <enumeration value="0123001"> <annotation> <documentation>neu aufgetreten</documentation> </annotation> </enumeration> <enumeration value="0123002"> <annotation> <documentation>verschlechtert</documentation> </annotation> </enumeration> <enumeration value="0123003"> <annotation> <documentation>keine Veränderung</documentation> </annotation> </enumeration> <enumeration value="0123004"> <annotation> <documentation>nicht relevant, da Primäreingriff</documentation> </annotation> </enumeration> <enumeration value="0123042"> <annotation> <documentation>unbekannt</documentation> </annotation> </enumeration> </restriction> </simpleType> </pre>

simpleType enum_0124

namespace	http://xml.ir-d.de/irdsaa		
type	restriction of string		
properties	base xs:string		
facets	Kind	Value	Annotation
	enumeration	0124001	documentation Salzlösung
	enumeration	0124002	documentation Silikongel
	enumeration	0124003	documentation Kombination Silikongel und Salzlösung
	enumeration	0124042	documentation sonstige
annotation	documentation Kat_BI_Fuellung		
source	<simpleType name="enum_0124">		

	<pre> <annotation> <documentation>Kat_BI_Fuellung</documentation> </annotation> <restriction base="xs:string"> <enumeration value="0124001"> <annotation> <documentation>Salzlösung</documentation> </annotation> </enumeration> <enumeration value="0124002"> <annotation> <documentation>Silikongel</documentation> </annotation> </enumeration> <enumeration value="0124003"> <annotation> <documentation>Kombination Silikongel und Salzlösung</documentation> </annotation> </enumeration> <enumeration value="0124042"> <annotation> <documentation>sonstige</documentation> </annotation> </enumeration> </restriction> </simpleType> </pre>
--	---

simpleType enum_0126

namespace	http://xml.ir-d.de/irdsaa		
type	restriction of string		
properties	base xs:string		
facets	Kind	Value	Annotation
	enumeration	0126001	documentation anatomisch (tropfenförmig)
	enumeration	0126002	documentation rund (punktsymmetrisch)
	enumeration	0126042	documentation sonstige
annotation	documentation Kat BI Form		
source	<pre> <simpleType name="enum_0126"> <annotation> <documentation>Kat_BI_Form</documentation> </annotation> <restriction base="xs:string"> <enumeration value="0126001"> <annotation> <documentation>anatomisch (tropfenförmig)</documentation> </annotation> </enumeration> <enumeration value="0126002"> <annotation> <documentation>rund (punktsymmetrisch)</documentation> </annotation> </enumeration> <enumeration value="0126042"> </pre>		

	<pre> <annotation> <documentation>sonstige</documentation> </annotation> </enumeration> </restriction> </simpleType> </pre>
--	---

simpleType enum_0128

namespace	http://xml.ir-d.de/irdsaa		
type	restriction of string		
properties	base xs:string		
facets	Kind	Value	Annotation
	enumeration	0128001	documentation glattwandig
	enumeration	0128002	documentation beschichtet
	enumeration	0128003	documentation texturiert
annotation	documentation Kat_BI_Oberflaeche		
source	<pre> <simpleType name="enum_0128"> <annotation> <documentation>Kat_BI_Oberflaeche</documentation> </annotation> <restriction base="xs:string"> <enumeration value="0128001"> <annotation> <documentation>glattwandig</documentation> </annotation> </enumeration> <enumeration value="0128002"> <annotation> <documentation>beschichtet</documentation> </annotation> </enumeration> <enumeration value="0128003"> <annotation> <documentation>texturiert</documentation> </annotation> </enumeration> </restriction> </simpleType> </pre>		

simpleType enum_0130

namespace	http://xml.ir-d.de/irdsaa		
type	restriction of string		
properties	base xs:string		
facets	Kind	Value	Annotation
	enumeration	0130001	documentation Allergan
	enumeration	0130002	documentation Cereplas
	enumeration	0130003	documentation

	<p>enumeration 0130004 CUI (Cox Uphoff Implants) documentation</p> <p>enumeration 0130005 EMSI Biomedical documentation</p> <p>enumeration 0130006 Establishment labs documentation</p> <p>enumeration 0130007 Eurosilicone documentation</p> <p>enumeration 0130008 Nagor documentation</p> <p>enumeration 0130008 Groupe Sebbin documentation</p> <p>enumeration 0130009 Laboratoires Arion documentation</p> <p>enumeration 0130010 Mentor documentation</p> <p>enumeration 0130011 Pérouse Plastie SAS documentation</p> <p>enumeration 0130012 PIP M-Implants documentation</p> <p>enumeration 0130013 Polytech Health & Aesthetics documentation</p> <p>enumeration 0130014 Silimed documentation</p> <p>enumeration 0130015 Surgitek documentation</p> <p>enumeration 0130016 G&G Biotechnology documentation</p> <p>enumeration 0130017 nicht belegter Wert documentation</p> <p>enumeration 0130018 nicht belegter Wert documentation</p> <p>enumeration 0130019 nicht belegter Wert documentation</p> <p>enumeration 0130020 nicht belegter Wert documentation</p> <p>enumeration 0130021 nicht belegter Wert documentation</p> <p>enumeration 0130042 nicht belegter Wert documentation sonstiger</p>
annotation	documentation Kat_BI_Hersteller
source	<pre> <simpleType name="enum_0130"> <annotation> <documentation>Kat_BI_Hersteller</documentation> </annotation> <restriction base="xs:string"> <enumeration value="0130001"> <annotation> <documentation>Allergan</documentation> </annotation> </enumeration> <enumeration value="0130002"> <annotation> <documentation>Cereplas</documentation> </annotation> </enumeration> <enumeration value="0130003"> <annotation> <documentation>CUI (Cox Uphoff Implants)</documentation> </annotation> </enumeration> <enumeration value="0130004"> </pre>

```
<annotation>
  <documentation>EMSI Biomedical</documentation>
</annotation>
</enumeration>
<enumeration value="0130005">
  <annotation>
    <documentation>Establishment labs</documentation>
  </annotation>
</enumeration>
<enumeration value="0130006">
  <annotation>
    <documentation>Eurosilicone</documentation>
  </annotation>
</enumeration>
<enumeration value="0130007">
  <annotation>
    <documentation>Nagor</documentation>
  </annotation>
</enumeration>
<enumeration value="0130008">
  <annotation>
    <documentation>Groupe Sebbin</documentation>
  </annotation>
</enumeration>
<enumeration value="0130009">
  <annotation>
    <documentation>Laboratoires Arion</documentation>
  </annotation>
</enumeration>
<enumeration value="0130010">
  <annotation>
    <documentation>Mentor</documentation>
  </annotation>
</enumeration>
<enumeration value="0130011">
  <annotation>
    <documentation>Pérouse Plastie SAS</documentation>
  </annotation>
</enumeration>
<enumeration value="0130012">
  <annotation>
    <documentation>PIP M-Implants</documentation>
  </annotation>
</enumeration>
<enumeration value="0130013">
  <annotation>
    <documentation>Polytech Health & Aesthetics</documentation>
  </annotation>
</enumeration>
<enumeration value="0130014">
  <annotation>
    <documentation>Silimed</documentation>
  </annotation>
</enumeration>
<enumeration value="0130015">
  <annotation>
    <documentation>Surgitek</documentation>
  </annotation>
</enumeration>
```

```

<enumeration value="0130016">
  <annotation>
    <documentation>G&G Biotechnology</documentation>
  </annotation>
</enumeration>
<enumeration value="0130017">
  <annotation>
    <documentation>nicht belegter Wert</documentation>
  </annotation>
</enumeration>
<enumeration value="0130018">
  <annotation>
    <documentation>nicht belegter Wert</documentation>
  </annotation>
</enumeration>
<enumeration value="0130019">
  <annotation>
    <documentation>nicht belegter Wert</documentation>
  </annotation>
</enumeration>
<enumeration value="0130020">
  <annotation>
    <documentation>nicht belegter Wert</documentation>
  </annotation>
</enumeration>
<enumeration value="0130021">
  <annotation>
    <documentation>nicht belegter Wert</documentation>
  </annotation>
</enumeration>
<enumeration value="0130042">
  <annotation>
    <documentation>sonstiger</documentation>
  </annotation>
</enumeration>
</restriction>
</simpleType>

```

simpleType enum 0131

namespace	http://xml.ir-d.de/irdsaa		
type	restriction of string		
properties	base xs:string		
facets	Kind	Value	Annotation
	enumeration	0131001	documentation Allergan
	enumeration	0131002	documentation Establishment labs
	enumeration	0131003	documentation Eurosilicone
	enumeration	0131004	documentation Galatea
	enumeration	0131005	documentation Integra
	enumeration	0131006	documentation Lifecell
	enumeration	0131007	documentation MBP (Medical Biomaterial Products)

	<p>enumeration 0131008 documentation Mentor</p> <p>enumeration 0131009 documentation Novus Scientific</p> <p>enumeration 0131042 documentation sonstiger</p>
annotation	documentation Kat_BI_ZubehoerHersteller
source	<pre> <simpleType name="enum_0131"> <annotation> <documentation>Kat_BI_ZubehoerHersteller</documentation> </annotation> <restriction base="xs:string"> <enumeration value="0131001"> <annotation> <documentation>Allergan</documentation> </annotation> </enumeration> <enumeration value="0131002"> <annotation> <documentation>Establishment labs</documentation> </annotation> </enumeration> <enumeration value="0131003"> <annotation> <documentation>Eurosilicone</documentation> </annotation> </enumeration> <enumeration value="0131004"> <annotation> <documentation>Galatea</documentation> </annotation> </enumeration> <enumeration value="0131005"> <annotation> <documentation>Integra</documentation> </annotation> </enumeration> <enumeration value="0131006"> <annotation> <documentation>Lifecell</documentation> </annotation> </enumeration> <enumeration value="0131007"> <annotation> <documentation>MBP (Medical Biomaterial Products)</documentation> </annotation> </enumeration> <enumeration value="0131008"> <annotation> <documentation>Mentor</documentation> </annotation> </enumeration> <enumeration value="0131009"> <annotation> <documentation>Novus Scientific</documentation> </annotation> </enumeration> <enumeration value="0131042"> </pre>

	<pre> <annotation> <documentation>sonstiger</documentation> </annotation> </enumeration> </restriction> </simpleType> </pre>
--	--

simpleType enum_0190

namespace	http://xml.ir-d.de/irdsaa		
type	restriction of string		
properties	base xs:string		
facets	Kind	Value	Annotation
	enumeration	0190001	documentation Brustimplantat
	enumeration	0190003	documentation Brustexpander
annotation	documentation Kat_BI_Artikeltyp		
source	<pre> <simpleType name="enum_0190"> <annotation> <documentation>Kat_BI_Artikeltyp</documentation> </annotation> <restriction base="xs:string"> <enumeration value="0190001"> <annotation> <documentation>Brustimplantat</documentation> </annotation> </enumeration> <enumeration value="0190003"> <annotation> <documentation>Brustexpander</documentation> </annotation> </enumeration> </restriction> </simpleType> </pre>		

simpleType enum_0191

namespace	http://xml.ir-d.de/irdsaa		
type	restriction of string		
properties	base xs:string		
facets	Kind	Value	Annotation
	enumeration	0191001	documentation Netz
	enumeration	0191002	documentation ADM
annotation	documentation Kat_BI_ZubehoerTyp		
source	<pre> <simpleType name="enum_0191"> <annotation> <documentation>Kat_BI_ZubehoerTyp</documentation> </annotation> <restriction base="xs:string"> </pre>		

	<pre> <enumeration value="0191001"> <annotation> <documentation>Netz</documentation> </annotation> </enumeration> <enumeration value="0191002"> <annotation> <documentation>ADM</documentation> </annotation> </enumeration> </restriction> </simpleType> </pre>
--	--

simpleType enum_0200

namespace	http://xml.ir-d.de/irdsaa		
type	restriction of string		
properties	base xs:string		
facets	Kind	Value	Annotation
	enumeration	0200001	documentation Erst-OP
	enumeration	0200002	documentation Folgeeingriff
annotation	documentation Kat_EP_ArtEingriff		
source	<pre> <simpleType name="enum_0200"> <annotation> <documentation>Kat_EP_ArtEingriff</documentation> </annotation> <restriction base="xs:string"> <enumeration value="0200001"> <annotation> <documentation>Erst-OP</documentation> </annotation> </enumeration> <enumeration value="0200002"> <annotation> <documentation>Folgeeingriff</documentation> </annotation> </enumeration> </restriction> </simpleType> </pre>		

simpleType enum_0202

namespace	http://xml.ir-d.de/irdsaa		
type	restriction of string		
properties	base xs:string		
facets	Kind	Value	Annotation
	enumeration	0202001	documentation Lockerung
	enumeration	0202002	documentation Infektion, Verdacht auf
	enumeration	0202003	documentation

	<p>enumeration 0202004 Infektion, gesichert documentation</p> <p>enumeration 0202005 Luxation, Inlay aus der Pfanne documentation</p> <p>enumeration 0202006 Luxation, Kopf aus Pfanne/Inlay documentation</p> <p>enumeration 0202007 Periprothetische Fraktur documentation</p> <p>enumeration 0202008 Verschleiß des PE-Inlays documentation</p> <p>enumeration 0202009 Implantatbruch documentation</p> <p>enumeration 0202010 Implantatfehlage/Malalignement documentation</p> <p>enumeration 0202011 Osteolysen bei festem Implantat documentation</p> <p>enumeration 0202012 Progression der Grunderkrankung documentation</p> <p>enumeration 0202013 ARMD documentation</p> <p>enumeration 0202013 Verdacht auf allergische Reaktion documentation</p> <p>enumeration 0202021 Zustand nach Prothesenentfernung documentation</p> <p>enumeration 0202042 andere Gründe documentation</p>
annotation	documentation Kat_EP_GrundWechselHuefte
source	<pre> <simpleType name="enum_0202"> <annotation> <documentation>Kat_EP_GrundWechselHuefte</documentation> </annotation> <restriction base="xs:string"> <enumeration value="0202001"> <annotation> <documentation>Lockerung</documentation> </annotation> </enumeration> <enumeration value="0202002"> <annotation> <documentation>Infektion, Verdacht auf</documentation> </annotation> </enumeration> <enumeration value="0202003"> <annotation> <documentation>Infektion, gesichert</documentation> </annotation> </enumeration> <enumeration value="0202004"> <annotation> <documentation>Luxation, Inlay aus der Pfanne</documentation> </annotation> </enumeration> <enumeration value="0202005"> <annotation> <documentation>Luxation, Kopf aus Pfanne/Inlay</documentation> </annotation> </enumeration> <enumeration value="0202006"> <annotation> <documentation>Periprothetische Fraktur</documentation> </annotation> </enumeration> </restriction> </simpleType> </pre>

```

</enumeration>
<enumeration value="0202007">
  <annotation>
    <documentation>Verschleiß des PE-Inlays</documentation>
  </annotation>
</enumeration>
<enumeration value="0202008">
  <annotation>
    <documentation>Implantatbruch</documentation>
  </annotation>
</enumeration>
<enumeration value="0202009">
  <annotation>
    <documentation>Implantatfehllage/Malalignement</documentation>
  </annotation>
</enumeration>
<enumeration value="0202010">
  <annotation>
    <documentation>Osteolysen bei festem Implantat</documentation>
  </annotation>
</enumeration>
<enumeration value="0202011">
  <annotation>
    <documentation>Progression der Grunderkrankung</documentation>
  </annotation>
</enumeration>
<enumeration value="0202012">
  <annotation>
    <documentation>ARMD</documentation>
  </annotation>
</enumeration>
<enumeration value="0202013">
  <annotation>
    <documentation>Verdacht auf allergische Reaktion</documentation>
  </annotation>
</enumeration>
<enumeration value="0202021">
  <annotation>
    <documentation>Zustand nach Prothesenentfernung</documentation>
  </annotation>
</enumeration>
<enumeration value="0202042">
  <annotation>
    <documentation>andere Gründe</documentation>
  </annotation>
</enumeration>
</restriction>
</simpleType>

```

simpleType enum_0204

namespace	http://xml.ir-d.de/irdsaa		
type	restriction of string		
properties	base xs:string		
facets	Kind enumeration	Value 0204001	Annotation documentation Lockerung

	<p>enumeration 0204002 documentation Infektion, Verdacht auf</p> <p>enumeration 0204003 documentation Infektion, gesichert</p> <p>enumeration 0204006 documentation Periprothetische Fraktur</p> <p>enumeration 0204007 documentation Verschleiß</p> <p>enumeration 0204008 documentation Implantatbruch</p> <p>enumeration 0204009 documentation Implantatfehlage/Malalignement</p> <p>enumeration 0204010 documentation Osteolysen bei festem Implantat</p> <p>enumeration 0204011 documentation Progression der Grunderkrankung</p> <p>enumeration 0204012 documentation ARMD</p> <p>enumeration 0204013 documentation Verdacht auf allergische Reaktion</p> <p>enumeration 0204014 documentation Dislokation/Migration von Komponenten</p> <p>enumeration 0204015 documentation Bandinstabilität</p> <p>enumeration 0204016 documentation Bewegungseinschränkung</p> <p>enumeration 0204021 documentation Zustand nach Prothesenentfernung</p> <p>enumeration 0204042 documentation andere Gründe</p>
annotation	<p>documentation Kat_EP_GrundWechselKnie</p>
source	<pre> <simpleType name="enum_0204"> <annotation> <documentation>Kat_EP_GrundWechselKnie</documentation> </annotation> <restriction base="xs:string"> <enumeration value="0204001"> <annotation> <documentation>Lockerung</documentation> </annotation> </enumeration> <enumeration value="0204002"> <annotation> <documentation>Infektion, Verdacht auf</documentation> </annotation> </enumeration> <enumeration value="0204003"> <annotation> <documentation>Infektion, gesichert</documentation> </annotation> </enumeration> <enumeration value="0204006"> <annotation> <documentation>Periprothetische Fraktur</documentation> </annotation> </enumeration> <enumeration value="0204007"> <annotation> <documentation>Verschleiß</documentation> </annotation> </enumeration> </restriction> </simpleType> </pre>

```
<enumeration value="0204008">
  <annotation>
    <documentation>Implantatbruch</documentation>
  </annotation>
</enumeration>
<enumeration value="0204009">
  <annotation>
    <documentation>Implantatfehllage/Malalignent</documentation>
  </annotation>
</enumeration>
<enumeration value="0204010">
  <annotation>
    <documentation>Osteolysen bei festem Implantat</documentation>
  </annotation>
</enumeration>
<enumeration value="0204011">
  <annotation>
    <documentation>Progression der Grunderkrankung</documentation>
  </annotation>
</enumeration>
<enumeration value="0204012">
  <annotation>
    <documentation>ARMD</documentation>
  </annotation>
</enumeration>
<enumeration value="0204013">
  <annotation>
    <documentation>Verdacht auf allergische Reaktion</documentation>
  </annotation>
</enumeration>
<enumeration value="0204014">
  <annotation>
    <documentation>Dislokation/Migration von Komponenten</documentation>
  </annotation>
</enumeration>
<enumeration value="0204015">
  <annotation>
    <documentation>Bandinstabilität</documentation>
  </annotation>
</enumeration>
<enumeration value="0204016">
  <annotation>
    <documentation>Bewegungseinschränkung</documentation>
  </annotation>
</enumeration>
<enumeration value="0204021">
  <annotation>
    <documentation>Zustand nach Prothesenentfernung</documentation>
  </annotation>
</enumeration>
<enumeration value="0204042">
  <annotation>
    <documentation>andere Gründe</documentation>
  </annotation>
</enumeration>
</restriction>
</simpleType>
```

simpleType enum_0206

namespace	http://xml.ir-d.de/irdsaa		
type	restriction of string		
properties	base xs:string		
facets	Kind	Value	Annotation
	enumeration	0206001	documentation Lockerung
	enumeration	0206002	documentation Infektion, Verdacht auf
	enumeration	0206003	documentation Infektion, gesichert
	enumeration	0206004	documentation Luxation, Inlay aus der Pfanne
	enumeration	0206005	documentation Luxation, Kopf aus Pfanne/Inlay
	enumeration	0206006	documentation Periprothetische Fraktur
	enumeration	0206007	documentation Verschleiß
	enumeration	0206008	documentation Implantatbruch
	enumeration	0206009	documentation Implantatfehlage/Malalignement
	enumeration	0206010	documentation Osteolysen bei festem Implantat
	enumeration	0206011	documentation Progression der Grunderkrankung
	enumeration	0206012	documentation ARMD
	enumeration	0206013	documentation Verdacht auf allergische Reaktion
	enumeration	0206014	documentation Dislokation/Migration von Komponenten
	enumeration	0206015	documentation Bandinstabilität
	enumeration	0206016	documentation Bewegungseinschränkung
	enumeration	0206021	documentation Zustand nach Prothesenentfernung
	enumeration	0206042	documentation andere Gründe
annotation	documentation Kat_EP_GrundWechselTFE		
source	<pre> <simpleType name="enum_0206"> <annotation> <documentation>Kat_EP_GrundWechselTFE</documentation> </annotation> <restriction base="xs:string"> <enumeration value="0206001"> <annotation> <documentation>Lockerung</documentation> </annotation> </enumeration> <enumeration value="0206002"> <annotation> <documentation>Infektion, Verdacht auf</documentation> </annotation> </enumeration> <enumeration value="0206003"> </pre>		

```
<annotation>
  <documentation>Infektion, gesichert</documentation>
</annotation>
</enumeration>
<enumeration value="0206004">
  <annotation>
    <documentation>Luxation, Inlay aus der Pfanne</documentation>
  </annotation>
</enumeration>
<enumeration value="0206005">
  <annotation>
    <documentation>Luxation, Kopf aus Pfanne/Inlay</documentation>
  </annotation>
</enumeration>
<enumeration value="0206006">
  <annotation>
    <documentation>Periprothetische Fraktur</documentation>
  </annotation>
</enumeration>
<enumeration value="0206007">
  <annotation>
    <documentation>Verschleiß</documentation>
  </annotation>
</enumeration>
<enumeration value="0206008">
  <annotation>
    <documentation>Implantatbruch</documentation>
  </annotation>
</enumeration>
<enumeration value="0206009">
  <annotation>
    <documentation>Implantatfehllage/Malalignent</documentation>
  </annotation>
</enumeration>
<enumeration value="0206010">
  <annotation>
    <documentation>Osteolysen bei festem Implantat</documentation>
  </annotation>
</enumeration>
<enumeration value="0206011">
  <annotation>
    <documentation>Progression der Grunderkrankung</documentation>
  </annotation>
</enumeration>
<enumeration value="0206012">
  <annotation>
    <documentation>ARMD</documentation>
  </annotation>
</enumeration>
<enumeration value="0206013">
  <annotation>
    <documentation>Verdacht auf allergische Reaktion</documentation>
  </annotation>
</enumeration>
<enumeration value="0206014">
  <annotation>
    <documentation>Dislokation/Migration von Komponenten</documentation>
  </annotation>
</enumeration>
```

	<pre> <enumeration value="0206015"> <annotation> <documentation>Bandinstabilität</documentation> </annotation> </enumeration> <enumeration value="0206016"> <annotation> <documentation>Bewegungseinschränkung</documentation> </annotation> </enumeration> <enumeration value="0206021"> <annotation> <documentation>Zustand nach Prothesenentfernung</documentation> </annotation> </enumeration> <enumeration value="0206042"> <annotation> <documentation>andere Gründe</documentation> </annotation> </enumeration> </restriction> </simpleType> </pre>
--	--

simpleType enum_0210

namespace	http://xml.ir-d.de/irdsaa		
type	restriction of string		
properties	base xs:string		
facets	Kind	Value	Annotation
	enumeration	0210001	documentation keine relevante Voroperation
	enumeration	0210002	documentation Osteosynthese/Osteotomie (Becken)
	enumeration	0210003	documentation Osteosynthese/Osteotomie (Femur)
	enumeration	0210004	documentation Osteosynthese/Osteotomie (beides)
	enumeration	0210005	documentation Operation bei Hüftkopfnekrose
	enumeration	0210006	documentation Arthrodese
	enumeration	0210042	documentation andere
annotation	documentation Kat_EP_VoroperationHuefte		
source	<pre> <simpleType name="enum_0210"> <annotation> <documentation>Kat_EP_VoroperationHuefte</documentation> </annotation> <restriction base="xs:string"> <enumeration value="0210001"> <annotation> <documentation>keine relevante Voroperation</documentation> </annotation> </enumeration> <enumeration value="0210002"> <annotation> </pre>		

```

    <documentation>Osteosynthese/Osteotomie (Becken)</documentation>
  </annotation>
</enumeration>
<enumeration value="0210003">
  <annotation>
    <documentation>Osteosynthese/Osteotomie (Femur)</documentation>
  </annotation>
</enumeration>
<enumeration value="0210004">
  <annotation>
    <documentation>Osteosynthese/Osteotomie (beides)</documentation>
  </annotation>
</enumeration>
<enumeration value="0210005">
  <annotation>
    <documentation>Operation bei Hüftkopfnekrose</documentation>
  </annotation>
</enumeration>
<enumeration value="0210006">
  <annotation>
    <documentation>Arthrodese</documentation>
  </annotation>
</enumeration>
<enumeration value="0210042">
  <annotation>
    <documentation>andere</documentation>
  </annotation>
</enumeration>
</restriction>
</simpleType>

```

simpleType enum_0211

namespace	http://xml.ir-d.de/irdsaa		
type	restriction of string		
properties	base xs:string		
facets	Kind	Value	Annotation
	enumeration	0211001	documentation keine relevante Voroperation
	enumeration	0211002	documentation Osteosynthese/Osteotomie (Femur)
	enumeration	0211003	documentation Osteosynthese/Osteotomie (Tibia)
	enumeration	0211004	documentation Osteosynthese/Osteotomie (Patella)
	enumeration	0211005	documentation Osteosynthese/Osteotomie (mehrere)
	enumeration	0211006	documentation Kapsel-/Bandapparat
	enumeration	0211007	documentation Arthrodese
	enumeration	0211042	documentation andere
annotation	documentation Kat_EP_VoroperationKnie		
source	<simpleType name="enum_0211"> <annotation> <documentation>Kat EP VoroperationKnie</documentation>		

```

</annotation>
<restriction base="xs:string">
  <enumeration value="0211001">
    <annotation>
      <documentation>keine relevante Voroperation</documentation>
    </annotation>
  </enumeration>
  <enumeration value="0211002">
    <annotation>
      <documentation>Osteosynthese/Osteotomie (Femur)</documentation>
    </annotation>
  </enumeration>
  <enumeration value="0211003">
    <annotation>
      <documentation>Osteosynthese/Osteotomie (Tibia)</documentation>
    </annotation>
  </enumeration>
  <enumeration value="0211004">
    <annotation>
      <documentation>Osteosynthese/Osteotomie (Patella)</documentation>
    </annotation>
  </enumeration>
  <enumeration value="0211005">
    <annotation>
      <documentation>Osteosynthese/Osteotomie (mehrere)</documentation>
    </annotation>
  </enumeration>
  <enumeration value="0211006">
    <annotation>
      <documentation>Kapsel-/Bandapparat</documentation>
    </annotation>
  </enumeration>
  <enumeration value="0211007">
    <annotation>
      <documentation>Arthrodesse</documentation>
    </annotation>
  </enumeration>
  <enumeration value="0211042">
    <annotation>
      <documentation>andere</documentation>
    </annotation>
  </enumeration>
</restriction>
</simpleType>

```

simpleType enum_0212

namespace	http://xml.ir-d.de/irdsaa		
type	restriction of string		
properties	base xs:string		
facets	Kind	Value	Annotation
	enumeration	0212001	documentation Hüfte
	enumeration	0212002	documentation Knie
	enumeration	0212003	documentation Totaler Femurersatz inkl. Durchsteck-Prothese

annotation	documentation Kat_EP_Gelenk
source	<pre> <simpleType name="enum_0212"> <annotation> <documentation>Kat_EP_Gelenk</documentation> </annotation> <restriction base="xs:string"> <enumeration value="0212001"> <annotation> <documentation>Hüfte</documentation> </annotation> </enumeration> <enumeration value="0212002"> <annotation> <documentation>Knie</documentation> </annotation> </enumeration> <enumeration value="0212003"> <annotation> <documentation>Totaler Femurersatz inkl. Durchsteck-Prothese</documentation> </annotation> </enumeration> </restriction> </simpleType> </pre>

simpleType enum_0220

namespace	http://xml.ir-d.de/irdsaa		
type	restriction of string		
properties	base xs:string		
facets	Kind	Value	Annotation
	enumeration	0220001	documentation anterior
	enumeration	0220002	documentation anterolateral
	enumeration	0220003	documentation lateral
	enumeration	0220004	documentation posterior
	enumeration	0220005	documentation posterolateral
	enumeration	0220006	documentation 2-Inzisionen-Zugang
	enumeration	0220042	documentation sonstiges/unbekannt
annotation	documentation Kat_EP_Operationszugang		
source	<pre> <simpleType name="enum_0220"> <annotation> <documentation>Kat_EP_Operationszugang</documentation> </annotation> <restriction base="xs:string"> <enumeration value="0220001"> <annotation> <documentation>anterior</documentation> </annotation> </enumeration> </restriction> </simpleType> </pre>		

	<pre> </enumeration> <enumeration value="0220002"> <annotation> <documentation>anterolateral</documentation> </annotation> </enumeration> <enumeration value="0220003"> <annotation> <documentation>lateral</documentation> </annotation> </enumeration> <enumeration value="0220004"> <annotation> <documentation>posterior</documentation> </annotation> </enumeration> <enumeration value="0220005"> <annotation> <documentation>posterolateral</documentation> </annotation> </enumeration> <enumeration value="0220006"> <annotation> <documentation>2-Inzisionen-Zugang</documentation> </annotation> </enumeration> <enumeration value="0220042"> <annotation> <documentation>sonstiges/unbekannt</documentation> </annotation> </enumeration> </restriction> </simpleType> </pre>
--	---

simpleType enum_0222

namespace	http://xml.lir-d.de/irdsaa		
type	restriction of string		
properties	base xs:string		
facets	Kind	Value	Annotation
	enumeration	0222001	documentation nein
	enumeration	0222002	documentation ja- Ausbau
	enumeration	0222003	documentation ja- Einbau
annotation	documentation Kat_EP_Zweizeitwechsel		
source	<pre> <simpleType name="enum_0222"> <annotation> <documentation>Kat_EP_Zweizeitwechsel</documentation> </annotation> <restriction base="xs:string"> <enumeration value="0222001"> <annotation> <documentation>nein</documentation> </annotation> </pre>		

```

</enumeration>
<enumeration value="0222002">
  <annotation>
    <documentation>ja- Ausbau</documentation>
  </annotation>
</enumeration>
<enumeration value="0222003">
  <annotation>
    <documentation>ja- Einbau</documentation>
  </annotation>
</enumeration>
</restriction>
</simpleType>

```

simpleType **enum_0230**

namespace	http://xml.ir-d.de/irdsaa		
type	restriction of string		
properties	base xs:string		
facets	Kind	Value	Annotation
	enumeration	0230001	documentation Smith & Nephew GmbH
	enumeration	0230002	documentation Mathys Orthopädie GmbH
	enumeration	0230003	documentation Ceramtec AG
	enumeration	0230004	documentation Biomet
	enumeration	0230005	documentation Peter Brehm GmbH
	enumeration	0230006	documentation Amplitude GmbH
	enumeration	0230007	documentation Exactech Deutschland
	enumeration	0230008	documentation Globus Medical
	enumeration	0230009	documentation Implantcast GmbH
	enumeration	0230010	documentation DePuy Orthopädie GmbH
	enumeration	0230011	documentation IO-International Orthopaedics
	enumeration	0230012	documentation Joint Replacement Ltd. Instrumentation
	enumeration	0230013	documentation Merete
	enumeration	0230014	documentation S&G Implants GmbH
	enumeration	0230015	documentation Speetec Implantate GmbH
	enumeration	0230016	documentation Stemcup Medical Products GmbH
	enumeration	0230017	documentation Symbios Deutschland GmbH
	enumeration	0230018	documentation Tantum AG
	enumeration	0230019	documentation Tornier GmbH
	enumeration	0230020	documentation MicroPort Orthopedics GmbH

	<p>enumeration 0230021 documentation aap Implanate AG</p> <p>enumeration 0230022 documentation AQImplants</p> <p>enumeration 0230023 documentation ESKA Orthodynamics GmbH</p> <p>enumeration 0230024 documentation Ateosos medical AG</p> <p>enumeration 0230025 documentation Chiropro GmbH</p> <p>enumeration 0230026 documentation Medacta</p> <p>enumeration 0230027 documentation OHST Medizintechnik AG</p> <p>enumeration 0230028 documentation Lima Deutschland GmbH</p> <p>enumeration 0230029 documentation alloPlus GmbH</p> <p>enumeration 0230030 documentation Heraeus Medical GmbH</p> <p>enumeration 0230031 documentation ImplanTec Deutschland GmbH</p> <p>enumeration 0230032 documentation Falcon Medical GmbH</p> <p>enumeration 0230033 documentation Meril GmbH</p> <p>enumeration 0230034 documentation Zimmer Germany GmbH</p> <p>enumeration 0230035 documentation Stryker GmbH & Co. KG</p> <p>enumeration 0230036 documentation Aesculap AG</p> <p>enumeration 0230037 documentation Waldemar Link GmbH & Co. KG</p> <p>enumeration 0230038 documentation Corin Germany GmbH</p> <p>enumeration 0230039 documentation nicht belegter Wert</p> <p>enumeration 0230040 documentation nicht belegter Wert</p> <p>enumeration 0230041 documentation nicht belegter Wert</p> <p>enumeration 0230042 documentation sonstige</p> <p>enumeration 0230043 documentation nicht belegter Wert</p> <p>enumeration 0230044 documentation nicht belegter Wert</p>
annotation	documentation Kat_EP_Hersteller
source	<pre> <simpleType name="enum_0230"> <annotation> <documentation>Kat_EP_Hersteller</documentation> </annotation> <restriction base="xs:string"> <enumeration value="0230001"> <annotation> <documentation>Smith & Nephew GmbH</documentation> </annotation> </enumeration> <enumeration value="0230002"> <annotation> <documentation>Mathys Orthopädie GmbH</documentation> </annotation> </enumeration> </restriction> </simpleType> </pre>

```
</annotation>
</enumeration>
<enumeration value="0230003">
  <annotation>
    <documentation>Ceramtec AG</documentation>
  </annotation>
</enumeration>
<enumeration value="0230004">
  <annotation>
    <documentation>Biomet</documentation>
  </annotation>
</enumeration>
<enumeration value="0230005">
  <annotation>
    <documentation>Peter Brehm GmbH</documentation>
  </annotation>
</enumeration>
<enumeration value="0230006">
  <annotation>
    <documentation>Amplitude GmbH</documentation>
  </annotation>
</enumeration>
<enumeration value="0230007">
  <annotation>
    <documentation>Exactech Deutschland</documentation>
  </annotation>
</enumeration>
<enumeration value="0230008">
  <annotation>
    <documentation>Globus Medical</documentation>
  </annotation>
</enumeration>
<enumeration value="0230009">
  <annotation>
    <documentation>Implantcast GmbH</documentation>
  </annotation>
</enumeration>
<enumeration value="0230010">
  <annotation>
    <documentation>DePuy Orthopädie GmbH</documentation>
  </annotation>
</enumeration>
<enumeration value="0230011">
  <annotation>
    <documentation>IO-International Orthopaedics</documentation>
  </annotation>
</enumeration>
<enumeration value="0230012">
  <annotation>
    <documentation>Joint Replacement Ltd. Instrumentation</documentation>
  </annotation>
</enumeration>
<enumeration value="0230013">
  <annotation>
    <documentation>Merete</documentation>
  </annotation>
</enumeration>
<enumeration value="0230014">
  <annotation>
```

```
<documentation>S&G Implants GmbH</documentation>
</annotation>
</enumeration>
<enumeration value="0230015">
  <annotation>
    <documentation>Speetec Implantate GmbH</documentation>
  </annotation>
</enumeration>
<enumeration value="0230016">
  <annotation>
    <documentation>Stemcup Medical Products GmbH</documentation>
  </annotation>
</enumeration>
<enumeration value="0230017">
  <annotation>
    <documentation>Symbios Deutschland GmbH</documentation>
  </annotation>
</enumeration>
<enumeration value="0230018">
  <annotation>
    <documentation>Tantum AG</documentation>
  </annotation>
</enumeration>
<enumeration value="0230019">
  <annotation>
    <documentation>Tornier GmbH</documentation>
  </annotation>
</enumeration>
<enumeration value="0230020">
  <annotation>
    <documentation>MicroPort Orthopedics GmbH</documentation>
  </annotation>
</enumeration>
<enumeration value="0230021">
  <annotation>
    <documentation>aap Implanate AG</documentation>
  </annotation>
</enumeration>
<enumeration value="0230022">
  <annotation>
    <documentation>AQImplants</documentation>
  </annotation>
</enumeration>
<enumeration value="0230023">
  <annotation>
    <documentation>ESKA Orthodynamics GmbH</documentation>
  </annotation>
</enumeration>
<enumeration value="0230024">
  <annotation>
    <documentation>Ateos medical AG</documentation>
  </annotation>
</enumeration>
<enumeration value="0230025">
  <annotation>
    <documentation>Chiropro GmbH</documentation>
  </annotation>
</enumeration>
<enumeration value="0230026">
```



```
<annotation>
  <documentation>Medacta</documentation>
</annotation>
</enumeration>
<enumeration value="0230027">
  <annotation>
    <documentation>OHST Medizintechnik AG</documentation>
  </annotation>
</enumeration>
<enumeration value="0230028">
  <annotation>
    <documentation>Lima Deutschland GmbH</documentation>
  </annotation>
</enumeration>
<enumeration value="0230029">
  <annotation>
    <documentation>alloPlus GmbH</documentation>
  </annotation>
</enumeration>
<enumeration value="0230030">
  <annotation>
    <documentation>Heraeus Medical GmbH</documentation>
  </annotation>
</enumeration>
<enumeration value="0230031">
  <annotation>
    <documentation>ImplanTec Deutschland GmbH</documentation>
  </annotation>
</enumeration>
<enumeration value="0230032">
  <annotation>
    <documentation>Falcon Medical GmbH</documentation>
  </annotation>
</enumeration>
<enumeration value="0230033">
  <annotation>
    <documentation>Meril GmbH</documentation>
  </annotation>
</enumeration>
<enumeration value="0230034">
  <annotation>
    <documentation>Zimmer Germany GmbH</documentation>
  </annotation>
</enumeration>
<enumeration value="0230035">
  <annotation>
    <documentation>Stryker GmbH & Co. KG</documentation>
  </annotation>
</enumeration>
<enumeration value="0230036">
  <annotation>
    <documentation>Aesculap AG</documentation>
  </annotation>
</enumeration>
<enumeration value="0230037">
  <annotation>
    <documentation>Waldemar Link GmbH & Co. KG</documentation>
  </annotation>
</enumeration>
```

```

<enumeration value="0230038">
  <annotation>
    <documentation>Corin Germany GmbH</documentation>
  </annotation>
</enumeration>
<enumeration value="0230039">
  <annotation>
    <documentation>nicht belegter Wert</documentation>
  </annotation>
</enumeration>
<enumeration value="0230040">
  <annotation>
    <documentation>nicht belegter Wert</documentation>
  </annotation>
</enumeration>
<enumeration value="0230041">
  <annotation>
    <documentation>nicht belegter Wert</documentation>
  </annotation>
</enumeration>
<enumeration value="0230042">
  <annotation>
    <documentation>sonstige</documentation>
  </annotation>
</enumeration>
<enumeration value="0230043">
  <annotation>
    <documentation>nicht belegter Wert</documentation>
  </annotation>
</enumeration>
<enumeration value="0230044">
  <annotation>
    <documentation>nicht belegter Wert</documentation>
  </annotation>
</enumeration>
</restriction>
</simpleType>

```

simpleType enum 0252

namespace	http://xml.ir-d.de/irdsaa		
type	restriction of string		
properties	base xs:string		
facets	Kind	Value	Annotation
	enumeration	0252001	documentation Pfanne
	enumeration	0252002	documentation Schaft
	enumeration	0252003	documentation beides
annotation	documentation Kat_EP_KomponenteHuefte		
source	<pre> <simpleType name="enum_0252"> <annotation> <documentation>Kat_EP_KomponenteHuefte</documentation> </annotation> <restriction base="xs:string"> </pre>		

	<pre> <enumeration value="0252001"> <annotation> <documentation>Pfanne</documentation> </annotation> </enumeration> <enumeration value="0252002"> <annotation> <documentation>Schaft</documentation> </annotation> </enumeration> <enumeration value="0252003"> <annotation> <documentation>beides</documentation> </annotation> </enumeration> </restriction> </simpleType> </pre>
--	---

simpleType enum 0254

namespace	http://xml.ir-d.de/irdsaa		
type	restriction of string		
properties	base xs:string		
facets	Kind	Value	Annotation
	enumeration	0254001	documentation Femur
	enumeration	0254002	documentation Tibia
	enumeration	0254003	documentation Patella
	enumeration	0254004	documentation mehrere
annotation	documentation Kat_EP_KomponenteKnie		
source	<pre> <simpleType name="enum_0254"> <annotation> <documentation>Kat_EP_KomponenteKnie</documentation> </annotation> <restriction base="xs:string"> <enumeration value="0254001"> <annotation> <documentation>Femur</documentation> </annotation> </enumeration> <enumeration value="0254002"> <annotation> <documentation>Tibia</documentation> </annotation> </enumeration> <enumeration value="0254003"> <annotation> <documentation>Patella</documentation> </annotation> </enumeration> <enumeration value="0254004"> <annotation> <documentation>mehrere</documentation> </annotation> </enumeration> </restriction> </simpleType> </pre>		

```

</annotation>
</enumeration>
</restriction>
</simpleType>

```

simpleType enum_0256

namespace	http://xml.ir-d.de/irdsaa		
type	restriction of string		
properties	base xs:string		
facets	Kind	Value	Annotation
	enumeration	0256001	documentation Pfanne
	enumeration	0256002	documentation Schaft
	enumeration	0256003	documentation Pfanne und Schaft
	enumeration	0256004	documentation Femur
	enumeration	0256005	documentation Tibia
	enumeration	0256006	documentation Patella
	enumeration	0256007	documentation mehrere
annotation	documentation Kat_EP_KomponenteTFE		
source	<pre> <simpleType name="enum_0256"> <annotation> <documentation>Kat_EP_KomponenteTFE</documentation> </annotation> <restriction base="xs:string"> <enumeration value="0256001"> <annotation> <documentation>Pfanne</documentation> </annotation> </enumeration> <enumeration value="0256002"> <annotation> <documentation>Schaft</documentation> </annotation> </enumeration> <enumeration value="0256003"> <annotation> <documentation>Pfanne und Schaft</documentation> </annotation> </enumeration> <enumeration value="0256004"> <annotation> <documentation>Femur</documentation> </annotation> </enumeration> <enumeration value="0256005"> <annotation> <documentation>Tibia</documentation> </annotation> </enumeration> </restriction> </simpleType> </pre>		

	<pre> <enumeration value="0256006"> <annotation> <documentation>Patella</documentation> </annotation> </enumeration> <enumeration value="0256007"> <annotation> <documentation>mehrere</documentation> </annotation> </enumeration> </restriction> </simpleType> </pre>
--	---

simpleType enum_0262

namespace	http://xml.ir-d.de/irdsaa		
type	restriction of string		
properties	base xs:string		
facets	Kind	Value	Annotation
	enumeration	0262001	documentation Pfanne
	enumeration	0262002	documentation Schaft
	enumeration	0262003	documentation Kopf
	enumeration	0262004	documentation Inlay
	enumeration	0262005	documentation Adapter
	enumeration	0262006	documentation mehrere
annotation	documentation Kat_EP_ImplantatbruchHuefte		
source	<pre> <simpleType name="enum_0262"> <annotation> <documentation>Kat_EP_ImplantatbruchHuefte</documentation> </annotation> <restriction base="xs:string"> <enumeration value="0262001"> <annotation> <documentation>Pfanne</documentation> </annotation> </enumeration> <enumeration value="0262002"> <annotation> <documentation>Schaft</documentation> </annotation> </enumeration> <enumeration value="0262003"> <annotation> <documentation>Kopf</documentation> </annotation> </enumeration> <enumeration value="0262004"> <annotation> <documentation>Inlay</documentation> </annotation> </enumeration> </restriction> </simpleType> </pre>		

	<pre> </enumeration> <enumeration value="0262005"> <annotation> <documentation>Adapter</documentation> </annotation> </enumeration> <enumeration value="0262006"> <annotation> <documentation>mehrere</documentation> </annotation> </enumeration> </restriction> </simpleType> </pre>
--	--

simpleType enum_0264

namespace	http://xml.ir-d.de/irdsaa		
type	restriction of string		
properties	base xs:string		
facets	Kind	Value	Annotation
	enumeration	0264001	documentation Femur
	enumeration	0264002	documentation Tibia
	enumeration	0264003	documentation Inlay
	enumeration	0264004	documentation Adapter
	enumeration	0264005	documentation Verlängerung
	enumeration	0264006	documentation Schrauben
	enumeration	0264007	documentation mehrere
	enumeration	0264042	documentation andere
annotation	documentation Kat_EP_ImplantatbruchKnie		
source	<pre> <simpleType name="enum_0264"> <annotation> <documentation>Kat_EP_ImplantatbruchKnie</documentation> </annotation> <restriction base="xs:string"> <enumeration value="0264001"> <annotation> <documentation>Femur</documentation> </annotation> </enumeration> <enumeration value="0264002"> <annotation> <documentation>Tibia</documentation> </annotation> </enumeration> <enumeration value="0264003"> <annotation> <documentation>Inlay</documentation> </annotation> </enumeration> </restriction> </simpleType> </pre>		

```

<enumeration value="0264004">
  <annotation>
    <documentation>Adapter</documentation>
  </annotation>
</enumeration>
<enumeration value="0264005">
  <annotation>
    <documentation>Verlängerung</documentation>
  </annotation>
</enumeration>
<enumeration value="0264006">
  <annotation>
    <documentation>Schrauben</documentation>
  </annotation>
</enumeration>
<enumeration value="0264007">
  <annotation>
    <documentation>mehrere</documentation>
  </annotation>
</enumeration>
<enumeration value="0264042">
  <annotation>
    <documentation>andere</documentation>
  </annotation>
</enumeration>
</restriction>
</simpleType>

```

simpleType enum_0266

namespace	http://xml.ir-d.de/irdsaa		
type	restriction of string		
properties	base	xs:string	
facets	Kind	Value	Annotation
	enumeration	0266001	documentation Pfanne
	enumeration	0266002	documentation Schaft
	enumeration	0266003	documentation Kopf
	enumeration	0266004	documentation Inlay
	enumeration	0266005	documentation Adapter
	enumeration	0266006	documentation Femur
	enumeration	0266007	documentation Tibia
	enumeration	0266008	documentation Verlängerung
	enumeration	0266009	documentation Schrauben
	enumeration	0266010	documentation mehrere
	enumeration	0266042	documentation andere
annotation	documentation Kat_EP_ImplantatbruchTFE		

source

```
<simpleType name="enum_0266">
  <annotation>
    <documentation>Kat_EP_ImplantatbruchTFE</documentation>
  </annotation>
  <restriction base="xs:string">
    <enumeration value="0266001">
      <annotation>
        <documentation>Pfanne</documentation>
      </annotation>
    </enumeration>
    <enumeration value="0266002">
      <annotation>
        <documentation>Schaft</documentation>
      </annotation>
    </enumeration>
    <enumeration value="0266003">
      <annotation>
        <documentation>Kopf</documentation>
      </annotation>
    </enumeration>
    <enumeration value="0266004">
      <annotation>
        <documentation>Inlay</documentation>
      </annotation>
    </enumeration>
    <enumeration value="0266005">
      <annotation>
        <documentation>Adapter</documentation>
      </annotation>
    </enumeration>
    <enumeration value="0266006">
      <annotation>
        <documentation>Femur</documentation>
      </annotation>
    </enumeration>
    <enumeration value="0266007">
      <annotation>
        <documentation>Tibia</documentation>
      </annotation>
    </enumeration>
    <enumeration value="0266008">
      <annotation>
        <documentation>Verlängerung</documentation>
      </annotation>
    </enumeration>
    <enumeration value="0266009">
      <annotation>
        <documentation>Schrauben</documentation>
      </annotation>
    </enumeration>
    <enumeration value="0266010">
      <annotation>
        <documentation>mehrere</documentation>
      </annotation>
    </enumeration>
    <enumeration value="0266042">
      <annotation>
        <documentation>andere</documentation>
      </annotation>
    </enumeration>
  </restriction>
</simpleType>
```

	<pre> </enumeration> </restriction> </simpleType> </pre>
--	--

simpleType enum_0270

namespace	http://xml.ir-d.de/irdsaa		
type	restriction of string		
properties	base xs:string		
facets	Kind	Value	Annotation
	enumeration	0270001	documentation PE-Inlay
	enumeration	0270002	documentation patellare Komponente
	enumeration	0270003	documentation beides
annotation	documentation Kat_EP_VerschleissKnie		
source	<pre> <simpleType name="enum_0270"> <annotation> <documentation>Kat_EP_VerschleissKnie</documentation> </annotation> <restriction base="xs:string"> <enumeration value="0270001"> <annotation> <documentation>PE-Inlay</documentation> </annotation> </enumeration> <enumeration value="0270002"> <annotation> <documentation>patellare Komponente</documentation> </annotation> </enumeration> <enumeration value="0270003"> <annotation> <documentation>beides</documentation> </annotation> </enumeration> </restriction> </simpleType> </pre>		

simpleType enum_0271

namespace	http://xml.ir-d.de/irdsaa		
type	restriction of string		
properties	base xs:string		
facets	Kind	Value	Annotation
	enumeration	0271001	documentation Schraube
	enumeration	0271002	documentation Inlay
	enumeration	0271003	documentation patellare Komponente
	enumeration	0271004	documentation Kopplung

	enumeration 0271005 documentation mehrere
	enumeration 0271042 documentation andere
annotation	documentation Kat_EP_MigrationKnie
source	<pre> <simpleType name="enum_0271"> <annotation> <documentation>Kat_EP_MigrationKnie</documentation> </annotation> <restriction base="xs:string"> <enumeration value="0271001"> <annotation> <documentation>Schraube</documentation> </annotation> </enumeration> <enumeration value="0271002"> <annotation> <documentation>Inlay</documentation> </annotation> </enumeration> <enumeration value="0271003"> <annotation> <documentation>patellare Komponente</documentation> </annotation> </enumeration> <enumeration value="0271004"> <annotation> <documentation>Kopplung</documentation> </annotation> </enumeration> <enumeration value="0271005"> <annotation> <documentation>mehrere</documentation> </annotation> </enumeration> <enumeration value="0271042"> <annotation> <documentation>andere</documentation> </annotation> </enumeration> </restriction> </simpleType> </pre>

simpleType enum_0290

namespace	http://xml.ir-d.de/irdsaa		
type	restriction of string		
properties	base xs:string		
facets	Kind	Value	Annotation
	enumeration	0290001	documentation Hüft-Komponente
	enumeration	0290002	documentation Knie-Komponente
	enumeration	0290003	documentation Modulare Komponente (Hüfte/Knie)

annotation	documentation Kat_EP_Artikeltyp
source	<pre> <simpleType name="enum_0290"> <annotation> <documentation>Kat_EP_Artikeltyp</documentation> </annotation> <restriction base="xs:string"> <enumeration value="0290001"> <annotation> <documentation>Hüft-Komponente</documentation> </annotation> </enumeration> <enumeration value="0290002"> <annotation> <documentation>Knie-Komponente</documentation> </annotation> </enumeration> <enumeration value="0290003"> <annotation> <documentation>Modulare Komponente (Hüfte/Knie)</documentation> </annotation> </enumeration> </restriction> </simpleType> </pre>

simpleType enum_0291

namespace	http://xml.ir-d.de/irdsaa		
type	restriction of string		
properties	base xs:string		
facets	Kind	Value	Annotation
	enumeration	0291001	documentation Knochen-Zement
	enumeration	0291002	documentation sonstiges Zubehör
annotation	documentation Kat_EP_ZubehoerTyp		
source	<pre> <simpleType name="enum_0291"> <annotation> <documentation>Kat_EP_ZubehoerTyp</documentation> </annotation> <restriction base="xs:string"> <enumeration value="0291001"> <annotation> <documentation>Knochen-Zement</documentation> </annotation> </enumeration> <enumeration value="0291002"> <annotation> <documentation>sonstiges Zubehör</documentation> </annotation> </enumeration> </restriction> </simpleType> </pre>		

simpleType enum_0300

namespace	http://xml.ir-d.de/irdsaa		
type	restriction of string		
properties	base xs:string		
facets	Kind	Value	Annotation
	enumeration	0300001	documentation konventieller Aortenklappenersatz
	enumeration	0300002	documentation kathetergestützte Aortenklappenimplantation (TAVI)
annotation	documentation Kat_AK_ArtEingriff		
source	<pre> <simpleType name="enum_0300"> <annotation> <documentation>Kat_AK_ArtEingriff</documentation> </annotation> <restriction base="xs:string"> <enumeration value="0300001"> <annotation> <documentation>konventieller Aortenklappenersatz</documentation> </annotation> </enumeration> <enumeration value="0300002"> <annotation> <documentation>kathetergestützte Aortenklappenimplantation (TAVI)</documentation> </annotation> </enumeration> </restriction> </simpleType> </pre>		

simpleType enum_0302

namespace	http://xml.ir-d.de/irdsaa		
type	restriction of string		
properties	base xs:string		
facets	Kind	Value	Annotation
	enumeration	0302001	documentation Stenose
	enumeration	0302002	documentation Insuffizienz
	enumeration	0302003	documentation Stenose und Insuffizienz
annotation	documentation Kat_AK_GrundEingriff		
source	<pre> <simpleType name="enum_0302"> <annotation> <documentation>Kat_AK_GrundEingriff</documentation> </annotation> <restriction base="xs:string"> <enumeration value="0302001"> <annotation> <documentation>Stenose</documentation> </annotation> </enumeration> <enumeration value="0302002"> </pre>		

	<pre> <annotation> <documentation>Insuffizienz</documentation> </annotation> </enumeration> <enumeration value="0302003"> <annotation> <documentation>Stenose und Insuffizienz</documentation> </annotation> </enumeration> </restriction> </simpleType> </pre>
--	---

simpleType enum_0318

namespace	http://xml.ir-d.de/irdsaa		
type	restriction of string		
properties	base xs:string		
facets	Kind	Value	Annotation
	enumeration	0318001	documentation transapikal
	enumeration	0318002	documentation transaortal
	enumeration	0318003	documentation transfemoral
	enumeration	0318004	documentation transaxillär
	enumeration	0318042	documentation anderer Zugangsweg
annotation	documentation Kat_AK_ZugangKatheter		
source	<pre> <simpleType name="enum_0318"> <annotation> <documentation>Kat_AK_ZugangKatheter</documentation> </annotation> <restriction base="xs:string"> <enumeration value="0318001"> <annotation> <documentation>transapikal</documentation> </annotation> </enumeration> <enumeration value="0318002"> <annotation> <documentation>transaortal</documentation> </annotation> </enumeration> <enumeration value="0318003"> <annotation> <documentation>transfemoral</documentation> </annotation> </enumeration> <enumeration value="0318004"> <annotation> <documentation>transaxillär</documentation> </annotation> </enumeration> <enumeration value="0318042"> <annotation> </pre>		

	<pre> <documentation>anderer Zugangsweg</documentation> </annotation> </enumeration> </restriction> </simpleType> </pre>
--	--

simpleType enum_0320

namespace	http://xml.ir-d.de/irdsaa		
type	restriction of string		
properties	base xs:string		
facets	Kind	Value	Annotation
	enumeration	0320001	documentation konventionelle Sternotomie
	enumeration	0320002	documentation partielle Sternotomie
	enumeration	0320003	documentation parasternaler Zugang
	enumeration	0320042	documentation anderer Zugangsweg
annotation	documentation Kat_AK_ZugangKonventionell		
source	<pre> <simpleType name="enum_0320"> <annotation> <documentation>Kat_AK_ZugangKonventionell</documentation> </annotation> <restriction base="xs:string"> <enumeration value="0320001"> <annotation> <documentation>konventionelle Sternotomie</documentation> </annotation> </enumeration> <enumeration value="0320002"> <annotation> <documentation>partielle Sternotomie</documentation> </annotation> </enumeration> <enumeration value="0320003"> <annotation> <documentation>parasternaler Zugang</documentation> </annotation> </enumeration> <enumeration value="0320042"> <annotation> <documentation>anderer Zugangsweg</documentation> </annotation> </enumeration> </restriction> </simpleType> </pre>		

simpleType enum_0322

namespace	http://xml.ir-d.de/irdsaa		
type	restriction of string		

properties	base xs:string																					
facets	<table border="1"> <thead> <tr> <th>Kind</th> <th>Value</th> <th>Annotation</th> </tr> </thead> <tbody> <tr> <td>enumeration</td> <td>0322001</td> <td>documentation nein</td> </tr> <tr> <td>enumeration</td> <td>0322002</td> <td>documentation ja, diätetisch behandelt</td> </tr> <tr> <td>enumeration</td> <td>0322003</td> <td>documentation ja, orale Medikation</td> </tr> <tr> <td>enumeration</td> <td>0322004</td> <td>documentation ja, mit Insulin behandelt</td> </tr> <tr> <td>enumeration</td> <td>0322005</td> <td>documentation ja, unbehandelt</td> </tr> <tr> <td>enumeration</td> <td>0322099</td> <td>documentation unbekannt</td> </tr> </tbody> </table>	Kind	Value	Annotation	enumeration	0322001	documentation nein	enumeration	0322002	documentation ja, diätetisch behandelt	enumeration	0322003	documentation ja, orale Medikation	enumeration	0322004	documentation ja, mit Insulin behandelt	enumeration	0322005	documentation ja, unbehandelt	enumeration	0322099	documentation unbekannt
Kind	Value	Annotation																				
enumeration	0322001	documentation nein																				
enumeration	0322002	documentation ja, diätetisch behandelt																				
enumeration	0322003	documentation ja, orale Medikation																				
enumeration	0322004	documentation ja, mit Insulin behandelt																				
enumeration	0322005	documentation ja, unbehandelt																				
enumeration	0322099	documentation unbekannt																				
annotation	documentation Kat_AK_Diabetes																					
source	<pre> <simpleType name="enum_0322"> <annotation> <documentation>Kat_AK_Diabetes</documentation> </annotation> <restriction base="xs:string"> <enumeration value="0322001"> <annotation> <documentation>nein</documentation> </annotation> </enumeration> <enumeration value="0322002"> <annotation> <documentation>ja, diätetisch behandelt</documentation> </annotation> </enumeration> <enumeration value="0322003"> <annotation> <documentation>ja, orale Medikation</documentation> </annotation> </enumeration> <enumeration value="0322004"> <annotation> <documentation>ja, mit Insulin behandelt</documentation> </annotation> </enumeration> <enumeration value="0322005"> <annotation> <documentation>ja, unbehandelt</documentation> </annotation> </enumeration> <enumeration value="0322099"> <annotation> <documentation>unbekannt</documentation> </annotation> </enumeration> </restriction> </simpleType> </pre>																					

simpleType enum_0324

namespace	http://xml.ir-d.de/irdsaa
-----------	---------------------------

type	restriction of string		
properties	base xs:string		
facets	Kind	Value	Annotation
	enumeration	0324001	documentation (I): Beschwerdefreiheit, normale körperliche Belastbarkeit
	enumeration	0324002	documentation (II): Beschwerden bei stärkerer körperlicher Belastung
	enumeration	0324003	documentation (III): Beschwerden bei leichter körperlicher Belastung
	enumeration	0324004	documentation (IV): Beschwerden in Ruhe
annotation	documentation Kat_AK_NYHA		
source	<pre> <simpleType name="enum_0324"> <annotation> <documentation>Kat_AK_NYHA</documentation> </annotation> <restriction base="xs:string"> <enumeration value="0324001"> <annotation> <documentation>(I): Beschwerdefreiheit, normale körperliche Belastbarkeit</documentation> </annotation> </enumeration> <enumeration value="0324002"> <annotation> <documentation>(II): Beschwerden bei stärkerer körperlicher Belastung</documentation> </annotation> </enumeration> <enumeration value="0324003"> <annotation> <documentation>(III): Beschwerden bei leichter körperlicher Belastung</documentation> </annotation> </enumeration> <enumeration value="0324004"> <annotation> <documentation>(IV): Beschwerden in Ruhe</documentation> </annotation> </enumeration> </restriction> </simpleType> </pre>		

simpleType **enum_0330**

namespace	http://xml.ir-d.de/irdsaa		
type	restriction of string		
properties	base xs:string		
facets	Kind	Value	Annotation
	enumeration	0330001	documentation ATS Medical
	enumeration	0330002	documentation Edwards Lifesciences
	enumeration	0330003	documentation Medtronic

	<p>enumeration 0330004 documentation JenaValve</p> <p>enumeration 0330005 documentation Corcym</p> <p>enumeration 0330006 documentation St.Jude Medical/Abbott</p> <p>enumeration 0330007 documentation Symetis</p> <p>enumeration 0330008 documentation Direct Flow Medical</p> <p>enumeration 0330009 documentation Boston Scientific</p> <p>enumeration 0330010 documentation nicht belegter Wert</p> <p>enumeration 0330011 documentation nicht belegter Wert</p> <p>enumeration 0330012 documentation nicht belegter Wert</p> <p>enumeration 0330013 documentation nicht belegter Wert</p> <p>enumeration 0330014 documentation nicht belegter Wert</p> <p>enumeration 0330042 documentation sonstiger Hersteller</p>
annotation	documentation Kat_AK_Hersteller
source	<pre> <simpleType name="enum_0330"> <annotation> <documentation>Kat_AK_Hersteller</documentation> </annotation> <restriction base="xs:string"> <enumeration value="0330001"> <annotation> <documentation>ATS Medical</documentation> </annotation> </enumeration> <enumeration value="0330002"> <annotation> <documentation>Edwards Lifesciences</documentation> </annotation> </enumeration> <enumeration value="0330003"> <annotation> <documentation>Medtronic</documentation> </annotation> </enumeration> <enumeration value="0330004"> <annotation> <documentation>JenaValve</documentation> </annotation> </enumeration> <enumeration value="0330005"> <annotation> <documentation>Corcym</documentation> </annotation> </enumeration> <enumeration value="0330006"> <annotation> <documentation>St.Jude Medical/Abbott</documentation> </annotation> </enumeration> </restriction> </simpleType> </pre>

```

<enumeration value="0330007">
  <annotation>
    <documentation>Symetis</documentation>
  </annotation>
</enumeration>
<enumeration value="0330008">
  <annotation>
    <documentation>Direct Flow Medical</documentation>
  </annotation>
</enumeration>
<enumeration value="0330009">
  <annotation>
    <documentation>Boston Scientific</documentation>
  </annotation>
</enumeration>
<enumeration value="0330010">
  <annotation>
    <documentation>nicht belegter Wert</documentation>
  </annotation>
</enumeration>
<enumeration value="0330011">
  <annotation>
    <documentation>nicht belegter Wert</documentation>
  </annotation>
</enumeration>
<enumeration value="0330012">
  <annotation>
    <documentation>nicht belegter Wert</documentation>
  </annotation>
</enumeration>
<enumeration value="0330013">
  <annotation>
    <documentation>nicht belegter Wert</documentation>
  </annotation>
</enumeration>
<enumeration value="0330014">
  <annotation>
    <documentation>nicht belegter Wert</documentation>
  </annotation>
</enumeration>
<enumeration value="0330042">
  <annotation>
    <documentation>sonstiger Hersteller</documentation>
  </annotation>
</enumeration>
</restriction>
</simpleType>

```

simpleType enum_0338

namespace	http://xml.ir-d.de/irdsaa		
type	restriction of string		
properties	base xs:string		
facets	Kind	Value	Annotation
	enumeration	0338001	documentation LAD
	enumeration	0338002	documentation

	enumeration 0338003 RCA documentation RCX enumeration 0338004 documentation Hauptstamm
annotation	documentation Kat_AK_PCIArterien
source	<pre> <simpleType name="enum_0338"> <annotation> <documentation>Kat_AK_PCIArterien</documentation> </annotation> <restriction base="xs:string"> <enumeration value="0338001"> <annotation> <documentation>LAD</documentation> </annotation> </enumeration> <enumeration value="0338002"> <annotation> <documentation>RCA</documentation> </annotation> </enumeration> <enumeration value="0338003"> <annotation> <documentation>RCX</documentation> </annotation> </enumeration> <enumeration value="0338004"> <annotation> <documentation>Hauptstamm</documentation> </annotation> </enumeration> </restriction> </simpleType> </pre>

simpleType enum_0339

namespace	http://xml.ir-d.de/irdsaa		
type	restriction of string		
properties	base xs:string		
facets	Kind	Value	Annotation
	enumeration	0339001	documentation TEE
	enumeration	0339002	documentation CT
	enumeration	0339042	documentation andere
annotation	documentation Kat_AK_AnnulusMessmethode		
source	<pre> <simpleType name="enum_0339"> <annotation> <documentation>Kat_AK_AnnulusMessmethode</documentation> </annotation> <restriction base="xs:string"> <enumeration value="0339001"> <annotation> <documentation>TEE</documentation> </annotation> </enumeration> </restriction> </simpleType> </pre>		

	<pre> </annotation> </enumeration> <enumeration value="0339002"> <annotation> <documentation>CT</documentation> </annotation> </enumeration> <enumeration value="0339042"> <annotation> <documentation>andere</documentation> </annotation> </enumeration> </restriction> </simpleType> </pre>
--	--

simpleType enum_0341

namespace	http://xml.lir-d.de/irdsaa		
type	restriction of string		
properties	base xs:string		
facets	Kind	Value	Annotation
	enumeration	0341001	documentation intraprozedural verstorben
	enumeration	0341002	documentation Implantation von mehr als einer Prothese
	enumeration	0341003	documentation gravierende Gefäß- oder Zugangskomplikation (gemäß VARC-3)
	enumeration	0341004	documentation erforderlicher chirurgischer oder interventioneller Eingriff wegen einer Klappenfehlfunktion (gemäß VARC-3)
	enumeration	0341005	documentation >= große strukturelle kardiale Komplikation (gemäß VARC-3)
annotation	documentation Kat_AK_FailureGrund		
source	<pre> <simpleType name="enum_0341"> <annotation> <documentation>Kat_AK_FailureGrund</documentation> </annotation> <restriction base="xs:string"> <enumeration value="0341001"> <annotation> <documentation>intraprozedural verstorben</documentation> </annotation> </enumeration> <enumeration value="0341002"> <annotation> <documentation>Implantation von mehr als einer Prothese</documentation> </annotation> </enumeration> <enumeration value="0341003"> <annotation> <documentation>gravierende Gefäß- oder Zugangskomplikation (gemäß VARC-3)</documentation> </annotation> </enumeration> <enumeration value="0341004"> <annotation> </pre>		

	<pre> <documentation>erforderlicher chirurgischer oder interventioneller Eingriff wegen einer Klappenfehlfunktion (gemäß VARC-3)</documentation> </annotation> </enumeration> <enumeration value="0341005"> <annotation> <documentation>&gt;= große strukturelle kardiale Komplikation (gemäß VARC-3)</documentation> </annotation> </enumeration> </restriction> </simpleType> </pre>
--	--

simpleType enum_0342

namespace	http://xml.ir-d.de/irdsaa		
type	restriction of string		
properties	base xs:string		
facets	Kind	Value	Annotation
	enumeration	0342001	documentation Alter
	enumeration	0342002	documentation Frailty
	enumeration	0342003	documentation Hochrisiko
	enumeration	0342004	documentation Prognose-limitierende Zweiterkrankung
	enumeration	0342005	documentation Porzellan-Aorta
	enumeration	0342042	documentation Sonstige
annotation	documentation Kat_AK_Tavi		
source	<pre> <simpleType name="enum_0342"> <annotation> <documentation>Kat_AK_Tavi</documentation> </annotation> <restriction base="xs:string"> <enumeration value="0342001"> <annotation> <documentation>Alter</documentation> </annotation> </enumeration> <enumeration value="0342002"> <annotation> <documentation>Frailty</documentation> </annotation> </enumeration> <enumeration value="0342003"> <annotation> <documentation>Hochrisiko</documentation> </annotation> </enumeration> <enumeration value="0342004"> <annotation> <documentation>Prognose-limitierende Zweiterkrankung</documentation> </annotation> </enumeration> </restriction> </simpleType> </pre>		

```

</enumeration>
<enumeration value="0342005">
  <annotation>
    <documentation>Porzellan-Aorta</documentation>
  </annotation>
</enumeration>
<enumeration value="0342042">
  <annotation>
    <documentation>Sonstige</documentation>
  </annotation>
</enumeration>
</restriction>
</simpleType>

```

simpleType **enum_0343**

namespace	http://xml.ir-d.de/irdsaa		
type	restriction of string		
properties	base xs:string		
facets	Kind	Value	Annotation
	enumeration	0343001	documentation Device-Fehlpositionierung
	enumeration	0343002	documentation Koronarostienverschluss
	enumeration	0343003	documentation Aortendissektion
	enumeration	0343004	documentation Aortenregurgitation > = 2. Grades
	enumeration	0343005	documentation Annulus-Ruptur
	enumeration	0343006	documentation Ruptur-/Perforation einer Herzhöhle ohne Therapiebedarf
	enumeration	0343007	documentation Ruptur-/Perforation einer Herzhöhle mit Therapiebedarf
	enumeration	0343008	documentation Perikardtamponade
	enumeration	0343009	documentation kardiale Dekompensation
	enumeration	0343010	documentation Himembolie
	enumeration	0343011	documentation Rhythmusstörungen
	enumeration	0343012	documentation Device-Embolisation
	enumeration	0343013	documentation vaskuläre Komplikation
	enumeration	0343014	documentation Low Cardiac Output
	enumeration	0343015	documentation schwerwiegende Blutungen (intraprozedural)
	enumeration	0343016	documentation lebensbedrohliche Blutungen (intraprozedural)
	enumeration	0343017	documentation Patient verstarb im OP/Katheterlabor
	enumeration	0343042	documentation sonstige intraprozedurale Komplikationen
annotation	documentation Kat_AK_KomplikationTyp		
source	<simpleType name="enum_0343">		

```

<annotation>
  <documentation>Kat_AK_KomplikationTyp</documentation>
</annotation>
<restriction base="xs:string">
  <enumeration value="0343001">
    <annotation>
      <documentation>Device-Fehlpositionierung</documentation>
    </annotation>
  </enumeration>
  <enumeration value="0343002">
    <annotation>
      <documentation>Koronarostienverschluss</documentation>
    </annotation>
  </enumeration>
  <enumeration value="0343003">
    <annotation>
      <documentation>Aortendissektion</documentation>
    </annotation>
  </enumeration>
  <enumeration value="0343004">
    <annotation>
      <documentation>Aortenregurgitation &gt; = 2. Grades</documentation>
    </annotation>
  </enumeration>
  <enumeration value="0343005">
    <annotation>
      <documentation>Annulus-Ruptur</documentation>
    </annotation>
  </enumeration>
  <enumeration value="0343006">
    <annotation>
      <documentation>Ruptur-/Perforation einer Herzhöhle ohne
Therapiebedarf</documentation>
    </annotation>
  </enumeration>
  <enumeration value="0343007">
    <annotation>
      <documentation>Ruptur-/Perforation einer Herzhöhle mit
Therapiebedarf</documentation>
    </annotation>
  </enumeration>
  <enumeration value="0343008">
    <annotation>
      <documentation>Perikardtamponade</documentation>
    </annotation>
  </enumeration>
  <enumeration value="0343009">
    <annotation>
      <documentation>kardiale Dekompensation</documentation>
    </annotation>
  </enumeration>
  <enumeration value="0343010">
    <annotation>
      <documentation>Hirnembolie</documentation>
    </annotation>
  </enumeration>
  <enumeration value="0343011">
    <annotation>
      <documentation>Rhythmusstörungen</documentation>
    </annotation>
  </enumeration>

```

```

</annotation>
</enumeration>
<enumeration value="0343012">
  <annotation>
    <documentation>Device-Embolisation</documentation>
  </annotation>
</enumeration>
<enumeration value="0343013">
  <annotation>
    <documentation>vaskuläre Komplikation</documentation>
  </annotation>
</enumeration>
<enumeration value="0343014">
  <annotation>
    <documentation>Low Cardiac Output</documentation>
  </annotation>
</enumeration>
<enumeration value="0343015">
  <annotation>
    <documentation>schwerwiegende Blutungen
(intraprozedural)</documentation>
  </annotation>
</enumeration>
<enumeration value="0343016">
  <annotation>
    <documentation>lebensbedrohliche Blutungen
(intraprozedural)</documentation>
  </annotation>
</enumeration>
<enumeration value="0343017">
  <annotation>
    <documentation>Patient verstarb im OP/Katheterlabor</documentation>
  </annotation>
</enumeration>
<enumeration value="0343042">
  <annotation>
    <documentation>sonstige intraprozedurale
Komplikationen</documentation>
  </annotation>
</enumeration>
</restriction>
</simpleType>

```

simpleType enum_0346

namespace	http://xml.ir-d.de/irdsaa		
type	restriction of string		
properties	base xs:string		
facets	Kind	Value	Annotation
	enumeration	0346001	documentation keine Therapie erforderlich
	enumeration	0346002	documentation medikamentös
	enumeration	0346003	documentation IABP
	enumeration	0346004	documentation VAD

	enumeration 0346005 documentation ECMO enumeration 0346042 documentation sonstige
annotation	documentation Kat_AK_TherapieLCO
source	<pre> <simpleType name="enum_0346"> <annotation> <documentation>Kat_AK_TherapieLCO</documentation> </annotation> <restriction base="xs:string"> <enumeration value="0346001"> <annotation> <documentation>keine Therapie erforderlich</documentation> </annotation> </enumeration> <enumeration value="0346002"> <annotation> <documentation>medikamentös</documentation> </annotation> </enumeration> <enumeration value="0346003"> <annotation> <documentation>IABP</documentation> </annotation> </enumeration> <enumeration value="0346004"> <annotation> <documentation>VAD</documentation> </annotation> </enumeration> <enumeration value="0346005"> <annotation> <documentation>ECMO</documentation> </annotation> </enumeration> <enumeration value="0346042"> <annotation> <documentation>sonstige</documentation> </annotation> </enumeration> </restriction> </simpleType> </pre>

simpleType enum_0347

namespace	http://xml.ir-d.de/irdsaa		
type	restriction of string		
properties	base xs:string		
facets	Kind	Value	Annotation
	enumeration	0347001	documentation Einzeleingriff
	enumeration	0347002	documentation Kombinationseingriff mit mehreren Prozeduren
annotation	documentation Kat_AK_Eingriffsumfang		

source	<pre> <simpleType name="enum_0347"> <annotation> <documentation>Kat_AK_Eingriffsumfang</documentation> </annotation> <restriction base="xs:string"> <enumeration value="0347001"> <annotation> <documentation>Einzeleingriff</documentation> </annotation> </enumeration> <enumeration value="0347002"> <annotation> <documentation>Kombinationseingriff mit mehreren Prozeduren</documentation> </annotation> </enumeration> </restriction> </simpleType> </pre>
--------	---

simpleType enum_0348

namespace	http://xml.ir-d.de/irdsaa		
type	restriction of string		
properties	base xs:string		
facets	Kind	Value	Annotation
	enumeration	0348001	documentation mit HLM
	enumeration	0348002	documentation ohne HLM
	enumeration	0348003	documentation Umstieg von OP ohne HLM auf OP mit HLM
annotation	documentation Kat_AK_OPVorgehen		
source	<pre> <simpleType name="enum_0348"> <annotation> <documentation>Kat_AK_OPVorgehen</documentation> </annotation> <restriction base="xs:string"> <enumeration value="0348001"> <annotation> <documentation>mit HLM</documentation> </annotation> </enumeration> <enumeration value="0348002"> <annotation> <documentation>ohne HLM</documentation> </annotation> </enumeration> <enumeration value="0348003"> <annotation> <documentation>Umstieg von OP ohne HLM auf OP mit HLM</documentation> </annotation> </enumeration> </restriction> </simpleType> </pre>		

simpleType enum_0350

namespace	http://xml.ir-d.de/irdsaa		
type	restriction of string		
properties	base xs:string		
facets	Kind	Value	Annotation
	enumeration	0350001	documentation IABP
	enumeration	0350002	documentation Impella
	enumeration	0350003	documentation vv ECMO
	enumeration	0350004	documentation va ECMO
	enumeration	0350042	documentation andere
annotation	documentation Kat_AK_Methode		
source	<pre> <simpleType name="enum_0350"> <annotation> <documentation>Kat_AK_Methode</documentation> </annotation> <restriction base="xs:string"> <enumeration value="0350001"> <annotation> <documentation>IABP</documentation> </annotation> </enumeration> <enumeration value="0350002"> <annotation> <documentation>Impella</documentation> </annotation> </enumeration> <enumeration value="0350003"> <annotation> <documentation>vv ECMO</documentation> </annotation> </enumeration> <enumeration value="0350004"> <annotation> <documentation>va ECMO</documentation> </annotation> </enumeration> <enumeration value="0350042"> <annotation> <documentation>andere</documentation> </annotation> </enumeration> </restriction> </simpleType> </pre>		

simpleType enum_0351

namespace	http://xml.ir-d.de/irdsaa
type	restriction of string

properties	base xs:string																											
facets	<table border="1"> <thead> <tr> <th>Kind</th> <th>Value</th> <th>Annotation</th> </tr> </thead> <tbody> <tr> <td>enumeration</td> <td>0351001</td> <td>documentation nein</td> </tr> <tr> <td>enumeration</td> <td>0351002</td> <td>documentation ja, zu Sternotomie</td> </tr> <tr> <td>enumeration</td> <td>0351003</td> <td>documentation ja, zu transapikal</td> </tr> <tr> <td>enumeration</td> <td>0351004</td> <td>documentation ja, zu transaortal</td> </tr> <tr> <td>enumeration</td> <td>0351005</td> <td>documentation ja, zu transfemoral</td> </tr> <tr> <td>enumeration</td> <td>0351006</td> <td>documentation ja, zu transaxillär</td> </tr> <tr> <td>enumeration</td> <td>0351007</td> <td>documentation ja, zu anderem endovaskulären Zugang</td> </tr> <tr> <td>enumeration</td> <td>0351042</td> <td>documentation ja, zu anderem Zugang</td> </tr> </tbody> </table>	Kind	Value	Annotation	enumeration	0351001	documentation nein	enumeration	0351002	documentation ja, zu Sternotomie	enumeration	0351003	documentation ja, zu transapikal	enumeration	0351004	documentation ja, zu transaortal	enumeration	0351005	documentation ja, zu transfemoral	enumeration	0351006	documentation ja, zu transaxillär	enumeration	0351007	documentation ja, zu anderem endovaskulären Zugang	enumeration	0351042	documentation ja, zu anderem Zugang
Kind	Value	Annotation																										
enumeration	0351001	documentation nein																										
enumeration	0351002	documentation ja, zu Sternotomie																										
enumeration	0351003	documentation ja, zu transapikal																										
enumeration	0351004	documentation ja, zu transaortal																										
enumeration	0351005	documentation ja, zu transfemoral																										
enumeration	0351006	documentation ja, zu transaxillär																										
enumeration	0351007	documentation ja, zu anderem endovaskulären Zugang																										
enumeration	0351042	documentation ja, zu anderem Zugang																										
annotation	documentation Kat_AK_Konversion																											
source	<pre> <simpleType name="enum_0351"> <annotation> <documentation>Kat_AK_Konversion</documentation> </annotation> <restriction base="xs:string"> <enumeration value="0351001"> <annotation> <documentation>nein</documentation> </annotation> </enumeration> <enumeration value="0351002"> <annotation> <documentation>ja, zu Sternotomie</documentation> </annotation> </enumeration> <enumeration value="0351003"> <annotation> <documentation>ja, zu transapikal</documentation> </annotation> </enumeration> <enumeration value="0351004"> <annotation> <documentation>ja, zu transaortal</documentation> </annotation> </enumeration> <enumeration value="0351005"> <annotation> <documentation>ja, zu transfemoral</documentation> </annotation> </enumeration> <enumeration value="0351006"> <annotation> <documentation>ja, zu transaxillär</documentation> </annotation> </enumeration> <enumeration value="0351007"> <annotation> <documentation>ja, zu anderem endovaskulären Zugang</documentation> </annotation> </enumeration> </restriction> </simpleType> </pre>																											

	<pre> <enumeration value="0351042"> <annotation> <documentation>ja, zu anderem Zugang</documentation> </annotation> </enumeration> </restriction> </simpleType> </pre>
--	--

simpleType enum_0352

namespace	http://xml.ir-d.de/irdsaa		
type	restriction of string		
properties	base xs:string		
facets	Kind	Value	Annotation
	enumeration	0352001	documentation nein
	enumeration	0352002	documentation ja, Intubationsnarkose
	enumeration	0352003	documentation ja, Maskenbeatmung, incl. LAMA
	enumeration	0352042	documentation ja, unbekannt welche
annotation	documentation Kat_AK_Anaesthesie		
source	<pre> <simpleType name="enum_0352"> <annotation> <documentation>Kat_AK_Anaesthesie</documentation> </annotation> <restriction base="xs:string"> <enumeration value="0352001"> <annotation> <documentation>nein</documentation> </annotation> </enumeration> <enumeration value="0352002"> <annotation> <documentation>ja, Intubationsnarkose</documentation> </annotation> </enumeration> <enumeration value="0352003"> <annotation> <documentation>ja, Maskenbeatmung, incl. LAMA</documentation> </annotation> </enumeration> <enumeration value="0352042"> <annotation> <documentation>ja, unbekannt welche</documentation> </annotation> </enumeration> </restriction> </simpleType> </pre>		

simpleType enum_0353

namespace	http://xml.ir-d.de/irdsaa
-----------	---------------------------

type	restriction of string		
properties	base xs:string		
facets	Kind	Value	Annotation
	enumeration	0353001	documentation keine
	enumeration	0353002	documentation leichtgradig
	enumeration	0353003	documentation mittelgradig
	enumeration	0353004	documentation hochgradig
	enumeration	0353099	documentation nicht bestimmbar
annotation	documentation Kat_AK_ResidualeArteninsuffizienz		
source	<pre> <simpleType name="enum_0353"> <annotation> <documentation>Kat_AK_ResidualeArteninsuffizienz</documentation> </annotation> <restriction base="xs:string"> <enumeration value="0353001"> <annotation> <documentation>keine</documentation> </annotation> </enumeration> <enumeration value="0353002"> <annotation> <documentation>leichtgradig</documentation> </annotation> </enumeration> <enumeration value="0353003"> <annotation> <documentation>mittelgradig</documentation> </annotation> </enumeration> <enumeration value="0353004"> <annotation> <documentation>hochgradig</documentation> </annotation> </enumeration> <enumeration value="0353099"> <annotation> <documentation>nicht bestimmbar</documentation> </annotation> </enumeration> </restriction> </simpleType> </pre>		

simpleType **enum_0354**

namespace	http://xml.ir-d.de/irdsaa		
type	restriction of string		
properties	base xs:string		
facets	Kind	Value	Annotation
	enumeration	0354001	documentation chirurgisch-offen

	enumeration 0354002 documentation Verschluss-System enumeration 0354042 documentation sonstige
annotation	documentation Kat_AK_Zugangswegverschluss
source	<pre> <simpleType name="enum_0354"> <annotation> <documentation>Kat_AK_Zugangswegverschluss</documentation> </annotation> <restriction base="xs:string"> <enumeration value="0354001"> <annotation> <documentation>chirurgisch-offen</documentation> </annotation> </enumeration> <enumeration value="0354002"> <annotation> <documentation>Verschluss-System</documentation> </annotation> </enumeration> <enumeration value="0354042"> <annotation> <documentation>sonstige</documentation> </annotation> </enumeration> </restriction> </simpleType> </pre>

simpleType enum 0357

namespace	http://xml.ir-d.de/irdsaa		
type	restriction of string		
properties	base xs:string		
facets	Kind	Value	Annotation
	enumeration	0357001	documentation keine KHK
	enumeration	0357002	documentation 1-Gefäßerkrankung
	enumeration	0357003	documentation 2-Gefäßerkrankung
	enumeration	0357004	documentation 3-Gefäßerkrankung
	enumeration	0357005	documentation keine koronare Bildgebung
annotation	documentation Kat_AK_BefundBildgebung		
source	<pre> <simpleType name="enum_0357"> <annotation> <documentation>Kat_AK_BefundBildgebung</documentation> </annotation> <restriction base="xs:string"> <enumeration value="0357001"> <annotation> <documentation>keine KHK</documentation> </annotation> </enumeration> </pre>		

	<pre> <enumeration value="0357002"> <annotation> <documentation>1-Gefäßerkrankung</documentation> </annotation> </enumeration> <enumeration value="0357003"> <annotation> <documentation>2-Gefäßerkrankung</documentation> </annotation> </enumeration> <enumeration value="0357004"> <annotation> <documentation>3-Gefäßerkrankung</documentation> </annotation> </enumeration> <enumeration value="0357005"> <annotation> <documentation>keine koronare Bildgebung</documentation> </annotation> </enumeration> </restriction> </simpleType> </pre>
--	---

simpleType enum_0358

namespace	http://xml.ir-d.de/irdsaa		
type	restriction of string		
properties	base xs:string		
facets	Kind	Value	Annotation
	enumeration	0358001	documentation 0
	enumeration	0358002	documentation 1
	enumeration	0358003	documentation 2
	enumeration	0358004	documentation 3
	enumeration	0358005	documentation 4
	enumeration	0358006	documentation 5 oder mehr
	enumeration	0358098	documentation genaue Anzahl unbekannt (aber mind. 1)
	enumeration	0358099	documentation unbekannt
annotation	documentation Kat_AK_AnzahlVorOP		
source	<pre> <simpleType name="enum_0358"> <annotation> <documentation>Kat_AK_AnzahlVorOP</documentation> </annotation> <restriction base="xs:string"> <enumeration value="0358001"> <annotation> <documentation>0</documentation> </annotation> </enumeration> <enumeration value="0358002"> </pre>		

```

    <annotation>
      <documentation>1</documentation>
    </annotation>
  </enumeration>
  <enumeration value="0358003">
    <annotation>
      <documentation>2</documentation>
    </annotation>
  </enumeration>
  <enumeration value="0358004">
    <annotation>
      <documentation>3</documentation>
    </annotation>
  </enumeration>
  <enumeration value="0358005">
    <annotation>
      <documentation>4</documentation>
    </annotation>
  </enumeration>
  <enumeration value="0358006">
    <annotation>
      <documentation>5 oder mehr</documentation>
    </annotation>
  </enumeration>
  <enumeration value="0358098">
    <annotation>
      <documentation>genaue Anzahl unbekannt (aber mind. 1)</documentation>
    </annotation>
  </enumeration>
  <enumeration value="0358099">
    <annotation>
      <documentation>unbekannt</documentation>
    </annotation>
  </enumeration>
</restriction>
</simpleType>

```

simpleType enum 0359

namespace	http://xml.ir-d.de/irdsaa		
type	restriction of string		
properties	base xs:string		
facets	Kind	Value	Annotation
	enumeration	0359001	documentation nein
	enumeration	0359002	documentation ja - einseitig
	enumeration	0359003	documentation ja - beidseitig
	enumeration	0359042	documentation unbekannt
annotation	documentation Kat_AK_LVOT		
source	<pre> <simpleType name="enum_0359"> <annotation> <documentation>Kat_AK_LVOT</documentation> </annotation> </pre>		

	<pre> <restriction base="xs:string"> <enumeration value="0359001"> <annotation> <documentation>nein</documentation> </annotation> </enumeration> <enumeration value="0359002"> <annotation> <documentation>ja - einseitig</documentation> </annotation> </enumeration> <enumeration value="0359003"> <annotation> <documentation>ja - beidseitig</documentation> </annotation> </enumeration> <enumeration value="0359042"> <annotation> <documentation>unbekannt</documentation> </annotation> </enumeration> </restriction> </simpleType> </pre>
--	--

simpleType enum_0360

namespace	http://xml.ir-d.de/irdsaa		
type	restriction of string		
properties	base xs:string		
facets	Kind	Value	Annotation
	enumeration	0360001	documentation keine
	enumeration	0360002	documentation leichtgradig
	enumeration	0360003	documentation mittelgradig
	enumeration	0360004	documentation hochgradig
	enumeration	0360005	documentation massive
	enumeration	0360006	documentation torrential
	enumeration	0360099	documentation unbekannt
annotation	documentation Kat_AK_TriskupidalInsuffizienz		
source	<pre> <simpleType name="enum_0360"> <annotation> <documentation>Kat_AK_TriskupidalInsuffizienz</documentation> </annotation> <restriction base="xs:string"> <enumeration value="0360001"> <annotation> <documentation>keine</documentation> </annotation> </enumeration> <enumeration value="0360002"> </pre>		

	<pre> <annotation> <documentation>leichtgradig</documentation> </annotation> </enumeration> <enumeration value="0360003"> <annotation> <documentation>mittelgradig</documentation> </annotation> </enumeration> <enumeration value="0360004"> <annotation> <documentation>hochgradig</documentation> </annotation> </enumeration> <enumeration value="0360005"> <annotation> <documentation>massive</documentation> </annotation> </enumeration> <enumeration value="0360006"> <annotation> <documentation>torrential</documentation> </annotation> </enumeration> <enumeration value="0360099"> <annotation> <documentation>unbekannt</documentation> </annotation> </enumeration> </restriction> </simpleType> </pre>
--	---

simpleType enum_0361

namespace	http://xml.ir-d.de/irdsaa		
type	restriction of string		
properties	base xs:string		
facets	Kind	Value	Annotation
	enumeration	0361001	documentation nein
	enumeration	0361002	documentation ja, letzte(r) innerhalb der letzten 48 Stunden
	enumeration	0361003	documentation ja, letzte(r) innerhalb der letzten 21 Tage
	enumeration	0361004	documentation ja, letzte(r) länger als 21 Tage
	enumeration	0361098	documentation ja, letzter Zeitpunkt unbekannt
	enumeration	0361099	documentation unbekannt
annotation	documentation Kat_AK_SchockReanimation		
source	<pre> <simpleType name="enum_0361"> <annotation> <documentation>Kat_AK_SchockReanimation</documentation> </annotation> <restriction base="xs:string"> </pre>		

	<pre> <enumeration value="0361001"> <annotation> <documentation>nein</documentation> </annotation> </enumeration> <enumeration value="0361002"> <annotation> <documentation>ja, letzte(r) innerhalb der letzten 48 Stunden</documentation> </annotation> </enumeration> <enumeration value="0361003"> <annotation> <documentation>ja, letzte(r) innerhalb der letzten 21 Tage</documentation> </annotation> </enumeration> <enumeration value="0361004"> <annotation> <documentation>ja, letzte(r) länger als 21 Tage</documentation> </annotation> </enumeration> <enumeration value="0361098"> <annotation> <documentation>ja, letzter Zeitpunkt unbekannt</documentation> </annotation> </enumeration> <enumeration value="0361099"> <annotation> <documentation>unbekannt</documentation> </annotation> </enumeration> </restriction> </simpleType> </pre>
--	--

simpleType enum 0362

namespace	http://xml.lir-d.de/irdsaa		
type	restriction of string		
properties	base xs:string		
facets	Kind	Value	Annotation
	enumeration	0362001	documentation Sinusrhythmus
	enumeration	0362002	documentation Vorhofflimmern
	enumeration	0362042	documentation anderer Herzrhythmus
annotation	documentation Kat_AK_Herzrhythmus		
source	<pre> <simpleType name="enum_0362"> <annotation> <documentation>Kat_AK_Herzrhythmus</documentation> </annotation> <restriction base="xs:string"> <enumeration value="0362001"> <annotation> <documentation>Sinusrhythmus</documentation> </pre>		

	<pre> </annotation> </enumeration> <enumeration value="0362002"> <annotation> <documentation>Vorhofflimmern</documentation> </annotation> </enumeration> <enumeration value="0362042"> <annotation> <documentation>anderer Herzrhythmus</documentation> </annotation> </enumeration> </restriction> </simpleType> </pre>
--	--

simpleType enum_0363

namespace	http://xml.lir-d.de/irdsaa		
type	restriction of string		
properties	base xs:string		
facets	Kind	Value	Annotation
	enumeration	0363001	documentation nein
	enumeration	0363002	documentation paroxysmal
	enumeration	0363003	documentation persistierend
	enumeration	0363004	documentation permanent
annotation	documentation Kat_AK_Vorhofflimmern		
source	<pre> <simpleType name="enum_0363"> <annotation> <documentation>Kat_AK_Vorhofflimmern</documentation> </annotation> <restriction base="xs:string"> <enumeration value="0363001"> <annotation> <documentation>nein</documentation> </annotation> </enumeration> <enumeration value="0363002"> <annotation> <documentation>paroxysmal</documentation> </annotation> </enumeration> <enumeration value="0363003"> <annotation> <documentation>persistierend</documentation> </annotation> </enumeration> <enumeration value="0363004"> <annotation> <documentation>permanent</documentation> </annotation> </enumeration> </restriction> </pre>		

	<code></simpleType></code>
--	----------------------------------

simpleType enum_0364

namespace	http://xml.ir-d.de/irdsaa																		
type	restriction of string																		
properties	base xs:string																		
facets	<table><thead><tr><th>Kind</th><th>Value</th><th>Annotation</th></tr></thead><tbody><tr><td>enumeration</td><td>0364001</td><td>documentation nein</td></tr><tr><td>enumeration</td><td>0364002</td><td>documentation Schrittmacher ohne CRT-System</td></tr><tr><td>enumeration</td><td>0364003</td><td>documentation Schrittmacher mit CRT-System</td></tr><tr><td>enumeration</td><td>0364004</td><td>documentation Defibrillator ohne CRT-System</td></tr><tr><td>enumeration</td><td>0364005</td><td>documentation Defibrillator mit CRT-System</td></tr></tbody></table>	Kind	Value	Annotation	enumeration	0364001	documentation nein	enumeration	0364002	documentation Schrittmacher ohne CRT-System	enumeration	0364003	documentation Schrittmacher mit CRT-System	enumeration	0364004	documentation Defibrillator ohne CRT-System	enumeration	0364005	documentation Defibrillator mit CRT-System
Kind	Value	Annotation																	
enumeration	0364001	documentation nein																	
enumeration	0364002	documentation Schrittmacher ohne CRT-System																	
enumeration	0364003	documentation Schrittmacher mit CRT-System																	
enumeration	0364004	documentation Defibrillator ohne CRT-System																	
enumeration	0364005	documentation Defibrillator mit CRT-System																	
annotation	documentation Kat_AK_SchrittmacherDefi																		
source	<pre><simpleType name="enum_0364"> <annotation> <documentation>Kat_AK_SchrittmacherDefi</documentation> </annotation> <restriction base="xs:string"> <enumeration value="0364001"> <annotation> <documentation>nein</documentation> </annotation> </enumeration> <enumeration value="0364002"> <annotation> <documentation>Schrittmacher ohne CRT-System</documentation> </annotation> </enumeration> <enumeration value="0364003"> <annotation> <documentation>Schrittmacher mit CRT-System</documentation> </annotation> </enumeration> <enumeration value="0364004"> <annotation> <documentation>Defibrillator ohne CRT-System</documentation> </annotation> </enumeration> <enumeration value="0364005"> <annotation> <documentation>Defibrillator mit CRT-System</documentation> </annotation> </enumeration> </restriction> </simpleType></pre>																		

simpleType enum_0365

namespace	http://xml.ir-d.de/irdsaa
-----------	---------------------------

type	restriction of string		
properties	base xs:string		
facets	Kind	Value	Annotation
	enumeration	0365001	documentation nein
	enumeration	0365002	documentation ja, operativ
	enumeration	0365003	documentation ja, interventionell
annotation	documentation Kat_AK_MyokardRevaskularisation		
source	<pre> <simpleType name="enum_0365"> <annotation> <documentation>Kat_AK_MyokardRevaskularisation</documentation> </annotation> <restriction base="xs:string"> <enumeration value="0365001"> <annotation> <documentation>nein</documentation> </annotation> </enumeration> <enumeration value="0365002"> <annotation> <documentation>ja, operativ</documentation> </annotation> </enumeration> <enumeration value="0365003"> <annotation> <documentation>ja, interventionell</documentation> </annotation> </enumeration> </restriction> </simpleType> </pre>		

simpleType **enum_0366**

namespace	http://xml.ir-d.de/irdsaa		
type	restriction of string		
properties	base xs:string		
facets	Kind	Value	Annotation
	enumeration	0366001	documentation nein
	enumeration	0366002	documentation ja, <= 6 Stunden
	enumeration	0366003	documentation ja, > 6 Stunden bis <= 3 Monate
	enumeration	0366004	documentation ja, > 3 Monate
	enumeration	0366099	documentation unbekannt
annotation	documentation Kat_AK_PCI		
source	<pre> <simpleType name="enum_0366"> <annotation> <documentation>Kat_AK_PCI</documentation> </annotation> </pre>		

```

<restriction base="xs:string">
  <enumeration value="0366001">
    <annotation>
      <documentation>nein</documentation>
    </annotation>
  </enumeration>
  <enumeration value="0366002">
    <annotation>
      <documentation>ja, &lt;= 6 Stunden</documentation>
    </annotation>
  </enumeration>
  <enumeration value="0366003">
    <annotation>
      <documentation>ja, &gt; 6 Stunden bis &lt;= 3 Monate</documentation>
    </annotation>
  </enumeration>
  <enumeration value="0366004">
    <annotation>
      <documentation>ja, &gt; 3 Monate</documentation>
    </annotation>
  </enumeration>
  <enumeration value="0366099">
    <annotation>
      <documentation>unbekannt</documentation>
    </annotation>
  </enumeration>
</restriction>
</simpleType>

```

simpleType enum_0367

namespace	http://xml.ir-d.de/irdsaa		
type	restriction of string		
properties	base xs:string		
facets	Kind	Value	Annotation
	enumeration	0367001	documentation keine
	enumeration	0367002	documentation Mediastinitis
	enumeration	0367003	documentation Sepsis
	enumeration	0367004	documentation broncho-pulmonale Infektion
	enumeration	0367005	documentation oto-laryngologische Infektion
	enumeration	0367006	documentation floride Endokarditis
	enumeration	0367007	documentation Peritonitis
	enumeration	0367008	documentation Wundinfektion Thorax
	enumeration	0367009	documentation Pleuraempyem
	enumeration	0367010	documentation Venenkatheterinfektion
	enumeration	0367011	documentation Harnwegsinfektion
	enumeration	0367012	documentation Wundinfektion untere Extremitäten

	enumeration 0367013 documentation HIV-Infektion enumeration 0367014 documentation Hepatitis B oder C enumeration 0367015 documentation andere Wundinfektion enumeration 0367042 documentation sonstige Infektion
annotation	documentation Kat_AK_Infektion
source	<pre> <simpleType name="enum_0367"> <annotation> <documentation>Kat_AK_Infektion</documentation> </annotation> <restriction base="xs:string"> <enumeration value="0367001"> <annotation> <documentation>keine</documentation> </annotation> </enumeration> <enumeration value="0367002"> <annotation> <documentation>Mediastinitis</documentation> </annotation> </enumeration> <enumeration value="0367003"> <annotation> <documentation>Sepsis</documentation> </annotation> </enumeration> <enumeration value="0367004"> <annotation> <documentation>broncho-pulmonale Infektion</documentation> </annotation> </enumeration> <enumeration value="0367005"> <annotation> <documentation>oto-laryngologische Infektion</documentation> </annotation> </enumeration> <enumeration value="0367006"> <annotation> <documentation>floride Endokarditis</documentation> </annotation> </enumeration> <enumeration value="0367007"> <annotation> <documentation>Peritonitis</documentation> </annotation> </enumeration> <enumeration value="0367008"> <annotation> <documentation>Wundinfektion Thorax</documentation> </annotation> </enumeration> <enumeration value="0367009"> <annotation> <documentation>Pleuraempyem</documentation> </annotation> </enumeration> </restriction> </simpleType> </pre>

```

<enumeration value="0367010">
  <annotation>
    <documentation>Venenkatheterinfektion</documentation>
  </annotation>
</enumeration>
<enumeration value="0367011">
  <annotation>
    <documentation>Harnwegsinfektion</documentation>
  </annotation>
</enumeration>
<enumeration value="0367012">
  <annotation>
    <documentation>Wundinfektion untere Extremitäten</documentation>
  </annotation>
</enumeration>
<enumeration value="0367013">
  <annotation>
    <documentation>HIV-Infektion</documentation>
  </annotation>
</enumeration>
<enumeration value="0367014">
  <annotation>
    <documentation>Hepatitis B oder C</documentation>
  </annotation>
</enumeration>
<enumeration value="0367015">
  <annotation>
    <documentation>andere Wundinfektion</documentation>
  </annotation>
</enumeration>
<enumeration value="0367042">
  <annotation>
    <documentation>sonstige Infektion</documentation>
  </annotation>
</enumeration>
</restriction>
</simpleType>

```

simpleType enum 0368

namespace	http://xml.ir-d.de/irdsaa		
type	restriction of string		
properties	base xs:string		
facets	Kind	Value	Annotation
	enumeration	0368001	documentation nein
	enumeration	0368002	documentation ja, COPD mit Dauermedikation
	enumeration	0368003	documentation ja, COPD ohne Dauermedikation
	enumeration	0368004	documentation ja, andere Lungenerkrankungen
	enumeration	0368099	documentation unbekannt
annotation	documentation Kat AK Lungenerkrankung		
source	<simpleType name="enum_0368">		

	<pre> <annotation> <documentation>Kat_AK_Lungenerkrankung</documentation> </annotation> <restriction base="xs:string"> <enumeration value="0368001"> <annotation> <documentation>nein</documentation> </annotation> </enumeration> <enumeration value="0368002"> <annotation> <documentation>ja, COPD mit Dauermedikation</documentation> </annotation> </enumeration> <enumeration value="0368003"> <annotation> <documentation>ja, COPD ohne Dauermedikation</documentation> </annotation> </enumeration> <enumeration value="0368004"> <annotation> <documentation>ja, andere Lungenerkrankungen</documentation> </annotation> </enumeration> <enumeration value="0368099"> <annotation> <documentation>unbekannt</documentation> </annotation> </enumeration> </restriction> </simpleType> </pre>
--	---

simpleType enum_0369

namespace	http://xml.ir-d.de/irdsaa		
type	restriction of string		
properties	base xs:string		
facets	Kind	Value	Annotation
	enumeration	0369001	documentation nein
	enumeration	0369002	documentation akut
	enumeration	0369003	documentation chronisch
annotation	documentation Kat_AK_Nierenersatztherapie		
source	<pre> <simpleType name="enum_0369"> <annotation> <documentation>Kat_AK_Nierenersatztherapie</documentation> </annotation> <restriction base="xs:string"> <enumeration value="0369001"> <annotation> <documentation>nein</documentation> </annotation> </enumeration> <enumeration value="0369002"> </pre>		

	<pre> <annotation> <documentation>akut</documentation> </annotation> </enumeration> <enumeration value="0369003"> <annotation> <documentation>chronisch</documentation> </annotation> </enumeration> </restriction> </simpleType> </pre>
--	--

simpleType enum_0370

namespace	http://xml.ir-d.de/irdsaa		
type	restriction of string		
properties	base xs:string		
facets	Kind	Value	Annotation
	enumeration	0370001	documentation Echokardiographie
	enumeration	0370002	documentation Herzkatheter
	enumeration	0370042	documentation andere
annotation	documentation Kat_AK_AKOEFMessmethode		
source	<pre> <simpleType name="enum_0370"> <annotation> <documentation>Kat_AK_AKOEFMessmethode</documentation> </annotation> <restriction base="xs:string"> <enumeration value="0370001"> <annotation> <documentation>Echokardiographie</documentation> </annotation> </enumeration> <enumeration value="0370002"> <annotation> <documentation>Herzkatheter</documentation> </annotation> </enumeration> <enumeration value="0370042"> <annotation> <documentation>andere</documentation> </annotation> </enumeration> </restriction> </simpleType> </pre>		

simpleType enum_0371

namespace	http://xml.ir-d.de/irdsaa		
type	restriction of string		
properties	base xs:string		

facets	<table border="1"> <thead> <tr> <th>Kind</th> <th>Value</th> <th>Annotation</th> </tr> </thead> <tbody> <tr> <td>enumeration</td> <td>0371001</td> <td>documentation keine</td> </tr> <tr> <td>enumeration</td> <td>0371002</td> <td>documentation leicht</td> </tr> <tr> <td>enumeration</td> <td>0371003</td> <td>documentation mittel</td> </tr> <tr> <td>enumeration</td> <td>0371004</td> <td>documentation schwer</td> </tr> <tr> <td>enumeration</td> <td>0371099</td> <td>documentation unbekannt</td> </tr> </tbody> </table>	Kind	Value	Annotation	enumeration	0371001	documentation keine	enumeration	0371002	documentation leicht	enumeration	0371003	documentation mittel	enumeration	0371004	documentation schwer	enumeration	0371099	documentation unbekannt
Kind	Value	Annotation																	
enumeration	0371001	documentation keine																	
enumeration	0371002	documentation leicht																	
enumeration	0371003	documentation mittel																	
enumeration	0371004	documentation schwer																	
enumeration	0371099	documentation unbekannt																	
annotation	documentation Kat AK Verkalkungsgrad																		
source	<pre> <simpleType name="enum_0371"> <annotation> <documentation>Kat_AK_Verkalkungsgrad</documentation> </annotation> <restriction base="xs:string"> <enumeration value="0371001"> <annotation> <documentation>keine</documentation> </annotation> </enumeration> <enumeration value="0371002"> <annotation> <documentation>leicht</documentation> </annotation> </enumeration> <enumeration value="0371003"> <annotation> <documentation>mittel</documentation> </annotation> </enumeration> <enumeration value="0371004"> <annotation> <documentation>schwer</documentation> </annotation> </enumeration> <enumeration value="0371099"> <annotation> <documentation>unbekannt</documentation> </annotation> </enumeration> </restriction> </simpleType> </pre>																		

simpleType enum_0372

namespace	http://xml.ir-d.de/irdsaa												
type	restriction of string												
properties	base xs:string												
facets	<table border="1"> <thead> <tr> <th>Kind</th> <th>Value</th> <th>Annotation</th> </tr> </thead> <tbody> <tr> <td>enumeration</td> <td>0372001</td> <td>documentation nein</td> </tr> <tr> <td>enumeration</td> <td>0372002</td> <td>documentation ja, bicuspide</td> </tr> <tr> <td>enumeration</td> <td>0372003</td> <td>documentation ja, unicuspide</td> </tr> </tbody> </table>	Kind	Value	Annotation	enumeration	0372001	documentation nein	enumeration	0372002	documentation ja, bicuspide	enumeration	0372003	documentation ja, unicuspide
Kind	Value	Annotation											
enumeration	0372001	documentation nein											
enumeration	0372002	documentation ja, bicuspide											
enumeration	0372003	documentation ja, unicuspide											

	enumeration 0372099 documentation unbekannt
annotation	documentation Kat_AK_BiUnicuspideKlappe
source	<pre> <simpleType name="enum_0372"> <annotation> <documentation>Kat_AK_BiUnicuspideKlappe</documentation> </annotation> <restriction base="xs:string"> <enumeration value="0372001"> <annotation> <documentation>nein</documentation> </annotation> </enumeration> <enumeration value="0372002"> <annotation> <documentation>ja, bicuspide</documentation> </annotation> </enumeration> <enumeration value="0372003"> <annotation> <documentation>ja, unicuspide</documentation> </annotation> </enumeration> <enumeration value="0372099"> <annotation> <documentation>unbekannt</documentation> </annotation> </enumeration> </restriction> </simpleType> </pre>

simpleType enum_0373

namespace	http://xml.ir-d.de/irdsaa		
type	restriction of string		
properties	base xs:string		
facets	Kind	Value	Annotation
	enumeration	0373001	documentation keine
	enumeration	0373002	documentation leichtgradig
	enumeration	0373003	documentation mittelgradig
	enumeration	0373004	documentation hochgradig
	enumeration	0373099	documentation unbekannt
annotation	documentation Kat_AK_Grad		
source	<pre> <simpleType name="enum_0373"> <annotation> <documentation>Kat_AK_Grad</documentation> </annotation> <restriction base="xs:string"> <enumeration value="0373001"> <annotation> </pre>		

	<pre> <documentation>keine</documentation> </annotation> </enumeration> <enumeration value="0373002"> <annotation> <documentation>leichtgradig</documentation> </annotation> </enumeration> <enumeration value="0373003"> <annotation> <documentation>mittelgradig</documentation> </annotation> </enumeration> <enumeration value="0373004"> <annotation> <documentation>hochgradig</documentation> </annotation> </enumeration> <enumeration value="0373099"> <annotation> <documentation>unbekannt</documentation> </annotation> </enumeration> </restriction> </simpleType> </pre>
--	--

simpleType enum_0374

namespace	http://xml.ir-d.de/irdsaa		
type	restriction of string		
properties	base xs:string		
facets	Kind	Value	Annotation
	enumeration	0374001	documentation nein
	enumeration	0374002	documentation ja, <= 6 Stunden
	enumeration	0374003	documentation ja, > 6 Stunden bis <= 24 Stunden
	enumeration	0374004	documentation ja, > 1 bis 7 Tage
	enumeration	0374005	documentation ja, > 7 bis 21 Tage
	enumeration	0374006	documentation ja, > 21 Tage
annotation	documentation Kat_AK_InfarktAnamnese		
source	<pre> <simpleType name="enum_0374"> <annotation> <documentation>Kat_AK_InfarktAnamnese</documentation> </annotation> <restriction base="xs:string"> <enumeration value="0374001"> <annotation> <documentation>nein</documentation> </annotation> </enumeration> <enumeration value="0374002"> </pre>		

	<pre> <annotation> <documentation>ja, &lt;= 6 Stunden</documentation> </annotation> </enumeration> <enumeration value="0374003"> <annotation> <documentation>ja, &gt; 6 Stunden bis &lt;= 24 Stunden</documentation> </annotation> </enumeration> <enumeration value="0374004"> <annotation> <documentation>ja, &gt; 1 bis 7 Tage</documentation> </annotation> </enumeration> <enumeration value="0374005"> <annotation> <documentation>ja, &gt; 7 bis 21 Tage</documentation> </annotation> </enumeration> <enumeration value="0374006"> <annotation> <documentation>ja, &gt; 21 Tage</documentation> </annotation> </enumeration> </restriction> </simpleType> </pre>
--	--

simpleType enum_0375

namespace	http://xml.ir-d.de/irdsaa		
type	restriction of string		
properties	base xs:string		
facets	Kind	Value	Annotation
	enumeration	0375001	documentation keine Symptome oder Angina
	enumeration	0375002	documentation Symptome, aber keine Ischämiezeichen
	enumeration	0375003	documentation stabile Angina
	enumeration	0375004	documentation instabile Angina
	enumeration	0375005	documentation Infarkt ohne ST-Hebung (Non-STEMI)
	enumeration	0375006	documentation Infarkt mit ST-Hebung (STEMI)
	enumeration	0375042	documentation unbekannt
annotation	documentation Kat_AK_KardialeSymptome		
source	<pre> <simpleType name="enum_0375"> <annotation> <documentation>Kat_AK_KardialeSymptome</documentation> </annotation> <restriction base="xs:string"> <enumeration value="0375001"> <annotation> <documentation>keine Symptome oder Angina</documentation> </pre>		

```

</annotation>
</enumeration>
<enumeration value="0375002">
  <annotation>
    <documentation>Symptome, aber keine Ischämiezeichen</documentation>
  </annotation>
</enumeration>
<enumeration value="0375003">
  <annotation>
    <documentation>stabile Angina</documentation>
  </annotation>
</enumeration>
<enumeration value="0375004">
  <annotation>
    <documentation>instabile Angina</documentation>
  </annotation>
</enumeration>
<enumeration value="0375005">
  <annotation>
    <documentation>Infarkt ohne ST-Hebung (Non-STEMI)</documentation>
  </annotation>
</enumeration>
<enumeration value="0375006">
  <annotation>
    <documentation>Infarkt mit ST-Hebung (STEMI)</documentation>
  </annotation>
</enumeration>
<enumeration value="0375042">
  <annotation>
    <documentation>unbekannt</documentation>
  </annotation>
</enumeration>
</restriction>
</simpleType>

```

simpleType enum 0376

namespace	http://xml.lir-d.de/irdsaa		
type	restriction of string		
properties	base xs:string		
facets	Kind	Value	Annotation
	enumeration	0376001	documentation nein
	enumeration	0376002	documentation ja, ZNS, zerebrovaskuläre Blutung
	enumeration	0376003	documentation ja, ZNS, zerebrovaskuläre Ischämie
	enumeration	0376042	documentation ja, ZNS, andere
annotation	documentation Kat_AK_Schlaganfall		
source	<pre> <simpleType name="enum_0376"> <annotation> <documentation>Kat_AK_Schlaganfall</documentation> </annotation> <restriction base="xs:string"> <enumeration value="0376001"> </pre>		

	<pre> <annotation> <documentation>nein</documentation> </annotation> </enumeration> <enumeration value="0376002"> <annotation> <documentation>ja, ZNS, zerebrovaskuläre Blutung</documentation> </annotation> </enumeration> <enumeration value="0376003"> <annotation> <documentation>ja, ZNS, zerebrovaskuläre Ischämie</documentation> </annotation> </enumeration> <enumeration value="0376042"> <annotation> <documentation>ja, ZNS, andere</documentation> </annotation> </enumeration> </restriction> </simpleType> </pre>
--	---

simpleType enum 0377

namespace	http://xml.ir-d.de/irdsaa		
type	restriction of string		
properties	base xs:string		
facets	Kind	Value	Annotation
	enumeration	0377001	documentation ja, mild neurological dysfunction: NIHSS 0-5
	enumeration	0377002	documentation ja, moderate neurological dysfunction: NIHSS 6-14
	enumeration	0377003	documentation ja, severe neurological dysfunction: NIHSS >=15
annotation	documentation Kat AK Nihss		
source	<pre> <simpleType name="enum_0377"> <annotation> <documentation>Kat_AK_Nihss</documentation> </annotation> <restriction base="xs:string"> <enumeration value="0377001"> <annotation> <documentation>ja, mild neurological dysfunction: NIHSS 0-5</documentation> </annotation> </enumeration> <enumeration value="0377002"> <annotation> <documentation>ja, moderate neurological dysfunction: NIHSS 6-14</documentation> </annotation> </enumeration> <enumeration value="0377003"> <annotation> <documentation> ja, severe neurological dysfunction: NIHSS >=15</documentation> </annotation> </enumeration> </restriction> </simpleType> </pre>		

	<pre> </annotation> </enumeration> </restriction> </simpleType> </pre>
--	--

simpleType enum_0378

namespace	http://xml.ir-d.de/irdsaa		
type	restriction of string		
properties	base xs:string		
facets	Kind	Value	Annotation
	enumeration	0378001	documentation nein
	enumeration	0378002	documentation ja, < 48h gemäss VARC-3-Definition
	enumeration	0378003	documentation ja, >= 48h - <= 72h gemäß VARC-3-Definition
	enumeration	0378004	documentation ja, > 72 h gemäß VARC-3 Definition
annotation	documentation Kat_AK_Myokardinfarkt		
source	<pre> <simpleType name="enum_0378"> <annotation> <documentation>Kat_AK_Myokardinfarkt</documentation> </annotation> <restriction base="xs:string"> <enumeration value="0378001"> <annotation> <documentation>nein</documentation> </annotation> </enumeration> <enumeration value="0378002"> <annotation> <documentation>ja, &lt; 48h gemäss VARC-3-Definition</documentation> </annotation> </enumeration> <enumeration value="0378003"> <annotation> <documentation>ja, &gt;= 48h - &lt;= 72h gemäß VARC-3-Definition</documentation> </annotation> </enumeration> <enumeration value="0378004"> <annotation> <documentation>ja, &gt; 72 h gemäß VARC-3 Definition</documentation> </annotation> </enumeration> </restriction> </simpleType> </pre>		

simpleType enum_0379

namespace	http://xml.ir-d.de/irdsaa		
type	restriction of string		

properties	base xs:string															
facets	<table border="1"> <thead> <tr> <th>Kind</th> <th>Value</th> <th>Annotation</th> </tr> </thead> <tbody> <tr> <td>enumeration</td> <td>0379001</td> <td>documentation Keine gefäss- oder zugangsassoziierte Komplikationen</td> </tr> <tr> <td>enumeration</td> <td>0379002</td> <td>documentation Versagen des perkutanen Verschlusssystems</td> </tr> <tr> <td>enumeration</td> <td>0379003</td> <td>documentation Geringfügige Gefäßkomplikationen</td> </tr> <tr> <td>enumeration</td> <td>0379004</td> <td>documentation Erhebliche Gefäßkomplikationen</td> </tr> </tbody> </table>	Kind	Value	Annotation	enumeration	0379001	documentation Keine gefäss- oder zugangsassoziierte Komplikationen	enumeration	0379002	documentation Versagen des perkutanen Verschlusssystems	enumeration	0379003	documentation Geringfügige Gefäßkomplikationen	enumeration	0379004	documentation Erhebliche Gefäßkomplikationen
Kind	Value	Annotation														
enumeration	0379001	documentation Keine gefäss- oder zugangsassoziierte Komplikationen														
enumeration	0379002	documentation Versagen des perkutanen Verschlusssystems														
enumeration	0379003	documentation Geringfügige Gefäßkomplikationen														
enumeration	0379004	documentation Erhebliche Gefäßkomplikationen														
annotation	documentation Kat_AK_ZugangKomplikationen															
source	<pre> <simpleType name="enum_0379"> <annotation> <documentation>Kat_AK_ZugangKomplikationen</documentation> </annotation> <restriction base="xs:string"> <enumeration value="0379001"> <annotation> <documentation>Keine gefäss- oder zugangsassoziierte Komplikationen</documentation> </annotation> </enumeration> <enumeration value="0379002"> <annotation> <documentation>Versagen des perkutanen Verschlusssystems</documentation> </annotation> </enumeration> <enumeration value="0379003"> <annotation> <documentation>Geringfügige Gefäßkomplikationen</documentation> </annotation> </enumeration> <enumeration value="0379004"> <annotation> <documentation>Erhebliche Gefäßkomplikationen</documentation> </annotation> </enumeration> </restriction> </simpleType> </pre>															

simpleType enum_0380

namespace	http://xml.ir-d.de/irdsaa															
type	restriction of string															
properties	base xs:string															
facets	<table border="1"> <thead> <tr> <th>Kind</th> <th>Value</th> <th>Annotation</th> </tr> </thead> <tbody> <tr> <td>enumeration</td> <td>0380001</td> <td>documentation nein</td> </tr> <tr> <td>enumeration</td> <td>0380002</td> <td>documentation ja, intraprozedural</td> </tr> <tr> <td>enumeration</td> <td>0380003</td> <td>documentation ja, postprozedural</td> </tr> <tr> <td>enumeration</td> <td>0380004</td> <td>documentation ja, Zeitpunkt nicht bekannt</td> </tr> </tbody> </table>	Kind	Value	Annotation	enumeration	0380001	documentation nein	enumeration	0380002	documentation ja, intraprozedural	enumeration	0380003	documentation ja, postprozedural	enumeration	0380004	documentation ja, Zeitpunkt nicht bekannt
Kind	Value	Annotation														
enumeration	0380001	documentation nein														
enumeration	0380002	documentation ja, intraprozedural														
enumeration	0380003	documentation ja, postprozedural														
enumeration	0380004	documentation ja, Zeitpunkt nicht bekannt														
annotation	documentation															

	Kat_AK_Reanimation
source	<pre> <simpleType name="enum_0380"> <annotation> <documentation>Kat_AK_Reanimation</documentation> </annotation> <restriction base="xs:string"> <enumeration value="0380001"> <annotation> <documentation>nein</documentation> </annotation> </enumeration> <enumeration value="0380002"> <annotation> <documentation>ja, intraprozedural</documentation> </annotation> </enumeration> <enumeration value="0380003"> <annotation> <documentation>ja, postprozedural</documentation> </annotation> </enumeration> <enumeration value="0380004"> <annotation> <documentation>ja, Zeitpunkt nicht bekannt</documentation> </annotation> </enumeration> </restriction> </simpleType> </pre>

simpleType **enum_0381**

namespace	http://xml.ir-d.de/irdsaa		
type	restriction of string		
properties	base xs:string		
facets	Kind	Value	Annotation
	enumeration	0381001	documentation nein
	enumeration	0381002	documentation Thorakotomie/Rethorakotomie
	enumeration	0381003	documentation kathetergestützte Reintervention
	enumeration	0381004	documentation lokale Reinterventionen
	enumeration	0381005	documentation andere Reintervention
annotation	documentation Kat_AK_Massnahmen		
source	<pre> <simpleType name="enum_0381"> <annotation> <documentation>Kat_AK_Massnahmen</documentation> </annotation> <restriction base="xs:string"> <enumeration value="0381001"> <annotation> <documentation>nein</documentation> </annotation> </enumeration> </pre>		

	<pre> <enumeration value="0381002"> <annotation> <documentation>Thorakotomie/Rethorakotomie</documentation> </annotation> </enumeration> <enumeration value="0381003"> <annotation> <documentation>kathetergestützte Reintervention</documentation> </annotation> </enumeration> <enumeration value="0381004"> <annotation> <documentation>lokale Reinterventionen</documentation> </annotation> </enumeration> <enumeration value="0381005"> <annotation> <documentation>andere Reintervention</documentation> </annotation> </enumeration> </restriction> </simpleType> </pre>
--	--

simpleType enum_0382

namespace	http://xml.ir-d.de/irdsaa		
type	restriction of string		
properties	base xs:string		
facets	Kind	Value	Annotation
	enumeration	0382001	documentation keine Rethorakotomie / kein weiterer Grund
	enumeration	0382002	documentation Blutung/Hämatom
	enumeration	0382003	documentation Low Cardiac Output
	enumeration	0382004	documentation Tamponade
	enumeration	0382005	documentation Graftprobleme, Ischämie
	enumeration	0382006	documentation Wundinfektion, Mediastinitis
	enumeration	0382007	documentation Dissektion
	enumeration	0382008	documentation Prothesendysfunktion
	enumeration	0382009	documentation instabiles Sternum
	enumeration	0382010	documentation Chylothorax
	enumeration	0382011	documentation lokale Revision im Bereich des Zugangsweges
	enumeration	0382042	documentation anderer Grund
annotation	documentation Kat_AK_Komplikation		
source	<pre> <simpleType name="enum_0382"> <annotation> <documentation>Kat_AK_Komplikation</documentation> </pre>		

```

</annotation>
<restriction base="xs:string">
  <enumeration value="0382001">
    <annotation>
      <documentation>keine Rethorakotomie / kein weiterer
Grund</documentation>
    </annotation>
  </enumeration>
  <enumeration value="0382002">
    <annotation>
      <documentation>Blutung/Hämatom</documentation>
    </annotation>
  </enumeration>
  <enumeration value="0382003">
    <annotation>
      <documentation>Low Cardiac Output</documentation>
    </annotation>
  </enumeration>
  <enumeration value="0382004">
    <annotation>
      <documentation>Tamponade</documentation>
    </annotation>
  </enumeration>
  <enumeration value="0382005">
    <annotation>
      <documentation>Graftprobleme, Ischämie</documentation>
    </annotation>
  </enumeration>
  <enumeration value="0382006">
    <annotation>
      <documentation>Wundinfektion, Mediastinitis</documentation>
    </annotation>
  </enumeration>
  <enumeration value="0382007">
    <annotation>
      <documentation>Dissektion</documentation>
    </annotation>
  </enumeration>
  <enumeration value="0382008">
    <annotation>
      <documentation>Prothesendysfunktion</documentation>
    </annotation>
  </enumeration>
  <enumeration value="0382009">
    <annotation>
      <documentation>instabiles Sternum</documentation>
    </annotation>
  </enumeration>
  <enumeration value="0382010">
    <annotation>
      <documentation>Chylothorax</documentation>
    </annotation>
  </enumeration>
  <enumeration value="0382011">
    <annotation>
      <documentation>lokale Revision im Bereich des
Zugangsweges</documentation>
    </annotation>
  </enumeration>

```

	<pre> <enumeration value="0382042"> <annotation> <documentation>anderer Grund</documentation> </annotation> </enumeration> </restriction> </simpleType> </pre>
--	--

simpleType enum_0383

namespace	http://xml.ir-d.de/irdsaa		
type	restriction of string		
properties	base xs:string		
facets	Kind	Value	Annotation
	enumeration	0383001	documentation nein
	enumeration	0383002	documentation ja, mit forcierter Atemtherapie
	enumeration	0383003	documentation ja, Reintubation oder längerfristige Beatmung
	enumeration	0383004	documentation ja, Tracheotomie
annotation	documentation Kat_AK_RespiratorischeInsuffizienz		
source	<pre> <simpleType name="enum_0383"> <annotation> <documentation>Kat_AK_RespiratorischeInsuffizienz</documentation> </annotation> <restriction base="xs:string"> <enumeration value="0383001"> <annotation> <documentation>nein</documentation> </annotation> </enumeration> <enumeration value="0383002"> <annotation> <documentation>ja, mit forcierter Atemtherapie</documentation> </annotation> </enumeration> <enumeration value="0383003"> <annotation> <documentation>ja, Reintubation oder längerfristige Beatmung</documentation> </annotation> </enumeration> <enumeration value="0383004"> <annotation> <documentation>ja, Tracheotomie</documentation> </annotation> </enumeration> </restriction> </simpleType> </pre>		

simpleType enum_0384

namespace	http://xml.ir-d.de/irdsaa		
type	restriction of string		
properties	base xs:string		
facets	Kind	Value	Annotation
	enumeration	0384001	documentation keine Blutungskomplikationen
	enumeration	0384002	documentation Geringfügige Blutung (Minor Bleeding - BARC type 2 or 3a)
	enumeration	0384003	documentation Starke Blutung (Major Bleeding - BARC type 3a)
	enumeration	0384004	documentation Lebensbedrohliche Blutung (Life-threatening or disabling bleeding - BARC type 3b or 3c or type 5)
annotation	documentation Kat AK Blutungskomplikation		
source	<pre> <simpleType name="enum_0384"> <annotation> <documentation>Kat_AK_Blutungskomplikation</documentation> </annotation> <restriction base="xs:string"> <enumeration value="0384001"> <annotation> <documentation>keine Blutungskomplikationen</documentation> </annotation> </enumeration> <enumeration value="0384002"> <annotation> <documentation>Geringfügige Blutung (Minor Bleeding - BARC type 2 or 3a)</documentation> </annotation> </enumeration> <enumeration value="0384003"> <annotation> <documentation>Starke Blutung (Major Bleeding - BARC type 3a)</documentation> </annotation> </enumeration> <enumeration value="0384004"> <annotation> <documentation>Lebensbedrohliche Blutung (Life-threatening or disabling bleeding - BARC type 3b or 3c or type 5)</documentation> </annotation> </enumeration> </restriction> </simpleType> </pre>		

simpleType enum_0385

namespace	http://xml.ir-d.de/irdsaa		
type	restriction of string		
properties	base xs:string		
facets	Kind	Value	Annotation
	enumeration	0385001	documentation Sinusrhythmus

	enumeration 0385002 documentation Vorhofflimmern enumeration 0385003 documentation Patient verstorben (kein Herzrhythmus) enumeration 0385042 documentation anderer Rhythmus
annotation	documentation Kat_AK_HerzrhythmusEntlassung
source	<pre> <simpleType name="enum_0385"> <annotation> <documentation>Kat_AK_HerzrhythmusEntlassung</documentation> </annotation> <restriction base="xs:string"> <enumeration value="0385001"> <annotation> <documentation>Sinusrhythmus</documentation> </annotation> </enumeration> <enumeration value="0385002"> <annotation> <documentation>Vorhofflimmern</documentation> </annotation> </enumeration> <enumeration value="0385003"> <annotation> <documentation>Patient verstorben (kein Herzrhythmus)</documentation> </annotation> </enumeration> <enumeration value="0385042"> <annotation> <documentation>anderer Rhythmus</documentation> </annotation> </enumeration> </restriction> </simpleType> </pre>

simpleType enum_0388

namespace	http://xml.ir-d.de/irdsaa		
type	restriction of string		
properties	base xs:string		
facets	Kind	Value	Annotation
	enumeration	0388001	documentation nein
	enumeration	0388002	documentation ASS
	enumeration	0388003	documentation ADP-Rezeptor-Antagonist
	enumeration	0388004	documentation Kombination ASS und ADP-Rezeptor-Antagonist
	enumeration	0388042	documentation ja, andere
	enumeration	0388099	documentation unbekannt
annotation	documentation Kat_AK_Plaettchenaggregationshemmer		
source	<pre> <simpleType name="enum_0388"> <annotation> </pre>		

```

<documentation>Kat_AK_Plaettchenaggregationshemmer</documentation>
</annotation>
<restriction base="xs:string">
  <enumeration value="0388001">
    <annotation>
      <documentation>nein</documentation>
    </annotation>
  </enumeration>
  <enumeration value="0388002">
    <annotation>
      <documentation>ASS</documentation>
    </annotation>
  </enumeration>
  <enumeration value="0388003">
    <annotation>
      <documentation>ADP-Rezeptor-Antagonist</documentation>
    </annotation>
  </enumeration>
  <enumeration value="0388004">
    <annotation>
      <documentation>Kombination ASS und
ADP-Rezeptor-Antagonist</documentation>
    </annotation>
  </enumeration>
  <enumeration value="0388042">
    <annotation>
      <documentation>ja, andere</documentation>
    </annotation>
  </enumeration>
  <enumeration value="0388099">
    <annotation>
      <documentation>unbekannt</documentation>
    </annotation>
  </enumeration>
</restriction>
</simpleType>

```

simpleType enum 0389

namespace	http://xml.ir-d.de/irdsaa		
type	restriction of string		
properties	base xs:string		
facets	Kind	Value	Annotation
	enumeration	0389001	documentation nein
	enumeration	0389002	documentation Cumarin-Derivate
	enumeration	0389003	documentation Heparinoide
	enumeration	0389004	documentation orale Thrombinantagonisten
	enumeration	0389005	documentation Kombination Heparinoide und Cumarin-Derivate
	enumeration	0389006	documentation Direkte orale Antikoagulantien (DOAK / NOAK)
	enumeration	0389042	documentation ja, andere
	enumeration	0389099	documentation

	unbekannt
annotation	documentation Kat AK Antikoagulantien
source	<pre> <simpleType name="enum_0389"> <annotation> <documentation>Kat_AK_Antikoagulantien</documentation> </annotation> <restriction base="xs:string"> <enumeration value="0389001"> <annotation> <documentation>nein</documentation> </annotation> </enumeration> <enumeration value="0389002"> <annotation> <documentation>Cumarin-Derivate</documentation> </annotation> </enumeration> <enumeration value="0389003"> <annotation> <documentation>Heparinoide</documentation> </annotation> </enumeration> <enumeration value="0389004"> <annotation> <documentation>orale Thrombinantagonisten</documentation> </annotation> </enumeration> <enumeration value="0389005"> <annotation> <documentation>Kombination Heparinoide und Cumarin-Derivate</documentation> </annotation> </enumeration> <enumeration value="0389006"> <annotation> <documentation>Direkte orale Antikoagulantien (DOAK / NOAK)</documentation> </annotation> </enumeration> <enumeration value="0389042"> <annotation> <documentation>ja, andere</documentation> </annotation> </enumeration> <enumeration value="0389099"> <annotation> <documentation>unbekannt</documentation> </annotation> </enumeration> </restriction> </simpleType> </pre>

simpleType enum_0390

namespace	http://xml.ir-d.de/irdsaa
type	restriction of string

properties	base xs:string									
facets	<table border="1"> <thead> <tr> <th>Kind</th> <th>Value</th> <th>Annotation</th> </tr> </thead> <tbody> <tr> <td>enumeration</td> <td>0390001</td> <td>documentation biologisches Klappenmodell</td> </tr> <tr> <td>enumeration</td> <td>0390002</td> <td>documentation mechanisches Klappenmodell</td> </tr> </tbody> </table>	Kind	Value	Annotation	enumeration	0390001	documentation biologisches Klappenmodell	enumeration	0390002	documentation mechanisches Klappenmodell
Kind	Value	Annotation								
enumeration	0390001	documentation biologisches Klappenmodell								
enumeration	0390002	documentation mechanisches Klappenmodell								
annotation	documentation Kat_AK_Artikeltyp									
source	<pre><simpleType name="enum_0390"> <annotation> <documentation>Kat_AK_Artikeltyp</documentation> </annotation> <restriction base="xs:string"> <enumeration value="0390001"> <annotation> <documentation>biologisches Klappenmodell</documentation> </annotation> </enumeration> <enumeration value="0390002"> <annotation> <documentation>mechanisches Klappenmodell</documentation> </annotation> </enumeration> </restriction> </simpleType></pre>									

simpleType enum_0398

namespace	http://xml.ir-d.de/irdsaa												
type	restriction of string												
properties	base xs:string												
facets	<table border="1"> <thead> <tr> <th>Kind</th> <th>Value</th> <th>Annotation</th> </tr> </thead> <tbody> <tr> <td>enumeration</td> <td>0398001</td> <td>documentation kardiovaskuläre Ursache</td> </tr> <tr> <td>enumeration</td> <td>0398002</td> <td>documentation nicht-kardiovaskuläre Ursache</td> </tr> <tr> <td>enumeration</td> <td>0398099</td> <td>documentation Todesursache unbekannt</td> </tr> </tbody> </table>	Kind	Value	Annotation	enumeration	0398001	documentation kardiovaskuläre Ursache	enumeration	0398002	documentation nicht-kardiovaskuläre Ursache	enumeration	0398099	documentation Todesursache unbekannt
Kind	Value	Annotation											
enumeration	0398001	documentation kardiovaskuläre Ursache											
enumeration	0398002	documentation nicht-kardiovaskuläre Ursache											
enumeration	0398099	documentation Todesursache unbekannt											
annotation	documentation Kat_AK_Todesursache												
source	<pre><simpleType name="enum_0398"> <annotation> <documentation>Kat_AK_Todesursache</documentation> </annotation> <restriction base="xs:string"> <enumeration value="0398001"> <annotation> <documentation>kardiovaskuläre Ursache</documentation> </annotation> </enumeration> <enumeration value="0398002"> <annotation> <documentation>nicht-kardiovaskuläre Ursache</documentation> </annotation> </enumeration> <enumeration value="0398099"> </pre>												

	<pre> <annotation> <documentation>Todesursache unbekannt</documentation> </annotation> </enumeration> </restriction> </simpleType> </pre>
--	---

simpleType enum_0399

namespace	http://xml.ir-d.de/irdsaa		
type	restriction of string		
properties	base xs:string		
facets	Kind	Value	Annotation
	enumeration	0399001	documentation Patient lebt
	enumeration	0399002	documentation Patient im Krankenhaus verstorben
annotation	documentation Kat_AK_Vitalstatus		
source	<pre> <simpleType name="enum_0399"> <annotation> <documentation>Kat_AK_Vitalstatus</documentation> </annotation> <restriction base="xs:string"> <enumeration value="0399001"> <annotation> <documentation>Patient lebt</documentation> </annotation> </enumeration> <enumeration value="0399002"> <annotation> <documentation>Patient im Krankenhaus verstorben</documentation> </annotation> </enumeration> </restriction> </simpleType> </pre>		

simpleType enum_0044

namespace	http://xml.ir-d.de/emg		
type	restriction of string		
properties	base xs:string		
used by	element	OperationBasis/OPE_AsaSchluessel	
facets	Kind	Value	Annotation
	enumeration	0044001	documentation 1= normaler, sonst gesunder Patient
	enumeration	0044002	documentation 2= Patient mit leichter Allgemeinerkrankung
	enumeration	0044003	documentation 3= Patient mit schwerer Allgemeinerkrankung
	enumeration	0044004	documentation 4= Patient mit schwerer Allgemeinerkrankung, die eine ständige Lebensbedrohung darstellt
	enumeration	0044005	documentation

	5= moribunder Patient, der ohne die Operation voraussichtlich nicht überleben wird
annotation	documentation Kat ASA
source	<pre> <simpleType name="enum_0044"> <annotation> <documentation>Kat_ASA</documentation> </annotation> <restriction base="xs:string"> <enumeration value="0044001"> <annotation> <documentation>1= normaler, sonst gesunder Patient</documentation> </annotation> </enumeration> <enumeration value="0044002"> <annotation> <documentation>2= Patient mit leichter Allgemeinerkrankung</documentation> </annotation> </enumeration> <enumeration value="0044003"> <annotation> <documentation>3= Patient mit schwerer Allgemeinerkrankung</documentation> </annotation> </enumeration> <enumeration value="0044004"> <annotation> <documentation>4= Patient mit schwerer Allgemeinerkrankung, die eine ständige Lebensbedrohung darstellt</documentation> </annotation> </enumeration> <enumeration value="0044005"> <annotation> <documentation>5= moribunder Patient, der ohne die Operation voraussichtlich nicht überleben wird</documentation> </annotation> </enumeration> </restriction> </simpleType> </pre>

simpleType enum_0050

namespace	http://xml.lir-d.de/emg		
type	restriction of string		
properties	base xs:string		
used by	element OperationBasis/OPE SeitenLokalisationSchlüssel		
facets	Kind	Value	Annotation
	enumeration	0050001	documentation rechts
	enumeration	0050002	documentation links
annotation	documentation Kat_RechtsLinks		
source	<pre> <simpleType name="enum_0050"> <annotation> <documentation>Kat_RechtsLinks</documentation> </pre>		

	<pre> </annotation> <restriction base="xs:string"> <enumeration value="0050001"> <annotation> <documentation>rechts</documentation> </annotation> </enumeration> <enumeration value="0050002"> <annotation> <documentation>links</documentation> </annotation> </enumeration> </restriction> </simpleType> </pre>
--	---

simpleType enum_0060

namespace	http://xml.lir-d.de/emg		
type	restriction of string		
properties	base xs:string		
used by	elements	ArtikelidentifikationBasis/ARI_SonderstatusJNSchluessel OperationAortenklappeBasis/OAK_AortaThorakalSchluessel OperationAortenklappeBasis/OAK_BeatmungSchluessel OperationAortenklappeBasis/OAK_ExplantationSchluessel OperationAortenklappeBasis/OAK_InotropeSchluessel OperationAortenklappeBasis/OAK_IntraOpUnterstuetzungSchluessel OperationAortenklappeBasis/OAK_IsoliertSchluessel OperationAortenklappeBasis/OAK_KomplikationenSchluessel OperationAortenklappeBasis/OAK_KreislaufunterstuetzungSchluessel OperationAortenklappeBasis/OAK_NeuroprotektionSchluessel OperationAortenklappeBasis/OAK_PciWegenKhkSchluessel OperationAortenklappeBasis/OAK_PciWegenKomplikationSchluessel OperationAortenklappeBasis/OAK_PraeOpUnterstuetzungSchluessel OperationAortenklappeBasis/OAK_PtcaNachSchluessel OperationAortenklappeBasis/OAK_PtcaVorSchluessel OperationAortenklappeBasis/OAK_RapidPacingIntraSchluessel OperationAortenklappeBasis/OAK_RapidPacingNachSchluessel OperationAortenklappeBasis/OAK_RapidPacingVorSchluessel OperationAortenklappeBasis/OAK_SuccessSchluessel OperationAortenklappeBasis/OAK_TroponinSchluessel OperationAortenklappeBasis/OAK_ValveInValveSchluessel OperationAortenklappeBasis/OAK_ZusaetzlichePciSchluessel OperationEndoprotheseBasis/OEP_FrakturJNSchluessel PostoperationAortenklappeBasis/POA_AvBlockSchluessel PostoperationAortenklappeBasis/POA_EndokarditisSchluessel PostoperationAortenklappeBasis/POA_IntraOpVerstorbenSchluessel PostoperationAortenklappeBasis/POA_NierenersatzSchluessel PostoperationAortenklappeBasis/POA_SepsisSchluessel PostoperationAortenklappeBasis/POA_VorhofflimmernSchluessel	
facets	Kind	Value	Annotation
	enumeration	0060001	documentation ja
	enumeration	0060002	documentation nein
annotation	documentation Kat_JaNein		
source	<pre> <simpleType name="enum_0060"> <annotation> <documentation>Kat_JaNein</documentation> </pre>		

	<pre> </annotation> <restriction base="xs:string"> <enumeration value="0060001"> <annotation> <documentation>ja</documentation> </annotation> </enumeration> <enumeration value="0060002"> <annotation> <documentation>nein</documentation> </annotation> </enumeration> </restriction> </simpleType> </pre>
--	--

simpleType enum_0061

namespace	http://xml.lir-d.de/emg		
type	restriction of string		
properties	base xs:string		
used by	elements	OperationAortenklappeBasis/OAK ZugangVerkalkungSchluessel PatientenaufnahmeAortenklappeBasis/PAA AortenaneurysmaSchluessel PatientenaufnahmeAortenklappeBasis/PAA ArteriaCarotisSchluessel PatientenaufnahmeAortenklappeBasis/PAA AvkSchluessel PatientenaufnahmeAortenklappeBasis/PAA HypertonusSchluessel PatientenaufnahmeAortenklappeBasis/PAA PavkSchluessel PatientenaufnahmeAortenklappeBasis/PAA SonstigeAvkSchluessel PatientenaufnahmeAortenklappeBasis/PAA ValvuloplastieSchluessel	
facets	Kind	Value	Annotation
	enumeration	0061001	documentation ja
	enumeration	0061002	documentation nein
	enumeration	0061099	documentation unbekannt
annotation	documentation Kat_JaNeinUnbekannt		
source	<pre> <simpleType name="enum_0061"> <annotation> <documentation>Kat_JaNeinUnbekannt</documentation> </annotation> <restriction base="xs:string"> <enumeration value="0061001"> <annotation> <documentation>ja</documentation> </annotation> </enumeration> <enumeration value="0061002"> <annotation> <documentation>nein</documentation> </annotation> </enumeration> <enumeration value="0061099"> <annotation> <documentation>unbekannt</documentation> </annotation> </enumeration> </restriction> </simpleType> </pre>		

```

</restriction>
</simpleType>

```

simpleType enum_0062

namespace	http://xml.ir-d.de/emg		
type	restriction of string		
properties	base xs:string		
used by	element ZubehoerEndoprotheseBasis/ZEP_EinheitSchluessel		
facets	Kind	Value	Annotation
	enumeration	0062001	documentation Stück
	enumeration	0062002	documentation g
	enumeration	0062003	documentation mg
	enumeration	0062004	documentation l
	enumeration	0062005	documentation ml
	enumeration	0062006	documentation cm ³
	enumeration	0062007	documentation mm
	enumeration	0062008	documentation cm
	enumeration	0062009	documentation dm
	enumeration	0062010	documentation m
	enumeration	0062042	documentation andere
annotation	documentation Kat_Einheit		
source	<pre> <simpleType name="enum_0062"> <annotation> <documentation>Kat_Einheit</documentation> </annotation> <restriction base="xs:string"> <enumeration value="0062001"> <annotation> <documentation>Stück</documentation> </annotation> </enumeration> <enumeration value="0062002"> <annotation> <documentation>g</documentation> </annotation> </enumeration> <enumeration value="0062003"> <annotation> <documentation>mg</documentation> </annotation> </enumeration> <enumeration value="0062004"> <annotation> <documentation>l</documentation> </annotation> </pre>		

```

</enumeration>
<enumeration value="0062005">
  <annotation>
    <documentation>ml</documentation>
  </annotation>
</enumeration>
<enumeration value="0062006">
  <annotation>
    <documentation>cm3</documentation>
  </annotation>
</enumeration>
<enumeration value="0062007">
  <annotation>
    <documentation>mm</documentation>
  </annotation>
</enumeration>
<enumeration value="0062008">
  <annotation>
    <documentation>cm</documentation>
  </annotation>
</enumeration>
<enumeration value="0062009">
  <annotation>
    <documentation>dm</documentation>
  </annotation>
</enumeration>
<enumeration value="0062010">
  <annotation>
    <documentation>m</documentation>
  </annotation>
</enumeration>
<enumeration value="0062042">
  <annotation>
    <documentation>andere</documentation>
  </annotation>
</enumeration>
</restriction>
</simpleType>

```

simpleType **enum_0065**

namespace	http://xml.ir-d.de/emg		
type	restriction of string		
properties	base xs:string		
used by	element FallBasis/FAL ArtAufenthaltSchluessel		
facets	Kind	Value	Annotation
	enumeration	0065001	documentation stationär
	enumeration	0065002	documentation teilstationär
	enumeration	0065003	documentation ambulant
annotation	documentation Kat_ArtAufenthalt		
source	<pre> <simpleType name="enum_0065"> <annotation> </pre>		

	<pre> <documentation>Kat_ArtAufenthalt</documentation> </annotation> <restriction base="xs:string"> <enumeration value="0065001"> <annotation> <documentation>stationär</documentation> </annotation> </enumeration> <enumeration value="0065002"> <annotation> <documentation>teilstationär</documentation> </annotation> </enumeration> <enumeration value="0065003"> <annotation> <documentation>ambulant</documentation> </annotation> </enumeration> </restriction> </simpleType> </pre>
--	---

simpleType enum_0067

namespace	http://xml.ir-d.de/emg		
type	restriction of string		
properties	base xs:string		
used by	element ArtikelidentifikationBasis/ARI ArtikelArtSchluessel		
facets	Kind	Value	Annotation
	enumeration	0067001	documentation Implantat
	enumeration	0067002	documentation Explantat
annotation	documentation Kat_ArtArtikel		
source	<pre> <simpleType name="enum_0067"> <annotation> <documentation>Kat_ArtArtikel</documentation> </annotation> <restriction base="xs:string"> <enumeration value="0067001"> <annotation> <documentation>Implantat</documentation> </annotation> </enumeration> <enumeration value="0067002"> <annotation> <documentation>Explantat</documentation> </annotation> </enumeration> </restriction> </simpleType> </pre>		

simpleType enum_0068

namespace	http://xml.ir-d.de/emg		
type	restriction of string		
properties	base xs:string		
used by	element ArtikelidentifikationBasis/ARI KennzeichenTypSchluessel		
facets	Kind	Value	Annotation
	enumeration	0068001	documentation UDI
	enumeration	0068002	documentation Referenz (REF)
	enumeration	0068003	documentation Katalognummer
	enumeration	0068042	documentation sonstiger
annotation	documentation Kat_KennzeichenTyp		
source	<pre> <simpleType name="enum_0068"> <annotation> <documentation>Kat_KennzeichenTyp</documentation> </annotation> <restriction base="xs:string"> <enumeration value="0068001"> <annotation> <documentation>UDI</documentation> </annotation> </enumeration> <enumeration value="0068002"> <annotation> <documentation>Referenz (REF)</documentation> </annotation> </enumeration> <enumeration value="0068003"> <annotation> <documentation>Katalognummer</documentation> </annotation> </enumeration> <enumeration value="0068042"> <annotation> <documentation>sonstiger</documentation> </annotation> </enumeration> </restriction> </simpleType> </pre>		

simpleType enum_0069

namespace	http://xml.ir-d.de/emg		
type	restriction of string		
properties	base xs:string		
used by	element ZubehoerBasis/ZUB ZubehoerArtSchluessel		
facets	Kind	Value	Annotation
	enumeration	0069001	documentation Implantat
	enumeration	0069002	documentation

	Explantat
annotation	documentation Kat ArtZubehoer
source	<pre> <simpleType name="enum_0069"> <annotation> <documentation>Kat_ArtZubehoer</documentation> </annotation> <restriction base="xs:string"> <enumeration value="0069001"> <annotation> <documentation>Implantat</documentation> </annotation> </enumeration> <enumeration value="0069002"> <annotation> <documentation>Explantat</documentation> </annotation> </enumeration> </restriction> </simpleType> </pre>

simpleType enum_0070

namespace	http://xml.ir-d.de/emg		
type	restriction of string		
properties	base xs:string		
used by	element PatientenaufnahmeBasis/PAT GeschlechtSchluesel		
facets	Kind	Value	Annotation
	enumeration	0070001	documentation weiblich
	enumeration	0070002	documentation männlich
	enumeration	0070003	documentation divers
	enumeration	0070042	documentation unbestimmt
annotation	documentation Kat_Geschlecht		
source	<pre> <simpleType name="enum_0070"> <annotation> <documentation>Kat_Geschlecht</documentation> </annotation> <restriction base="xs:string"> <enumeration value="0070001"> <annotation> <documentation>weiblich</documentation> </annotation> </enumeration> <enumeration value="0070002"> <annotation> <documentation>männlich</documentation> </annotation> </enumeration> <enumeration value="0070003"> <annotation> <documentation>divers</documentation> </annotation> </enumeration> </restriction> </simpleType> </pre>		

	<pre> </annotation> </enumeration> <enumeration value="0070042"> <annotation> <documentation>unbestimmt</documentation> </annotation> </enumeration> </restriction> </simpleType> </pre>
--	--

simpleType enum_0071

namespace	http://xml.ir-d.de/emg												
type	restriction of string												
properties	base xs:string												
used by	element ArtikelidentifikationBasis/ARI ArtikelArtFunktionSchluessel												
facets	<table border="1"> <thead> <tr> <th>Kind</th> <th>Value</th> <th>Annotation</th> </tr> </thead> <tbody> <tr> <td>enumeration</td> <td>0071001</td> <td>documentation Implantat</td> </tr> <tr> <td>enumeration</td> <td>0071002</td> <td>documentation Explantat</td> </tr> <tr> <td>enumeration</td> <td>0071003</td> <td>documentation Degeneriertes/defektes Produkt, das funktionslos im Körper verbleibt</td> </tr> </tbody> </table>	Kind	Value	Annotation	enumeration	0071001	documentation Implantat	enumeration	0071002	documentation Explantat	enumeration	0071003	documentation Degeneriertes/defektes Produkt, das funktionslos im Körper verbleibt
Kind	Value	Annotation											
enumeration	0071001	documentation Implantat											
enumeration	0071002	documentation Explantat											
enumeration	0071003	documentation Degeneriertes/defektes Produkt, das funktionslos im Körper verbleibt											
annotation	documentation Kat_ArtikelArtFunktion												
source	<pre> <simpleType name="enum_0071"> <annotation> <documentation>Kat_ArtikelArtFunktion</documentation> </annotation> <restriction base="xs:string"> <enumeration value="0071001"> <annotation> <documentation>Implantat</documentation> </annotation> </enumeration> <enumeration value="0071002"> <annotation> <documentation>Explantat</documentation> </annotation> </enumeration> <enumeration value="0071003"> <annotation> <documentation>Degeneriertes/defektes Produkt, das funktionslos im Körper verbleibt</documentation> </annotation> </enumeration> </restriction> </simpleType> </pre>												

simpleType enum_0075

namespace	http://xml.ir-d.de/emg
type	restriction of string

properties	base xs:string												
used by	element OperationEndoprotheseBasis/OEP DringlichkeitSchluessel												
facets	<table border="1"> <thead> <tr> <th>Kind</th> <th>Value</th> <th>Annotation</th> </tr> </thead> <tbody> <tr> <td>enumeration</td> <td>0075001</td> <td>documentation elektiv</td> </tr> <tr> <td>enumeration</td> <td>0075002</td> <td>documentation dringlich</td> </tr> <tr> <td>enumeration</td> <td>0075003</td> <td>documentation Notfall</td> </tr> </tbody> </table>	Kind	Value	Annotation	enumeration	0075001	documentation elektiv	enumeration	0075002	documentation dringlich	enumeration	0075003	documentation Notfall
Kind	Value	Annotation											
enumeration	0075001	documentation elektiv											
enumeration	0075002	documentation dringlich											
enumeration	0075003	documentation Notfall											
annotation	documentation Kat_Dringlichkeit												
source	<pre> <simpleType name="enum_0075"> <annotation> <documentation>Kat_Dringlichkeit</documentation> </annotation> <restriction base="xs:string"> <enumeration value="0075001"> <annotation> <documentation>elektiv</documentation> </annotation> </enumeration> <enumeration value="0075002"> <annotation> <documentation>dringlich</documentation> </annotation> </enumeration> <enumeration value="0075003"> <annotation> <documentation>Notfall</documentation> </annotation> </enumeration> </restriction> </simpleType> </pre>												

simpleType enum_0076

namespace	http://xml.ir-d.de/emg															
type	restriction of string															
properties	base xs:string															
used by	element OperationAortenklappeBasis/OAK DringlichkeitSchluessel															
facets	<table border="1"> <thead> <tr> <th>Kind</th> <th>Value</th> <th>Annotation</th> </tr> </thead> <tbody> <tr> <td>enumeration</td> <td>0076001</td> <td>documentation elektiv</td> </tr> <tr> <td>enumeration</td> <td>0076002</td> <td>documentation dringlich</td> </tr> <tr> <td>enumeration</td> <td>0076003</td> <td>documentation Notfall</td> </tr> <tr> <td>enumeration</td> <td>0076004</td> <td>documentation Notfall (Reanimation / ultima ratio)</td> </tr> </tbody> </table>	Kind	Value	Annotation	enumeration	0076001	documentation elektiv	enumeration	0076002	documentation dringlich	enumeration	0076003	documentation Notfall	enumeration	0076004	documentation Notfall (Reanimation / ultima ratio)
Kind	Value	Annotation														
enumeration	0076001	documentation elektiv														
enumeration	0076002	documentation dringlich														
enumeration	0076003	documentation Notfall														
enumeration	0076004	documentation Notfall (Reanimation / ultima ratio)														
annotation	documentation Kat_Dringlichkeit_Reanimation															
source	<pre> <simpleType name="enum_0076"> <annotation> <documentation>Kat_Dringlichkeit_Reanimation</documentation> </annotation> <restriction base="xs:string"> </pre>															

	<pre> <enumeration value="0076001"> <annotation> <documentation>elektiv</documentation> </annotation> </enumeration> <enumeration value="0076002"> <annotation> <documentation>dringlich</documentation> </annotation> </enumeration> <enumeration value="0076003"> <annotation> <documentation>Notfall</documentation> </annotation> </enumeration> <enumeration value="0076004"> <annotation> <documentation>Notfall (Reanimation / ultima ratio)</documentation> </annotation> </enumeration> </restriction> </simpleType> </pre>
--	--

simpleType enum_0080

namespace	http://xml.ir-d.de/emg		
type	restriction of string		
properties	base xs:string		
used by	element	OperationBasis/OPE ImplantattypSchluessel	
facets	Kind	Value	Annotation
	enumeration	0080001	documentation Endoprothese Hüfte/Knie
	enumeration	0080002	documentation Brustimplantat
	enumeration	0080003	documentation Aortenklappenprothese
annotation	documentation Kat_Implantattyp		
source	<pre> <simpleType name="enum_0080"> <annotation> <documentation>Kat_Implantattyp</documentation> </annotation> <restriction base="xs:string"> <enumeration value="0080001"> <annotation> <documentation>Endoprothese Hüfte/Knie</documentation> </annotation> </enumeration> <enumeration value="0080002"> <annotation> <documentation>Brustimplantat</documentation> </annotation> </enumeration> <enumeration value="0080003"> <annotation> <documentation>Aortenklappenprothese</documentation> </annotation> </enumeration> </restriction> </simpleType> </pre>		

	<pre> </annotation> </enumeration> </restriction> </simpleType> </pre>
--	--

simpleType enum_0100

namespace	http://xml.ir-d.de/emg		
type	restriction of string		
properties	base xs:string		
used by	element OperationBrustimplantatBasis/OBI ArtEingriffSchluessel		
facets	Kind	Value	Annotation
	enumeration	0100001	documentation Primäreingriff
	enumeration	0100002	documentation Austausch Expander gegen dauerhaftes Brustimplantat
	enumeration	0100003	documentation Revision
	enumeration	0100004	documentation Nur Explantation
annotation	documentation Kat BI_ArtEingriff		
source	<pre> <simpleType name="enum_0100"> <annotation> <documentation>Kat_BI_ArtEingriff</documentation> </annotation> <restriction base="xs:string"> <enumeration value="0100001"> <annotation> <documentation>Primäreingriff</documentation> </annotation> </enumeration> <enumeration value="0100002"> <annotation> <documentation>Austausch Expander gegen dauerhaftes Brustimplantat</documentation> </annotation> </enumeration> <enumeration value="0100003"> <annotation> <documentation>Revision</documentation> </annotation> </enumeration> <enumeration value="0100004"> <annotation> <documentation>Nur Explantation</documentation> </annotation> </enumeration> </restriction> </simpleType> </pre>		

simpleType enum_0102

namespace	http://xml.ir-d.de/emg
-----------	------------------------

type	restriction of string		
properties	base xs:string		
used by	element OperationBrustimplantatBasis/OBI GrundPrimaer EingriffSchlüssel		
facets	Kind	Value	Annotation
	enumeration	0102001	documentation kosmetische Augmentation
	enumeration	0102002	documentation Rekonstruktion, benigne
	enumeration	0102003	documentation Rekonstruktion nach Mastektomie aufgrund eines Karzinoms
	enumeration	0102004	documentation Rekonstruktion nach risikoreduzierender Mastektomie
annotation	documentation Kat_BI_GrundPrimaereingriff		
source	<pre> <simpleType name="enum_0102"> <annotation> <documentation>Kat_BI_GrundPrimaereingriff</documentation> </annotation> <restriction base="xs:string"> <enumeration value="0102001"> <annotation> <documentation>kosmetische Augmentation</documentation> </annotation> </enumeration> <enumeration value="0102002"> <annotation> <documentation>Rekonstruktion, benigne</documentation> </annotation> </enumeration> <enumeration value="0102003"> <annotation> <documentation>Rekonstruktion nach Mastektomie aufgrund eines Karzinoms</documentation> </annotation> </enumeration> <enumeration value="0102004"> <annotation> <documentation>Rekonstruktion nach risikoreduzierender Mastektomie</documentation> </annotation> </enumeration> </restriction> </simpleType> </pre>		

simpleType **enum_0103**

namespace	http://xml.ir-d.de/emg		
type	restriction of string		
properties	base xs:string		
used by	element OperationsdetailBrustimplantatBasis/ODB OperationsdetailPrimaer EingriffSchlüssel		
facets	Kind	Value	Annotation
	enumeration	0103001	documentation simultane Lappendeckung
	enumeration	0103002	documentation simultane Eigenfetttransplantation

	<p>enumeration 0103003 documentation simultane Mastopexie</p> <p>enumeration 0103005 documentation simultane Mastektomie, Ablatio / hautsparend</p> <p>enumeration 0103006 documentation simultane Mastektomie, nippelerhaltend</p> <p>enumeration 0103007 documentation Axilla-Dissektion</p> <p>enumeration 0103008 documentation Drainage</p>
annotation	documentation Kat_BI_OperationsdetailPrimaereingriff
source	<pre> <simpleType name="enum_0103"> <annotation> <documentation>Kat_BI_OperationsdetailPrimaereingriff</documentation> </annotation> <restriction base="xs:string"> <enumeration value="0103001"> <annotation> <documentation>simultane Lappendeckung</documentation> </annotation> </enumeration> <enumeration value="0103002"> <annotation> <documentation>simultane Eigenfetttransplantation</documentation> </annotation> </enumeration> <enumeration value="0103003"> <annotation> <documentation>simultane Mastopexie</documentation> </annotation> </enumeration> <enumeration value="0103005"> <annotation> <documentation>simultane Mastektomie, Ablatio / hautsparend</documentation> </annotation> </enumeration> <enumeration value="0103006"> <annotation> <documentation>simultane Mastektomie, nippelerhaltend</documentation> </annotation> </enumeration> <enumeration value="0103007"> <annotation> <documentation>Axilla-Dissektion</documentation> </annotation> </enumeration> <enumeration value="0103008"> <annotation> <documentation>Drainage</documentation> </annotation> </enumeration> </restriction> </simpleType> </pre>

simpleType enum_0104

namespace	http://xml.ir-d.de/emg		
type	restriction of string		
properties	base xs:string		
used by	element OperationBrustimplantatBasis/OBI GrundAustauschSchluessel		
facets	Kind	Value	Annotation
	enumeration	0104001	documentation Austausch Expander gegen dauerhaftes Brustimplantat
annotation	documentation Kat_BI_GrundAustausch		
source	<pre> <simpleType name="enum_0104"> <annotation> <documentation>Kat_BI_GrundAustausch</documentation> </annotation> <restriction base="xs:string"> <enumeration value="0104001"> <annotation> <documentation>Austausch Expander gegen dauerhaftes Brustimplantat</documentation> </annotation> </enumeration> </restriction> </simpleType> </pre>		

simpleType enum_0105

namespace	http://xml.ir-d.de/emg		
type	restriction of string		
properties	base xs:string		
used by	element OperationsdetailBrustimplantatBasis/ODB OperationsdetailAustauschSchluessel		
facets	Kind	Value	Annotation
	enumeration	0105001	documentation simultane Lappendeckung
	enumeration	0105002	documentation simultane Eigenfetttransplantation
	enumeration	0105003	documentation simultane Mastopexie
	enumeration	0105008	documentation Drainage
	enumeration	0105009	documentation Kapsulektomie, komplett
	enumeration	0105010	documentation Kapsulektomie, partiell
	enumeration	0105011	documentation Neopocket
annotation	documentation Kat_BI_OperationsdetailAustausch		
source	<pre> <simpleType name="enum_0105"> <annotation> <documentation>Kat_BI_OperationsdetailAustausch</documentation> </annotation> <restriction base="xs:string"> <enumeration value="0105001"> <annotation> </pre>		

	<pre> <documentation>simultane Lappendeckung</documentation> </annotation> </enumeration> <enumeration value="0105002"> <annotation> <documentation>simultane Eigenfetttransplantation</documentation> </annotation> </enumeration> <enumeration value="0105003"> <annotation> <documentation>simultane Mastopexie</documentation> </annotation> </enumeration> <enumeration value="0105008"> <annotation> <documentation>Drainage</documentation> </annotation> </enumeration> <enumeration value="0105009"> <annotation> <documentation>Kapsulektomie, komplett</documentation> </annotation> </enumeration> <enumeration value="0105010"> <annotation> <documentation>Kapsulektomie, partiell</documentation> </annotation> </enumeration> <enumeration value="0105011"> <annotation> <documentation>Neopocket</documentation> </annotation> </enumeration> </restriction> </simpleType> </pre>
--	--

simpleType enum_0106

namespace	http://xml.ir-d.de/emg		
type	restriction of string		
properties	base xs:string		
used by	element OperationBrustimplantatBasis/OBI GrundRevisionExplantationSchluessel		
facets	Kind	Value	Annotation
	enumeration	0106001	documentation Patientenwunsch
	enumeration	0106002	documentation asymptomatisch
	enumeration	0106003	documentation Komplikation
annotation	documentation Kat BI_GrundRevisionExplantation		
source	<pre> <simpleType name="enum_0106"> <annotation> <documentation>Kat_BI_GrundRevisionExplantation</documentation> </annotation> <restriction base="xs:string"> </pre>		

	<pre> <enumeration value="0106001"> <annotation> <documentation>Patientenwunsch</documentation> </annotation> </enumeration> <enumeration value="0106002"> <annotation> <documentation>asymptomatisch</documentation> </annotation> </enumeration> <enumeration value="0106003"> <annotation> <documentation>Komplikation</documentation> </annotation> </enumeration> </restriction> </simpleType> </pre>
--	--

simpleType enum 0107

namespace	http://xml.ir-d.de/emg		
type	restriction of string		
properties	base xs:string		
used by	element OperationsdetailBrustimplantatBasis/ODB OperationsdetailRevisionSchluessel		
facets	Kind	Value	Annotation
	enumeration	0107001	documentation simultane Lappendeckung
	enumeration	0107002	documentation simultane Eigenfetttransplantation
	enumeration	0107003	documentation simultane Mastopexie
	enumeration	0107005	documentation simultane Mastektomie, Ablatio / hautsparend
	enumeration	0107006	documentation simultane Mastektomie, nippelerhaltend
	enumeration	0107007	documentation Axilla-Dissektion
	enumeration	0107008	documentation Drainage
	enumeration	0107009	documentation Kapsulektomie, komplett
	enumeration	0107010	documentation Kapsulektomie, partiell
	enumeration	0107011	documentation Neopocket
annotation	documentation Kat_BI_OperationsdetailRevision		
source	<pre> <simpleType name="enum_0107"> <annotation> <documentation>Kat_BI_OperationsdetailRevision</documentation> </annotation> <restriction base="xs:string"> <enumeration value="0107001"> <annotation> <documentation>simultane Lappendeckung</documentation> </annotation> </enumeration> </pre>		

```

<enumeration value="0107002">
  <annotation>
    <documentation>simultane Eigenfetttransplantation</documentation>
  </annotation>
</enumeration>
<enumeration value="0107003">
  <annotation>
    <documentation>simultane Mastopexie</documentation>
  </annotation>
</enumeration>
<enumeration value="0107005">
  <annotation>
    <documentation>simultane Mastektomie, Ablatio /
hautsparend</documentation>
  </annotation>
</enumeration>
<enumeration value="0107006">
  <annotation>
    <documentation>simultane Mastektomie, nippelerhaltend</documentation>
  </annotation>
</enumeration>
<enumeration value="0107007">
  <annotation>
    <documentation>Axilla-Dissektion</documentation>
  </annotation>
</enumeration>
<enumeration value="0107008">
  <annotation>
    <documentation>Drainage</documentation>
  </annotation>
</enumeration>
<enumeration value="0107009">
  <annotation>
    <documentation>Kapsulektomie, komplett</documentation>
  </annotation>
</enumeration>
<enumeration value="0107010">
  <annotation>
    <documentation>Kapsulektomie, partiell</documentation>
  </annotation>
</enumeration>
<enumeration value="0107011">
  <annotation>
    <documentation>Neopocket</documentation>
  </annotation>
</enumeration>
</restriction>
</simpleType>

```

simpleType enum_0110

namespace	http://xml.ir-d.de/emg
type	restriction of string
properties	base xs:string
used by	element VorbereitungBrustimplantatBasis/VBI_BehandlungLokalSchlüssel

facets	Kind enumeration	Value 0110001	Annotation documentation Bestrahlung
annotation	documentation Kat_BI_VorbehandlungLokal		
source	<pre><simpleType name="enum_0110"> <annotation> <documentation>Kat_BI_VorbehandlungLokal</documentation> </annotation> <restriction base="xs:string"> <enumeration value="0110001"> <annotation> <documentation>Bestrahlung</documentation> </annotation> </enumeration> </restriction> </simpleType></pre>		

simpleType **enum_0111**

namespace	http://xml.ir-d.de/emg		
type	restriction of string		
properties	base xs:string		
used by	element OperationBrustimplantatBasis/OBI_VerfahrenswechselSchluessel		
facets	Kind enumeration	Value 0111001	Annotation documentation nein
	enumeration	0111002	documentation Lipofilling
	enumeration	0111003	documentation Eigengewebstrekonstruktion
annotation	documentation Kat_BI_Verfahrenswechsel		
source	<pre><simpleType name="enum_0111"> <annotation> <documentation>Kat_BI_Verfahrenswechsel</documentation> </annotation> <restriction base="xs:string"> <enumeration value="0111001"> <annotation> <documentation>nein</documentation> </annotation> </enumeration> <enumeration value="0111002"> <annotation> <documentation>Lipofilling</documentation> </annotation> </enumeration> <enumeration value="0111003"> <annotation> <documentation>Eigengewebstrekonstruktion</documentation> </annotation> </enumeration> </restriction> </simpleType></pre>		

simpleType enum_0112

namespace	http://xml.ir-d.de/emg		
type	restriction of string		
properties	base xs:string		
used by	element OperationBrustimplantatBasis/OBI LageSchlüssel		
facets	Kind	Value	Annotation
	enumeration	0112001	documentation subglandulär / epipektoral
	enumeration	0112002	documentation subpektoral
	enumeration	0112003	documentation subfaszial
	enumeration	0112004	documentation sub-flap
	enumeration	0112005	documentation subkutan
	enumeration	0112006	documentation dual plane
	enumeration	0112042	documentation andere
annotation	documentation Kat_BI_LageImplantat		
source	<pre> <simpleType name="enum_0112"> <annotation> <documentation>Kat_BI_LageImplantat</documentation> </annotation> <restriction base="xs:string"> <enumeration value="0112001"> <annotation> <documentation>subglandulär / epipektoral</documentation> </annotation> </enumeration> <enumeration value="0112002"> <annotation> <documentation>subpektoral</documentation> </annotation> </enumeration> <enumeration value="0112003"> <annotation> <documentation>subfaszial</documentation> </annotation> </enumeration> <enumeration value="0112004"> <annotation> <documentation>sub-flap</documentation> </annotation> </enumeration> <enumeration value="0112005"> <annotation> <documentation>subkutan</documentation> </annotation> </enumeration> <enumeration value="0112006"> <annotation> <documentation>dual plane</documentation> </annotation> </enumeration> </restriction> </simpleType> </pre>		

	<pre> </enumeration> <enumeration value="0112042"> <annotation> <documentation>andere</documentation> </annotation> </enumeration> </restriction> </simpleType> </pre>
--	--

simpleType enum_0113

namespace	http://xml.ir-d.de/emg		
type	restriction of string		
properties	base xs:string		
used by	element VorbereitungBrustimplantatBasis/VBI BehandlungSystemischSchlüssel		
facets	Kind	Value	Annotation
	enumeration	0113001	documentation Chemotherapie innerhalb der letzten drei Monate
annotation	documentation Kat_BI_VorbereitungSystemisch		
source	<pre> <simpleType name="enum_0113"> <annotation> <documentation>Kat_BI_VorbereitungSystemisch</documentation> </annotation> <restriction base="xs:string"> <enumeration value="0113001"> <annotation> <documentation>Chemotherapie innerhalb der letzten drei Monate</documentation> </annotation> </enumeration> </restriction> </simpleType> </pre>		

simpleType enum_0114

namespace	http://xml.ir-d.de/emg		
type	restriction of string		
properties	base xs:string		
used by	element OperationBrustimplantatBasis/OBI EntfernungAdmNetzSchlüssel		
facets	Kind	Value	Annotation
	enumeration	0114001	documentation vollständig
	enumeration	0114002	documentation nein
	enumeration	0114003	documentation teilweise
	enumeration	0114004	documentation nicht vorhanden
annotation	documentation Kat_BI_EntfernungADMNetz		
source	<pre> <simpleType name="enum_0114"> <annotation> </pre>		

	<pre> <documentation>Kat_BI_EntfernungADMNetz</documentation> </annotation> <restriction base="xs:string"> <enumeration value="0114001"> <annotation> <documentation>vollständig</documentation> </annotation> </enumeration> <enumeration value="0114002"> <annotation> <documentation>nein</documentation> </annotation> </enumeration> <enumeration value="0114003"> <annotation> <documentation>teilweise</documentation> </annotation> </enumeration> <enumeration value="0114004"> <annotation> <documentation>nicht vorhanden</documentation> </annotation> </enumeration> </restriction> </simpleType> </pre>
--	---

simpleType enum_0116

namespace	http://xml.ir-d.de/emg		
type	restriction of string		
properties	base xs:string		
used by	element	MassnahmeBrustimplantatBasis/MAB MassnahmeSchluessel	
facets	Kind	Value	Annotation
	enumeration	0116001	documentation Spülung, antibiotisch
	enumeration	0116002	documentation Spülung, antiseptisch
	enumeration	0116003	documentation Spülung, wirkstofffrei
	enumeration	0116004	documentation Spülung, andere
	enumeration	0116005	documentation prä-/perioperative Antibiotika
	enumeration	0116006	documentation postoperative Antibiotika
	enumeration	0116007	documentation Handschuhwechsel vor Implantation
	enumeration	0116008	documentation Implantationshilfe
annotation	documentation	Kat_BI_Operationsmassnahme	
source	<pre> <simpleType name="enum_0116"> <annotation> <documentation>Kat_BI_Operationsmassnahme</documentation> </annotation> <restriction base="xs:string"> <enumeration value="0116001"> </pre>		

	<pre> <annotation> <documentation>Spülung, antibiotisch</documentation> </annotation> </enumeration> <enumeration value="0116002"> <annotation> <documentation>Spülung, antiseptisch</documentation> </annotation> </enumeration> <enumeration value="0116003"> <annotation> <documentation>Spülung, wirkstofffrei</documentation> </annotation> </enumeration> <enumeration value="0116004"> <annotation> <documentation>Spülung, andere</documentation> </annotation> </enumeration> <enumeration value="0116005"> <annotation> <documentation>prä-/perioperative Antibiotika</documentation> </annotation> </enumeration> <enumeration value="0116006"> <annotation> <documentation>postoperative Antibiotika</documentation> </annotation> </enumeration> <enumeration value="0116007"> <annotation> <documentation>Handschuhwechsel vor Implantation</documentation> </annotation> </enumeration> <enumeration value="0116008"> <annotation> <documentation>Implantationshilfe</documentation> </annotation> </enumeration> </restriction> </simpleType> </pre>
--	--

simpleType enum_0118

namespace	http://xml.ir-d.de/emg		
type	restriction of string		
properties	base xs:string		
used by	element OperationBrustimplantatBasis/OBI ZugangSchluessel		
facets	Kind	Value	Annotation
	enumeration	0118001	documentation axillär
	enumeration	0118002	documentation periareolär
	enumeration	0118003	documentation inframammär
	enumeration	0118004	documentation Mastektomienarbe

	enumeration 0118042 documentation anderer
annotation	documentation Kat_BI_Operationszugang
source	<pre> <simpleType name="enum_0118"> <annotation> <documentation>Kat_BI_Operationszugang</documentation> </annotation> <restriction base="xs:string"> <enumeration value="0118001"> <annotation> <documentation>axillär</documentation> </annotation> </enumeration> <enumeration value="0118002"> <annotation> <documentation>periareolär</documentation> </annotation> </enumeration> <enumeration value="0118003"> <annotation> <documentation>inframammär</documentation> </annotation> </enumeration> <enumeration value="0118004"> <annotation> <documentation>Mastektomienarbe</documentation> </annotation> </enumeration> <enumeration value="0118042"> <annotation> <documentation>anderer</documentation> </annotation> </enumeration> </restriction> </simpleType> </pre>

simpleType enum_0120

namespace	http://xml.ir-d.de/emg		
type	restriction of string		
properties	base xs:string		
used by	element	BefundBrustimplantatBasis/BEB BefundAustauschSchluessel	
facets	Kind	Value	Annotation
	enumeration	0120001	documentation Expander defekt
annotation	documentation Kat_BI_BefundAustausch		
source	<pre> <simpleType name="enum_0120"> <annotation> <documentation>Kat_BI_BefundAustausch</documentation> </annotation> <restriction base="xs:string"> <enumeration value="0120001"> <annotation> <documentation>Expander defekt</documentation> </annotation> </enumeration> </restriction> </simpleType> </pre>		

```

</annotation>
</enumeration>
</restriction>
</simpleType>

```

simpleType enum_0121

namespace	http://xml.ir-d.de/emg		
type	restriction of string		
properties	base xs:string		
used by	element BefundBrustimplantatBasis/BEB BefundSchluessel		
facets	Kind	Value	Annotation
	enumeration	0121001	documentation Infektion
	enumeration	0121002	documentation Serom
	enumeration	0121003	documentation Hämatom
	enumeration	0121004	documentation Kapselfibrose
	enumeration	0121005	documentation Implantatruptur
	enumeration	0121006	documentation Fehlpositionierung/Rotation
	enumeration	0121007	documentation BIA-ALCL/-SCC, Verdacht
	enumeration	0121008	documentation BIA-ALCL/-SCC, pathologisch bestätigt
	enumeration	0121009	documentation Brustschmerzen
	enumeration	0121010	documentation Doppelkapsel
	enumeration	0121011	documentation Netz-/ADM-bedingte Komplikation, Non-Integration
	enumeration	0121012	documentation Netz-/ADM-bedingte Komplikation, andere
	enumeration	0121013	documentation Hautnekrose/exponiertes Implantat
	enumeration	0121014	documentation BII/ASIA (Brustimplantat assoziierte Symptome), Verdacht
	enumeration	0121015	documentation Lymphadenopathie
	enumeration	0121016	documentation Brustkrebs, neu aufgetreten/Rezidiv
annotation	documentation Kat_BI_BefundKomplett		
source	<pre> <simpleType name="enum_0121"> <annotation> <documentation>Kat_BI_BefundKomplett</documentation> </annotation> <restriction base="xs:string"> <enumeration value="0121001"> <annotation> <documentation>Infektion</documentation> </annotation> </enumeration> <enumeration value="0121002"> <annotation> <documentation>Serom</documentation> </pre>		

```

</annotation>
</enumeration>
<enumeration value="0121003">
  <annotation>
    <documentation>Hämatom</documentation>
  </annotation>
</enumeration>
<enumeration value="0121004">
  <annotation>
    <documentation>Kapselfibrose</documentation>
  </annotation>
</enumeration>
<enumeration value="0121005">
  <annotation>
    <documentation>Implantatruptur</documentation>
  </annotation>
</enumeration>
<enumeration value="0121006">
  <annotation>
    <documentation>Fehlpositionierung/Rotation</documentation>
  </annotation>
</enumeration>
<enumeration value="0121007">
  <annotation>
    <documentation>BIA-ALCL/-SCC, Verdacht</documentation>
  </annotation>
</enumeration>
<enumeration value="0121008">
  <annotation>
    <documentation>BIA-ALCL/-SCC, pathologisch bestätigt</documentation>
  </annotation>
</enumeration>
<enumeration value="0121009">
  <annotation>
    <documentation>Brustschmerzen</documentation>
  </annotation>
</enumeration>
<enumeration value="0121010">
  <annotation>
    <documentation>Doppelkapsel</documentation>
  </annotation>
</enumeration>
<enumeration value="0121011">
  <annotation>
    <documentation>Netz-/ADM-bedingte Komplikation,
Non-Integration</documentation>
  </annotation>
</enumeration>
<enumeration value="0121012">
  <annotation>
    <documentation>Netz-/ADM-bedingte Komplikation, andere</documentation>
  </annotation>
</enumeration>
<enumeration value="0121013">
  <annotation>
    <documentation>Hautnekrose/exponiertes Implantat</documentation>
  </annotation>
</enumeration>
<enumeration value="0121014">

```

	<pre> <annotation> <documentation>BII/ASIA (Brustimplantat assoziierte Symptome), Verdacht</documentation> </annotation> </enumeration> <enumeration value="0121015"> <annotation> <documentation>Lymphadenopathie</documentation> </annotation> </enumeration> <enumeration value="0121016"> <annotation> <documentation>Brustkrebs, neu aufgetreten/Rezidiv</documentation> </annotation> </enumeration> </restriction> </simpleType> </pre>
--	--

simpleType enum_0122

namespace	http://xml.ir-d.de/emg		
type	restriction of string		
properties	base xs:string		
used by	element PatientenaufnahmeBrustimplantatBasis/PAB AutoimmunerkrankungSchluessel		
facets	Kind	Value	Annotation
	enumeration	0122001	documentation ja, ärztlich nachgewiesen
	enumeration	0122002	documentation nein
	enumeration	0122042	documentation unbekannt
annotation	documentation Kat_BI_Autoimmunerkrankung		
source	<pre> <simpleType name="enum_0122"> <annotation> <documentation>Kat_BI_Autoimmunerkrankung</documentation> </annotation> <restriction base="xs:string"> <enumeration value="0122001"> <annotation> <documentation>ja, ärztlich nachgewiesen</documentation> </annotation> </enumeration> <enumeration value="0122002"> <annotation> <documentation>nein</documentation> </annotation> </enumeration> <enumeration value="0122042"> <annotation> <documentation>unbekannt</documentation> </annotation> </enumeration> </restriction> </simpleType> </pre>		

simpleType enum_0123

namespace	http://xml.ir-d.de/emg		
type	restriction of string		
properties	base xs:string		
used by	element PatientenaufnahmeBrustimplantatBasis/PAB VerlaufAutoimmunerkrankungSchluessel		
facets	Kind	Value	Annotation
	enumeration	0123001	documentation neu aufgetreten
	enumeration	0123002	documentation verschlechtert
	enumeration	0123003	documentation keine Veränderung
	enumeration	0123004	documentation nicht relevant, da Primäreingriff
	enumeration	0123042	documentation unbekannt
annotation	documentation Kat_BI_VerlaufAutoimmunerkrankung		
source	<pre> <simpleType name="enum_0123"> <annotation> <documentation>Kat_BI_VerlaufAutoimmunerkrankung</documentation> </annotation> <restriction base="xs:string"> <enumeration value="0123001"> <annotation> <documentation>neu aufgetreten</documentation> </annotation> </enumeration> <enumeration value="0123002"> <annotation> <documentation>verschlechtert</documentation> </annotation> </enumeration> <enumeration value="0123003"> <annotation> <documentation>keine Veränderung</documentation> </annotation> </enumeration> <enumeration value="0123004"> <annotation> <documentation>nicht relevant, da Primäreingriff</documentation> </annotation> </enumeration> <enumeration value="0123042"> <annotation> <documentation>unbekannt</documentation> </annotation> </enumeration> </restriction> </simpleType> </pre>		

simpleType enum_0124

namespace	http://xml.ir-d.de/emg
-----------	------------------------

type	restriction of string															
properties	base xs:string															
used by	element ArtikelBrustimplantatBasis/ABI_FuellungSchluessel															
facets	<table border="1"> <thead> <tr> <th>Kind</th> <th>Value</th> <th>Annotation</th> </tr> </thead> <tbody> <tr> <td>enumeration</td> <td>0124001</td> <td>documentation Salzlösung</td> </tr> <tr> <td>enumeration</td> <td>0124002</td> <td>documentation Silikongel</td> </tr> <tr> <td>enumeration</td> <td>0124003</td> <td>documentation Kombination Silikongel und Salzlösung</td> </tr> <tr> <td>enumeration</td> <td>0124042</td> <td>documentation sonstige</td> </tr> </tbody> </table>	Kind	Value	Annotation	enumeration	0124001	documentation Salzlösung	enumeration	0124002	documentation Silikongel	enumeration	0124003	documentation Kombination Silikongel und Salzlösung	enumeration	0124042	documentation sonstige
Kind	Value	Annotation														
enumeration	0124001	documentation Salzlösung														
enumeration	0124002	documentation Silikongel														
enumeration	0124003	documentation Kombination Silikongel und Salzlösung														
enumeration	0124042	documentation sonstige														
annotation	documentation Kat_BI_Fuellung															
source	<pre> <simpleType name="enum_0124"> <annotation> <documentation>Kat_BI_Fuellung</documentation> </annotation> <restriction base="xs:string"> <enumeration value="0124001"> <annotation> <documentation>Salzlösung</documentation> </annotation> </enumeration> <enumeration value="0124002"> <annotation> <documentation>Silikongel</documentation> </annotation> </enumeration> <enumeration value="0124003"> <annotation> <documentation>Kombination Silikongel und Salzlösung</documentation> </annotation> </enumeration> <enumeration value="0124042"> <annotation> <documentation>sonstige</documentation> </annotation> </enumeration> </restriction> </simpleType> </pre>															

simpleType **enum_0126**

namespace	http://xml.ir-d.de/emg												
type	restriction of string												
properties	base xs:string												
used by	element ArtikelBrustimplantatBasis/ABI_FormSchluessel												
facets	<table border="1"> <thead> <tr> <th>Kind</th> <th>Value</th> <th>Annotation</th> </tr> </thead> <tbody> <tr> <td>enumeration</td> <td>0126001</td> <td>documentation anatomisch (tropfenförmig)</td> </tr> <tr> <td>enumeration</td> <td>0126002</td> <td>documentation rund (punktsymmetrisch)</td> </tr> <tr> <td>enumeration</td> <td>0126042</td> <td>documentation sonstige</td> </tr> </tbody> </table>	Kind	Value	Annotation	enumeration	0126001	documentation anatomisch (tropfenförmig)	enumeration	0126002	documentation rund (punktsymmetrisch)	enumeration	0126042	documentation sonstige
Kind	Value	Annotation											
enumeration	0126001	documentation anatomisch (tropfenförmig)											
enumeration	0126002	documentation rund (punktsymmetrisch)											
enumeration	0126042	documentation sonstige											

annotation	documentation Kat_BI_Form
source	<pre> <simpleType name="enum_0126"> <annotation> <documentation>Kat_BI_Form</documentation> </annotation> <restriction base="xs:string"> <enumeration value="0126001"> <annotation> <documentation>anatomisch (tropfenförmig)</documentation> </annotation> </enumeration> <enumeration value="0126002"> <annotation> <documentation>rund (punktsymmetrisch)</documentation> </annotation> </enumeration> <enumeration value="0126042"> <annotation> <documentation>sonstige</documentation> </annotation> </enumeration> </restriction> </simpleType> </pre>

simpleType **enum_0128**

namespace	http://xml.ir-d.de/emg		
type	restriction of string		
properties	base xs:string		
used by	element ArtikelBrustimplantatBasis/ABI OberflaecheSchluessel		
facets	Kind	Value	Annotation
	enumeration	0128001	documentation glattwandig
	enumeration	0128002	documentation beschichtet
	enumeration	0128003	documentation texturiert
annotation	documentation Kat_BI_Oberflaeche		
source	<pre> <simpleType name="enum_0128"> <annotation> <documentation>Kat_BI_Oberflaeche</documentation> </annotation> <restriction base="xs:string"> <enumeration value="0128001"> <annotation> <documentation>glattwandig</documentation> </annotation> </enumeration> <enumeration value="0128002"> <annotation> <documentation>beschichtet</documentation> </annotation> </enumeration> <enumeration value="0128003"> </pre>		

```

<annotation>
  <documentation>texturiert</documentation>
</annotation>
</enumeration>
</restriction>
</simpleType>

```

simpleType enum_0130

namespace	http://xml.ir-d.de/emg		
type	restriction of string		
properties	base xs:string		
used by	element ArtikelBrustimplantatBasis/ABI_HerstellerSchluessel		
facets	Kind	Value	Annotation
	enumeration	0130001	documentation Allergan
	enumeration	0130002	documentation Cereplas
	enumeration	0130003	documentation CUI (Cox Uphoff Implants)
	enumeration	0130004	documentation EMSI Biomedical
	enumeration	0130005	documentation Establishment labs
	enumeration	0130006	documentation Eurosilicone
	enumeration	0130007	documentation Nagor
	enumeration	0130008	documentation Groupe Sebbin
	enumeration	0130009	documentation Laboratoires Arion
	enumeration	0130010	documentation Mentor
	enumeration	0130011	documentation Pérouse Plastie SAS
	enumeration	0130012	documentation PIP M-Implants
	enumeration	0130013	documentation Polytech Health & Aesthetics
	enumeration	0130014	documentation Silimed
	enumeration	0130015	documentation Surgitek
	enumeration	0130016	documentation G&G Biotechnology
	enumeration	0130017	documentation nicht belegter Wert
	enumeration	0130018	documentation nicht belegter Wert
	enumeration	0130019	documentation nicht belegter Wert
	enumeration	0130020	documentation nicht belegter Wert
	enumeration	0130021	documentation nicht belegter Wert
	enumeration	0130042	documentation sonstiger
annotation	documentation Kat_Bl_Hersteller		

source

```
<simpleType name="enum_0130">
  <annotation>
    <documentation>Kat_BI_Hersteller</documentation>
  </annotation>
  <restriction base="xs:string">
    <enumeration value="0130001">
      <annotation>
        <documentation>Allergan</documentation>
      </annotation>
    </enumeration>
    <enumeration value="0130002">
      <annotation>
        <documentation>Cereplas</documentation>
      </annotation>
    </enumeration>
    <enumeration value="0130003">
      <annotation>
        <documentation>CUI (Cox Uphoff Implants)</documentation>
      </annotation>
    </enumeration>
    <enumeration value="0130004">
      <annotation>
        <documentation>EMSI Biomedical</documentation>
      </annotation>
    </enumeration>
    <enumeration value="0130005">
      <annotation>
        <documentation>Establishment labs</documentation>
      </annotation>
    </enumeration>
    <enumeration value="0130006">
      <annotation>
        <documentation>Eurosilicone</documentation>
      </annotation>
    </enumeration>
    <enumeration value="0130007">
      <annotation>
        <documentation>Nagor</documentation>
      </annotation>
    </enumeration>
    <enumeration value="0130008">
      <annotation>
        <documentation>Groupe Sebbin</documentation>
      </annotation>
    </enumeration>
    <enumeration value="0130009">
      <annotation>
        <documentation>Laboratoires Arion</documentation>
      </annotation>
    </enumeration>
    <enumeration value="0130010">
      <annotation>
        <documentation>Mentor</documentation>
      </annotation>
    </enumeration>
    <enumeration value="0130011">
      <annotation>
        <documentation>Pérouse Plastie SAS</documentation>
      </annotation>
    </enumeration>
  </restriction>
</simpleType>
```

```
</enumeration>
<enumeration value="0130012">
  <annotation>
    <documentation>PIP M-Implants</documentation>
  </annotation>
</enumeration>
<enumeration value="0130013">
  <annotation>
    <documentation>Polytech Health & Aesthetics</documentation>
  </annotation>
</enumeration>
<enumeration value="0130014">
  <annotation>
    <documentation>Silimed</documentation>
  </annotation>
</enumeration>
<enumeration value="0130015">
  <annotation>
    <documentation>Surgitek</documentation>
  </annotation>
</enumeration>
<enumeration value="0130016">
  <annotation>
    <documentation>G&G Biotechnology</documentation>
  </annotation>
</enumeration>
<enumeration value="0130017">
  <annotation>
    <documentation>nicht belegter Wert</documentation>
  </annotation>
</enumeration>
<enumeration value="0130018">
  <annotation>
    <documentation>nicht belegter Wert</documentation>
  </annotation>
</enumeration>
<enumeration value="0130019">
  <annotation>
    <documentation>nicht belegter Wert</documentation>
  </annotation>
</enumeration>
<enumeration value="0130020">
  <annotation>
    <documentation>nicht belegter Wert</documentation>
  </annotation>
</enumeration>
<enumeration value="0130021">
  <annotation>
    <documentation>nicht belegter Wert</documentation>
  </annotation>
</enumeration>
<enumeration value="0130042">
  <annotation>
    <documentation>sonstiger</documentation>
  </annotation>
</enumeration>
</restriction>
</simpleType>
```

simpleType enum_0131

namespace	http://xml.ir-d.de/emg		
type	restriction of string		
properties	base xs:string		
used by	element ZubehoerBrustimplantatBasis/ZBI_HerstellerSchluessel		
facets	Kind	Value	Annotation
	enumeration	0131001	documentation Allergan
	enumeration	0131002	documentation Establishment labs
	enumeration	0131003	documentation Eurosilicone
	enumeration	0131004	documentation Galatea
	enumeration	0131005	documentation Integra
	enumeration	0131006	documentation Lifecell
	enumeration	0131007	documentation MBP (Medical Biomaterial Products)
	enumeration	0131008	documentation Mentor
	enumeration	0131009	documentation Novus Scientific
	enumeration	0131042	documentation sonstiger
annotation	documentation Kat_BI_ZubehoerHersteller		
source	<pre> <simpleType name="enum_0131"> <annotation> <documentation>Kat_BI_ZubehoerHersteller</documentation> </annotation> <restriction base="xs:string"> <enumeration value="0131001"> <annotation> <documentation>Allergan</documentation> </annotation> </enumeration> <enumeration value="0131002"> <annotation> <documentation>Establishment labs</documentation> </annotation> </enumeration> <enumeration value="0131003"> <annotation> <documentation>Eurosilicone</documentation> </annotation> </enumeration> <enumeration value="0131004"> <annotation> <documentation>Galatea</documentation> </annotation> </enumeration> <enumeration value="0131005"> <annotation> <documentation>Integra</documentation> </annotation> </enumeration> </restriction> </simpleType> </pre>		

	<pre> </enumeration> <enumeration value="0131006"> <annotation> <documentation>Lifecell</documentation> </annotation> </enumeration> <enumeration value="0131007"> <annotation> <documentation>MBP (Medical Biomaterial Products)</documentation> </annotation> </enumeration> <enumeration value="0131008"> <annotation> <documentation>Mentor</documentation> </annotation> </enumeration> <enumeration value="0131009"> <annotation> <documentation>Novus Scientific</documentation> </annotation> </enumeration> <enumeration value="0131042"> <annotation> <documentation>sonstiger</documentation> </annotation> </enumeration> </restriction> </simpleType> </pre>
--	---

simpleType enum_0190

namespace	http://xml.ir-d.de/emg		
type	restriction of string		
properties	base xs:string		
used by	element ArtikelBrustimplantatBasis/ABI ArtikelTypSchluessel		
facets	Kind	Value	Annotation
	enumeration	0190001	documentation Brustimplantat
	enumeration	0190003	documentation Brustexpander
annotation	documentation Kat_BI_Artikeltyp		
source	<pre> <simpleType name="enum_0190"> <annotation> <documentation>Kat_BI_Artikeltyp</documentation> </annotation> <restriction base="xs:string"> <enumeration value="0190001"> <annotation> <documentation>Brustimplantat</documentation> </annotation> </enumeration> <enumeration value="0190003"> <annotation> <documentation>Brustexpander</documentation> </annotation> </enumeration> </restriction> </simpleType> </pre>		

	<pre> </enumeration> </restriction> </simpleType> </pre>
--	--

simpleType enum_0191

namespace	http://xml.ir-d.de/emg		
type	restriction of string		
properties	base xs:string		
used by	element ZubehoerBrustimplantatBasis/ZBI ZubehoerTypSchluessel		
facets	Kind	Value	Annotation
	enumeration	0191001	documentation Netz
	enumeration	0191002	documentation ADM
annotation	documentation Kat_BI_ZubehoerTyp		
source	<pre> <simpleType name="enum_0191"> <annotation> <documentation>Kat_BI_ZubehoerTyp</documentation> </annotation> <restriction base="xs:string"> <enumeration value="0191001"> <annotation> <documentation>Netz</documentation> </annotation> </enumeration> <enumeration value="0191002"> <annotation> <documentation>ADM</documentation> </annotation> </enumeration> </restriction> </simpleType> </pre>		

simpleType enum_0200

namespace	http://xml.ir-d.de/emg		
type	restriction of string		
properties	base xs:string		
used by	element OperationEndoprotheseBasis/OEP ArtEingriffSchluessel		
facets	Kind	Value	Annotation
	enumeration	0200001	documentation Erst-OP
	enumeration	0200002	documentation Folgeeingriff
annotation	documentation Kat_EP_ArtEingriff		
source	<pre> <simpleType name="enum_0200"> <annotation> <documentation>Kat_EP_ArtEingriff</documentation> </annotation> <restriction base="xs:string"> </pre>		

	<pre> <enumeration value="0200001"> <annotation> <documentation>Erst-OP</documentation> </annotation> </enumeration> <enumeration value="0200002"> <annotation> <documentation>Folgeeingriff</documentation> </annotation> </enumeration> </restriction> </simpleType> </pre>
--	---

simpleType enum_0202

namespace	http://xml.ir-d.de/emg		
type	restriction of string		
properties	base xs:string		
used by	element OperationEndprotheseBasis/OEP GrundWechselHuefteSchluessel		
facets	Kind	Value	Annotation
	enumeration	0202001	documentation Lockerung
	enumeration	0202002	documentation Infektion, Verdacht auf
	enumeration	0202003	documentation Infektion, gesichert
	enumeration	0202004	documentation Luxation, Inlay aus der Pfanne
	enumeration	0202005	documentation Luxation, Kopf aus Pfanne/Inlay
	enumeration	0202006	documentation Periprothetische Fraktur
	enumeration	0202007	documentation Verschleiß des PE-Inlays
	enumeration	0202008	documentation Implantatbruch
	enumeration	0202009	documentation Implantatfehlage/Malalignent
	enumeration	0202010	documentation Osteolysen bei festem Implantat
	enumeration	0202011	documentation Progression der Grunderkrankung
	enumeration	0202012	documentation ARMD
	enumeration	0202013	documentation Verdacht auf allergische Reaktion
	enumeration	0202021	documentation Zustand nach Prothesenentfernung
	enumeration	0202042	documentation andere Gründe
annotation	documentation Kat_EP_GrundWechselHuefte		
source	<pre> <simpleType name="enum_0202"> <annotation> <documentation>Kat_EP_GrundWechselHuefte</documentation> </annotation> <restriction base="xs:string"> <enumeration value="0202001"> </pre>		

```
<annotation>
  <documentation>Lockerung</documentation>
</annotation>
</enumeration>
<enumeration value="0202002">
  <annotation>
    <documentation>Infektion, Verdacht auf</documentation>
  </annotation>
</enumeration>
<enumeration value="0202003">
  <annotation>
    <documentation>Infektion, gesichert</documentation>
  </annotation>
</enumeration>
<enumeration value="0202004">
  <annotation>
    <documentation>Luxation, Inlay aus der Pfanne</documentation>
  </annotation>
</enumeration>
<enumeration value="0202005">
  <annotation>
    <documentation>Luxation, Kopf aus Pfanne/Inlay</documentation>
  </annotation>
</enumeration>
<enumeration value="0202006">
  <annotation>
    <documentation>Periprothetische Fraktur</documentation>
  </annotation>
</enumeration>
<enumeration value="0202007">
  <annotation>
    <documentation>Verschleiß des PE-Inlays</documentation>
  </annotation>
</enumeration>
<enumeration value="0202008">
  <annotation>
    <documentation>Implantatbruch</documentation>
  </annotation>
</enumeration>
<enumeration value="0202009">
  <annotation>
    <documentation>Implantatfehllage/Malalignent</documentation>
  </annotation>
</enumeration>
<enumeration value="0202010">
  <annotation>
    <documentation>Osteolysen bei festem Implantat</documentation>
  </annotation>
</enumeration>
<enumeration value="0202011">
  <annotation>
    <documentation>Progression der Grunderkrankung</documentation>
  </annotation>
</enumeration>
<enumeration value="0202012">
  <annotation>
    <documentation>ARMD</documentation>
  </annotation>
</enumeration>
```

```

<enumeration value="0202013">
  <annotation>
    <documentation>Verdacht auf allergische Reaktion</documentation>
  </annotation>
</enumeration>
<enumeration value="0202021">
  <annotation>
    <documentation>Zustand nach Prothesenentfernung</documentation>
  </annotation>
</enumeration>
<enumeration value="0202042">
  <annotation>
    <documentation>andere Gründe</documentation>
  </annotation>
</enumeration>
</restriction>
</simpleType>

```

simpleType enum 0204

namespace	http://xml.ir-d.de/emg		
type	restriction of string		
properties	base xs:string		
used by	element OperationEndprotheseBasis/OEP GrundWechselKnieSchluessel		
facets	Kind	Value	Annotation
	enumeration	0204001	documentation Lockerung
	enumeration	0204002	documentation Infektion, Verdacht auf
	enumeration	0204003	documentation Infektion, gesichert
	enumeration	0204006	documentation Periprothetische Fraktur
	enumeration	0204007	documentation Verschleiß
	enumeration	0204008	documentation Implantatbruch
	enumeration	0204009	documentation Implantatfehlage/Malalignent
	enumeration	0204010	documentation Osteolysen bei festem Implantat
	enumeration	0204011	documentation Progression der Grunderkrankung
	enumeration	0204012	documentation ARM-D
	enumeration	0204013	documentation Verdacht auf allergische Reaktion
	enumeration	0204014	documentation Dislokation/Migration von Komponenten
	enumeration	0204015	documentation Bandinstabilität
	enumeration	0204016	documentation Bewegungseinschränkung
	enumeration	0204021	documentation Zustand nach Prothesenentfernung
	enumeration	0204042	documentation andere Gründe
annotation	documentation Kat_EP_GrundWechselKnie		

source

```
<simpleType name="enum_0204">
  <annotation>
    <documentation>Kat_EP_GrundWechselKnie</documentation>
  </annotation>
  <restriction base="xs:string">
    <enumeration value="0204001">
      <annotation>
        <documentation>Lockerung</documentation>
      </annotation>
    </enumeration>
    <enumeration value="0204002">
      <annotation>
        <documentation>Infektion, Verdacht auf</documentation>
      </annotation>
    </enumeration>
    <enumeration value="0204003">
      <annotation>
        <documentation>Infektion, gesichert</documentation>
      </annotation>
    </enumeration>
    <enumeration value="0204006">
      <annotation>
        <documentation>Periprothetische Fraktur</documentation>
      </annotation>
    </enumeration>
    <enumeration value="0204007">
      <annotation>
        <documentation>Verschleiß</documentation>
      </annotation>
    </enumeration>
    <enumeration value="0204008">
      <annotation>
        <documentation>Implantatbruch</documentation>
      </annotation>
    </enumeration>
    <enumeration value="0204009">
      <annotation>
        <documentation>Implantatfehllage/Malalignent</documentation>
      </annotation>
    </enumeration>
    <enumeration value="0204010">
      <annotation>
        <documentation>Osteolysen bei festem Implantat</documentation>
      </annotation>
    </enumeration>
    <enumeration value="0204011">
      <annotation>
        <documentation>Progression der Grunderkrankung</documentation>
      </annotation>
    </enumeration>
    <enumeration value="0204012">
      <annotation>
        <documentation>ARMD</documentation>
      </annotation>
    </enumeration>
    <enumeration value="0204013">
      <annotation>
        <documentation>Verdacht auf allergische Reaktion</documentation>
      </annotation>
    </enumeration>
  </restriction>
</simpleType>
```

```

</enumeration>
<enumeration value="0204014">
  <annotation>
    <documentation>Dislokation/Migration von Komponenten</documentation>
  </annotation>
</enumeration>
<enumeration value="0204015">
  <annotation>
    <documentation>Bandinstabilität</documentation>
  </annotation>
</enumeration>
<enumeration value="0204016">
  <annotation>
    <documentation>Bewegungseinschränkung</documentation>
  </annotation>
</enumeration>
<enumeration value="0204021">
  <annotation>
    <documentation>Zustand nach Prothesenentfernung</documentation>
  </annotation>
</enumeration>
<enumeration value="0204042">
  <annotation>
    <documentation>andere Gründe</documentation>
  </annotation>
</enumeration>
</restriction>
</simpleType>

```

simpleType enum_0206

namespace	http://xml.ir-d.de/emg		
type	restriction of string		
properties	base xs:string		
used by	element OperationEndoprotheseBasis/OEP_GrundWechselTfeSchluessel		
facets	Kind	Value	Annotation
	enumeration	0206001	documentation Lockerung
	enumeration	0206002	documentation Infektion, Verdacht auf
	enumeration	0206003	documentation Infektion, gesichert
	enumeration	0206004	documentation Luxation, Inlay aus der Pfanne
	enumeration	0206005	documentation Luxation, Kopf aus Pfanne/Inlay
	enumeration	0206006	documentation Periprothetische Fraktur
	enumeration	0206007	documentation Verschleiß
	enumeration	0206008	documentation Implantatbruch
	enumeration	0206009	documentation Implantatfehlhllage/Malalignent
	enumeration	0206010	documentation Osteolysen bei festem Implantat
	enumeration	0206011	documentation Progression der Grunderkrankung

	<p>enumeration 0206012 documentation ARM D</p> <p>enumeration 0206013 documentation Verdacht auf allergische Reaktion</p> <p>enumeration 0206014 documentation Dislokation/Migration von Komponenten</p> <p>enumeration 0206015 documentation Bandinstabilität</p> <p>enumeration 0206016 documentation Bewegungseinschränkung</p> <p>enumeration 0206021 documentation Zustand nach Prothesenentfernung</p> <p>enumeration 0206042 documentation andere Gründe</p>
annotation	documentation Kat_EP_GrundWechselTFE
source	<pre> <simpleType name="enum_0206"> <annotation> <documentation>Kat_EP_GrundWechselTFE</documentation> </annotation> <restriction base="xs:string"> <enumeration value="0206001"> <annotation> <documentation>Lockerung</documentation> </annotation> </enumeration> <enumeration value="0206002"> <annotation> <documentation>Infektion, Verdacht auf</documentation> </annotation> </enumeration> <enumeration value="0206003"> <annotation> <documentation>Infektion, gesichert</documentation> </annotation> </enumeration> <enumeration value="0206004"> <annotation> <documentation>Luxation, Inlay aus der Pfanne</documentation> </annotation> </enumeration> <enumeration value="0206005"> <annotation> <documentation>Luxation, Kopf aus Pfanne/Inlay</documentation> </annotation> </enumeration> <enumeration value="0206006"> <annotation> <documentation>Periprothetische Fraktur</documentation> </annotation> </enumeration> <enumeration value="0206007"> <annotation> <documentation>Verschleiß</documentation> </annotation> </enumeration> <enumeration value="0206008"> <annotation> <documentation>Implantatbruch</documentation> </annotation> </enumeration> </restriction> </simpleType> </pre>

```

</enumeration>
<enumeration value="0206009">
  <annotation>
    <documentation>Implantatfehllage/Malalignent</documentation>
  </annotation>
</enumeration>
<enumeration value="0206010">
  <annotation>
    <documentation>Osteolysen bei festem Implantat</documentation>
  </annotation>
</enumeration>
<enumeration value="0206011">
  <annotation>
    <documentation>Progression der Grunderkrankung</documentation>
  </annotation>
</enumeration>
<enumeration value="0206012">
  <annotation>
    <documentation>ARMD</documentation>
  </annotation>
</enumeration>
<enumeration value="0206013">
  <annotation>
    <documentation>Verdacht auf allergische Reaktion</documentation>
  </annotation>
</enumeration>
<enumeration value="0206014">
  <annotation>
    <documentation>Dislokation/Migration von Komponenten</documentation>
  </annotation>
</enumeration>
<enumeration value="0206015">
  <annotation>
    <documentation>Bandinstabilität</documentation>
  </annotation>
</enumeration>
<enumeration value="0206016">
  <annotation>
    <documentation>Bewegungseinschränkung</documentation>
  </annotation>
</enumeration>
<enumeration value="0206021">
  <annotation>
    <documentation>Zustand nach Prothesenentfernung</documentation>
  </annotation>
</enumeration>
<enumeration value="0206042">
  <annotation>
    <documentation>andere Gründe</documentation>
  </annotation>
</enumeration>
</restriction>
</simpleType>

```

simpleType enum_0210

namespace <http://xml.ir-d.de/emg>

type	restriction of string		
properties	base xs:string		
used by	element VorbereitungEndoprotheseBasis/VEP_VorOpHuefteSchlüssel		
facets	Kind	Value	Annotation
	enumeration	0210001	documentation keine relevante Voroperation
	enumeration	0210002	documentation Osteosynthese/Osteotomie (Becken)
	enumeration	0210003	documentation Osteosynthese/Osteotomie (Femur)
	enumeration	0210004	documentation Osteosynthese/Osteotomie (beides)
	enumeration	0210005	documentation Operation bei Hüftkopfnekrose
	enumeration	0210006	documentation Arthrodese
	enumeration	0210042	documentation andere
annotation	documentation Kat_EP_VoroperationHuefte		
source	<pre> <simpleType name="enum_0210"> <annotation> <documentation>Kat_EP_VoroperationHuefte</documentation> </annotation> <restriction base="xs:string"> <enumeration value="0210001"> <annotation> <documentation>keine relevante Voroperation</documentation> </annotation> </enumeration> <enumeration value="0210002"> <annotation> <documentation>Osteosynthese/Osteotomie (Becken)</documentation> </annotation> </enumeration> <enumeration value="0210003"> <annotation> <documentation>Osteosynthese/Osteotomie (Femur)</documentation> </annotation> </enumeration> <enumeration value="0210004"> <annotation> <documentation>Osteosynthese/Osteotomie (beides)</documentation> </annotation> </enumeration> <enumeration value="0210005"> <annotation> <documentation>Operation bei Hüftkopfnekrose</documentation> </annotation> </enumeration> <enumeration value="0210006"> <annotation> <documentation>Arthrodese</documentation> </annotation> </enumeration> <enumeration value="0210042"> <annotation> <documentation>andere</documentation> </annotation> </enumeration> </restriction> </simpleType> </pre>		

```

</annotation>
</enumeration>
</restriction>
</simpleType>

```

simpleType enum_0211

namespace	http://xml.ir-d.de/emg		
type	restriction of string		
properties	base xs:string		
used by	element VorbereitungEndoprotheseBasis/VEP_VorOpKnieSchluessel		
facets	Kind	Value	Annotation
	enumeration	0211001	documentation keine relevante Voroperation
	enumeration	0211002	documentation Osteosynthese/Osteotomie (Femur)
	enumeration	0211003	documentation Osteosynthese/Osteotomie (Tibia)
	enumeration	0211004	documentation Osteosynthese/Osteotomie (Patella)
	enumeration	0211005	documentation Osteosynthese/Osteotomie (mehrere)
	enumeration	0211006	documentation Kapsel-/Bandapparat
	enumeration	0211007	documentation Arthrodese
	enumeration	0211042	documentation andere
annotation	documentation Kat_EP_VoroperationKnie		
source	<pre> <simpleType name="enum_0211"> <annotation> <documentation>Kat_EP_VoroperationKnie</documentation> </annotation> <restriction base="xs:string"> <enumeration value="0211001"> <annotation> <documentation>keine relevante Voroperation</documentation> </annotation> </enumeration> <enumeration value="0211002"> <annotation> <documentation>Osteosynthese/Osteotomie (Femur)</documentation> </annotation> </enumeration> <enumeration value="0211003"> <annotation> <documentation>Osteosynthese/Osteotomie (Tibia)</documentation> </annotation> </enumeration> <enumeration value="0211004"> <annotation> <documentation>Osteosynthese/Osteotomie (Patella)</documentation> </annotation> </enumeration> <enumeration value="0211005"> <annotation> </pre>		

	<pre> <documentation>Osteosynthese/Osteotomie (mehrere)</documentation> </annotation> </enumeration> <enumeration value="0211006"> <annotation> <documentation>Kapsel-/Bandapparat</documentation> </annotation> </enumeration> <enumeration value="0211007"> <annotation> <documentation>Arthrodesse</documentation> </annotation> </enumeration> <enumeration value="0211042"> <annotation> <documentation>andere</documentation> </annotation> </enumeration> </restriction> </simpleType> </pre>
--	--

simpleType enum_0212

namespace	http://xml.ir-d.de/emg		
type	restriction of string		
properties	base xs:string		
used by	element	OperationEndoprotheseBasis/OEP GelenkSchlüssel	
facets	Kind	Value	Annotation
	enumeration	0212001	documentation Hüfte
	enumeration	0212002	documentation Knie
	enumeration	0212003	documentation Totaler Femurersatz inkl. Durchsteck-Prothese
annotation	documentation Kat_EP_Gelenk		
source	<pre> <simpleType name="enum_0212"> <annotation> <documentation>Kat_EP_Gelenk</documentation> </annotation> <restriction base="xs:string"> <enumeration value="0212001"> <annotation> <documentation>Hüfte</documentation> </annotation> </enumeration> <enumeration value="0212002"> <annotation> <documentation>Knie</documentation> </annotation> </enumeration> <enumeration value="0212003"> <annotation> <documentation>Totaler Femurersatz inkl. Durchsteck-Prothese</documentation> </annotation> </enumeration> </restriction> </pre>		

```

</enumeration>
</restriction>
</simpleType>

```

simpleType enum_0220

namespace	http://xml.ir-d.de/emg		
type	restriction of string		
properties	base xs:string		
used by	element OperationEndoprotheseBasis/OEP_ZugangHuefteSchluessel		
facets	Kind	Value	Annotation
	enumeration	0220001	documentation anterior
	enumeration	0220002	documentation anterolateral
	enumeration	0220003	documentation lateral
	enumeration	0220004	documentation posterior
	enumeration	0220005	documentation posterolateral
	enumeration	0220006	documentation 2-Inzisionen-Zugang
	enumeration	0220042	documentation sonstiges/unbekannt
annotation	documentation Kat_EP_Operationszugang		
source	<pre> <simpleType name="enum_0220"> <annotation> <documentation>Kat_EP_Operationszugang</documentation> </annotation> <restriction base="xs:string"> <enumeration value="0220001"> <annotation> <documentation>anterior</documentation> </annotation> </enumeration> <enumeration value="0220002"> <annotation> <documentation>anterolateral</documentation> </annotation> </enumeration> <enumeration value="0220003"> <annotation> <documentation>lateral</documentation> </annotation> </enumeration> <enumeration value="0220004"> <annotation> <documentation>posterior</documentation> </annotation> </enumeration> <enumeration value="0220005"> <annotation> <documentation>posterolateral</documentation> </annotation> </enumeration> </restriction> </simpleType> </pre>		

	<pre> <enumeration value="0220006"> <annotation> <documentation>2-Inzisionen-Zugang</documentation> </annotation> </enumeration> <enumeration value="0220042"> <annotation> <documentation>sonstiges/unbekannt</documentation> </annotation> </enumeration> </restriction> </simpleType> </pre>
--	---

simpleType enum_0222

namespace	http://xml.ir-d.de/emg		
type	restriction of string		
properties	base xs:string		
used by	element OperationEndprotheseBasis/OEP ZweizeitwechselSchlüssel		
facets	Kind	Value	Annotation
	enumeration	0222001	documentation nein
	enumeration	0222002	documentation ja- Ausbau
	enumeration	0222003	documentation ja- Einbau
annotation	documentation Kat_EP_Zweizeitwechsel		
source	<pre> <simpleType name="enum_0222"> <annotation> <documentation>Kat_EP_Zweizeitwechsel</documentation> </annotation> <restriction base="xs:string"> <enumeration value="0222001"> <annotation> <documentation>nein</documentation> </annotation> </enumeration> <enumeration value="0222002"> <annotation> <documentation>ja- Ausbau</documentation> </annotation> </enumeration> <enumeration value="0222003"> <annotation> <documentation>ja- Einbau</documentation> </annotation> </enumeration> </restriction> </simpleType> </pre>		

simpleType enum_0230

namespace	http://xml.ir-d.de/emg
-----------	------------------------

type	restriction of string		
properties	base xs:string		
used by	elements ArtikelEndoprotheseBasis/AEP_HerstellerSchluessel ZubehoerEndoprotheseBasis/ZEP_HerstellerSchluessel		
facets	Kind	Value	Annotation
	enumeration	0230001	documentation Smith & Nephew GmbH
	enumeration	0230002	documentation Mathys Orthopädie GmbH
	enumeration	0230003	documentation Ceramtec AG
	enumeration	0230004	documentation Biomet
	enumeration	0230005	documentation Peter Brehm GmbH
	enumeration	0230006	documentation Amplitude GmbH
	enumeration	0230007	documentation Exactech Deutschland
	enumeration	0230008	documentation Globus Medical
	enumeration	0230009	documentation Implantcast GmbH
	enumeration	0230010	documentation DePuy Orthopädie GmbH
	enumeration	0230011	documentation IO-International Orthopaedics
	enumeration	0230012	documentation Joint Replacement Ltd. Instrumentation
	enumeration	0230013	documentation Merete
	enumeration	0230014	documentation S&G Implants GmbH
	enumeration	0230015	documentation Speetec Implantate GmbH
	enumeration	0230016	documentation Stemcup Medical Products GmbH
	enumeration	0230017	documentation Symbios Deutschland GmbH
	enumeration	0230018	documentation Tantum AG
	enumeration	0230019	documentation Tornier GmbH
	enumeration	0230020	documentation MicroPort Orthopedics GmbH
	enumeration	0230021	documentation aap Implanate AG
	enumeration	0230022	documentation AQImplants
	enumeration	0230023	documentation ESKA Orthodynamics GmbH
	enumeration	0230024	documentation Ateos medical AG
	enumeration	0230025	documentation Chiropro GmbH
	enumeration	0230026	documentation Medacta
	enumeration	0230027	documentation OHST Medizintechnik AG
	enumeration	0230028	documentation Lima Deutschland GmbH
	enumeration	0230029	documentation alloPlus GmbH

	<p>enumeration 0230030 documentation Heraeus Medical GmbH</p> <p>enumeration 0230031 documentation ImplanTec Deutschland GmbH</p> <p>enumeration 0230032 documentation Falcon Medical GmbH</p> <p>enumeration 0230033 documentation Meril GmbH</p> <p>enumeration 0230034 documentation Zimmer Germany GmbH</p> <p>enumeration 0230035 documentation Stryker GmbH & Co. KG</p> <p>enumeration 0230036 documentation Aesculap AG</p> <p>enumeration 0230037 documentation Waldemar Link GmbH & Co. KG</p> <p>enumeration 0230038 documentation Corin Germany GmbH</p> <p>enumeration 0230039 documentation nicht belegter Wert</p> <p>enumeration 0230040 documentation nicht belegter Wert</p> <p>enumeration 0230041 documentation nicht belegter Wert</p> <p>enumeration 0230042 documentation sonstige</p> <p>enumeration 0230043 documentation nicht belegter Wert</p> <p>enumeration 0230044 documentation nicht belegter Wert</p>
annotation	documentation Kat_EP_Hersteller
source	<pre> <simpleType name="enum_0230"> <annotation> <documentation>Kat_EP_Hersteller</documentation> </annotation> <restriction base="xs:string"> <enumeration value="0230001"> <annotation> <documentation>Smith & Nephew GmbH</documentation> </annotation> </enumeration> <enumeration value="0230002"> <annotation> <documentation>Mathys Orthopädie GmbH</documentation> </annotation> </enumeration> <enumeration value="0230003"> <annotation> <documentation>Ceramtec AG</documentation> </annotation> </enumeration> <enumeration value="0230004"> <annotation> <documentation>Biomet</documentation> </annotation> </enumeration> <enumeration value="0230005"> <annotation> <documentation>Peter Brehm GmbH</documentation> </annotation> </enumeration> </restriction> </simpleType> </pre>

```
<enumeration value="0230006">
  <annotation>
    <documentation>Amplitude GmbH</documentation>
  </annotation>
</enumeration>
<enumeration value="0230007">
  <annotation>
    <documentation>Exactech Deutschland</documentation>
  </annotation>
</enumeration>
<enumeration value="0230008">
  <annotation>
    <documentation>Globus Medical</documentation>
  </annotation>
</enumeration>
<enumeration value="0230009">
  <annotation>
    <documentation>Implantcast GmbH</documentation>
  </annotation>
</enumeration>
<enumeration value="0230010">
  <annotation>
    <documentation>DePuy Orthopädie GmbH</documentation>
  </annotation>
</enumeration>
<enumeration value="0230011">
  <annotation>
    <documentation>IO-International Orthopaedics</documentation>
  </annotation>
</enumeration>
<enumeration value="0230012">
  <annotation>
    <documentation>Joint Replacement Ltd. Instrumentation</documentation>
  </annotation>
</enumeration>
<enumeration value="0230013">
  <annotation>
    <documentation>Merete</documentation>
  </annotation>
</enumeration>
<enumeration value="0230014">
  <annotation>
    <documentation>S&G Implants GmbH</documentation>
  </annotation>
</enumeration>
<enumeration value="0230015">
  <annotation>
    <documentation>Speetec Implantate GmbH</documentation>
  </annotation>
</enumeration>
<enumeration value="0230016">
  <annotation>
    <documentation>Stemcup Medical Products GmbH</documentation>
  </annotation>
</enumeration>
<enumeration value="0230017">
  <annotation>
    <documentation>Symbios Deutschland GmbH</documentation>
  </annotation>
</enumeration>
```

```
</enumeration>
<enumeration value="0230018">
  <annotation>
    <documentation>Tantum AG</documentation>
  </annotation>
</enumeration>
<enumeration value="0230019">
  <annotation>
    <documentation>Tornier GmbH</documentation>
  </annotation>
</enumeration>
<enumeration value="0230020">
  <annotation>
    <documentation>MicroPort Orthopedics GmbH</documentation>
  </annotation>
</enumeration>
<enumeration value="0230021">
  <annotation>
    <documentation>aap Implanate AG</documentation>
  </annotation>
</enumeration>
<enumeration value="0230022">
  <annotation>
    <documentation>AQImplants</documentation>
  </annotation>
</enumeration>
<enumeration value="0230023">
  <annotation>
    <documentation>ESKA Orthodynamics GmbH</documentation>
  </annotation>
</enumeration>
<enumeration value="0230024">
  <annotation>
    <documentation>Ateos medical AG</documentation>
  </annotation>
</enumeration>
<enumeration value="0230025">
  <annotation>
    <documentation>Chiropro GmbH</documentation>
  </annotation>
</enumeration>
<enumeration value="0230026">
  <annotation>
    <documentation>Medacta</documentation>
  </annotation>
</enumeration>
<enumeration value="0230027">
  <annotation>
    <documentation>OHST Medizintechnik AG</documentation>
  </annotation>
</enumeration>
<enumeration value="0230028">
  <annotation>
    <documentation>Lima Deutschland GmbH</documentation>
  </annotation>
</enumeration>
<enumeration value="0230029">
  <annotation>
    <documentation>alloPlus GmbH</documentation>
  </annotation>
</enumeration>
```

```
</annotation>
</enumeration>
<enumeration value="0230030">
  <annotation>
    <documentation>Heraeus Medical GmbH</documentation>
  </annotation>
</enumeration>
<enumeration value="0230031">
  <annotation>
    <documentation>ImplanTec Deutschland GmbH</documentation>
  </annotation>
</enumeration>
<enumeration value="0230032">
  <annotation>
    <documentation>Falcon Medical GmbH</documentation>
  </annotation>
</enumeration>
<enumeration value="0230033">
  <annotation>
    <documentation>Meril GmbH</documentation>
  </annotation>
</enumeration>
<enumeration value="0230034">
  <annotation>
    <documentation>Zimmer Germany GmbH</documentation>
  </annotation>
</enumeration>
<enumeration value="0230035">
  <annotation>
    <documentation>Stryker GmbH & Co. KG</documentation>
  </annotation>
</enumeration>
<enumeration value="0230036">
  <annotation>
    <documentation>Aesculap AG</documentation>
  </annotation>
</enumeration>
<enumeration value="0230037">
  <annotation>
    <documentation>Waldemar Link GmbH & Co. KG</documentation>
  </annotation>
</enumeration>
<enumeration value="0230038">
  <annotation>
    <documentation>Corin Germany GmbH</documentation>
  </annotation>
</enumeration>
<enumeration value="0230039">
  <annotation>
    <documentation>nicht belegter Wert</documentation>
  </annotation>
</enumeration>
<enumeration value="0230040">
  <annotation>
    <documentation>nicht belegter Wert</documentation>
  </annotation>
</enumeration>
<enumeration value="0230041">
  <annotation>
```

	<pre> <documentation>nicht belegter Wert</documentation> </annotation> </enumeration> <enumeration value="0230042"> <annotation> <documentation>sonstige</documentation> </annotation> </enumeration> <enumeration value="0230043"> <annotation> <documentation>nicht belegter Wert</documentation> </annotation> </enumeration> <enumeration value="0230044"> <annotation> <documentation>nicht belegter Wert</documentation> </annotation> </enumeration> </restriction> </simpleType> </pre>
--	---

simpleType enum_0252

namespace	http://xml.ir-d.de/emg		
type	restriction of string		
properties	base xs:string		
used by	element OperationEndprotheseBasis/OEP KomponenteHuefteSchluessel		
facets	Kind	Value	Annotation
	enumeration	0252001	documentation Pfanne
	enumeration	0252002	documentation Schaft
	enumeration	0252003	documentation beides
annotation	documentation Kat_EP_KomponenteHuefte		
source	<pre> <simpleType name="enum_0252"> <annotation> <documentation>Kat_EP_KomponenteHuefte</documentation> </annotation> <restriction base="xs:string"> <enumeration value="0252001"> <annotation> <documentation>Pfanne</documentation> </annotation> </enumeration> <enumeration value="0252002"> <annotation> <documentation>Schaft</documentation> </annotation> </enumeration> <enumeration value="0252003"> <annotation> <documentation>beides</documentation> </annotation> </enumeration> </restriction> </pre>		

	<pre> </restriction> </simpleType> </pre>
--	---

simpleType enum_0254

namespace	http://xml.ir-d.de/emg		
type	restriction of string		
properties	base xs:string		
used by	element	OperationEndoprotheseBasis/OEP_KomponenteKnieSchluessel	
facets	Kind	Value	Annotation
	enumeration	0254001	documentation Femur
	enumeration	0254002	documentation Tibia
	enumeration	0254003	documentation Patella
	enumeration	0254004	documentation mehrere
annotation	documentation Kat_EP_KomponenteKnie		
source	<pre> <simpleType name="enum_0254"> <annotation> <documentation>Kat_EP_KomponenteKnie</documentation> </annotation> <restriction base="xs:string"> <enumeration value="0254001"> <annotation> <documentation>Femur</documentation> </annotation> </enumeration> <enumeration value="0254002"> <annotation> <documentation>Tibia</documentation> </annotation> </enumeration> <enumeration value="0254003"> <annotation> <documentation>Patella</documentation> </annotation> </enumeration> <enumeration value="0254004"> <annotation> <documentation>mehrere</documentation> </annotation> </enumeration> </restriction> </simpleType> </pre>		

simpleType enum_0256

namespace	http://xml.ir-d.de/emg		
type	restriction of string		
properties	base xs:string		

used by	element OperationEndprotheseBasis/OEP KomponenteTfeSchluessel																								
facets	<table border="1"> <thead> <tr> <th>Kind</th> <th>Value</th> <th>Annotation</th> </tr> </thead> <tbody> <tr> <td>enumeration</td> <td>0256001</td> <td>documentation Pfanne</td> </tr> <tr> <td>enumeration</td> <td>0256002</td> <td>documentation Schaft</td> </tr> <tr> <td>enumeration</td> <td>0256003</td> <td>documentation Pfanne und Schaft</td> </tr> <tr> <td>enumeration</td> <td>0256004</td> <td>documentation Femur</td> </tr> <tr> <td>enumeration</td> <td>0256005</td> <td>documentation Tibia</td> </tr> <tr> <td>enumeration</td> <td>0256006</td> <td>documentation Patella</td> </tr> <tr> <td>enumeration</td> <td>0256007</td> <td>documentation mehrere</td> </tr> </tbody> </table>	Kind	Value	Annotation	enumeration	0256001	documentation Pfanne	enumeration	0256002	documentation Schaft	enumeration	0256003	documentation Pfanne und Schaft	enumeration	0256004	documentation Femur	enumeration	0256005	documentation Tibia	enumeration	0256006	documentation Patella	enumeration	0256007	documentation mehrere
Kind	Value	Annotation																							
enumeration	0256001	documentation Pfanne																							
enumeration	0256002	documentation Schaft																							
enumeration	0256003	documentation Pfanne und Schaft																							
enumeration	0256004	documentation Femur																							
enumeration	0256005	documentation Tibia																							
enumeration	0256006	documentation Patella																							
enumeration	0256007	documentation mehrere																							
annotation	documentation Kat_EP_KomponenteTFE																								
source	<pre> <simpleType name="enum_0256"> <annotation> <documentation>Kat_EP_KomponenteTFE</documentation> </annotation> <restriction base="xs:string"> <enumeration value="0256001"> <annotation> <documentation>Pfanne</documentation> </annotation> </enumeration> <enumeration value="0256002"> <annotation> <documentation>Schaft</documentation> </annotation> </enumeration> <enumeration value="0256003"> <annotation> <documentation>Pfanne und Schaft</documentation> </annotation> </enumeration> <enumeration value="0256004"> <annotation> <documentation>Femur</documentation> </annotation> </enumeration> <enumeration value="0256005"> <annotation> <documentation>Tibia</documentation> </annotation> </enumeration> <enumeration value="0256006"> <annotation> <documentation>Patella</documentation> </annotation> </enumeration> <enumeration value="0256007"> <annotation> <documentation>mehrere</documentation> </annotation> </enumeration> </restriction> </pre>																								

	<code></simpleType></code>
--	----------------------------------

simpleType enum_0262

namespace	http://xml.ir-d.de/emg		
type	restriction of string		
properties	base xs:string		
used by	element	OperationEndoprotheseBasis/OEP ImplantatbruchHuefteSchluessel	
facets	Kind	Value	Annotation
	enumeration	0262001	documentation Pfanne
	enumeration	0262002	documentation Schaft
	enumeration	0262003	documentation Kopf
	enumeration	0262004	documentation Inlay
	enumeration	0262005	documentation Adapter
	enumeration	0262006	documentation mehrere
annotation	documentation Kat_EP_ImplantatbruchHuefte		
source	<pre><simpleType name="enum_0262"> <annotation> <documentation>Kat_EP_ImplantatbruchHuefte</documentation> </annotation> <restriction base="xs:string"> <enumeration value="0262001"> <annotation> <documentation>Pfanne</documentation> </annotation> </enumeration> <enumeration value="0262002"> <annotation> <documentation>Schaft</documentation> </annotation> </enumeration> <enumeration value="0262003"> <annotation> <documentation>Kopf</documentation> </annotation> </enumeration> <enumeration value="0262004"> <annotation> <documentation>Inlay</documentation> </annotation> </enumeration> <enumeration value="0262005"> <annotation> <documentation>Adapter</documentation> </annotation> </enumeration> <enumeration value="0262006"> <annotation> <documentation>mehrere</documentation> </annotation> </enumeration> </restriction> </simpleType></pre>		

	<pre> </enumeration> </restriction> </simpleType> </pre>
--	--

simpleType enum_0264

namespace	http://xml.ir-d.de/emg		
type	restriction of string		
properties	base xs:string		
used by	element OperationEndoprotheseBasis/OEP ImplantatbruchKnieSchluessel		
facets	Kind	Value	Annotation
	enumeration	0264001	documentation Femur
	enumeration	0264002	documentation Tibia
	enumeration	0264003	documentation Inlay
	enumeration	0264004	documentation Adapter
	enumeration	0264005	documentation Verlängerung
	enumeration	0264006	documentation Schrauben
	enumeration	0264007	documentation mehrere
	enumeration	0264042	documentation andere
annotation	documentation Kat_EP_ImplantatbruchKnie		
source	<pre> <simpleType name="enum_0264"> <annotation> <documentation>Kat_EP_ImplantatbruchKnie</documentation> </annotation> <restriction base="xs:string"> <enumeration value="0264001"> <annotation> <documentation>Femur</documentation> </annotation> </enumeration> <enumeration value="0264002"> <annotation> <documentation>Tibia</documentation> </annotation> </enumeration> <enumeration value="0264003"> <annotation> <documentation>Inlay</documentation> </annotation> </enumeration> <enumeration value="0264004"> <annotation> <documentation>Adapter</documentation> </annotation> </enumeration> <enumeration value="0264005"> <annotation> <documentation>Verlängerung</documentation> </pre>		

```

    </annotation>
  </enumeration>
  <enumeration value="0264006">
    <annotation>
      <documentation>Schrauben</documentation>
    </annotation>
  </enumeration>
  <enumeration value="0264007">
    <annotation>
      <documentation>mehrere</documentation>
    </annotation>
  </enumeration>
  <enumeration value="0264042">
    <annotation>
      <documentation>andere</documentation>
    </annotation>
  </enumeration>
</restriction>
</simpleType>

```

simpleType **enum_0266**

namespace	http://xml.ir-d.de/emg		
type	restriction of string		
properties	base xs:string		
used by	element OperationEndoprotheseBasis/OEP ImplantatbruchTfeSchluessel		
facets	Kind	Value	Annotation
	enumeration	0266001	documentation Pfanne
	enumeration	0266002	documentation Schaft
	enumeration	0266003	documentation Kopf
	enumeration	0266004	documentation Inlay
	enumeration	0266005	documentation Adapter
	enumeration	0266006	documentation Femur
	enumeration	0266007	documentation Tibia
	enumeration	0266008	documentation Verlängerung
	enumeration	0266009	documentation Schrauben
	enumeration	0266010	documentation mehrere
	enumeration	0266042	documentation andere
annotation	documentation Kat_EP_ImplantatbruchTFE		
source	<pre> <simpleType name="enum_0266"> <annotation> <documentation>Kat_EP_ImplantatbruchTFE</documentation> </annotation> <restriction base="xs:string"> <enumeration value="0266001"> <annotation> </pre>		

```
<documentation>Pfanne</documentation>
</annotation>
</enumeration>
<enumeration value="0266002">
  <annotation>
    <documentation>Schaft</documentation>
  </annotation>
</enumeration>
<enumeration value="0266003">
  <annotation>
    <documentation>Kopf</documentation>
  </annotation>
</enumeration>
<enumeration value="0266004">
  <annotation>
    <documentation>Inlay</documentation>
  </annotation>
</enumeration>
<enumeration value="0266005">
  <annotation>
    <documentation>Adapter</documentation>
  </annotation>
</enumeration>
<enumeration value="0266006">
  <annotation>
    <documentation>Femur</documentation>
  </annotation>
</enumeration>
<enumeration value="0266007">
  <annotation>
    <documentation>Tibia</documentation>
  </annotation>
</enumeration>
<enumeration value="0266008">
  <annotation>
    <documentation>Verlängerung</documentation>
  </annotation>
</enumeration>
<enumeration value="0266009">
  <annotation>
    <documentation>Schrauben</documentation>
  </annotation>
</enumeration>
<enumeration value="0266010">
  <annotation>
    <documentation>mehrere</documentation>
  </annotation>
</enumeration>
<enumeration value="0266042">
  <annotation>
    <documentation>andere</documentation>
  </annotation>
</enumeration>
</restriction>
</simpleType>
```

simpleType enum_0270

namespace	http://xml.ir-d.de/emg		
type	restriction of string		
properties	base xs:string		
used by	element OperationEndoprotheseBasis/OEP_VerschleissKnieSchluessel		
facets	Kind	Value	Annotation
	enumeration	0270001	documentation PE-Inlay
	enumeration	0270002	documentation patellare Komponente
	enumeration	0270003	documentation beides
annotation	documentation Kat_EP_VerschleissKnie		
source	<pre> <simpleType name="enum_0270"> <annotation> <documentation>Kat_EP_VerschleissKnie</documentation> </annotation> <restriction base="xs:string"> <enumeration value="0270001"> <annotation> <documentation>PE-Inlay</documentation> </annotation> </enumeration> <enumeration value="0270002"> <annotation> <documentation>patellare Komponente</documentation> </annotation> </enumeration> <enumeration value="0270003"> <annotation> <documentation>beides</documentation> </annotation> </enumeration> </restriction> </simpleType> </pre>		

simpleType enum_0271

namespace	http://xml.ir-d.de/emg		
type	restriction of string		
properties	base xs:string		
used by	element OperationEndoprotheseBasis/OEP_MigrationKnieSchluessel		
facets	Kind	Value	Annotation
	enumeration	0271001	documentation Schraube
	enumeration	0271002	documentation Inlay
	enumeration	0271003	documentation patellare Komponente
	enumeration	0271004	documentation Kopplung
	enumeration	0271005	documentation mehrere
	enumeration	0271042	documentation

	andere
annotation	documentation Kat_EP_MigrationKnie
source	<pre> <simpleType name="enum_0271"> <annotation> <documentation>Kat_EP_MigrationKnie</documentation> </annotation> <restriction base="xs:string"> <enumeration value="0271001"> <annotation> <documentation>Schraube</documentation> </annotation> </enumeration> <enumeration value="0271002"> <annotation> <documentation>Inlay</documentation> </annotation> </enumeration> <enumeration value="0271003"> <annotation> <documentation>patellare Komponente</documentation> </annotation> </enumeration> <enumeration value="0271004"> <annotation> <documentation>Kopplung</documentation> </annotation> </enumeration> <enumeration value="0271005"> <annotation> <documentation>mehrere</documentation> </annotation> </enumeration> <enumeration value="0271042"> <annotation> <documentation>andere</documentation> </annotation> </enumeration> </restriction> </simpleType> </pre>

simpleType enum_0290

namespace	http://xml.ir-d.de/emg		
type	restriction of string		
properties	base xs:string		
used by	element ArtikelEndoprotheseBasis/AEP ArtikelTypSchluessel		
facets	Kind	Value	Annotation
	enumeration	0290001	documentation Hüft-Komponente
	enumeration	0290002	documentation Knie-Komponente
	enumeration	0290003	documentation Modulare Komponente (Hüfte/Knie)
annotation	documentation Kat_EP_Artikeltyp		

source	<pre> <simpleType name="enum_0290"> <annotation> <documentation>Kat_EP_Artikeltyp</documentation> </annotation> <restriction base="xs:string"> <enumeration value="0290001"> <annotation> <documentation>Hüft-Komponente</documentation> </annotation> </enumeration> <enumeration value="0290002"> <annotation> <documentation>Knie-Komponente</documentation> </annotation> </enumeration> <enumeration value="0290003"> <annotation> <documentation>Modulare Komponente (Hüfte/Knie)</documentation> </annotation> </enumeration> </restriction> </simpleType> </pre>
--------	--

simpleType enum_0291

namespace	http://xml.ir-d.de/emg		
type	restriction of string		
properties	base xs:string		
used by	element ZubehoerEndoprotheseBasis/ZEP_ZubehoerTypSchluessel		
facets	Kind	Value	Annotation
	enumeration	0291001	documentation Knochen-Zement
	enumeration	0291002	documentation sonstiges Zubehör
annotation	documentation Kat_EP_ZubehoerTyp		
source	<pre> <simpleType name="enum_0291"> <annotation> <documentation>Kat_EP_ZubehoerTyp</documentation> </annotation> <restriction base="xs:string"> <enumeration value="0291001"> <annotation> <documentation>Knochen-Zement</documentation> </annotation> </enumeration> <enumeration value="0291002"> <annotation> <documentation>sonstiges Zubehör</documentation> </annotation> </enumeration> </restriction> </simpleType> </pre>		

simpleType enum_0300

namespace	http://xml.ir-d.de/emg		
type	restriction of string		
properties	base xs:string		
used by	element OperationAortenklappeBasis/OAK ArtEingriffSchluessel		
facets	Kind	Value	Annotation
	enumeration	0300001	documentation konventioneller Aortenklappenersatz
	enumeration	0300002	documentation kathetergestützte Aortenklappenimplantation (TAVI)
annotation	documentation Kat_AK_ArtEingriff		
source	<pre> <simpleType name="enum_0300"> <annotation> <documentation>Kat_AK_ArtEingriff</documentation> </annotation> <restriction base="xs:string"> <enumeration value="0300001"> <annotation> <documentation>konventioneller Aortenklappenersatz</documentation> </annotation> </enumeration> <enumeration value="0300002"> <annotation> <documentation>kathetergestützte Aortenklappenimplantation (TAVI)</documentation> </annotation> </enumeration> </restriction> </simpleType> </pre>		

simpleType enum_0302

namespace	http://xml.ir-d.de/emg		
type	restriction of string		
properties	base xs:string		
used by	element OperationAortenklappeBasis/OAK GrundEingriffSchluessel		
facets	Kind	Value	Annotation
	enumeration	0302001	documentation Stenose
	enumeration	0302002	documentation Insuffizienz
	enumeration	0302003	documentation Stenose und Insuffizienz
annotation	documentation Kat_AK_GrundEingriff		
source	<pre> <simpleType name="enum_0302"> <annotation> <documentation>Kat_AK_GrundEingriff</documentation> </annotation> <restriction base="xs:string"> <enumeration value="0302001"> <annotation> <documentation>Stenose</documentation> </annotation> </enumeration> </restriction> </simpleType> </pre>		

	<pre> </annotation> </enumeration> <enumeration value="0302002"> <annotation> <documentation>Insuffizienz</documentation> </annotation> </enumeration> <enumeration value="0302003"> <annotation> <documentation>Stenose und Insuffizienz</documentation> </annotation> </enumeration> </restriction> </simpleType> </pre>
--	--

simpleType enum_0318

namespace	http://xml.ir-d.de/emg		
type	restriction of string		
properties	base xs:string		
used by	element OperationAortenklappeBasis/OAK ZugangKatheterSchluessel		
facets	Kind	Value	Annotation
	enumeration	0318001	documentation transapikal
	enumeration	0318002	documentation transaortal
	enumeration	0318003	documentation transfemorale
	enumeration	0318004	documentation transaxillär
	enumeration	0318042	documentation anderer Zugangsweg
annotation	documentation Kat_AK_ZugangKatheter		
source	<pre> <simpleType name="enum_0318"> <annotation> <documentation>Kat_AK_ZugangKatheter</documentation> </annotation> <restriction base="xs:string"> <enumeration value="0318001"> <annotation> <documentation>transapikal</documentation> </annotation> </enumeration> <enumeration value="0318002"> <annotation> <documentation>transaortal</documentation> </annotation> </enumeration> <enumeration value="0318003"> <annotation> <documentation>transfemorale</documentation> </annotation> </enumeration> <enumeration value="0318004"> <annotation> </pre>		

	<pre> <documentation>transaxillär</documentation> </annotation> </enumeration> <enumeration value="0318042"> <annotation> <documentation>anderer Zugangsweg</documentation> </annotation> </enumeration> </restriction> </simpleType> </pre>
--	--

simpleType enum_0320

namespace	http://xml.ir-d.de/emg		
type	restriction of string		
properties	base xs:string		
used by	element OperationAortenklappeBasis/OAK ZugangKonventionellSchluessel		
facets	Kind	Value	Annotation
	enumeration	0320001	documentation konventionelle Sternotomie
	enumeration	0320002	documentation partielle Sternotomie
	enumeration	0320003	documentation parasternaler Zugang
	enumeration	0320042	documentation anderer Zugangsweg
annotation	documentation Kat AK ZugangKonventionell		
source	<pre> <simpleType name="enum_0320"> <annotation> <documentation>Kat_AK_ZugangKonventionell</documentation> </annotation> <restriction base="xs:string"> <enumeration value="0320001"> <annotation> <documentation>konventionelle Sternotomie</documentation> </annotation> </enumeration> <enumeration value="0320002"> <annotation> <documentation>partielle Sternotomie</documentation> </annotation> </enumeration> <enumeration value="0320003"> <annotation> <documentation>parasternaler Zugang</documentation> </annotation> </enumeration> <enumeration value="0320042"> <annotation> <documentation>anderer Zugangsweg</documentation> </annotation> </enumeration> </restriction> </simpleType> </pre>		

simpleType enum_0322

namespace	http://xml.ir-d.de/emg		
type	restriction of string		
properties	base xs:string		
used by	element PatientenaufnahmeKardiologieBasis/PKA_DiabetesSchluessel		
facets	Kind	Value	Annotation
	enumeration	0322001	documentation nein
	enumeration	0322002	documentation ja, diätetisch behandelt
	enumeration	0322003	documentation ja, orale Medikation
	enumeration	0322004	documentation ja, mit Insulin behandelt
	enumeration	0322005	documentation ja, unbehandelt
	enumeration	0322099	documentation unbekannt
annotation	documentation Kat AK Diabetes		
source	<pre> <simpleType name="enum_0322"> <annotation> <documentation>Kat_AK_Diabetes</documentation> </annotation> <restriction base="xs:string"> <enumeration value="0322001"> <annotation> <documentation>nein</documentation> </annotation> </enumeration> <enumeration value="0322002"> <annotation> <documentation>ja, diätetisch behandelt</documentation> </annotation> </enumeration> <enumeration value="0322003"> <annotation> <documentation>ja, orale Medikation</documentation> </annotation> </enumeration> <enumeration value="0322004"> <annotation> <documentation>ja, mit Insulin behandelt</documentation> </annotation> </enumeration> <enumeration value="0322005"> <annotation> <documentation>ja, unbehandelt</documentation> </annotation> </enumeration> <enumeration value="0322099"> <annotation> <documentation>unbekannt</documentation> </annotation> </enumeration> </restriction> </pre>		

	<code></simpleType></code>
--	----------------------------------

simpleType enum_0324

namespace	http://xml.ir-d.de/emg		
type	restriction of string		
properties	base xs:string		
used by	element	PatientenaufnahmeKardiologieBasis/PKA_NyhaSchluessel	
facets	Kind	Value	Annotation
	enumeration	0324001	documentation (I): Beschwerdefreiheit, normale körperliche Belastbarkeit
	enumeration	0324002	documentation (II): Beschwerden bei stärkerer körperlicher Belastung
	enumeration	0324003	documentation (III): Beschwerden bei leichter körperlicher Belastung
	enumeration	0324004	documentation (IV): Beschwerden in Ruhe
annotation	documentation Kat AK NYHA		
source	<pre> <simpleType name="enum_0324"> <annotation> <documentation>Kat_AK_NYHA</documentation> </annotation> <restriction base="xs:string"> <enumeration value="0324001"> <annotation> <documentation>(I): Beschwerdefreiheit, normale körperliche Belastbarkeit</documentation> </annotation> </enumeration> <enumeration value="0324002"> <annotation> <documentation>(II): Beschwerden bei stärkerer körperlicher Belastung</documentation> </annotation> </enumeration> <enumeration value="0324003"> <annotation> <documentation>(III): Beschwerden bei leichter körperlicher Belastung</documentation> </annotation> </enumeration> <enumeration value="0324004"> <annotation> <documentation>(IV): Beschwerden in Ruhe</documentation> </annotation> </enumeration> </restriction> </simpleType> </pre>		

simpleType enum_0330

namespace	http://xml.ir-d.de/emg
type	restriction of string

properties	base xs:string																																																
used by	element ArtikelAortenklappeBasis/AAK_HerstellerSchluessel																																																
facets	<table border="1"> <thead> <tr> <th>Kind</th> <th>Value</th> <th>Annotation</th> </tr> </thead> <tbody> <tr> <td>enumeration</td> <td>0330001</td> <td>documentation ATS Medical</td> </tr> <tr> <td>enumeration</td> <td>0330002</td> <td>documentation Edwards Lifesciences</td> </tr> <tr> <td>enumeration</td> <td>0330003</td> <td>documentation Medtronic</td> </tr> <tr> <td>enumeration</td> <td>0330004</td> <td>documentation JenaValve</td> </tr> <tr> <td>enumeration</td> <td>0330005</td> <td>documentation Corcym</td> </tr> <tr> <td>enumeration</td> <td>0330006</td> <td>documentation StJude Medical/Abbott</td> </tr> <tr> <td>enumeration</td> <td>0330007</td> <td>documentation Symetis</td> </tr> <tr> <td>enumeration</td> <td>0330008</td> <td>documentation Direct Flow Medical</td> </tr> <tr> <td>enumeration</td> <td>0330009</td> <td>documentation Boston Scientific</td> </tr> <tr> <td>enumeration</td> <td>0330010</td> <td>documentation nicht belegter Wert</td> </tr> <tr> <td>enumeration</td> <td>0330011</td> <td>documentation nicht belegter Wert</td> </tr> <tr> <td>enumeration</td> <td>0330012</td> <td>documentation nicht belegter Wert</td> </tr> <tr> <td>enumeration</td> <td>0330013</td> <td>documentation nicht belegter Wert</td> </tr> <tr> <td>enumeration</td> <td>0330014</td> <td>documentation nicht belegter Wert</td> </tr> <tr> <td>enumeration</td> <td>0330042</td> <td>documentation sonstiger Hersteller</td> </tr> </tbody> </table>	Kind	Value	Annotation	enumeration	0330001	documentation ATS Medical	enumeration	0330002	documentation Edwards Lifesciences	enumeration	0330003	documentation Medtronic	enumeration	0330004	documentation JenaValve	enumeration	0330005	documentation Corcym	enumeration	0330006	documentation StJude Medical/Abbott	enumeration	0330007	documentation Symetis	enumeration	0330008	documentation Direct Flow Medical	enumeration	0330009	documentation Boston Scientific	enumeration	0330010	documentation nicht belegter Wert	enumeration	0330011	documentation nicht belegter Wert	enumeration	0330012	documentation nicht belegter Wert	enumeration	0330013	documentation nicht belegter Wert	enumeration	0330014	documentation nicht belegter Wert	enumeration	0330042	documentation sonstiger Hersteller
Kind	Value	Annotation																																															
enumeration	0330001	documentation ATS Medical																																															
enumeration	0330002	documentation Edwards Lifesciences																																															
enumeration	0330003	documentation Medtronic																																															
enumeration	0330004	documentation JenaValve																																															
enumeration	0330005	documentation Corcym																																															
enumeration	0330006	documentation StJude Medical/Abbott																																															
enumeration	0330007	documentation Symetis																																															
enumeration	0330008	documentation Direct Flow Medical																																															
enumeration	0330009	documentation Boston Scientific																																															
enumeration	0330010	documentation nicht belegter Wert																																															
enumeration	0330011	documentation nicht belegter Wert																																															
enumeration	0330012	documentation nicht belegter Wert																																															
enumeration	0330013	documentation nicht belegter Wert																																															
enumeration	0330014	documentation nicht belegter Wert																																															
enumeration	0330042	documentation sonstiger Hersteller																																															
annotation	documentation Kat_AK_Hersteller																																																
source	<pre> <simpleType name="enum_0330"> <annotation> <documentation>Kat_AK_Hersteller</documentation> </annotation> <restriction base="xs:string"> <enumeration value="0330001"> <annotation> <documentation>ATS Medical</documentation> </annotation> </enumeration> <enumeration value="0330002"> <annotation> <documentation>Edwards Lifesciences</documentation> </annotation> </enumeration> <enumeration value="0330003"> <annotation> <documentation>Medtronic</documentation> </annotation> </enumeration> <enumeration value="0330004"> <annotation> <documentation>JenaValve</documentation> </annotation> </enumeration> </restriction> </simpleType> </pre>																																																

```
<enumeration value="0330005">
  <annotation>
    <documentation>Corcym</documentation>
  </annotation>
</enumeration>
<enumeration value="0330006">
  <annotation>
    <documentation>St. Jude Medical/Abbott</documentation>
  </annotation>
</enumeration>
<enumeration value="0330007">
  <annotation>
    <documentation>Symetis</documentation>
  </annotation>
</enumeration>
<enumeration value="0330008">
  <annotation>
    <documentation>Direct Flow Medical</documentation>
  </annotation>
</enumeration>
<enumeration value="0330009">
  <annotation>
    <documentation>Boston Scientific</documentation>
  </annotation>
</enumeration>
<enumeration value="0330010">
  <annotation>
    <documentation>nicht belegter Wert</documentation>
  </annotation>
</enumeration>
<enumeration value="0330011">
  <annotation>
    <documentation>nicht belegter Wert</documentation>
  </annotation>
</enumeration>
<enumeration value="0330012">
  <annotation>
    <documentation>nicht belegter Wert</documentation>
  </annotation>
</enumeration>
<enumeration value="0330013">
  <annotation>
    <documentation>nicht belegter Wert</documentation>
  </annotation>
</enumeration>
<enumeration value="0330014">
  <annotation>
    <documentation>nicht belegter Wert</documentation>
  </annotation>
</enumeration>
<enumeration value="0330042">
  <annotation>
    <documentation>sonstiger Hersteller</documentation>
  </annotation>
</enumeration>
</restriction>
</simpleType>
```

simpleType enum_0338

namespace	http://xml.ir-d.de/emg		
type	restriction of string		
properties	base xs:string		
used by	element PciAortenklappeBasis/PCA_PciArterienSchluessel		
facets	Kind	Value	Annotation
	enumeration	0338001	documentation LAD
	enumeration	0338002	documentation RCA
	enumeration	0338003	documentation RCX
	enumeration	0338004	documentation Hauptstamm
annotation	documentation Kat_AK_PCIArterien		
source	<pre> <simpleType name="enum_0338"> <annotation> <documentation>Kat_AK_PCIArterien</documentation> </annotation> <restriction base="xs:string"> <enumeration value="0338001"> <annotation> <documentation>LAD</documentation> </annotation> </enumeration> <enumeration value="0338002"> <annotation> <documentation>RCA</documentation> </annotation> </enumeration> <enumeration value="0338003"> <annotation> <documentation>RCX</documentation> </annotation> </enumeration> <enumeration value="0338004"> <annotation> <documentation>Hauptstamm</documentation> </annotation> </enumeration> </restriction> </simpleType> </pre>		

simpleType enum_0339

namespace	http://xml.ir-d.de/emg		
type	restriction of string		
properties	base xs:string		
used by	element OperationAortenklappeBasis/OAK_MessmethodeSchluessel		
facets	Kind	Value	Annotation
	enumeration	0339001	documentation TEE

	enumeration 0339002 documentation CT
	enumeration 0339042 documentation andere
annotation	documentation Kat_AK_AnnulusMessmethode
source	<pre> <simpleType name="enum_0339"> <annotation> <documentation>Kat_AK_AnnulusMessmethode</documentation> </annotation> <restriction base="xs:string"> <enumeration value="0339001"> <annotation> <documentation>TEE</documentation> </annotation> </enumeration> <enumeration value="0339002"> <annotation> <documentation>CT</documentation> </annotation> </enumeration> <enumeration value="0339042"> <annotation> <documentation>andere</documentation> </annotation> </enumeration> </restriction> </simpleType> </pre>

simpleType enum 0341

namespace	http://xml.ir-d.de/emg		
type	restriction of string		
properties	base xs:string		
used by	element FailureGrundAortenklappeBasis/FAK FailureGrundSchlussel		
facets	Kind	Value	Annotation
	enumeration	0341001	documentation intraprozedural verstorben
	enumeration	0341002	documentation Implantation von mehr als einer Prothese
	enumeration	0341003	documentation gravierende Gefäß- oder Zugangskomplikation (gemäß VARC-3)
	enumeration	0341004	documentation erforderlicher chirurgischer oder interventioneller Eingriff wegen einer Klappenfehlfunktion (gemäß VARC-3)
	enumeration	0341005	documentation >= große strukturelle kardiale Komplikation (gemäß VARC-3)
annotation	documentation Kat_AK_FailureGrund		
source	<pre> <simpleType name="enum_0341"> <annotation> <documentation>Kat_AK_FailureGrund</documentation> </annotation> <restriction base="xs:string"> <enumeration value="0341001"> <annotation> <documentation>intraprozedural verstorben</documentation> </pre>		

	<pre> </annotation> </enumeration> <enumeration value="0341002"> <annotation> <documentation>Implantation von mehr als einer Prothese</documentation> </annotation> </enumeration> <enumeration value="0341003"> <annotation> <documentation>gravierende Gefäß- oder Zugangskomplikation (gemäß VARC-3)</documentation> </annotation> </enumeration> <enumeration value="0341004"> <annotation> <documentation>erforderlicher chirurgischer oder interventioneller Eingriff wegen einer Klappenfehlfunktion (gemäß VARC-3)</documentation> </annotation> </enumeration> <enumeration value="0341005"> <annotation> <documentation>&gt;= große strukturelle kardiale Komplikation (gemäß VARC-3)</documentation> </annotation> </enumeration> </restriction> </simpleType> </pre>
--	--

simpleType enum_0342

namespace	http://xml.ir-d.de/emg		
type	restriction of string		
properties	base xs:string		
used by	element TaviAortenklappeBasis/TAK GrundTaviSchluessel		
facets	Kind	Value	Annotation
	enumeration	0342001	documentation Alter
	enumeration	0342002	documentation Frailty
	enumeration	0342003	documentation Hochrisiko
	enumeration	0342004	documentation Prognose-limitierende Zweiterkrankung
	enumeration	0342005	documentation Porzellan-Aorta
	enumeration	0342042	documentation Sonstige
annotation	documentation Kat AK Tavi		
source	<pre> <simpleType name="enum_0342"> <annotation> <documentation>Kat_AK_Tavi</documentation> </annotation> <restriction base="xs:string"> <enumeration value="0342001"> <annotation> <documentation>Alter</documentation> </pre>		

```

</annotation>
</enumeration>
<enumeration value="0342002">
  <annotation>
    <documentation>Frailty</documentation>
  </annotation>
</enumeration>
<enumeration value="0342003">
  <annotation>
    <documentation>Hochrisiko</documentation>
  </annotation>
</enumeration>
<enumeration value="0342004">
  <annotation>
    <documentation>Prognose-limitierende Zweiterkrankung</documentation>
  </annotation>
</enumeration>
<enumeration value="0342005">
  <annotation>
    <documentation>Porzellan-Aorta</documentation>
  </annotation>
</enumeration>
<enumeration value="0342042">
  <annotation>
    <documentation>Sonstige</documentation>
  </annotation>
</enumeration>
</restriction>
</simpleType>

```

simpleType enum_0343

namespace	http://xml.ir-d.de/emg		
type	restriction of string		
properties	base xs:string		
used by	element KomplikationAortenklappeBasis/KAK KomplikationTypSchluessel		
facets	Kind	Value	Annotation
	enumeration	0343001	documentation Device-Fehlpositionierung
	enumeration	0343002	documentation Koronarostienverschluss
	enumeration	0343003	documentation Aortendissektion
	enumeration	0343004	documentation Aortenregurgitation > = 2. Grades
	enumeration	0343005	documentation Annulus-Ruptur
	enumeration	0343006	documentation Ruptur-/Perforation einer Herzhöhle ohne Therapiebedarf
	enumeration	0343007	documentation Ruptur-/Perforation einer Herzhöhle mit Therapiebedarf
	enumeration	0343008	documentation Perikardtamponade
	enumeration	0343009	documentation kardiale Dekompensation
	enumeration	0343010	documentation Hirnembolie
	enumeration	0343011	documentation

	<p>enumeration 0343012 Rhythmusstörungen documentation Device-Embolisation</p> <p>enumeration 0343013 documentation vaskuläre Komplikation</p> <p>enumeration 0343014 documentation Low Cardiac Output</p> <p>enumeration 0343015 documentation schwerwiegende Blutungen (intraprozedural)</p> <p>enumeration 0343016 documentation lebensbedrohliche Blutungen (intraprozedural)</p> <p>enumeration 0343017 documentation Patient verstarb im OP/Katheterlabor</p> <p>enumeration 0343042 documentation sonstige intraprozedurale Komplikationen</p>
annotation	documentation Kat_AK_KomplikationTyp
source	<pre> <simpleType name="enum_0343"> <annotation> <documentation>Kat_AK_KomplikationTyp</documentation> </annotation> <restriction base="xs:string"> <enumeration value="0343001"> <annotation> <documentation>Device-Fehlpositionierung</documentation> </annotation> </enumeration> <enumeration value="0343002"> <annotation> <documentation>Koronarostienverschluss</documentation> </annotation> </enumeration> <enumeration value="0343003"> <annotation> <documentation>Aortendissektion</documentation> </annotation> </enumeration> <enumeration value="0343004"> <annotation> <documentation>Aortenregurgitation &gt; = 2. Grades</documentation> </annotation> </enumeration> <enumeration value="0343005"> <annotation> <documentation>Annulus-Ruptur</documentation> </annotation> </enumeration> <enumeration value="0343006"> <annotation> <documentation>Ruptur-/Perforation einer Herzhöhle ohne Therapiebedarf</documentation> </annotation> </enumeration> <enumeration value="0343007"> <annotation> <documentation>Ruptur-/Perforation einer Herzhöhle mit Therapiebedarf</documentation> </annotation> </enumeration> <enumeration value="0343008"> </pre>

```

    <annotation>
      <documentation>Perikardtamponade</documentation>
    </annotation>
  </enumeration>
  <enumeration value="0343009">
    <annotation>
      <documentation>kardiale Dekompensation</documentation>
    </annotation>
  </enumeration>
  <enumeration value="0343010">
    <annotation>
      <documentation>Hirnembolie</documentation>
    </annotation>
  </enumeration>
  <enumeration value="0343011">
    <annotation>
      <documentation>Rhythmusstörungen</documentation>
    </annotation>
  </enumeration>
  <enumeration value="0343012">
    <annotation>
      <documentation>Device-Embolisation</documentation>
    </annotation>
  </enumeration>
  <enumeration value="0343013">
    <annotation>
      <documentation>vaskuläre Komplikation</documentation>
    </annotation>
  </enumeration>
  <enumeration value="0343014">
    <annotation>
      <documentation>Low Cardiac Output</documentation>
    </annotation>
  </enumeration>
  <enumeration value="0343015">
    <annotation>
      <documentation>schwerwiegende Blutungen
(intraprozedural)</documentation>
    </annotation>
  </enumeration>
  <enumeration value="0343016">
    <annotation>
      <documentation>lebensbedrohliche Blutungen
(intraprozedural)</documentation>
    </annotation>
  </enumeration>
  <enumeration value="0343017">
    <annotation>
      <documentation>Patient verstarb im OP/Katheterlabor</documentation>
    </annotation>
  </enumeration>
  <enumeration value="0343042">
    <annotation>
      <documentation>sonstige intraprozedurale
Komplikationen</documentation>
    </annotation>
  </enumeration>
</restriction>
</simpleType>

```

simpleType enum 0346

namespace	http://xml.ir-d.de/emg		
type	restriction of string		
properties	base xs:string		
used by	element OperationAortenklappeBasis/OAK TherapieLcoSchluessel		
facets	Kind	Value	Annotation
	enumeration	0346001	documentation keine Therapie erforderlich
	enumeration	0346002	documentation medikamentös
	enumeration	0346003	documentation IABP
	enumeration	0346004	documentation VAD
	enumeration	0346005	documentation ECMO
	enumeration	0346042	documentation sonstige
annotation	documentation Kat_AK_TherapieLCO		
source	<pre> <simpleType name="enum_0346"> <annotation> <documentation>Kat_AK_TherapieLCO</documentation> </annotation> <restriction base="xs:string"> <enumeration value="0346001"> <annotation> <documentation>keine Therapie erforderlich</documentation> </annotation> </enumeration> <enumeration value="0346002"> <annotation> <documentation>medikamentös</documentation> </annotation> </enumeration> <enumeration value="0346003"> <annotation> <documentation>IABP</documentation> </annotation> </enumeration> <enumeration value="0346004"> <annotation> <documentation>VAD</documentation> </annotation> </enumeration> <enumeration value="0346005"> <annotation> <documentation>ECMO</documentation> </annotation> </enumeration> <enumeration value="0346042"> <annotation> <documentation>sonstige</documentation> </annotation> </enumeration> </restriction> </pre>		

	<pre> </restriction> </simpleType> </pre>
--	---

simpleType enum_0347

namespace	http://xml.ir-d.de/emg		
type	restriction of string		
properties	base xs:string		
used by	element OperationAortenklappeBasis/OAK EingriffsumfangSchluessel		
facets	Kind	Value	Annotation
	enumeration	0347001	documentation Einzeleingriff
	enumeration	0347002	documentation Kombinationseingriff mit mehreren Prozeduren
annotation	documentation Kat_AK_Eingriffsumfang		
source	<pre> <simpleType name="enum_0347"> <annotation> <documentation>Kat_AK_Eingriffsumfang</documentation> </annotation> <restriction base="xs:string"> <enumeration value="0347001"> <annotation> <documentation>Einzeleingriff</documentation> </annotation> </enumeration> <enumeration value="0347002"> <annotation> <documentation>Kombinationseingriff mit mehreren Prozeduren</documentation> </annotation> </enumeration> </restriction> </simpleType> </pre>		

simpleType enum_0348

namespace	http://xml.ir-d.de/emg		
type	restriction of string		
properties	base xs:string		
used by	element OperationAortenklappeBasis/OAK VorgehenSchluessel		
facets	Kind	Value	Annotation
	enumeration	0348001	documentation mit HLM
	enumeration	0348002	documentation ohne HLM
	enumeration	0348003	documentation Umstieg von OP ohne HLM auf OP mit HLM
annotation	documentation Kat_AK_OPVorgehen		
source	<pre> <simpleType name="enum_0348"> <annotation> <documentation>Kat AK OPVorgehen</documentation> </annotation> </pre>		

	<pre> </annotation> <restriction base="xs:string"> <enumeration value="0348001"> <annotation> <documentation>mit HLM</documentation> </annotation> </enumeration> <enumeration value="0348002"> <annotation> <documentation>ohne HLM</documentation> </annotation> </enumeration> <enumeration value="0348003"> <annotation> <documentation>Umstieg von OP ohne HLM auf OP mit HLM</documentation> </annotation> </enumeration> </restriction> </simpleType> </pre>
--	---

simpleType enum 0350

namespace	http://xml.ir-d.de/emg		
type	restriction of string		
properties	base xs:string		
used by	elements OperationAortenklappeBasis/OAK IntraOpMethodeSchluessel OperationAortenklappeBasis/OAK PraeOpMethodeSchluessel		
facets	Kind	Value	Annotation
	enumeration	0350001	documentation IABP
	enumeration	0350002	documentation Impella
	enumeration	0350003	documentation vv ECMO
	enumeration	0350004	documentation va ECMO
	enumeration	0350042	documentation andere
annotation	documentation Kat AK Methode		
source	<pre> <simpleType name="enum_0350"> <annotation> <documentation>Kat_AK_Methode</documentation> </annotation> <restriction base="xs:string"> <enumeration value="0350001"> <annotation> <documentation>IABP</documentation> </annotation> </enumeration> <enumeration value="0350002"> <annotation> <documentation>Impella</documentation> </annotation> </enumeration> <enumeration value="0350003"> <annotation> </pre>		

```

    <documentation>vv ECMO</documentation>
  </annotation>
</enumeration>
<enumeration value="0350004">
  <annotation>
    <documentation>va ECMO</documentation>
  </annotation>
</enumeration>
<enumeration value="0350042">
  <annotation>
    <documentation>andere</documentation>
  </annotation>
</enumeration>
</restriction>
</simpleType>

```

simpleType enum 0351

namespace	http://xml.ir-d.de/emg		
type	restriction of string		
properties	base xs:string		
used by	element OperationAortenklappeBasis/OAK KonversionSchluessel		
facets	Kind	Value	Annotation
	enumeration	0351001	documentation nein
	enumeration	0351002	documentation ja, zu Sternotomie
	enumeration	0351003	documentation ja, zu transapikal
	enumeration	0351004	documentation ja, zu transaortal
	enumeration	0351005	documentation ja, zu transfemoral
	enumeration	0351006	documentation ja, zu transaxillär
	enumeration	0351007	documentation ja, zu anderem endovaskulären Zugang
	enumeration	0351042	documentation ja, zu anderem Zugang
annotation	documentation Kat_AK_Konversion		
source	<pre> <simpleType name="enum_0351"> <annotation> <documentation>Kat_AK_Konversion</documentation> </annotation> <restriction base="xs:string"> <enumeration value="0351001"> <annotation> <documentation>nein</documentation> </annotation> </enumeration> <enumeration value="0351002"> <annotation> <documentation>ja, zu Sternotomie</documentation> </annotation> </enumeration> <enumeration value="0351003"> </pre>		

	<pre> <annotation> <documentation>ja, zu transapikal</documentation> </annotation> </enumeration> <enumeration value="0351004"> <annotation> <documentation>ja, zu transaortal</documentation> </annotation> </enumeration> <enumeration value="0351005"> <annotation> <documentation>ja, zu transfemoral</documentation> </annotation> </enumeration> <enumeration value="0351006"> <annotation> <documentation>ja, zu transaxillär</documentation> </annotation> </enumeration> <enumeration value="0351007"> <annotation> <documentation>ja, zu anderem endovaskulären Zugang</documentation> </annotation> </enumeration> <enumeration value="0351042"> <annotation> <documentation>ja, zu anderem Zugang</documentation> </annotation> </enumeration> </restriction> </simpleType> </pre>
--	--

simpleType enum_0352

namespace	http://xml.ir-d.de/emg		
type	restriction of string		
properties	base xs:string		
used by	element	OperationAortenklappeBasis/OAK AnaesthesieSchluessel	
facets	Kind	Value	Annotation
	enumeration	0352001	documentation nein
	enumeration	0352002	documentation ja, Intubationsnarkose
	enumeration	0352003	documentation ja, Maskenbeatmung, incl. LAMA
	enumeration	0352042	documentation ja, unbekannt welche
annotation	documentation	Kat_AK_Anaesthesie	
source	<pre> <simpleType name="enum_0352"> <annotation> <documentation>Kat_AK_Anaesthesie</documentation> </annotation> <restriction base="xs:string"> <enumeration value="0352001"> <annotation> </pre>		

```

        <documentation>nein</documentation>
    </annotation>
</enumeration>
<enumeration value="0352002">
    <annotation>
        <documentation>ja, Intubationsnarkose</documentation>
    </annotation>
</enumeration>
<enumeration value="0352003">
    <annotation>
        <documentation>ja, Maskenbeatmung, incl. LAMA</documentation>
    </annotation>
</enumeration>
<enumeration value="0352042">
    <annotation>
        <documentation>ja, unbekannt welche</documentation>
    </annotation>
</enumeration>
</restriction>
</simpleType>

```

simpleType **enum_0353**

namespace	http://xml.ir-d.de/emg		
type	restriction of string		
properties	base xs:string		
used by	element	OperationAortenklappeBasis/OAK ResidualeInsuffizienzSchlussel	
facets	Kind	Value	Annotation
	enumeration	0353001	documentation keine
	enumeration	0353002	documentation leichtgradig
	enumeration	0353003	documentation mittelgradig
	enumeration	0353004	documentation hochgradig
	enumeration	0353099	documentation nicht bestimmbar
annotation	documentation Kat_AK_ResidualeAorteninsuffizienz		
source	<pre> <simpleType name="enum_0353"> <annotation> <documentation>Kat_AK_ResidualeAorteninsuffizienz</documentation> </annotation> <restriction base="xs:string"> <enumeration value="0353001"> <annotation> <documentation>keine</documentation> </annotation> </enumeration> <enumeration value="0353002"> <annotation> <documentation>leichtgradig</documentation> </annotation> </enumeration> <enumeration value="0353003"> </pre>		

	<pre> <annotation> <documentation>mittelgradig</documentation> </annotation> </enumeration> <enumeration value="0353004"> <annotation> <documentation>hochgradig</documentation> </annotation> </enumeration> <enumeration value="0353099"> <annotation> <documentation>nicht bestimmbar</documentation> </annotation> </enumeration> </restriction> </simpleType> </pre>
--	---

simpleType enum 0354

namespace	http://xml.ir-d.de/emg		
type	restriction of string		
properties	base xs:string		
used by	element OperationAortenklappeBasis/OAK ZugangVerschlussSchlüssel		
facets	Kind	Value	Annotation
	enumeration	0354001	documentation chirurgisch-offen
	enumeration	0354002	documentation Verschluss-System
	enumeration	0354042	documentation sonstige
annotation	documentation Kat_AK_Zugangswegverschluss		
source	<pre> <simpleType name="enum_0354"> <annotation> <documentation>Kat_AK_Zugangswegverschluss</documentation> </annotation> <restriction base="xs:string"> <enumeration value="0354001"> <annotation> <documentation>chirurgisch-offen</documentation> </annotation> </enumeration> <enumeration value="0354002"> <annotation> <documentation>Verschluss-System</documentation> </annotation> </enumeration> <enumeration value="0354042"> <annotation> <documentation>sonstige</documentation> </annotation> </enumeration> </restriction> </simpleType> </pre>		

simpleType enum_0357

namespace	http://xml.ir-d.de/emg		
type	restriction of string		
properties	base xs:string		
used by	element PatientenaufnahmeAortenklappeBasis/PAA BefundSchluessel		
facets	Kind	Value	Annotation
	enumeration	0357001	documentation keine KHK
	enumeration	0357002	documentation 1-Gefäßerkrankung
	enumeration	0357003	documentation 2-Gefäßerkrankung
	enumeration	0357004	documentation 3-Gefäßerkrankung
	enumeration	0357005	documentation keine koronare Bildgebung
annotation	documentation Kat_AK_BefundBildgebung		
source	<pre> <simpleType name="enum_0357"> <annotation> <documentation>Kat_AK_BefundBildgebung</documentation> </annotation> <restriction base="xs:string"> <enumeration value="0357001"> <annotation> <documentation>keine KHK</documentation> </annotation> </enumeration> <enumeration value="0357002"> <annotation> <documentation>1-Gefäßerkrankung</documentation> </annotation> </enumeration> <enumeration value="0357003"> <annotation> <documentation>2-Gefäßerkrankung</documentation> </annotation> </enumeration> <enumeration value="0357004"> <annotation> <documentation>3-Gefäßerkrankung</documentation> </annotation> </enumeration> <enumeration value="0357005"> <annotation> <documentation>keine koronare Bildgebung</documentation> </annotation> </enumeration> </restriction> </simpleType> </pre>		

simpleType enum_0358

namespace	http://xml.ir-d.de/emg
-----------	------------------------

type	restriction of string		
properties	base xs:string		
used by	element PatientenaufnahmeAortenklappeBasis/PAA_AnzahlVorOpSchlüssel		
facets	Kind	Value	Annotation
	enumeration	0358001	documentation 0
	enumeration	0358002	documentation 1
	enumeration	0358003	documentation 2
	enumeration	0358004	documentation 3
	enumeration	0358005	documentation 4
	enumeration	0358006	documentation 5 oder mehr
	enumeration	0358098	documentation genaue Anzahl unbekannt (aber mind. 1)
	enumeration	0358099	documentation unbekannt
annotation	documentation Kat_AK_AnzahlVorOP		
source	<pre> <simpleType name="enum_0358"> <annotation> <documentation>Kat_AK_AnzahlVorOP</documentation> </annotation> <restriction base="xs:string"> <enumeration value="0358001"> <annotation> <documentation>0</documentation> </annotation> </enumeration> <enumeration value="0358002"> <annotation> <documentation>1</documentation> </annotation> </enumeration> <enumeration value="0358003"> <annotation> <documentation>2</documentation> </annotation> </enumeration> <enumeration value="0358004"> <annotation> <documentation>3</documentation> </annotation> </enumeration> <enumeration value="0358005"> <annotation> <documentation>4</documentation> </annotation> </enumeration> <enumeration value="0358006"> <annotation> <documentation>5 oder mehr</documentation> </annotation> </enumeration> <enumeration value="0358098"> <annotation> </pre>		

	<pre> <documentation>genaue Anzahl unbekannt (aber mind. 1)</documentation> </annotation> </enumeration> <enumeration value="0358099"> <annotation> <documentation>unbekannt</documentation> </annotation> </enumeration> </restriction> </simpleType> </pre>
--	---

simpleType enum_0359

namespace	http://xml.ir-d.de/emg		
type	restriction of string		
properties	base xs:string		
used by	element PatientenaufnahmeAortenklappeBasis/PAA_LvotSchluessel		
facets	Kind	Value	Annotation
	enumeration	0359001	documentation nein
	enumeration	0359002	documentation ja - einseitig
	enumeration	0359003	documentation ja - beidseitig
	enumeration	0359042	documentation unbekannt
annotation	documentation Kat AK LVOT		
source	<pre> <simpleType name="enum_0359"> <annotation> <documentation>Kat_AK_LVOT</documentation> </annotation> <restriction base="xs:string"> <enumeration value="0359001"> <annotation> <documentation>nein</documentation> </annotation> </enumeration> <enumeration value="0359002"> <annotation> <documentation>ja - einseitig</documentation> </annotation> </enumeration> <enumeration value="0359003"> <annotation> <documentation>ja - beidseitig</documentation> </annotation> </enumeration> <enumeration value="0359042"> <annotation> <documentation>unbekannt</documentation> </annotation> </enumeration> </restriction> </simpleType> </pre>		

simpleType enum_0360

namespace	http://xml.ir-d.de/emg		
type	restriction of string		
properties	base xs:string		
used by	elements PatientenaufnahmeAortenklappeBasis/PAA_TrikuspidalinsuffizienzSchluessel PostoperationAortenklappeBasis/POA_TrikuspidalinsuffizienzSchluessel		
facets	Kind	Value	Annotation
	enumeration	0360001	documentation keine
	enumeration	0360002	documentation leichtgradig
	enumeration	0360003	documentation mittelgradig
	enumeration	0360004	documentation hochgradig
	enumeration	0360005	documentation massive
	enumeration	0360006	documentation torrential
	enumeration	0360099	documentation unbekannt
annotation	documentation Kat_AK_TriskupidalInsuffizienz		
source	<pre> <simpleType name="enum_0360"> <annotation> <documentation>Kat_AK_TriskupidalInsuffizienz</documentation> </annotation> <restriction base="xs:string"> <enumeration value="0360001"> <annotation> <documentation>keine</documentation> </annotation> </enumeration> <enumeration value="0360002"> <annotation> <documentation>leichtgradig</documentation> </annotation> </enumeration> <enumeration value="0360003"> <annotation> <documentation>mittelgradig</documentation> </annotation> </enumeration> <enumeration value="0360004"> <annotation> <documentation>hochgradig</documentation> </annotation> </enumeration> <enumeration value="0360005"> <annotation> <documentation>massive</documentation> </annotation> </enumeration> <enumeration value="0360006"> <annotation> <documentation>torrential</documentation> </annotation> </enumeration> </restriction> </simpleType> </pre>		

	<pre> </enumeration> <enumeration value="0360099"> <annotation> <documentation>unbekannt</documentation> </annotation> </enumeration> </restriction> </simpleType> </pre>
--	---

simpleType enum_0361

namespace	http://xml.ir-d.de/emg		
type	restriction of string		
properties	base xs:string		
used by	elements	PatientenaufnahmeAortenklappeBasis/PAA DekompensationSchluessel PatientenaufnahmeAortenklappeBasis/PAA ReanimationSchluessel	
facets	Kind	Value	Annotation
	enumeration	0361001	documentation nein
	enumeration	0361002	documentation ja, letzte(r) innerhalb der letzten 48 Stunden
	enumeration	0361003	documentation ja, letzte(r) innerhalb der letzten 21 Tage
	enumeration	0361004	documentation ja, letzte(r) länger als 21 Tage
	enumeration	0361098	documentation ja, letzter Zeitpunkt unbekannt
	enumeration	0361099	documentation unbekannt
annotation	documentation Kat_AK_SchockReanimation		
source	<pre> <simpleType name="enum_0361"> <annotation> <documentation>Kat_AK_SchockReanimation</documentation> </annotation> <restriction base="xs:string"> <enumeration value="0361001"> <annotation> <documentation>nein</documentation> </annotation> </enumeration> <enumeration value="0361002"> <annotation> <documentation>ja, letzte(r) innerhalb der letzten 48 Stunden</documentation> </annotation> </enumeration> <enumeration value="0361003"> <annotation> <documentation>ja, letzte(r) innerhalb der letzten 21 Tage</documentation> </annotation> </enumeration> <enumeration value="0361004"> <annotation> <documentation>ja, letzte(r) länger als 21 Tage</documentation> </annotation> </pre>		

	<pre> </enumeration> <enumeration value="0361098"> <annotation> <documentation>ja, letzter Zeitpunkt unbekannt</documentation> </annotation> </enumeration> <enumeration value="0361099"> <annotation> <documentation>unbekannt</documentation> </annotation> </enumeration> </restriction> </simpleType> </pre>
--	--

simpleType enum_0362

namespace	http://xml.ir-d.de/emg		
type	restriction of string		
properties	base xs:string		
used by	element PatientenaufnahmeAortenklappeBasis/PAA HerzrhythmusSchlüssel		
facets	Kind	Value	Annotation
	enumeration	0362001	documentation Sinusrhythmus
	enumeration	0362002	documentation Vorhofflimmern
	enumeration	0362042	documentation anderer Herzrhythmus
annotation	documentation Kat_AK_Herzrhythmus		
source	<pre> <simpleType name="enum_0362"> <annotation> <documentation>Kat_AK_Herzrhythmus</documentation> </annotation> <restriction base="xs:string"> <enumeration value="0362001"> <annotation> <documentation>Sinusrhythmus</documentation> </annotation> </enumeration> <enumeration value="0362002"> <annotation> <documentation>Vorhofflimmern</documentation> </annotation> </enumeration> <enumeration value="0362042"> <annotation> <documentation>anderer Herzrhythmus</documentation> </annotation> </enumeration> </restriction> </simpleType> </pre>		

simpleType enum_0363

namespace	http://xml.ir-d.de/emg
-----------	------------------------

type	restriction of string		
properties	base xs:string		
used by	element PatientenaufnahmeAortenklappeBasis/PAA VorhofflimmernSchluessel		
facets	Kind	Value	Annotation
	enumeration	0363001	documentation nein
	enumeration	0363002	documentation paroxysmal
	enumeration	0363003	documentation persistierend
	enumeration	0363004	documentation permanent
annotation	documentation Kat_AK_Vorhofflimmern		
source	<pre> <simpleType name="enum_0363"> <annotation> <documentation>Kat_AK_Vorhofflimmern</documentation> </annotation> <restriction base="xs:string"> <enumeration value="0363001"> <annotation> <documentation>nein</documentation> </annotation> </enumeration> <enumeration value="0363002"> <annotation> <documentation>paroxysmal</documentation> </annotation> </enumeration> <enumeration value="0363003"> <annotation> <documentation>persistierend</documentation> </annotation> </enumeration> <enumeration value="0363004"> <annotation> <documentation>permanent</documentation> </annotation> </enumeration> </restriction> </simpleType> </pre>		

simpleType **enum_0364**

namespace	http://xml.ir-d.de/emg		
type	restriction of string		
properties	base xs:string		
used by	elements PatientenaufnahmeAortenklappeBasis/PAA SchrittmacherSchluessel PostoperationAortenklappeBasis/POA SchrittmacherSchluessel		
facets	Kind	Value	Annotation
	enumeration	0364001	documentation nein
	enumeration	0364002	documentation Schrittmacher ohne CRT-System
	enumeration	0364003	documentation Schrittmacher mit CRT-System

	enumeration 0364004 documentation Defibrillator ohne CRT-System enumeration 0364005 documentation Defibrillator mit CRT-System
annotation	documentation Kat_AK_SchrittmacherDefi
source	<pre> <simpleType name="enum_0364"> <annotation> <documentation>Kat_AK_SchrittmacherDefi</documentation> </annotation> <restriction base="xs:string"> <enumeration value="0364001"> <annotation> <documentation>nein</documentation> </annotation> </enumeration> <enumeration value="0364002"> <annotation> <documentation>Schrittmacher ohne CRT-System</documentation> </annotation> </enumeration> <enumeration value="0364003"> <annotation> <documentation>Schrittmacher mit CRT-System</documentation> </annotation> </enumeration> <enumeration value="0364004"> <annotation> <documentation>Defibrillator ohne CRT-System</documentation> </annotation> </enumeration> <enumeration value="0364005"> <annotation> <documentation>Defibrillator mit CRT-System</documentation> </annotation> </enumeration> </restriction> </simpleType> </pre>

simpleType enum_0365

namespace	http://xml.ir-d.de/emg		
type	restriction of string		
properties	base xs:string		
used by	element	PatientenaufnahmeAortenklappeBasis/PAA_RevaskularisationSchluessel	
facets	Kind	Value	Annotation
	enumeration	0365001	documentation nein
	enumeration	0365002	documentation ja, operativ
	enumeration	0365003	documentation ja, interventionell
annotation	documentation Kat_AK_MyokardRevaskularisation		
source	<pre> <simpleType name="enum_0365"> <annotation> </pre>		

```

<documentation>Kat_AK_MyokardRevaskularisation</documentation>
</annotation>
<restriction base="xs:string">
  <enumeration value="0365001">
    <annotation>
      <documentation>nein</documentation>
    </annotation>
  </enumeration>
  <enumeration value="0365002">
    <annotation>
      <documentation>ja, operativ</documentation>
    </annotation>
  </enumeration>
  <enumeration value="0365003">
    <annotation>
      <documentation>ja, interventionell</documentation>
    </annotation>
  </enumeration>
</restriction>
</simpleType>

```

simpleType **enum_0366**

namespace	http://xml.ir-d.de/emg		
type	restriction of string		
properties	base xs:string		
used by	element	PatientenaufnahmeAortenklappeBasis/PAA PciSchluessel	
facets	Kind	Value	Annotation
	enumeration	0366001	documentation nein
	enumeration	0366002	documentation ja, <= 6 Stunden
	enumeration	0366003	documentation ja, > 6 Stunden bis <= 3 Monate
	enumeration	0366004	documentation ja, > 3 Monate
	enumeration	0366099	documentation unbekannt
annotation	documentation	Kat_AK_PCI	
source	<pre> <simpleType name="enum_0366"> <annotation> <documentation>Kat_AK_PCI</documentation> </annotation> <restriction base="xs:string"> <enumeration value="0366001"> <annotation> <documentation>nein</documentation> </annotation> </enumeration> <enumeration value="0366002"> <annotation> <documentation>ja, &lt;= 6 Stunden</documentation> </annotation> </enumeration> <enumeration value="0366003"> </pre>		

```

<annotation>
  <documentation>ja, > 6 Stunden bis <= 3 Monate</documentation>
</annotation>
</enumeration>
<enumeration value="0366004">
  <annotation>
    <documentation>ja, > 3 Monate</documentation>
  </annotation>
</enumeration>
<enumeration value="0366099">
  <annotation>
    <documentation>unbekannt</documentation>
  </annotation>
</enumeration>
</restriction>
</simpleType>

```

simpleType enum **0367**

namespace	http://xml.ir-d.de/emg		
type	restriction of string		
properties	base xs:string		
used by	element InfektionAortenklappeBasis/IAK InfektionSchluessel		
facets	Kind	Value	Annotation
	enumeration	0367001	documentation keine
	enumeration	0367002	documentation Mediastinitis
	enumeration	0367003	documentation Sepsis
	enumeration	0367004	documentation broncho-pulmonale Infektion
	enumeration	0367005	documentation oto-laryngologische Infektion
	enumeration	0367006	documentation floride Endokarditis
	enumeration	0367007	documentation Peritonitis
	enumeration	0367008	documentation Wundinfektion Thorax
	enumeration	0367009	documentation Pleuraempyem
	enumeration	0367010	documentation Venenkatheterinfektion
	enumeration	0367011	documentation Harnwegsinfektion
	enumeration	0367012	documentation Wundinfektion untere Extremitäten
	enumeration	0367013	documentation HIV-Infektion
	enumeration	0367014	documentation Hepatitis B oder C
	enumeration	0367015	documentation andere Wundinfektion
	enumeration	0367042	documentation sonstige Infektion
annotation	documentation Kat AK Infektion		

source

```
<simpleType name="enum_0367">
  <annotation>
    <documentation>Kat_AK_Infektion</documentation>
  </annotation>
  <restriction base="xs:string">
    <enumeration value="0367001">
      <annotation>
        <documentation>keine</documentation>
      </annotation>
    </enumeration>
    <enumeration value="0367002">
      <annotation>
        <documentation>Mediastinitis</documentation>
      </annotation>
    </enumeration>
    <enumeration value="0367003">
      <annotation>
        <documentation>Sepsis</documentation>
      </annotation>
    </enumeration>
    <enumeration value="0367004">
      <annotation>
        <documentation>broncho-pulmonale Infektion</documentation>
      </annotation>
    </enumeration>
    <enumeration value="0367005">
      <annotation>
        <documentation>oto-laryngologische Infektion</documentation>
      </annotation>
    </enumeration>
    <enumeration value="0367006">
      <annotation>
        <documentation>floride Endokarditis</documentation>
      </annotation>
    </enumeration>
    <enumeration value="0367007">
      <annotation>
        <documentation>Peritonitis</documentation>
      </annotation>
    </enumeration>
    <enumeration value="0367008">
      <annotation>
        <documentation>Wundinfektion Thorax</documentation>
      </annotation>
    </enumeration>
    <enumeration value="0367009">
      <annotation>
        <documentation>Pleuraempyem</documentation>
      </annotation>
    </enumeration>
    <enumeration value="0367010">
      <annotation>
        <documentation>Venenkatheterinfektion</documentation>
      </annotation>
    </enumeration>
    <enumeration value="0367011">
      <annotation>
        <documentation>Harnwegsinfektion</documentation>
      </annotation>
    </enumeration>
  </restriction>
</simpleType>
```

	<pre> </enumeration> <enumeration value="0367012"> <annotation> <documentation>Wundinfektion untere Extremitäten</documentation> </annotation> </enumeration> <enumeration value="0367013"> <annotation> <documentation>HIV-Infektion</documentation> </annotation> </enumeration> <enumeration value="0367014"> <annotation> <documentation>Hepatitis B oder C</documentation> </annotation> </enumeration> <enumeration value="0367015"> <annotation> <documentation>andere Wundinfektion</documentation> </annotation> </enumeration> <enumeration value="0367042"> <annotation> <documentation>sonstige Infektion</documentation> </annotation> </enumeration> </restriction> </simpleType> </pre>
--	--

simpleType enum_0368

namespace	http://xml.ir-d.de/emg		
type	restriction of string		
properties	base xs:string		
used by	element PatientenaufnahmeAortenklappeBasis/PAA LungenerkrankungSchluessel		
facets	Kind	Value	Annotation
	enumeration	0368001	documentation nein
	enumeration	0368002	documentation ja, COPD mit Dauermedikation
	enumeration	0368003	documentation ja, COPD ohne Dauermedikation
	enumeration	0368004	documentation ja, andere Lungenerkrankungen
	enumeration	0368099	documentation unbekannt
annotation	documentation Kat_AK_Lungenerkrankung		
source	<pre> <simpleType name="enum_0368"> <annotation> <documentation>Kat_AK_Lungenerkrankung</documentation> </annotation> <restriction base="xs:string"> <enumeration value="0368001"> <annotation> <documentation>nein</documentation> </pre>		

	<pre> </annotation> </enumeration> <enumeration value="0368002"> <annotation> <documentation>ja, COPD mit Dauermedikation</documentation> </annotation> </enumeration> <enumeration value="0368003"> <annotation> <documentation>ja, COPD ohne Dauermedikation</documentation> </annotation> </enumeration> <enumeration value="0368004"> <annotation> <documentation>ja, andere Lungenerkrankungen</documentation> </annotation> </enumeration> <enumeration value="0368099"> <annotation> <documentation>unbekannt</documentation> </annotation> </enumeration> </restriction> </simpleType> </pre>
--	---

simpleType enum_0369

namespace	http://xml.ir-d.de/emg												
type	restriction of string												
properties	base xs:string												
used by	element PatientenaufnahmeKardiologieBasis/PKA_NierenersatzSchluessel												
facets	<table border="1"> <thead> <tr> <th>Kind</th> <th>Value</th> <th>Annotation</th> </tr> </thead> <tbody> <tr> <td>enumeration</td> <td>0369001</td> <td>documentation nein</td> </tr> <tr> <td>enumeration</td> <td>0369002</td> <td>documentation akut</td> </tr> <tr> <td>enumeration</td> <td>0369003</td> <td>documentation chronisch</td> </tr> </tbody> </table>	Kind	Value	Annotation	enumeration	0369001	documentation nein	enumeration	0369002	documentation akut	enumeration	0369003	documentation chronisch
Kind	Value	Annotation											
enumeration	0369001	documentation nein											
enumeration	0369002	documentation akut											
enumeration	0369003	documentation chronisch											
annotation	documentation Kat_AK_Nierenersatztherapie												
source	<pre> <simpleType name="enum_0369"> <annotation> <documentation>Kat_AK_Nierenersatztherapie</documentation> </annotation> <restriction base="xs:string"> <enumeration value="0369001"> <annotation> <documentation>nein</documentation> </annotation> </enumeration> <enumeration value="0369002"> <annotation> <documentation>akut</documentation> </annotation> </enumeration> <enumeration value="0369003"> </pre>												

	<pre> <annotation> <documentation>chronisch</documentation> </annotation> </enumeration> </restriction> </simpleType> </pre>
--	--

simpleType enum_0370

namespace	http://xml.ir-d.de/emg		
type	restriction of string		
properties	base xs:string		
used by	element PatientenaufnahmeAortenklappeBasis/PAA AkoefMethodeSchluessel		
facets	Kind	Value	Annotation
	enumeration	0370001	documentation Echokardiographie
	enumeration	0370002	documentation Herzkatheter
	enumeration	0370042	documentation andere
annotation	documentation Kat_AK_AKOEFMessmethode		
source	<pre> <simpleType name="enum_0370"> <annotation> <documentation>Kat_AK_AKOEFMessmethode</documentation> </annotation> <restriction base="xs:string"> <enumeration value="0370001"> <annotation> <documentation>Echokardiographie</documentation> </annotation> </enumeration> <enumeration value="0370002"> <annotation> <documentation>Herzkatheter</documentation> </annotation> </enumeration> <enumeration value="0370042"> <annotation> <documentation>andere</documentation> </annotation> </enumeration> </restriction> </simpleType> </pre>		

simpleType enum_0371

namespace	http://xml.ir-d.de/emg		
type	restriction of string		
properties	base xs:string		
used by	element PatientenaufnahmeAortenklappeBasis/PAA VerkalkungsgradSchluessel		
facets	Kind	Value	Annotation
	enumeration	0371001	documentation

	enumeration 0371002 keine documentation leicht enumeration 0371003 documentation mittel enumeration 0371004 documentation schwer enumeration 0371099 documentation unbekannt
annotation	documentation Kat_AK_Verkalkungsgrad
source	<pre> <simpleType name="enum_0371"> <annotation> <documentation>Kat_AK_Verkalkungsgrad</documentation> </annotation> <restriction base="xs:string"> <enumeration value="0371001"> <annotation> <documentation>keine</documentation> </annotation> </enumeration> <enumeration value="0371002"> <annotation> <documentation>leicht</documentation> </annotation> </enumeration> <enumeration value="0371003"> <annotation> <documentation>mittel</documentation> </annotation> </enumeration> <enumeration value="0371004"> <annotation> <documentation>schwer</documentation> </annotation> </enumeration> <enumeration value="0371099"> <annotation> <documentation>unbekannt</documentation> </annotation> </enumeration> </restriction> </simpleType> </pre>

simpleType enum_0372

namespace	http://xml.ir-d.de/emg		
type	restriction of string		
properties	base xs:string		
used by	element PatientenaufnahmeAortenklappeBasis/PAA_BiUnicuspideKlappeSchluessel		
facets	Kind	Value	Annotation
	enumeration	0372001	documentation nein
	enumeration	0372002	documentation ja, bicuspide
	enumeration	0372003	documentation ja, unicuspide

	enumeration 0372099 documentation unbekannt
annotation	documentation Kat_AK_BiUnicuspideKlappe
source	<pre> <simpleType name="enum_0372"> <annotation> <documentation>Kat_AK_BiUnicuspideKlappe</documentation> </annotation> <restriction base="xs:string"> <enumeration value="0372001"> <annotation> <documentation>nein</documentation> </annotation> </enumeration> <enumeration value="0372002"> <annotation> <documentation>ja, bicuspide</documentation> </annotation> </enumeration> <enumeration value="0372003"> <annotation> <documentation>ja, unicuspide</documentation> </annotation> </enumeration> <enumeration value="0372099"> <annotation> <documentation>unbekannt</documentation> </annotation> </enumeration> </restriction> </simpleType> </pre>

simpleType enum_0373

namespace	http://xml.ir-d.de/emg		
type	restriction of string		
properties	base xs:string		
used by	elements PatientenaufnahmeAortenklappeBasis/PAA AorteninsuffizienzSchluessel PatientenaufnahmeAortenklappeBasis/PAA AortenstenoseSchluessel PatientenaufnahmeAortenklappeBasis/PAA MitralinsuffizienzSchluessel PostoperationAortenklappeBasis/POA AorteninsuffizienzSchluessel PostoperationAortenklappeBasis/POA MitralinsuffizienzSchluessel		
facets	Kind	Value	Annotation
	enumeration	0373001	documentation keine
	enumeration	0373002	documentation leichtgradig
	enumeration	0373003	documentation mittelgradig
	enumeration	0373004	documentation hochgradig
	enumeration	0373099	documentation unbekannt
annotation	documentation Kat_AK_Grad		
source	<pre> <simpleType name="enum_0373"> <annotation> </pre>		

	<pre> <documentation>Kat_AK_Grad</documentation> </annotation> <restriction base="xs:string"> <enumeration value="0373001"> <annotation> <documentation>keine</documentation> </annotation> </enumeration> <enumeration value="0373002"> <annotation> <documentation>leichtgradig</documentation> </annotation> </enumeration> <enumeration value="0373003"> <annotation> <documentation>mittelgradig</documentation> </annotation> </enumeration> <enumeration value="0373004"> <annotation> <documentation>hochgradig</documentation> </annotation> </enumeration> <enumeration value="0373099"> <annotation> <documentation>unbekannt</documentation> </annotation> </enumeration> </restriction> </simpleType> </pre>
--	---

simpleType enum_0374

namespace	http://xml.ir-d.de/emg		
type	restriction of string		
properties	base xs:string		
used by	element	PatientenaufnahmeAortenklappeBasis/PAA MyokardinfarktSchluessel	
facets	Kind	Value	Annotation
	enumeration	0374001	documentation nein
	enumeration	0374002	documentation ja, <= 6 Stunden
	enumeration	0374003	documentation ja, > 6 Stunden bis <= 24 Stunden
	enumeration	0374004	documentation ja, > 1 bis 7 Tage
	enumeration	0374005	documentation ja, > 7 bis 21 Tage
	enumeration	0374006	documentation ja, > 21 Tage
annotation	documentation Kat_AK_InfarktAnamnese		
source	<pre> <simpleType name="enum_0374"> <annotation> <documentation>Kat_AK_InfarktAnamnese</documentation> </annotation> <restriction base="xs:string"> </pre>		

```

<enumeration value="0374001">
  <annotation>
    <documentation>nein</documentation>
  </annotation>
</enumeration>
<enumeration value="0374002">
  <annotation>
    <documentation>ja, &lt;= 6 Stunden</documentation>
  </annotation>
</enumeration>
<enumeration value="0374003">
  <annotation>
    <documentation>ja, &gt; 6 Stunden bis &lt;= 24 Stunden</documentation>
  </annotation>
</enumeration>
<enumeration value="0374004">
  <annotation>
    <documentation>ja, &gt; 1 bis 7 Tage</documentation>
  </annotation>
</enumeration>
<enumeration value="0374005">
  <annotation>
    <documentation>ja, &gt; 7 bis 21 Tage</documentation>
  </annotation>
</enumeration>
<enumeration value="0374006">
  <annotation>
    <documentation>ja, &gt; 21 Tage</documentation>
  </annotation>
</enumeration>
</restriction>
</simpleType>

```

simpleType enum_0375

namespace	http://xml.ir-d.de/emg		
type	restriction of string		
properties	base xs:string		
used by	element PatientenaufnahmeAortenklappeBasis/PAA_SymptomeSchluessel		
facets	Kind	Value	Annotation
	enumeration	0375001	documentation keine Symptome oder Angina
	enumeration	0375002	documentation Symptome, aber keine Ischämiezeichen
	enumeration	0375003	documentation stabile Angina
	enumeration	0375004	documentation instabile Angina
	enumeration	0375005	documentation Infarkt ohne ST-Hebung (Non-STEMI)
	enumeration	0375006	documentation Infarkt mit ST-Hebung (STEMI)
	enumeration	0375042	documentation unbekannt
annotation	documentation Kat_AK_KardialeSymptome		
source	<simpleType name="enum_0375">		

```

<annotation>
  <documentation>Kat_AK_KardialeSymptome</documentation>
</annotation>
<restriction base="xs:string">
  <enumeration value="0375001">
    <annotation>
      <documentation>keine Symptome oder Angina</documentation>
    </annotation>
  </enumeration>
  <enumeration value="0375002">
    <annotation>
      <documentation>Symptome, aber keine Ischämiezeichen</documentation>
    </annotation>
  </enumeration>
  <enumeration value="0375003">
    <annotation>
      <documentation>stabile Angina</documentation>
    </annotation>
  </enumeration>
  <enumeration value="0375004">
    <annotation>
      <documentation>instabile Angina</documentation>
    </annotation>
  </enumeration>
  <enumeration value="0375005">
    <annotation>
      <documentation>Infarkt ohne ST-Hebung (Non-STEMI)</documentation>
    </annotation>
  </enumeration>
  <enumeration value="0375006">
    <annotation>
      <documentation>Infarkt mit ST-Hebung (STEMI)</documentation>
    </annotation>
  </enumeration>
  <enumeration value="0375042">
    <annotation>
      <documentation>unbekannt</documentation>
    </annotation>
  </enumeration>
</restriction>
</simpleType>

```

simpleType enum_0376

namespace	http://xml.ir-d.de/emg		
type	restriction of string		
properties	base xs:string		
used by	element	PostoperationAortenklappeBasis/POA_SchlaganfallSchluessel	
facets	Kind	Value	Annotation
	enumeration	0376001	documentation nein
	enumeration	0376002	documentation ja, ZNS, zerebrovaskuläre Blutung
	enumeration	0376003	documentation ja, ZNS, zerebrovaskuläre Ischämie
	enumeration	0376042	documentation ja, ZNS, andere

annotation	documentation Kat_AK_Schlaganfall
source	<pre> <simpleType name="enum_0376"> <annotation> <documentation>Kat_AK_Schlaganfall</documentation> </annotation> <restriction base="xs:string"> <enumeration value="0376001"> <annotation> <documentation>nein</documentation> </annotation> </enumeration> <enumeration value="0376002"> <annotation> <documentation>ja, ZNS, zerebrovaskuläre Blutung</documentation> </annotation> </enumeration> <enumeration value="0376003"> <annotation> <documentation>ja, ZNS, zerebrovaskuläre Ischämie</documentation> </annotation> </enumeration> <enumeration value="0376042"> <annotation> <documentation>ja, ZNS, andere</documentation> </annotation> </enumeration> </restriction> </simpleType> </pre>

simpleType enum_0377

namespace	http://xml.ir-d.de/emg		
type	restriction of string		
properties	base xs:string		
used by	element	PostoperationAortenklappeBasis/POA_NihssSchluessel	
facets	Kind	Value	Annotation
	enumeration	0377001	documentation ja, mild neurological dysfunction: NIHSS 0-5
	enumeration	0377002	documentation ja, moderate neurological dysfunction: NIHSS 6-14
	enumeration	0377003	documentation ja, severe neurological dysfunction: NIHSS >=15
annotation	documentation Kat_AK_Nihss		
source	<pre> <simpleType name="enum_0377"> <annotation> <documentation>Kat_AK_Nihss</documentation> </annotation> <restriction base="xs:string"> <enumeration value="0377001"> <annotation> <documentation>ja, mild neurological dysfunction: NIHSS 0-5</documentation> </annotation> </enumeration> </pre>		

	<pre> <enumeration value="0377002"> <annotation> <documentation>ja, moderate neurological dysfunction: NIHSS 6-14</documentation> </annotation> </enumeration> <enumeration value="0377003"> <annotation> <documentation> ja, severe neurological dysfunction: NIHSS >=15</documentation> </annotation> </enumeration> </restriction> </simpleType> </pre>
--	---

simpleType enum_0378

namespace	http://xml.lir-d.de/emg		
type	restriction of string		
properties	base xs:string		
used by	element PostoperationAortenklappeBasis/POA MyokardinfarktSchluessel		
facets	Kind	Value	Annotation
	enumeration	0378001	documentation nein
	enumeration	0378002	documentation ja, < 48h gemäss VARC-3-Definition
	enumeration	0378003	documentation ja, >= 48h - <= 72h gemäß VARC-3-Definition
	enumeration	0378004	documentation ja, > 72 h gemäß VARC-3 Definition
annotation	documentation Kat_AK_Myokardinfarkt		
source	<pre> <simpleType name="enum_0378"> <annotation> <documentation>Kat_AK_Myokardinfarkt</documentation> </annotation> <restriction base="xs:string"> <enumeration value="0378001"> <annotation> <documentation>nein</documentation> </annotation> </enumeration> <enumeration value="0378002"> <annotation> <documentation>ja, &lt; 48h gemäss VARC-3-Definition</documentation> </annotation> </enumeration> <enumeration value="0378003"> <annotation> <documentation>ja, &gt;= 48h - &lt;= 72h gemäß VARC-3-Definition</documentation> </annotation> </enumeration> <enumeration value="0378004"> <annotation> <documentation>ja, &gt; 72 h gemäß VARC-3 Definition</documentation> </pre>		

	<pre> </annotation> </enumeration> </restriction> </simpleType> </pre>
--	--

simpleType enum_0379

namespace	http://xml.ir-d.de/emg		
type	restriction of string		
properties	base xs:string		
used by	element	PostoperationAortenklappeBasis/POA ZugangKomplikationenSchluessel	
facets	Kind	Value	Annotation
	enumeration	0379001	documentation Keine gefäss- oder zugangsassoziierte Komplikationen
	enumeration	0379002	documentation Versagen des perkutanen Verschlusssystems
	enumeration	0379003	documentation Geringfügige Gefäßkomplikationen
	enumeration	0379004	documentation Erhebliche Gefäßkomplikationen
annotation	documentation Kat AK ZugangKomplikationen		
source	<pre> <simpleType name="enum_0379"> <annotation> <documentation>Kat_AK_ZugangKomplikationen</documentation> </annotation> <restriction base="xs:string"> <enumeration value="0379001"> <annotation> <documentation>Keine gefäss- oder zugangsassoziierte Komplikationen</documentation> </annotation> </enumeration> <enumeration value="0379002"> <annotation> <documentation>Versagen des perkutanen Verschlusssystems</documentation> </annotation> </enumeration> <enumeration value="0379003"> <annotation> <documentation>Geringfügige Gefäßkomplikationen</documentation> </annotation> </enumeration> <enumeration value="0379004"> <annotation> <documentation>Erhebliche Gefäßkomplikationen</documentation> </annotation> </enumeration> </restriction> </simpleType> </pre>		

simpleType enum_0380

namespace	http://xml.ir-d.de/emg
-----------	------------------------

type	restriction of string															
properties	base xs:string															
used by	element PostoperationAortenklappeBasis/POA ReanimationSchluessel															
facets	<table border="1"> <thead> <tr> <th>Kind</th> <th>Value</th> <th>Annotation</th> </tr> </thead> <tbody> <tr> <td>enumeration</td> <td>0380001</td> <td>documentation nein</td> </tr> <tr> <td>enumeration</td> <td>0380002</td> <td>documentation ja, intraprozedural</td> </tr> <tr> <td>enumeration</td> <td>0380003</td> <td>documentation ja, postprozedural</td> </tr> <tr> <td>enumeration</td> <td>0380004</td> <td>documentation ja, Zeitpunkt nicht bekannt</td> </tr> </tbody> </table>	Kind	Value	Annotation	enumeration	0380001	documentation nein	enumeration	0380002	documentation ja, intraprozedural	enumeration	0380003	documentation ja, postprozedural	enumeration	0380004	documentation ja, Zeitpunkt nicht bekannt
Kind	Value	Annotation														
enumeration	0380001	documentation nein														
enumeration	0380002	documentation ja, intraprozedural														
enumeration	0380003	documentation ja, postprozedural														
enumeration	0380004	documentation ja, Zeitpunkt nicht bekannt														
annotation	documentation Kat_AK_Reanimation															
source	<pre> <simpleType name="enum_0380"> <annotation> <documentation>Kat_AK_Reanimation</documentation> </annotation> <restriction base="xs:string"> <enumeration value="0380001"> <annotation> <documentation>nein</documentation> </annotation> </enumeration> <enumeration value="0380002"> <annotation> <documentation>ja, intraprozedural</documentation> </annotation> </enumeration> <enumeration value="0380003"> <annotation> <documentation>ja, postprozedural</documentation> </annotation> </enumeration> <enumeration value="0380004"> <annotation> <documentation>ja, Zeitpunkt nicht bekannt</documentation> </annotation> </enumeration> </restriction> </simpleType> </pre>															

simpleType enum_0381

namespace	http://xml.ir-d.de/emg												
type	restriction of string												
properties	base xs:string												
used by	element PostoperationAortenklappeBasis/POA MassnahmenSchluessel												
facets	<table border="1"> <thead> <tr> <th>Kind</th> <th>Value</th> <th>Annotation</th> </tr> </thead> <tbody> <tr> <td>enumeration</td> <td>0381001</td> <td>documentation nein</td> </tr> <tr> <td>enumeration</td> <td>0381002</td> <td>documentation Thorakotomie/Rethorakotomie</td> </tr> <tr> <td>enumeration</td> <td>0381003</td> <td>documentation kathetergestützte Reintervention</td> </tr> </tbody> </table>	Kind	Value	Annotation	enumeration	0381001	documentation nein	enumeration	0381002	documentation Thorakotomie/Rethorakotomie	enumeration	0381003	documentation kathetergestützte Reintervention
Kind	Value	Annotation											
enumeration	0381001	documentation nein											
enumeration	0381002	documentation Thorakotomie/Rethorakotomie											
enumeration	0381003	documentation kathetergestützte Reintervention											

	enumeration 0381004 documentation lokale Reinterventionen
	enumeration 0381005 documentation andere Reintervention
annotation	documentation Kat_AK_Massnahmen
source	<pre> <simpleType name="enum_0381"> <annotation> <documentation>Kat_AK_Massnahmen</documentation> </annotation> <restriction base="xs:string"> <enumeration value="0381001"> <annotation> <documentation>nein</documentation> </annotation> </enumeration> <enumeration value="0381002"> <annotation> <documentation>Thorakotomie/Rethorakotomie</documentation> </annotation> </enumeration> <enumeration value="0381003"> <annotation> <documentation>kathetergestützte Reintervention</documentation> </annotation> </enumeration> <enumeration value="0381004"> <annotation> <documentation>lokale Reinterventionen</documentation> </annotation> </enumeration> <enumeration value="0381005"> <annotation> <documentation>andere Reintervention</documentation> </annotation> </enumeration> </restriction> </simpleType> </pre>

simpleType enum_0382

namespace	http://xml.ir-d.de/emg		
type	restriction of string		
properties	base xs:string		
used by	element	PostoperationAortenklappeBasis/POA_GrundMassnahmeSchluessel	
facets	Kind	Value	Annotation
	enumeration	0382001	documentation keine Rethorakotomie / kein weiterer Grund
	enumeration	0382002	documentation Blutung/Hämatom
	enumeration	0382003	documentation Low Cardiac Output
	enumeration	0382004	documentation Tamponade
	enumeration	0382005	documentation Graftprobleme, Ischämie
	enumeration	0382006	documentation

	<p>enumeration 0382007 Wundinfektion, Mediastinitis documentation Dissektion</p> <p>enumeration 0382008 documentation Prothesendysfunktion</p> <p>enumeration 0382009 documentation instabiles Sternum</p> <p>enumeration 0382010 documentation Chylothorax</p> <p>enumeration 0382011 documentation lokale Revision im Bereich des Zugangsweges</p> <p>enumeration 0382042 documentation anderer Grund</p>
annotation	documentation Kat_AK_Komplikation
source	<pre> <simpleType name="enum_0382"> <annotation> <documentation>Kat_AK_Komplikation</documentation> </annotation> <restriction base="xs:string"> <enumeration value="0382001"> <annotation> <documentation>keine Rethorakotomie / kein weiterer Grund</documentation> </annotation> </enumeration> <enumeration value="0382002"> <annotation> <documentation>Blutung/Hämatom</documentation> </annotation> </enumeration> <enumeration value="0382003"> <annotation> <documentation>Low Cardiac Output</documentation> </annotation> </enumeration> <enumeration value="0382004"> <annotation> <documentation>Tamponade</documentation> </annotation> </enumeration> <enumeration value="0382005"> <annotation> <documentation>Graftprobleme, Ischämie</documentation> </annotation> </enumeration> <enumeration value="0382006"> <annotation> <documentation>Wundinfektion, Mediastinitis</documentation> </annotation> </enumeration> <enumeration value="0382007"> <annotation> <documentation>Dissektion</documentation> </annotation> </enumeration> <enumeration value="0382008"> <annotation> <documentation>Prothesendysfunktion</documentation> </annotation> </enumeration> </restriction> </simpleType> </pre>

	<pre> </enumeration> <enumeration value="0382009"> <annotation> <documentation>instabiles Sternum</documentation> </annotation> </enumeration> <enumeration value="0382010"> <annotation> <documentation>Chylothorax</documentation> </annotation> </enumeration> <enumeration value="0382011"> <annotation> <documentation>lokale Revision im Bereich des Zugangsweges</documentation> </annotation> </enumeration> <enumeration value="0382042"> <annotation> <documentation>anderer Grund</documentation> </annotation> </enumeration> </restriction> </simpleType> </pre>
--	---

simpleType enum_0383

namespace	http://xml.ir-d.de/emg		
type	restriction of string		
properties	base xs:string		
used by	element	PostoperationAortenklappeBasis/POA AtemInsuffizienzSchluessel	
facets	Kind	Value	Annotation
	enumeration	0383001	documentation nein
	enumeration	0383002	documentation ja, mit forcierter Atemtherapie
	enumeration	0383003	documentation ja, Reintubation oder längerfristige Beatmung
	enumeration	0383004	documentation ja, Tracheotomie
annotation	documentation Kat_AK_RespiratorischeInsuffizienz		
source	<pre> <simpleType name="enum_0383"> <annotation> <documentation>Kat_AK_RespiratorischeInsuffizienz</documentation> </annotation> <restriction base="xs:string"> <enumeration value="0383001"> <annotation> <documentation>nein</documentation> </annotation> </enumeration> <enumeration value="0383002"> <annotation> <documentation>ja, mit forcierter Atemtherapie</documentation> </annotation> </enumeration> </restriction> </simpleType> </pre>		

	<pre> </enumeration> <enumeration value="0383003"> <annotation> <documentation>ja, Reintubation oder längerfristige Beatmung</documentation> </annotation> </enumeration> <enumeration value="0383004"> <annotation> <documentation>ja, Tracheotomie</documentation> </annotation> </enumeration> </restriction> </simpleType> </pre>
--	---

simpleType enum_0384

namespace	http://xml.lir-d.de/emg		
type	restriction of string		
properties	base xs:string		
used by	element PostoperationAortenklappeBasis/POA BlutungSchluessel		
facets	Kind	Value	Annotation
	enumeration	0384001	documentation keine Blutungskomplikationen
	enumeration	0384002	documentation Geringfügige Blutung (Minor Bleeding - BARC type 2 or 3a)
	enumeration	0384003	documentation Starke Blutung (Major Bleeding - BARC type 3a)
	enumeration	0384004	documentation Lebensbedrohliche Blutung (Life-threatening or disabling bleeding - BARC type 3b or 3c or type 5)
annotation	documentation Kat_AK_Blutungskomplikation		
source	<pre> <simpleType name="enum_0384"> <annotation> <documentation>Kat_AK_Blutungskomplikation</documentation> </annotation> <restriction base="xs:string"> <enumeration value="0384001"> <annotation> <documentation>keine Blutungskomplikationen</documentation> </annotation> </enumeration> <enumeration value="0384002"> <annotation> <documentation>Geringfügige Blutung (Minor Bleeding - BARC type 2 or 3a)</documentation> </annotation> </enumeration> <enumeration value="0384003"> <annotation> <documentation>Starke Blutung (Major Bleeding - BARC type 3a)</documentation> </annotation> </enumeration> <enumeration value="0384004"> </pre>		

	<pre> <annotation> <documentation>Lebensbedrohliche Blutung (Life-threatening or disabling bleeding - BARC type 3b or 3c or type 5)</documentation> </annotation> </enumeration> </restriction> </simpleType> </pre>
--	--

simpleType **enum_0385**

namespace	http://xml.ir-d.de/emg		
type	restriction of string		
properties	base xs:string		
used by	element	PostoperationAortenklappeBasis/POA_HerzrhythmusSchluessel	
facets	Kind	Value	Annotation
	enumeration	0385001	documentation Sinusrhythmus
	enumeration	0385002	documentation Vorhofflimmern
	enumeration	0385003	documentation Patient verstorben (kein Herzrhythmus)
	enumeration	0385042	documentation anderer Rhythmus
annotation	documentation Kat_AK_HerzrhythmusEntlassung		
source	<pre> <simpleType name="enum_0385"> <annotation> <documentation>Kat_AK_HerzrhythmusEntlassung</documentation> </annotation> <restriction base="xs:string"> <enumeration value="0385001"> <annotation> <documentation>Sinusrhythmus</documentation> </annotation> </enumeration> <enumeration value="0385002"> <annotation> <documentation>Vorhofflimmern</documentation> </annotation> </enumeration> <enumeration value="0385003"> <annotation> <documentation>Patient verstorben (kein Herzrhythmus)</documentation> </annotation> </enumeration> <enumeration value="0385042"> <annotation> <documentation>anderer Rhythmus</documentation> </annotation> </enumeration> </restriction> </simpleType> </pre>		

simpleType enum_0388

namespace	http://xml.ir-d.de/emg		
type	restriction of string		
properties	base xs:string		
used by	element PostoperationAortenklappeBasis/POA AggregationshemmerSchlüssel		
facets	Kind	Value	Annotation
	enumeration	0388001	documentation nein
	enumeration	0388002	documentation ASS
	enumeration	0388003	documentation ADP-Rezeptor-Antagonist
	enumeration	0388004	documentation Kombination ASS und ADP-Rezeptor-Antagonist
	enumeration	0388042	documentation ja, andere
	enumeration	0388099	documentation unbekannt
annotation	documentation Kat_AK_Plaettchenaggregationshemmer		
source	<pre> <simpleType name="enum_0388"> <annotation> <documentation>Kat_AK_Plaettchenaggregationshemmer</documentation> </annotation> <restriction base="xs:string"> <enumeration value="0388001"> <annotation> <documentation>nein</documentation> </annotation> </enumeration> <enumeration value="0388002"> <annotation> <documentation>ASS</documentation> </annotation> </enumeration> <enumeration value="0388003"> <annotation> <documentation>ADP-Rezeptor-Antagonist</documentation> </annotation> </enumeration> <enumeration value="0388004"> <annotation> <documentation>Kombination ASS und ADP-Rezeptor-Antagonist</documentation> </annotation> </enumeration> <enumeration value="0388042"> <annotation> <documentation>ja, andere</documentation> </annotation> </enumeration> <enumeration value="0388099"> <annotation> <documentation>unbekannt</documentation> </annotation> </enumeration> </restriction> </pre>		

	<code></simpleType></code>
--	----------------------------------

simpleType enum_0389

namespace	http://xml.ir-d.de/emg																											
type	restriction of string																											
properties	base xs:string																											
used by	element AntikoagulansAortenklappeBasis/AKA_AntikoagulansSchluessel																											
facets	<table><thead><tr><th>Kind</th><th>Value</th><th>Annotation</th></tr></thead><tbody><tr><td>enumeration</td><td>0389001</td><td>documentation nein</td></tr><tr><td>enumeration</td><td>0389002</td><td>documentation Cumarin-Derivate</td></tr><tr><td>enumeration</td><td>0389003</td><td>documentation Heparinoide</td></tr><tr><td>enumeration</td><td>0389004</td><td>documentation orale Thrombinantagonisten</td></tr><tr><td>enumeration</td><td>0389005</td><td>documentation Kombination Heparinoide und Cumarin-Derivate</td></tr><tr><td>enumeration</td><td>0389006</td><td>documentation Direkte orale Antikoagulantien (DOAK / NOAK)</td></tr><tr><td>enumeration</td><td>0389042</td><td>documentation ja, andere</td></tr><tr><td>enumeration</td><td>0389099</td><td>documentation unbekannt</td></tr></tbody></table>	Kind	Value	Annotation	enumeration	0389001	documentation nein	enumeration	0389002	documentation Cumarin-Derivate	enumeration	0389003	documentation Heparinoide	enumeration	0389004	documentation orale Thrombinantagonisten	enumeration	0389005	documentation Kombination Heparinoide und Cumarin-Derivate	enumeration	0389006	documentation Direkte orale Antikoagulantien (DOAK / NOAK)	enumeration	0389042	documentation ja, andere	enumeration	0389099	documentation unbekannt
Kind	Value	Annotation																										
enumeration	0389001	documentation nein																										
enumeration	0389002	documentation Cumarin-Derivate																										
enumeration	0389003	documentation Heparinoide																										
enumeration	0389004	documentation orale Thrombinantagonisten																										
enumeration	0389005	documentation Kombination Heparinoide und Cumarin-Derivate																										
enumeration	0389006	documentation Direkte orale Antikoagulantien (DOAK / NOAK)																										
enumeration	0389042	documentation ja, andere																										
enumeration	0389099	documentation unbekannt																										
annotation	documentation Kat_AK_Antikoagulantien																											
source	<pre><simpleType name="enum_0389"> <annotation> <documentation>Kat_AK_Antikoagulantien</documentation> </annotation> <restriction base="xs:string"> <enumeration value="0389001"> <annotation> <documentation>nein</documentation> </annotation> </enumeration> <enumeration value="0389002"> <annotation> <documentation>Cumarin-Derivate</documentation> </annotation> </enumeration> <enumeration value="0389003"> <annotation> <documentation>Heparinoide</documentation> </annotation> </enumeration> <enumeration value="0389004"> <annotation> <documentation>orale Thrombinantagonisten</documentation> </annotation> </enumeration> <enumeration value="0389005"> <annotation> <documentation>Kombination Heparinoide und Cumarin-Derivate</documentation> </annotation> </enumeration> </restriction> </simpleType></pre>																											

	<pre> </enumeration> <enumeration value="0389006"> <annotation> <documentation>Direkte orale Antikoagulantien (DOAK / NOAK)</documentation> </annotation> </enumeration> <enumeration value="0389042"> <annotation> <documentation>ja, andere</documentation> </annotation> </enumeration> <enumeration value="0389099"> <annotation> <documentation>unbekannt</documentation> </annotation> </enumeration> </restriction> </simpleType> </pre>
--	---

simpleType enum_0390

namespace	http://xml.ir-d.de/emg		
type	restriction of string		
properties	base xs:string		
used by	element ArtikelAortenklappeBasis/AAK ArtikelTypSchluessel		
facets	Kind	Value	Annotation
	enumeration	0390001	documentation biologisches Klappenmodell
	enumeration	0390002	documentation mechanisches Klappenmodell
annotation	documentation Kat_AK_Artikeltyp		
source	<pre> <simpleType name="enum_0390"> <annotation> <documentation>Kat_AK_Artikeltyp</documentation> </annotation> <restriction base="xs:string"> <enumeration value="0390001"> <annotation> <documentation>biologisches Klappenmodell</documentation> </annotation> </enumeration> <enumeration value="0390002"> <annotation> <documentation>mechanisches Klappenmodell</documentation> </annotation> </enumeration> </restriction> </simpleType> </pre>		

simpleType enum_0398

namespace	http://xml.ir-d.de/emg
-----------	------------------------

type	restriction of string												
properties	base xs:string												
used by	element PostoperationAortenklappeBasis/POA TodesursacheSchluessel												
facets	<table border="1"> <thead> <tr> <th>Kind</th> <th>Value</th> <th>Annotation</th> </tr> </thead> <tbody> <tr> <td>enumeration</td> <td>0398001</td> <td>documentation kardiovaskuläre Ursache</td> </tr> <tr> <td>enumeration</td> <td>0398002</td> <td>documentation nicht-kardiovaskuläre Ursache</td> </tr> <tr> <td>enumeration</td> <td>0398099</td> <td>documentation Todesursache unbekannt</td> </tr> </tbody> </table>	Kind	Value	Annotation	enumeration	0398001	documentation kardiovaskuläre Ursache	enumeration	0398002	documentation nicht-kardiovaskuläre Ursache	enumeration	0398099	documentation Todesursache unbekannt
Kind	Value	Annotation											
enumeration	0398001	documentation kardiovaskuläre Ursache											
enumeration	0398002	documentation nicht-kardiovaskuläre Ursache											
enumeration	0398099	documentation Todesursache unbekannt											
annotation	documentation Kat_AK_Todesursache												
source	<pre> <simpleType name="enum_0398"> <annotation> <documentation>Kat_AK_Todesursache</documentation> </annotation> <restriction base="xs:string"> <enumeration value="0398001"> <annotation> <documentation>kardiovaskuläre Ursache</documentation> </annotation> </enumeration> <enumeration value="0398002"> <annotation> <documentation>nicht-kardiovaskuläre Ursache</documentation> </annotation> </enumeration> <enumeration value="0398099"> <annotation> <documentation>Todesursache unbekannt</documentation> </annotation> </enumeration> </restriction> </simpleType> </pre>												

simpleType **enum_0399**

namespace	http://xml.ir-d.de/emg									
type	restriction of string									
properties	base xs:string									
used by	element PostoperationAortenklappeBasis/POA VitalstatusSchluessel									
facets	<table border="1"> <thead> <tr> <th>Kind</th> <th>Value</th> <th>Annotation</th> </tr> </thead> <tbody> <tr> <td>enumeration</td> <td>0399001</td> <td>documentation Patient lebt</td> </tr> <tr> <td>enumeration</td> <td>0399002</td> <td>documentation Patient im Krankenhaus verstorben</td> </tr> </tbody> </table>	Kind	Value	Annotation	enumeration	0399001	documentation Patient lebt	enumeration	0399002	documentation Patient im Krankenhaus verstorben
Kind	Value	Annotation								
enumeration	0399001	documentation Patient lebt								
enumeration	0399002	documentation Patient im Krankenhaus verstorben								
annotation	documentation Kat_AK_Vitalstatus									
source	<pre> <simpleType name="enum_0399"> <annotation> <documentation>Kat_AK_Vitalstatus</documentation> </annotation> <restriction base="xs:string"> <enumeration value="0399001"> <annotation> </pre>									

	<pre> <documentation>Patient lebt</documentation> </annotation> </enumeration> <enumeration value="0399002"> <annotation> <documentation>Patient im Krankenhaus verstorben</documentation> </annotation> </enumeration> </restriction> </simpleType> </pre>
--	---

complexType **PatientenaufnahmeBasis**

diagram	
namespace	http://xml.ir-d.de/emg
children	PAT_Alter PAT_Groesse PAT_Gewicht PAT_GeschlechtSchluessel
used by	complexType Patientenaufnahme
source	<pre> <complexType name="PatientenaufnahmeBasis"> <sequence> <element name="PAT_Alter" type="xs:integer"/> <element name="PAT_Groesse" type="xs:integer" minOccurs="0"/> <element name="PAT_Gewicht" type="xs:integer" minOccurs="0"/> <element name="PAT_GeschlechtSchluessel" type="enum_0070"/> </sequence> </complexType> </pre>

element **PatientenaufnahmeBasis/PAT_Alter**

diagram	
type	integer
properties	content simple
source	<pre><element name="PAT_Alter" type="xs:integer"/></pre>

element **PatientenaufnahmeBasis/PAT_Groesse**

diagram	
type	integer
properties	minOcc 0 maxOcc 1 content simple
source	<code><element name="PAT_Groesse" type="xs:integer" minOccurs="0"/></code>

element **PatientenaufnahmeBasis/PAT_Gewicht**

diagram	
type	integer
properties	minOcc 0 maxOcc 1 content simple
source	<code><element name="PAT_Gewicht" type="xs:integer" minOccurs="0"/></code>

element **PatientenaufnahmeBasis/PAT_GeschlechtSchluessel**

diagram																
type	enum 0070															
properties	content simple															
facets	<table border="1"> <thead> <tr> <th>Kind</th> <th>Value</th> <th>Annotation</th> </tr> </thead> <tbody> <tr> <td>enumeration</td> <td>0070001</td> <td>documentation weiblich</td> </tr> <tr> <td>enumeration</td> <td>0070002</td> <td>documentation männlich</td> </tr> <tr> <td>enumeration</td> <td>0070003</td> <td>documentation divers</td> </tr> <tr> <td>enumeration</td> <td>0070042</td> <td>documentation unbestimmt</td> </tr> </tbody> </table>	Kind	Value	Annotation	enumeration	0070001	documentation weiblich	enumeration	0070002	documentation männlich	enumeration	0070003	documentation divers	enumeration	0070042	documentation unbestimmt
Kind	Value	Annotation														
enumeration	0070001	documentation weiblich														
enumeration	0070002	documentation männlich														
enumeration	0070003	documentation divers														
enumeration	0070042	documentation unbestimmt														
source	<code><element name="PAT_GeschlechtSchluessel" type="enum_0070"/></code>															

complexType **PatientenaufnahmeBrustimplantatBasis**

diagram	
namespace	http://xml.ir-d.de/emg
children	PAB AutoimmunerkrankungSchluessel PAB VerlaufAutoimmunerkrankungSchluessel

used by	element Patientenaufnahme/patientenaufnahmeBrustimplantat
source	<pre><complexType name="PatientenaufnahmeBrustimplantatBasis"> <sequence> <element name="PAB_AutoimmunerkrankungSchluessel" type="enum_0122"/> <element name="PAB_VerlaufAutoimmunerkrankungSchluessel" type="enum_0123" minOccurs="0"/> </sequence> </complexType></pre>

element [PatientenaufnahmeBrustimplantatBasis/PAB_AutoimmunerkrankungSchluessel](#)

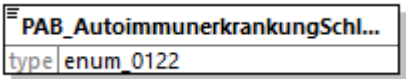
diagram													
type	enum 0122												
properties	content simple												
facets	<table border="1"> <thead> <tr> <th>Kind</th> <th>Value</th> <th>Annotation</th> </tr> </thead> <tbody> <tr> <td>enumeration</td> <td>0122001</td> <td>documentation ja, ärztlich nachgewiesen</td> </tr> <tr> <td>enumeration</td> <td>0122002</td> <td>documentation nein</td> </tr> <tr> <td>enumeration</td> <td>0122042</td> <td>documentation unbekannt</td> </tr> </tbody> </table>	Kind	Value	Annotation	enumeration	0122001	documentation ja, ärztlich nachgewiesen	enumeration	0122002	documentation nein	enumeration	0122042	documentation unbekannt
Kind	Value	Annotation											
enumeration	0122001	documentation ja, ärztlich nachgewiesen											
enumeration	0122002	documentation nein											
enumeration	0122042	documentation unbekannt											
source	<pre><element name="PAB_AutoimmunerkrankungSchluessel" type="enum_0122"/></pre>												

element [PatientenaufnahmeBrustimplantatBasis/PAB_VerlaufAutoimmunerkrankungSchluessel](#)

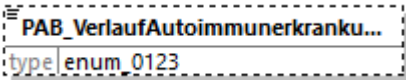
diagram																			
type	enum 0123																		
properties	minOcc 0 maxOcc 1 content simple																		
facets	<table border="1"> <thead> <tr> <th>Kind</th> <th>Value</th> <th>Annotation</th> </tr> </thead> <tbody> <tr> <td>enumeration</td> <td>0123001</td> <td>documentation neu aufgetreten</td> </tr> <tr> <td>enumeration</td> <td>0123002</td> <td>documentation verschlechtert</td> </tr> <tr> <td>enumeration</td> <td>0123003</td> <td>documentation keine Veränderung</td> </tr> <tr> <td>enumeration</td> <td>0123004</td> <td>documentation nicht relevant, da Primäreingriff</td> </tr> <tr> <td>enumeration</td> <td>0123042</td> <td>documentation unbekannt</td> </tr> </tbody> </table>	Kind	Value	Annotation	enumeration	0123001	documentation neu aufgetreten	enumeration	0123002	documentation verschlechtert	enumeration	0123003	documentation keine Veränderung	enumeration	0123004	documentation nicht relevant, da Primäreingriff	enumeration	0123042	documentation unbekannt
Kind	Value	Annotation																	
enumeration	0123001	documentation neu aufgetreten																	
enumeration	0123002	documentation verschlechtert																	
enumeration	0123003	documentation keine Veränderung																	
enumeration	0123004	documentation nicht relevant, da Primäreingriff																	
enumeration	0123042	documentation unbekannt																	
source	<pre><element name="PAB_VerlaufAutoimmunerkrankungSchluessel" type="enum_0123" minOccurs="0"/></pre>																		

complexType **PatientenaufnahmeKardiologie**

<p>diagram</p>	
<p>namespace</p>	<p>http://xml.ir-d.de/emg</p>
<p>type</p>	<p>extension of PatientenaufnahmeKardiologieBasis</p>
<p>properties</p>	<p>base PatientenaufnahmeKardiologieBasis</p>
<p>children</p>	<p>PKA_NyhaSchluessel PKA_Lvef PKA_LvefUnbekannt PKA_DiabetesSchluessel PKA_NierenersatzSchluessel PKA_KreatininwertMgdl PKA_KreatininwertMikromol PKA_KreatininwertUnbekannt patientenaufnahmeAortenklappe</p>
<p>used by</p>	<p>element Patientenaufnahme/patientenaufnahmeKardiologie</p>
<p>source</p>	<pre><complexType name="PatientenaufnahmeKardiologie"> <complexContent> <extension base="PatientenaufnahmeKardiologieBasis"> <sequence> <element name="patientenaufnahmeAortenklappe" type="PatientenaufnahmeAortenkla..."/> </sequence> </extension> </complexContent> </complexType></pre>

element **PatientenaufnahmeKardiologie/patientenaufnahmeAortenklappe**

diagram

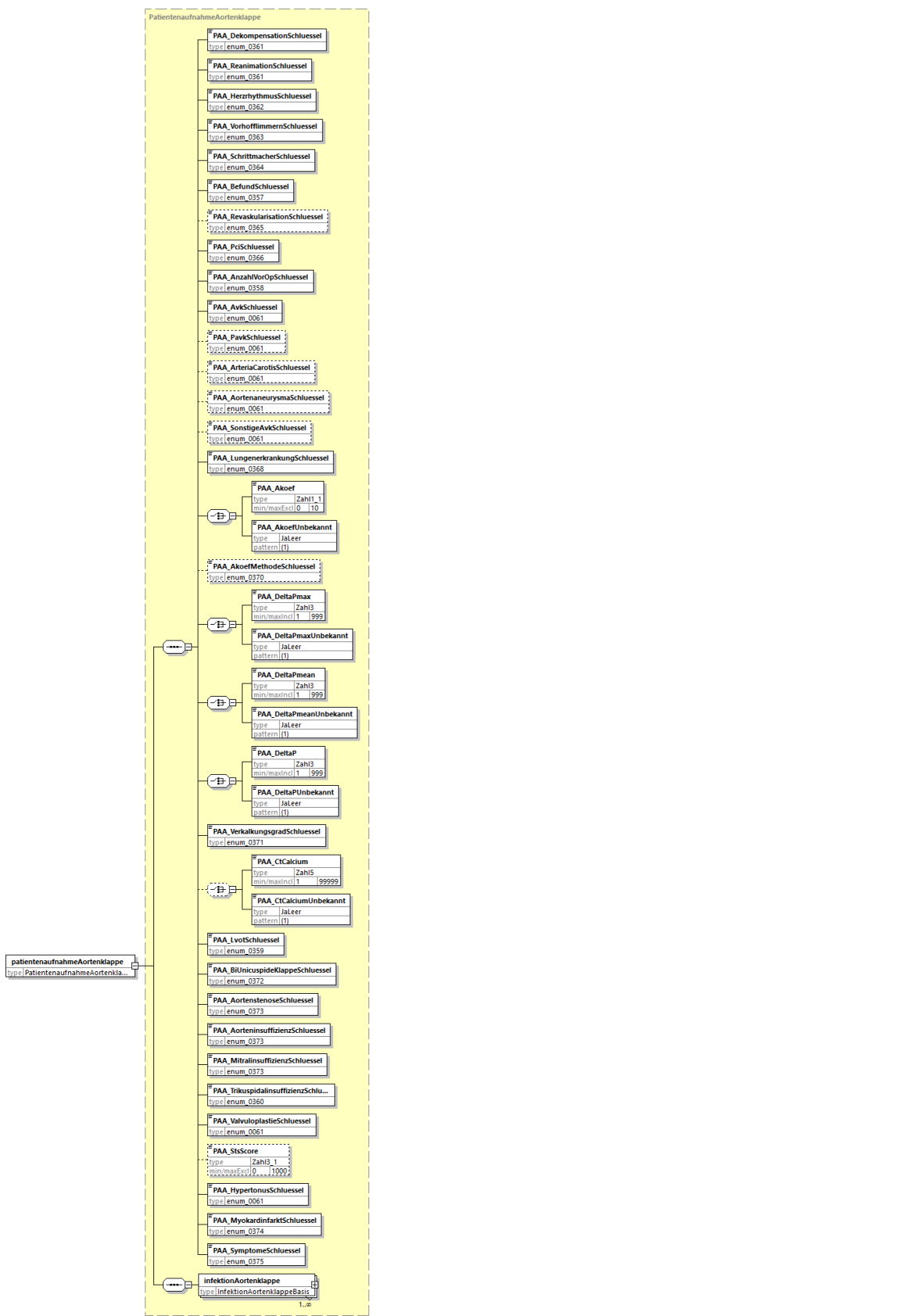

type [PatientenaufnahmeAortenklappe](#)

properties content complex

children	PAA DekompensationSchluessel PAA ReanimationSchluessel PAA HerzrhythmusSchluessel PAA VorhofflimmernSchluessel PAA SchrittmacherSchluessel PAA BefundSchluessel PAA RevaskularisationSchluessel PAA PciSchluessel PAA AnzahlVorOpSchluessel PAA AvkSchluessel PAA PavkSchluessel PAA ArteriaCarotisSchluessel PAA AortenaneurysmaSchluessel PAA SonstigeAvkSchluessel PAA LungenerkrankungSchluessel PAA Akoef PAA AkoefUnbekannt PAA AkoefMethodeSchluessel PAA DeltaPmax PAA DeltaPmaxUnbekannt PAA DeltaPmean PAA DeltaPmeanUnbekannt PAA DeltaP PAA DeltaPUnbekannt PAA VerkalkungsgradSchluessel PAA CtCalcium PAA CtCalciumUnbekannt PAA LvotSchluessel PAA BiUnicuspideKlappeSchluessel PAA AortenstenoseSchluessel PAA AorteninsuffizienzSchluessel PAA MitralinsuffizienzSchluessel PAA TrikuspidalinsuffizienzSchluessel PAA ValvuloplastieSchluessel PAA StsScore PAA HypertonusSchluessel PAA MyokardinfarktSchluessel PAA SymptomeSchluessel infektionAortenklappe
source	<pre><element name="patientenaufnahmeAortenklappe" type="PatientenaufnahmeAortenklappe"/></pre>

complexType **OperationBasis**

diagram	
namespace	http://xml.ir-d.de/emg
children	OPE LaufendeNumer OPE Datum OPE SeitenLokalisationSchluessel OPE AsaSchluessel OPE ImplantattypSchluessel
used by	complexType Operation
source	<pre><complexType name="OperationBasis"> <sequence> <element name="OPE_LaufendeNumer" type="Zahl3"/> <element name="OPE_Datum" type="xs:date"/> <element name="OPE_SeitenLokalisationSchluessel" type="enum_0050" minOccurs="0"/> <element name="OPE_AsaSchluessel" type="enum_0044"/> <element name="OPE_ImplantattypSchluessel" type="enum_0080"/> </sequence> </complexType></pre>

element **OperationBasis/OPE_LaufendeNumer**

diagram	
---------	--

type	Zahl3									
properties	content simple									
facets	<table border="1"> <thead> <tr> <th>Kind</th> <th>Value</th> <th>Annotation</th> </tr> </thead> <tbody> <tr> <td>minInclusive</td> <td>1</td> <td></td> </tr> <tr> <td>maxInclusive</td> <td>999</td> <td></td> </tr> </tbody> </table>	Kind	Value	Annotation	minInclusive	1		maxInclusive	999	
Kind	Value	Annotation								
minInclusive	1									
maxInclusive	999									
source	<code><element name="OPE_LaufendeNummer" type="Zahl3"/></code>									

element **OperationBasis/OPE_Datum**

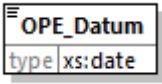
diagram	
type	date
properties	content simple
source	<code><element name="OPE_Datum" type="xs:date"/></code>

element **OperationBasis/OPE_SeitenLokalisationSchluessel**

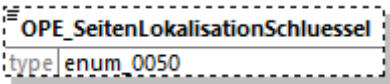
diagram										
type	enum_0050									
properties	<table border="1"> <tbody> <tr> <td>minOcc</td> <td>0</td> </tr> <tr> <td>maxOcc</td> <td>1</td> </tr> <tr> <td>content</td> <td>simple</td> </tr> </tbody> </table>	minOcc	0	maxOcc	1	content	simple			
minOcc	0									
maxOcc	1									
content	simple									
facets	<table border="1"> <thead> <tr> <th>Kind</th> <th>Value</th> <th>Annotation</th> </tr> </thead> <tbody> <tr> <td>enumeration</td> <td>0050001</td> <td>documentation rechts</td> </tr> <tr> <td>enumeration</td> <td>0050002</td> <td>documentation links</td> </tr> </tbody> </table>	Kind	Value	Annotation	enumeration	0050001	documentation rechts	enumeration	0050002	documentation links
Kind	Value	Annotation								
enumeration	0050001	documentation rechts								
enumeration	0050002	documentation links								
source	<code><element name="OPE_SeitenLokalisationSchluessel" type="enum_0050" minOccurs="0"/></code>									

element **OperationBasis/OPE_AsaSchluessel**

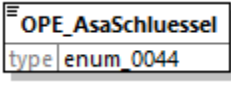
diagram																
type	enum_0044															
properties	content simple															
facets	<table border="1"> <thead> <tr> <th>Kind</th> <th>Value</th> <th>Annotation</th> </tr> </thead> <tbody> <tr> <td>enumeration</td> <td>0044001</td> <td>documentation 1= normaler, sonst gesunder Patient</td> </tr> <tr> <td>enumeration</td> <td>0044002</td> <td>documentation 2= Patient mit leichter Allgemeinerkrankung</td> </tr> <tr> <td>enumeration</td> <td>0044003</td> <td>documentation 3= Patient mit schwerer Allgemeinerkrankung</td> </tr> <tr> <td>enumeration</td> <td>0044004</td> <td>documentation 4= Patient mit schwerer Allgemeinerkrankung, die eine ständige Lebensbedrohung darstellt</td> </tr> </tbody> </table>	Kind	Value	Annotation	enumeration	0044001	documentation 1= normaler, sonst gesunder Patient	enumeration	0044002	documentation 2= Patient mit leichter Allgemeinerkrankung	enumeration	0044003	documentation 3= Patient mit schwerer Allgemeinerkrankung	enumeration	0044004	documentation 4= Patient mit schwerer Allgemeinerkrankung, die eine ständige Lebensbedrohung darstellt
Kind	Value	Annotation														
enumeration	0044001	documentation 1= normaler, sonst gesunder Patient														
enumeration	0044002	documentation 2= Patient mit leichter Allgemeinerkrankung														
enumeration	0044003	documentation 3= Patient mit schwerer Allgemeinerkrankung														
enumeration	0044004	documentation 4= Patient mit schwerer Allgemeinerkrankung, die eine ständige Lebensbedrohung darstellt														

	enumeration 0044005 documentation 5= moribunder Patient, der ohne die Operation voraussichtlich nicht überleben wird
source	<element name="OPE_AsaSchluessel" type="enum_0044"/>

element **OperationBasis/OPE_ImplantattypSchluessel**

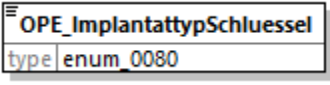
diagram			
type	enum_0080		
properties	content simple		
facets	Kind	Value	Annotation
	enumeration	0080001	documentation Endoprothese Hüfte/Knie
	enumeration	0080002	documentation Brustimplantat
	enumeration	0080003	documentation Aortenklappenprothese
source	<element name="OPE_ImplantattypSchluessel" type="enum_0080"/>		

complexType **OperationBrustimplantat**

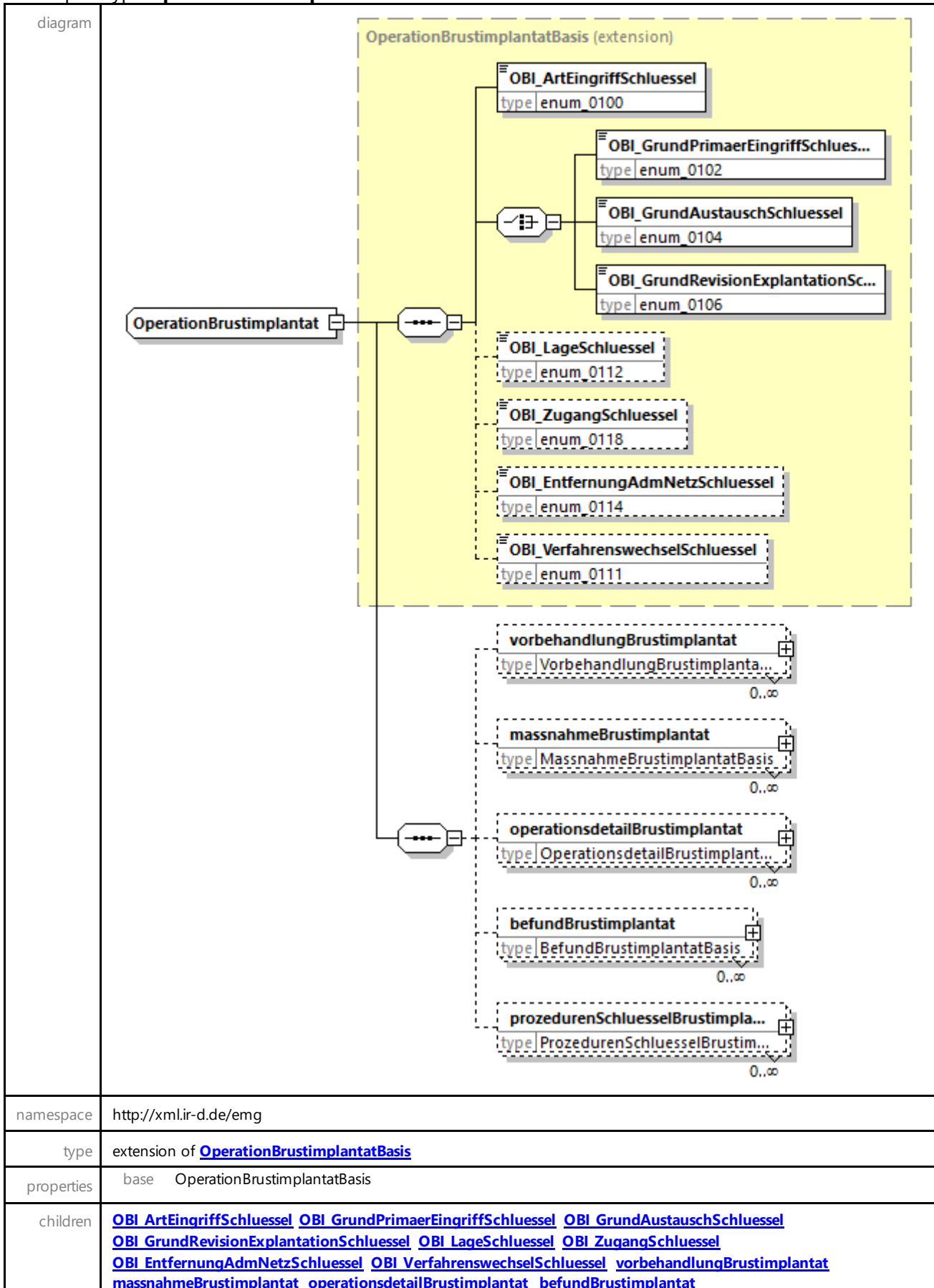

	prozedurenSchluesselBrustimplantat
used by	element Operation/operationBrustimplantat
source	<pre> <complexType name="OperationBrustimplantat"> <complexContent> <extension base="OperationBrustimplantatBasis"> <sequence> <element name="vorbehandlungBrustimplantat" type="VorbehandlungBrustimplantatBasis" minOccurs="0" maxOccurs="unbounded"/> <element name="massnahmeBrustimplantat" type="MassnahmeBrustimplantatBasis" minOccurs="0" maxOccurs="unbounded"/> <element name="operationsdetailBrustimplantat" type="OperationsdetailBrustimplantatBasis" minOccurs="0" maxOccurs="unbounded"/> <element name="befundBrustimplantat" type="BefundBrustimplantatBasis" minOccurs="0" maxOccurs="unbounded"/> <element name="prozedurenSchluesselBrustimplantat" type="ProzedurenSchluesselBrustimplantatBasis" minOccurs="0" maxOccurs="unbounded"/> </sequence> </extension> </complexContent> </complexType> </pre>

element **OperationBrustimplantat/vorbehandlungBrustimplantat**

diagram	
type	VorbehandlungBrustimplantatBasis
properties	minOcc 0 maxOcc unbounded content complex
children	VBI BehandlungLokalSchluessel VBI BehandlungSystemischSchluessel
source	<pre> <element name="vorbehandlungBrustimplantat" type="VorbehandlungBrustimplantatBasis" minOccurs="0" maxOccurs="unbounded"/> </pre>

element **OperationBrustimplantat/massnahmeBrustimplantat**

diagram	
type	MassnahmeBrustimplantatBasis
properties	minOcc 0 maxOcc unbounded

	content complex
children	MAB MassnahmeSchluessel
source	<code><element name="massnahmeBrustimplantat" type="MassnahmeBrustimplantatBasis" minOccurs="0" maxOccurs="unbounded"/></code>

element **OperationBrustimplantat/operationsdetailBrustimplantat**

diagram	
type	OperationsdetailBrustimplantatBasis
properties	minOcc 0 maxOcc unbounded content complex
children	ODB_OperationsdetailPrimaerEingriffSchluessel ODB_OperationsdetailAustauschSchluessel ODB_OperationsdetailRevisionSchluessel
source	<code><element name="operationsdetailBrustimplantat" type="OperationsdetailBrustimplantatBasis" minOccurs="0" maxOccurs="unbounded"/></code>

element **OperationBrustimplantat/befundBrustimplantat**

diagram	
type	BefundBrustimplantatBasis
properties	minOcc 0 maxOcc unbounded content complex
children	BEB_BefundSchluessel BEB_BefundAustauschSchluessel
source	<code><element name="befundBrustimplantat" type="BefundBrustimplantatBasis" minOccurs="0" maxOccurs="unbounded"/></code>

element **OperationBrustimplantat/prozedurenSchluesselBrustimplantat**

diagram	
type	ProzedurenSchluesselBrustimplantatBasis
properties	minOcc 0 maxOcc unbounded content complex
children	PBI_ProzedurenSchluessel
source	<pre><element name="prozedurenSchluesselBrustimplantat" type="ProzedurenSchluesselBrustimplantatBasis" minOccurs="0" maxOccurs="unbounded"/></pre>

complexType **OperationEndoprothese**

diagram

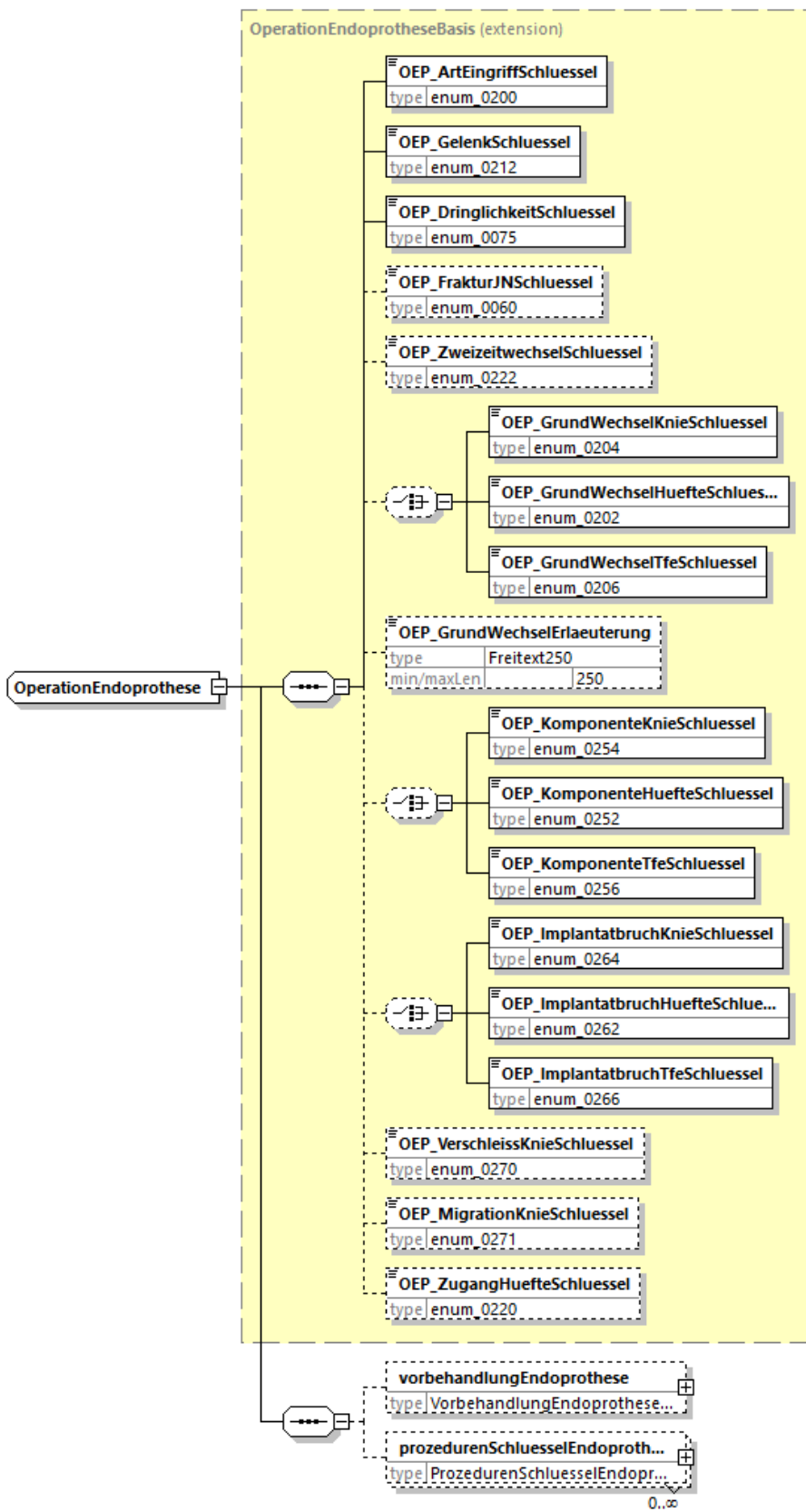

namespace http://xml.ir-d.de/emg

type extension of [OperationEndoprotheseBasis](#)

properties	base OperationEndoprotheseBasis
children	OEP ArtEingriffSchluessel OEP GelenkSchluessel OEP DringlichkeitSchluessel OEP FrakturJNSchluessel OEP ZweizeitwechselSchluessel OEP GrundWechselKnieSchluessel OEP GrundWechselHuefteSchluessel OEP GrundWechselTfeSchluessel OEP GrundWechselErlaeuterung OEP KomponenteKnieSchluessel OEP KomponenteHuefteSchluessel OEP KomponenteTfeSchluessel OEP ImplantatbruchKnieSchluessel OEP ImplantatbruchHuefteSchluessel OEP ImplantatbruchTfeSchluessel OEP VerschleissKnieSchluessel OEP MigrationKnieSchluessel OEP ZugangHuefteSchluessel vorbehandlungEndoprothese prozedurenSchluesselEndoprothese
used by	element Operation/operationEndoprothese
source	<pre><complexType name="OperationEndoprothese"> <complexContent> <extension base="OperationEndoprotheseBasis"> <sequence> <element name="vorbehandlungEndoprothese" type="VorbehandlungEndoprotheseBasis" minOccurs="0"/> <element name="prozedurenSchluesselEndoprothese" type="ProzedurenSchluesselEndoprotheseBasis" minOccurs="0" maxOccurs="unbounded"/> </sequence> </extension> </complexContent> </complexType></pre>

element **OperationEndoprothese/vorbehandlungEndoprothese**

diagram	
type	VorbehandlungEndoprotheseBasis
properties	minOcc 0 maxOcc 1 content complex
children	VEP_VorOpKnieSchluessel VEP_VorOpHuefteSchluessel VEP_VorOpErlaeuterung
source	<pre><element name="vorbehandlungEndoprothese" type="VorbehandlungEndoprotheseBasis" minOccurs="0"/></pre>

element **OperationEndoprothese/prozedurenSchluesselEndoprothese**

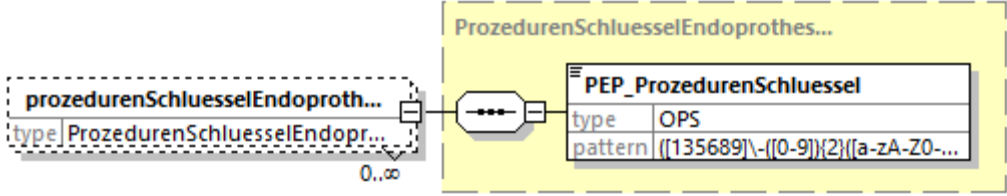
<p>diagram</p>	
<p>type</p>	<p>ProzedurenSchluesselEndoprotheseBasis</p>
<p>properties</p>	<p>minOcc 0 maxOcc unbounded content complex</p>
<p>children</p>	<p>PEP_ProzedurenSchluessel</p>
<p>source</p>	<pre><element name="prozedurenSchluesselEndoprothese" type="ProzedurenSchluesselEndoprotheseBasis" minOccurs="0" maxOccurs="unbounded"/></pre>

properties	base OperationAortenklappeBasis
children	OAK NummerEingriff OAK ArtEingriffSchluessel OAK GrundEingriffSchluessel OAK DringlichkeitSchluessel OAK ExplantationSchluessel OAK IsoliertSchluessel OAK ZugangKonventionellSchluessel OAK ZugangKatheterSchluessel OAK KomplikationenSchluessel OAK TherapieLcoSchluessel OAK Durchleuchtungszeit OAK BeatmungSchluessel OAK TroponinSchluessel OAK InotropeSchluessel OAK Eingriffsdauer OAK EingriffsumfangSchluessel OAK ProzedurenAnzahl OAK VorgehenSchluessel OAK Bypasszeit OAK BypasszeitUnbekannt OAK Abklemmzeit OAK AbklemmzeitUnbekannt OAK AortaThorakalSchluessel OAK NeuroprotektionSchluessel OAK KreislaufunterstuetzungSchluessel OAK PraeOpUnterstuetzungSchluessel OAK PraeOpMethodeSchluessel OAK IntraOpUnterstuetzungSchluessel OAK IntraOpMethodeSchluessel OAK AortenklappenOpAnzahl OAK ValvelnValveSchluessel OAK ZugangsGefaessdiameter OAK ZugangsGefaessUnbekannt OAK ZugangVerkalkungSchluessel OAK Aortenklappenannulus OAK MessmethodeSchluessel OAK DistanzRca OAK DistanzRcaUnbekannt OAK DistanzLca OAK DistanzLcaUnbekannt OAK PtcaVorSchluessel OAK PtcaVorDurchmesser OAK PtcaVorDurchmesserUnbekannt OAK PtcaVorAnzahl OAK RapidPacingVorSchluessel OAK RapidPacingIntraSchluessel OAK PtcaNachSchluessel OAK PtcaNachDurchmesser OAK PtcaNachDurchmesserUnbekannt OAK PtcaNachAnzahl OAK RapidPacingNachSchluessel OAK KonversionSchluessel OAK SuccessSchluessel OAK AnaesthesieSchluessel OAK DeltaPmeanNachOp OAK DeltaPmeanNachOpUnbekannt OAK ResidualeInsuffizienzSchluessel OAK ZugangVerschlussSchluessel OAK ZusätzlichePciSchluessel OAK PciWegenKhkSchluessel OAK PciWegenKomplikationSchluessel OAK LaesionenAnzahl komplikationAortenklappe taviAortenklappe pciAortenklappe failureGrundAortenklappe prozedurenSchluesselAortenklappe
used by	element Operation/operationAortenklappe
source	<pre> <complexType name="OperationAortenklappe"> <complexContent> <extension base="OperationAortenklappeBasis"> <sequence> <element name="komplikationAortenklappe" type="KomplikationAortenklappeBasis" minOccurs="0" maxOccurs="unbounded"/> <element name="taviAortenklappe" type="TaviAortenklappeBasis" minOccurs="0" maxOccurs="unbounded"/> <element name="pciAortenklappe" type="PciAortenklappeBasis" minOccurs="0" maxOccurs="unbounded"/> <element name="failureGrundAortenklappe" type="FailureGrundAortenklappeBasis" minOccurs="0" maxOccurs="unbounded"/> <element name="prozedurenSchluesselAortenklappe" type="ProzedurenSchluesselAortenklappeBasis" minOccurs="0" maxOccurs="unbounded"/> </sequence> </extension> </complexContent> </complexType> </pre>

element **OperationAortenklappe/komplikationAortenklappe**

diagram	
type	KomplikationAortenklappeBasis
properties	minOcc 0 maxOcc unbounded content complex
children	KAK KomplikationTypSchluessel

source	<code><element name="komplikationAortenklappe" type="KomplikationAortenklappeBasis" minOccurs="0" maxOccurs="unbounded"/></code>
--------	--

element **OperationAortenklappe/taviAortenklappe**

diagram	
type	TaviAortenklappeBasis
properties	minOcc 0 maxOcc unbounded content complex
children	TAK GrundTaviSchlüssel
source	<code><element name="taviAortenklappe" type="TaviAortenklappeBasis" minOccurs="0" maxOccurs="unbounded"/></code>

element **OperationAortenklappe/pciAortenklappe**

diagram	
type	PciAortenklappeBasis
properties	minOcc 0 maxOcc unbounded content complex
children	PCA PciArterienSchlüssel
source	<code><element name="pciAortenklappe" type="PciAortenklappeBasis" minOccurs="0" maxOccurs="unbounded"/></code>

element **OperationAortenklappe/failureGrundAortenklappe**

diagram	
type	FailureGrundAortenklappeBasis
properties	minOcc 0 maxOcc unbounded content complex
children	FAK FailureGrundSchlüssel
source	<code><element name="failureGrundAortenklappe" type="FailureGrundAortenklappeBasis" minOccurs="0" maxOccurs="unbounded"/></code>

`minOccurs="0" maxOccurs="unbounded"/>`

element **OperationAortenklappe/prozedurenSchluesselAortenklappe**

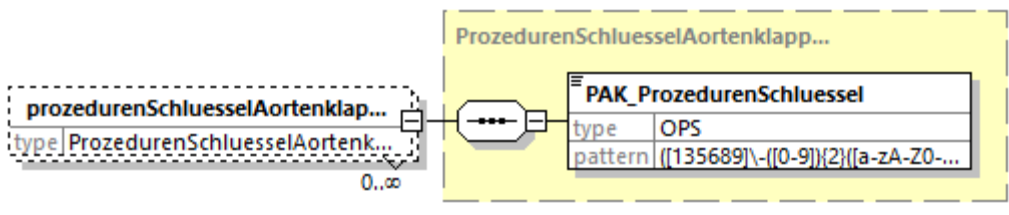
diagram	
type	ProzedurenSchluesselAortenklappeBasis
properties	minOcc 0 maxOcc unbounded content complex
children	PAK ProzedurenSchluessel
source	<code><element name="prozedurenSchluesselAortenklappe" type="ProzedurenSchluesselAortenklappeBasis" minOccurs="0" maxOccurs="unbounded"/></code>

complexType Artikelidentifikation

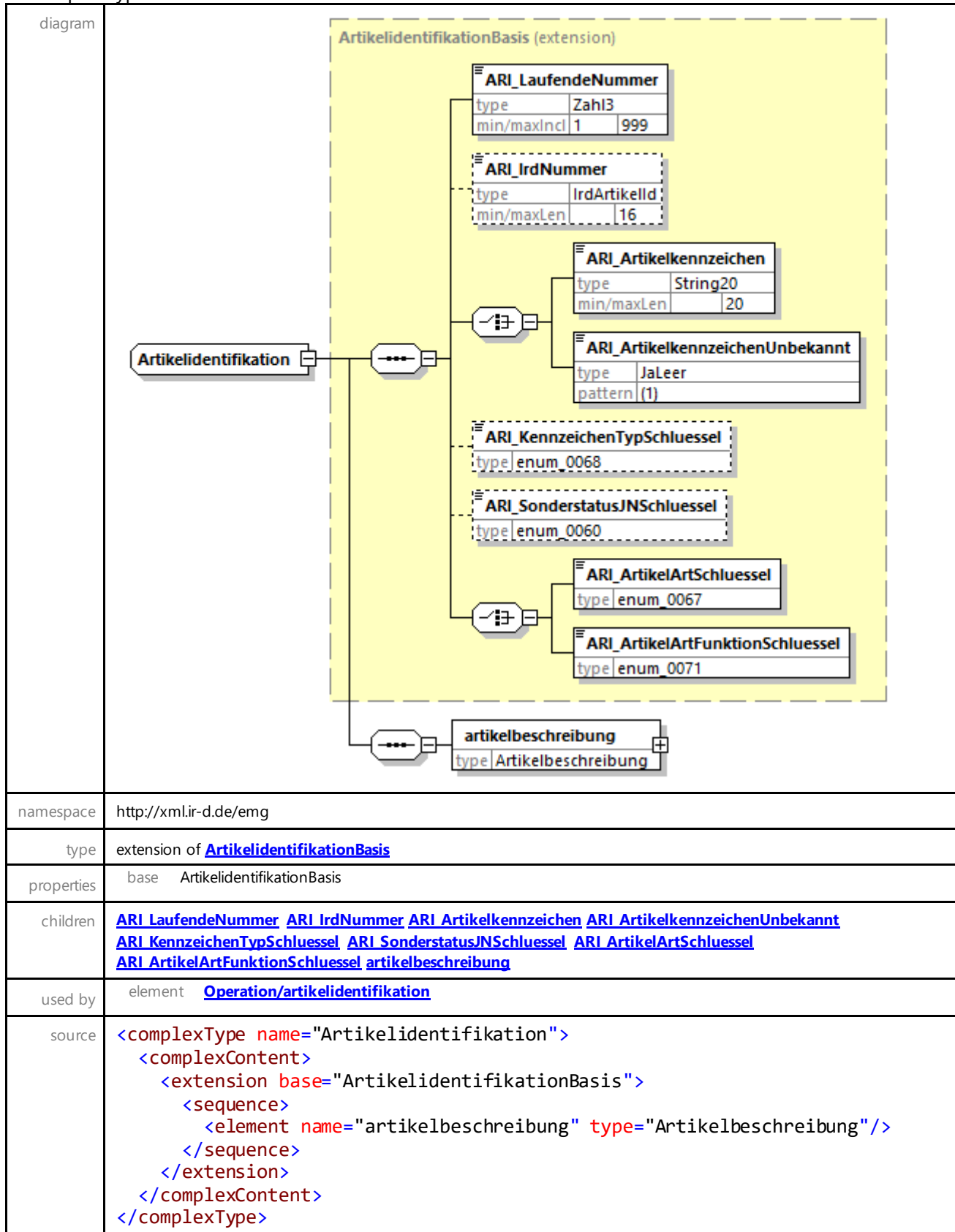

element **Artikelidentifikation/artikelbeschreibung**

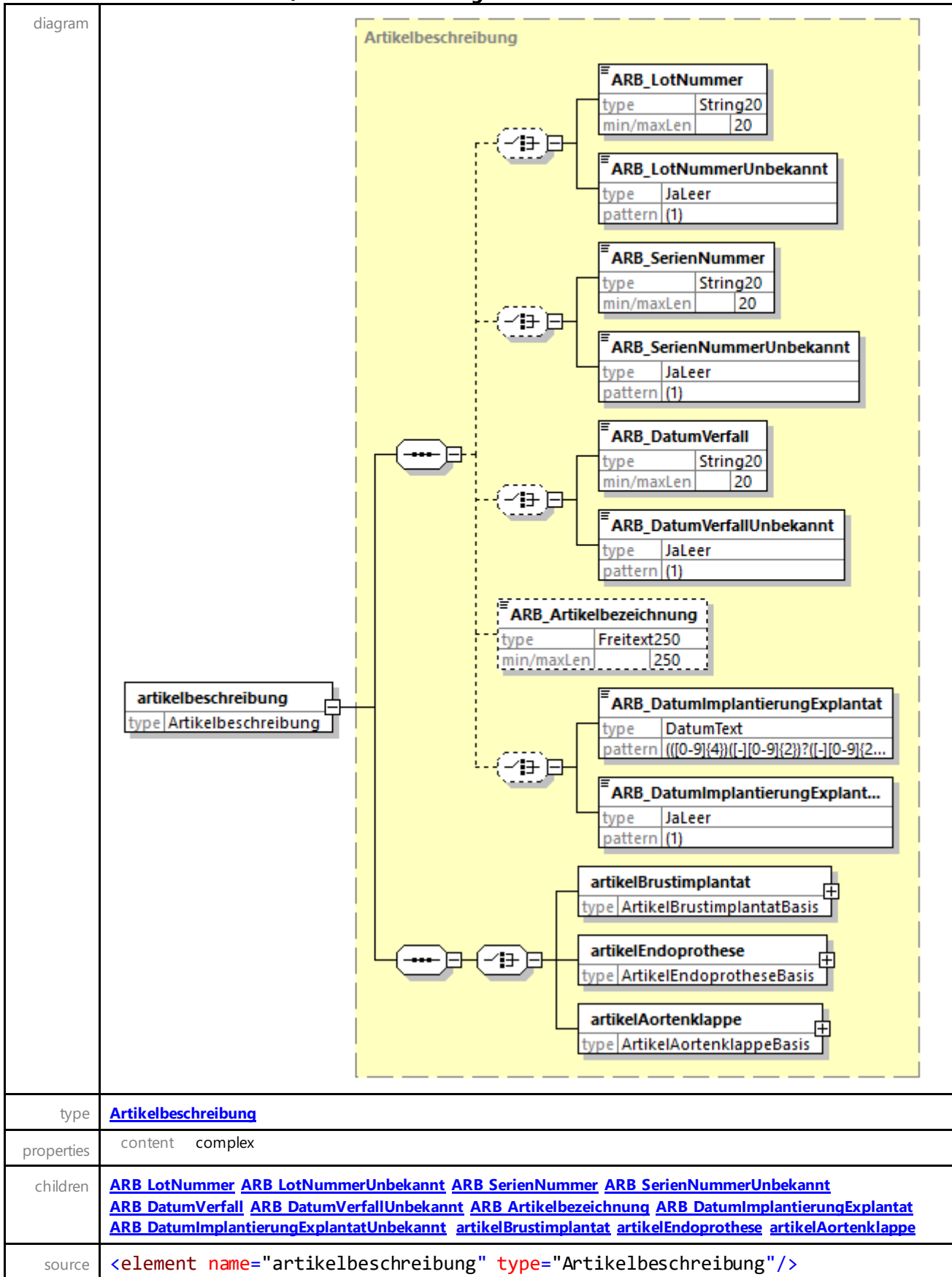

complexType **Zubehoer**

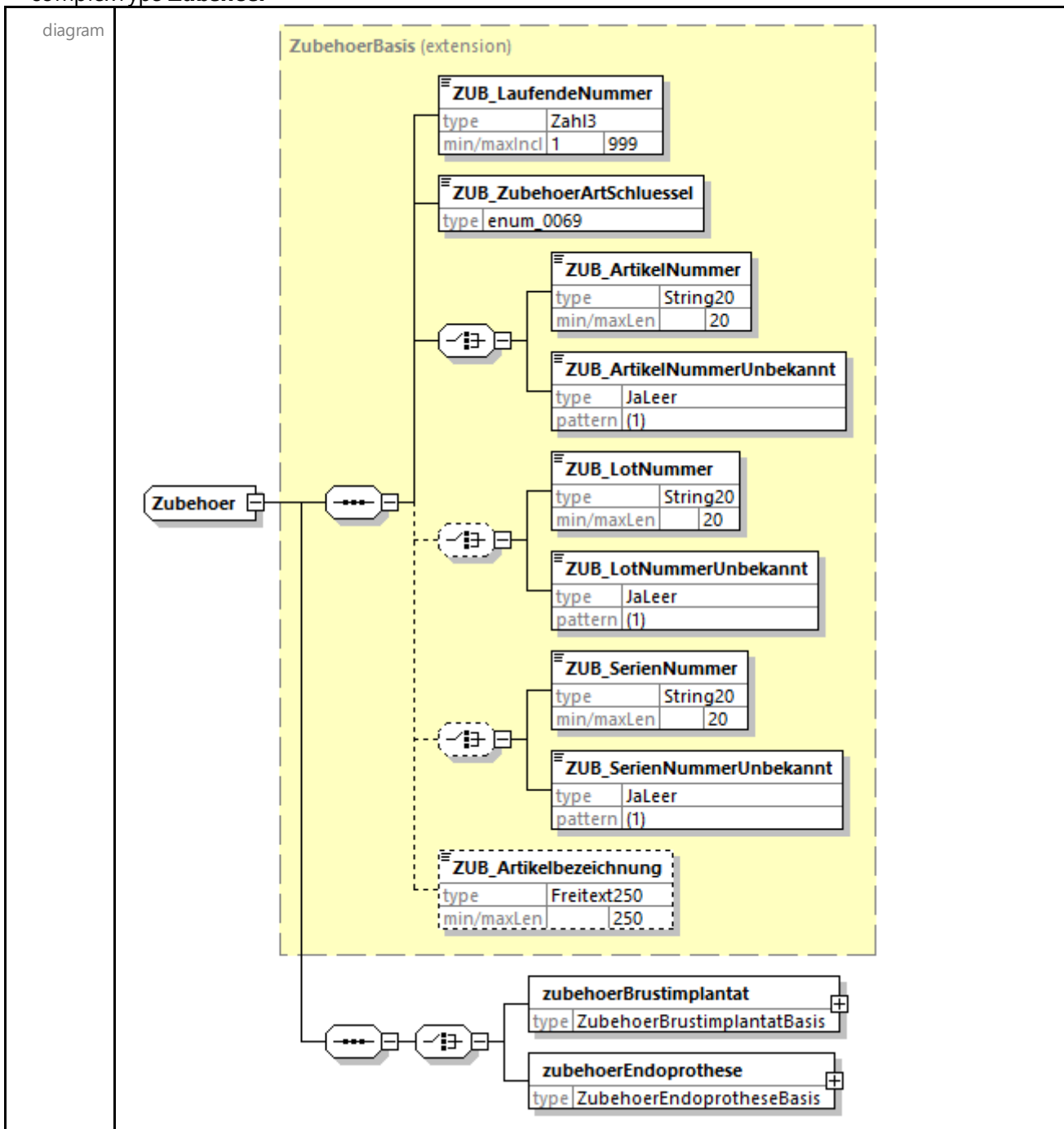

namespace	http://xml.ir-d.de/emg
type	extension of ZubehoerBasis
properties	base ZubehoerBasis
children	ZUB LaufendeNummer ZUB ZubehoerArtSchluessel ZUB ArtikelNummer ZUB ArtikelNummerUnbekannt ZUB LotNummer ZUB LotNummerUnbekannt ZUB SerienNummer ZUB SerienNummerUnbekannt ZUB Artikelbezeichnung zubehoerBrustimplantat zubehoerEndoprothese
used by	element Operation/zubehoer
source	<code><complexType name="Zubehoer"></code> <code><complexContent></code>

```

<extension base="ZubehoerBasis">
  <sequence>
    <choice>
      <element name="zubehoerBrustimplantat"
type="ZubehoerBrustimplantatBasis"/>
      <element name="zubehoerEndoprothese"
type="ZubehoerEndoprotheseBasis"/>
    </choice>
  </sequence>
</extension>
</complexContent>
</complexType>

```

element **Zubehoer/zubehoerBrustimplantat**

diagram	
type	ZubehoerBrustimplantatBasis
properties	content complex
children	ZBI_HerstellerSchluessel ZBI_HerstellerUnbekannt ZBI_HerstellerSonstiger ZBI_ZubehoerTypSchluessel
source	<code><element name="zubehoerBrustimplantat" type="ZubehoerBrustimplantatBasis"/></code>

element **Zubehoer/zubehoerEndoprothese**

diagram	
type	ZubehoerEndoprotheseBasis
properties	content complex
children	ZEP HerstellerSchluessel ZEP HerstellerUnbekannt ZEP HerstellerSonstiger ZEP ZubehoerTypSchluessel ZEP Menge ZEP EinheitSchluessel
source	<code><element name="zubehoerEndoprothese" type="ZubehoerEndoprotheseBasis"/></code>

complexType **EntlassungBasis**

diagram	
namespace	http://xml.ir-d.de/emg
children	ENT Datum ENT GrundSchluessel
used by	complexType Entlassung
source	<pre> <complexType name="EntlassungBasis"> <sequence> <element name="ENT_Datum" type="xs:date"/> <element name="ENT_GrundSchluessel" type="String2" minOccurs="0"/> </sequence> </complexType> </pre>

element EntlassungBasis/ENT_Datum

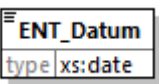
diagram	
type	date
properties	content simple
source	<code><element name="ENT_Datum" type="xs:date"/></code>

element EntlassungBasis/ENT_GrundSchluessel

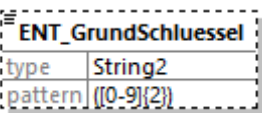
diagram	
type	String2
properties	minOcc 0 maxOcc 1 content simple
facets	Kind Value Annotation pattern ([0-9]{2})
source	<code><element name="ENT_GrundSchluessel" type="String2" minOccurs="0"/></code>

complexType DiagnoseBrustimplantatBasis

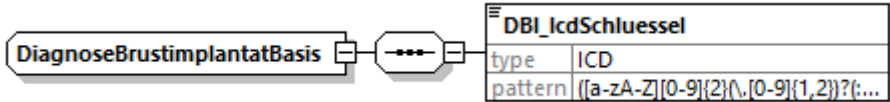
diagram	
namespace	http://xml.ir-d.de/emg
children	DBI_IcdSchluessel
used by	element Entlassung/diagnoseBrustimplantat
source	<pre><complexType name="DiagnoseBrustimplantatBasis"> <sequence> <element name="DBI_IcdSchluessel" type="ICD"/> </sequence> </complexType></pre>

element DiagnoseBrustimplantatBasis/DBI_IcdSchluessel

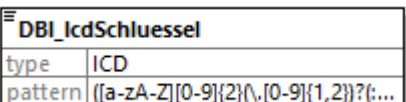
diagram	
type	ICD
properties	content simple
facets	Kind Value Annotation pattern ([a-zA-Z][0-9]{2}(\.[0-9]{1,2})?;:[RLB])?)

source	<code><element name="DBI_IcdSchluessel" type="ICD"/></code>
--------	---

complexType DiagnoseEndoprotheseBasis

diagram	
namespace	http://xml.ir-d.de/emg
children	DEP_IcdSchluessel
used by	element Entlassung/diagnoseEndoprothese
source	<pre> <complexType name="DiagnoseEndoprotheseBasis"> <sequence> <element name="DEP_IcdSchluessel" type="ICD"/> </sequence> </complexType> </pre>

element DiagnoseEndoprotheseBasis/DEP_IcdSchluessel

diagram							
type	ICD						
properties	content simple						
facets	<table border="1"> <thead> <tr> <th>Kind</th> <th>Value</th> <th>Annotation</th> </tr> </thead> <tbody> <tr> <td>pattern</td> <td>([a-zA-Z][0-9]{2}\.[0-9]{1,2})?;(:[RLB])?</td> <td></td> </tr> </tbody> </table>	Kind	Value	Annotation	pattern	([a-zA-Z][0-9]{2}\.[0-9]{1,2})?;(:[RLB])?	
Kind	Value	Annotation					
pattern	([a-zA-Z][0-9]{2}\.[0-9]{1,2})?;(:[RLB])?						
source	<code><element name="DEP_IcdSchluessel" type="ICD"/></code>						

complexType DiagnoseAortenklappeBasis

diagram	
namespace	http://xml.ir-d.de/emg
children	DAK_IcdSchluessel
used by	element Entlassung/diagnoseAortenklappe
source	<pre> <complexType name="DiagnoseAortenklappeBasis"> <sequence> <element name="DAK_IcdSchluessel" type="ICD"/> </sequence> </complexType> </pre>

element **DiagnoseAortenklappeBasis/DAK_IcdSchluessel**

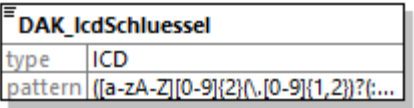
diagram	 <pre> DAK_IcdSchluessel type ICD pattern ([a-zA-Z][0-9]{2}(\.[0-9]{1,2})?:(... </pre>						
type	ICD						
properties	content simple						
facets	<table border="1"> <thead> <tr> <th>Kind</th> <th>Value</th> <th>Annotation</th> </tr> </thead> <tbody> <tr> <td>pattern</td> <td>([a-zA-Z][0-9]{2}(\.[0-9]{1,2})?:(RLB))?</td> <td></td> </tr> </tbody> </table>	Kind	Value	Annotation	pattern	([a-zA-Z][0-9]{2}(\.[0-9]{1,2})?:(RLB))?	
Kind	Value	Annotation					
pattern	([a-zA-Z][0-9]{2}(\.[0-9]{1,2})?:(RLB))?						
source	<code><element name="DAK_IcdSchluessel" type="ICD"/></code>						

complexType PostoperationAortenklappeBasis

diagram

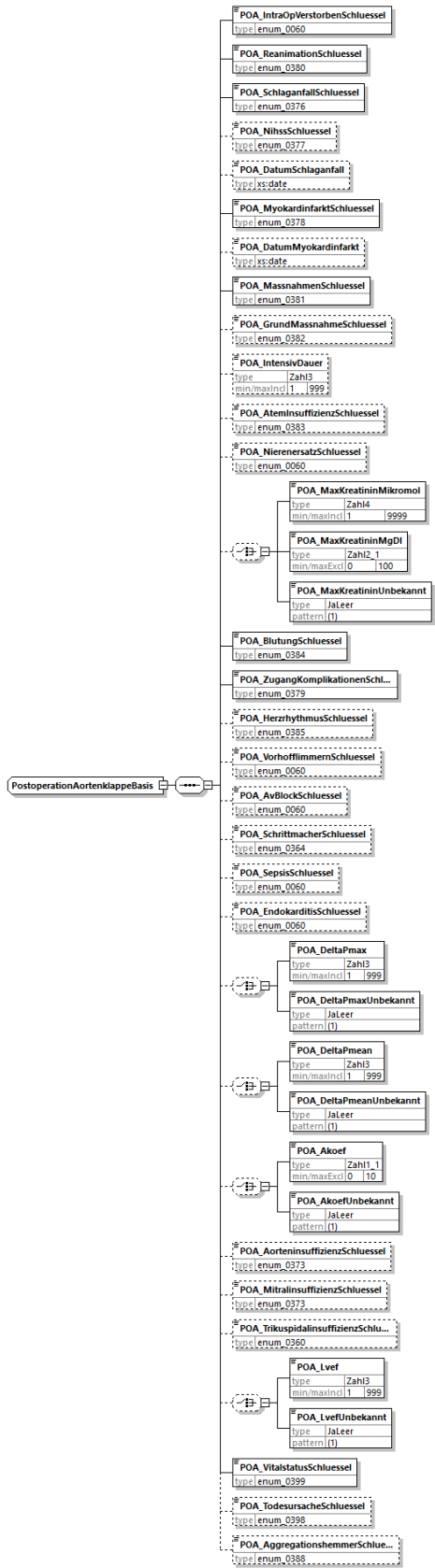

namespace	http://xml.ir-d.de/emg
children	POA_IntraOpVerstorbenSchluessel POA_ReanimationSchluessel POA_SchlaganfallSchluessel POA_NihssSchluessel POA_DatumSchlaganfall POA_MyokardinfarktSchluessel POA_DatumMyokardinfarkt

	POA MassnahmenSchluessel POA GrundMassnahmeSchluessel POA IntensivDauer POA AtemInsuffizienzSchluessel POA NierenersatzSchluessel POA MaxKreatininMikromol POA MaxKreatininMgDI POA MaxKreatininUnbekannt POA BlutungSchluessel POA ZugangKomplikationenSchluessel POA HerzrhythmusSchluessel POA VorhofflimmernSchluessel POA AvBlockSchluessel POA SchrittmacherSchluessel POA SepsisSchluessel POA EndokarditisSchluessel POA DeltaPmax POA DeltaPmaxUnbekannt POA DeltaPmean POA DeltaPmeanUnbekannt POA Akoef POA AkoefUnbekannt POA AorteninsuffizienzSchluessel POA MitralinsuffizienzSchluessel POA TrikuspidalinsuffizienzSchluessel POA Lvef POA LvefUnbekannt POA VitalstatusSchluessel POA TodesursacheSchluessel POA AggregationshemmerSchluessel
used by	complexType PostoperationAortenklappe
source	<pre> <complexType name="PostoperationAortenklappeBasis"> <sequence> <element name="POA_IntraOpVerstorbenSchluessel" type="enum_0060"/> <element name="POA_ReanimationSchluessel" type="enum_0380"/> <element name="POA_SchlaganfallSchluessel" type="enum_0376"/> <element name="POA_NihssSchluessel" type="enum_0377" minOccurs="0"/> <element name="POA_DatumSchlaganfall" type="xs:date" minOccurs="0"/> <element name="POA_MyokardinfarktSchluessel" type="enum_0378"/> <element name="POA_DatumMyokardinfarkt" type="xs:date" minOccurs="0"/> <element name="POA_MassnahmenSchluessel" type="enum_0381"/> <element name="POA_GrundMassnahmeSchluessel" type="enum_0382" minOccurs="0"/> <element name="POA_IntensivDauer" type="Zahl3" minOccurs="0"/> <element name="POA_AtemInsuffizienzSchluessel" type="enum_0383" minOccurs="0"/> <element name="POA_NierenersatzSchluessel" type="enum_0060" minOccurs="0"/> <choice minOccurs="0"> <element name="POA_MaxKreatininMikromol" type="Zahl14"/> <element name="POA_MaxKreatininMgDI" type="Zahl2_1"/> <element name="POA_MaxKreatininUnbekannt" type="JaLeer"/> </choice> <element name="POA_BlutungSchluessel" type="enum_0384"/> <element name="POA_ZugangKomplikationenSchluessel" type="enum_0379"/> <element name="POA_HerzrhythmusSchluessel" type="enum_0385" minOccurs="0"/> <element name="POA_VorhofflimmernSchluessel" type="enum_0060" minOccurs="0"/> <element name="POA_AvBlockSchluessel" type="enum_0060" minOccurs="0"/> <element name="POA_SchrittmacherSchluessel" type="enum_0364" minOccurs="0"/> <element name="POA_SepsisSchluessel" type="enum_0060" minOccurs="0"/> <element name="POA_EndokarditisSchluessel" type="enum_0060" minOccurs="0"/> <choice minOccurs="0"> <element name="POA_DeltaPmax" type="Zahl3"/> <element name="POA_DeltaPmaxUnbekannt" type="JaLeer"/> </choice> <choice minOccurs="0"> <element name="POA_DeltaPmean" type="Zahl3"/> <element name="POA_DeltaPmeanUnbekannt" type="JaLeer"/> </choice> <choice minOccurs="0"> <element name="POA_Akoef" type="Zahl1_1"/> <element name="POA_AkoefUnbekannt" type="JaLeer"/> </choice> <element name="POA_AorteninsuffizienzSchluessel" type="enum_0373" minOccurs="0"/> <element name="POA MitralinsuffizienzSchluessel" type="enum_0373" </pre>

	<pre> minOccurs="0"/> <element name="POA_TrikuspidalinsuffizienzSchluessel" type="enum_0360" minOccurs="0"/> <choice minOccurs="0"> <element name="POA_Lvef" type="Zahl3"/> <element name="POA_LvefUnbekannt" type="JaLeer"/> </choice> <element name="POA_VitalstatusSchluessel" type="enum_0399"/> <element name="POA_TodesursacheSchluessel" type="enum_0398" minOccurs="0"/> <element name="POA_AggregationshemmerSchluessel" type="enum_0388" minOccurs="0"/> </sequence> </complexType> </pre>
--	---

element **PostoperationAortenklappeBasis/POA_IntraOpVerstorbenSchluessel**

diagram										
type	enum_0060									
properties	content simple									
facets	<table border="1"> <thead> <tr> <th>Kind</th> <th>Value</th> <th>Annotation</th> </tr> </thead> <tbody> <tr> <td>enumeration</td> <td>0060001</td> <td>documentation ja</td> </tr> <tr> <td>enumeration</td> <td>0060002</td> <td>documentation nein</td> </tr> </tbody> </table>	Kind	Value	Annotation	enumeration	0060001	documentation ja	enumeration	0060002	documentation nein
Kind	Value	Annotation								
enumeration	0060001	documentation ja								
enumeration	0060002	documentation nein								
source	<code><element name="POA_IntraOpVerstorbenSchluessel" type="enum_0060"/></code>									

element **PostoperationAortenklappeBasis/POA_ReanimationSchluessel**

diagram																
type	enum_0380															
properties	content simple															
facets	<table border="1"> <thead> <tr> <th>Kind</th> <th>Value</th> <th>Annotation</th> </tr> </thead> <tbody> <tr> <td>enumeration</td> <td>0380001</td> <td>documentation nein</td> </tr> <tr> <td>enumeration</td> <td>0380002</td> <td>documentation ja, intraprozedural</td> </tr> <tr> <td>enumeration</td> <td>0380003</td> <td>documentation ja, postprozedural</td> </tr> <tr> <td>enumeration</td> <td>0380004</td> <td>documentation ja, Zeitpunkt nicht bekannt</td> </tr> </tbody> </table>	Kind	Value	Annotation	enumeration	0380001	documentation nein	enumeration	0380002	documentation ja, intraprozedural	enumeration	0380003	documentation ja, postprozedural	enumeration	0380004	documentation ja, Zeitpunkt nicht bekannt
Kind	Value	Annotation														
enumeration	0380001	documentation nein														
enumeration	0380002	documentation ja, intraprozedural														
enumeration	0380003	documentation ja, postprozedural														
enumeration	0380004	documentation ja, Zeitpunkt nicht bekannt														
source	<code><element name="POA_ReanimationSchluessel" type="enum_0380"/></code>															

element **PostoperationAortenklappeBasis/POA_SchlaganfallSchluessel**

diagram	
---------	--

type	enum_0376															
properties	content simple															
facets	<table border="1"> <thead> <tr> <th>Kind</th> <th>Value</th> <th>Annotation</th> </tr> </thead> <tbody> <tr> <td>enumeration</td> <td>0376001</td> <td>documentation nein</td> </tr> <tr> <td>enumeration</td> <td>0376002</td> <td>documentation ja, ZNS, zerebrovaskuläre Blutung</td> </tr> <tr> <td>enumeration</td> <td>0376003</td> <td>documentation ja, ZNS, zerebrovaskuläre Ischämie</td> </tr> <tr> <td>enumeration</td> <td>0376042</td> <td>documentation ja, ZNS, andere</td> </tr> </tbody> </table>	Kind	Value	Annotation	enumeration	0376001	documentation nein	enumeration	0376002	documentation ja, ZNS, zerebrovaskuläre Blutung	enumeration	0376003	documentation ja, ZNS, zerebrovaskuläre Ischämie	enumeration	0376042	documentation ja, ZNS, andere
Kind	Value	Annotation														
enumeration	0376001	documentation nein														
enumeration	0376002	documentation ja, ZNS, zerebrovaskuläre Blutung														
enumeration	0376003	documentation ja, ZNS, zerebrovaskuläre Ischämie														
enumeration	0376042	documentation ja, ZNS, andere														
source	<code><element name="POA_SchlaganfallSchluessel" type="enum_0376"/></code>															

element **PostoperationAortenklappeBasis/POA_NihssSchluessel**

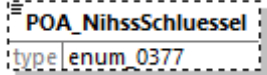
diagram													
type	enum_0377												
properties	minOcc 0 maxOcc 1 content simple												
facets	<table border="1"> <thead> <tr> <th>Kind</th> <th>Value</th> <th>Annotation</th> </tr> </thead> <tbody> <tr> <td>enumeration</td> <td>0377001</td> <td>documentation ja, mild neurological dysfunction: NIHSS 0-5</td> </tr> <tr> <td>enumeration</td> <td>0377002</td> <td>documentation ja, moderate neurological dysfunction: NIHSS 6-14</td> </tr> <tr> <td>enumeration</td> <td>0377003</td> <td>documentation ja, severe neurological dysfunction: NIHSS &gt;=15</td> </tr> </tbody> </table>	Kind	Value	Annotation	enumeration	0377001	documentation ja, mild neurological dysfunction: NIHSS 0-5	enumeration	0377002	documentation ja, moderate neurological dysfunction: NIHSS 6-14	enumeration	0377003	documentation ja, severe neurological dysfunction: NIHSS >=15
Kind	Value	Annotation											
enumeration	0377001	documentation ja, mild neurological dysfunction: NIHSS 0-5											
enumeration	0377002	documentation ja, moderate neurological dysfunction: NIHSS 6-14											
enumeration	0377003	documentation ja, severe neurological dysfunction: NIHSS >=15											
source	<code><element name="POA_NihssSchluessel" type="enum_0377" minOccurs="0"/></code>												

element **PostoperationAortenklappeBasis/POA_DatumSchlaganfall**

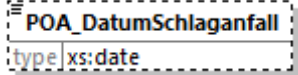
diagram	
type	date
properties	minOcc 0 maxOcc 1 content simple
source	<code><element name="POA_DatumSchlaganfall" type="xs:date" minOccurs="0"/></code>

element **PostoperationAortenklappeBasis/POA_MyokardinfarktSchluessel**

diagram							
type	enum_0378						
properties	content simple						
facets	<table border="1"> <thead> <tr> <th>Kind</th> <th>Value</th> <th>Annotation</th> </tr> </thead> <tbody> <tr> <td>enumeration</td> <td>0378001</td> <td>documentation</td> </tr> </tbody> </table>	Kind	Value	Annotation	enumeration	0378001	documentation
Kind	Value	Annotation					
enumeration	0378001	documentation					

	enumeration	0378002	nein documentation ja, < 48h gemäss VARC-3-Definition
	enumeration	0378003	documentation ja, >= 48h - <= 72h gemäß VARC-3-Definition
	enumeration	0378004	documentation ja, > 72 h gemäß VARC-3 Definition
source	<code><element name="POA_MyokardinfarktSchluessel" type="enum_0378"/></code>		

element **PostoperationAortenklappeBasis/POA_DatumMyokardinfarkt**

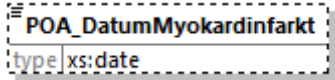
diagram			
type	date		
properties	minOcc	0	
	maxOcc	1	
	content	simple	
source	<code><element name="POA_DatumMyokardinfarkt" type="xs:date" minOccurs="0"/></code>		

element **PostoperationAortenklappeBasis/POA_MassnahmenSchluessel**

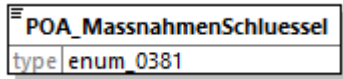
diagram			
type	enum 0381		
properties	content	simple	
facets	Kind	Value	Annotation
	enumeration	0381001	documentation nein
	enumeration	0381002	documentation Thorakotomie/Rethorakotomie
	enumeration	0381003	documentation kathetergestützte Reintervention
	enumeration	0381004	documentation lokale Reinterventionen
	enumeration	0381005	documentation andere Reintervention
source	<code><element name="POA_MassnahmenSchluessel" type="enum_0381"/></code>		

element **PostoperationAortenklappeBasis/POA_GrundMassnahmeSchluessel**

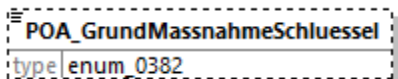
diagram			
type	enum 0382		
properties	minOcc	0	
	maxOcc	1	
	content	simple	
facets	Kind	Value	Annotation
	enumeration	0382001	documentation keine Rethorakotomie / kein weiterer Grund
	enumeration	0382002	documentation

	enumeration	0382003	Blutung/Hämatom documentation
	enumeration	0382004	Low Cardiac Output documentation
	enumeration	0382005	Tamponade documentation
	enumeration	0382006	Graftprobleme, Ischämie documentation
	enumeration	0382007	Wundinfektion, Mediastinitis documentation
	enumeration	0382008	Dissektion documentation
	enumeration	0382009	Prothesendysfunktion documentation
	enumeration	0382010	instabiles Sternum documentation
	enumeration	0382011	Chylothorax documentation
	enumeration	0382042	lokale Revision im Bereich des Zugangsweges documentation
			anderer Grund
source	<code><element name="POA_GrundMassnahmeSchluessel" type="enum_0382" minOccurs="0"/></code>		

element **PostoperationAortenklappeBasis/POA_IntensivDauer**

diagram			
type	Zahl3		
properties	minOcc	0	
	maxOcc	1	
	content	simple	
facets	Kind	Value	Annotation
	minInclusive	1	
	maxInclusive	999	
source	<code><element name="POA_IntensivDauer" type="Zahl3" minOccurs="0"/></code>		

element **PostoperationAortenklappeBasis/POA_AtemInsuffizienzSchluessel**

diagram			
type	enum 0383		
properties	minOcc	0	
	maxOcc	1	
	content	simple	
facets	Kind	Value	Annotation
	enumeration	0383001	documentation nein
	enumeration	0383002	documentation ja, mit forcierter Atemtherapie
	enumeration	0383003	documentation ja, Reintubation oder längerfristige Beatmung
	enumeration	0383004	documentation ja, Tracheotomie

source	<code><element name="POA_AtemInsuffizienzSchluessel" type="enum_0383" minOccurs="0"/></code>
--------	--

element **PostoperationAortenklappeBasis/POA_NierenersatzSchluessel**

diagram										
type	enum_0060									
properties	minOcc 0 maxOcc 1 content simple									
facets	<table border="1"> <thead> <tr> <th>Kind</th> <th>Value</th> <th>Annotation</th> </tr> </thead> <tbody> <tr> <td>enumeration</td> <td>0060001</td> <td>documentation ja</td> </tr> <tr> <td>enumeration</td> <td>0060002</td> <td>documentation nein</td> </tr> </tbody> </table>	Kind	Value	Annotation	enumeration	0060001	documentation ja	enumeration	0060002	documentation nein
Kind	Value	Annotation								
enumeration	0060001	documentation ja								
enumeration	0060002	documentation nein								
source	<code><element name="POA_NierenersatzSchluessel" type="enum_0060" minOccurs="0"/></code>									

element **PostoperationAortenklappeBasis/POA_MaxKreatininMikromol**

diagram										
type	Zahl4									
properties	content simple									
facets	<table border="1"> <thead> <tr> <th>Kind</th> <th>Value</th> <th>Annotation</th> </tr> </thead> <tbody> <tr> <td>minInclusive</td> <td>1</td> <td></td> </tr> <tr> <td>maxInclusive</td> <td>9999</td> <td></td> </tr> </tbody> </table>	Kind	Value	Annotation	minInclusive	1		maxInclusive	9999	
Kind	Value	Annotation								
minInclusive	1									
maxInclusive	9999									
source	<code><element name="POA_MaxKreatininMikromol" type="Zahl4"/></code>									

element **PostoperationAortenklappeBasis/POA_MaxKreatininMgDI**

diagram																
type	Zahl2_1															
properties	content simple															
facets	<table border="1"> <thead> <tr> <th>Kind</th> <th>Value</th> <th>Annotation</th> </tr> </thead> <tbody> <tr> <td>minExclusive</td> <td>0</td> <td></td> </tr> <tr> <td>maxExclusive</td> <td>100</td> <td></td> </tr> <tr> <td>totalDigits</td> <td>2</td> <td></td> </tr> <tr> <td>fractionDigits</td> <td>1</td> <td></td> </tr> </tbody> </table>	Kind	Value	Annotation	minExclusive	0		maxExclusive	100		totalDigits	2		fractionDigits	1	
Kind	Value	Annotation														
minExclusive	0															
maxExclusive	100															
totalDigits	2															
fractionDigits	1															
source	<code><element name="POA_MaxKreatininMgDI" type="Zahl2_1"/></code>															

element **PostoperationAortenklappeBasis/POA_MaxKreatininUnbekannt**

diagram							
type	JaLeer						
properties	content simple						
facets	<table border="1"> <thead> <tr> <th>Kind</th> <th>Value</th> <th>Annotation</th> </tr> </thead> <tbody> <tr> <td>pattern</td> <td>(1)</td> <td></td> </tr> </tbody> </table>	Kind	Value	Annotation	pattern	(1)	
Kind	Value	Annotation					
pattern	(1)						
source	<code><element name="POA_MaxKreatininUnbekannt" type="JaLeer"/></code>						

element **PostoperationAortenklappeBasis/POA_BlutungSchluessel**

diagram																
type	enum_0384															
properties	content simple															
facets	<table border="1"> <thead> <tr> <th>Kind</th> <th>Value</th> <th>Annotation</th> </tr> </thead> <tbody> <tr> <td>enumeration</td> <td>0384001</td> <td>documentation keine Blutungskomplikationen</td> </tr> <tr> <td>enumeration</td> <td>0384002</td> <td>documentation Geringfügige Blutung (Minor Bleeding - BARC type 2 or 3a)</td> </tr> <tr> <td>enumeration</td> <td>0384003</td> <td>documentation Starke Blutung (Major Bleeding - BARC type 3a)</td> </tr> <tr> <td>enumeration</td> <td>0384004</td> <td>documentation Lebensbedrohliche Blutung (Life-threatening or disabling bleeding - BARC type 3b or 3c or type 5)</td> </tr> </tbody> </table>	Kind	Value	Annotation	enumeration	0384001	documentation keine Blutungskomplikationen	enumeration	0384002	documentation Geringfügige Blutung (Minor Bleeding - BARC type 2 or 3a)	enumeration	0384003	documentation Starke Blutung (Major Bleeding - BARC type 3a)	enumeration	0384004	documentation Lebensbedrohliche Blutung (Life-threatening or disabling bleeding - BARC type 3b or 3c or type 5)
Kind	Value	Annotation														
enumeration	0384001	documentation keine Blutungskomplikationen														
enumeration	0384002	documentation Geringfügige Blutung (Minor Bleeding - BARC type 2 or 3a)														
enumeration	0384003	documentation Starke Blutung (Major Bleeding - BARC type 3a)														
enumeration	0384004	documentation Lebensbedrohliche Blutung (Life-threatening or disabling bleeding - BARC type 3b or 3c or type 5)														
source	<code><element name="POA_BlutungSchluessel" type="enum_0384"/></code>															

element **PostoperationAortenklappeBasis/POA_ZugangKomplikationenSchluessel**

diagram																
type	enum_0379															
properties	content simple															
facets	<table border="1"> <thead> <tr> <th>Kind</th> <th>Value</th> <th>Annotation</th> </tr> </thead> <tbody> <tr> <td>enumeration</td> <td>0379001</td> <td>documentation Keine gefäß- oder zugangsassoziierte Komplikationen</td> </tr> <tr> <td>enumeration</td> <td>0379002</td> <td>documentation Versagen des perkutanen Verschlusssystems</td> </tr> <tr> <td>enumeration</td> <td>0379003</td> <td>documentation Geringfügige Gefäßkomplikationen</td> </tr> <tr> <td>enumeration</td> <td>0379004</td> <td>documentation Erhebliche Gefäßkomplikationen</td> </tr> </tbody> </table>	Kind	Value	Annotation	enumeration	0379001	documentation Keine gefäß- oder zugangsassoziierte Komplikationen	enumeration	0379002	documentation Versagen des perkutanen Verschlusssystems	enumeration	0379003	documentation Geringfügige Gefäßkomplikationen	enumeration	0379004	documentation Erhebliche Gefäßkomplikationen
Kind	Value	Annotation														
enumeration	0379001	documentation Keine gefäß- oder zugangsassoziierte Komplikationen														
enumeration	0379002	documentation Versagen des perkutanen Verschlusssystems														
enumeration	0379003	documentation Geringfügige Gefäßkomplikationen														
enumeration	0379004	documentation Erhebliche Gefäßkomplikationen														
source	<code><element name="POA_ZugangKomplikationenSchluessel" type="enum_0379"/></code>															

element **PostoperationAortenklappeBasis/POA_HerzrhythmusSchluessel**

diagram																
type	enum 0385															
properties	minOcc 0 maxOcc 1 content simple															
facets	<table border="1"> <thead> <tr> <th>Kind</th> <th>Value</th> <th>Annotation</th> </tr> </thead> <tbody> <tr> <td>enumeration</td> <td>0385001</td> <td>documentation Sinusrhythmus</td> </tr> <tr> <td>enumeration</td> <td>0385002</td> <td>documentation Vorhofflimmern</td> </tr> <tr> <td>enumeration</td> <td>0385003</td> <td>documentation Patient verstorben (kein Herzrhythmus)</td> </tr> <tr> <td>enumeration</td> <td>0385042</td> <td>documentation anderer Rhythmus</td> </tr> </tbody> </table>	Kind	Value	Annotation	enumeration	0385001	documentation Sinusrhythmus	enumeration	0385002	documentation Vorhofflimmern	enumeration	0385003	documentation Patient verstorben (kein Herzrhythmus)	enumeration	0385042	documentation anderer Rhythmus
Kind	Value	Annotation														
enumeration	0385001	documentation Sinusrhythmus														
enumeration	0385002	documentation Vorhofflimmern														
enumeration	0385003	documentation Patient verstorben (kein Herzrhythmus)														
enumeration	0385042	documentation anderer Rhythmus														
source	<code><element name="POA_HerzrhythmusSchluessel" type="enum_0385" minOccurs="0"/></code>															

element **PostoperationAortenklappeBasis/POA_VorhofflimmernSchluessel**

diagram										
type	enum 0060									
properties	minOcc 0 maxOcc 1 content simple									
facets	<table border="1"> <thead> <tr> <th>Kind</th> <th>Value</th> <th>Annotation</th> </tr> </thead> <tbody> <tr> <td>enumeration</td> <td>0060001</td> <td>documentation ja</td> </tr> <tr> <td>enumeration</td> <td>0060002</td> <td>documentation nein</td> </tr> </tbody> </table>	Kind	Value	Annotation	enumeration	0060001	documentation ja	enumeration	0060002	documentation nein
Kind	Value	Annotation								
enumeration	0060001	documentation ja								
enumeration	0060002	documentation nein								
source	<code><element name="POA_VorhofflimmernSchluessel" type="enum_0060" minOccurs="0"/></code>									

element **PostoperationAortenklappeBasis/POA_AvBlockSchluessel**

diagram										
type	enum 0060									
properties	minOcc 0 maxOcc 1 content simple									
facets	<table border="1"> <thead> <tr> <th>Kind</th> <th>Value</th> <th>Annotation</th> </tr> </thead> <tbody> <tr> <td>enumeration</td> <td>0060001</td> <td>documentation ja</td> </tr> <tr> <td>enumeration</td> <td>0060002</td> <td>documentation nein</td> </tr> </tbody> </table>	Kind	Value	Annotation	enumeration	0060001	documentation ja	enumeration	0060002	documentation nein
Kind	Value	Annotation								
enumeration	0060001	documentation ja								
enumeration	0060002	documentation nein								
source	<code><element name="POA_AvBlockSchluessel" type="enum_0060" minOccurs="0"/></code>									

element **PostoperationAortenklappeBasis/POA_SchrittmacherSchluessel**

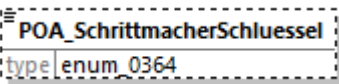
diagram																			
type	enum 0364																		
properties	minOcc 0 maxOcc 1 content simple																		
facets	<table border="1"> <thead> <tr> <th>Kind</th> <th>Value</th> <th>Annotation</th> </tr> </thead> <tbody> <tr> <td>enumeration</td> <td>0364001</td> <td>documentation nein</td> </tr> <tr> <td>enumeration</td> <td>0364002</td> <td>documentation Schrittmacher ohne CRT-System</td> </tr> <tr> <td>enumeration</td> <td>0364003</td> <td>documentation Schrittmacher mit CRT-System</td> </tr> <tr> <td>enumeration</td> <td>0364004</td> <td>documentation Defibrillator ohne CRT-System</td> </tr> <tr> <td>enumeration</td> <td>0364005</td> <td>documentation Defibrillator mit CRT-System</td> </tr> </tbody> </table>	Kind	Value	Annotation	enumeration	0364001	documentation nein	enumeration	0364002	documentation Schrittmacher ohne CRT-System	enumeration	0364003	documentation Schrittmacher mit CRT-System	enumeration	0364004	documentation Defibrillator ohne CRT-System	enumeration	0364005	documentation Defibrillator mit CRT-System
Kind	Value	Annotation																	
enumeration	0364001	documentation nein																	
enumeration	0364002	documentation Schrittmacher ohne CRT-System																	
enumeration	0364003	documentation Schrittmacher mit CRT-System																	
enumeration	0364004	documentation Defibrillator ohne CRT-System																	
enumeration	0364005	documentation Defibrillator mit CRT-System																	
source	<code><element name="POA_SchrittmacherSchluessel" type="enum_0364" minOccurs="0"/></code>																		

element **PostoperationAortenklappeBasis/POA_SepsisSchluessel**

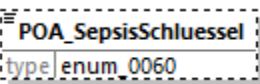
diagram										
type	enum 0060									
properties	minOcc 0 maxOcc 1 content simple									
facets	<table border="1"> <thead> <tr> <th>Kind</th> <th>Value</th> <th>Annotation</th> </tr> </thead> <tbody> <tr> <td>enumeration</td> <td>0060001</td> <td>documentation ja</td> </tr> <tr> <td>enumeration</td> <td>0060002</td> <td>documentation nein</td> </tr> </tbody> </table>	Kind	Value	Annotation	enumeration	0060001	documentation ja	enumeration	0060002	documentation nein
Kind	Value	Annotation								
enumeration	0060001	documentation ja								
enumeration	0060002	documentation nein								
source	<code><element name="POA_SepsisSchluessel" type="enum_0060" minOccurs="0"/></code>									

element **PostoperationAortenklappeBasis/POA_EndokarditisSchluessel**

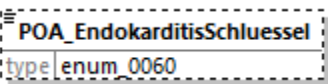
diagram										
type	enum 0060									
properties	minOcc 0 maxOcc 1 content simple									
facets	<table border="1"> <thead> <tr> <th>Kind</th> <th>Value</th> <th>Annotation</th> </tr> </thead> <tbody> <tr> <td>enumeration</td> <td>0060001</td> <td>documentation ja</td> </tr> <tr> <td>enumeration</td> <td>0060002</td> <td>documentation nein</td> </tr> </tbody> </table>	Kind	Value	Annotation	enumeration	0060001	documentation ja	enumeration	0060002	documentation nein
Kind	Value	Annotation								
enumeration	0060001	documentation ja								
enumeration	0060002	documentation nein								
source	<code><element name="POA_EndokarditisSchluessel" type="enum_0060" minOccurs="0"/></code>									

element **PostoperationAortenklappeBasis/POA_DeltaPmax**

diagram										
type	Zahl3									
properties	content simple									
facets	<table border="1"> <thead> <tr> <th>Kind</th> <th>Value</th> <th>Annotation</th> </tr> </thead> <tbody> <tr> <td>minInclusive</td> <td>1</td> <td></td> </tr> <tr> <td>maxInclusive</td> <td>999</td> <td></td> </tr> </tbody> </table>	Kind	Value	Annotation	minInclusive	1		maxInclusive	999	
Kind	Value	Annotation								
minInclusive	1									
maxInclusive	999									
source	<code><element name="POA_DeltaPmax" type="Zahl3"/></code>									

element **PostoperationAortenklappeBasis/POA_DeltaPmaxUnbekannt**

diagram							
type	JaLeer						
properties	content simple						
facets	<table border="1"> <thead> <tr> <th>Kind</th> <th>Value</th> <th>Annotation</th> </tr> </thead> <tbody> <tr> <td>pattern</td> <td>(1)</td> <td></td> </tr> </tbody> </table>	Kind	Value	Annotation	pattern	(1)	
Kind	Value	Annotation					
pattern	(1)						
source	<code><element name="POA_DeltaPmaxUnbekannt" type="JaLeer"/></code>						

element **PostoperationAortenklappeBasis/POA_DeltaPmean**

diagram										
type	Zahl3									
properties	content simple									
facets	<table border="1"> <thead> <tr> <th>Kind</th> <th>Value</th> <th>Annotation</th> </tr> </thead> <tbody> <tr> <td>minInclusive</td> <td>1</td> <td></td> </tr> <tr> <td>maxInclusive</td> <td>999</td> <td></td> </tr> </tbody> </table>	Kind	Value	Annotation	minInclusive	1		maxInclusive	999	
Kind	Value	Annotation								
minInclusive	1									
maxInclusive	999									
source	<code><element name="POA_DeltaPmean" type="Zahl3"/></code>									

element **PostoperationAortenklappeBasis/POA_DeltaPmeanUnbekannt**

diagram							
type	JaLeer						
properties	content simple						
facets	<table border="1"> <thead> <tr> <th>Kind</th> <th>Value</th> <th>Annotation</th> </tr> </thead> <tbody> <tr> <td>pattern</td> <td>(1)</td> <td></td> </tr> </tbody> </table>	Kind	Value	Annotation	pattern	(1)	
Kind	Value	Annotation					
pattern	(1)						

source	<code><element name="POA_DeltaPmeanUnbekannt" type="JaLeer"/></code>
--------	--

element **PostoperationAortenklappeBasis/POA_Akoef**

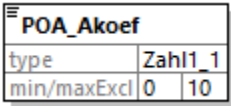
diagram																
type	Zahl1_1															
properties	content simple															
facets	<table border="1"> <thead> <tr> <th>Kind</th> <th>Value</th> <th>Annotation</th> </tr> </thead> <tbody> <tr> <td>minExclusive</td> <td>0</td> <td></td> </tr> <tr> <td>maxExclusive</td> <td>10</td> <td></td> </tr> <tr> <td>totalDigits</td> <td>1</td> <td></td> </tr> <tr> <td>fractionDigits</td> <td>1</td> <td></td> </tr> </tbody> </table>	Kind	Value	Annotation	minExclusive	0		maxExclusive	10		totalDigits	1		fractionDigits	1	
Kind	Value	Annotation														
minExclusive	0															
maxExclusive	10															
totalDigits	1															
fractionDigits	1															
source	<code><element name="POA_Akoef" type="Zahl1_1"/></code>															

element **PostoperationAortenklappeBasis/POA_AkoefUnbekannt**

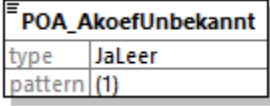
diagram							
type	JaLeer						
properties	content simple						
facets	<table border="1"> <thead> <tr> <th>Kind</th> <th>Value</th> <th>Annotation</th> </tr> </thead> <tbody> <tr> <td>pattern</td> <td>(1)</td> <td></td> </tr> </tbody> </table>	Kind	Value	Annotation	pattern	(1)	
Kind	Value	Annotation					
pattern	(1)						
source	<code><element name="POA_AkoefUnbekannt" type="JaLeer"/></code>						

element **PostoperationAortenklappeBasis/POA_AorteninsuffizienzSchluessel**

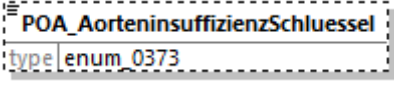
diagram																			
type	enum_0373																		
properties	<table border="1"> <tbody> <tr> <td>minOcc</td> <td>0</td> </tr> <tr> <td>maxOcc</td> <td>1</td> </tr> <tr> <td>content</td> <td>simple</td> </tr> </tbody> </table>	minOcc	0	maxOcc	1	content	simple												
minOcc	0																		
maxOcc	1																		
content	simple																		
facets	<table border="1"> <thead> <tr> <th>Kind</th> <th>Value</th> <th>Annotation</th> </tr> </thead> <tbody> <tr> <td>enumeration</td> <td>0373001</td> <td>documentation keine</td> </tr> <tr> <td>enumeration</td> <td>0373002</td> <td>documentation leichtgradig</td> </tr> <tr> <td>enumeration</td> <td>0373003</td> <td>documentation mittelgradig</td> </tr> <tr> <td>enumeration</td> <td>0373004</td> <td>documentation hochgradig</td> </tr> <tr> <td>enumeration</td> <td>0373099</td> <td>documentation unbekannt</td> </tr> </tbody> </table>	Kind	Value	Annotation	enumeration	0373001	documentation keine	enumeration	0373002	documentation leichtgradig	enumeration	0373003	documentation mittelgradig	enumeration	0373004	documentation hochgradig	enumeration	0373099	documentation unbekannt
Kind	Value	Annotation																	
enumeration	0373001	documentation keine																	
enumeration	0373002	documentation leichtgradig																	
enumeration	0373003	documentation mittelgradig																	
enumeration	0373004	documentation hochgradig																	
enumeration	0373099	documentation unbekannt																	
source	<code><element name="POA_AorteninsuffizienzSchluessel" type="enum_0373"></code>																		

	<code>minOccurs="0"/></code>
--	---------------------------------

element **PostoperationAortenklappeBasis/POA_MitralinsuffizienzSchluessel**

diagram			
type	enum 0373		
properties	minOcc 0 maxOcc 1 content simple		
facets	Kind	Value	Annotation
	enumeration	0373001	documentation keine
	enumeration	0373002	documentation leichtgradig
	enumeration	0373003	documentation mittelgradig
	enumeration	0373004	documentation hochgradig
	enumeration	0373099	documentation unbekannt
source	<code><element name="POA_MitralinsuffizienzSchluessel" type="enum_0373" minOccurs="0"/></code>		

element **PostoperationAortenklappeBasis/POA_TrikuspidalinsuffizienzSchluessel**

diagram			
type	enum 0360		
properties	minOcc 0 maxOcc 1 content simple		
facets	Kind	Value	Annotation
	enumeration	0360001	documentation keine
	enumeration	0360002	documentation leichtgradig
	enumeration	0360003	documentation mittelgradig
	enumeration	0360004	documentation hochgradig
	enumeration	0360005	documentation massive
	enumeration	0360006	documentation torrential
	enumeration	0360099	documentation unbekannt
source	<code><element name="POA_TrikuspidalinsuffizienzSchluessel" type="enum_0360" minOccurs="0"/></code>		

element **PostoperationAortenklappeBasis/POA_Lvef**

diagram										
type	Zahl3									
properties	content simple									
facets	<table border="1"> <thead> <tr> <th>Kind</th> <th>Value</th> <th>Annotation</th> </tr> </thead> <tbody> <tr> <td>minInclusive</td> <td>1</td> <td></td> </tr> <tr> <td>maxInclusive</td> <td>999</td> <td></td> </tr> </tbody> </table>	Kind	Value	Annotation	minInclusive	1		maxInclusive	999	
Kind	Value	Annotation								
minInclusive	1									
maxInclusive	999									
source	<code><element name="POA_Lvef" type="Zahl3"/></code>									

element **PostoperationAortenklappeBasis/POA_LvefUnbekannt**

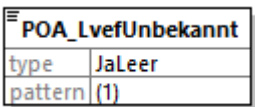
diagram							
type	JaLeer						
properties	content simple						
facets	<table border="1"> <thead> <tr> <th>Kind</th> <th>Value</th> <th>Annotation</th> </tr> </thead> <tbody> <tr> <td>pattern</td> <td>(1)</td> <td></td> </tr> </tbody> </table>	Kind	Value	Annotation	pattern	(1)	
Kind	Value	Annotation					
pattern	(1)						
source	<code><element name="POA_LvefUnbekannt" type="JaLeer"/></code>						

element **PostoperationAortenklappeBasis/POA_VitalstatusSchluessel**

diagram										
type	enum 0399									
properties	content simple									
facets	<table border="1"> <thead> <tr> <th>Kind</th> <th>Value</th> <th>Annotation</th> </tr> </thead> <tbody> <tr> <td>enumeration</td> <td>0399001</td> <td>documentation Patient lebt</td> </tr> <tr> <td>enumeration</td> <td>0399002</td> <td>documentation Patient im Krankenhaus verstorben</td> </tr> </tbody> </table>	Kind	Value	Annotation	enumeration	0399001	documentation Patient lebt	enumeration	0399002	documentation Patient im Krankenhaus verstorben
Kind	Value	Annotation								
enumeration	0399001	documentation Patient lebt								
enumeration	0399002	documentation Patient im Krankenhaus verstorben								
source	<code><element name="POA_VitalstatusSchluessel" type="enum_0399"/></code>									

element **PostoperationAortenklappeBasis/POA_TodesursacheSchluessel**

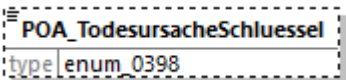
diagram							
type	enum 0398						
properties	<table border="1"> <tbody> <tr> <td>minOcc</td> <td>0</td> </tr> <tr> <td>maxOcc</td> <td>1</td> </tr> <tr> <td>content</td> <td>simple</td> </tr> </tbody> </table>	minOcc	0	maxOcc	1	content	simple
minOcc	0						
maxOcc	1						
content	simple						

facets	Kind	Value	Annotation
	enumeration	0398001	documentation kardiovaskuläre Ursache
	enumeration	0398002	documentation nicht-kardiovaskuläre Ursache
	enumeration	0398099	documentation Todesursache unbekannt
source	<code><element name="POA_TodesursacheSchluessel" type="enum_0398" minOccurs="0"/></code>		

element **PostoperationAortenklappeBasis/POA_AggregationshemmerSchluessel**

diagram			
type	enum 0388		
properties	minOcc 0 maxOcc 1 content simple		
facets	Kind	Value	Annotation
	enumeration	0388001	documentation nein
	enumeration	0388002	documentation ASS
	enumeration	0388003	documentation ADP-Rezeptor-Antagonist
	enumeration	0388004	documentation Kombination ASS und ADP-Rezeptor-Antagonist
	enumeration	0388042	documentation ja, andere
	enumeration	0388099	documentation unbekannt
source	<code><element name="POA_AggregationshemmerSchluessel" type="enum_0388" minOccurs="0"/></code>		

complexType **AntikoagulansAortenklappeBasis**

diagram	
namespace	http://xml.ir-d.de/emg
children	AKA_AntikoagulansSchluessel
used by	element PostoperationAortenklappe/antikoagulansAortenklappe
source	<code><complexType name="AntikoagulansAortenklappeBasis"> <sequence> <element name="AKA_AntikoagulansSchluessel" type="enum_0389"/> </sequence> </complexType></code>

element **AntikoagulansAortenklappeBasis/AKA_AntikoagulansSchluessel**

diagram			
type	enum 0389		
properties	content simple		
facets	Kind	Value	Annotation
	enumeration	0389001	documentation nein
	enumeration	0389002	documentation Cumarin-Derivate
	enumeration	0389003	documentation Heparinoide
	enumeration	0389004	documentation orale Thrombinantagonisten
	enumeration	0389005	documentation Kombination Heparinoide und Cumarin-Derivate
	enumeration	0389006	documentation Direkte orale Antikoagulantien (DOAK / NOAK)
	enumeration	0389042	documentation ja, andere
	enumeration	0389099	documentation unbekannt
source	<code><element name="AKA_AntikoagulansSchluessel" type="enum_0389"/></code>		

complexType **PatientenaufnahmeKardiologieBasis**

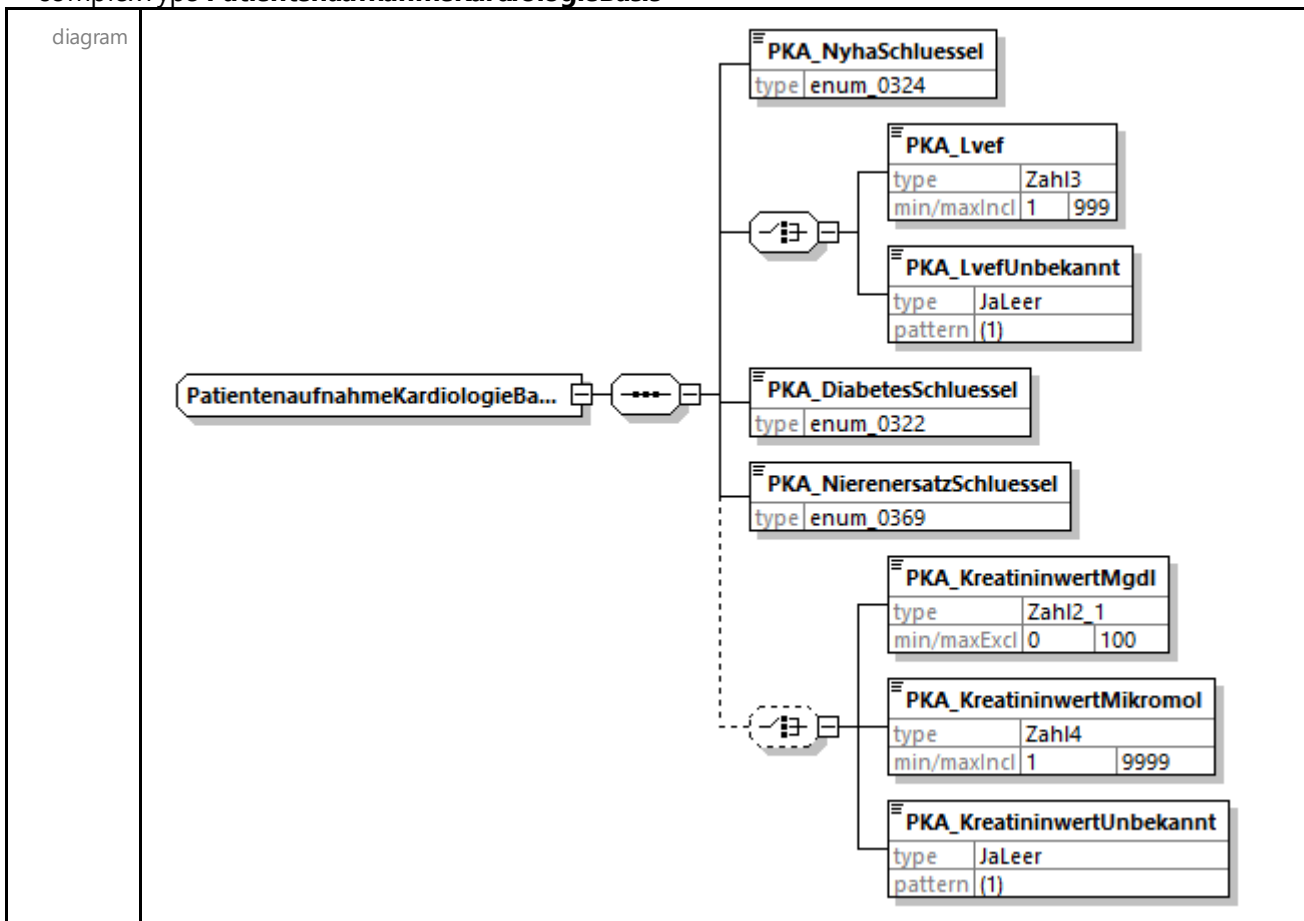

namespace	http://xml.ir-d.de/emg
children	PKA NyhaSchluessel PKA Lvef PKA LvefUnbekannt PKA DiabetesSchluessel PKA NierenersatzSchluessel PKA KreatininwertMgdl PKA KreatininwertMikromol PKA KreatininwertUnbekannt
used by	complexType PatientenaufnahmeKardiologie
source	<pre> <complexType name="PatientenaufnahmeKardiologieBasis"> <sequence> <element name="PKA_NyhaSchluessel" type="enum_0324"/> <choice> <element name="PKA_Lvef" type="Zahl3"/> <element name="PKA_LvefUnbekannt" type="JaLeer"/> </choice> <element name="PKA_DiabetesSchluessel" type="enum_0322"/> <element name="PKA_NierenersatzSchluessel" type="enum_0369"/> <choice minOccurs="0"> <element name="PKA_KreatininwertMgdl" type="Zahl2_1"/> <element name="PKA_KreatininwertMikromol" type="Zahl14"/> <element name="PKA_KreatininwertUnbekannt" type="JaLeer"/> </choice> </sequence> </complexType> </pre>

element [PatientenaufnahmeKardiologieBasis/PKA_NyhaSchluessel](#)

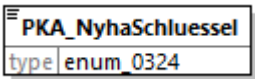
diagram																
type	enum 0324															
properties	content simple															
facets	<table border="1"> <thead> <tr> <th>Kind</th> <th>Value</th> <th>Annotation</th> </tr> </thead> <tbody> <tr> <td>enumeration</td> <td>0324001</td> <td>documentation (I): Beschwerdefreiheit, normale körperliche Belastbarkeit</td> </tr> <tr> <td>enumeration</td> <td>0324002</td> <td>documentation (II): Beschwerden bei stärkerer körperlicher Belastung</td> </tr> <tr> <td>enumeration</td> <td>0324003</td> <td>documentation (III): Beschwerden bei leichter körperlicher Belastung</td> </tr> <tr> <td>enumeration</td> <td>0324004</td> <td>documentation (IV): Beschwerden in Ruhe</td> </tr> </tbody> </table>	Kind	Value	Annotation	enumeration	0324001	documentation (I): Beschwerdefreiheit, normale körperliche Belastbarkeit	enumeration	0324002	documentation (II): Beschwerden bei stärkerer körperlicher Belastung	enumeration	0324003	documentation (III): Beschwerden bei leichter körperlicher Belastung	enumeration	0324004	documentation (IV): Beschwerden in Ruhe
Kind	Value	Annotation														
enumeration	0324001	documentation (I): Beschwerdefreiheit, normale körperliche Belastbarkeit														
enumeration	0324002	documentation (II): Beschwerden bei stärkerer körperlicher Belastung														
enumeration	0324003	documentation (III): Beschwerden bei leichter körperlicher Belastung														
enumeration	0324004	documentation (IV): Beschwerden in Ruhe														
source	<code><element name="PKA_NyhaSchluessel" type="enum_0324"/></code>															

element [PatientenaufnahmeKardiologieBasis/PKA_Lvef](#)

diagram										
type	Zahl3									
properties	content simple									
facets	<table border="1"> <thead> <tr> <th>Kind</th> <th>Value</th> <th>Annotation</th> </tr> </thead> <tbody> <tr> <td>minInclusive</td> <td>1</td> <td></td> </tr> <tr> <td>maxInclusive</td> <td>999</td> <td></td> </tr> </tbody> </table>	Kind	Value	Annotation	minInclusive	1		maxInclusive	999	
Kind	Value	Annotation								
minInclusive	1									
maxInclusive	999									
source	<code><element name="PKA_Lvef" type="Zahl3"/></code>									

element **PatientenaufnahmeKardiologieBasis/PKA_LvefUnbekannt**

diagram							
type	JaLeer						
properties	content simple						
facets	<table border="1"> <thead> <tr> <th>Kind</th> <th>Value</th> <th>Annotation</th> </tr> </thead> <tbody> <tr> <td>pattern</td> <td>(1)</td> <td></td> </tr> </tbody> </table>	Kind	Value	Annotation	pattern	(1)	
Kind	Value	Annotation					
pattern	(1)						
source	<code><element name="PKA_LvefUnbekannt" type="JaLeer"/></code>						

element **PatientenaufnahmeKardiologieBasis/PKA_DiabetesSchluessel**

diagram																						
type	enum_0322																					
properties	content simple																					
facets	<table border="1"> <thead> <tr> <th>Kind</th> <th>Value</th> <th>Annotation</th> </tr> </thead> <tbody> <tr> <td>enumeration</td> <td>0322001</td> <td>documentation nein</td> </tr> <tr> <td>enumeration</td> <td>0322002</td> <td>documentation ja, diätetisch behandelt</td> </tr> <tr> <td>enumeration</td> <td>0322003</td> <td>documentation ja, orale Medikation</td> </tr> <tr> <td>enumeration</td> <td>0322004</td> <td>documentation ja, mit Insulin behandelt</td> </tr> <tr> <td>enumeration</td> <td>0322005</td> <td>documentation ja, unbehandelt</td> </tr> <tr> <td>enumeration</td> <td>0322099</td> <td>documentation unbekannt</td> </tr> </tbody> </table>	Kind	Value	Annotation	enumeration	0322001	documentation nein	enumeration	0322002	documentation ja, diätetisch behandelt	enumeration	0322003	documentation ja, orale Medikation	enumeration	0322004	documentation ja, mit Insulin behandelt	enumeration	0322005	documentation ja, unbehandelt	enumeration	0322099	documentation unbekannt
Kind	Value	Annotation																				
enumeration	0322001	documentation nein																				
enumeration	0322002	documentation ja, diätetisch behandelt																				
enumeration	0322003	documentation ja, orale Medikation																				
enumeration	0322004	documentation ja, mit Insulin behandelt																				
enumeration	0322005	documentation ja, unbehandelt																				
enumeration	0322099	documentation unbekannt																				
source	<code><element name="PKA_DiabetesSchluessel" type="enum_0322"/></code>																					

element **PatientenaufnahmeKardiologieBasis/PKA_NierenersatzSchluessel**

diagram													
type	enum_0369												
properties	content simple												
facets	<table border="1"> <thead> <tr> <th>Kind</th> <th>Value</th> <th>Annotation</th> </tr> </thead> <tbody> <tr> <td>enumeration</td> <td>0369001</td> <td>documentation nein</td> </tr> <tr> <td>enumeration</td> <td>0369002</td> <td>documentation akut</td> </tr> <tr> <td>enumeration</td> <td>0369003</td> <td>documentation chronisch</td> </tr> </tbody> </table>	Kind	Value	Annotation	enumeration	0369001	documentation nein	enumeration	0369002	documentation akut	enumeration	0369003	documentation chronisch
Kind	Value	Annotation											
enumeration	0369001	documentation nein											
enumeration	0369002	documentation akut											
enumeration	0369003	documentation chronisch											
source	<code><element name="PKA_NierenersatzSchluessel" type="enum_0369"/></code>												

element **PatientenaufnahmeKardiologieBasis/PKA_KreatininwertMgdl**

diagram																
type	Zahl2_1															
properties	content simple															
facets	<table border="1"> <thead> <tr> <th>Kind</th> <th>Value</th> <th>Annotation</th> </tr> </thead> <tbody> <tr> <td>minExclusive</td> <td>0</td> <td></td> </tr> <tr> <td>maxExclusive</td> <td>100</td> <td></td> </tr> <tr> <td>totalDigits</td> <td>2</td> <td></td> </tr> <tr> <td>fractionDigits</td> <td>1</td> <td></td> </tr> </tbody> </table>	Kind	Value	Annotation	minExclusive	0		maxExclusive	100		totalDigits	2		fractionDigits	1	
Kind	Value	Annotation														
minExclusive	0															
maxExclusive	100															
totalDigits	2															
fractionDigits	1															
source	<code><element name="PKA_KreatininwertMgdl" type="Zahl2_1"/></code>															

element **PatientenaufnahmeKardiologieBasis/PKA_KreatininwertMikromol**

diagram										
type	Zahl4									
properties	content simple									
facets	<table border="1"> <thead> <tr> <th>Kind</th> <th>Value</th> <th>Annotation</th> </tr> </thead> <tbody> <tr> <td>minInclusive</td> <td>1</td> <td></td> </tr> <tr> <td>maxInclusive</td> <td>9999</td> <td></td> </tr> </tbody> </table>	Kind	Value	Annotation	minInclusive	1		maxInclusive	9999	
Kind	Value	Annotation								
minInclusive	1									
maxInclusive	9999									
source	<code><element name="PKA_KreatininwertMikromol" type="Zahl4"/></code>									

element **PatientenaufnahmeKardiologieBasis/PKA_KreatininwertUnbekannt**

diagram							
type	JaLeer						
properties	content simple						
facets	<table border="1"> <thead> <tr> <th>Kind</th> <th>Value</th> <th>Annotation</th> </tr> </thead> <tbody> <tr> <td>pattern</td> <td>(1)</td> <td></td> </tr> </tbody> </table>	Kind	Value	Annotation	pattern	(1)	
Kind	Value	Annotation					
pattern	(1)						
source	<code><element name="PKA_KreatininwertUnbekannt" type="JaLeer"/></code>						

complexType PatientenaufnahmeAortenklappe

diagram

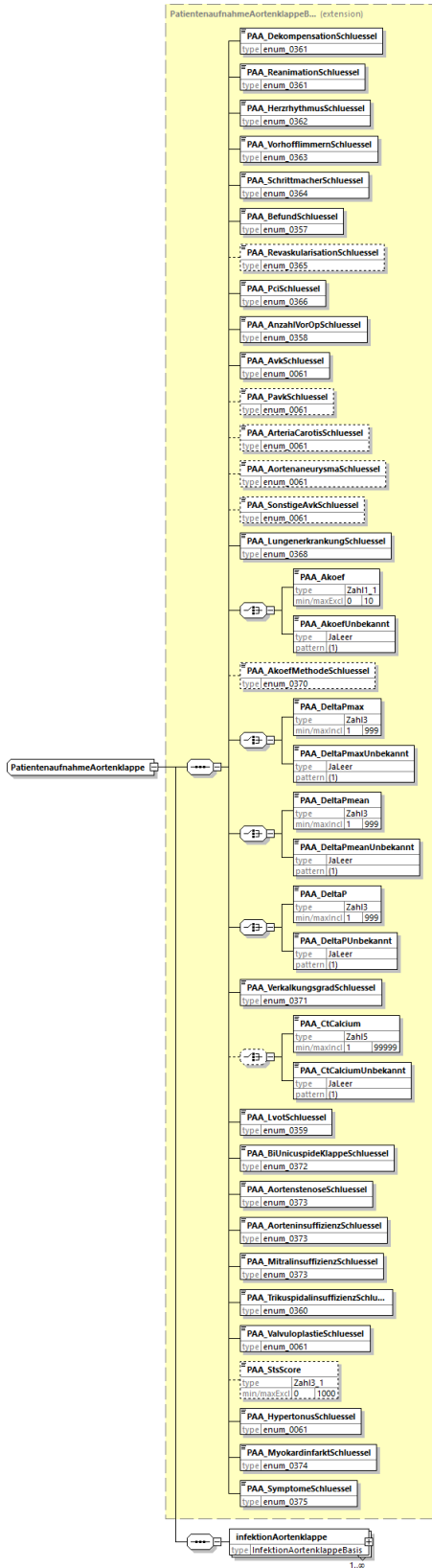

namespace	http://xml.ir-d.de/emg
type	extension of PatientenaufnahmeAortenklappeBasis
properties	base PatientenaufnahmeAortenklappeBasis

children	PAA DekompensationSchluessel PAA ReanimationSchluessel PAA HerzrhythmusSchluessel PAA VorhofflimmernSchluessel PAA SchrittmacherSchluessel PAA BefundSchluessel PAA RevaskularisationSchluessel PAA PciSchluessel PAA AnzahlVorOpSchluessel PAA AvkSchluessel PAA PavkSchluessel PAA ArteriaCarotisSchluessel PAA AortenaneurysmaSchluessel PAA SonstigeAvkSchluessel PAA LungenerkrankungSchluessel PAA Akoef PAA AkoefUnbekannt PAA AkoefMethodeSchluessel PAA DeltaPmax PAA DeltaPmaxUnbekannt PAA DeltaPmean PAA DeltaPmeanUnbekannt PAA DeltaP PAA DeltaPUnbekannt PAA VerkalkungsgradSchluessel PAA CtCalcium PAA CtCalciumUnbekannt PAA LvtotSchluessel PAA BiUnicuspideKlappeSchluessel PAA AortenstenoseSchluessel PAA AorteninsuffizienzSchluessel PAA MitralsuffizienzSchluessel PAA TrikuspidalinsuffizienzSchluessel PAA ValvuloplastieSchluessel PAA StsScore PAA HypertonusSchluessel PAA MyokardinfarktSchluessel PAA SymptomeSchluessel infektionAortenklappe
used by	element PatientenaufnahmeKardiologie/patientenaufnahmeAortenklappe
source	<pre> <complexType name="PatientenaufnahmeAortenklappe"> <complexContent> <extension base="PatientenaufnahmeAortenklappeBasis"> <sequence> <element name="infektionAortenklappe" type="InfektionAortenklappeBasis" maxOccurs="unbounded"/> </sequence> </extension> </complexContent> </complexType> </pre>

element **PatientenaufnahmeAortenklappe/infektionAortenklappe**

diagram	
type	InfektionAortenklappeBasis
properties	minOcc 1 maxOcc unbounded content complex
children	IAK InfektionSchluessel
source	<pre> <element name="infektionAortenklappe" type="InfektionAortenklappeBasis" maxOccurs="unbounded"/> </pre>

complexType **OperationBrustimplantatBasis**

diagram	
namespace	http://xml.ir-d.de/emg
children	OBI ArtEingriffSchluessel OBI GrundPrimaerEingriffSchluessel OBI GrundAustauschSchluessel OBI GrundRevisionExplantationSchluessel OBI LageSchluessel OBI ZugangSchluessel OBI EntfernungAdmNetzSchluessel OBI VerfahrenswechselSchluessel
used by	complexType OperationBrustimplantat
source	<pre> <complexType name="OperationBrustimplantatBasis"> <sequence> <element name="OBI_ArtEingriffSchluessel" type="enum_0100"/> <choice> <element name="OBI_GrundPrimaerEingriffSchluessel" type="enum_0102"/> <element name="OBI_GrundAustauschSchluessel" type="enum_0104"/> <element name="OBI_GrundRevisionExplantationSchluessel" type="enum_0106"/> </choice> <element name="OBI_LageSchluessel" type="enum_0112" minOccurs="0"/> <element name="OBI_ZugangSchluessel" type="enum_0118" minOccurs="0"/> <element name="OBI_EntfernungAdmNetzSchluessel" type="enum_0114" minOccurs="0"/> <element name="OBI_VerfahrenswechselSchluessel" type="enum_0111" minOccurs="0"/> </sequence> </complexType> </pre>

element **OperationBrustimplantatBasis/OBI_ArtEingriffSchluessel**

diagram	
type	enum 0100

properties	content simple		
facets	Kind	Value	Annotation
	enumeration	0100001	documentation Primäreingriff
	enumeration	0100002	documentation Austausch Expander gegen dauerhaftes Brustimplantat
	enumeration	0100003	documentation Revision
	enumeration	0100004	documentation Nur Explantation
source	<code><element name="OBI_ArtEingriffSchluessel" type="enum_0100"/></code>		

element **OperationBrustimplantatBasis/OBI_GrundPrimaerEingriffSchluessel**

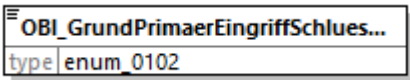
diagram			
type	enum 0102		
properties	content simple		
facets	Kind	Value	Annotation
	enumeration	0102001	documentation kosmetische Augmentation
	enumeration	0102002	documentation Rekonstruktion, benigne
	enumeration	0102003	documentation Rekonstruktion nach Mastektomie aufgrund eines Karzinoms
	enumeration	0102004	documentation Rekonstruktion nach risikoreduzierender Mastektomie
source	<code><element name="OBI_GrundPrimaerEingriffSchluessel" type="enum_0102"/></code>		

element **OperationBrustimplantatBasis/OBI_GrundAustauschSchluessel**

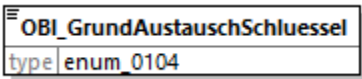
diagram			
type	enum 0104		
properties	content simple		
facets	Kind	Value	Annotation
	enumeration	0104001	documentation Austausch Expander gegen dauerhaftes Brustimplantat
source	<code><element name="OBI_GrundAustauschSchluessel" type="enum_0104"/></code>		

element **OperationBrustimplantatBasis/OBI_GrundRevisionExplantationSchluessel**

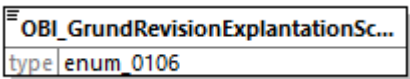
diagram			
type	enum 0106		
properties	content simple		
facets	Kind	Value	Annotation
	enumeration	0106001	documentation

	enumeration 0106002	Patientenwunsch documentation asymptomatisch
	enumeration 0106003	documentation Komplikation
source	<element name="OBI_GrundRevisionExplantationSchluessel" type="enum_0106"/>	

element **OperationBrustimplantatBasis/OBI_LageSchluessel**

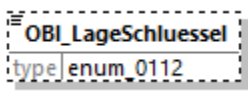
diagram			
type	enum 0112		
properties	minOcc 0 maxOcc 1 content simple		
facets	Kind	Value	Annotation
	enumeration	0112001	documentation subglandulär / epipektoral
	enumeration	0112002	documentation subpektoral
	enumeration	0112003	documentation subfaszial
	enumeration	0112004	documentation sub-flap
	enumeration	0112005	documentation subkutan
	enumeration	0112006	documentation dual plane
	enumeration	0112042	documentation andere
source	<element name="OBI_LageSchluessel" type="enum_0112" minOccurs="0"/>		

element **OperationBrustimplantatBasis/OBI_ZugangSchluessel**

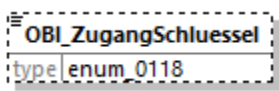
diagram			
type	enum 0118		
properties	minOcc 0 maxOcc 1 content simple		
facets	Kind	Value	Annotation
	enumeration	0118001	documentation axillär
	enumeration	0118002	documentation periareolär
	enumeration	0118003	documentation inframammär
	enumeration	0118004	documentation Mastektomienarbe
	enumeration	0118042	documentation anderer
source	<element name="OBI_ZugangSchluessel" type="enum_0118" minOccurs="0"/>		

element **OperationBrustimplantatBasis/OBI_EntfernungAdmNetzSchluessel**

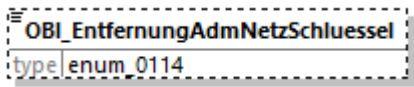
diagram																
type	enum 0114															
properties	minOcc 0 maxOcc 1 content simple															
facets	<table border="1"> <thead> <tr> <th>Kind</th> <th>Value</th> <th>Annotation</th> </tr> </thead> <tbody> <tr> <td>enumeration</td> <td>0114001</td> <td>documentation vollständig</td> </tr> <tr> <td>enumeration</td> <td>0114002</td> <td>documentation nein</td> </tr> <tr> <td>enumeration</td> <td>0114003</td> <td>documentation teilweise</td> </tr> <tr> <td>enumeration</td> <td>0114004</td> <td>documentation nicht vorhanden</td> </tr> </tbody> </table>	Kind	Value	Annotation	enumeration	0114001	documentation vollständig	enumeration	0114002	documentation nein	enumeration	0114003	documentation teilweise	enumeration	0114004	documentation nicht vorhanden
Kind	Value	Annotation														
enumeration	0114001	documentation vollständig														
enumeration	0114002	documentation nein														
enumeration	0114003	documentation teilweise														
enumeration	0114004	documentation nicht vorhanden														
source	<code><element name="OBI_EntfernungAdmNetzSchluessel" type="enum_0114" minOccurs="0"/></code>															

element **OperationBrustimplantatBasis/OBI_VerfahrenswechselSchluessel**

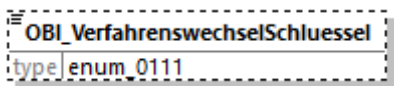
diagram													
type	enum 0111												
properties	minOcc 0 maxOcc 1 content simple												
facets	<table border="1"> <thead> <tr> <th>Kind</th> <th>Value</th> <th>Annotation</th> </tr> </thead> <tbody> <tr> <td>enumeration</td> <td>0111001</td> <td>documentation nein</td> </tr> <tr> <td>enumeration</td> <td>0111002</td> <td>documentation Lipofilling</td> </tr> <tr> <td>enumeration</td> <td>0111003</td> <td>documentation Eigengewebsrekonstruktion</td> </tr> </tbody> </table>	Kind	Value	Annotation	enumeration	0111001	documentation nein	enumeration	0111002	documentation Lipofilling	enumeration	0111003	documentation Eigengewebsrekonstruktion
Kind	Value	Annotation											
enumeration	0111001	documentation nein											
enumeration	0111002	documentation Lipofilling											
enumeration	0111003	documentation Eigengewebsrekonstruktion											
source	<code><element name="OBI_VerfahrenswechselSchluessel" type="enum_0111" minOccurs="0"/></code>												

complexType **VorbehandlungBrustimplantatBasis**

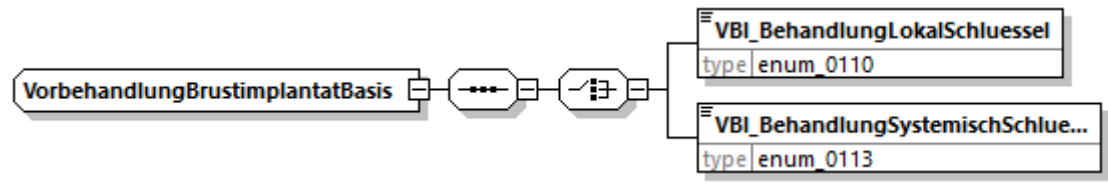
diagram	
namespace	http://xml.ir-d.de/emg
children	VBI_BehandlungLokalSchluessel VBI_BehandlungSystemischSchluessel
used by	element OperationBrustimplantat/vorbehandlungBrustimplantat
source	<code><complexType name="VorbehandlungBrustimplantatBasis"> <sequence></code>

	<pre> <choice> <element name="VBI_BehandlungLokalSchluessel" type="enum_0110"/> <element name="VBI_BehandlungSystemischSchluessel" type="enum_0113"/> </choice> </sequence> </complexType> </pre>
--	---

element **VorbehandlungBrustimplantatBasis/VBI_BehandlungLokalSchluessel**

diagram							
type	enum 0110						
properties	content simple						
facets	<table border="1"> <thead> <tr> <th>Kind</th> <th>Value</th> <th>Annotation</th> </tr> </thead> <tbody> <tr> <td>enumeration</td> <td>0110001</td> <td>documentation Bestrahlung</td> </tr> </tbody> </table>	Kind	Value	Annotation	enumeration	0110001	documentation Bestrahlung
Kind	Value	Annotation					
enumeration	0110001	documentation Bestrahlung					
source	<code><element name="VBI_BehandlungLokalSchluessel" type="enum_0110"/></code>						

element **VorbehandlungBrustimplantatBasis/VBI_BehandlungSystemischSchluessel**

diagram							
type	enum 0113						
properties	content simple						
facets	<table border="1"> <thead> <tr> <th>Kind</th> <th>Value</th> <th>Annotation</th> </tr> </thead> <tbody> <tr> <td>enumeration</td> <td>0113001</td> <td>documentation Chemotherapie innerhalb der letzten drei Monate</td> </tr> </tbody> </table>	Kind	Value	Annotation	enumeration	0113001	documentation Chemotherapie innerhalb der letzten drei Monate
Kind	Value	Annotation					
enumeration	0113001	documentation Chemotherapie innerhalb der letzten drei Monate					
source	<code><element name="VBI_BehandlungSystemischSchluessel" type="enum_0113"/></code>						

complexType **MassnahmeBrustimplantatBasis**

diagram	
namespace	http://xml.ir-d.de/emg
children	MAB_MassnahmeSchluessel
used by	element OperationBrustimplantat/massnahmeBrustimplantat
source	<pre> <complexType name="MassnahmeBrustimplantatBasis"> <sequence> <element name="MAB_MassnahmeSchluessel" type="enum_0116"/> </sequence> </complexType> </pre>

element **MassnahmeBrustimplantatBasis/MAB_MassnahmeSchluessel**

diagram			
type	enum 0116		
properties	content simple		
facets	Kind	Value	Annotation
	enumeration	0116001	documentation Spülung, antibiotisch
	enumeration	0116002	documentation Spülung, antiseptisch
	enumeration	0116003	documentation Spülung, wirkstofffrei
	enumeration	0116004	documentation Spülung, andere
	enumeration	0116005	documentation prä-/perioperative Antibiotika
	enumeration	0116006	documentation postoperative Antibiotika
	enumeration	0116007	documentation Handschuhwechsel vor Implantation
	enumeration	0116008	documentation Implantationshilfe
source	<code><element name="MAB_MassnahmeSchluessel" type="enum_0116"/></code>		

complexType **OperationsdetailBrustimplantatBasis**

diagram			
namespace	http://xml.ir-d.de/emg		
children	ODB_OperationsdetailPrimaerEingriffSchluessel ODB_OperationsdetailAustauschSchluessel ODB_OperationsdetailRevisionSchluessel		
used by	element	OperationBrustimplantat/operationsdetailBrustimplantat	
source	<pre> <complexType name="OperationsdetailBrustimplantatBasis"> <sequence> <choice> <element name="ODB_OperationsdetailPrimaerEingriffSchluessel" type="enum_0103"/> <element name="ODB_OperationsdetailAustauschSchluessel" type="enum_0105"/> <element name="ODB_OperationsdetailRevisionSchluessel" type="enum_0107"/> </choice> </sequence> </complexType> </pre>		

element **OperationsdetailBrustimplantatBasis/ODB_OperationsdetailPrimaerEingriffSchluessel**

diagram			
type	enum 0103		
properties	content simple		
facets	Kind	Value	Annotation
	enumeration	0103001	documentation simultane Lappendeckung
	enumeration	0103002	documentation simultane Eigenfetttransplantation
	enumeration	0103003	documentation simultane Mastopexie
	enumeration	0103005	documentation simultane Mastektomie, Ablatio / hautsparend
	enumeration	0103006	documentation simultane Mastektomie, nippelerhaltend
	enumeration	0103007	documentation Axilla-Dissektion
	enumeration	0103008	documentation Drainage
source	<pre><element name="ODB_OperationsdetailPrimaerEingriffSchluessel" type="enum_0103"/></pre>		

element **OperationsdetailBrustimplantatBasis/ODB_OperationsdetailAustauschSchluessel**

diagram			
type	enum 0105		
properties	content simple		
facets	Kind	Value	Annotation
	enumeration	0105001	documentation simultane Lappendeckung
	enumeration	0105002	documentation simultane Eigenfetttransplantation
	enumeration	0105003	documentation simultane Mastopexie
	enumeration	0105008	documentation Drainage
	enumeration	0105009	documentation Kapsulektomie, komplett
	enumeration	0105010	documentation Kapsulektomie, partiell
	enumeration	0105011	documentation Neopocket
source	<pre><element name="ODB_OperationsdetailAustauschSchluessel" type="enum_0105"/></pre>		

element **OperationsdetailBrustimplantatBasis/ODB_OperationsdetailRevisionSchluessel**

diagram			
type	enum 0107		

properties	content simple		
facets	Kind	Value	Annotation
	enumeration	0107001	documentation simultane Lappendeckung
	enumeration	0107002	documentation simultane Eigenfetttransplantation
	enumeration	0107003	documentation simultane Mastopexie
	enumeration	0107005	documentation simultane Mastektomie, Ablatio / hautsparend
	enumeration	0107006	documentation simultane Mastektomie, nippelerhaltend
	enumeration	0107007	documentation Axilla-Dissektion
	enumeration	0107008	documentation Drainage
	enumeration	0107009	documentation Kapsulektomie, komplett
	enumeration	0107010	documentation Kapsulektomie, partiell
	enumeration	0107011	documentation Neopocket
source	<code><element name="ODB_OperationsdetailRevisionSchluessel" type="enum_0107"/></code>		

complexType **BefundBrustimplantatBasis**

diagram	
namespace	http://xml.ir-d.de/emg
children	BEB_BefundSchluessel BEB_BefundAustauschSchluessel
used by	element OperationBrustimplantat/befundBrustimplantat
source	<pre> <complexType name="BefundBrustimplantatBasis"> <sequence> <choice> <element name="BEB_BefundSchluessel" type="enum_0121"/> <element name="BEB_BefundAustauschSchluessel" type="enum_0120"/> </choice> </sequence> </complexType> </pre>

element **BefundBrustimplantatBasis/BEB_BefundSchluessel**

diagram							
type	enum 0121						
properties	content simple						
facets	<table border="1"> <tr> <td>Kind</td> <td>Value</td> <td>Annotation</td> </tr> <tr> <td>enumeration</td> <td>0121001</td> <td>documentation</td> </tr> </table>	Kind	Value	Annotation	enumeration	0121001	documentation
Kind	Value	Annotation					
enumeration	0121001	documentation					

	enumeration	0121002	Infektion documentation Serom
	enumeration	0121003	documentation Hämatom
	enumeration	0121004	documentation Kapsel fibrose
	enumeration	0121005	documentation Implantatruptur
	enumeration	0121006	documentation Fehlpositionierung/Rotation
	enumeration	0121007	documentation BIA-ALCL/-SCC, Verdacht
	enumeration	0121008	documentation BIA-ALCL/-SCC, pathologisch bestätigt
	enumeration	0121009	documentation Brustschmerzen
	enumeration	0121010	documentation Doppelkapsel
	enumeration	0121011	documentation Netz-/ADM-bedingte Komplikation, Non-Integration
	enumeration	0121012	documentation Netz-/ADM-bedingte Komplikation, andere
	enumeration	0121013	documentation Hautnekrose/exponiertes Implantat
	enumeration	0121014	documentation BII/ASIA (Brustimplantat assoziierte Symptome), Verdacht
	enumeration	0121015	documentation Lymphadenopathie
	enumeration	0121016	documentation Brustkrebs, neu aufgetreten/Rezidiv
source	<code><element name="BEB_BefundSchluessel" type="enum_0121"/></code>		

element **BefundBrustimplantatBasis/BEB_BefundAustauschSchluessel**

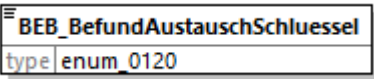
diagram			
type	enum 0120		
properties	content simple		
facets	Kind	Value	Annotation
	enumeration	0120001	documentation Expander defekt
source	<code><element name="BEB_BefundAustauschSchluessel" type="enum_0120"/></code>		

complexType **ProzedurenSchluesselBrustimplantatBasis**

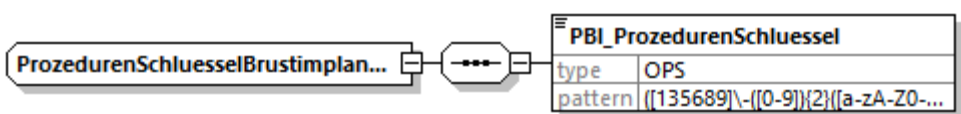
diagram			
namespace	http://xml.ir-d.de/emg		
children	PBI_ProzedurenSchluessel		
used by	element	OperationBrustimplantat/prozedurenSchluesselBrustimplantat	

source	<pre><complexType name="ProzedurenSchluesselBrustimplantatBasis"> <sequence> <element name="PBI_ProzedurenSchluessel" type="OPS"/> </sequence> </complexType></pre>
--------	---

element **ProzedurenSchluesselBrustimplantatBasis/PBI_ProzedurenSchluessel**

diagram							
type	OPS						
properties	content simple						
facets	<table border="1"> <thead> <tr> <th>Kind</th> <th>Value</th> <th>Annotation</th> </tr> </thead> <tbody> <tr> <td>pattern</td> <td>(([135689]\-[0-9]){2}([a-zA-Z0-9]{1}\.[a-zA-Z0-9]{1,2})*(:[RLBrlb])?)</td> <td></td> </tr> </tbody> </table>	Kind	Value	Annotation	pattern	(([135689]\-[0-9]){2}([a-zA-Z0-9]{1}\.[a-zA-Z0-9]{1,2})*(:[RLBrlb])?)	
Kind	Value	Annotation					
pattern	(([135689]\-[0-9]){2}([a-zA-Z0-9]{1}\.[a-zA-Z0-9]{1,2})*(:[RLBrlb])?)						
source	<pre><element name="PBI_ProzedurenSchluessel" type="OPS"/></pre>						

complexType **OperationEndoprotheseBasis**

diagram

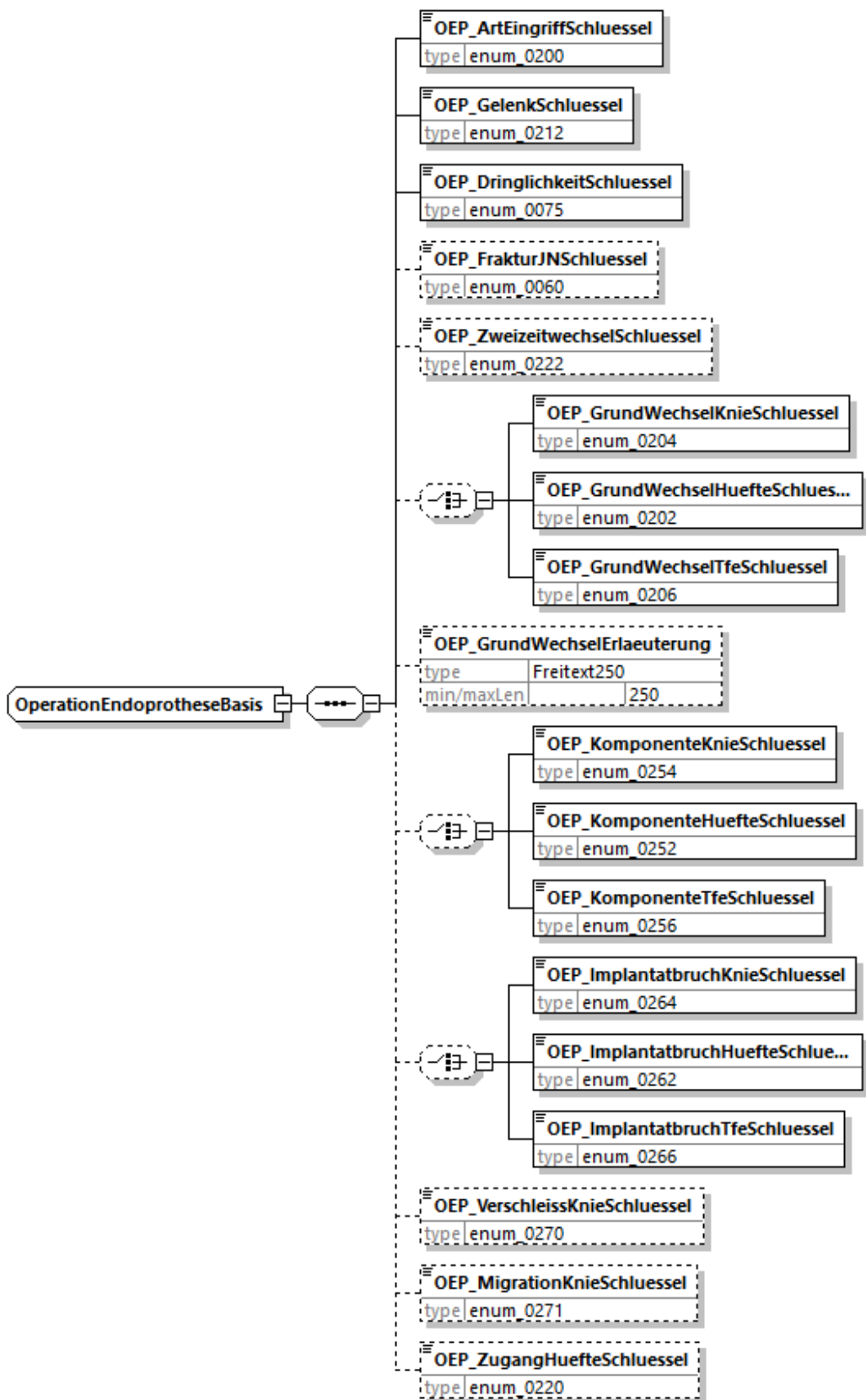

namespace <http://xml.ir-d.de/emg>

children [OEP_ArtEingriffSchluessel](#) [OEP_GelenkSchluessel](#) [OEP_DringlichkeitSchluessel](#) [OEP_FrakturJNSchluessel](#) [OEP_ZweizeitwechselSchluessel](#) [OEP_GrundWechselKnieSchluessel](#) [OEP_GrundWechselHuefteSchluessel](#)

	OEP GrundWechselTfeSchluessel OEP GrundWechselErlaeuterung OEP KomponenteKnieSchluessel OEP KomponenteHuefteSchluessel OEP KomponenteTfeSchluessel OEP ImplantatbruchKnieSchluessel OEP ImplantatbruchHuefteSchluessel OEP ImplantatbruchTfeSchluessel OEP VerschleissKnieSchluessel OEP MigrationKnieSchluessel OEP ZugangHuefteSchluessel
used by	complexType OperationEndoprothese
source	<pre> <complexType name="OperationEndoprotheseBasis"> <sequence> <element name="OEP_ArtEingriffSchluessel" type="enum_0200"/> <element name="OEP_GelenkSchluessel" type="enum_0212"/> <element name="OEP_DringlichkeitSchluessel" type="enum_0075"/> <element name="OEP_FrakturJNSchluessel" type="enum_0060" minOccurs="0"/> <element name="OEP_ZweizeitwechselSchluessel" type="enum_0222" minOccurs="0"/> <choice minOccurs="0"> <element name="OEP_GrundWechselKnieSchluessel" type="enum_0204"/> <element name="OEP_GrundWechselHuefteSchluessel" type="enum_0202"/> <element name="OEP_GrundWechselTfeSchluessel" type="enum_0206"/> </choice> <element name="OEP_GrundWechselErlaeuterung" type="Freitext250" minOccurs="0"/> <choice minOccurs="0"> <element name="OEP_KomponenteKnieSchluessel" type="enum_0254"/> <element name="OEP_KomponenteHuefteSchluessel" type="enum_0252"/> <element name="OEP_KomponenteTfeSchluessel" type="enum_0256"/> </choice> <choice minOccurs="0"> <element name="OEP_ImplantatbruchKnieSchluessel" type="enum_0264"/> <element name="OEP_ImplantatbruchHuefteSchluessel" type="enum_0262"/> <element name="OEP_ImplantatbruchTfeSchluessel" type="enum_0266"/> </choice> <element name="OEP_VerschleissKnieSchluessel" type="enum_0270" minOccurs="0"/> <element name="OEP_MigrationKnieSchluessel" type="enum_0271" minOccurs="0"/> <element name="OEP_ZugangHuefteSchluessel" type="enum_0220" minOccurs="0"/> </sequence> </complexType> </pre>

element **OperationEndoprotheseBasis/OEP_ArtEingriffSchluessel**

diagram										
type	enum 0200									
properties	content simple									
facets	<table border="1"> <thead> <tr> <th>Kind</th> <th>Value</th> <th>Annotation</th> </tr> </thead> <tbody> <tr> <td>enumeration</td> <td>0200001</td> <td>documentation Erst-OP</td> </tr> <tr> <td>enumeration</td> <td>0200002</td> <td>documentation Folgeeingriff</td> </tr> </tbody> </table>	Kind	Value	Annotation	enumeration	0200001	documentation Erst-OP	enumeration	0200002	documentation Folgeeingriff
Kind	Value	Annotation								
enumeration	0200001	documentation Erst-OP								
enumeration	0200002	documentation Folgeeingriff								
source	<pre><element name="OEP_ArtEingriffSchluessel" type="enum_0200"/></pre>									

element **OperationEndoprotheseBasis/OEP_GelenkSchluessel**

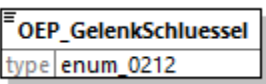
diagram													
type	enum_0212												
properties	content simple												
facets	<table border="1"> <thead> <tr> <th>Kind</th> <th>Value</th> <th>Annotation</th> </tr> </thead> <tbody> <tr> <td>enumeration</td> <td>0212001</td> <td>documentation Hüfte</td> </tr> <tr> <td>enumeration</td> <td>0212002</td> <td>documentation Knie</td> </tr> <tr> <td>enumeration</td> <td>0212003</td> <td>documentation Totaler Femurersatz inkl. Durchsteck-Prothese</td> </tr> </tbody> </table>	Kind	Value	Annotation	enumeration	0212001	documentation Hüfte	enumeration	0212002	documentation Knie	enumeration	0212003	documentation Totaler Femurersatz inkl. Durchsteck-Prothese
Kind	Value	Annotation											
enumeration	0212001	documentation Hüfte											
enumeration	0212002	documentation Knie											
enumeration	0212003	documentation Totaler Femurersatz inkl. Durchsteck-Prothese											
source	<code><element name="OEP_GelenkSchluessel" type="enum_0212"/></code>												

element **OperationEndoprotheseBasis/OEP_DringlichkeitSchluessel**

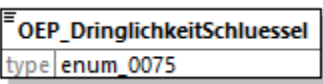
diagram													
type	enum_0075												
properties	content simple												
facets	<table border="1"> <thead> <tr> <th>Kind</th> <th>Value</th> <th>Annotation</th> </tr> </thead> <tbody> <tr> <td>enumeration</td> <td>0075001</td> <td>documentation elektiv</td> </tr> <tr> <td>enumeration</td> <td>0075002</td> <td>documentation dringlich</td> </tr> <tr> <td>enumeration</td> <td>0075003</td> <td>documentation Notfall</td> </tr> </tbody> </table>	Kind	Value	Annotation	enumeration	0075001	documentation elektiv	enumeration	0075002	documentation dringlich	enumeration	0075003	documentation Notfall
Kind	Value	Annotation											
enumeration	0075001	documentation elektiv											
enumeration	0075002	documentation dringlich											
enumeration	0075003	documentation Notfall											
source	<code><element name="OEP_DringlichkeitSchluessel" type="enum_0075"/></code>												

element **OperationEndoprotheseBasis/OEP_FrakturJNSchluessel**

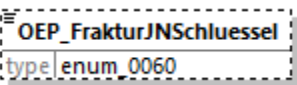
diagram										
type	enum_0060									
properties	minOcc 0 maxOcc 1 content simple									
facets	<table border="1"> <thead> <tr> <th>Kind</th> <th>Value</th> <th>Annotation</th> </tr> </thead> <tbody> <tr> <td>enumeration</td> <td>0060001</td> <td>documentation ja</td> </tr> <tr> <td>enumeration</td> <td>0060002</td> <td>documentation nein</td> </tr> </tbody> </table>	Kind	Value	Annotation	enumeration	0060001	documentation ja	enumeration	0060002	documentation nein
Kind	Value	Annotation								
enumeration	0060001	documentation ja								
enumeration	0060002	documentation nein								
source	<code><element name="OEP_FrakturJNSchluessel" type="enum_0060" minOccurs="0"/></code>									

element **OperationEndoprotheseBasis/OEP_ZweizeitwechselSchluessel**

diagram													
type	enum 0222												
properties	minOcc 0 maxOcc 1 content simple												
facets	<table border="1"> <thead> <tr> <th>Kind</th> <th>Value</th> <th>Annotation</th> </tr> </thead> <tbody> <tr> <td>enumeration</td> <td>0222001</td> <td>documentation nein</td> </tr> <tr> <td>enumeration</td> <td>0222002</td> <td>documentation ja- Ausbau</td> </tr> <tr> <td>enumeration</td> <td>0222003</td> <td>documentation ja- Einbau</td> </tr> </tbody> </table>	Kind	Value	Annotation	enumeration	0222001	documentation nein	enumeration	0222002	documentation ja- Ausbau	enumeration	0222003	documentation ja- Einbau
Kind	Value	Annotation											
enumeration	0222001	documentation nein											
enumeration	0222002	documentation ja- Ausbau											
enumeration	0222003	documentation ja- Einbau											
source	<code><element name="OEP_ZweizeitwechselSchluessel" type="enum_0222" minOccurs="0"/></code>												

element **OperationEndoprotheseBasis/OEP_GrundWechselKnieSchluessel**

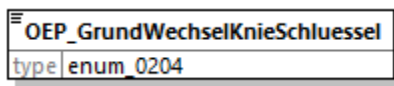
diagram																																																				
type	enum 0204																																																			
properties	content simple																																																			
facets	<table border="1"> <thead> <tr> <th>Kind</th> <th>Value</th> <th>Annotation</th> </tr> </thead> <tbody> <tr> <td>enumeration</td> <td>0204001</td> <td>documentation Lockerung</td> </tr> <tr> <td>enumeration</td> <td>0204002</td> <td>documentation Infektion, Verdacht auf</td> </tr> <tr> <td>enumeration</td> <td>0204003</td> <td>documentation Infektion, gesichert</td> </tr> <tr> <td>enumeration</td> <td>0204006</td> <td>documentation Periprothetische Fraktur</td> </tr> <tr> <td>enumeration</td> <td>0204007</td> <td>documentation Verschleiß</td> </tr> <tr> <td>enumeration</td> <td>0204008</td> <td>documentation Implantatbruch</td> </tr> <tr> <td>enumeration</td> <td>0204009</td> <td>documentation Implantatfehlage/Malalignent</td> </tr> <tr> <td>enumeration</td> <td>0204010</td> <td>documentation Osteolysen bei festem Implantat</td> </tr> <tr> <td>enumeration</td> <td>0204011</td> <td>documentation Progression der Grunderkrankung</td> </tr> <tr> <td>enumeration</td> <td>0204012</td> <td>documentation ARMD</td> </tr> <tr> <td>enumeration</td> <td>0204013</td> <td>documentation Verdacht auf allergische Reaktion</td> </tr> <tr> <td>enumeration</td> <td>0204014</td> <td>documentation Dislokation/Migration von Komponenten</td> </tr> <tr> <td>enumeration</td> <td>0204015</td> <td>documentation Bandinstabilität</td> </tr> <tr> <td>enumeration</td> <td>0204016</td> <td>documentation Bewegungseinschränkung</td> </tr> <tr> <td>enumeration</td> <td>0204021</td> <td>documentation Zustand nach Prothesenentfernung</td> </tr> <tr> <td>enumeration</td> <td>0204042</td> <td>documentation andere Gründe</td> </tr> </tbody> </table>	Kind	Value	Annotation	enumeration	0204001	documentation Lockerung	enumeration	0204002	documentation Infektion, Verdacht auf	enumeration	0204003	documentation Infektion, gesichert	enumeration	0204006	documentation Periprothetische Fraktur	enumeration	0204007	documentation Verschleiß	enumeration	0204008	documentation Implantatbruch	enumeration	0204009	documentation Implantatfehlage/Malalignent	enumeration	0204010	documentation Osteolysen bei festem Implantat	enumeration	0204011	documentation Progression der Grunderkrankung	enumeration	0204012	documentation ARMD	enumeration	0204013	documentation Verdacht auf allergische Reaktion	enumeration	0204014	documentation Dislokation/Migration von Komponenten	enumeration	0204015	documentation Bandinstabilität	enumeration	0204016	documentation Bewegungseinschränkung	enumeration	0204021	documentation Zustand nach Prothesenentfernung	enumeration	0204042	documentation andere Gründe
Kind	Value	Annotation																																																		
enumeration	0204001	documentation Lockerung																																																		
enumeration	0204002	documentation Infektion, Verdacht auf																																																		
enumeration	0204003	documentation Infektion, gesichert																																																		
enumeration	0204006	documentation Periprothetische Fraktur																																																		
enumeration	0204007	documentation Verschleiß																																																		
enumeration	0204008	documentation Implantatbruch																																																		
enumeration	0204009	documentation Implantatfehlage/Malalignent																																																		
enumeration	0204010	documentation Osteolysen bei festem Implantat																																																		
enumeration	0204011	documentation Progression der Grunderkrankung																																																		
enumeration	0204012	documentation ARMD																																																		
enumeration	0204013	documentation Verdacht auf allergische Reaktion																																																		
enumeration	0204014	documentation Dislokation/Migration von Komponenten																																																		
enumeration	0204015	documentation Bandinstabilität																																																		
enumeration	0204016	documentation Bewegungseinschränkung																																																		
enumeration	0204021	documentation Zustand nach Prothesenentfernung																																																		
enumeration	0204042	documentation andere Gründe																																																		

source	<element name="OEP_GrundWechselKnieSchluessel" type="enum_0204"/>
--------	---

element **OperationEndoprotheseBasis/OEP_GrundWechselHuefteSchluessel**

diagram			
type	enum 0202		
properties	content simple		
facets	Kind	Value	Annotation
	enumeration	0202001	documentation Lockerung
	enumeration	0202002	documentation Infektion, Verdacht auf
	enumeration	0202003	documentation Infektion, gesichert
	enumeration	0202004	documentation Luxation, Inlay aus der Pfanne
	enumeration	0202005	documentation Luxation, Kopf aus Pfanne/Inlay
	enumeration	0202006	documentation Periprothetische Fraktur
	enumeration	0202007	documentation Verschleiß des PE-Inlays
	enumeration	0202008	documentation Implantatbruch
	enumeration	0202009	documentation Implantatfehlage/Malalignent
	enumeration	0202010	documentation Osteolysen bei festem Implantat
	enumeration	0202011	documentation Progression der Grunderkrankung
	enumeration	0202012	documentation ARMD
	enumeration	0202013	documentation Verdacht auf allergische Reaktion
	enumeration	0202021	documentation Zustand nach Prothesenentfernung
	enumeration	0202042	documentation andere Gründe
source	<element name="OEP_GrundWechselHuefteSchluessel" type="enum_0202"/>		

element **OperationEndoprotheseBasis/OEP_GrundWechselTfeSchluessel**

diagram			
type	enum 0206		
properties	content simple		
facets	Kind	Value	Annotation
	enumeration	0206001	documentation Lockerung
	enumeration	0206002	documentation Infektion, Verdacht auf
	enumeration	0206003	documentation Infektion, gesichert

	enumeration	0206004	documentation Luxation, Inlay aus der Pfanne
	enumeration	0206005	documentation Luxation, Kopf aus Pfanne/Inlay
	enumeration	0206006	documentation Periprothetische Fraktur
	enumeration	0206007	documentation Verschleiß
	enumeration	0206008	documentation Implantatbruch
	enumeration	0206009	documentation Implantatfehlage/Malalignent
	enumeration	0206010	documentation Osteolysen bei festem Implantat
	enumeration	0206011	documentation Progression der Grunderkrankung
	enumeration	0206012	documentation ARMD
	enumeration	0206013	documentation Verdacht auf allergische Reaktion
	enumeration	0206014	documentation Dislokation/Migration von Komponenten
	enumeration	0206015	documentation Bandinstabilität
	enumeration	0206016	documentation Bewegungseinschränkung
	enumeration	0206021	documentation Zustand nach Prothesenentfernung
	enumeration	0206042	documentation andere Gründe
source	<code><element name="OEP_GrundWechselTfSchlüssel" type="enum_0206"/></code>		

element **OperationEndoprotheseBasis/OEP_GrundWechselErlaeuterung**

diagram			
type	Freitext250		
properties	minOcc	0	
	maxOcc	1	
	content	simple	
facets	Kind	Value	Annotation
	maxLength	250	
source	<code><element name="OEP_GrundWechselErlaeuterung" type="Freitext250" minOccurs="0"/></code>		

element **OperationEndoprotheseBasis/OEP_KomponenteKnieSchlüssel**

diagram			
type	enum_0254		
properties	content	simple	
facets	Kind	Value	Annotation
	enumeration	0254001	documentation Femur

	enumeration	0254002	documentation Tibia
	enumeration	0254003	documentation Patella
	enumeration	0254004	documentation mehrere
source	<code><element name="OEP_KomponenteKnieSchluessel" type="enum_0254"/></code>		

element **OperationEndoprotheseBasis/OEP_KomponenteHuefteSchluessel**

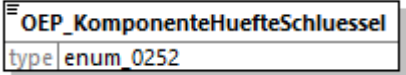
diagram			
type	enum 0252		
properties	content simple		
facets	Kind	Value	Annotation
	enumeration	0252001	documentation Pfanne
	enumeration	0252002	documentation Schaft
	enumeration	0252003	documentation beides
source	<code><element name="OEP_KomponenteHuefteSchluessel" type="enum_0252"/></code>		

element **OperationEndoprotheseBasis/OEP_KomponenteTfeSchluessel**

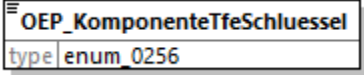
diagram			
type	enum 0256		
properties	content simple		
facets	Kind	Value	Annotation
	enumeration	0256001	documentation Pfanne
	enumeration	0256002	documentation Schaft
	enumeration	0256003	documentation Pfanne und Schaft
	enumeration	0256004	documentation Femur
	enumeration	0256005	documentation Tibia
	enumeration	0256006	documentation Patella
	enumeration	0256007	documentation mehrere
source	<code><element name="OEP_KomponenteTfeSchluessel" type="enum_0256"/></code>		

element **OperationEndoprotheseBasis/OEP_ImplantatbruchKnieSchluessel**

diagram			
---------	---	--	--

type	enum_0264		
properties	content simple		
facets	Kind	Value	Annotation
	enumeration	0264001	documentation Femur
	enumeration	0264002	documentation Tibia
	enumeration	0264003	documentation Inlay
	enumeration	0264004	documentation Adapter
	enumeration	0264005	documentation Verlängerung
	enumeration	0264006	documentation Schrauben
	enumeration	0264007	documentation mehrere
	enumeration	0264042	documentation andere
source	<code><element name="OEP_ImplantatbruchKnieSchluessel" type="enum_0264"/></code>		

element **OperationEndoprotheseBasis/OEP_ImplantatbruchHuefteSchluessel**

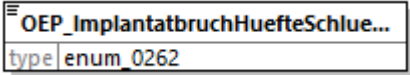
diagram			
type	enum_0262		
properties	content simple		
facets	Kind	Value	Annotation
	enumeration	0262001	documentation Pfanne
	enumeration	0262002	documentation Schaft
	enumeration	0262003	documentation Kopf
	enumeration	0262004	documentation Inlay
	enumeration	0262005	documentation Adapter
	enumeration	0262006	documentation mehrere
source	<code><element name="OEP_ImplantatbruchHuefteSchluessel" type="enum_0262"/></code>		

element **OperationEndoprotheseBasis/OEP_ImplantatbruchTfeSchluessel**

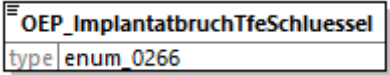
diagram			
type	enum_0266		
properties	content simple		
facets	Kind	Value	Annotation
	enumeration	0266001	documentation Pfanne
	enumeration	0266002	documentation

	enumeration	0266003	Schaft documentation
	enumeration	0266004	Kopf documentation
	enumeration	0266005	Inlay documentation
	enumeration	0266006	Adapter documentation
	enumeration	0266007	Femur documentation
	enumeration	0266008	Tibia documentation
	enumeration	0266009	Verlängerung documentation
	enumeration	0266010	Schrauben documentation
	enumeration	0266042	mehrere documentation andere
source	<code><element name="OEP_ImplantatbruchTfeSchluessel" type="enum_0266"/></code>		

element **OperationEndoprotheseBasis/OEP_VerschleissKnieSchluessel**

diagram			
type	enum 0270		
properties	minOcc	0	
	maxOcc	1	
	content	simple	
facets	Kind	Value	Annotation
	enumeration	0270001	documentation PE-Inlay
	enumeration	0270002	documentation patellare Komponente
	enumeration	0270003	documentation beides
source	<code><element name="OEP_VerschleissKnieSchluessel" type="enum_0270" minOccurs="0"/></code>		

element **OperationEndoprotheseBasis/OEP_MigrationKnieSchluessel**

diagram			
type	enum 0271		
properties	minOcc	0	
	maxOcc	1	
	content	simple	
facets	Kind	Value	Annotation
	enumeration	0271001	documentation Schraube
	enumeration	0271002	documentation Inlay
	enumeration	0271003	documentation patellare Komponente
	enumeration	0271004	documentation Kopplung

	enumeration 0271005	documentation mehrere
	enumeration 0271042	documentation andere
source	<code><element name="OEP_MigrationKnieSchluessel" type="enum_0271" minOccurs="0"/></code>	

element **OperationEndoprotheseBasis/OEP_ZugangHuefteSchluessel**

diagram			
type	enum 0220		
properties	minOcc	0	
	maxOcc	1	
	content	simple	
facets	Kind	Value	Annotation
	enumeration	0220001	documentation anterior
	enumeration	0220002	documentation anterolateral
	enumeration	0220003	documentation lateral
	enumeration	0220004	documentation posterior
	enumeration	0220005	documentation posterolateral
	enumeration	0220006	documentation 2-Inzisionen-Zugang
	enumeration	0220042	documentation sonstiges/unbekannt
source	<code><element name="OEP_ZugangHuefteSchluessel" type="enum_0220" minOccurs="0"/></code>		

complexType **VorbehandlungEndoprotheseBasis**

diagram			
namespace	http://xml.ir-d.de/emg		
children	VEP_VorOpKnieSchluessel VEP_VorOpHuefteSchluessel VEP_VorOpErlaeuterung		
used by	element	OperationEndoprothese/vorbehandlungEndoprothese	
source	<pre> <complexType name="VorbehandlungEndoprotheseBasis"> <sequence> <choice minOccurs="0"> <element name="VEP_VorOpKnieSchluessel" type="enum_0211"/> <element name="VEP_VorOpHuefteSchluessel" type="enum_0210"/> </choice> <element name="VEP_VorOpErlaeuterung" type="Freitext250" minOccurs="0"/> </sequence> </pre>		

```

</sequence>
</complexType>

```

element **VorbehandlungEndoprotheseBasis/VEP_VorOpKnieSchluessel**

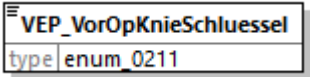
diagram			
type	enum 0211		
properties	content simple		
facets	Kind	Value	Annotation
	enumeration	0211001	documentation keine relevante Voroperation
	enumeration	0211002	documentation Osteosynthese/Osteotomie (Femur)
	enumeration	0211003	documentation Osteosynthese/Osteotomie (Tibia)
	enumeration	0211004	documentation Osteosynthese/Osteotomie (Patella)
	enumeration	0211005	documentation Osteosynthese/Osteotomie (mehrere)
	enumeration	0211006	documentation Kapsel-/Bandapparat
	enumeration	0211007	documentation Arthrodese
	enumeration	0211042	documentation andere
source	<code><element name="VEP_VorOpKnieSchluessel" type="enum_0211"/></code>		

element **VorbehandlungEndoprotheseBasis/VEP_VorOpHuefteSchluessel**

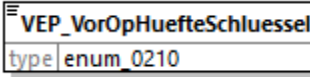
diagram			
type	enum 0210		
properties	content simple		
facets	Kind	Value	Annotation
	enumeration	0210001	documentation keine relevante Voroperation
	enumeration	0210002	documentation Osteosynthese/Osteotomie (Becken)
	enumeration	0210003	documentation Osteosynthese/Osteotomie (Femur)
	enumeration	0210004	documentation Osteosynthese/Osteotomie (beides)
	enumeration	0210005	documentation Operation bei Hüftkopfnekrose
	enumeration	0210006	documentation Arthrodese
	enumeration	0210042	documentation andere
source	<code><element name="VEP_VorOpHuefteSchluessel" type="enum_0210"/></code>		

element **VorbehandlungEndoprotheseBasis/VEP_VorOpErlaeuterung**

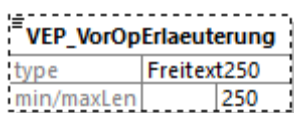
diagram	
type	Freitext250
properties	minOcc 0 maxOcc 1 content simple
facets	Kind Value Annotation maxLength 250
source	<code><element name="VEP_VorOpErlaeuterung" type="Freitext250" minOccurs="0"/></code>

complexType **ProzedurenSchluesselEndoprotheseBasis**

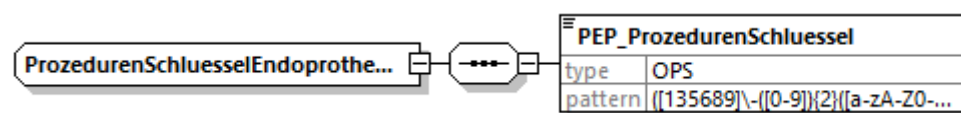
diagram	
namespace	http://xml.ir-d.de/emg
children	PEP_ProzedurenSchluessel
used by	element OperationEndoprothese/prozedurenSchluesselEndoprothese
source	<code><complexType name="ProzedurenSchluesselEndoprotheseBasis"> <sequence> <element name="PEP_ProzedurenSchluessel" type="OPS"/> </sequence> </complexType></code>

element **ProzedurenSchluesselEndoprotheseBasis/PEP_ProzedurenSchluessel**

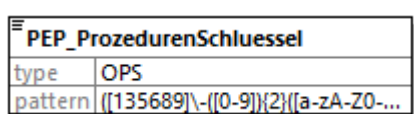
diagram	
type	OPS
properties	content simple
facets	Kind Value Annotation pattern (([135689]\-([0-9]){2})([a-zA-Z0-9]){1}\.([a-zA-Z0-9]{1,2}))*(:[RLBrlb])?
source	<code><element name="PEP_ProzedurenSchluessel" type="OPS"/></code>

complexType OperationAortenklappeBasis

diagram

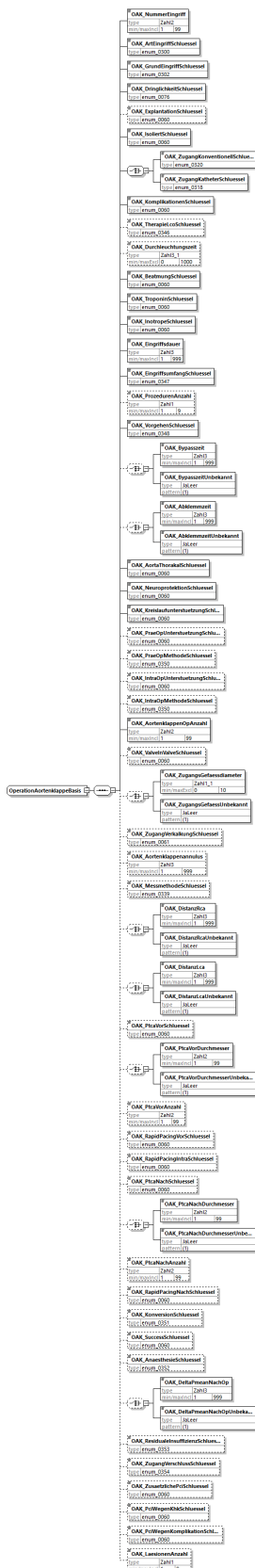

namespace	http://xml.ir-d.de/emg
children	OAK NummerEingriff OAK ArtEingriffSchlüssel OAK GrundEingriffSchlüssel OAK DringlichkeitSchlüssel OAK ExplantationSchlüssel OAK IsoliertSchlüssel OAK ZugangKonventionellSchlüssel

	<p> OAK ZugangKatheterSchluessel OAK KomplikationenSchluessel OAK TherapieLcoSchluessel OAK Durchleuchtungszeit OAK BeatmungSchluessel OAK TroponinSchluessel OAK InotropeSchluessel OAK Eingriffsdauer OAK EingriffsumfangSchluessel OAK ProzedurenAnzahl OAK VorgehenSchluessel OAK Bypasszeit OAK BypasszeitUnbekannt OAK Abklemmzeit OAK AbklemmzeitUnbekannt OAK AortaThorakalSchluessel OAK NeuroprotektionSchluessel OAK KreislaufunterstuetzungSchluessel OAK PraeOpUnterstuetzungSchluessel OAK PraeOpMethodeSchluessel OAK IntraOpUnterstuetzungSchluessel OAK IntraOpMethodeSchluessel OAK AortenklappenOpAnzahl OAK ValvelnValveSchluessel OAK ZugangsGefaessdiameter OAK ZugangsGefaessUnbekannt OAK ZugangVerkalkungSchluessel OAK Aortenklappenannulus OAK MessmethodeSchluessel OAK DistanzRca OAK DistanzRcaUnbekannt OAK DistanzLca OAK DistanzLcaUnbekannt OAK PtcaVorSchluessel OAK PtcaVorDurchmesser OAK PtcaVorDurchmesserUnbekannt OAK PtcaVorAnzahl OAK RapidPacingVorSchluessel OAK RapidPacingIntraSchluessel OAK PtcaNachSchluessel OAK PtcaNachDurchmesser OAK PtcaNachDurchmesserUnbekannt OAK PtcaNachAnzahl OAK RapidPacingNachSchluessel OAK KonversionSchluessel OAK SuccessSchluessel OAK AnaesthesieSchluessel OAK DeltaPmeanNachOp OAK DeltaPmeanNachOpUnbekannt OAK ResidualeinsuffizienzSchluessel OAK ZugangVerschlussSchluessel OAK ZusaetzlichePciSchluessel OAK PciWegenKhkSchluessel OAK PciWegenKomplikationSchluessel OAK LaesionenAnzahl </p>
used by	<p>complexType OperationAortenklappe</p>
source	<pre> <complexType name="OperationAortenklappeBasis"> <sequence> <element name="OAK_NummerEingriff" type="Zahl2"/> <element name="OAK_ArtEingriffSchluessel" type="enum_0300"/> <element name="OAK_GrundEingriffSchluessel" type="enum_0302"/> <element name="OAK_DringlichkeitSchluessel" type="enum_0076"/> <element name="OAK_ExplantationSchluessel" type="enum_0060" minOccurs="0"/> <element name="OAK_IsoliertSchluessel" type="enum_0060"/> <choice> <element name="OAK_ZugangKonventionellSchluessel" type="enum_0320"/> <element name="OAK_ZugangKatheterSchluessel" type="enum_0318"/> </choice> <element name="OAK_KomplikationenSchluessel" type="enum_0060"/> <element name="OAK_TherapieLcoSchluessel" type="enum_0346" minOccurs="0"/> <element name="OAK_Durchleuchtungszeit" type="Zahl3_1" minOccurs="0"/> <element name="OAK_BeatmungSchluessel" type="enum_0060"/> <element name="OAK_TroponinSchluessel" type="enum_0060"/> <element name="OAK_InotropeSchluessel" type="enum_0060"/> <element name="OAK_Eingriffsdauer" type="Zahl3"/> <element name="OAK_EingriffsumfangSchluessel" type="enum_0347"/> <element name="OAK_ProzedurenAnzahl" type="Zahl1" minOccurs="0"/> <element name="OAK_VorgehenSchluessel" type="enum_0348"/> <choice minOccurs="0"> <element name="OAK_Bypasszeit" type="Zahl3"/> <element name="OAK_BypasszeitUnbekannt" type="JaLeer"/> </choice> <choice minOccurs="0"> <element name="OAK_Abklemmzeit" type="Zahl3"/> <element name="OAK_AbklemmzeitUnbekannt" type="JaLeer"/> </choice> <element name="OAK_AortaThorakalSchluessel" type="enum_0060"/> <element name="OAK_NeuroprotektionSchluessel" type="enum_0060"/> <element name="OAK_KreislaufunterstuetzungSchluessel" type="enum_0060"/> <element name="OAK_PraeOpUnterstuetzungSchluessel" type="enum_0060" minOccurs="0"/> <element name="OAK_PraeOpMethodeSchluessel" type="enum_0350" minOccurs="0"/> <element name="OAK_IntraOpUnterstuetzungSchluessel" type="enum_0060" minOccurs="0"/> <element name="OAK_IntraOpMethodeSchluessel" type="enum_0350" </pre>

```

minOccurs="0"/>
  <element name="OAK_AortenklappenOpAnzahl" type="Zahl2"/>
  <element name="OAK_ValveInValveSchluessel" type="enum_0060"
minOccurs="0"/>
  <choice minOccurs="0">
    <element name="OAK_ZugangsGefaessdiameter" type="Zahl1_1"/>
    <element name="OAK_ZugangsGefaessUnbekannt" type="JaLeer"/>
  </choice>
  <element name="OAK_ZugangVerkalkungSchluessel" type="enum_0061"
minOccurs="0"/>
  <element name="OAK_Aortenklappenannulus" type="Zahl3" minOccurs="0"/>
  <element name="OAK_MessmethodeSchluessel" type="enum_0339" minOccurs="0"/>
  <choice minOccurs="0">
    <element name="OAK_DistanzRca" type="Zahl3"/>
    <element name="OAK_DistanzRcaUnbekannt" type="JaLeer"/>
  </choice>
  <choice minOccurs="0">
    <element name="OAK_DistanzLca" type="Zahl3"/>
    <element name="OAK_DistanzLcaUnbekannt" type="JaLeer"/>
  </choice>
  <element name="OAK_PtcaVorSchluessel" type="enum_0060" minOccurs="0"/>
  <choice minOccurs="0">
    <element name="OAK_PtcaVorDurchmesser" type="Zahl2"/>
    <element name="OAK_PtcaVorDurchmesserUnbekannt" type="JaLeer"/>
  </choice>
  <element name="OAK_PtcaVorAnzahl" type="Zahl2" minOccurs="0"/>
  <element name="OAK_RapidPacingVorSchluessel" type="enum_0060"
minOccurs="0"/>
  <element name="OAK_RapidPacingIntraSchluessel" type="enum_0060"
minOccurs="0"/>
  <element name="OAK_PtcaNachSchluessel" type="enum_0060" minOccurs="0"/>
  <choice minOccurs="0">
    <element name="OAK_PtcaNachDurchmesser" type="Zahl2"/>
    <element name="OAK_PtcaNachDurchmesserUnbekannt" type="JaLeer"/>
  </choice>
  <element name="OAK_PtcaNachAnzahl" type="Zahl2" minOccurs="0"/>
  <element name="OAK_RapidPacingNachSchluessel" type="enum_0060"
minOccurs="0"/>
  <element name="OAK_KonversionSchluessel" type="enum_0351" minOccurs="0"/>
  <element name="OAK_SuccessSchluessel" type="enum_0060" minOccurs="0"/>
  <element name="OAK_AnaesthesieSchluessel" type="enum_0352" minOccurs="0"/>
  <choice minOccurs="0">
    <element name="OAK_DeltaPmeanNachOp" type="Zahl3"/>
    <element name="OAK_DeltaPmeanNachOpUnbekannt" type="JaLeer"/>
  </choice>
  <element name="OAK_ResidualeInsuffizienzSchluessel" type="enum_0353"
minOccurs="0"/>
  <element name="OAK_ZugangVerschlussSchluessel" type="enum_0354"
minOccurs="0"/>
  <element name="OAK_ZusaetzlichePciSchluessel" type="enum_0060"
minOccurs="0"/>
  <element name="OAK_PciWegenKhkSchluessel" type="enum_0060" minOccurs="0"/>
  <element name="OAK_PciWegenKomplikationSchluessel" type="enum_0060"
minOccurs="0"/>
  <element name="OAK_LaesionenAnzahl" type="Zahl1" minOccurs="0"/>
</sequence>
</complexType>

```

element **OperationAortenklappeBasis/OAK_NummerEingriff**

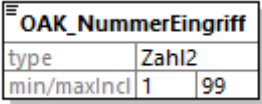
diagram										
type	Zahl2									
properties	content simple									
facets	<table border="1"> <thead> <tr> <th>Kind</th> <th>Value</th> <th>Annotation</th> </tr> </thead> <tbody> <tr> <td>minInclusive</td> <td>1</td> <td></td> </tr> <tr> <td>maxInclusive</td> <td>99</td> <td></td> </tr> </tbody> </table>	Kind	Value	Annotation	minInclusive	1		maxInclusive	99	
Kind	Value	Annotation								
minInclusive	1									
maxInclusive	99									
source	<code><element name="OAK_NummerEingriff" type="Zahl2"/></code>									

element **OperationAortenklappeBasis/OAK_ArtEingriffSchluessel**

diagram										
type	enum_0300									
properties	content simple									
facets	<table border="1"> <thead> <tr> <th>Kind</th> <th>Value</th> <th>Annotation</th> </tr> </thead> <tbody> <tr> <td>enumeration</td> <td>0300001</td> <td>documentation konventieller Aortenklappenersatz</td> </tr> <tr> <td>enumeration</td> <td>0300002</td> <td>documentation kathetergestützte Aortenklappenimplantation (TAVI)</td> </tr> </tbody> </table>	Kind	Value	Annotation	enumeration	0300001	documentation konventieller Aortenklappenersatz	enumeration	0300002	documentation kathetergestützte Aortenklappenimplantation (TAVI)
Kind	Value	Annotation								
enumeration	0300001	documentation konventieller Aortenklappenersatz								
enumeration	0300002	documentation kathetergestützte Aortenklappenimplantation (TAVI)								
source	<code><element name="OAK_ArtEingriffSchluessel" type="enum_0300"/></code>									

element **OperationAortenklappeBasis/OAK_GrundEingriffSchluessel**

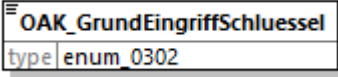
diagram													
type	enum_0302												
properties	content simple												
facets	<table border="1"> <thead> <tr> <th>Kind</th> <th>Value</th> <th>Annotation</th> </tr> </thead> <tbody> <tr> <td>enumeration</td> <td>0302001</td> <td>documentation Stenose</td> </tr> <tr> <td>enumeration</td> <td>0302002</td> <td>documentation Insuffizienz</td> </tr> <tr> <td>enumeration</td> <td>0302003</td> <td>documentation Stenose und Insuffizienz</td> </tr> </tbody> </table>	Kind	Value	Annotation	enumeration	0302001	documentation Stenose	enumeration	0302002	documentation Insuffizienz	enumeration	0302003	documentation Stenose und Insuffizienz
Kind	Value	Annotation											
enumeration	0302001	documentation Stenose											
enumeration	0302002	documentation Insuffizienz											
enumeration	0302003	documentation Stenose und Insuffizienz											
source	<code><element name="OAK_GrundEingriffSchluessel" type="enum_0302"/></code>												

element **OperationAortenklappeBasis/OAK_DringlichkeitSchluessel**

diagram	
---------	---

type	enum_0076															
properties	content simple															
facets	<table border="1"> <thead> <tr> <th>Kind</th> <th>Value</th> <th>Annotation</th> </tr> </thead> <tbody> <tr> <td>enumeration</td> <td>0076001</td> <td>documentation elektiv</td> </tr> <tr> <td>enumeration</td> <td>0076002</td> <td>documentation dringlich</td> </tr> <tr> <td>enumeration</td> <td>0076003</td> <td>documentation Notfall</td> </tr> <tr> <td>enumeration</td> <td>0076004</td> <td>documentation Notfall (Reanimation / ultima ratio)</td> </tr> </tbody> </table>	Kind	Value	Annotation	enumeration	0076001	documentation elektiv	enumeration	0076002	documentation dringlich	enumeration	0076003	documentation Notfall	enumeration	0076004	documentation Notfall (Reanimation / ultima ratio)
Kind	Value	Annotation														
enumeration	0076001	documentation elektiv														
enumeration	0076002	documentation dringlich														
enumeration	0076003	documentation Notfall														
enumeration	0076004	documentation Notfall (Reanimation / ultima ratio)														
source	<code><element name="OAK_DringlichkeitSchluessel" type="enum_0076"/></code>															

element OperationAortenklappeBasis/OAK_ExplantationSchluessel

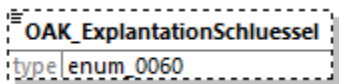
diagram										
type	enum_0060									
properties	minOcc 0 maxOcc 1 content simple									
facets	<table border="1"> <thead> <tr> <th>Kind</th> <th>Value</th> <th>Annotation</th> </tr> </thead> <tbody> <tr> <td>enumeration</td> <td>0060001</td> <td>documentation ja</td> </tr> <tr> <td>enumeration</td> <td>0060002</td> <td>documentation nein</td> </tr> </tbody> </table>	Kind	Value	Annotation	enumeration	0060001	documentation ja	enumeration	0060002	documentation nein
Kind	Value	Annotation								
enumeration	0060001	documentation ja								
enumeration	0060002	documentation nein								
source	<code><element name="OAK_ExplantationSchluessel" type="enum_0060" minOccurs="0"/></code>									

element OperationAortenklappeBasis/OAK_IsoliertSchluessel

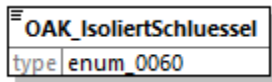
diagram										
type	enum_0060									
properties	content simple									
facets	<table border="1"> <thead> <tr> <th>Kind</th> <th>Value</th> <th>Annotation</th> </tr> </thead> <tbody> <tr> <td>enumeration</td> <td>0060001</td> <td>documentation ja</td> </tr> <tr> <td>enumeration</td> <td>0060002</td> <td>documentation nein</td> </tr> </tbody> </table>	Kind	Value	Annotation	enumeration	0060001	documentation ja	enumeration	0060002	documentation nein
Kind	Value	Annotation								
enumeration	0060001	documentation ja								
enumeration	0060002	documentation nein								
source	<code><element name="OAK_IsoliertSchluessel" type="enum_0060"/></code>									

element OperationAortenklappeBasis/OAK_ZugangKonventionellSchluessel

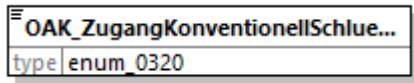
diagram	
type	enum_0320
properties	content simple

facets	Kind	Value	Annotation
	enumeration	0320001	documentation konventionelle Sternotomie
	enumeration	0320002	documentation partielle Sternotomie
	enumeration	0320003	documentation parasternaler Zugang
enumeration	0320042	documentation anderer Zugangsweg	
source	<code><element name="OAK_ZugangKonventionellSchluessel" type="enum_0320"/></code>		

element **OperationAortenklappeBasis/OAK_ZugangKatheterSchluessel**

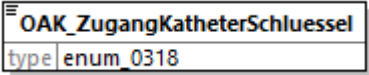
diagram			
type	enum 0318		
properties	content simple		
facets	Kind	Value	Annotation
	enumeration	0318001	documentation transapikal
	enumeration	0318002	documentation transaortal
	enumeration	0318003	documentation transfemoral
	enumeration	0318004	documentation transaxillär
enumeration	0318042	documentation anderer Zugangsweg	
source	<code><element name="OAK_ZugangKatheterSchluessel" type="enum_0318"/></code>		

element **OperationAortenklappeBasis/OAK_KomplikationenSchluessel**

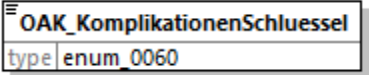
diagram			
type	enum 0060		
properties	content simple		
facets	Kind	Value	Annotation
	enumeration	0060001	documentation ja
enumeration	0060002	documentation nein	
source	<code><element name="OAK_KomplikationenSchluessel" type="enum_0060"/></code>		

element **OperationAortenklappeBasis/OAK_TherapieLcoSchluessel**

diagram			
type	enum 0346		

properties	minOcc 0 maxOcc 1 content simple																					
facets	<table border="1"> <thead> <tr> <th>Kind</th> <th>Value</th> <th>Annotation</th> </tr> </thead> <tbody> <tr> <td>enumeration</td> <td>0346001</td> <td>documentation keine Therapie erforderlich</td> </tr> <tr> <td>enumeration</td> <td>0346002</td> <td>documentation medikamentös</td> </tr> <tr> <td>enumeration</td> <td>0346003</td> <td>documentation IABP</td> </tr> <tr> <td>enumeration</td> <td>0346004</td> <td>documentation VAD</td> </tr> <tr> <td>enumeration</td> <td>0346005</td> <td>documentation ECMO</td> </tr> <tr> <td>enumeration</td> <td>0346042</td> <td>documentation sonstige</td> </tr> </tbody> </table>	Kind	Value	Annotation	enumeration	0346001	documentation keine Therapie erforderlich	enumeration	0346002	documentation medikamentös	enumeration	0346003	documentation IABP	enumeration	0346004	documentation VAD	enumeration	0346005	documentation ECMO	enumeration	0346042	documentation sonstige
Kind	Value	Annotation																				
enumeration	0346001	documentation keine Therapie erforderlich																				
enumeration	0346002	documentation medikamentös																				
enumeration	0346003	documentation IABP																				
enumeration	0346004	documentation VAD																				
enumeration	0346005	documentation ECMO																				
enumeration	0346042	documentation sonstige																				
source	<code><element name="OAK_TherapieLcoSchluessel" type="enum_0346" minOccurs="0"/></code>																					

element **OperationAortenklappeBasis/OAK_Durchleuchtungszeit**

diagram																
type	Zahl3_1															
properties	minOcc 0 maxOcc 1 content simple															
facets	<table border="1"> <thead> <tr> <th>Kind</th> <th>Value</th> <th>Annotation</th> </tr> </thead> <tbody> <tr> <td>minExclusive</td> <td>0</td> <td></td> </tr> <tr> <td>maxExclusive</td> <td>1000</td> <td></td> </tr> <tr> <td>totalDigits</td> <td>3</td> <td></td> </tr> <tr> <td>fractionDigits</td> <td>1</td> <td></td> </tr> </tbody> </table>	Kind	Value	Annotation	minExclusive	0		maxExclusive	1000		totalDigits	3		fractionDigits	1	
Kind	Value	Annotation														
minExclusive	0															
maxExclusive	1000															
totalDigits	3															
fractionDigits	1															
source	<code><element name="OAK_Durchleuchtungszeit" type="Zahl3_1" minOccurs="0"/></code>															

element **OperationAortenklappeBasis/OAK_BeatmungSchluessel**

diagram										
type	enum_0060									
properties	content simple									
facets	<table border="1"> <thead> <tr> <th>Kind</th> <th>Value</th> <th>Annotation</th> </tr> </thead> <tbody> <tr> <td>enumeration</td> <td>0060001</td> <td>documentation ja</td> </tr> <tr> <td>enumeration</td> <td>0060002</td> <td>documentation nein</td> </tr> </tbody> </table>	Kind	Value	Annotation	enumeration	0060001	documentation ja	enumeration	0060002	documentation nein
Kind	Value	Annotation								
enumeration	0060001	documentation ja								
enumeration	0060002	documentation nein								
source	<code><element name="OAK_BeatmungSchluessel" type="enum_0060"/></code>									

element **OperationAortenklappeBasis/OAK_TroponinSchluessel**

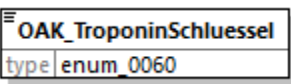
diagram										
type	enum_0060									
properties	content simple									
facets	<table border="1"> <thead> <tr> <th>Kind</th> <th>Value</th> <th>Annotation</th> </tr> </thead> <tbody> <tr> <td>enumeration</td> <td>0060001</td> <td>documentation ja</td> </tr> <tr> <td>enumeration</td> <td>0060002</td> <td>documentation nein</td> </tr> </tbody> </table>	Kind	Value	Annotation	enumeration	0060001	documentation ja	enumeration	0060002	documentation nein
Kind	Value	Annotation								
enumeration	0060001	documentation ja								
enumeration	0060002	documentation nein								
source	<code><element name="OAK_TroponinSchluessel" type="enum_0060"/></code>									

element **OperationAortenklappeBasis/OAK_InotropeSchluessel**

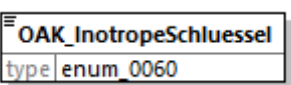
diagram										
type	enum_0060									
properties	content simple									
facets	<table border="1"> <thead> <tr> <th>Kind</th> <th>Value</th> <th>Annotation</th> </tr> </thead> <tbody> <tr> <td>enumeration</td> <td>0060001</td> <td>documentation ja</td> </tr> <tr> <td>enumeration</td> <td>0060002</td> <td>documentation nein</td> </tr> </tbody> </table>	Kind	Value	Annotation	enumeration	0060001	documentation ja	enumeration	0060002	documentation nein
Kind	Value	Annotation								
enumeration	0060001	documentation ja								
enumeration	0060002	documentation nein								
source	<code><element name="OAK_InotropeSchluessel" type="enum_0060"/></code>									

element **OperationAortenklappeBasis/OAK_Eingriffsdauer**

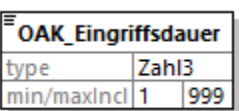
diagram										
type	Zahl3									
properties	content simple									
facets	<table border="1"> <thead> <tr> <th>Kind</th> <th>Value</th> <th>Annotation</th> </tr> </thead> <tbody> <tr> <td>minInclusive</td> <td>1</td> <td></td> </tr> <tr> <td>maxInclusive</td> <td>999</td> <td></td> </tr> </tbody> </table>	Kind	Value	Annotation	minInclusive	1		maxInclusive	999	
Kind	Value	Annotation								
minInclusive	1									
maxInclusive	999									
source	<code><element name="OAK_Eingriffsdauer" type="Zahl3"/></code>									

element **OperationAortenklappeBasis/OAK_EingriffsumfangSchluessel**

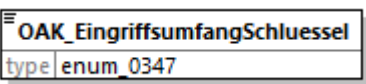
diagram	
type	enum_0347
properties	content simple

facets	Kind	Value	Annotation
	enumeration	0347001	documentation Einzeleingriff
	enumeration	0347002	documentation Kombinationseingriff mit mehreren Prozeduren
source	<code><element name="OAK_EingriffsumfangSchluessel" type="enum_0347"/></code>		

element **OperationAortenklappeBasis/OAK_ProzedurenAnzahl**

diagram			
type	Zahl1		
properties	minOcc 0 maxOcc 1 content simple		
facets	Kind	Value	Annotation
	minInclusive	1	
	maxInclusive	9	
source	<code><element name="OAK_ProzedurenAnzahl" type="Zahl1" minOccurs="0"/></code>		

element **OperationAortenklappeBasis/OAK_VorgehenSchluessel**

diagram			
type	enum_0348		
properties	content simple		
facets	Kind	Value	Annotation
	enumeration	0348001	documentation mit HLM
	enumeration	0348002	documentation ohne HLM
	enumeration	0348003	documentation Umstieg von OP ohne HLM auf OP mit HLM
source	<code><element name="OAK_VorgehenSchluessel" type="enum_0348"/></code>		

element **OperationAortenklappeBasis/OAK_Bypasszeit**

diagram			
type	Zahl3		
properties	content simple		
facets	Kind	Value	Annotation
	minInclusive	1	
	maxInclusive	999	
source	<code><element name="OAK_Bypasszeit" type="Zahl3"/></code>		

element **OperationAortenklappeBasis/OAK_BypasszeitUnbekannt**

diagram							
type	JaLeer						
properties	content simple						
facets	<table border="1"> <thead> <tr> <th>Kind</th> <th>Value</th> <th>Annotation</th> </tr> </thead> <tbody> <tr> <td>pattern</td> <td>(1)</td> <td></td> </tr> </tbody> </table>	Kind	Value	Annotation	pattern	(1)	
Kind	Value	Annotation					
pattern	(1)						
source	<code><element name="OAK_BypasszeitUnbekannt" type="JaLeer"/></code>						

element **OperationAortenklappeBasis/OAK_Abklemmzeit**

diagram										
type	Zahl3									
properties	content simple									
facets	<table border="1"> <thead> <tr> <th>Kind</th> <th>Value</th> <th>Annotation</th> </tr> </thead> <tbody> <tr> <td>minInclusive</td> <td>1</td> <td></td> </tr> <tr> <td>maxInclusive</td> <td>999</td> <td></td> </tr> </tbody> </table>	Kind	Value	Annotation	minInclusive	1		maxInclusive	999	
Kind	Value	Annotation								
minInclusive	1									
maxInclusive	999									
source	<code><element name="OAK_Abklemmzeit" type="Zahl3"/></code>									

element **OperationAortenklappeBasis/OAK_AbklemmzeitUnbekannt**

diagram							
type	JaLeer						
properties	content simple						
facets	<table border="1"> <thead> <tr> <th>Kind</th> <th>Value</th> <th>Annotation</th> </tr> </thead> <tbody> <tr> <td>pattern</td> <td>(1)</td> <td></td> </tr> </tbody> </table>	Kind	Value	Annotation	pattern	(1)	
Kind	Value	Annotation					
pattern	(1)						
source	<code><element name="OAK_AbklemmzeitUnbekannt" type="JaLeer"/></code>						

element **OperationAortenklappeBasis/OAK_AortaThorakalSchluessel**

diagram							
type	enum_0060						
properties	content simple						
facets	<table border="1"> <thead> <tr> <th>Kind</th> <th>Value</th> <th>Annotation</th> </tr> </thead> <tbody> <tr> <td>enumeration</td> <td>0060001</td> <td>documentation</td> </tr> </tbody> </table>	Kind	Value	Annotation	enumeration	0060001	documentation
Kind	Value	Annotation					
enumeration	0060001	documentation					

	enumeration 0060002 ja documentation nein
source	<element name="OAK_AortaThorakalSchluessel" type="enum_0060"/>

element **OperationAortenklappeBasis/OAK_NeuroprotektionSchluessel**

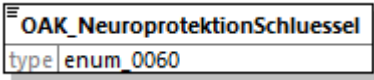
diagram										
type	enum_0060									
properties	content simple									
facets	<table border="1"> <thead> <tr> <th>Kind</th> <th>Value</th> <th>Annotation</th> </tr> </thead> <tbody> <tr> <td>enumeration</td> <td>0060001</td> <td>documentation ja</td> </tr> <tr> <td>enumeration</td> <td>0060002</td> <td>documentation nein</td> </tr> </tbody> </table>	Kind	Value	Annotation	enumeration	0060001	documentation ja	enumeration	0060002	documentation nein
Kind	Value	Annotation								
enumeration	0060001	documentation ja								
enumeration	0060002	documentation nein								
source	<element name="OAK_NeuroprotektionSchluessel" type="enum_0060"/>									

element **OperationAortenklappeBasis/OAK_KreislaufunterstuetzungSchluessel**

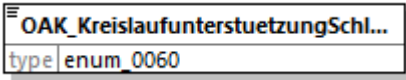
diagram										
type	enum_0060									
properties	content simple									
facets	<table border="1"> <thead> <tr> <th>Kind</th> <th>Value</th> <th>Annotation</th> </tr> </thead> <tbody> <tr> <td>enumeration</td> <td>0060001</td> <td>documentation ja</td> </tr> <tr> <td>enumeration</td> <td>0060002</td> <td>documentation nein</td> </tr> </tbody> </table>	Kind	Value	Annotation	enumeration	0060001	documentation ja	enumeration	0060002	documentation nein
Kind	Value	Annotation								
enumeration	0060001	documentation ja								
enumeration	0060002	documentation nein								
source	<element name="OAK_KreislaufunterstuetzungSchluessel" type="enum_0060"/>									

element **OperationAortenklappeBasis/OAK_PraeOpUnterstuetzungSchluessel**

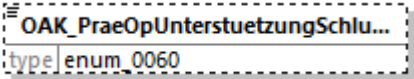
diagram										
type	enum_0060									
properties	minOcc 0 maxOcc 1 content simple									
facets	<table border="1"> <thead> <tr> <th>Kind</th> <th>Value</th> <th>Annotation</th> </tr> </thead> <tbody> <tr> <td>enumeration</td> <td>0060001</td> <td>documentation ja</td> </tr> <tr> <td>enumeration</td> <td>0060002</td> <td>documentation nein</td> </tr> </tbody> </table>	Kind	Value	Annotation	enumeration	0060001	documentation ja	enumeration	0060002	documentation nein
Kind	Value	Annotation								
enumeration	0060001	documentation ja								
enumeration	0060002	documentation nein								
source	<element name="OAK_PraeOpUnterstuetzungSchluessel" type="enum_0060" minOccurs="0"/>									

element **OperationAortenklappeBasis/OAK_PraeOpMethodeSchluessel**

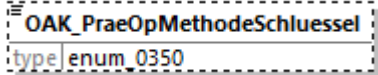
diagram																			
type	enum 0350																		
properties	minOcc 0 maxOcc 1 content simple																		
facets	<table border="1"> <thead> <tr> <th>Kind</th> <th>Value</th> <th>Annotation</th> </tr> </thead> <tbody> <tr> <td>enumeration</td> <td>0350001</td> <td>documentation IABP</td> </tr> <tr> <td>enumeration</td> <td>0350002</td> <td>documentation Impella</td> </tr> <tr> <td>enumeration</td> <td>0350003</td> <td>documentation vv ECMO</td> </tr> <tr> <td>enumeration</td> <td>0350004</td> <td>documentation va ECMO</td> </tr> <tr> <td>enumeration</td> <td>0350042</td> <td>documentation andere</td> </tr> </tbody> </table>	Kind	Value	Annotation	enumeration	0350001	documentation IABP	enumeration	0350002	documentation Impella	enumeration	0350003	documentation vv ECMO	enumeration	0350004	documentation va ECMO	enumeration	0350042	documentation andere
Kind	Value	Annotation																	
enumeration	0350001	documentation IABP																	
enumeration	0350002	documentation Impella																	
enumeration	0350003	documentation vv ECMO																	
enumeration	0350004	documentation va ECMO																	
enumeration	0350042	documentation andere																	
source	<code><element name="OAK_PraeOpMethodeSchluessel" type="enum_0350" minOccurs="0"/></code>																		

element **OperationAortenklappeBasis/OAK_IntraOpUnterstuetzungSchluessel**

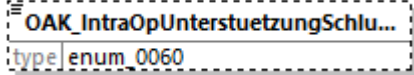
diagram										
type	enum 0060									
properties	minOcc 0 maxOcc 1 content simple									
facets	<table border="1"> <thead> <tr> <th>Kind</th> <th>Value</th> <th>Annotation</th> </tr> </thead> <tbody> <tr> <td>enumeration</td> <td>0060001</td> <td>documentation ja</td> </tr> <tr> <td>enumeration</td> <td>0060002</td> <td>documentation nein</td> </tr> </tbody> </table>	Kind	Value	Annotation	enumeration	0060001	documentation ja	enumeration	0060002	documentation nein
Kind	Value	Annotation								
enumeration	0060001	documentation ja								
enumeration	0060002	documentation nein								
source	<code><element name="OAK_IntraOpUnterstuetzungSchluessel" type="enum_0060" minOccurs="0"/></code>									

element **OperationAortenklappeBasis/OAK_IntraOpMethodeSchluessel**

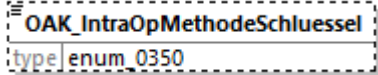
diagram													
type	enum 0350												
properties	minOcc 0 maxOcc 1 content simple												
facets	<table border="1"> <thead> <tr> <th>Kind</th> <th>Value</th> <th>Annotation</th> </tr> </thead> <tbody> <tr> <td>enumeration</td> <td>0350001</td> <td>documentation IABP</td> </tr> <tr> <td>enumeration</td> <td>0350002</td> <td>documentation Impella</td> </tr> <tr> <td>enumeration</td> <td>0350003</td> <td>documentation vv ECMO</td> </tr> </tbody> </table>	Kind	Value	Annotation	enumeration	0350001	documentation IABP	enumeration	0350002	documentation Impella	enumeration	0350003	documentation vv ECMO
Kind	Value	Annotation											
enumeration	0350001	documentation IABP											
enumeration	0350002	documentation Impella											
enumeration	0350003	documentation vv ECMO											

	enumeration 0350004 documentation va ECMO
	enumeration 0350042 documentation andere
source	<code><element name="OAK_IntraOpMethodeSchluessel" type="enum_0350" minOccurs="0"/></code>

element **OperationAortenklappeBasis/OAK_AortenklappenOpAnzahl**

diagram										
type	Zahl2									
properties	content simple									
facets	<table border="1"> <thead> <tr> <th>Kind</th> <th>Value</th> <th>Annotation</th> </tr> </thead> <tbody> <tr> <td>minInclusive</td> <td>1</td> <td></td> </tr> <tr> <td>maxInclusive</td> <td>99</td> <td></td> </tr> </tbody> </table>	Kind	Value	Annotation	minInclusive	1		maxInclusive	99	
Kind	Value	Annotation								
minInclusive	1									
maxInclusive	99									
source	<code><element name="OAK_AortenklappenOpAnzahl" type="Zahl2"/></code>									

element **OperationAortenklappeBasis/OAK_ValveInValveSchluessel**

diagram										
type	enum_0060									
properties	minOcc 0 maxOcc 1 content simple									
facets	<table border="1"> <thead> <tr> <th>Kind</th> <th>Value</th> <th>Annotation</th> </tr> </thead> <tbody> <tr> <td>enumeration</td> <td>0060001</td> <td>documentation ja</td> </tr> <tr> <td>enumeration</td> <td>0060002</td> <td>documentation nein</td> </tr> </tbody> </table>	Kind	Value	Annotation	enumeration	0060001	documentation ja	enumeration	0060002	documentation nein
Kind	Value	Annotation								
enumeration	0060001	documentation ja								
enumeration	0060002	documentation nein								
source	<code><element name="OAK_ValveInValveSchluessel" type="enum_0060" minOccurs="0"/></code>									

element **OperationAortenklappeBasis/OAK_ZugangsGefaessdiameter**

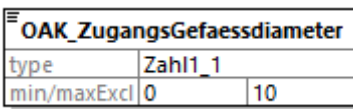
diagram																
type	Zahl1_1															
properties	content simple															
facets	<table border="1"> <thead> <tr> <th>Kind</th> <th>Value</th> <th>Annotation</th> </tr> </thead> <tbody> <tr> <td>minExclusive</td> <td>0</td> <td></td> </tr> <tr> <td>maxExclusive</td> <td>10</td> <td></td> </tr> <tr> <td>totalDigits</td> <td>1</td> <td></td> </tr> <tr> <td>fractionDigits</td> <td>1</td> <td></td> </tr> </tbody> </table>	Kind	Value	Annotation	minExclusive	0		maxExclusive	10		totalDigits	1		fractionDigits	1	
Kind	Value	Annotation														
minExclusive	0															
maxExclusive	10															
totalDigits	1															
fractionDigits	1															
source	<code><element name="OAK_ZugangsGefaessdiameter" type="Zahl1_1"/></code>															

element **OperationAortenklappeBasis/OAK_ZugangsGefaessUnbekannt**

diagram							
type	JaLeer						
properties	content simple						
facets	<table border="1"> <thead> <tr> <th>Kind</th> <th>Value</th> <th>Annotation</th> </tr> </thead> <tbody> <tr> <td>pattern</td> <td>(1)</td> <td></td> </tr> </tbody> </table>	Kind	Value	Annotation	pattern	(1)	
Kind	Value	Annotation					
pattern	(1)						
source	<code><element name="OAK_ZugangsGefaessUnbekannt" type="JaLeer"/></code>						

element **OperationAortenklappeBasis/OAK_ZugangVerkalkungSchluessel**

diagram													
type	enum_0061												
properties	<table border="1"> <tbody> <tr> <td>minOcc</td> <td>0</td> </tr> <tr> <td>maxOcc</td> <td>1</td> </tr> <tr> <td>content</td> <td>simple</td> </tr> </tbody> </table>	minOcc	0	maxOcc	1	content	simple						
minOcc	0												
maxOcc	1												
content	simple												
facets	<table border="1"> <thead> <tr> <th>Kind</th> <th>Value</th> <th>Annotation</th> </tr> </thead> <tbody> <tr> <td>enumeration</td> <td>0061001</td> <td>documentation ja</td> </tr> <tr> <td>enumeration</td> <td>0061002</td> <td>documentation nein</td> </tr> <tr> <td>enumeration</td> <td>0061099</td> <td>documentation unbekannt</td> </tr> </tbody> </table>	Kind	Value	Annotation	enumeration	0061001	documentation ja	enumeration	0061002	documentation nein	enumeration	0061099	documentation unbekannt
Kind	Value	Annotation											
enumeration	0061001	documentation ja											
enumeration	0061002	documentation nein											
enumeration	0061099	documentation unbekannt											
source	<code><element name="OAK_ZugangVerkalkungSchluessel" type="enum_0061" minOccurs="0"/></code>												

element **OperationAortenklappeBasis/OAK_Aortenklappenannulus**

diagram										
type	Zahl3									
properties	<table border="1"> <tbody> <tr> <td>minOcc</td> <td>0</td> </tr> <tr> <td>maxOcc</td> <td>1</td> </tr> <tr> <td>content</td> <td>simple</td> </tr> </tbody> </table>	minOcc	0	maxOcc	1	content	simple			
minOcc	0									
maxOcc	1									
content	simple									
facets	<table border="1"> <thead> <tr> <th>Kind</th> <th>Value</th> <th>Annotation</th> </tr> </thead> <tbody> <tr> <td>minInclusive</td> <td>1</td> <td></td> </tr> <tr> <td>maxInclusive</td> <td>999</td> <td></td> </tr> </tbody> </table>	Kind	Value	Annotation	minInclusive	1		maxInclusive	999	
Kind	Value	Annotation								
minInclusive	1									
maxInclusive	999									
source	<code><element name="OAK_Aortenklappenannulus" type="Zahl3" minOccurs="0"/></code>									

element **OperationAortenklappeBasis/OAK_MessmethodeSchluessel**

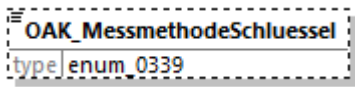
diagram													
type	enum_0339												
properties	minOcc 0 maxOcc 1 content simple												
facets	<table border="1"> <thead> <tr> <th>Kind</th> <th>Value</th> <th>Annotation</th> </tr> </thead> <tbody> <tr> <td>enumeration</td> <td>0339001</td> <td>documentation TEE</td> </tr> <tr> <td>enumeration</td> <td>0339002</td> <td>documentation CT</td> </tr> <tr> <td>enumeration</td> <td>0339042</td> <td>documentation andere</td> </tr> </tbody> </table>	Kind	Value	Annotation	enumeration	0339001	documentation TEE	enumeration	0339002	documentation CT	enumeration	0339042	documentation andere
Kind	Value	Annotation											
enumeration	0339001	documentation TEE											
enumeration	0339002	documentation CT											
enumeration	0339042	documentation andere											
source	<code><element name="OAK_MessmethodeSchluessel" type="enum_0339" minOccurs="0"/></code>												

element **OperationAortenklappeBasis/OAK_DistanzRca**

diagram										
type	Zahl3									
properties	content simple									
facets	<table border="1"> <thead> <tr> <th>Kind</th> <th>Value</th> <th>Annotation</th> </tr> </thead> <tbody> <tr> <td>minInclusive</td> <td>1</td> <td></td> </tr> <tr> <td>maxInclusive</td> <td>999</td> <td></td> </tr> </tbody> </table>	Kind	Value	Annotation	minInclusive	1		maxInclusive	999	
Kind	Value	Annotation								
minInclusive	1									
maxInclusive	999									
source	<code><element name="OAK_DistanzRca" type="Zahl3"/></code>									

element **OperationAortenklappeBasis/OAK_DistanzRcaUnbekannt**

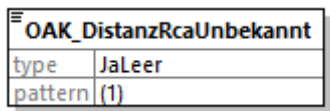
diagram							
type	JaLeer						
properties	content simple						
facets	<table border="1"> <thead> <tr> <th>Kind</th> <th>Value</th> <th>Annotation</th> </tr> </thead> <tbody> <tr> <td>pattern</td> <td>(1)</td> <td></td> </tr> </tbody> </table>	Kind	Value	Annotation	pattern	(1)	
Kind	Value	Annotation					
pattern	(1)						
source	<code><element name="OAK_DistanzRcaUnbekannt" type="JaLeer"/></code>						

element **OperationAortenklappeBasis/OAK_DistanzLca**

diagram	
type	Zahl3

properties	content simple									
facets	<table border="1"> <thead> <tr> <th>Kind</th> <th>Value</th> <th>Annotation</th> </tr> </thead> <tbody> <tr> <td>minInclusive</td> <td>1</td> <td></td> </tr> <tr> <td>maxInclusive</td> <td>999</td> <td></td> </tr> </tbody> </table>	Kind	Value	Annotation	minInclusive	1		maxInclusive	999	
Kind	Value	Annotation								
minInclusive	1									
maxInclusive	999									
source	<code><element name="OAK_DistanzLca" type="Zahl3"/></code>									

element **OperationAortenklappeBasis/OAK_DistanzLcaUnbekannt**

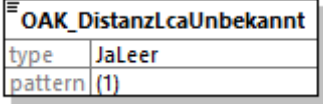
diagram							
type	JaLeer						
properties	content simple						
facets	<table border="1"> <thead> <tr> <th>Kind</th> <th>Value</th> <th>Annotation</th> </tr> </thead> <tbody> <tr> <td>pattern</td> <td>(1)</td> <td></td> </tr> </tbody> </table>	Kind	Value	Annotation	pattern	(1)	
Kind	Value	Annotation					
pattern	(1)						
source	<code><element name="OAK_DistanzLcaUnbekannt" type="JaLeer"/></code>						

element **OperationAortenklappeBasis/OAK_PtcaVorSchluessel**

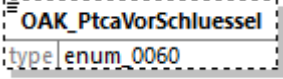
diagram										
type	enum_0060									
properties	<table border="1"> <tbody> <tr> <td>minOcc</td> <td>0</td> </tr> <tr> <td>maxOcc</td> <td>1</td> </tr> <tr> <td>content</td> <td>simple</td> </tr> </tbody> </table>	minOcc	0	maxOcc	1	content	simple			
minOcc	0									
maxOcc	1									
content	simple									
facets	<table border="1"> <thead> <tr> <th>Kind</th> <th>Value</th> <th>Annotation</th> </tr> </thead> <tbody> <tr> <td>enumeration</td> <td>0060001</td> <td>documentation ja</td> </tr> <tr> <td>enumeration</td> <td>0060002</td> <td>documentation nein</td> </tr> </tbody> </table>	Kind	Value	Annotation	enumeration	0060001	documentation ja	enumeration	0060002	documentation nein
Kind	Value	Annotation								
enumeration	0060001	documentation ja								
enumeration	0060002	documentation nein								
source	<code><element name="OAK_PtcaVorSchluessel" type="enum_0060" minOccurs="0"/></code>									

element **OperationAortenklappeBasis/OAK_PtcaVorDurchmesser**

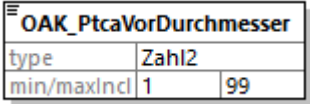
diagram										
type	Zahl2									
properties	content simple									
facets	<table border="1"> <thead> <tr> <th>Kind</th> <th>Value</th> <th>Annotation</th> </tr> </thead> <tbody> <tr> <td>minInclusive</td> <td>1</td> <td></td> </tr> <tr> <td>maxInclusive</td> <td>99</td> <td></td> </tr> </tbody> </table>	Kind	Value	Annotation	minInclusive	1		maxInclusive	99	
Kind	Value	Annotation								
minInclusive	1									
maxInclusive	99									
source	<code><element name="OAK_PtcaVorDurchmesser" type="Zahl2"/></code>									

element **OperationAortenklappeBasis/OAK_PtcaVorDurchmesserUnbekannt**

diagram							
type	JaLeer						
properties	content simple						
facets	<table border="1"> <thead> <tr> <th>Kind</th> <th>Value</th> <th>Annotation</th> </tr> </thead> <tbody> <tr> <td>pattern</td> <td>(1)</td> <td></td> </tr> </tbody> </table>	Kind	Value	Annotation	pattern	(1)	
Kind	Value	Annotation					
pattern	(1)						
source	<code><element name="OAK_PtcaVorDurchmesserUnbekannt" type="JaLeer"/></code>						

element **OperationAortenklappeBasis/OAK_PtcaVorAnzahl**

diagram										
type	Zahl2									
properties	<table border="1"> <tbody> <tr> <td>minOcc</td> <td>0</td> </tr> <tr> <td>maxOcc</td> <td>1</td> </tr> <tr> <td>content</td> <td>simple</td> </tr> </tbody> </table>	minOcc	0	maxOcc	1	content	simple			
minOcc	0									
maxOcc	1									
content	simple									
facets	<table border="1"> <thead> <tr> <th>Kind</th> <th>Value</th> <th>Annotation</th> </tr> </thead> <tbody> <tr> <td>minInclusive</td> <td>1</td> <td></td> </tr> <tr> <td>maxInclusive</td> <td>99</td> <td></td> </tr> </tbody> </table>	Kind	Value	Annotation	minInclusive	1		maxInclusive	99	
Kind	Value	Annotation								
minInclusive	1									
maxInclusive	99									
source	<code><element name="OAK_PtcaVorAnzahl" type="Zahl2" minOccurs="0"/></code>									

element **OperationAortenklappeBasis/OAK_RapidPacingVorSchluessel**

diagram										
type	enum_0060									
properties	<table border="1"> <tbody> <tr> <td>minOcc</td> <td>0</td> </tr> <tr> <td>maxOcc</td> <td>1</td> </tr> <tr> <td>content</td> <td>simple</td> </tr> </tbody> </table>	minOcc	0	maxOcc	1	content	simple			
minOcc	0									
maxOcc	1									
content	simple									
facets	<table border="1"> <thead> <tr> <th>Kind</th> <th>Value</th> <th>Annotation</th> </tr> </thead> <tbody> <tr> <td>enumeration</td> <td>0060001</td> <td>documentation ja</td> </tr> <tr> <td>enumeration</td> <td>0060002</td> <td>documentation nein</td> </tr> </tbody> </table>	Kind	Value	Annotation	enumeration	0060001	documentation ja	enumeration	0060002	documentation nein
Kind	Value	Annotation								
enumeration	0060001	documentation ja								
enumeration	0060002	documentation nein								
source	<code><element name="OAK_RapidPacingVorSchluessel" type="enum_0060" minOccurs="0"/></code>									

element **OperationAortenklappeBasis/OAK_RapidPacingIntraSchluessel**

diagram					
type	enum_0060				
properties	<table border="1"> <tbody> <tr> <td>minOcc</td> <td>0</td> </tr> <tr> <td>maxOcc</td> <td>1</td> </tr> </tbody> </table>	minOcc	0	maxOcc	1
minOcc	0				
maxOcc	1				

	content simple									
facets	<table border="1"> <thead> <tr> <th>Kind</th> <th>Value</th> <th>Annotation</th> </tr> </thead> <tbody> <tr> <td>enumeration</td> <td>0060001</td> <td>documentation ja</td> </tr> <tr> <td>enumeration</td> <td>0060002</td> <td>documentation nein</td> </tr> </tbody> </table>	Kind	Value	Annotation	enumeration	0060001	documentation ja	enumeration	0060002	documentation nein
Kind	Value	Annotation								
enumeration	0060001	documentation ja								
enumeration	0060002	documentation nein								
source	<code><element name="OAK_RapidPacingIntraSchluessel" type="enum_0060" minOccurs="0"/></code>									

element **OperationAortenklappeBasis/OAK_PtcaNachSchluessel**

diagram										
type	enum_0060									
properties	minOcc 0 maxOcc 1 content simple									
facets	<table border="1"> <thead> <tr> <th>Kind</th> <th>Value</th> <th>Annotation</th> </tr> </thead> <tbody> <tr> <td>enumeration</td> <td>0060001</td> <td>documentation ja</td> </tr> <tr> <td>enumeration</td> <td>0060002</td> <td>documentation nein</td> </tr> </tbody> </table>	Kind	Value	Annotation	enumeration	0060001	documentation ja	enumeration	0060002	documentation nein
Kind	Value	Annotation								
enumeration	0060001	documentation ja								
enumeration	0060002	documentation nein								
source	<code><element name="OAK_PtcaNachSchluessel" type="enum_0060" minOccurs="0"/></code>									

element **OperationAortenklappeBasis/OAK_PtcaNachDurchmesser**

diagram										
type	Zahl2									
properties	content simple									
facets	<table border="1"> <thead> <tr> <th>Kind</th> <th>Value</th> <th>Annotation</th> </tr> </thead> <tbody> <tr> <td>minInclusive</td> <td>1</td> <td></td> </tr> <tr> <td>maxInclusive</td> <td>99</td> <td></td> </tr> </tbody> </table>	Kind	Value	Annotation	minInclusive	1		maxInclusive	99	
Kind	Value	Annotation								
minInclusive	1									
maxInclusive	99									
source	<code><element name="OAK_PtcaNachDurchmesser" type="Zahl2"/></code>									

element **OperationAortenklappeBasis/OAK_PtcaNachDurchmesserUnbekannt**

diagram							
type	JaLeer						
properties	content simple						
facets	<table border="1"> <thead> <tr> <th>Kind</th> <th>Value</th> <th>Annotation</th> </tr> </thead> <tbody> <tr> <td>pattern</td> <td>(1)</td> <td></td> </tr> </tbody> </table>	Kind	Value	Annotation	pattern	(1)	
Kind	Value	Annotation					
pattern	(1)						
source	<code><element name="OAK_PtcaNachDurchmesserUnbekannt" type="JaLeer"/></code>						

element **OperationAortenklappeBasis/OAK_PtcaNachAnzahl**

diagram										
type	Zahl2									
properties	minOcc 0 maxOcc 1 content simple									
facets	<table border="1"> <thead> <tr> <th>Kind</th> <th>Value</th> <th>Annotation</th> </tr> </thead> <tbody> <tr> <td>minInclusive</td> <td>1</td> <td></td> </tr> <tr> <td>maxInclusive</td> <td>99</td> <td></td> </tr> </tbody> </table>	Kind	Value	Annotation	minInclusive	1		maxInclusive	99	
Kind	Value	Annotation								
minInclusive	1									
maxInclusive	99									
source	<code><element name="OAK_PtcaNachAnzahl" type="Zahl2" minOccurs="0"/></code>									

element **OperationAortenklappeBasis/OAK_RapidPacingNachSchluessel**

diagram										
type	enum_0060									
properties	minOcc 0 maxOcc 1 content simple									
facets	<table border="1"> <thead> <tr> <th>Kind</th> <th>Value</th> <th>Annotation</th> </tr> </thead> <tbody> <tr> <td>enumeration</td> <td>0060001</td> <td>documentation ja</td> </tr> <tr> <td>enumeration</td> <td>0060002</td> <td>documentation nein</td> </tr> </tbody> </table>	Kind	Value	Annotation	enumeration	0060001	documentation ja	enumeration	0060002	documentation nein
Kind	Value	Annotation								
enumeration	0060001	documentation ja								
enumeration	0060002	documentation nein								
source	<code><element name="OAK_RapidPacingNachSchluessel" type="enum_0060" minOccurs="0"/></code>									

element **OperationAortenklappeBasis/OAK_KonversionSchluessel**

diagram																									
type	enum_0351																								
properties	minOcc 0 maxOcc 1 content simple																								
facets	<table border="1"> <thead> <tr> <th>Kind</th> <th>Value</th> <th>Annotation</th> </tr> </thead> <tbody> <tr> <td>enumeration</td> <td>0351001</td> <td>documentation nein</td> </tr> <tr> <td>enumeration</td> <td>0351002</td> <td>documentation ja, zu Stenotomie</td> </tr> <tr> <td>enumeration</td> <td>0351003</td> <td>documentation ja, zu transapikal</td> </tr> <tr> <td>enumeration</td> <td>0351004</td> <td>documentation ja, zu transaortal</td> </tr> <tr> <td>enumeration</td> <td>0351005</td> <td>documentation ja, zu transfemorale</td> </tr> <tr> <td>enumeration</td> <td>0351006</td> <td>documentation ja, zu transaxillär</td> </tr> <tr> <td>enumeration</td> <td>0351007</td> <td>documentation ja, zu anderem endovaskulären Zugang</td> </tr> </tbody> </table>	Kind	Value	Annotation	enumeration	0351001	documentation nein	enumeration	0351002	documentation ja, zu Stenotomie	enumeration	0351003	documentation ja, zu transapikal	enumeration	0351004	documentation ja, zu transaortal	enumeration	0351005	documentation ja, zu transfemorale	enumeration	0351006	documentation ja, zu transaxillär	enumeration	0351007	documentation ja, zu anderem endovaskulären Zugang
Kind	Value	Annotation																							
enumeration	0351001	documentation nein																							
enumeration	0351002	documentation ja, zu Stenotomie																							
enumeration	0351003	documentation ja, zu transapikal																							
enumeration	0351004	documentation ja, zu transaortal																							
enumeration	0351005	documentation ja, zu transfemorale																							
enumeration	0351006	documentation ja, zu transaxillär																							
enumeration	0351007	documentation ja, zu anderem endovaskulären Zugang																							

	enumeration 0351042 documentation ja, zu anderem Zugang
source	<element name="OAK_KonversionSchluessel" type="enum_0351" minOccurs="0"/>

element **OperationAortenklappeBasis/OAK_SuccessSchluessel**

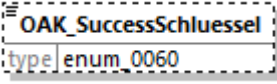
diagram										
type	enum_0060									
properties	minOcc 0 maxOcc 1 content simple									
facets	<table border="1"> <thead> <tr> <th>Kind</th> <th>Value</th> <th>Annotation</th> </tr> </thead> <tbody> <tr> <td>enumeration</td> <td>0060001</td> <td>documentation ja</td> </tr> <tr> <td>enumeration</td> <td>0060002</td> <td>documentation nein</td> </tr> </tbody> </table>	Kind	Value	Annotation	enumeration	0060001	documentation ja	enumeration	0060002	documentation nein
Kind	Value	Annotation								
enumeration	0060001	documentation ja								
enumeration	0060002	documentation nein								
source	<element name="OAK_SuccessSchluessel" type="enum_0060" minOccurs="0"/>									

element **OperationAortenklappeBasis/OAK_AnaesthesieSchluessel**

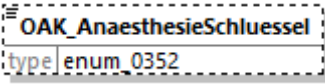
diagram																
type	enum_0352															
properties	minOcc 0 maxOcc 1 content simple															
facets	<table border="1"> <thead> <tr> <th>Kind</th> <th>Value</th> <th>Annotation</th> </tr> </thead> <tbody> <tr> <td>enumeration</td> <td>0352001</td> <td>documentation nein</td> </tr> <tr> <td>enumeration</td> <td>0352002</td> <td>documentation ja, Intubationsnarkose</td> </tr> <tr> <td>enumeration</td> <td>0352003</td> <td>documentation ja, Maskenbeatmung, incl. LAMA</td> </tr> <tr> <td>enumeration</td> <td>0352042</td> <td>documentation ja, unbekannt welche</td> </tr> </tbody> </table>	Kind	Value	Annotation	enumeration	0352001	documentation nein	enumeration	0352002	documentation ja, Intubationsnarkose	enumeration	0352003	documentation ja, Maskenbeatmung, incl. LAMA	enumeration	0352042	documentation ja, unbekannt welche
Kind	Value	Annotation														
enumeration	0352001	documentation nein														
enumeration	0352002	documentation ja, Intubationsnarkose														
enumeration	0352003	documentation ja, Maskenbeatmung, incl. LAMA														
enumeration	0352042	documentation ja, unbekannt welche														
source	<element name="OAK_AnaesthesieSchluessel" type="enum_0352" minOccurs="0"/>															

element **OperationAortenklappeBasis/OAK_DeltaPmeanNachOp**

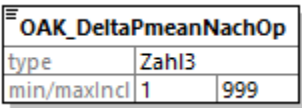
diagram										
type	Zahl3									
properties	content simple									
facets	<table border="1"> <thead> <tr> <th>Kind</th> <th>Value</th> <th>Annotation</th> </tr> </thead> <tbody> <tr> <td>minInclusive</td> <td>1</td> <td></td> </tr> <tr> <td>maxInclusive</td> <td>999</td> <td></td> </tr> </tbody> </table>	Kind	Value	Annotation	minInclusive	1		maxInclusive	999	
Kind	Value	Annotation								
minInclusive	1									
maxInclusive	999									

source	<code><element name="OAK_DeltaPmeanNachOp" type="Zah13"/></code>
--------	--

element **OperationAortenklappeBasis/OAK_DeltaPmeanNachOpUnbekannt**

diagram							
type	JaLeer						
properties	content simple						
facets	<table border="1"> <thead> <tr> <th>Kind</th> <th>Value</th> <th>Annotation</th> </tr> </thead> <tbody> <tr> <td>pattern</td> <td>(1)</td> <td></td> </tr> </tbody> </table>	Kind	Value	Annotation	pattern	(1)	
Kind	Value	Annotation					
pattern	(1)						
source	<code><element name="OAK_DeltaPmeanNachOpUnbekannt" type="JaLeer"/></code>						

element **OperationAortenklappeBasis/OAK_ResidualeInsuffizienzSchluessel**

diagram																			
type	enum 0353																		
properties	<table border="1"> <tr> <td>minOcc</td> <td>0</td> </tr> <tr> <td>maxOcc</td> <td>1</td> </tr> <tr> <td>content</td> <td>simple</td> </tr> </table>	minOcc	0	maxOcc	1	content	simple												
minOcc	0																		
maxOcc	1																		
content	simple																		
facets	<table border="1"> <thead> <tr> <th>Kind</th> <th>Value</th> <th>Annotation</th> </tr> </thead> <tbody> <tr> <td>enumeration</td> <td>0353001</td> <td>documentation keine</td> </tr> <tr> <td>enumeration</td> <td>0353002</td> <td>documentation leichtgradig</td> </tr> <tr> <td>enumeration</td> <td>0353003</td> <td>documentation mittelgradig</td> </tr> <tr> <td>enumeration</td> <td>0353004</td> <td>documentation hochgradig</td> </tr> <tr> <td>enumeration</td> <td>0353099</td> <td>documentation nicht bestimmbar</td> </tr> </tbody> </table>	Kind	Value	Annotation	enumeration	0353001	documentation keine	enumeration	0353002	documentation leichtgradig	enumeration	0353003	documentation mittelgradig	enumeration	0353004	documentation hochgradig	enumeration	0353099	documentation nicht bestimmbar
Kind	Value	Annotation																	
enumeration	0353001	documentation keine																	
enumeration	0353002	documentation leichtgradig																	
enumeration	0353003	documentation mittelgradig																	
enumeration	0353004	documentation hochgradig																	
enumeration	0353099	documentation nicht bestimmbar																	
source	<code><element name="OAK_ResidualeInsuffizienzSchluessel" type="enum_0353" minOccurs="0"/></code>																		

element **OperationAortenklappeBasis/OAK_ZugangVerschlussSchluessel**

diagram													
type	enum 0354												
properties	<table border="1"> <tr> <td>minOcc</td> <td>0</td> </tr> <tr> <td>maxOcc</td> <td>1</td> </tr> <tr> <td>content</td> <td>simple</td> </tr> </table>	minOcc	0	maxOcc	1	content	simple						
minOcc	0												
maxOcc	1												
content	simple												
facets	<table border="1"> <thead> <tr> <th>Kind</th> <th>Value</th> <th>Annotation</th> </tr> </thead> <tbody> <tr> <td>enumeration</td> <td>0354001</td> <td>documentation chirurgisch-offen</td> </tr> <tr> <td>enumeration</td> <td>0354002</td> <td>documentation Verschluss-System</td> </tr> <tr> <td>enumeration</td> <td>0354042</td> <td>documentation</td> </tr> </tbody> </table>	Kind	Value	Annotation	enumeration	0354001	documentation chirurgisch-offen	enumeration	0354002	documentation Verschluss-System	enumeration	0354042	documentation
Kind	Value	Annotation											
enumeration	0354001	documentation chirurgisch-offen											
enumeration	0354002	documentation Verschluss-System											
enumeration	0354042	documentation											

	sonstige
source	<code><element name="OAK_ZugangVerschlussSchluessel" type="enum_0354" minOccurs="0"/></code>

element **OperationAortenklappeBasis/OAK_ZusaetzlichePciSchluessel**

diagram										
type	enum 0060									
properties	minOcc 0 maxOcc 1 content simple									
facets	<table border="1"> <thead> <tr> <th>Kind</th> <th>Value</th> <th>Annotation</th> </tr> </thead> <tbody> <tr> <td>enumeration</td> <td>0060001</td> <td>documentation ja</td> </tr> <tr> <td>enumeration</td> <td>0060002</td> <td>documentation nein</td> </tr> </tbody> </table>	Kind	Value	Annotation	enumeration	0060001	documentation ja	enumeration	0060002	documentation nein
Kind	Value	Annotation								
enumeration	0060001	documentation ja								
enumeration	0060002	documentation nein								
source	<code><element name="OAK_ZusaetzlichePciSchluessel" type="enum_0060" minOccurs="0"/></code>									

element **OperationAortenklappeBasis/OAK_PciWegenKhkSchluessel**

diagram										
type	enum 0060									
properties	minOcc 0 maxOcc 1 content simple									
facets	<table border="1"> <thead> <tr> <th>Kind</th> <th>Value</th> <th>Annotation</th> </tr> </thead> <tbody> <tr> <td>enumeration</td> <td>0060001</td> <td>documentation ja</td> </tr> <tr> <td>enumeration</td> <td>0060002</td> <td>documentation nein</td> </tr> </tbody> </table>	Kind	Value	Annotation	enumeration	0060001	documentation ja	enumeration	0060002	documentation nein
Kind	Value	Annotation								
enumeration	0060001	documentation ja								
enumeration	0060002	documentation nein								
source	<code><element name="OAK_PciWegenKhkSchluessel" type="enum_0060" minOccurs="0"/></code>									

element **OperationAortenklappeBasis/OAK_PciWegenKomplikationSchluessel**

diagram										
type	enum 0060									
properties	minOcc 0 maxOcc 1 content simple									
facets	<table border="1"> <thead> <tr> <th>Kind</th> <th>Value</th> <th>Annotation</th> </tr> </thead> <tbody> <tr> <td>enumeration</td> <td>0060001</td> <td>documentation ja</td> </tr> <tr> <td>enumeration</td> <td>0060002</td> <td>documentation nein</td> </tr> </tbody> </table>	Kind	Value	Annotation	enumeration	0060001	documentation ja	enumeration	0060002	documentation nein
Kind	Value	Annotation								
enumeration	0060001	documentation ja								
enumeration	0060002	documentation nein								
source	<code><element name="OAK_PciWegenKomplikationSchluessel" type="enum_0060" minOccurs="0"/></code>									

element **OperationAortenklappeBasis/OAK_LaesionenAnzahl**

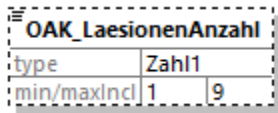
diagram										
type	Zahl1									
properties	minOcc 0 maxOcc 1 content simple									
facets	<table border="1"> <thead> <tr> <th>Kind</th> <th>Value</th> <th>Annotation</th> </tr> </thead> <tbody> <tr> <td>minInclusive</td> <td>1</td> <td></td> </tr> <tr> <td>maxInclusive</td> <td>9</td> <td></td> </tr> </tbody> </table>	Kind	Value	Annotation	minInclusive	1		maxInclusive	9	
Kind	Value	Annotation								
minInclusive	1									
maxInclusive	9									
source	<code><element name="OAK_LaesionenAnzahl" type="Zahl1" minOccurs="0"/></code>									

complexType **TaviAortenklappeBasis**

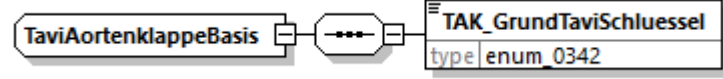
diagram	
namespace	http://xml.ir-d.de/emg
children	TAK_GrundTaviSchluessel
used by	element OperationAortenklappe/taviAortenklappe
source	<code><complexType name="TaviAortenklappeBasis"> <sequence> <element name="TAK_GrundTaviSchluessel" type="enum_0342"/> </sequence> </complexType></code>

element **TaviAortenklappeBasis/TAK_GrundTaviSchluessel**

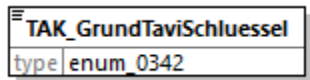
diagram																						
type	enum_0342																					
properties	content simple																					
facets	<table border="1"> <thead> <tr> <th>Kind</th> <th>Value</th> <th>Annotation</th> </tr> </thead> <tbody> <tr> <td>enumeration</td> <td>0342001</td> <td>documentation Alter</td> </tr> <tr> <td>enumeration</td> <td>0342002</td> <td>documentation Frailty</td> </tr> <tr> <td>enumeration</td> <td>0342003</td> <td>documentation Hochrisiko</td> </tr> <tr> <td>enumeration</td> <td>0342004</td> <td>documentation Prognose-limitierende Zweiterkrankung</td> </tr> <tr> <td>enumeration</td> <td>0342005</td> <td>documentation Porzellan-Aorta</td> </tr> <tr> <td>enumeration</td> <td>0342042</td> <td>documentation Sonstige</td> </tr> </tbody> </table>	Kind	Value	Annotation	enumeration	0342001	documentation Alter	enumeration	0342002	documentation Frailty	enumeration	0342003	documentation Hochrisiko	enumeration	0342004	documentation Prognose-limitierende Zweiterkrankung	enumeration	0342005	documentation Porzellan-Aorta	enumeration	0342042	documentation Sonstige
Kind	Value	Annotation																				
enumeration	0342001	documentation Alter																				
enumeration	0342002	documentation Frailty																				
enumeration	0342003	documentation Hochrisiko																				
enumeration	0342004	documentation Prognose-limitierende Zweiterkrankung																				
enumeration	0342005	documentation Porzellan-Aorta																				
enumeration	0342042	documentation Sonstige																				
source	<code><element name="TAK_GrundTaviSchluessel" type="enum_0342"/></code>																					

complexType **ProzedurenSchluesselAortenklappeBasis**

diagram	
namespace	http://xml.ir-d.de/emg
children	PAK_ProzedurenSchluessel
used by	element OperationAortenklappe/prozedurenSchluesselAortenklappe
source	<pre><complexType name="ProzedurenSchluesselAortenklappeBasis"> <sequence> <element name="PAK_ProzedurenSchluessel" type="OPS"/> </sequence> </complexType></pre>

element **ProzedurenSchluesselAortenklappeBasis/PAK_ProzedurenSchluessel**

diagram							
type	OPS						
properties	content simple						
facets	<table border="1"> <thead> <tr> <th>Kind</th> <th>Value</th> <th>Annotation</th> </tr> </thead> <tbody> <tr> <td>pattern</td> <td>(([135689]\-([0-9]){2}([a-zA-Z0-9]){1}\.([a-zA-Z0-9]{1,2}))*(:[RLBrlb])?)</td> <td></td> </tr> </tbody> </table>	Kind	Value	Annotation	pattern	(([135689]\-([0-9]){2}([a-zA-Z0-9]){1}\.([a-zA-Z0-9]{1,2}))*(:[RLBrlb])?)	
Kind	Value	Annotation					
pattern	(([135689]\-([0-9]){2}([a-zA-Z0-9]){1}\.([a-zA-Z0-9]{1,2}))*(:[RLBrlb])?)						
source	<pre><element name="PAK_ProzedurenSchluessel" type="OPS"/></pre>						

complexType **FailureGrundAortenklappeBasis**

diagram	
namespace	http://xml.ir-d.de/emg
children	FAK_FailureGrundSchluessel
used by	element OperationAortenklappe/failureGrundAortenklappe
source	<pre><complexType name="FailureGrundAortenklappeBasis"> <sequence> <element name="FAK_FailureGrundSchluessel" type="enum_0341"/> </sequence> </complexType></pre>

element **FailureGrundAortenklappeBasis/FAK_FailureGrundSchluessel**

diagram	
---------	--

type	enum 0341		
properties	content simple		
facets	Kind	Value	Annotation
	enumeration	0341001	documentation intraprozedural verstorben
	enumeration	0341002	documentation Implantation von mehr als einer Prothese
	enumeration	0341003	documentation gravierende Gefäß- oder Zugangskomplikation (gemäß VARC-3)
	enumeration	0341004	documentation erforderlicher chirurgischer oder interventioneller Eingriff wegen einer Klappenfehlfunktion (gemäß VARC-3)
	enumeration	0341005	documentation >= große strukturelle kardiale Komplikation (gemäß VARC-3)
source	<code><element name="FAK_FailureGrundSchluessel" type="enum_0341"/></code>		

complexType **PciAortenklappeBasis**

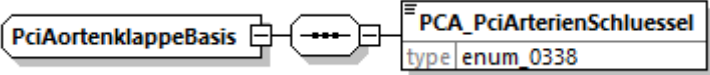
diagram	
namespace	http://xml.ir-d.de/emg
children	PCA_PciArterienSchluessel
used by	element OperationAortenklappe/pciAortenklappe
source	<code><complexType name="PciAortenklappeBasis"> <sequence> <element name="PCA_PciArterienSchluessel" type="enum_0338"/> </sequence> </complexType></code>

element **PciAortenklappeBasis/PCA_PciArterienSchluessel**

diagram			
type	enum 0338		
properties	content simple		
facets	Kind	Value	Annotation
	enumeration	0338001	documentation LAD
	enumeration	0338002	documentation RCA
	enumeration	0338003	documentation RCX
	enumeration	0338004	documentation Hauptstamm
source	<code><element name="PCA_PciArterienSchluessel" type="enum_0338"/></code>		

complexType **KomplikationAortenklappeBasis**

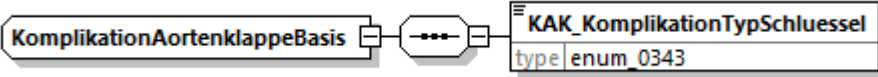
diagram	
namespace	http://xml.ir-d.de/emg
children	KAK KomplikationTypSchluessel
used by	element OperationAortenklappe/komplikationAortenklappe
source	<pre><complexType name="KomplikationAortenklappeBasis"> <sequence> <element name="KAK_KomplikationTypSchluessel" type="enum_0343"/> </sequence> </complexType></pre>

element **KomplikationAortenklappeBasis/KAK_KomplikationTypSchluessel**

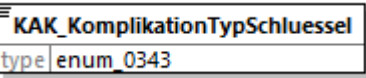
diagram																																																										
type	enum 0343																																																									
properties	content simple																																																									
facets	<table border="1"> <thead> <tr> <th>Kind</th> <th>Value</th> <th>Annotation</th> </tr> </thead> <tbody> <tr> <td>enumeration</td> <td>0343001</td> <td>documentation Device-Fehlpositionierung</td> </tr> <tr> <td>enumeration</td> <td>0343002</td> <td>documentation Koronarostienverschluss</td> </tr> <tr> <td>enumeration</td> <td>0343003</td> <td>documentation Aortendissektion</td> </tr> <tr> <td>enumeration</td> <td>0343004</td> <td>documentation Aortenregurgitation &gt; = 2. Grades</td> </tr> <tr> <td>enumeration</td> <td>0343005</td> <td>documentation Annulus-Ruptur</td> </tr> <tr> <td>enumeration</td> <td>0343006</td> <td>documentation Ruptur-/Perforation einer Herzhöhle ohne Therapiebedarf</td> </tr> <tr> <td>enumeration</td> <td>0343007</td> <td>documentation Ruptur-/Perforation einer Herzhöhle mit Therapiebedarf</td> </tr> <tr> <td>enumeration</td> <td>0343008</td> <td>documentation Perikardtamponade</td> </tr> <tr> <td>enumeration</td> <td>0343009</td> <td>documentation kardiale Dekompensation</td> </tr> <tr> <td>enumeration</td> <td>0343010</td> <td>documentation Hirnembolie</td> </tr> <tr> <td>enumeration</td> <td>0343011</td> <td>documentation Rhythmusstörungen</td> </tr> <tr> <td>enumeration</td> <td>0343012</td> <td>documentation Device-Embolisation</td> </tr> <tr> <td>enumeration</td> <td>0343013</td> <td>documentation vaskuläre Komplikation</td> </tr> <tr> <td>enumeration</td> <td>0343014</td> <td>documentation Low Cardiac Output</td> </tr> <tr> <td>enumeration</td> <td>0343015</td> <td>documentation schwerwiegende Blutungen (intraprozedural)</td> </tr> <tr> <td>enumeration</td> <td>0343016</td> <td>documentation lebensbedrohliche Blutungen (intraprozedural)</td> </tr> <tr> <td>enumeration</td> <td>0343017</td> <td>documentation Patient verstarb im OP/Katheterlabor</td> </tr> <tr> <td>enumeration</td> <td>0343042</td> <td>documentation</td> </tr> </tbody> </table>	Kind	Value	Annotation	enumeration	0343001	documentation Device-Fehlpositionierung	enumeration	0343002	documentation Koronarostienverschluss	enumeration	0343003	documentation Aortendissektion	enumeration	0343004	documentation Aortenregurgitation > = 2. Grades	enumeration	0343005	documentation Annulus-Ruptur	enumeration	0343006	documentation Ruptur-/Perforation einer Herzhöhle ohne Therapiebedarf	enumeration	0343007	documentation Ruptur-/Perforation einer Herzhöhle mit Therapiebedarf	enumeration	0343008	documentation Perikardtamponade	enumeration	0343009	documentation kardiale Dekompensation	enumeration	0343010	documentation Hirnembolie	enumeration	0343011	documentation Rhythmusstörungen	enumeration	0343012	documentation Device-Embolisation	enumeration	0343013	documentation vaskuläre Komplikation	enumeration	0343014	documentation Low Cardiac Output	enumeration	0343015	documentation schwerwiegende Blutungen (intraprozedural)	enumeration	0343016	documentation lebensbedrohliche Blutungen (intraprozedural)	enumeration	0343017	documentation Patient verstarb im OP/Katheterlabor	enumeration	0343042	documentation
Kind	Value	Annotation																																																								
enumeration	0343001	documentation Device-Fehlpositionierung																																																								
enumeration	0343002	documentation Koronarostienverschluss																																																								
enumeration	0343003	documentation Aortendissektion																																																								
enumeration	0343004	documentation Aortenregurgitation > = 2. Grades																																																								
enumeration	0343005	documentation Annulus-Ruptur																																																								
enumeration	0343006	documentation Ruptur-/Perforation einer Herzhöhle ohne Therapiebedarf																																																								
enumeration	0343007	documentation Ruptur-/Perforation einer Herzhöhle mit Therapiebedarf																																																								
enumeration	0343008	documentation Perikardtamponade																																																								
enumeration	0343009	documentation kardiale Dekompensation																																																								
enumeration	0343010	documentation Hirnembolie																																																								
enumeration	0343011	documentation Rhythmusstörungen																																																								
enumeration	0343012	documentation Device-Embolisation																																																								
enumeration	0343013	documentation vaskuläre Komplikation																																																								
enumeration	0343014	documentation Low Cardiac Output																																																								
enumeration	0343015	documentation schwerwiegende Blutungen (intraprozedural)																																																								
enumeration	0343016	documentation lebensbedrohliche Blutungen (intraprozedural)																																																								
enumeration	0343017	documentation Patient verstarb im OP/Katheterlabor																																																								
enumeration	0343042	documentation																																																								

sonstige intraprozedurale Komplikationen

source `<element name="KAK_KomplikationTypSchluessel" type="enum_0343"/>`

complexType **ArtikelidentifikationBasis**

diagram

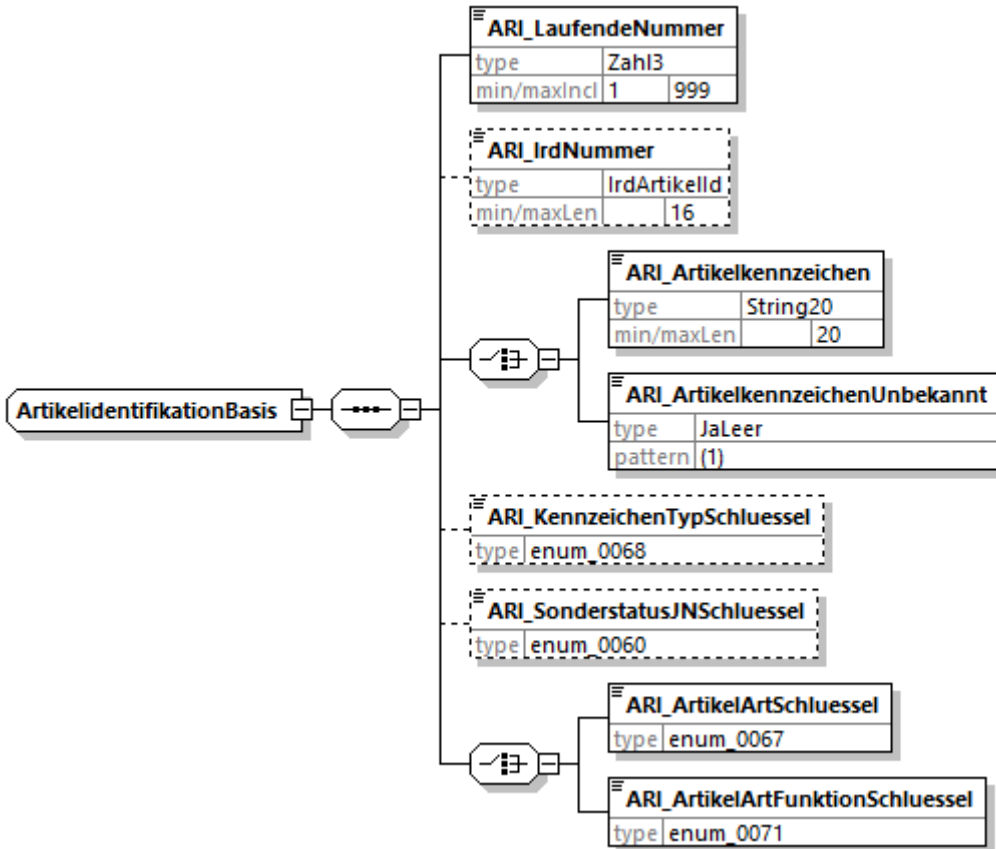

namespace `http://xml.ir-d.de/emg`

children [ARI LaufendeNummer](#) [ARI IrdNummer](#) [ARI Artikelkennzeichen](#) [ARI ArtikelkennzeichenUnbekannt](#) [ARI KennzeichenTypSchluessel](#) [ARI SonderstatusJNSchluessel](#) [ARI ArtikelArtSchluessel](#) [ARI ArtikelArtFunktionSchluessel](#)

used by complexType [Artikelidentifikation](#)

```

source <complexType name="ArtikelidentifikationBasis">
  <sequence>
    <element name="ARI_LaufendeNummer" type="Zahl3"/>
    <element name="ARI_IrdNummer" type="IrdArtikelId" minOccurs="0"/>
    <choice>
      <element name="ARI_Artikelkennzeichen" type="String20"/>
      <element name="ARI_ArtikelkennzeichenUnbekannt" type="JaLeer"/>
    </choice>
    <element name="ARI_KennzeichenTypSchluessel" type="enum_0068"
minOccurs="0"/>
    <element name="ARI_SonderstatusJNSchluessel" type="enum_0060"
minOccurs="0"/>
    <choice>
      <element name="ARI_ArtikelArtSchluessel" type="enum_0067"/>
      <element name="ARI_ArtikelArtFunktionSchluessel" type="enum_0071"/>
    </choice>
  </sequence>

```

	<code></complexType></code>
--	-----------------------------------

element **ArtikelidentifikationBasis/ARI_LaufendeNummer**

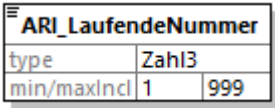
diagram										
type	Zahl3									
properties	content simple									
facets	<table border="1"><thead><tr><th>Kind</th><th>Value</th><th>Annotation</th></tr></thead><tbody><tr><td>minInclusive</td><td>1</td><td></td></tr><tr><td>maxInclusive</td><td>999</td><td></td></tr></tbody></table>	Kind	Value	Annotation	minInclusive	1		maxInclusive	999	
Kind	Value	Annotation								
minInclusive	1									
maxInclusive	999									
source	<code><element name="ARI_LaufendeNummer" type="Zahl3"/></code>									

element **ArtikelidentifikationBasis/ARI_IrdNummer**

diagram							
type	IrdArtikelId						
properties	minOcc 0 maxOcc 1 content simple						
facets	<table border="1"><thead><tr><th>Kind</th><th>Value</th><th>Annotation</th></tr></thead><tbody><tr><td>maxLength</td><td>16</td><td></td></tr></tbody></table>	Kind	Value	Annotation	maxLength	16	
Kind	Value	Annotation					
maxLength	16						
source	<code><element name="ARI_IrdNummer" type="IrdArtikelId" minOccurs="0"/></code>						

element **ArtikelidentifikationBasis/ARI_Artikelkennzeichen**

diagram							
type	String20						
properties	content simple						
facets	<table border="1"><thead><tr><th>Kind</th><th>Value</th><th>Annotation</th></tr></thead><tbody><tr><td>maxLength</td><td>20</td><td></td></tr></tbody></table>	Kind	Value	Annotation	maxLength	20	
Kind	Value	Annotation					
maxLength	20						
source	<code><element name="ARI_Artikelkennzeichen" type="String20"/></code>						

element **ArtikelidentifikationBasis/ARI_ArtikelkennzeichenUnbekannt**

diagram	
---------	---

type	JaLeer						
properties	content simple						
facets	<table border="1"> <thead> <tr> <th>Kind</th> <th>Value</th> <th>Annotation</th> </tr> </thead> <tbody> <tr> <td>pattern</td> <td>(1)</td> <td></td> </tr> </tbody> </table>	Kind	Value	Annotation	pattern	(1)	
Kind	Value	Annotation					
pattern	(1)						
source	<code><element name="ARI_ArtikelkennzeichenUnbekannt" type="JaLeer"/></code>						

element **ArtikelidentifikationBasis/ARI_KennzeichenTypSchluessel**

diagram																
type	enum_0068															
properties	<table border="1"> <tr> <td>minOcc</td> <td>0</td> </tr> <tr> <td>maxOcc</td> <td>1</td> </tr> <tr> <td>content</td> <td>simple</td> </tr> </table>	minOcc	0	maxOcc	1	content	simple									
minOcc	0															
maxOcc	1															
content	simple															
facets	<table border="1"> <thead> <tr> <th>Kind</th> <th>Value</th> <th>Annotation</th> </tr> </thead> <tbody> <tr> <td>enumeration</td> <td>0068001</td> <td>documentation UDI</td> </tr> <tr> <td>enumeration</td> <td>0068002</td> <td>documentation Referenz (REF)</td> </tr> <tr> <td>enumeration</td> <td>0068003</td> <td>documentation Katalognummer</td> </tr> <tr> <td>enumeration</td> <td>0068042</td> <td>documentation sonstiger</td> </tr> </tbody> </table>	Kind	Value	Annotation	enumeration	0068001	documentation UDI	enumeration	0068002	documentation Referenz (REF)	enumeration	0068003	documentation Katalognummer	enumeration	0068042	documentation sonstiger
Kind	Value	Annotation														
enumeration	0068001	documentation UDI														
enumeration	0068002	documentation Referenz (REF)														
enumeration	0068003	documentation Katalognummer														
enumeration	0068042	documentation sonstiger														
source	<code><element name="ARI_KennzeichenTypSchluessel" type="enum_0068" minOccurs="0"/></code>															

element **ArtikelidentifikationBasis/ARI_SonderstatusJNSchluessel**

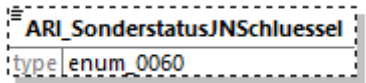
diagram										
type	enum_0060									
properties	<table border="1"> <tr> <td>minOcc</td> <td>0</td> </tr> <tr> <td>maxOcc</td> <td>1</td> </tr> <tr> <td>content</td> <td>simple</td> </tr> </table>	minOcc	0	maxOcc	1	content	simple			
minOcc	0									
maxOcc	1									
content	simple									
facets	<table border="1"> <thead> <tr> <th>Kind</th> <th>Value</th> <th>Annotation</th> </tr> </thead> <tbody> <tr> <td>enumeration</td> <td>0060001</td> <td>documentation ja</td> </tr> <tr> <td>enumeration</td> <td>0060002</td> <td>documentation nein</td> </tr> </tbody> </table>	Kind	Value	Annotation	enumeration	0060001	documentation ja	enumeration	0060002	documentation nein
Kind	Value	Annotation								
enumeration	0060001	documentation ja								
enumeration	0060002	documentation nein								
source	<code><element name="ARI_SonderstatusJNSchluessel" type="enum_0060" minOccurs="0"/></code>									

element **ArtikelidentifikationBasis/ARI_ArtikelArtSchluessel**

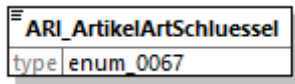
diagram							
type	enum_0067						
properties	content simple						
facets	<table border="1"> <thead> <tr> <th>Kind</th> <th>Value</th> <th>Annotation</th> </tr> </thead> <tbody> <tr> <td>enumeration</td> <td>0067001</td> <td>documentation</td> </tr> </tbody> </table>	Kind	Value	Annotation	enumeration	0067001	documentation
Kind	Value	Annotation					
enumeration	0067001	documentation					

	enumeration 0067002 Implantat documentation Explantat
source	<element name="ARI_ArtikelArtSchluessel" type="enum_0067"/>

element **ArtikelidentifikationBasis/ARI_ArtikelArtFunktionSchluessel**

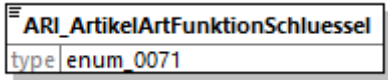
diagram													
type	enum_0071												
properties	content simple												
facets	<table border="1"> <thead> <tr> <th>Kind</th> <th>Value</th> <th>Annotation</th> </tr> </thead> <tbody> <tr> <td>enumeration</td> <td>0071001</td> <td>documentation Implantat</td> </tr> <tr> <td>enumeration</td> <td>0071002</td> <td>documentation Explantat</td> </tr> <tr> <td>enumeration</td> <td>0071003</td> <td>documentation Degeneriertes/defektes Produkt, das funktionslos im Körper verbleibt</td> </tr> </tbody> </table>	Kind	Value	Annotation	enumeration	0071001	documentation Implantat	enumeration	0071002	documentation Explantat	enumeration	0071003	documentation Degeneriertes/defektes Produkt, das funktionslos im Körper verbleibt
Kind	Value	Annotation											
enumeration	0071001	documentation Implantat											
enumeration	0071002	documentation Explantat											
enumeration	0071003	documentation Degeneriertes/defektes Produkt, das funktionslos im Körper verbleibt											
source	<element name="ARI_ArtikelArtFunktionSchluessel" type="enum_0071"/>												

complexType Artikelbeschreibung

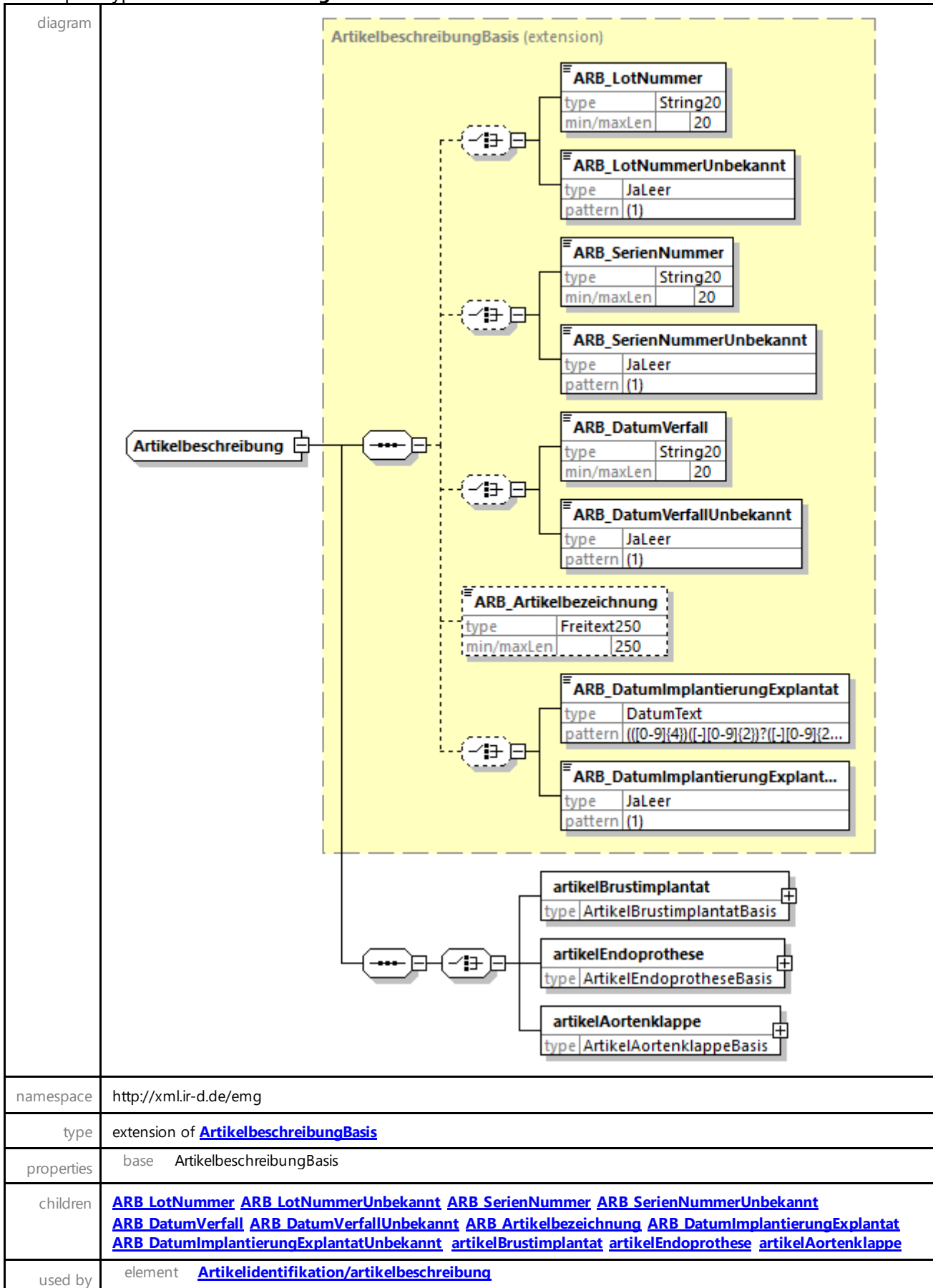

source

```
<complexType name="Artikelbeschreibung">
  <complexContent>
    <extension base="ArtikelbeschreibungBasis">
      <sequence>
        <choice>
          <element name="artikelBrustimplantat"
type="ArtikelBrustimplantatBasis"/>
          <element name="artikelEndoprothese"
type="ArtikelEndoprotheseBasis"/>
          <element name="artikelAortenklappe"
type="ArtikelAortenklappeBasis"/>
        </choice>
      </sequence>
    </extension>
  </complexContent>
</complexType>
```

element **Artikelbeschreibung/artikelBrustimplantat**

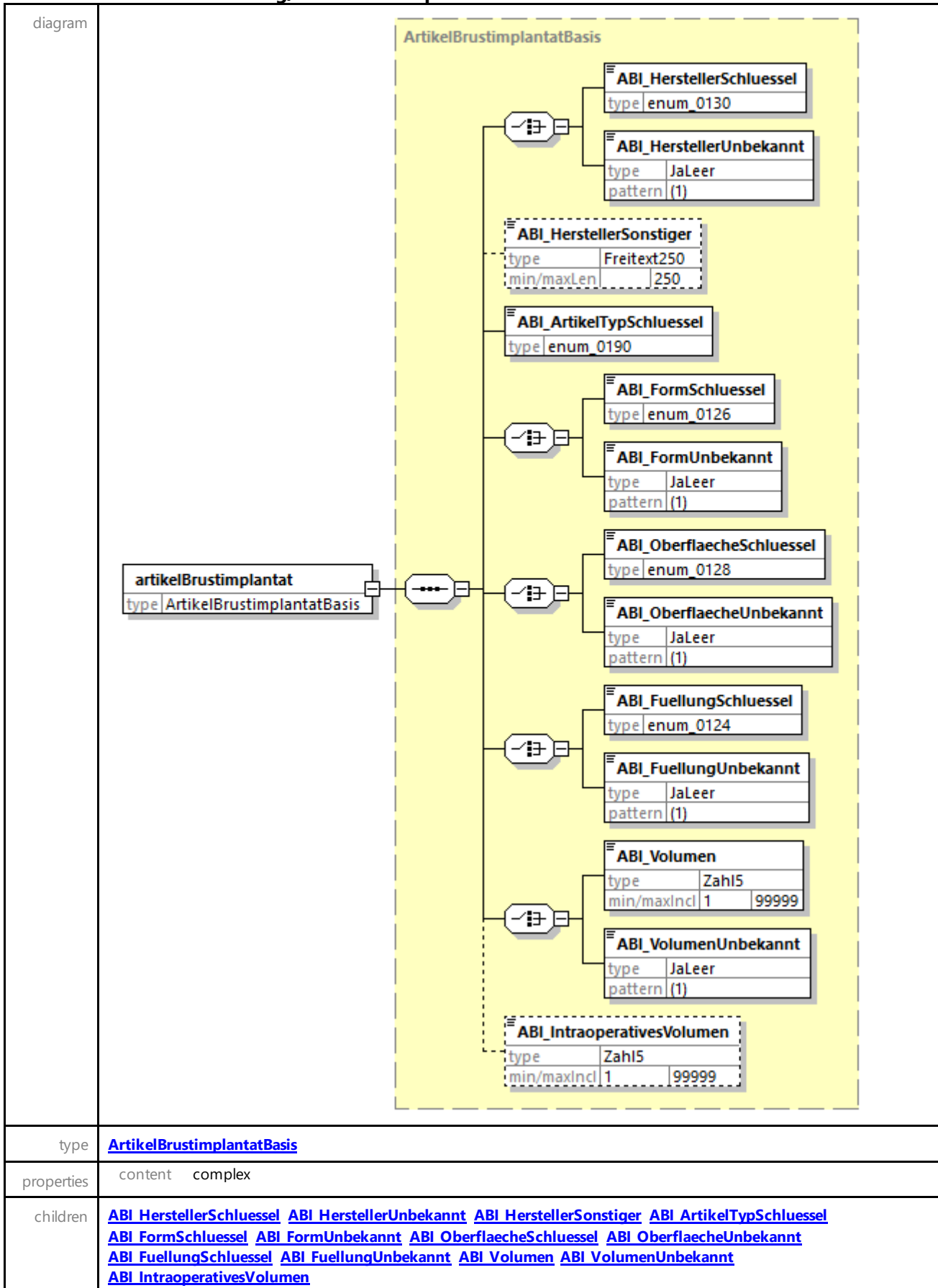

source	<code><element name="artikelBrustimplantat" type="ArtikelBrustimplantatBasis"/></code>
--------	--

element **Artikelbeschreibung/artikelEndoprothese**

diagram	<p>The diagram illustrates the structure of the 'artikelEndoprothese' element. It is a complex type derived from 'ArtikelEndoprotheseBasis'. The 'artikelEndoprothese' element is connected to a container (dashed box) labeled 'ArtikelEndoprotheseBasis'. This container contains four child elements:</p> <ul style="list-style-type: none"> AEP_HerstellerSchluessel: type enum_0230 AEP_HerstellerUnbekannt: type JaLeer, pattern (1) AEP_HerstellerSonstiger: type Freitext250, min/maxLen 250 AEP_ArtikelTypSchluessel: type enum_0290
type	ArtikelEndoprotheseBasis
properties	content complex
children	AEP_HerstellerSchluessel AEP_HerstellerUnbekannt AEP_HerstellerSonstiger AEP_ArtikelTypSchluessel
source	<code><element name="artikelEndoprothese" type="ArtikelEndoprotheseBasis"/></code>

element **Artikelbeschreibung/artikelAortenklappe**

<p>diagram</p>	
<p>type</p>	<p>ArtikelAortenklappeBasis</p>
<p>properties</p>	<p>content complex</p>
<p>children</p>	<p>AAK ArtikelTypSchluessel AAK HerstellerSchluessel AAK HerstellerUnbekannt AAK HerstellerSonstiger AAK ProthesenGroesse AAK ProthesenGroesseUnbekannt AAK Dislokation</p>
<p>source</p>	<p><code><element name="artikelAortenklappe" type="ArtikelAortenklappeBasis"/></code></p>

complexType **ZubehoerBasis**

<p>diagram</p>	
<p>namespace</p>	<p>http://xml.ir-d.de/emg</p>
<p>children</p>	<p>ZUB LaufendeNummer ZUB ZubehoerArtSchluessel ZUB ArtikelNummer ZUB ArtikelNummerUnbekannt ZUB LotNummer ZUB LotNummerUnbekannt ZUB SerienNummer ZUB SerienNummerUnbekannt ZUB Artikelbezeichnung</p>
<p>used by</p>	<p>complexType Zubehoer</p>
<p>source</p>	<pre><complexType name="ZubehoerBasis"> <sequence> <element name="ZUB_LaufendeNummer" type="Zahl3"/> <element name="ZUB_ZubehoerArtSchluessel" type="enum_0069"/> <choice> <element name="ZUB_ArtikelNummer" type="String20"/> <element name="ZUB_ArtikelNummerUnbekannt" type="JaLeer"/> </choice> <choice minOccurs="0"> <element name="ZUB_LotNummer" type="String20"/> <element name="ZUB_LotNummerUnbekannt" type="JaLeer"/> </choice> <choice minOccurs="0"> <element name="ZUB_SerienNummer" type="String20"/> <element name="ZUB_SerienNummerUnbekannt" type="JaLeer"/> </choice> </sequence> </complexType></pre>

	<pre><element name="ZUB_Artikelbezeichnung" type="Freitext250" minOccurs="0"/> </sequence> </complexType></pre>
--	---

element **ZubehoerBasis/ZUB_LaufendeNummer**

diagram										
type	Zahl3									
properties	content simple									
facets	<table border="1"> <thead> <tr> <th>Kind</th> <th>Value</th> <th>Annotation</th> </tr> </thead> <tbody> <tr> <td>minInclusive</td> <td>1</td> <td></td> </tr> <tr> <td>maxInclusive</td> <td>999</td> <td></td> </tr> </tbody> </table>	Kind	Value	Annotation	minInclusive	1		maxInclusive	999	
Kind	Value	Annotation								
minInclusive	1									
maxInclusive	999									
source	<pre><element name="ZUB_LaufendeNummer" type="Zahl3"/></pre>									

element **ZubehoerBasis/ZUB_ZubehoerArtSchluessel**

diagram										
type	enum_0069									
properties	content simple									
facets	<table border="1"> <thead> <tr> <th>Kind</th> <th>Value</th> <th>Annotation</th> </tr> </thead> <tbody> <tr> <td>enumeration</td> <td>0069001</td> <td>documentation Implantat</td> </tr> <tr> <td>enumeration</td> <td>0069002</td> <td>documentation Explantat</td> </tr> </tbody> </table>	Kind	Value	Annotation	enumeration	0069001	documentation Implantat	enumeration	0069002	documentation Explantat
Kind	Value	Annotation								
enumeration	0069001	documentation Implantat								
enumeration	0069002	documentation Explantat								
source	<pre><element name="ZUB_ZubehoerArtSchluessel" type="enum_0069"/></pre>									

element **ZubehoerBasis/ZUB_ArtikelNummer**

diagram							
type	String20						
properties	content simple						
facets	<table border="1"> <thead> <tr> <th>Kind</th> <th>Value</th> <th>Annotation</th> </tr> </thead> <tbody> <tr> <td>maxLength</td> <td>20</td> <td></td> </tr> </tbody> </table>	Kind	Value	Annotation	maxLength	20	
Kind	Value	Annotation					
maxLength	20						
source	<pre><element name="ZUB_ArtikelNummer" type="String20"/></pre>						

element **ZubehoerBasis/ZUB_ArtikelNummerUnbekannt**

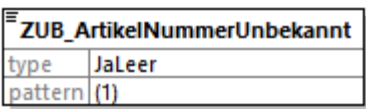
diagram	
type	JaLeer
properties	content simple
facets	Kind Value Annotation pattern (1)
source	<code><element name="ZUB_ArtikelNummerUnbekannt" type="JaLeer"/></code>

element **ZubehoerBasis/ZUB_LotNummer**

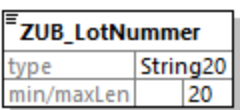
diagram	
type	String20
properties	content simple
facets	Kind Value Annotation maxLength 20
source	<code><element name="ZUB_LotNummer" type="String20"/></code>

element **ZubehoerBasis/ZUB_LotNummerUnbekannt**

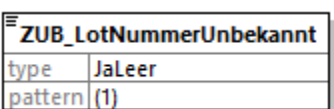
diagram	
type	JaLeer
properties	content simple
facets	Kind Value Annotation pattern (1)
source	<code><element name="ZUB_LotNummerUnbekannt" type="JaLeer"/></code>

element **ZubehoerBasis/ZUB_SerienNummer**

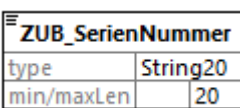
diagram	
type	String20
properties	content simple
facets	Kind Value Annotation maxLength 20
source	<code><element name="ZUB_SerienNummer" type="String20"/></code>

element **ZubehoerBasis/ZUB_SerienNummerUnbekannt**

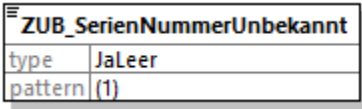
diagram							
type	JaLeer						
properties	content simple						
facets	<table border="1"> <thead> <tr> <th>Kind</th> <th>Value</th> <th>Annotation</th> </tr> </thead> <tbody> <tr> <td>pattern</td> <td>(1)</td> <td></td> </tr> </tbody> </table>	Kind	Value	Annotation	pattern	(1)	
Kind	Value	Annotation					
pattern	(1)						
source	<code><element name="ZUB_SerienNummerUnbekannt" type="JaLeer"/></code>						

element **ZubehoerBasis/ZUB_Artikelbezeichnung**

diagram							
type	Freitext250						
properties	<table border="1"> <tbody> <tr> <td>minOcc</td> <td>0</td> </tr> <tr> <td>maxOcc</td> <td>1</td> </tr> <tr> <td>content</td> <td>simple</td> </tr> </tbody> </table>	minOcc	0	maxOcc	1	content	simple
minOcc	0						
maxOcc	1						
content	simple						
facets	<table border="1"> <thead> <tr> <th>Kind</th> <th>Value</th> <th>Annotation</th> </tr> </thead> <tbody> <tr> <td>maxLength</td> <td>250</td> <td></td> </tr> </tbody> </table>	Kind	Value	Annotation	maxLength	250	
Kind	Value	Annotation					
maxLength	250						
source	<code><element name="ZUB_Artikelbezeichnung" type="Freitext250" minOccurs="0"/></code>						

complexType **ZubehoerBrustimplantatBasis**

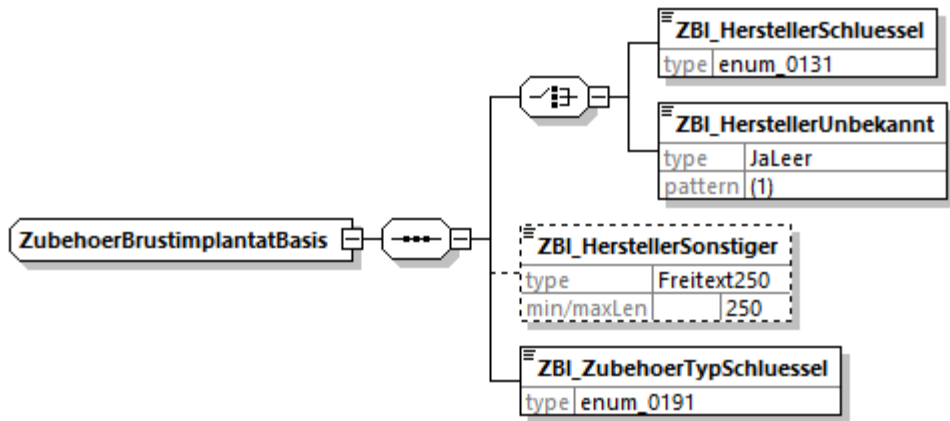
diagram	
namespace	http://xml.ir-d.de/emg
children	ZBI_HerstellerSchluessel ZBI_HerstellerUnbekannt ZBI_HerstellerSonstiger ZBI_ZubehoerTypSchluessel
used by	element Zubehoer/zubehoerBrustimplantat
source	<pre> <complexType name="ZubehoerBrustimplantatBasis"> <sequence> <choice> <element name="ZBI_HerstellerSchluessel" type="enum_0131"/> </pre>

```

<element name="ZBI_HerstellerUnbekannt" type="JaLeer"/>
</choice>
<element name="ZBI_HerstellerSonstiger" type="Freitext250" minOccurs="0"/>
<element name="ZBI_ZubehoerTypSchluessel" type="enum_0191"/>
</sequence>
</complexType>

```

element **ZubehoerBrustimplantatBasis/ZBI_HerstellerSchluessel**

diagram			
type	enum 0131		
properties	content simple		
facets	Kind	Value	Annotation
	enumeration	0131001	documentation Allergan
	enumeration	0131002	documentation Establishment labs
	enumeration	0131003	documentation Eurosilicone
	enumeration	0131004	documentation Galatea
	enumeration	0131005	documentation Integra
	enumeration	0131006	documentation Lifecell
	enumeration	0131007	documentation MBP (Medical Biomaterial Products)
	enumeration	0131008	documentation Mentor
	enumeration	0131009	documentation Novus Scientific
	enumeration	0131042	documentation sonstiger
source	<code><element name="ZBI_HerstellerSchluessel" type="enum_0131"/></code>		

element **ZubehoerBrustimplantatBasis/ZBI_HerstellerUnbekannt**

diagram			
type	JaLeer		
properties	content simple		
facets	Kind	Value	Annotation
	pattern	(1)	
source	<code><element name="ZBI_HerstellerUnbekannt" type="JaLeer"/></code>		

element **ZubehoerBrustimplantatBasis/ZBI_HerstellerSonstiger**

diagram	
type	Freitext250
properties	minOcc 0 maxOcc 1 content simple
facets	Kind Value Annotation maxLength 250
source	<code><element name="ZBI_HerstellerSonstiger" type="Freitext250" minOccurs="0"/></code>

element **ZubehoerBrustimplantatBasis/ZBI_ZubehoerTypSchluessel**

diagram	
type	enum 0191
properties	content simple
facets	Kind Value Annotation enumeration 0191001 documentation Netz enumeration 0191002 documentation ADM
source	<code><element name="ZBI_ZubehoerTypSchluessel" type="enum_0191"/></code>

complexType **ZubehoerEndoprotheseBasis**

diagram	
namespace	http://xml.ir-d.de/emg
children	ZEP_HerstellerSchluessel ZEP_HerstellerUnbekannt ZEP_HerstellerSonstiger ZEP_ZubehoerTypSchluessel

	ZEP Menge ZEP EinheitSchluessel
used by	element Zubehoer/zubehoerEndoprothese
source	<pre><complexType name="ZubehoerEndoprotheseBasis"> <sequence> <choice> <element name="ZEP_HerstellerSchluessel" type="enum_0230"/> <element name="ZEP_HerstellerUnbekannt" type="JaLeer"/> </choice> <element name="ZEP_HerstellerSonstiger" type="Freitext250" minOccurs="0"/> <element name="ZEP_ZubehoerTypSchluessel" type="enum_0291"/> <element name="ZEP_Menge" type="Zahl5"/> <element name="ZEP_EinheitSchluessel" type="enum_0062"/> </sequence> </complexType></pre>

element [ZubehoerEndoprotheseBasis/ZEP_HerstellerSchluessel](#)

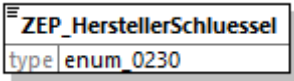
diagram			
type	enum 0230		
properties	content simple		
facets	Kind	Value	Annotation
	enumeration	0230001	documentation Smith & Nephew GmbH
	enumeration	0230002	documentation Mathys Orthopädie GmbH
	enumeration	0230003	documentation Ceramtec AG
	enumeration	0230004	documentation Biomet
	enumeration	0230005	documentation Peter Brehm GmbH
	enumeration	0230006	documentation Amplitude GmbH
	enumeration	0230007	documentation Exactech Deutschland
	enumeration	0230008	documentation Globus Medical
	enumeration	0230009	documentation Implantcast GmbH
	enumeration	0230010	documentation DePuy Orthopädie GmbH
	enumeration	0230011	documentation IO-International Orthopaedics
	enumeration	0230012	documentation Joint Replacement Ltd. Instrumentation
	enumeration	0230013	documentation Merete
	enumeration	0230014	documentation S&G Implants GmbH
	enumeration	0230015	documentation Speetec Implantate GmbH
	enumeration	0230016	documentation Stemcup Medical Products GmbH
	enumeration	0230017	documentation Symbios Deutschland GmbH
	enumeration	0230018	documentation

	enumeration	0230019	Tantum AG documentation
	enumeration	0230020	Tomier GmbH documentation
	enumeration	0230021	MicroPort Orthopedics GmbH documentation
	enumeration	0230022	aap Implanate AG documentation
	enumeration	0230023	AQImplants documentation
	enumeration	0230024	ESKA Orthodynamics GmbH documentation
	enumeration	0230025	Atesos medical AG documentation
	enumeration	0230026	Chiropro GmbH documentation
	enumeration	0230027	Medacta documentation
	enumeration	0230028	OHST Medizintechnik AG documentation
	enumeration	0230029	Lima Deutschland GmbH documentation
	enumeration	0230030	alloPlus GmbH documentation
	enumeration	0230031	Heraeus Medical GmbH documentation
	enumeration	0230032	ImplanTec Deutschland GmbH documentation
	enumeration	0230033	Falcon Medical GmbH documentation
	enumeration	0230034	Meril GmbH documentation
	enumeration	0230035	Zimmer Germany GmbH documentation
	enumeration	0230036	Stryker GmbH & Co. KG documentation
	enumeration	0230037	Aesculap AG documentation
	enumeration	0230038	Waldemar Link GmbH & Co. KG documentation
	enumeration	0230039	Corin Germany GmbH documentation
	enumeration	0230040	nicht belegter Wert documentation
	enumeration	0230041	nicht belegter Wert documentation
	enumeration	0230042	nicht belegter Wert documentation
	enumeration	0230043	sonstige documentation
	enumeration	0230044	nicht belegter Wert documentation
source	<code><element name="ZEP_HerstellerSchluesse1" type="enum_0230"/></code>		

element **ZubehoerEndoprotheseBasis/ZEP_HerstellerUnbekannt**

diagram	<pre> classDiagram class ZEP_HerstellerUnbekannt { type JaLeer pattern (1) } </pre>
---------	---

type	JaLeer
properties	content simple
facets	Kind Value Annotation pattern (1)
source	<code><element name="ZEP_HerstellerUnbekannt" type="JaLeer"/></code>

element **ZubehoerEndoprotheseBasis/ZEP_HerstellerSonstiger**

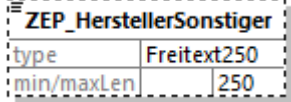
diagram	
type	Freitext250
properties	minOcc 0 maxOcc 1 content simple
facets	Kind Value Annotation maxLength 250
source	<code><element name="ZEP_HerstellerSonstiger" type="Freitext250" minOccurs="0"/></code>

element **ZubehoerEndoprotheseBasis/ZEP_ZubehoerTypSchluessel**

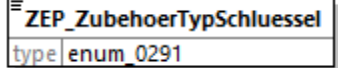
diagram	
type	enum 0291
properties	content simple
facets	Kind Value Annotation enumeration 0291001 documentation Knochen-Zement enumeration 0291002 documentation sonstiges Zubehör
source	<code><element name="ZEP_ZubehoerTypSchluessel" type="enum_0291"/></code>

element **ZubehoerEndoprotheseBasis/ZEP_Menge**

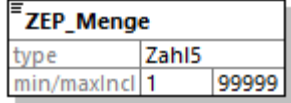
diagram	
type	Zahl5
properties	content simple
facets	Kind Value Annotation minInclusive 1 maxInclusive 99999
source	<code><element name="ZEP_Menge" type="Zahl5"/></code>

element **ZubehoerEndoprotheseBasis/ZEP_EinheitSchluessel**

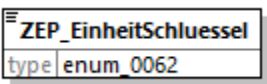
diagram			
type	enum 0062		
properties	content simple		
facets	Kind	Value	Annotation
	enumeration	0062001	documentation Stück
	enumeration	0062002	documentation g
	enumeration	0062003	documentation mg
	enumeration	0062004	documentation l
	enumeration	0062005	documentation ml
	enumeration	0062006	documentation cm ³
	enumeration	0062007	documentation mm
	enumeration	0062008	documentation cm
	enumeration	0062009	documentation dm
	enumeration	0062010	documentation m
	enumeration	0062042	documentation andere
source	<code><element name="ZEP_EinheitSchluessel" type="enum_0062"/></code>		

complexType PatientenaufnahmeAortenklappeBasis

diagram

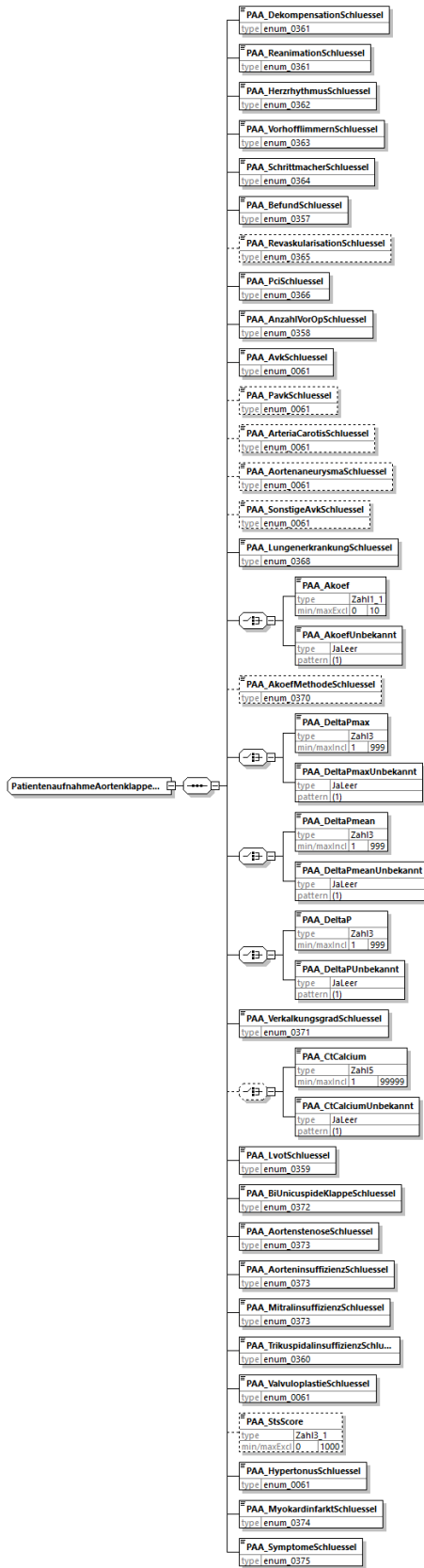

namespace <http://xml.ir-d.de/emg>

children [PAA DekompensationSchlüssel](#) [PAA ReanimationSchlüssel](#) [PAA HerzrhythmusSchlüssel](#) [PAA VorhofflimmernSchlüssel](#) [PAA SchrittmacherSchlüssel](#) [PAA BefundSchlüssel](#)

	PAA RevaskularisationSchluessel PAA PciSchluessel PAA AnzahlVorOpSchluessel PAA AvkSchluessel PAA PavkSchluessel PAA ArteriaCarotisSchluessel PAA AortenaneurysmaSchluessel PAA SonstigeAvkSchluessel PAA LungenerkrankungSchluessel PAA Akoef PAA AkoefUnbekannt PAA AkoefMethodeSchluessel PAA DeltaPmax PAA DeltaPmaxUnbekannt PAA DeltaPmean PAA DeltaPmeanUnbekannt PAA DeltaP PAA DeltaPUnbekannt PAA VerkalkungsgradSchluessel PAA CtCalcium PAA CtCalciumUnbekannt PAA LvotSchluessel PAA BiUnicuspideKlappeSchluessel PAA AortenstenoseSchluessel PAA AorteninsuffizienzSchluessel PAA MitralinsuffizienzSchluessel PAA TrikuspidalinsuffizienzSchluessel PAA ValvuloplastieSchluessel PAA StsScore PAA HypertonusSchluessel PAA MyokardinfarktSchluessel PAA SymptomeSchluessel
used by	complexType PatientenaufnahmeAortenklappe
source	<pre> <complexType name="PatientenaufnahmeAortenklappeBasis"> <sequence> <element name="PAA_DekompensationSchluessel" type="enum_0361"/> <element name="PAA_ReanimationSchluessel" type="enum_0361"/> <element name="PAA_HerzrhythmusSchluessel" type="enum_0362"/> <element name="PAA_VorhofflimmernSchluessel" type="enum_0363"/> <element name="PAA_SchrittmacherSchluessel" type="enum_0364"/> <element name="PAA_BefundSchluessel" type="enum_0357"/> <element name="PAA_RevaskularisationSchluessel" type="enum_0365" minOccurs="0"/> <element name="PAA_PciSchluessel" type="enum_0366"/> <element name="PAA_AnzahlVorOpSchluessel" type="enum_0358"/> <element name="PAA_AvkSchluessel" type="enum_0061"/> <element name="PAA_PavkSchluessel" type="enum_0061" minOccurs="0"/> <element name="PAA_ArteriaCarotisSchluessel" type="enum_0061" minOccurs="0"/> <element name="PAA_AortenaneurysmaSchluessel" type="enum_0061" minOccurs="0"/> <element name="PAA_SonstigeAvkSchluessel" type="enum_0061" minOccurs="0"/> <element name="PAA_LungenerkrankungSchluessel" type="enum_0368"/> <choice> <element name="PAA_Akoef" type="Zahl1_1"/> <element name="PAA_AkoefUnbekannt" type="JaLeer"/> </choice> <element name="PAA_AkoefMethodeSchluessel" type="enum_0370" minOccurs="0"/> <choice> <element name="PAA_DeltaPmax" type="Zahl3"/> <element name="PAA_DeltaPmaxUnbekannt" type="JaLeer"/> </choice> <choice> <element name="PAA_DeltaPmean" type="Zahl3"/> <element name="PAA_DeltaPmeanUnbekannt" type="JaLeer"/> </choice> <choice> <element name="PAA_DeltaP" type="Zahl3"/> <element name="PAA_DeltaPUnbekannt" type="JaLeer"/> </choice> <element name="PAA_VerkalkungsgradSchluessel" type="enum_0371"/> <choice minOccurs="0"> <element name="PAA_CtCalcium" type="Zahl15"/> <element name="PAA_CtCalciumUnbekannt" type="JaLeer"/> </choice> <element name="PAA_LvotSchluessel" type="enum_0359"/> <element name="PAA_BiUnicuspideKlappeSchluessel" type="enum_0372"/> <element name="PAA_AortenstenoseSchluessel" type="enum_0373"/> <element name="PAA_AorteninsuffizienzSchluessel" type="enum_0373"/> <element name="PAA_MitralinsuffizienzSchluessel" type="enum_0373"/> <element name="PAA_TrikuspidalinsuffizienzSchluessel" type="enum_0360"/> </pre>

	<pre> <element name="PAA_ValvuloplastieSchluessel" type="enum_0061"/> <element name="PAA_StsScore" type="Zahl3_1" minOccurs="0"/> <element name="PAA_HypertonusSchluessel" type="enum_0061"/> <element name="PAA_MyokardinfarktSchluessel" type="enum_0374"/> <element name="PAA_SymptomeSchluessel" type="enum_0375"/> </sequence> </complexType> </pre>
--	---

element **PatientenaufnahmeAortenklappeBasis/PAA_DekompensationSchluessel**

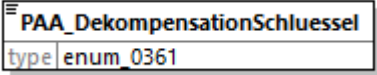
diagram			
type	enum 0361		
properties	content simple		
facets	Kind	Value	Annotation
	enumeration	0361001	documentation nein
	enumeration	0361002	documentation ja, letzte(r) innerhalb der letzten 48 Stunden
	enumeration	0361003	documentation ja, letzte(r) innerhalb der letzten 21 Tage
	enumeration	0361004	documentation ja, letzte(r) länger als 21 Tage
	enumeration	0361098	documentation ja, letzter Zeitpunkt unbekannt
	enumeration	0361099	documentation unbekannt
source	<code><element name="PAA_DekompensationSchluessel" type="enum_0361"/></code>		

element **PatientenaufnahmeAortenklappeBasis/PAA_ReanimationSchluessel**

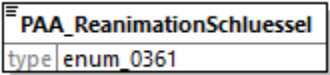
diagram			
type	enum 0361		
properties	content simple		
facets	Kind	Value	Annotation
	enumeration	0361001	documentation nein
	enumeration	0361002	documentation ja, letzte(r) innerhalb der letzten 48 Stunden
	enumeration	0361003	documentation ja, letzte(r) innerhalb der letzten 21 Tage
	enumeration	0361004	documentation ja, letzte(r) länger als 21 Tage
	enumeration	0361098	documentation ja, letzter Zeitpunkt unbekannt
	enumeration	0361099	documentation unbekannt
source	<code><element name="PAA_ReanimationSchluessel" type="enum_0361"/></code>		

element **PatientenaufnahmeAortenklappeBasis/PAA_HerzrhythmusSchluessel**

diagram			
type	enum 0362		
properties	content simple		
facets	Kind	Value	Annotation
	enumeration	0362001	documentation Sinusrhythmus
	enumeration	0362002	documentation Vorhofflimmern
	enumeration	0362042	documentation anderer Herzrhythmus
source	<code><element name="PAA_HerzrhythmusSchluessel" type="enum_0362"/></code>		

element **PatientenaufnahmeAortenklappeBasis/PAA_VorhofflimmernSchluessel**

diagram			
type	enum 0363		
properties	content simple		
facets	Kind	Value	Annotation
	enumeration	0363001	documentation nein
	enumeration	0363002	documentation paroxysmal
	enumeration	0363003	documentation persistierend
	enumeration	0363004	documentation permanent
source	<code><element name="PAA_VorhofflimmernSchluessel" type="enum_0363"/></code>		

element **PatientenaufnahmeAortenklappeBasis/PAA_SchrittmacherSchluessel**

diagram			
type	enum 0364		
properties	content simple		
facets	Kind	Value	Annotation
	enumeration	0364001	documentation nein
	enumeration	0364002	documentation Schrittmacher ohne CRT-System
	enumeration	0364003	documentation Schrittmacher mit CRT-System
	enumeration	0364004	documentation Defibrillator ohne CRT-System
	enumeration	0364005	documentation Defibrillator mit CRT-System
source	<code><element name="PAA_SchrittmacherSchluessel" type="enum_0364"/></code>		

element **PatientenaufnahmeAortenklappeBasis/PAA_BefundSchluessel**

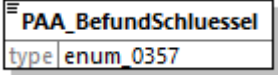
diagram																			
type	enum 0357																		
properties	content simple																		
facets	<table border="1"> <thead> <tr> <th>Kind</th> <th>Value</th> <th>Annotation</th> </tr> </thead> <tbody> <tr> <td>enumeration</td> <td>0357001</td> <td>documentation keine KHK</td> </tr> <tr> <td>enumeration</td> <td>0357002</td> <td>documentation 1-Gefäßerkrankung</td> </tr> <tr> <td>enumeration</td> <td>0357003</td> <td>documentation 2-Gefäßerkrankung</td> </tr> <tr> <td>enumeration</td> <td>0357004</td> <td>documentation 3-Gefäßerkrankung</td> </tr> <tr> <td>enumeration</td> <td>0357005</td> <td>documentation keine koronare Bildgebung</td> </tr> </tbody> </table>	Kind	Value	Annotation	enumeration	0357001	documentation keine KHK	enumeration	0357002	documentation 1-Gefäßerkrankung	enumeration	0357003	documentation 2-Gefäßerkrankung	enumeration	0357004	documentation 3-Gefäßerkrankung	enumeration	0357005	documentation keine koronare Bildgebung
Kind	Value	Annotation																	
enumeration	0357001	documentation keine KHK																	
enumeration	0357002	documentation 1-Gefäßerkrankung																	
enumeration	0357003	documentation 2-Gefäßerkrankung																	
enumeration	0357004	documentation 3-Gefäßerkrankung																	
enumeration	0357005	documentation keine koronare Bildgebung																	
source	<code><element name="PAA_BefundSchluessel" type="enum_0357"/></code>																		

element **PatientenaufnahmeAortenklappeBasis/PAA_RevaskularisationSchluessel**

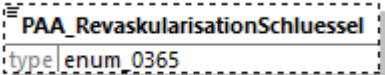
diagram													
type	enum 0365												
properties	minOcc 0 maxOcc 1 content simple												
facets	<table border="1"> <thead> <tr> <th>Kind</th> <th>Value</th> <th>Annotation</th> </tr> </thead> <tbody> <tr> <td>enumeration</td> <td>0365001</td> <td>documentation nein</td> </tr> <tr> <td>enumeration</td> <td>0365002</td> <td>documentation ja, operativ</td> </tr> <tr> <td>enumeration</td> <td>0365003</td> <td>documentation ja, interventionell</td> </tr> </tbody> </table>	Kind	Value	Annotation	enumeration	0365001	documentation nein	enumeration	0365002	documentation ja, operativ	enumeration	0365003	documentation ja, interventionell
Kind	Value	Annotation											
enumeration	0365001	documentation nein											
enumeration	0365002	documentation ja, operativ											
enumeration	0365003	documentation ja, interventionell											
source	<code><element name="PAA_RevaskularisationSchluessel" type="enum_0365" minOccurs="0"/></code>												

element **PatientenaufnahmeAortenklappeBasis/PAA_PciSchluessel**

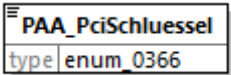
diagram													
type	enum 0366												
properties	content simple												
facets	<table border="1"> <thead> <tr> <th>Kind</th> <th>Value</th> <th>Annotation</th> </tr> </thead> <tbody> <tr> <td>enumeration</td> <td>0366001</td> <td>documentation nein</td> </tr> <tr> <td>enumeration</td> <td>0366002</td> <td>documentation ja, &lt;= 6 Stunden</td> </tr> <tr> <td>enumeration</td> <td>0366003</td> <td>documentation</td> </tr> </tbody> </table>	Kind	Value	Annotation	enumeration	0366001	documentation nein	enumeration	0366002	documentation ja, <= 6 Stunden	enumeration	0366003	documentation
Kind	Value	Annotation											
enumeration	0366001	documentation nein											
enumeration	0366002	documentation ja, <= 6 Stunden											
enumeration	0366003	documentation											

	enumeration 0366004	ja, > 6 Stunden bis <= 3 Monate documentation
	enumeration 0366099	ja, > 3 Monate documentation unbekannt
source	<code><element name="PAA_PciSchluessel" type="enum_0366"/></code>	

element **PatientenaufnahmeAortenklappeBasis/PAA_AnzahlVorOpSchluessel**

diagram			
type	enum 0358		
properties	content simple		
facets	Kind	Value	Annotation
	enumeration	0358001	documentation 0
	enumeration	0358002	documentation 1
	enumeration	0358003	documentation 2
	enumeration	0358004	documentation 3
	enumeration	0358005	documentation 4
	enumeration	0358006	documentation 5 oder mehr
	enumeration	0358098	documentation genaue Anzahl unbekannt (aber mind. 1)
	enumeration	0358099	documentation unbekannt
source	<code><element name="PAA_AnzahlVorOpSchluessel" type="enum_0358"/></code>		

element **PatientenaufnahmeAortenklappeBasis/PAA_AvkSchluessel**

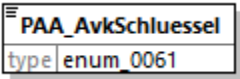
diagram			
type	enum 0061		
properties	content simple		
facets	Kind	Value	Annotation
	enumeration	0061001	documentation ja
	enumeration	0061002	documentation nein
	enumeration	0061099	documentation unbekannt
source	<code><element name="PAA_AvkSchluessel" type="enum_0061"/></code>		

element **PatientenaufnahmeAortenklappeBasis/PAA_PavkSchluessel**

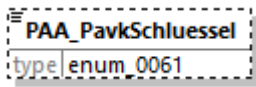
diagram													
type	enum 0061												
properties	minOcc 0 maxOcc 1 content simple												
facets	<table border="1"> <thead> <tr> <th>Kind</th> <th>Value</th> <th>Annotation</th> </tr> </thead> <tbody> <tr> <td>enumeration</td> <td>0061001</td> <td>documentation ja</td> </tr> <tr> <td>enumeration</td> <td>0061002</td> <td>documentation nein</td> </tr> <tr> <td>enumeration</td> <td>0061099</td> <td>documentation unbekannt</td> </tr> </tbody> </table>	Kind	Value	Annotation	enumeration	0061001	documentation ja	enumeration	0061002	documentation nein	enumeration	0061099	documentation unbekannt
Kind	Value	Annotation											
enumeration	0061001	documentation ja											
enumeration	0061002	documentation nein											
enumeration	0061099	documentation unbekannt											
source	<code><element name="PAA_PavkSchluessel" type="enum_0061" minOccurs="0"/></code>												

element **PatientenaufnahmeAortenklappeBasis/PAA_ArteriaCarotisSchluessel**

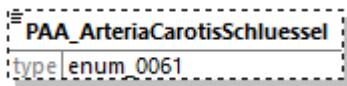
diagram													
type	enum 0061												
properties	minOcc 0 maxOcc 1 content simple												
facets	<table border="1"> <thead> <tr> <th>Kind</th> <th>Value</th> <th>Annotation</th> </tr> </thead> <tbody> <tr> <td>enumeration</td> <td>0061001</td> <td>documentation ja</td> </tr> <tr> <td>enumeration</td> <td>0061002</td> <td>documentation nein</td> </tr> <tr> <td>enumeration</td> <td>0061099</td> <td>documentation unbekannt</td> </tr> </tbody> </table>	Kind	Value	Annotation	enumeration	0061001	documentation ja	enumeration	0061002	documentation nein	enumeration	0061099	documentation unbekannt
Kind	Value	Annotation											
enumeration	0061001	documentation ja											
enumeration	0061002	documentation nein											
enumeration	0061099	documentation unbekannt											
source	<code><element name="PAA_ArteriaCarotisSchluessel" type="enum_0061" minOccurs="0"/></code>												

element **PatientenaufnahmeAortenklappeBasis/PAA_AortenaneurysmaSchluessel**

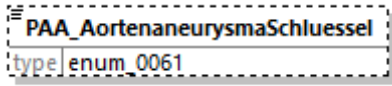
diagram													
type	enum 0061												
properties	minOcc 0 maxOcc 1 content simple												
facets	<table border="1"> <thead> <tr> <th>Kind</th> <th>Value</th> <th>Annotation</th> </tr> </thead> <tbody> <tr> <td>enumeration</td> <td>0061001</td> <td>documentation ja</td> </tr> <tr> <td>enumeration</td> <td>0061002</td> <td>documentation nein</td> </tr> <tr> <td>enumeration</td> <td>0061099</td> <td>documentation unbekannt</td> </tr> </tbody> </table>	Kind	Value	Annotation	enumeration	0061001	documentation ja	enumeration	0061002	documentation nein	enumeration	0061099	documentation unbekannt
Kind	Value	Annotation											
enumeration	0061001	documentation ja											
enumeration	0061002	documentation nein											
enumeration	0061099	documentation unbekannt											
source	<code><element name="PAA_AortenaneurysmaSchluessel" type="enum_0061" minOccurs="0"/></code>												

element **PatientenaufnahmeAortenklappeBasis/PAA_SonstigeAvkSchluessel**

diagram													
type	enum_0061												
properties	minOcc 0 maxOcc 1 content simple												
facets	<table border="1"> <thead> <tr> <th>Kind</th> <th>Value</th> <th>Annotation</th> </tr> </thead> <tbody> <tr> <td>enumeration</td> <td>0061001</td> <td>documentation ja</td> </tr> <tr> <td>enumeration</td> <td>0061002</td> <td>documentation nein</td> </tr> <tr> <td>enumeration</td> <td>0061099</td> <td>documentation unbekannt</td> </tr> </tbody> </table>	Kind	Value	Annotation	enumeration	0061001	documentation ja	enumeration	0061002	documentation nein	enumeration	0061099	documentation unbekannt
Kind	Value	Annotation											
enumeration	0061001	documentation ja											
enumeration	0061002	documentation nein											
enumeration	0061099	documentation unbekannt											
source	<code><element name="PAA_SonstigeAvkSchluessel" type="enum_0061" minOccurs="0"/></code>												

element **PatientenaufnahmeAortenklappeBasis/PAA_LungenerkrankungSchluessel**

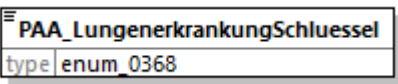
diagram																			
type	enum_0368																		
properties	content simple																		
facets	<table border="1"> <thead> <tr> <th>Kind</th> <th>Value</th> <th>Annotation</th> </tr> </thead> <tbody> <tr> <td>enumeration</td> <td>0368001</td> <td>documentation nein</td> </tr> <tr> <td>enumeration</td> <td>0368002</td> <td>documentation ja, COPD mit Dauermedikation</td> </tr> <tr> <td>enumeration</td> <td>0368003</td> <td>documentation ja, COPD ohne Dauermedikation</td> </tr> <tr> <td>enumeration</td> <td>0368004</td> <td>documentation ja, andere Lungenerkrankungen</td> </tr> <tr> <td>enumeration</td> <td>0368099</td> <td>documentation unbekannt</td> </tr> </tbody> </table>	Kind	Value	Annotation	enumeration	0368001	documentation nein	enumeration	0368002	documentation ja, COPD mit Dauermedikation	enumeration	0368003	documentation ja, COPD ohne Dauermedikation	enumeration	0368004	documentation ja, andere Lungenerkrankungen	enumeration	0368099	documentation unbekannt
Kind	Value	Annotation																	
enumeration	0368001	documentation nein																	
enumeration	0368002	documentation ja, COPD mit Dauermedikation																	
enumeration	0368003	documentation ja, COPD ohne Dauermedikation																	
enumeration	0368004	documentation ja, andere Lungenerkrankungen																	
enumeration	0368099	documentation unbekannt																	
source	<code><element name="PAA_LungenerkrankungSchluessel" type="enum_0368"/></code>																		

element **PatientenaufnahmeAortenklappeBasis/PAA_Akoef**

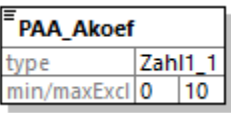
diagram																
type	Zahl1_1															
properties	content simple															
facets	<table border="1"> <thead> <tr> <th>Kind</th> <th>Value</th> <th>Annotation</th> </tr> </thead> <tbody> <tr> <td>minExclusive</td> <td>0</td> <td></td> </tr> <tr> <td>maxExclusive</td> <td>10</td> <td></td> </tr> <tr> <td>totalDigits</td> <td>1</td> <td></td> </tr> <tr> <td>fractionDigits</td> <td>1</td> <td></td> </tr> </tbody> </table>	Kind	Value	Annotation	minExclusive	0		maxExclusive	10		totalDigits	1		fractionDigits	1	
Kind	Value	Annotation														
minExclusive	0															
maxExclusive	10															
totalDigits	1															
fractionDigits	1															
source	<code><element name="PAA_Akoef" type="Zahl1_1"/></code>															

element **PatientenaufnahmeAortenklappeBasis/PAA_AkoefUnbekannt**

diagram							
type	JaLeer						
properties	content simple						
facets	<table border="1"> <thead> <tr> <th>Kind</th> <th>Value</th> <th>Annotation</th> </tr> </thead> <tbody> <tr> <td>pattern</td> <td>(1)</td> <td></td> </tr> </tbody> </table>	Kind	Value	Annotation	pattern	(1)	
Kind	Value	Annotation					
pattern	(1)						
source	<code><element name="PAA_AkoefUnbekannt" type="JaLeer"/></code>						

element **PatientenaufnahmeAortenklappeBasis/PAA_AkoefMethodeSchluessel**

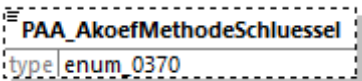
diagram													
type	enum_0370												
properties	<table border="1"> <tbody> <tr> <td>minOcc</td> <td>0</td> </tr> <tr> <td>maxOcc</td> <td>1</td> </tr> <tr> <td>content</td> <td>simple</td> </tr> </tbody> </table>	minOcc	0	maxOcc	1	content	simple						
minOcc	0												
maxOcc	1												
content	simple												
facets	<table border="1"> <thead> <tr> <th>Kind</th> <th>Value</th> <th>Annotation</th> </tr> </thead> <tbody> <tr> <td>enumeration</td> <td>0370001</td> <td>documentation Echokardiographie</td> </tr> <tr> <td>enumeration</td> <td>0370002</td> <td>documentation Herzkatheter</td> </tr> <tr> <td>enumeration</td> <td>0370042</td> <td>documentation andere</td> </tr> </tbody> </table>	Kind	Value	Annotation	enumeration	0370001	documentation Echokardiographie	enumeration	0370002	documentation Herzkatheter	enumeration	0370042	documentation andere
Kind	Value	Annotation											
enumeration	0370001	documentation Echokardiographie											
enumeration	0370002	documentation Herzkatheter											
enumeration	0370042	documentation andere											
source	<code><element name="PAA_AkoefMethodeSchluessel" type="enum_0370" minOccurs="0"/></code>												

element **PatientenaufnahmeAortenklappeBasis/PAA_DeltaPmax**

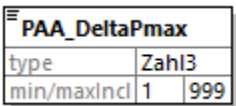
diagram										
type	Zahl3									
properties	content simple									
facets	<table border="1"> <thead> <tr> <th>Kind</th> <th>Value</th> <th>Annotation</th> </tr> </thead> <tbody> <tr> <td>minInclusive</td> <td>1</td> <td></td> </tr> <tr> <td>maxInclusive</td> <td>999</td> <td></td> </tr> </tbody> </table>	Kind	Value	Annotation	minInclusive	1		maxInclusive	999	
Kind	Value	Annotation								
minInclusive	1									
maxInclusive	999									
source	<code><element name="PAA_DeltaPmax" type="Zahl3"/></code>									

element **PatientenaufnahmeAortenklappeBasis/PAA_DeltaPmaxUnbekannt**

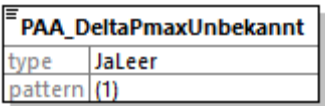
diagram							
type	JaLeer						
properties	content simple						
facets	<table border="1"> <thead> <tr> <th>Kind</th> <th>Value</th> <th>Annotation</th> </tr> </thead> <tbody> <tr> <td>pattern</td> <td>(1)</td> <td></td> </tr> </tbody> </table>	Kind	Value	Annotation	pattern	(1)	
Kind	Value	Annotation					
pattern	(1)						
source	<code><element name="PAA_DeltaPmaxUnbekannt" type="JaLeer"/></code>						

element **PatientenaufnahmeAortenklappeBasis/PAA_DeltaPmean**

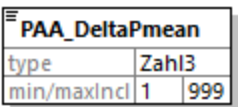
diagram										
type	Zahl3									
properties	content simple									
facets	<table border="1"> <thead> <tr> <th>Kind</th> <th>Value</th> <th>Annotation</th> </tr> </thead> <tbody> <tr> <td>minInclusive</td> <td>1</td> <td></td> </tr> <tr> <td>maxInclusive</td> <td>999</td> <td></td> </tr> </tbody> </table>	Kind	Value	Annotation	minInclusive	1		maxInclusive	999	
Kind	Value	Annotation								
minInclusive	1									
maxInclusive	999									
source	<code><element name="PAA_DeltaPmean" type="Zahl3"/></code>									

element **PatientenaufnahmeAortenklappeBasis/PAA_DeltaPmeanUnbekannt**

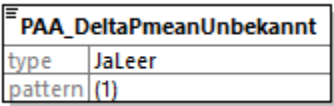
diagram							
type	JaLeer						
properties	content simple						
facets	<table border="1"> <thead> <tr> <th>Kind</th> <th>Value</th> <th>Annotation</th> </tr> </thead> <tbody> <tr> <td>pattern</td> <td>(1)</td> <td></td> </tr> </tbody> </table>	Kind	Value	Annotation	pattern	(1)	
Kind	Value	Annotation					
pattern	(1)						
source	<code><element name="PAA_DeltaPmeanUnbekannt" type="JaLeer"/></code>						

element **PatientenaufnahmeAortenklappeBasis/PAA_DeltaP**

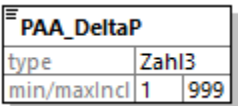
diagram										
type	Zahl3									
properties	content simple									
facets	<table border="1"> <thead> <tr> <th>Kind</th> <th>Value</th> <th>Annotation</th> </tr> </thead> <tbody> <tr> <td>minInclusive</td> <td>1</td> <td></td> </tr> <tr> <td>maxInclusive</td> <td>999</td> <td></td> </tr> </tbody> </table>	Kind	Value	Annotation	minInclusive	1		maxInclusive	999	
Kind	Value	Annotation								
minInclusive	1									
maxInclusive	999									

source	<code><element name="PAA_DeltaP" type="Zahl3"/></code>
--------	--

element **PatientenaufnahmeAortenklappeBasis/PAA_DeltaPUnbekannt**

diagram							
type	JaLeer						
properties	content simple						
facets	<table border="1"> <thead> <tr> <th>Kind</th> <th>Value</th> <th>Annotation</th> </tr> </thead> <tbody> <tr> <td>pattern</td> <td>(1)</td> <td></td> </tr> </tbody> </table>	Kind	Value	Annotation	pattern	(1)	
Kind	Value	Annotation					
pattern	(1)						
source	<code><element name="PAA_DeltaPUnbekannt" type="JaLeer"/></code>						

element **PatientenaufnahmeAortenklappeBasis/PAA_VerkalkungsgradSchluessel**

diagram																			
type	enum_0371																		
properties	content simple																		
facets	<table border="1"> <thead> <tr> <th>Kind</th> <th>Value</th> <th>Annotation</th> </tr> </thead> <tbody> <tr> <td>enumeration</td> <td>0371001</td> <td>documentation keine</td> </tr> <tr> <td>enumeration</td> <td>0371002</td> <td>documentation leicht</td> </tr> <tr> <td>enumeration</td> <td>0371003</td> <td>documentation mittel</td> </tr> <tr> <td>enumeration</td> <td>0371004</td> <td>documentation schwer</td> </tr> <tr> <td>enumeration</td> <td>0371099</td> <td>documentation unbekannt</td> </tr> </tbody> </table>	Kind	Value	Annotation	enumeration	0371001	documentation keine	enumeration	0371002	documentation leicht	enumeration	0371003	documentation mittel	enumeration	0371004	documentation schwer	enumeration	0371099	documentation unbekannt
Kind	Value	Annotation																	
enumeration	0371001	documentation keine																	
enumeration	0371002	documentation leicht																	
enumeration	0371003	documentation mittel																	
enumeration	0371004	documentation schwer																	
enumeration	0371099	documentation unbekannt																	
source	<code><element name="PAA_VerkalkungsgradSchluessel" type="enum_0371"/></code>																		

element **PatientenaufnahmeAortenklappeBasis/PAA_CtCalcium**

diagram										
type	Zahl5									
properties	content simple									
facets	<table border="1"> <thead> <tr> <th>Kind</th> <th>Value</th> <th>Annotation</th> </tr> </thead> <tbody> <tr> <td>minInclusive</td> <td>1</td> <td></td> </tr> <tr> <td>maxInclusive</td> <td>99999</td> <td></td> </tr> </tbody> </table>	Kind	Value	Annotation	minInclusive	1		maxInclusive	99999	
Kind	Value	Annotation								
minInclusive	1									
maxInclusive	99999									
source	<code><element name="PAA_CtCalcium" type="Zahl5"/></code>									

element **PatientenaufnahmeAortenklappeBasis/PAA_CtCalciumUnbekannt**

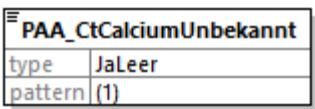
diagram							
type	JaLeer						
properties	content simple						
facets	<table border="1"> <thead> <tr> <th>Kind</th> <th>Value</th> <th>Annotation</th> </tr> </thead> <tbody> <tr> <td>pattern</td> <td>(1)</td> <td></td> </tr> </tbody> </table>	Kind	Value	Annotation	pattern	(1)	
Kind	Value	Annotation					
pattern	(1)						
source	<code><element name="PAA_CtCalciumUnbekannt" type="JaLeer"/></code>						

element **PatientenaufnahmeAortenklappeBasis/PAA_LvotSchluessel**

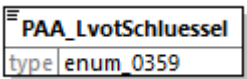
diagram																
type	enum_0359															
properties	content simple															
facets	<table border="1"> <thead> <tr> <th>Kind</th> <th>Value</th> <th>Annotation</th> </tr> </thead> <tbody> <tr> <td>enumeration</td> <td>0359001</td> <td>documentation nein</td> </tr> <tr> <td>enumeration</td> <td>0359002</td> <td>documentation ja - einseitig</td> </tr> <tr> <td>enumeration</td> <td>0359003</td> <td>documentation ja - beidseitig</td> </tr> <tr> <td>enumeration</td> <td>0359042</td> <td>documentation unbekannt</td> </tr> </tbody> </table>	Kind	Value	Annotation	enumeration	0359001	documentation nein	enumeration	0359002	documentation ja - einseitig	enumeration	0359003	documentation ja - beidseitig	enumeration	0359042	documentation unbekannt
Kind	Value	Annotation														
enumeration	0359001	documentation nein														
enumeration	0359002	documentation ja - einseitig														
enumeration	0359003	documentation ja - beidseitig														
enumeration	0359042	documentation unbekannt														
source	<code><element name="PAA_LvotSchluessel" type="enum_0359"/></code>															

element **PatientenaufnahmeAortenklappeBasis/PAA_BiUnicuspideKlappeSchluessel**

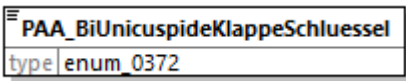
diagram																
type	enum_0372															
properties	content simple															
facets	<table border="1"> <thead> <tr> <th>Kind</th> <th>Value</th> <th>Annotation</th> </tr> </thead> <tbody> <tr> <td>enumeration</td> <td>0372001</td> <td>documentation nein</td> </tr> <tr> <td>enumeration</td> <td>0372002</td> <td>documentation ja, bicuspide</td> </tr> <tr> <td>enumeration</td> <td>0372003</td> <td>documentation ja, unicuspide</td> </tr> <tr> <td>enumeration</td> <td>0372099</td> <td>documentation unbekannt</td> </tr> </tbody> </table>	Kind	Value	Annotation	enumeration	0372001	documentation nein	enumeration	0372002	documentation ja, bicuspide	enumeration	0372003	documentation ja, unicuspide	enumeration	0372099	documentation unbekannt
Kind	Value	Annotation														
enumeration	0372001	documentation nein														
enumeration	0372002	documentation ja, bicuspide														
enumeration	0372003	documentation ja, unicuspide														
enumeration	0372099	documentation unbekannt														
source	<code><element name="PAA_BiUnicuspideKlappeSchluessel" type="enum_0372"/></code>															

element **PatientenaufnahmeAortenklappeBasis/PAA_AortenstenoseSchluessel**

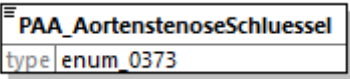
diagram			
type	enum 0373		
properties	content simple		
facets	Kind	Value	Annotation
	enumeration	0373001	documentation keine
	enumeration	0373002	documentation leichtgradig
	enumeration	0373003	documentation mittelgradig
	enumeration	0373004	documentation hochgradig
	enumeration	0373099	documentation unbekannt
source	<code><element name="PAA_AortenstenoseSchluessel" type="enum_0373"/></code>		

element **PatientenaufnahmeAortenklappeBasis/PAA_AorteninsuffizienzSchluessel**

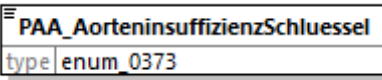
diagram			
type	enum 0373		
properties	content simple		
facets	Kind	Value	Annotation
	enumeration	0373001	documentation keine
	enumeration	0373002	documentation leichtgradig
	enumeration	0373003	documentation mittelgradig
	enumeration	0373004	documentation hochgradig
	enumeration	0373099	documentation unbekannt
source	<code><element name="PAA_AorteninsuffizienzSchluessel" type="enum_0373"/></code>		

element **PatientenaufnahmeAortenklappeBasis/PAA_MitralinsuffizienzSchluessel**

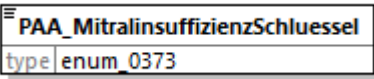
diagram			
type	enum 0373		
properties	content simple		
facets	Kind	Value	Annotation
	enumeration	0373001	documentation keine
	enumeration	0373002	documentation leichtgradig
	enumeration	0373003	documentation mittelgradig

	enumeration 0373004 documentation hochgradig
	enumeration 0373099 documentation unbekannt
source	<code><element name="PAA_MitralinsuffizienzSchluessel" type="enum_0373"/></code>

element **PatientenaufnahmeAortenklappeBasis/PAA_TrikuspidalinsuffizienzSchluessel**

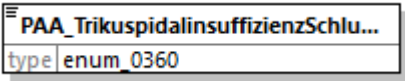
diagram			
type	enum 0360		
properties	content simple		
facets	Kind	Value	Annotation
	enumeration	0360001	documentation keine
	enumeration	0360002	documentation leichtgradig
	enumeration	0360003	documentation mittelgradig
	enumeration	0360004	documentation hochgradig
	enumeration	0360005	documentation massive
	enumeration	0360006	documentation torrential
	enumeration	0360099	documentation unbekannt
source	<code><element name="PAA_TrikuspidalinsuffizienzSchluessel" type="enum_0360"/></code>		

element **PatientenaufnahmeAortenklappeBasis/PAA_ValvuloplastieSchluessel**

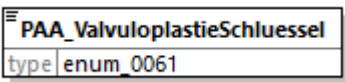
diagram			
type	enum 0061		
properties	content simple		
facets	Kind	Value	Annotation
	enumeration	0061001	documentation ja
	enumeration	0061002	documentation nein
	enumeration	0061099	documentation unbekannt
source	<code><element name="PAA_ValvuloplastieSchluessel" type="enum_0061"/></code>		

element **PatientenaufnahmeAortenklappeBasis/PAA_StsScore**

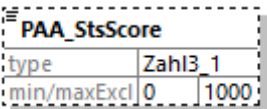
diagram			
---------	---	--	--

type	Zahl3_1															
properties	minOcc 0 maxOcc 1 content simple															
facets	<table border="1"> <thead> <tr> <th>Kind</th> <th>Value</th> <th>Annotation</th> </tr> </thead> <tbody> <tr> <td>minExclusive</td> <td>0</td> <td></td> </tr> <tr> <td>maxExclusive</td> <td>1000</td> <td></td> </tr> <tr> <td>totalDigits</td> <td>3</td> <td></td> </tr> <tr> <td>fractionDigits</td> <td>1</td> <td></td> </tr> </tbody> </table>	Kind	Value	Annotation	minExclusive	0		maxExclusive	1000		totalDigits	3		fractionDigits	1	
Kind	Value	Annotation														
minExclusive	0															
maxExclusive	1000															
totalDigits	3															
fractionDigits	1															
source	<code><element name="PAA_StsScore" type="Zahl3_1" minOccurs="0"/></code>															

element **PatientenaufnahmeAortenklappeBasis/PAA_HypertonusSchluessel**

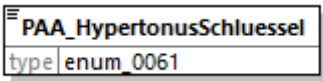
diagram													
type	enum 0061												
properties	content simple												
facets	<table border="1"> <thead> <tr> <th>Kind</th> <th>Value</th> <th>Annotation</th> </tr> </thead> <tbody> <tr> <td>enumeration</td> <td>0061001</td> <td>documentation ja</td> </tr> <tr> <td>enumeration</td> <td>0061002</td> <td>documentation nein</td> </tr> <tr> <td>enumeration</td> <td>0061099</td> <td>documentation unbekannt</td> </tr> </tbody> </table>	Kind	Value	Annotation	enumeration	0061001	documentation ja	enumeration	0061002	documentation nein	enumeration	0061099	documentation unbekannt
Kind	Value	Annotation											
enumeration	0061001	documentation ja											
enumeration	0061002	documentation nein											
enumeration	0061099	documentation unbekannt											
source	<code><element name="PAA_HypertonusSchluessel" type="enum_0061"/></code>												

element **PatientenaufnahmeAortenklappeBasis/PAA_MyokardinfarktSchluessel**

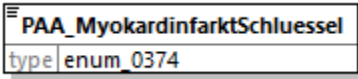
diagram																						
type	enum 0374																					
properties	content simple																					
facets	<table border="1"> <thead> <tr> <th>Kind</th> <th>Value</th> <th>Annotation</th> </tr> </thead> <tbody> <tr> <td>enumeration</td> <td>0374001</td> <td>documentation nein</td> </tr> <tr> <td>enumeration</td> <td>0374002</td> <td>documentation ja, &lt;= 6 Stunden</td> </tr> <tr> <td>enumeration</td> <td>0374003</td> <td>documentation ja, &gt; 6 Stunden bis &lt;= 24 Stunden</td> </tr> <tr> <td>enumeration</td> <td>0374004</td> <td>documentation ja, &gt; 1 bis 7 Tage</td> </tr> <tr> <td>enumeration</td> <td>0374005</td> <td>documentation ja, &gt; 7 bis 21 Tage</td> </tr> <tr> <td>enumeration</td> <td>0374006</td> <td>documentation ja, &gt; 21 Tage</td> </tr> </tbody> </table>	Kind	Value	Annotation	enumeration	0374001	documentation nein	enumeration	0374002	documentation ja, <= 6 Stunden	enumeration	0374003	documentation ja, > 6 Stunden bis <= 24 Stunden	enumeration	0374004	documentation ja, > 1 bis 7 Tage	enumeration	0374005	documentation ja, > 7 bis 21 Tage	enumeration	0374006	documentation ja, > 21 Tage
Kind	Value	Annotation																				
enumeration	0374001	documentation nein																				
enumeration	0374002	documentation ja, <= 6 Stunden																				
enumeration	0374003	documentation ja, > 6 Stunden bis <= 24 Stunden																				
enumeration	0374004	documentation ja, > 1 bis 7 Tage																				
enumeration	0374005	documentation ja, > 7 bis 21 Tage																				
enumeration	0374006	documentation ja, > 21 Tage																				
source	<code><element name="PAA_MyokardinfarktSchluessel" type="enum_0374"/></code>																					

element **PatientenaufnahmeAortenklappeBasis/PAA_SymptomeSchluessel**

diagram			
type	enum 0375		
properties	content simple		
facets	Kind	Value	Annotation
	enumeration	0375001	documentation keine Symptome oder Angina
	enumeration	0375002	documentation Symptome, aber keine Ischämiezeichen
	enumeration	0375003	documentation stabile Angina
	enumeration	0375004	documentation instabile Angina
	enumeration	0375005	documentation Infarkt ohne ST-Hebung (Non-STEMI)
	enumeration	0375006	documentation Infarkt mit ST-Hebung (STEMI)
	enumeration	0375042	documentation unbekannt
source	<code><element name="PAA_SymptomeSchluessel" type="enum_0375"/></code>		

complexType **InfektionAortenklappeBasis**

diagram			
namespace	http://xml.ir-d.de/emg		
children	IAK_InfektionSchluessel		
used by	element PatientenaufnahmeAortenklappe/infektionAortenklappe		
source	<pre> <complexType name="InfektionAortenklappeBasis"> <sequence> <element name="IAK_InfektionSchluessel" type="enum_0367"/> </sequence> </complexType> </pre>		

element **InfektionAortenklappeBasis/IAK_InfektionSchluessel**

diagram			
type	enum 0367		
properties	content simple		
facets	Kind	Value	Annotation
	enumeration	0367001	documentation keine
	enumeration	0367002	documentation Mediastinitis
	enumeration	0367003	documentation Sepsis
	enumeration	0367004	documentation

	enumeration	0367005	broncho-pulmonale Infektion documentation
	enumeration	0367006	oto-laryngologische Infektion documentation
	enumeration	0367007	floride Endokarditis documentation
	enumeration	0367008	Peritonitis documentation
	enumeration	0367009	Wundinfektion Thorax documentation
	enumeration	0367010	Pleuraempyem documentation
	enumeration	0367011	Venenkatheterinfektion documentation
	enumeration	0367012	Harnwegsinfektion documentation
	enumeration	0367013	Wundinfektion untere Extremitäten documentation
	enumeration	0367014	HIV-Infektion documentation
	enumeration	0367015	Hepatitis B oder C documentation
	enumeration	0367042	andere Wundinfektion documentation
	enumeration		sonstige Infektion
source	<code><element name="IAK_InfektionSchlüssel" type="enum_0367"/></code>		

complexType **ArtikelbeschreibungBasis**

<p>diagram</p>	
<p>namespace</p>	<p>http://xml.ir-d.de/emg</p>
<p>children</p>	<p>ARB LotNumber ARB LotNumberUnbekannt ARB SerienNumber ARB SerienNumberUnbekannt ARB DatumVerfall ARB DatumVerfallUnbekannt ARB Artikelbezeichnung ARB DatumImplantierungExplantat ARB DatumImplantierungExplantatUnbekannt</p>
<p>used by</p>	<p>complexType Artikelbeschreibung</p>
<p>source</p>	<pre><complexType name="ArtikelbeschreibungBasis"> <sequence> <choice minOccurs="0"> <element name="ARB_LotNumber" type="String20"/> <element name="ARB_LotNumberUnbekannt" type="JaLeer"/> </choice> <choice minOccurs="0"> <element name="ARB_SerienNumber" type="String20"/> <element name="ARB_SerienNumberUnbekannt" type="JaLeer"/> </choice> <choice minOccurs="0"> <element name="ARB_DatumVerfall" type="String20"/> <element name="ARB_DatumVerfallUnbekannt" type="JaLeer"/> </choice> <element name="ARB Artikelbezeichnung" type="Freitext250" minOccurs="0"/> </sequence> </complexType></pre>

	<pre> <choice minOccurs="0"> <element name="ARB_DatumImplantierungExplantat" type="DatumText"/> <element name="ARB_DatumImplantierungExplantatUnbekannt" type="JaLeer"/> </choice> </sequence> </complexType> </pre>
--	--

element **ArtikelbeschreibungBasis/ARB_LotNummer**

diagram	<pre> ARB_LotNummer type String20 min/maxLen 20 </pre>						
type	String20						
properties	content simple						
facets	<table border="1"> <thead> <tr> <th>Kind</th> <th>Value</th> <th>Annotation</th> </tr> </thead> <tbody> <tr> <td>maxLength</td> <td>20</td> <td></td> </tr> </tbody> </table>	Kind	Value	Annotation	maxLength	20	
Kind	Value	Annotation					
maxLength	20						
source	<code><element name="ARB_LotNummer" type="String20"/></code>						

element **ArtikelbeschreibungBasis/ARB_LotNummerUnbekannt**

diagram	<pre> ARB_LotNummerUnbekannt type JaLeer pattern (1) </pre>						
type	JaLeer						
properties	content simple						
facets	<table border="1"> <thead> <tr> <th>Kind</th> <th>Value</th> <th>Annotation</th> </tr> </thead> <tbody> <tr> <td>pattern</td> <td>(1)</td> <td></td> </tr> </tbody> </table>	Kind	Value	Annotation	pattern	(1)	
Kind	Value	Annotation					
pattern	(1)						
source	<code><element name="ARB_LotNummerUnbekannt" type="JaLeer"/></code>						

element **ArtikelbeschreibungBasis/ARB_SerienNummer**

diagram	<pre> ARB_SerienNummer type String20 min/maxLen 20 </pre>						
type	String20						
properties	content simple						
facets	<table border="1"> <thead> <tr> <th>Kind</th> <th>Value</th> <th>Annotation</th> </tr> </thead> <tbody> <tr> <td>maxLength</td> <td>20</td> <td></td> </tr> </tbody> </table>	Kind	Value	Annotation	maxLength	20	
Kind	Value	Annotation					
maxLength	20						
source	<code><element name="ARB_SerienNummer" type="String20"/></code>						

element **ArtikelbeschreibungBasis/ARB_SerienNummerUnbekannt**

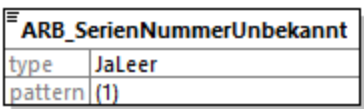
diagram	
type	JaLeer
properties	content simple
facets	Kind Value Annotation pattern (1)
source	<code><element name="ARB_SerienNummerUnbekannt" type="JaLeer"/></code>

element **ArtikelbeschreibungBasis/ARB_DatumVerfall**

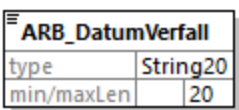
diagram	
type	String20
properties	content simple
facets	Kind Value Annotation maxLength 20
source	<code><element name="ARB_DatumVerfall" type="String20"/></code>

element **ArtikelbeschreibungBasis/ARB_DatumVerfallUnbekannt**

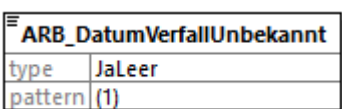
diagram	
type	JaLeer
properties	content simple
facets	Kind Value Annotation pattern (1)
source	<code><element name="ARB_DatumVerfallUnbekannt" type="JaLeer"/></code>

element **ArtikelbeschreibungBasis/ARB_Artikelbezeichnung**

diagram	
type	Freitext250
properties	minOcc 0 maxOcc 1 content simple
facets	Kind Value Annotation maxLength 250

source	<code><element name="ARB_Artikelbezeichnung" type="Freitext250" minOccurs="0"/></code>
--------	--

element **ArtikelbeschreibungBasis/ARB_DatumImplantierungExplantat**

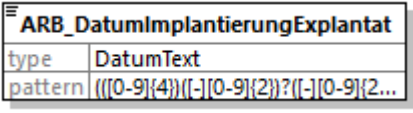
diagram							
type	DatumText						
properties	content simple						
facets	<table border="1"> <tr> <td>Kind</td> <td>Value</td> <td>Annotation</td> </tr> <tr> <td>pattern</td> <td>(([0-9]{4})([-][0-9]{2})?([-][0-9]{2}...))</td> <td></td> </tr> </table>	Kind	Value	Annotation	pattern	(([0-9]{4})([-][0-9]{2})?([-][0-9]{2}...))	
Kind	Value	Annotation					
pattern	(([0-9]{4})([-][0-9]{2})?([-][0-9]{2}...))						
source	<code><element name="ARB_DatumImplantierungExplantat" type="DatumText"/></code>						

element **ArtikelbeschreibungBasis/ARB_DatumImplantierungExplantatUnbekannt**

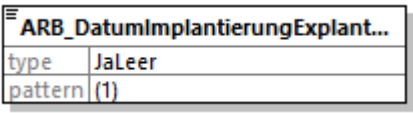
diagram							
type	JaLeer						
properties	content simple						
facets	<table border="1"> <tr> <td>Kind</td> <td>Value</td> <td>Annotation</td> </tr> <tr> <td>pattern</td> <td>(1)</td> <td></td> </tr> </table>	Kind	Value	Annotation	pattern	(1)	
Kind	Value	Annotation					
pattern	(1)						
source	<code><element name="ARB_DatumImplantierungExplantatUnbekannt" type="JaLeer"/></code>						

complexType **ArtikelBrustimplantatBasis**

<p>diagram</p>	
<p>namespace</p>	<p>http://xml.ir-d.de/emg</p>
<p>children</p>	<p>ABI_HerstellerSchluessel ABI_HerstellerUnbekannt ABI_HerstellerSonstiger ABI_ArtikelTypSchluessel ABI_FormSchluessel ABI_FormUnbekannt ABI_OberflaecheSchluessel ABI_OberflaecheUnbekannt ABI_FuellungSchluessel ABI_FuellungUnbekannt ABI_Volumen ABI_VolumenUnbekannt ABI_IntraoperativesVolumen</p>
<p>used by</p>	<p>element Artikelbeschreibung/artikelBrustimplantat</p>
<p>source</p>	<pre><complexType name="ArtikelBrustimplantatBasis"> <sequence> <choice></pre>

```

<element name="ABI_HerstellerSchluessel" type="enum_0130"/>
<element name="ABI_HerstellerUnbekannt" type="JaLeer"/>
</choice>
<element name="ABI_HerstellerSonstiger" type="Freitext250" minOccurs="0"/>
<element name="ABI_ArtikelTypSchluessel" type="enum_0190"/>
<choice>
  <element name="ABI_FormSchluessel" type="enum_0126"/>
  <element name="ABI_FormUnbekannt" type="JaLeer"/>
</choice>
<choice>
  <element name="ABI_OberflaecheSchluessel" type="enum_0128"/>
  <element name="ABI_OberflaecheUnbekannt" type="JaLeer"/>
</choice>
<choice>
  <element name="ABI_FuellungSchluessel" type="enum_0124"/>
  <element name="ABI_FuellungUnbekannt" type="JaLeer"/>
</choice>
<choice>
  <element name="ABI_Volumen" type="Zahl5"/>
  <element name="ABI_VolumenUnbekannt" type="JaLeer"/>
</choice>
<element name="ABI_IntraoperativesVolumen" type="Zahl5" minOccurs="0"/>
</sequence>
</complexType>

```

element ArtikelBrustimplantatBasis/ABI_HerstellerSchluessel

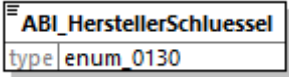
diagram			
type	enum 0130		
properties	content	simple	
facets	Kind	Value	Annotation
	enumeration	0130001	documentation Allergan
	enumeration	0130002	documentation Cereplas
	enumeration	0130003	documentation CUI (Cox Uphoff Implants)
	enumeration	0130004	documentation EMSI Biomedical
	enumeration	0130005	documentation Establishment labs
	enumeration	0130006	documentation Eurosilicone
	enumeration	0130007	documentation Nagor
	enumeration	0130008	documentation Groupe Sebbin
	enumeration	0130009	documentation Laboratoires Arion
	enumeration	0130010	documentation Mentor
	enumeration	0130011	documentation Pérouse Plastie SAS
	enumeration	0130012	documentation PIP M-Implants
	enumeration	0130013	documentation Polytech Health & Aesthetics

	enumeration	0130014	documentation Silimed
	enumeration	0130015	documentation Surgitek
	enumeration	0130016	documentation G&G Biotechnology
	enumeration	0130017	documentation nicht belegter Wert
	enumeration	0130018	documentation nicht belegter Wert
	enumeration	0130019	documentation nicht belegter Wert
	enumeration	0130020	documentation nicht belegter Wert
	enumeration	0130021	documentation nicht belegter Wert
	enumeration	0130042	documentation sonstiger
source	<code><element name="ABI_HerstellerSchluessel" type="enum_0130"/></code>		

element ArtikelBrustimplantatBasis/ABI_HerstellerUnbekannt

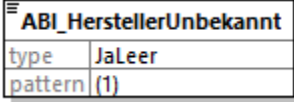
diagram			
type	JaLeer		
properties	content	simple	
facets	Kind	Value	Annotation
	pattern	(1)	
source	<code><element name="ABI_HerstellerUnbekannt" type="JaLeer"/></code>		

element ArtikelBrustimplantatBasis/ABI_HerstellerSonstiger

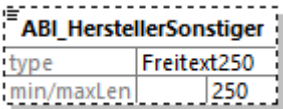
diagram			
type	Freitext250		
properties	minOcc	0	
	maxOcc	1	
	content	simple	
facets	Kind	Value	Annotation
	maxLength	250	
source	<code><element name="ABI_HerstellerSonstiger" type="Freitext250" minOccurs="0"/></code>		

element ArtikelBrustimplantatBasis/ABI_ArtikelTypSchluessel

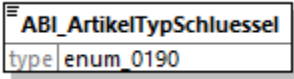
diagram			
type	enum_0190		

properties	content simple									
facets	<table border="1"> <thead> <tr> <th>Kind</th> <th>Value</th> <th>Annotation</th> </tr> </thead> <tbody> <tr> <td>enumeration</td> <td>0190001</td> <td>documentation Brustimplantat</td> </tr> <tr> <td>enumeration</td> <td>0190003</td> <td>documentation Brustexpander</td> </tr> </tbody> </table>	Kind	Value	Annotation	enumeration	0190001	documentation Brustimplantat	enumeration	0190003	documentation Brustexpander
Kind	Value	Annotation								
enumeration	0190001	documentation Brustimplantat								
enumeration	0190003	documentation Brustexpander								
source	<code><element name="ABI_ArtikelTypSchluessel" type="enum_0190"/></code>									

element ArtikelBrustimplantatBasis/ABI_FormSchluessel

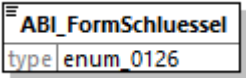
diagram													
type	enum 0126												
properties	content simple												
facets	<table border="1"> <thead> <tr> <th>Kind</th> <th>Value</th> <th>Annotation</th> </tr> </thead> <tbody> <tr> <td>enumeration</td> <td>0126001</td> <td>documentation anatomisch (tropfenförmig)</td> </tr> <tr> <td>enumeration</td> <td>0126002</td> <td>documentation rund (punktsymmetrisch)</td> </tr> <tr> <td>enumeration</td> <td>0126042</td> <td>documentation sonstige</td> </tr> </tbody> </table>	Kind	Value	Annotation	enumeration	0126001	documentation anatomisch (tropfenförmig)	enumeration	0126002	documentation rund (punktsymmetrisch)	enumeration	0126042	documentation sonstige
Kind	Value	Annotation											
enumeration	0126001	documentation anatomisch (tropfenförmig)											
enumeration	0126002	documentation rund (punktsymmetrisch)											
enumeration	0126042	documentation sonstige											
source	<code><element name="ABI_FormSchluessel" type="enum_0126"/></code>												

element ArtikelBrustimplantatBasis/ABI_FormUnbekannt

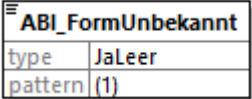
diagram							
type	JaLeer						
properties	content simple						
facets	<table border="1"> <thead> <tr> <th>Kind</th> <th>Value</th> <th>Annotation</th> </tr> </thead> <tbody> <tr> <td>pattern</td> <td>(1)</td> <td></td> </tr> </tbody> </table>	Kind	Value	Annotation	pattern	(1)	
Kind	Value	Annotation					
pattern	(1)						
source	<code><element name="ABI_FormUnbekannt" type="JaLeer"/></code>						

element ArtikelBrustimplantatBasis/ABI_OberflaecheSchluessel

diagram													
type	enum 0128												
properties	content simple												
facets	<table border="1"> <thead> <tr> <th>Kind</th> <th>Value</th> <th>Annotation</th> </tr> </thead> <tbody> <tr> <td>enumeration</td> <td>0128001</td> <td>documentation glattwandig</td> </tr> <tr> <td>enumeration</td> <td>0128002</td> <td>documentation beschichtet</td> </tr> <tr> <td>enumeration</td> <td>0128003</td> <td>documentation texturiert</td> </tr> </tbody> </table>	Kind	Value	Annotation	enumeration	0128001	documentation glattwandig	enumeration	0128002	documentation beschichtet	enumeration	0128003	documentation texturiert
Kind	Value	Annotation											
enumeration	0128001	documentation glattwandig											
enumeration	0128002	documentation beschichtet											
enumeration	0128003	documentation texturiert											

source	<code><element name="ABI_OberflaecheSchluesse1" type="enum_0128"/></code>
--------	---

element **ArtikelBrustimplantatBasis/ABI_OberflaecheUnbekannt**

diagram							
type	JaLeer						
properties	content simple						
facets	<table border="1"> <thead> <tr> <th>Kind</th> <th>Value</th> <th>Annotation</th> </tr> </thead> <tbody> <tr> <td>pattern</td> <td>(1)</td> <td></td> </tr> </tbody> </table>	Kind	Value	Annotation	pattern	(1)	
Kind	Value	Annotation					
pattern	(1)						
source	<code><element name="ABI_OberflaecheUnbekannt" type="JaLeer"/></code>						

element **ArtikelBrustimplantatBasis/ABI_FuellungSchluesse1**

diagram																
type	enum_0124															
properties	content simple															
facets	<table border="1"> <thead> <tr> <th>Kind</th> <th>Value</th> <th>Annotation</th> </tr> </thead> <tbody> <tr> <td>enumeration</td> <td>0124001</td> <td>documentation Salzlösung</td> </tr> <tr> <td>enumeration</td> <td>0124002</td> <td>documentation Silikongel</td> </tr> <tr> <td>enumeration</td> <td>0124003</td> <td>documentation Kombination Silikongel und Salzlösung</td> </tr> <tr> <td>enumeration</td> <td>0124042</td> <td>documentation sonstige</td> </tr> </tbody> </table>	Kind	Value	Annotation	enumeration	0124001	documentation Salzlösung	enumeration	0124002	documentation Silikongel	enumeration	0124003	documentation Kombination Silikongel und Salzlösung	enumeration	0124042	documentation sonstige
Kind	Value	Annotation														
enumeration	0124001	documentation Salzlösung														
enumeration	0124002	documentation Silikongel														
enumeration	0124003	documentation Kombination Silikongel und Salzlösung														
enumeration	0124042	documentation sonstige														
source	<code><element name="ABI_FuellungSchluesse1" type="enum_0124"/></code>															

element **ArtikelBrustimplantatBasis/ABI_FuellungUnbekannt**

diagram							
type	JaLeer						
properties	content simple						
facets	<table border="1"> <thead> <tr> <th>Kind</th> <th>Value</th> <th>Annotation</th> </tr> </thead> <tbody> <tr> <td>pattern</td> <td>(1)</td> <td></td> </tr> </tbody> </table>	Kind	Value	Annotation	pattern	(1)	
Kind	Value	Annotation					
pattern	(1)						
source	<code><element name="ABI_FuellungUnbekannt" type="JaLeer"/></code>						

element **ArtikelBrustimplantatBasis/ABI_Volumen**

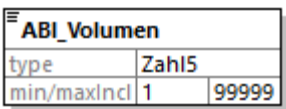
diagram										
type	Zahl5									
properties	content simple									
facets	<table border="1"> <thead> <tr> <th>Kind</th> <th>Value</th> <th>Annotation</th> </tr> </thead> <tbody> <tr> <td>minInclusive</td> <td>1</td> <td></td> </tr> <tr> <td>maxInclusive</td> <td>99999</td> <td></td> </tr> </tbody> </table>	Kind	Value	Annotation	minInclusive	1		maxInclusive	99999	
Kind	Value	Annotation								
minInclusive	1									
maxInclusive	99999									
source	<code><element name="ABI_Volumen" type="Zahl5"/></code>									

element **ArtikelBrustimplantatBasis/ABI_VolumenUnbekannt**

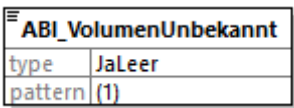
diagram							
type	JaLeer						
properties	content simple						
facets	<table border="1"> <thead> <tr> <th>Kind</th> <th>Value</th> <th>Annotation</th> </tr> </thead> <tbody> <tr> <td>pattern</td> <td>(1)</td> <td></td> </tr> </tbody> </table>	Kind	Value	Annotation	pattern	(1)	
Kind	Value	Annotation					
pattern	(1)						
source	<code><element name="ABI_VolumenUnbekannt" type="JaLeer"/></code>						

element **ArtikelBrustimplantatBasis/ABI_IntraoperativesVolumen**

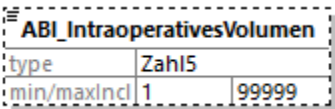
diagram										
type	Zahl5									
properties	<table border="1"> <tbody> <tr> <td>minOcc</td> <td>0</td> </tr> <tr> <td>maxOcc</td> <td>1</td> </tr> <tr> <td>content</td> <td>simple</td> </tr> </tbody> </table>	minOcc	0	maxOcc	1	content	simple			
minOcc	0									
maxOcc	1									
content	simple									
facets	<table border="1"> <thead> <tr> <th>Kind</th> <th>Value</th> <th>Annotation</th> </tr> </thead> <tbody> <tr> <td>minInclusive</td> <td>1</td> <td></td> </tr> <tr> <td>maxInclusive</td> <td>99999</td> <td></td> </tr> </tbody> </table>	Kind	Value	Annotation	minInclusive	1		maxInclusive	99999	
Kind	Value	Annotation								
minInclusive	1									
maxInclusive	99999									
source	<code><element name="ABI_IntraoperativesVolumen" type="Zahl5" minOccurs="0"/></code>									

complexType **ArtikelEndoprotheseBasis**

diagram	
namespace	http://xml.ir-d.de/emg
children	AEP HerstellerSchluessel AEP HerstellerUnbekannt AEP HerstellerSonstiger AEP ArtikelTypSchluessel
used by	element Artikelbeschreibung/artikelEndoprothese
source	<pre> <complexType name="ArtikelEndoprotheseBasis"> <sequence> <choice> <element name="AEP_HerstellerSchluessel" type="enum_0230"/> <element name="AEP_HerstellerUnbekannt" type="JaLeer"/> </choice> <element name="AEP_HerstellerSonstiger" type="Freitext250" minOccurs="0"/> <element name="AEP_ArtikelTypSchluessel" type="enum_0290"/> </sequence> </complexType> </pre>

element **ArtikelEndoprotheseBasis/AEP_HerstellerSchluessel**

diagram																															
type	enum 0230																														
properties	content simple																														
facets	<table border="1"> <thead> <tr> <th>Kind</th> <th>Value</th> <th>Annotation</th> </tr> </thead> <tbody> <tr> <td>enumeration</td> <td>0230001</td> <td>documentation Smith & Nephew GmbH</td> </tr> <tr> <td>enumeration</td> <td>0230002</td> <td>documentation Mathys Orthopädie GmbH</td> </tr> <tr> <td>enumeration</td> <td>0230003</td> <td>documentation Ceramtec AG</td> </tr> <tr> <td>enumeration</td> <td>0230004</td> <td>documentation Biomet</td> </tr> <tr> <td>enumeration</td> <td>0230005</td> <td>documentation Peter Brehm GmbH</td> </tr> <tr> <td>enumeration</td> <td>0230006</td> <td>documentation Amplitude GmbH</td> </tr> <tr> <td>enumeration</td> <td>0230007</td> <td>documentation Exactech Deutschland</td> </tr> <tr> <td>enumeration</td> <td>0230008</td> <td>documentation Globus Medical</td> </tr> <tr> <td>enumeration</td> <td>0230009</td> <td>documentation Implantcast GmbH</td> </tr> </tbody> </table>	Kind	Value	Annotation	enumeration	0230001	documentation Smith & Nephew GmbH	enumeration	0230002	documentation Mathys Orthopädie GmbH	enumeration	0230003	documentation Ceramtec AG	enumeration	0230004	documentation Biomet	enumeration	0230005	documentation Peter Brehm GmbH	enumeration	0230006	documentation Amplitude GmbH	enumeration	0230007	documentation Exactech Deutschland	enumeration	0230008	documentation Globus Medical	enumeration	0230009	documentation Implantcast GmbH
Kind	Value	Annotation																													
enumeration	0230001	documentation Smith & Nephew GmbH																													
enumeration	0230002	documentation Mathys Orthopädie GmbH																													
enumeration	0230003	documentation Ceramtec AG																													
enumeration	0230004	documentation Biomet																													
enumeration	0230005	documentation Peter Brehm GmbH																													
enumeration	0230006	documentation Amplitude GmbH																													
enumeration	0230007	documentation Exactech Deutschland																													
enumeration	0230008	documentation Globus Medical																													
enumeration	0230009	documentation Implantcast GmbH																													

enumeration	0230010	documentation DePuy Orthopädie GmbH
enumeration	0230011	documentation IO-International Orthopaedics
enumeration	0230012	documentation Joint Replacement Ltd. Instrumentation
enumeration	0230013	documentation Merete
enumeration	0230014	documentation S&G Implants GmbH
enumeration	0230015	documentation Speetec Implantate GmbH
enumeration	0230016	documentation Stemcup Medical Products GmbH
enumeration	0230017	documentation Symbios Deutschland GmbH
enumeration	0230018	documentation Tantum AG
enumeration	0230019	documentation Tomier GmbH
enumeration	0230020	documentation MicroPort Orthopedics GmbH
enumeration	0230021	documentation aap Implanate AG
enumeration	0230022	documentation AQImplants
enumeration	0230023	documentation ESKA Orthodynamics GmbH
enumeration	0230024	documentation Atesos medical AG
enumeration	0230025	documentation Chiropro GmbH
enumeration	0230026	documentation Medacta
enumeration	0230027	documentation OHST Medizintechnik AG
enumeration	0230028	documentation Lima Deutschland GmbH
enumeration	0230029	documentation alloPlus GmbH
enumeration	0230030	documentation Heraeus Medical GmbH
enumeration	0230031	documentation ImplanTec Deutschland GmbH
enumeration	0230032	documentation Falcon Medical GmbH
enumeration	0230033	documentation Meril GmbH
enumeration	0230034	documentation Zimmer Germany GmbH
enumeration	0230035	documentation Stryker GmbH & Co. KG
enumeration	0230036	documentation Aesculap AG
enumeration	0230037	documentation Waldemar Link GmbH & Co. KG
enumeration	0230038	documentation Corin Germany GmbH
enumeration	0230039	documentation nicht belegter Wert
enumeration	0230040	documentation nicht belegter Wert
enumeration	0230041	documentation nicht belegter Wert
enumeration	0230042	documentation nicht belegter Wert

	enumeration 0230043 sonstige documentation nicht belegter Wert
	enumeration 0230044 sonstige documentation nicht belegter Wert
source	<code><element name="AEP_HerstellerSchluessel" type="enum_0230"/></code>

element ArtikelEndoprotheseBasis/AEP_HerstellerUnbekannt

diagram	
type	JaLeer
properties	content simple
facets	Kind Value Annotation pattern (1)
source	<code><element name="AEP_HerstellerUnbekannt" type="JaLeer"/></code>

element ArtikelEndoprotheseBasis/AEP_HerstellerSonstiger

diagram	
type	Freitext250
properties	minOcc 0 maxOcc 1 content simple
facets	Kind Value Annotation maxLength 250
source	<code><element name="AEP_HerstellerSonstiger" type="Freitext250" minOccurs="0"/></code>

element ArtikelEndoprotheseBasis/AEP_ArtikelTypSchluessel

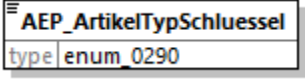
diagram	
type	enum_0290
properties	content simple
facets	Kind Value Annotation enumeration 0290001 documentation Hüft-Komponente enumeration 0290002 documentation Knie-Komponente enumeration 0290003 documentation Modulare Komponente (Hüfte/Knie)
source	<code><element name="AEP_ArtikelTypSchluessel" type="enum_0290"/></code>

complexType **ArtikelAortenklappeBasis**

diagram	
namespace	http://xml.ir-d.de/emg
children	AAK ArtikelTypSchluessel AAK HerstellerSchluessel AAK HerstellerUnbekannt AAK HerstellerSonstiger AAK ProthesenGroesse AAK ProthesenGroesseUnbekannt AAK Dislokation
used by	element Artikelbeschreibung/artikelAortenklappe
source	<pre> <complexType name="ArtikelAortenklappeBasis"> <sequence> <element name="AAK_ArtikelTypSchluessel" type="enum_0390" minOccurs="0"/> <choice> <element name="AAK_HerstellerSchluessel" type="enum_0330"/> <element name="AAK_HerstellerUnbekannt" type="JaLeer"/> </choice> <element name="AAK_HerstellerSonstiger" type="Freitext250" minOccurs="0"/> <choice> <element name="AAK_ProthesenGroesse" type="Zahl2"/> <element name="AAK_ProthesenGroesseUnbekannt" type="JaLeer"/> </choice> <element name="AAK_Dislokation" type="JaLeer" minOccurs="0"/> </sequence> </complexType> </pre>

element **ArtikelAortenklappeBasis/AAK_ArtikelTypSchluessel**

diagram	
type	enum 0390
properties	minOcc 0

	maxOcc 1 content simple									
facets	<table border="1"> <thead> <tr> <th>Kind</th> <th>Value</th> <th>Annotation</th> </tr> </thead> <tbody> <tr> <td>enumeration</td> <td>0390001</td> <td>documentation biologisches Klappenmodell</td> </tr> <tr> <td>enumeration</td> <td>0390002</td> <td>documentation mechanisches Klappenmodell</td> </tr> </tbody> </table>	Kind	Value	Annotation	enumeration	0390001	documentation biologisches Klappenmodell	enumeration	0390002	documentation mechanisches Klappenmodell
Kind	Value	Annotation								
enumeration	0390001	documentation biologisches Klappenmodell								
enumeration	0390002	documentation mechanisches Klappenmodell								
source	<code><element name="AAK_ArtikelTypSchluessel" type="enum_0390" minOccurs="0"/></code>									

element **ArtikelAortenklappeBasis/AAK_HerstellerSchluessel**

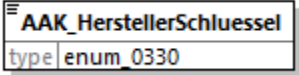
diagram																																																	
type	enum 0330																																																
properties	content simple																																																
facets	<table border="1"> <thead> <tr> <th>Kind</th> <th>Value</th> <th>Annotation</th> </tr> </thead> <tbody> <tr> <td>enumeration</td> <td>0330001</td> <td>documentation ATS Medical</td> </tr> <tr> <td>enumeration</td> <td>0330002</td> <td>documentation Edwards Lifesciences</td> </tr> <tr> <td>enumeration</td> <td>0330003</td> <td>documentation Medtronic</td> </tr> <tr> <td>enumeration</td> <td>0330004</td> <td>documentation JenaValve</td> </tr> <tr> <td>enumeration</td> <td>0330005</td> <td>documentation Corcym</td> </tr> <tr> <td>enumeration</td> <td>0330006</td> <td>documentation St.Jude Medical/Abbott</td> </tr> <tr> <td>enumeration</td> <td>0330007</td> <td>documentation Symetis</td> </tr> <tr> <td>enumeration</td> <td>0330008</td> <td>documentation Direct Flow Medical</td> </tr> <tr> <td>enumeration</td> <td>0330009</td> <td>documentation Boston Scientific</td> </tr> <tr> <td>enumeration</td> <td>0330010</td> <td>documentation nicht belegter Wert</td> </tr> <tr> <td>enumeration</td> <td>0330011</td> <td>documentation nicht belegter Wert</td> </tr> <tr> <td>enumeration</td> <td>0330012</td> <td>documentation nicht belegter Wert</td> </tr> <tr> <td>enumeration</td> <td>0330013</td> <td>documentation nicht belegter Wert</td> </tr> <tr> <td>enumeration</td> <td>0330014</td> <td>documentation nicht belegter Wert</td> </tr> <tr> <td>enumeration</td> <td>0330042</td> <td>documentation sonstiger Hersteller</td> </tr> </tbody> </table>	Kind	Value	Annotation	enumeration	0330001	documentation ATS Medical	enumeration	0330002	documentation Edwards Lifesciences	enumeration	0330003	documentation Medtronic	enumeration	0330004	documentation JenaValve	enumeration	0330005	documentation Corcym	enumeration	0330006	documentation St.Jude Medical/Abbott	enumeration	0330007	documentation Symetis	enumeration	0330008	documentation Direct Flow Medical	enumeration	0330009	documentation Boston Scientific	enumeration	0330010	documentation nicht belegter Wert	enumeration	0330011	documentation nicht belegter Wert	enumeration	0330012	documentation nicht belegter Wert	enumeration	0330013	documentation nicht belegter Wert	enumeration	0330014	documentation nicht belegter Wert	enumeration	0330042	documentation sonstiger Hersteller
Kind	Value	Annotation																																															
enumeration	0330001	documentation ATS Medical																																															
enumeration	0330002	documentation Edwards Lifesciences																																															
enumeration	0330003	documentation Medtronic																																															
enumeration	0330004	documentation JenaValve																																															
enumeration	0330005	documentation Corcym																																															
enumeration	0330006	documentation St.Jude Medical/Abbott																																															
enumeration	0330007	documentation Symetis																																															
enumeration	0330008	documentation Direct Flow Medical																																															
enumeration	0330009	documentation Boston Scientific																																															
enumeration	0330010	documentation nicht belegter Wert																																															
enumeration	0330011	documentation nicht belegter Wert																																															
enumeration	0330012	documentation nicht belegter Wert																																															
enumeration	0330013	documentation nicht belegter Wert																																															
enumeration	0330014	documentation nicht belegter Wert																																															
enumeration	0330042	documentation sonstiger Hersteller																																															
source	<code><element name="AAK_HerstellerSchluessel" type="enum_0330"/></code>																																																

element **ArtikelAortenklappeBasis/AAK_HerstellerUnbekannt**

diagram	
type	JaLeer

properties	content simple
facets	Kind Value Annotation pattern (1)
source	<code><element name="AAK_HerstellerUnbekannt" type="JaLeer"/></code>

element **ArtikelAortenklappeBasis/AAK_HerstellerSonstiger**

diagram	
type	Freitext250
properties	minOcc 0 maxOcc 1 content simple
facets	Kind Value Annotation maxLength 250
source	<code><element name="AAK_HerstellerSonstiger" type="Freitext250" minOccurs="0"/></code>

element **ArtikelAortenklappeBasis/AAK_ProthesenGrossesse**

diagram	
type	Zahl2
properties	content simple
facets	Kind Value Annotation minInclusive 1 maxInclusive 99
source	<code><element name="AAK_ProthesenGrossesse" type="Zahl2"/></code>

element **ArtikelAortenklappeBasis/AAK_ProthesenGrossesseUnbekannt**

diagram	
type	JaLeer
properties	content simple
facets	Kind Value Annotation pattern (1)
source	<code><element name="AAK_ProthesenGrossesseUnbekannt" type="JaLeer"/></code>

element **ArtikelAortenklappeBasis/AAK_Dislokation**

diagram	 <pre> AAK_Dislokation type JaLeer pattern (1) </pre>
type	JaLeer
properties	minOcc 0 maxOcc 1 content simple
facets	Kind Value Annotation pattern (1)
source	<code><element name="AAK_Dislokation" type="JaLeer" minOccurs="0"/></code>