

## Schema IRD\_XML\_Spezifikation.xsd

schema location: [http://xml.ir-d.de/rst/schema/verbindlich/V3.1.2/IRD\\_XML\\_Spezifikation.xsd](http://xml.ir-d.de/rst/schema/verbindlich/V3.1.2/IRD_XML_Spezifikation.xsd)  
attributeFormDefault:  
elementFormDefault: **unqualified**  
targetNamespace: **http://xml.ir-d.de/rst**

Elements

[GEMeldung](#)

[GESelbstauskunft](#)

[GESTorno](#)

[IRDMeldungAntwort](#)

[IRDSelbstauskunftAntwort](#)

[IRDStornoAntwort](#)

schema location: <http://xml.ir-d.de/rst/schema/verbindlich/V3.1.2/GEMeldung.xsd>  
attributeFormDefault:  
elementFormDefault: **unqualified**  
targetNamespace: **http://xml.ir-d.de/emg**

Complex types

[GeMeldung](#)

schema location: <http://xml.ir-d.de/rst/schema/verbindlich/V3.1.2/GESTorno.xsd>  
attributeFormDefault:  
elementFormDefault: **unqualified**  
targetNamespace: **http://xml.ir-d.de/stn**

Complex types

[GeStorno](#)

schema location: <http://xml.ir-d.de/rst/schema/verbindlich/V3.1.2/IRDMeldungAntwort.xsd>  
attributeFormDefault:  
elementFormDefault: **unqualified**  
targetNamespace: **http://xml.ir-d.de/irdma**

Complex types

[meldungAntwort](#)

schema location: <http://xml.ir-d.de/rst/schema/verbindlich/V3.1.2/IRDStornoAntwort.xsd>  
attributeFormDefault:  
elementFormDefault: **unqualified**  
targetNamespace: **http://xml.ir-d.de/irdsa**

Complex types

[stornoAntwort](#)

schema location: <http://xml.ir-d.de/rst/schema/verbindlich/V3.1.2/GESelbstauskunft.xsd>  
attributeFormDefault:  
elementFormDefault: **unqualified**  
targetNamespace: **http://xml.ir-d.de/sak**

Complex types

[GeSelbstauskunft](#)

schema location: <http://xml.ir-d.de/rst/schema/verbindlich/V3.1.2/IRDSelbstauskunftAntwort.xsd>  
attributeFormDefault:  
elementFormDefault: **unqualified**  
targetNamespace: **http://xml.ir-d.de/irdsaa**

Complex types

[selbstauskunftAntwort](#)

schema location: <http://xml.ir-d.de/rst/schema/verbindlich/V3.1.2/Bausteine/Meldung.xsd>  
attributeFormDefault:  
elementFormDefault: **unqualified**  
targetNamespace: **http://xml.ir-d.de/emg**

Complex types

[Meldung](#)

schema location: <http://xml.ir-d.de/rst/schema/verbindlich/V3.1.2/Bausteine/Storno.xsd>  
attributeFormDefault:  
elementFormDefault: **unqualified**  
targetNamespace: **http://xml.ir-d.de/stn**

Complex types

[Storno](#)

schema location: <http://xml.ir-d.de/rst/schema/verbindlich/V3.1.2/Bausteine/MeldungIrd.xsd>  
attributeFormDefault:  
elementFormDefault: **unqualified**  
targetNamespace: **http://xml.ir-d.de/irdma**

Complex types

[MeldungIrd](#)

schema location: <http://xml.ir-d.de/rst/schema/verbindlich/V3.1.2/Bausteine/EmpfangsbestaetigungBasis.xsd>  
attributeFormDefault:  
elementFormDefault: **unqualified**  
targetNamespace: **http://xml.ir-d.de/irdma**

Complex types

[EmpfangsbestaetigungBasis](#)

schema location: <http://xml.ir-d.de/rst/schema/verbindlich/V3.1.2/Bausteine/HinweisBasis.xsd>  
attributeFormDefault:  
elementFormDefault: **unqualified**  
targetNamespace: **http://xml.ir-d.de/irdma**

Complex types

[HinweisBasis](#)

schema location: <http://xml.ir-d.de/rst/schema/verbindlich/V3.1.2/Bausteine/Warnung.xsd>  
attributeFormDefault:  
elementFormDefault: **unqualified**  
targetNamespace: **http://xml.ir-d.de/irdma**

Complex types

[Warnung](#)

schema location: <http://xml.ir-d.de/rst/schema/verbindlich/V3.1.2/Bausteine/BestaetigungBasis.xsd>  
attributeFormDefault:  
elementFormDefault: **unqualified**  
targetNamespace: **http://xml.ir-d.de/irdma**

Complex types

[BestaetigungBasis](#)

schema location: <http://xml.ir-d.de/rst/schema/verbindlich/V3.1.2/Bausteine/Storno.xsd>  
attributeFormDefault:  
elementFormDefault: **unqualified**  
targetNamespace: **http://xml.ir-d.de/irdsa**

Complex types

[Storno](#)

schema location: <http://xml.ir-d.de/rst/schema/verbindlich/V3.1.2/Bausteine/EmpfangsbestaetigungBasis.xsd>  
attributeFormDefault:  
elementFormDefault: **unqualified**  
targetNamespace: **http://xml.ir-d.de/irdsa**

Complex types

[EmpfangsbestaetigungBasis](#)

schema location: <http://xml.ir-d.de/rst/schema/verbindlich/V3.1.2/Bausteine/HinweisBasis.xsd>  
attributeFormDefault:  
elementFormDefault: **unqualified**  
targetNamespace: **http://xml.ir-d.de/irdsa**

Complex types

[HinweisBasis](#)

schema location: <http://xml.ir-d.de/rst/schema/verbindlich/V3.1.2/Bausteine/Selbstauskunft.xsd>  
attributeFormDefault:  
elementFormDefault: **unqualified**  
targetNamespace: **http://xml.ir-d.de/sak**

Complex types

[Selbstauskunft](#)

schema location: <http://xml.ir-d.de/rst/schema/verbindlich/V3.1.2/Bausteine/Selbstauskunft.xsd>  
attributeFormDefault:  
elementFormDefault: **unqualified**  
targetNamespace: **http://xml.ir-d.de/irdsaa**

Complex types

[Selbstauskunft](#)

schema location: <http://xml.ir-d.de/rst/schema/verbindlich/V3.1.2/Bausteine/EmpfangsbestaetigungBasis.xsd>  
attributeFormDefault:  
elementFormDefault: **unqualified**  
targetNamespace: **http://xml.ir-d.de/irdsaa**

Complex types

[EmpfangsbestaetigungBasis](#)

schema location: <http://xml.ir-d.de/rst/schema/verbindlich/V3.1.2/Bausteine/MeldungBasis.xsd>  
attributeFormDefault:  
elementFormDefault: **unqualified**  
targetNamespace: **http://xml.ir-d.de/emg**

Complex types

[MeldungBasis](#)

schema location: <http://xml.ir-d.de/rst/schema/verbindlich/V3.1.2/Bausteine/Fall.xsd>  
attributeFormDefault:  
elementFormDefault: **unqualified**  
targetNamespace: **http://xml.ir-d.de/emg**

Complex types

[Fall](#)

schema location: [http://xml.ir-d.de/rst/schema/verbindlich/V3.1.2/Datentypen/IRD\\_DatenTypen.xsd](http://xml.ir-d.de/rst/schema/verbindlich/V3.1.2/Datentypen/IRD_DatenTypen.xsd)  
attributeFormDefault:  
elementFormDefault: **unqualified**  
targetNamespace: **http://xml.ir-d.de/stn**

Simple types

[DatumText](#)

[Freitext250](#)

[Freitext500](#)

[HashString](#)

[HashWert](#)

[ICD](#)

[IdEinrichtung](#)

[IrdArtikelId](#)

[IrdSpezVersion](#)

[JaLeer](#)

[Meldebestaetigung](#)

[OPS](#)

[String2](#)

[String20](#)

[Sw](#)

[Transfervnummer](#)

[Versionsnummer](#)

[Zahl1](#)

[Zahl1\\_1](#)

[Zahl2](#)

[Zahl2\\_1](#)

[Zahl3](#)

[Zahl3\\_1](#)

[Zahl4](#)  
[Zahl5](#)  
[Zahl5mitNull](#)

schema location: <http://xml.ir-d.de/rst/schema/verbindlich/V3.1.2/Bausteine/MeldungIrdBasis.xsd>  
attributeFormDefault:  
elementFormDefault: **unqualified**  
targetNamespace: **http://xml.ir-d.de/stn**

Complex types  
[MeldungIrdBasis](#)

schema location: <http://xml.ir-d.de/rst/schema/verbindlich/V3.1.2/Bausteine/StornoFallBasis.xsd>  
attributeFormDefault:  
elementFormDefault: **unqualified**  
targetNamespace: **http://xml.ir-d.de/stn**

Complex types  
[StornoFallBasis](#)

schema location: [http://xml.ir-d.de/rst/schema/verbindlich/V3.1.2/Datentypen/IRD\\_DatenTypen.xsd](http://xml.ir-d.de/rst/schema/verbindlich/V3.1.2/Datentypen/IRD_DatenTypen.xsd)  
attributeFormDefault:  
elementFormDefault: **unqualified**  
targetNamespace: **http://xml.ir-d.de/irdma**

Simple types  
[DatumText](#)  
[Freitext250](#)  
[Freitext500](#)  
[HashString](#)  
[HashWert](#)  
[ICD](#)  
[IdEinrichtung](#)  
[IrdArtikelId](#)  
[IrdSpezVersion](#)  
[JaLeer](#)  
[Meldebestaetigung](#)  
[OPS](#)  
[String2](#)  
[String20](#)  
[Sw](#)  
[Transfervummer](#)  
[Versionsnummer](#)  
[Zahl1](#)  
[Zahl1\\_1](#)  
[Zahl2](#)  
[Zahl2\\_1](#)  
[Zahl3](#)  
[Zahl3\\_1](#)  
[Zahl4](#)

[Zahl5](#)  
[Zahl5mitNull](#)

schema location: <http://xml.ir-d.de/rst/schema/verbindlich/V3.1.2/Bausteine/MeldungIrdBasis.xsd>  
attributeFormDefault:  
elementFormDefault: **unqualified**  
targetNamespace: **http://xml.ir-d.de/irdma**

Complex types  
[MeldungIrdBasis](#)

schema location: <http://xml.ir-d.de/rst/schema/verbindlich/V3.1.2/Bausteine/MeldungIrdFallBasis.xsd>  
attributeFormDefault:  
elementFormDefault: **unqualified**  
targetNamespace: **http://xml.ir-d.de/irdma**

Complex types  
[MeldungIrdFallBasis](#)

schema location: [http://xml.ir-d.de/rst/schema/verbindlich/V3.1.2/Datentypen/IRD\\_DatenTypen.xsd](http://xml.ir-d.de/rst/schema/verbindlich/V3.1.2/Datentypen/IRD_DatenTypen.xsd)  
attributeFormDefault:  
elementFormDefault: **unqualified**  
targetNamespace: **http://xml.ir-d.de/irdsa**

Simple types  
[DatumText](#)  
[Freitext250](#)  
[Freitext500](#)  
[HashString](#)  
[HashWert](#)  
[ICD](#)  
[IdEinrichtung](#)  
[IrdArtikelId](#)  
[IrdSpezVersion](#)  
[JaLeer](#)  
[Meldebestaetigung](#)  
[OPS](#)  
[String2](#)  
[String20](#)  
[Sw](#)  
[Transfervnummer](#)  
[Versionsnummer](#)  
[Zahl1](#)  
[Zahl1\\_1](#)  
[Zahl2](#)  
[Zahl2\\_1](#)  
[Zahl3](#)  
[Zahl3\\_1](#)  
[Zahl4](#)  
[Zahl5](#)

## [Zahl5mitNull](#)

schema location: <http://xml.ir-d.de/rst/schema/verbindlich/V3.1.2/Bausteine/MeldungIrdBasis.xsd>  
attributeFormDefault:  
elementFormDefault: **unqualified**  
targetNamespace: **http://xml.ir-d.de/irdsa**

Complex types

### [MeldungIrdBasis](#)

schema location: <http://xml.ir-d.de/rst/schema/verbindlich/V3.1.2/Bausteine/StornoFallBasis.xsd>  
attributeFormDefault:  
elementFormDefault: **unqualified**  
targetNamespace: **http://xml.ir-d.de/irdsa**

Complex types

### [StornoFallBasis](#)

schema location: [http://xml.ir-d.de/rst/schema/verbindlich/V3.1.2/Datentypen/IRD\\_DatenTypen.xsd](http://xml.ir-d.de/rst/schema/verbindlich/V3.1.2/Datentypen/IRD_DatenTypen.xsd)  
attributeFormDefault:  
elementFormDefault: **unqualified**  
targetNamespace: **http://xml.ir-d.de/sak**

Simple types

[DatumText](#)

[Freitext250](#)

[Freitext500](#)

[HashString](#)

[HashWert](#)

[ICD](#)

[IdEinrichtung](#)

[IrdArtikellId](#)

[IrdSpezVersion](#)

[JaLeer](#)

[Meldebestaetigung](#)

[OPS](#)

[String2](#)

[String20](#)

[Sw](#)

[Transfervnummer](#)

[Versionsnummer](#)

[Zahl1](#)

[Zahl1\\_1](#)

[Zahl2](#)

[Zahl2\\_1](#)

[Zahl3](#)

[Zahl3\\_1](#)

[Zahl4](#)

[Zahl5](#)

[Zahl5mitNull](#)



schema location: <http://xml.ir-d.de/rst/schema/verbindlich/V3.1.2/Bausteine/MeldungIrdBasis.xsd>  
attributeFormDefault:  
elementFormDefault: **unqualified**  
targetNamespace: **http://xml.ir-d.de/sak**

Complex types  
[MeldungIrdBasis](#)

schema location: <http://xml.ir-d.de/rst/schema/verbindlich/V3.1.2/Bausteine/SelbstauskunftFallBasis.xsd>  
attributeFormDefault:  
elementFormDefault: **unqualified**  
targetNamespace: **http://xml.ir-d.de/sak**

Complex types  
[SelbstauskunftFallBasis](#)

schema location: [http://xml.ir-d.de/rst/schema/verbindlich/V3.1.2/Datentypen/IRD\\_DatenTypen.xsd](http://xml.ir-d.de/rst/schema/verbindlich/V3.1.2/Datentypen/IRD_DatenTypen.xsd)  
attributeFormDefault:  
elementFormDefault: **unqualified**  
targetNamespace: **http://xml.ir-d.de/irdsaa**

Simple types  
[DatumText](#)  
[Freitext250](#)  
[Freitext500](#)  
[HashString](#)  
[HashWert](#)  
[ICD](#)  
[IdEinrichtung](#)  
[IrdArtikelId](#)  
[IrdSpezVersion](#)  
[JaLeer](#)  
[Meldebestaetigung](#)  
[OPS](#)  
[String2](#)  
[String20](#)  
[Sw](#)  
[Transfervnummer](#)  
[Versionsnummer](#)  
[Zahl1](#)  
[Zahl1\\_1](#)  
[Zahl2](#)  
[Zahl2\\_1](#)  
[Zahl3](#)  
[Zahl3\\_1](#)  
[Zahl4](#)  
[Zahl5](#)  
[Zahl5mitNull](#)

schema location: <http://xml.ir-d.de/rst/schema/verbindlich/V3.1.2/Bausteine/MeldungIrdBasis.xsd>  
attributeFormDefault:  
elementFormDefault: **unqualified**  
targetNamespace: **http://xml.ir-d.de/irdsaa**

Complex types  
[MeldungIrdBasis](#)

schema location: <http://xml.ir-d.de/rst/schema/verbindlich/V3.1.2/Bausteine/SelbstauskunftFallBasis.xsd>  
attributeFormDefault:  
elementFormDefault: **unqualified**  
targetNamespace: **http://xml.ir-d.de/irdsaa**

Complex types  
[SelbstauskunftFallBasis](#)

schema location: [http://xml.ir-d.de/rst/schema/verbindlich/V3.1.2/Datentypen/IRD\\_DatenTypen.xsd](http://xml.ir-d.de/rst/schema/verbindlich/V3.1.2/Datentypen/IRD_DatenTypen.xsd)  
attributeFormDefault:  
elementFormDefault: **unqualified**  
targetNamespace: **http://xml.ir-d.de/emg**

Simple types  
[DatumText](#)  
[Freitext250](#)  
[Freitext500](#)  
[HashString](#)  
[HashWert](#)  
[ICD](#)  
[IdEinrichtung](#)  
[IrdArtikelId](#)  
[IrdSpezVersion](#)  
[JaLeer](#)  
[Meldebestaetigung](#)  
[OPS](#)  
[String2](#)  
[String20](#)  
[Sw](#)  
[Transfervnummer](#)  
[Versionsnummer](#)  
[Zahl1](#)  
[Zahl1 1](#)  
[Zahl2](#)  
[Zahl2 1](#)  
[Zahl3](#)  
[Zahl3 1](#)  
[Zahl4](#)  
[Zahl5](#)  
[Zahl5mitNull](#)

schema location: <http://xml.ir-d.de/rst/schema/verbindlich/V3.1.2/Bausteine/FallBasis.xsd>  
attributeFormDefault:  
elementFormDefault: **unqualified**  
targetNamespace: **http://xml.ir-d.de/emg**

Complex types  
[FallBasis](#)

schema location: <http://xml.ir-d.de/rst/schema/verbindlich/V3.1.2/Bausteine/AusloeserBasis.xsd>  
attributeFormDefault:  
elementFormDefault: **unqualified**  
targetNamespace: **http://xml.ir-d.de/emg**

Complex types  
[AusloeserBasis](#)

schema location: <http://xml.ir-d.de/rst/schema/verbindlich/V3.1.2/Bausteine/Patientenaufnahme.xsd>  
attributeFormDefault:  
elementFormDefault: **unqualified**  
targetNamespace: **http://xml.ir-d.de/emg**

Complex types  
[Patientenaufnahme](#)

schema location: <http://xml.ir-d.de/rst/schema/verbindlich/V3.1.2/Bausteine/Operation.xsd>  
attributeFormDefault:  
elementFormDefault: **unqualified**  
targetNamespace: **http://xml.ir-d.de/emg**

Complex types  
[Operation](#)

schema location: <http://xml.ir-d.de/rst/schema/verbindlich/V3.1.2/Bausteine/Entlassung.xsd>  
attributeFormDefault:  
elementFormDefault: **unqualified**  
targetNamespace: **http://xml.ir-d.de/emg**

Complex types  
[Entlassung](#)

schema location: <http://xml.ir-d.de/rst/schema/verbindlich/V3.1.2/Bausteine/PostoperationAortenklappe.xsd>  
attributeFormDefault:  
elementFormDefault: **unqualified**  
targetNamespace: **http://xml.ir-d.de/emg**

Complex types

[PostoperationAortenklappe](#)

schema location: [http://xml.ir-d.de/rst/schema/verbindlich/V3.1.2/Datentypen/IRD\\_Wertelisten.xsd](http://xml.ir-d.de/rst/schema/verbindlich/V3.1.2/Datentypen/IRD_Wertelisten.xsd)  
attributeFormDefault:  
elementFormDefault: **qualified**  
targetNamespace: **http://xml.ir-d.de/stn**

Simple types

[enum 0044](#)  
[enum 0050](#)  
[enum 0060](#)  
[enum 0061](#)  
[enum 0062](#)  
[enum 0065](#)  
[enum 0067](#)  
[enum 0068](#)  
[enum 0069](#)  
[enum 0070](#)  
[enum 0071](#)  
[enum 0075](#)  
[enum 0076](#)  
[enum 0080](#)  
[enum 0100](#)  
[enum 0102](#)  
[enum 0103](#)  
[enum 0104](#)  
[enum 0105](#)  
[enum 0106](#)  
[enum 0107](#)  
[enum 0110](#)  
[enum 0111](#)  
[enum 0112](#)  
[enum 0113](#)  
[enum 0114](#)  
[enum 0116](#)  
[enum 0118](#)  
[enum 0120](#)  
[enum 0121](#)  
[enum 0122](#)  
[enum 0123](#)  
[enum 0124](#)  
[enum 0126](#)  
[enum 0128](#)  
[enum 0130](#)  
[enum 0131](#)  
[enum 0190](#)  
[enum 0191](#)  
[enum 0200](#)  
[enum 0202](#)  
[enum 0204](#)  
[enum 0206](#)

[enum 0210](#)  
[enum 0211](#)  
[enum 0212](#)  
[enum 0220](#)  
[enum 0222](#)  
[enum 0230](#)  
[enum 0252](#)  
[enum 0254](#)  
[enum 0256](#)  
[enum 0262](#)  
[enum 0264](#)  
[enum 0266](#)  
[enum 0270](#)  
[enum 0271](#)  
[enum 0290](#)  
[enum 0291](#)  
[enum 0300](#)  
[enum 0302](#)  
[enum 0318](#)  
[enum 0320](#)  
[enum 0322](#)  
[enum 0324](#)  
[enum 0330](#)  
[enum 0338](#)  
[enum 0339](#)  
[enum 0341](#)  
[enum 0342](#)  
[enum 0343](#)  
[enum 0346](#)  
[enum 0347](#)  
[enum 0348](#)  
[enum 0350](#)  
[enum 0351](#)  
[enum 0352](#)  
[enum 0353](#)  
[enum 0354](#)  
[enum 0357](#)  
[enum 0358](#)  
[enum 0359](#)  
[enum 0360](#)  
[enum 0361](#)  
[enum 0362](#)  
[enum 0363](#)  
[enum 0364](#)  
[enum 0365](#)  
[enum 0366](#)  
[enum 0367](#)  
[enum 0368](#)  
[enum 0369](#)  
[enum 0370](#)  
[enum 0371](#)  
[enum 0372](#)  
[enum 0373](#)  
[enum 0374](#)  
[enum 0375](#)  
[enum 0376](#)  
[enum 0377](#)  
[enum 0378](#)  
[enum 0379](#)  
[enum 0380](#)  
[enum 0381](#)  
[enum 0382](#)  
[enum 0383](#)  
[enum 0384](#)  
[enum 0385](#)

[enum 0388](#)  
[enum 0389](#)  
[enum 0390](#)  
[enum 0398](#)  
[enum 0399](#)

schema location: [http://xml.ir-d.de/rst/schema/verbindlich/V3.1.2/Datentypen/IRD\\_Wertelisten.xsd](http://xml.ir-d.de/rst/schema/verbindlich/V3.1.2/Datentypen/IRD_Wertelisten.xsd)  
attributeFormDefault:  
elementFormDefault: **qualified**  
targetNamespace: <http://xml.ir-d.de/irdma>

Simple types

[enum 0044](#)  
[enum 0050](#)  
[enum 0060](#)  
[enum 0061](#)  
[enum 0062](#)  
[enum 0065](#)  
[enum 0067](#)  
[enum 0068](#)  
[enum 0069](#)  
[enum 0070](#)  
[enum 0071](#)  
[enum 0075](#)  
[enum 0076](#)  
[enum 0080](#)  
[enum 0100](#)  
[enum 0102](#)  
[enum 0103](#)  
[enum 0104](#)  
[enum 0105](#)  
[enum 0106](#)  
[enum 0107](#)  
[enum 0110](#)  
[enum 0111](#)  
[enum 0112](#)  
[enum 0113](#)  
[enum 0114](#)  
[enum 0116](#)  
[enum 0118](#)  
[enum 0120](#)  
[enum 0121](#)  
[enum 0122](#)  
[enum 0123](#)  
[enum 0124](#)  
[enum 0126](#)  
[enum 0128](#)  
[enum 0130](#)  
[enum 0131](#)  
[enum 0190](#)  
[enum 0191](#)  
[enum 0200](#)  
[enum 0202](#)  
[enum 0204](#)  
[enum 0206](#)  
[enum 0210](#)  
[enum 0211](#)  
[enum 0212](#)  
[enum 0220](#)  
[enum 0222](#)

[enum 0230](#)  
[enum 0252](#)  
[enum 0254](#)  
[enum 0256](#)  
[enum 0262](#)  
[enum 0264](#)  
[enum 0266](#)  
[enum 0270](#)  
[enum 0271](#)  
[enum 0290](#)  
[enum 0291](#)  
[enum 0300](#)  
[enum 0302](#)  
[enum 0318](#)  
[enum 0320](#)  
[enum 0322](#)  
[enum 0324](#)  
[enum 0330](#)  
[enum 0338](#)  
[enum 0339](#)  
[enum 0341](#)  
[enum 0342](#)  
[enum 0343](#)  
[enum 0346](#)  
[enum 0347](#)  
[enum 0348](#)  
[enum 0350](#)  
[enum 0351](#)  
[enum 0352](#)  
[enum 0353](#)  
[enum 0354](#)  
[enum 0357](#)  
[enum 0358](#)  
[enum 0359](#)  
[enum 0360](#)  
[enum 0361](#)  
[enum 0362](#)  
[enum 0363](#)  
[enum 0364](#)  
[enum 0365](#)  
[enum 0366](#)  
[enum 0367](#)  
[enum 0368](#)  
[enum 0369](#)  
[enum 0370](#)  
[enum 0371](#)  
[enum 0372](#)  
[enum 0373](#)  
[enum 0374](#)  
[enum 0375](#)  
[enum 0376](#)  
[enum 0377](#)  
[enum 0378](#)  
[enum 0379](#)  
[enum 0380](#)  
[enum 0381](#)  
[enum 0382](#)  
[enum 0383](#)  
[enum 0384](#)  
[enum 0385](#)  
[enum 0388](#)  
[enum 0389](#)  
[enum 0390](#)  
[enum 0398](#)  
[enum 0399](#)

schema location: [http://xml.ir-d.de/rst/schema/verbindlich/V3.1.2/Datentypen/IRD\\_Wertelisten.xsd](http://xml.ir-d.de/rst/schema/verbindlich/V3.1.2/Datentypen/IRD_Wertelisten.xsd)  
attributeFormDefault:  
elementFormDefault: **qualified**  
targetNamespace: **http://xml.ir-d.de/irdsa**

Simple types

[enum 0044](#)  
[enum 0050](#)  
[enum 0060](#)  
[enum 0061](#)  
[enum 0062](#)  
[enum 0065](#)  
[enum 0067](#)  
[enum 0068](#)  
[enum 0069](#)  
[enum 0070](#)  
[enum 0071](#)  
[enum 0075](#)  
[enum 0076](#)  
[enum 0080](#)  
[enum 0100](#)  
[enum 0102](#)  
[enum 0103](#)  
[enum 0104](#)  
[enum 0105](#)  
[enum 0106](#)  
[enum 0107](#)  
[enum 0110](#)  
[enum 0111](#)  
[enum 0112](#)  
[enum 0113](#)  
[enum 0114](#)  
[enum 0116](#)  
[enum 0118](#)  
[enum 0120](#)  
[enum 0121](#)  
[enum 0122](#)  
[enum 0123](#)  
[enum 0124](#)  
[enum 0126](#)  
[enum 0128](#)  
[enum 0130](#)  
[enum 0131](#)  
[enum 0190](#)  
[enum 0191](#)  
[enum 0200](#)  
[enum 0202](#)  
[enum 0204](#)  
[enum 0206](#)  
[enum 0210](#)  
[enum 0211](#)  
[enum 0212](#)  
[enum 0220](#)  
[enum 0222](#)  
[enum 0230](#)  
[enum 0252](#)  
[enum 0254](#)  
[enum 0256](#)  
[enum 0262](#)



[enum 0264](#)  
[enum 0266](#)  
[enum 0270](#)  
[enum 0271](#)  
[enum 0290](#)  
[enum 0291](#)  
[enum 0300](#)  
[enum 0302](#)  
[enum 0318](#)  
[enum 0320](#)  
[enum 0322](#)  
[enum 0324](#)  
[enum 0330](#)  
[enum 0338](#)  
[enum 0339](#)  
[enum 0341](#)  
[enum 0342](#)  
[enum 0343](#)  
[enum 0346](#)  
[enum 0347](#)  
[enum 0348](#)  
[enum 0350](#)  
[enum 0351](#)  
[enum 0352](#)  
[enum 0353](#)  
[enum 0354](#)  
[enum 0357](#)  
[enum 0358](#)  
[enum 0359](#)  
[enum 0360](#)  
[enum 0361](#)  
[enum 0362](#)  
[enum 0363](#)  
[enum 0364](#)  
[enum 0365](#)  
[enum 0366](#)  
[enum 0367](#)  
[enum 0368](#)  
[enum 0369](#)  
[enum 0370](#)  
[enum 0371](#)  
[enum 0372](#)  
[enum 0373](#)  
[enum 0374](#)  
[enum 0375](#)  
[enum 0376](#)  
[enum 0377](#)  
[enum 0378](#)  
[enum 0379](#)  
[enum 0380](#)  
[enum 0381](#)  
[enum 0382](#)  
[enum 0383](#)  
[enum 0384](#)  
[enum 0385](#)  
[enum 0388](#)  
[enum 0389](#)  
[enum 0390](#)  
[enum 0398](#)  
[enum 0399](#)

schema location:

[http://xml.ir-d.de/rst/schema/verbindlich/V3.1.2/Datentypen/IRD\\_Wertelisten.xsd](http://xml.ir-d.de/rst/schema/verbindlich/V3.1.2/Datentypen/IRD_Wertelisten.xsd)

attributeFormDefault:

elementFormDefault:

targetNamespace:

**qualified**

**http://xml.ir-d.de/sak**

Simple types

[enum 0044](#)

[enum 0050](#)

[enum 0060](#)

[enum 0061](#)

[enum 0062](#)

[enum 0065](#)

[enum 0067](#)

[enum 0068](#)

[enum 0069](#)

[enum 0070](#)

[enum 0071](#)

[enum 0075](#)

[enum 0076](#)

[enum 0080](#)

[enum 0100](#)

[enum 0102](#)

[enum 0103](#)

[enum 0104](#)

[enum 0105](#)

[enum 0106](#)

[enum 0107](#)

[enum 0110](#)

[enum 0111](#)

[enum 0112](#)

[enum 0113](#)

[enum 0114](#)

[enum 0116](#)

[enum 0118](#)

[enum 0120](#)

[enum 0121](#)

[enum 0122](#)

[enum 0123](#)

[enum 0124](#)

[enum 0126](#)

[enum 0128](#)

[enum 0130](#)

[enum 0131](#)

[enum 0190](#)

[enum 0191](#)

[enum 0200](#)

[enum 0202](#)

[enum 0204](#)

[enum 0206](#)

[enum 0210](#)

[enum 0211](#)

[enum 0212](#)

[enum 0220](#)

[enum 0222](#)

[enum 0230](#)

[enum 0252](#)

[enum 0254](#)

[enum 0256](#)

[enum 0262](#)

[enum 0264](#)

[enum 0266](#)

[enum 0270](#)

[enum 0271](#)

[enum 0290](#)

[enum 0291](#)  
[enum 0300](#)  
[enum 0302](#)  
[enum 0318](#)  
[enum 0320](#)  
[enum 0322](#)  
[enum 0324](#)  
[enum 0330](#)  
[enum 0338](#)  
[enum 0339](#)  
[enum 0341](#)  
[enum 0342](#)  
[enum 0343](#)  
[enum 0346](#)  
[enum 0347](#)  
[enum 0348](#)  
[enum 0350](#)  
[enum 0351](#)  
[enum 0352](#)  
[enum 0353](#)  
[enum 0354](#)  
[enum 0357](#)  
[enum 0358](#)  
[enum 0359](#)  
[enum 0360](#)  
[enum 0361](#)  
[enum 0362](#)  
[enum 0363](#)  
[enum 0364](#)  
[enum 0365](#)  
[enum 0366](#)  
[enum 0367](#)  
[enum 0368](#)  
[enum 0369](#)  
[enum 0370](#)  
[enum 0371](#)  
[enum 0372](#)  
[enum 0373](#)  
[enum 0374](#)  
[enum 0375](#)  
[enum 0376](#)  
[enum 0377](#)  
[enum 0378](#)  
[enum 0379](#)  
[enum 0380](#)  
[enum 0381](#)  
[enum 0382](#)  
[enum 0383](#)  
[enum 0384](#)  
[enum 0385](#)  
[enum 0388](#)  
[enum 0389](#)  
[enum 0390](#)  
[enum 0398](#)  
[enum 0399](#)

schema location: [http://xml.ir-d.de/rst/schema/verbindlich/V3.1.2/Datentypen/IRD\\_Wertlisten.xsd](http://xml.ir-d.de/rst/schema/verbindlich/V3.1.2/Datentypen/IRD_Wertlisten.xsd)  
attributeFormDefault:  
elementFormDefault: **qualified**  
targetNamespace: <http://xml.ir-d.de/irdsaa>

Simple types

[enum 0044](#)  
[enum 0050](#)  
[enum 0060](#)  
[enum 0061](#)  
[enum 0062](#)  
[enum 0065](#)  
[enum 0067](#)  
[enum 0068](#)  
[enum 0069](#)  
[enum 0070](#)  
[enum 0071](#)  
[enum 0075](#)  
[enum 0076](#)  
[enum 0080](#)  
[enum 0100](#)  
[enum 0102](#)  
[enum 0103](#)  
[enum 0104](#)  
[enum 0105](#)  
[enum 0106](#)  
[enum 0107](#)  
[enum 0110](#)  
[enum 0111](#)  
[enum 0112](#)  
[enum 0113](#)  
[enum 0114](#)  
[enum 0116](#)  
[enum 0118](#)  
[enum 0120](#)  
[enum 0121](#)  
[enum 0122](#)  
[enum 0123](#)  
[enum 0124](#)  
[enum 0126](#)  
[enum 0128](#)  
[enum 0130](#)  
[enum 0131](#)  
[enum 0190](#)  
[enum 0191](#)  
[enum 0200](#)  
[enum 0202](#)  
[enum 0204](#)  
[enum 0206](#)  
[enum 0210](#)  
[enum 0211](#)  
[enum 0212](#)  
[enum 0220](#)  
[enum 0222](#)  
[enum 0230](#)  
[enum 0252](#)  
[enum 0254](#)  
[enum 0256](#)  
[enum 0262](#)  
[enum 0264](#)  
[enum 0266](#)  
[enum 0270](#)  
[enum 0271](#)  
[enum 0290](#)  
[enum 0291](#)  
[enum 0300](#)  
[enum 0302](#)  
[enum 0318](#)  
[enum 0320](#)

[enum 0322](#)  
[enum 0324](#)  
[enum 0330](#)  
[enum 0338](#)  
[enum 0339](#)  
[enum 0341](#)  
[enum 0342](#)  
[enum 0343](#)  
[enum 0346](#)  
[enum 0347](#)  
[enum 0348](#)  
[enum 0350](#)  
[enum 0351](#)  
[enum 0352](#)  
[enum 0353](#)  
[enum 0354](#)  
[enum 0357](#)  
[enum 0358](#)  
[enum 0359](#)  
[enum 0360](#)  
[enum 0361](#)  
[enum 0362](#)  
[enum 0363](#)  
[enum 0364](#)  
[enum 0365](#)  
[enum 0366](#)  
[enum 0367](#)  
[enum 0368](#)  
[enum 0369](#)  
[enum 0370](#)  
[enum 0371](#)  
[enum 0372](#)  
[enum 0373](#)  
[enum 0374](#)  
[enum 0375](#)  
[enum 0376](#)  
[enum 0377](#)  
[enum 0378](#)  
[enum 0379](#)  
[enum 0380](#)  
[enum 0381](#)  
[enum 0382](#)  
[enum 0383](#)  
[enum 0384](#)  
[enum 0385](#)  
[enum 0388](#)  
[enum 0389](#)  
[enum 0390](#)  
[enum 0398](#)  
[enum 0399](#)

schema location: [http://xml.ir-d.de/rst/schema/verbindlich/V3.1.2/Datentypen/IRD\\_Wertelisten.xsd](http://xml.ir-d.de/rst/schema/verbindlich/V3.1.2/Datentypen/IRD_Wertelisten.xsd)  
attributeFormDefault:  
elementFormDefault: **qualified**  
targetNamespace: **http://xml.ir-d.de/emg**

Simple types  
[enum 0044](#)  
[enum 0050](#)  
[enum 0060](#)

[enum 0061](#)  
[enum 0062](#)  
[enum 0065](#)  
[enum 0067](#)  
[enum 0068](#)  
[enum 0069](#)  
[enum 0070](#)  
[enum 0071](#)  
[enum 0075](#)  
[enum 0076](#)  
[enum 0080](#)  
[enum 0100](#)  
[enum 0102](#)  
[enum 0103](#)  
[enum 0104](#)  
[enum 0105](#)  
[enum 0106](#)  
[enum 0107](#)  
[enum 0110](#)  
[enum 0111](#)  
[enum 0112](#)  
[enum 0113](#)  
[enum 0114](#)  
[enum 0116](#)  
[enum 0118](#)  
[enum 0120](#)  
[enum 0121](#)  
[enum 0122](#)  
[enum 0123](#)  
[enum 0124](#)  
[enum 0126](#)  
[enum 0128](#)  
[enum 0130](#)  
[enum 0131](#)  
[enum 0190](#)  
[enum 0191](#)  
[enum 0200](#)  
[enum 0202](#)  
[enum 0204](#)  
[enum 0206](#)  
[enum 0210](#)  
[enum 0211](#)  
[enum 0212](#)  
[enum 0220](#)  
[enum 0222](#)  
[enum 0230](#)  
[enum 0252](#)  
[enum 0254](#)  
[enum 0256](#)  
[enum 0262](#)  
[enum 0264](#)  
[enum 0266](#)  
[enum 0270](#)  
[enum 0271](#)  
[enum 0290](#)  
[enum 0291](#)  
[enum 0300](#)  
[enum 0302](#)  
[enum 0318](#)  
[enum 0320](#)  
[enum 0322](#)  
[enum 0324](#)  
[enum 0330](#)  
[enum 0338](#)  
[enum 0339](#)

[enum 0341](#)  
[enum 0342](#)  
[enum 0343](#)  
[enum 0346](#)  
[enum 0347](#)  
[enum 0348](#)  
[enum 0350](#)  
[enum 0351](#)  
[enum 0352](#)  
[enum 0353](#)  
[enum 0354](#)  
[enum 0357](#)  
[enum 0358](#)  
[enum 0359](#)  
[enum 0360](#)  
[enum 0361](#)  
[enum 0362](#)  
[enum 0363](#)  
[enum 0364](#)  
[enum 0365](#)  
[enum 0366](#)  
[enum 0367](#)  
[enum 0368](#)  
[enum 0369](#)  
[enum 0370](#)  
[enum 0371](#)  
[enum 0372](#)  
[enum 0373](#)  
[enum 0374](#)  
[enum 0375](#)  
[enum 0376](#)  
[enum 0377](#)  
[enum 0378](#)  
[enum 0379](#)  
[enum 0380](#)  
[enum 0381](#)  
[enum 0382](#)  
[enum 0383](#)  
[enum 0384](#)  
[enum 0385](#)  
[enum 0388](#)  
[enum 0389](#)  
[enum 0390](#)  
[enum 0398](#)  
[enum 0399](#)

schema location: <http://xml.ir-d.de/rst/schema/verbindlich/V3.1.2/Bausteine/PatientenaufnahmeBasis.xsd>  
attributeFormDefault:  
elementFormDefault: **unqualified**  
targetNamespace: **http://xml.ir-d.de/emg**

Complex types  
[PatientenaufnahmeBasis](#)

schema location: <http://xml.ir-d.de/rst/schema/verbindlich/V3.1.2/Bausteine/PatientenaufnahmeBrustimplantatBasis.xsd>  
attributeFormDefault:  
elementFormDefault: **unqualified**

targetNamespace: <http://xml.ir-d.de/emg>

Complex types

[PatientenaufnahmeBrustimplantatBasis](#)

schema location: <http://xml.ir-d.de/rst/schema/verbindlich/V3.1.2/Bausteine/PatientenaufnahmeKardiologie.xsd>

attributeFormDefault:

elementFormDefault: **unqualified**

targetNamespace: <http://xml.ir-d.de/emg>

Complex types

[PatientenaufnahmeKardiologie](#)

schema location: <http://xml.ir-d.de/rst/schema/verbindlich/V3.1.2/Bausteine/OperationBasis.xsd>

attributeFormDefault:

elementFormDefault: **unqualified**

targetNamespace: <http://xml.ir-d.de/emg>

Complex types

[OperationBasis](#)

schema location: <http://xml.ir-d.de/rst/schema/verbindlich/V3.1.2/Bausteine/OperationBrustimplantat.xsd>

attributeFormDefault:

elementFormDefault: **unqualified**

targetNamespace: <http://xml.ir-d.de/emg>

Complex types

[OperationBrustimplantat](#)

schema location: <http://xml.ir-d.de/rst/schema/verbindlich/V3.1.2/Bausteine/OperationEndoprothese.xsd>

attributeFormDefault:

elementFormDefault: **unqualified**

targetNamespace: <http://xml.ir-d.de/emg>

Complex types

[OperationEndoprothese](#)

schema location: <http://xml.ir-d.de/rst/schema/verbindlich/V3.1.2/Bausteine/OperationAortenklappe.xsd>

attributeFormDefault:

elementFormDefault: **unqualified**



targetNamespace: **<http://xml.ir-d.de/emg>**

Complex types

**[OperationAortenklappe](#)**

schema location: **<http://xml.ir-d.de/rst/schema/verbindlich/V3.1.2/Bausteine/Artikelidentifikation.xsd>**

attributeFormDefault:

elementFormDefault:

**unqualified**

targetNamespace: **<http://xml.ir-d.de/emg>**

Complex types

**[Artikelidentifikation](#)**

schema location: **<http://xml.ir-d.de/rst/schema/verbindlich/V3.1.2/Bausteine/Zubehoer.xsd>**

attributeFormDefault:

elementFormDefault:

**unqualified**

targetNamespace: **<http://xml.ir-d.de/emg>**

Complex types

**[Zubehoer](#)**

schema location: **<http://xml.ir-d.de/rst/schema/verbindlich/V3.1.2/Bausteine/EntlassungBasis.xsd>**

attributeFormDefault:

elementFormDefault:

**unqualified**

targetNamespace: **<http://xml.ir-d.de/emg>**

Complex types

**[EntlassungBasis](#)**

schema location: **<http://xml.ir-d.de/rst/schema/verbindlich/V3.1.2/Bausteine/DiagnoseBrustimplantatBasis.xsd>**

attributeFormDefault:

elementFormDefault:

**unqualified**

targetNamespace: **<http://xml.ir-d.de/emg>**

Complex types

**[DiagnoseBrustimplantatBasis](#)**

schema location: **<http://xml.ir-d.de/rst/schema/verbindlich/V3.1.2/Bausteine/DiagnoseEndoprotheseBasis.xsd>**

attributeFormDefault:

elementFormDefault:

**unqualified**

targetNamespace: **<http://xml.ir-d.de/emg>**

Complex types

**[DiagnoseEndoprotheseBasis](#)**

schema location: **<http://xml.ir-d.de/rst/schema/verbindlich/V3.1.2/Bausteine/DiagnoseAortenklappeBasis.xsd>**

attributeFormDefault:

elementFormDefault: **unqualified**

targetNamespace: **<http://xml.ir-d.de/emg>**

Complex types

**[DiagnoseAortenklappeBasis](#)**

schema location: **<http://xml.ir-d.de/rst/schema/verbindlich/V3.1.2/Bausteine/PostoperationAortenklappeBasis.xsd>**

attributeFormDefault:

elementFormDefault: **unqualified**

targetNamespace: **<http://xml.ir-d.de/emg>**

Complex types

**[PostoperationAortenklappeBasis](#)**

schema location: **<http://xml.ir-d.de/rst/schema/verbindlich/V3.1.2/Bausteine/AntikoagulansAortenklappeBasis.xsd>**

attributeFormDefault:

elementFormDefault: **unqualified**

targetNamespace: **<http://xml.ir-d.de/emg>**

Complex types

**[AntikoagulansAortenklappeBasis](#)**

schema location: **<http://xml.ir-d.de/rst/schema/verbindlich/V3.1.2/Bausteine/PatientenaufnahmeKardiologieBasis.xsd>**

attributeFormDefault:

elementFormDefault: **unqualified**

targetNamespace: **<http://xml.ir-d.de/emg>**

Complex types

**[PatientenaufnahmeKardiologieBasis](#)**

schema location: **<http://xml.ir-d.de/rst/schema/verbindlich/V3.1.2/Bausteine/PatientenaufnahmeAortenklappe.xsd>**

attributeFormDefault:

elementFormDefault: **unqualified**

targetNamespace: <http://xml.ir-d.de/emg>

Complex types

[PatientenaufnahmeAortenklappe](#)

schema location: <http://xml.ir-d.de/rst/schema/verbindlich/V3.1.2/Bausteine/OperationBrustimplantatBasis.xsd>

attributeFormDefault:

elementFormDefault: **unqualified**

targetNamespace: <http://xml.ir-d.de/emg>

Complex types

[OperationBrustimplantatBasis](#)

schema location: <http://xml.ir-d.de/rst/schema/verbindlich/V3.1.2/Bausteine/VorbehandlungBrustimplantatBasis.xsd>

attributeFormDefault:

elementFormDefault: **unqualified**

targetNamespace: <http://xml.ir-d.de/emg>

Complex types

[VorbehandlungBrustimplantatBasis](#)

schema location: <http://xml.ir-d.de/rst/schema/verbindlich/V3.1.2/Bausteine/MassnahmeBrustimplantatBasis.xsd>

attributeFormDefault:

elementFormDefault: **unqualified**

targetNamespace: <http://xml.ir-d.de/emg>

Complex types

[MassnahmeBrustimplantatBasis](#)

schema location: <http://xml.ir-d.de/rst/schema/verbindlich/V3.1.2/Bausteine/OperationsdetailBrustimplantatBasis.xsd>

attributeFormDefault:

elementFormDefault: **unqualified**

targetNamespace: <http://xml.ir-d.de/emg>

Complex types

[OperationsdetailBrustimplantatBasis](#)

schema location: <http://xml.ir-d.de/rst/schema/verbindlich/V3.1.2/Bausteine/BefundBrustimplantatBasis.xsd>

attributeFormDefault:

elementFormDefault: **unqualified**

targetNamespace: **<http://xml.ir-d.de/emg>**

Complex types

**[BefundBrustimplantatBasis](#)**

schema location: **<http://xml.ir-d.de/rst/schema/verbindlich/V3.1.2/Bausteine/ProzedurenSchluesselBrustimplantatBasis.xsd>**

attributeFormDefault

:

elementFormDefault: **unqualified**

targetNamespace: **<http://xml.ir-d.de/emg>**

Complex types

**[ProzedurenSchluesselBrustimplantatBasis](#)**

schema location: **<http://xml.ir-d.de/rst/schema/verbindlich/V3.1.2/Bausteine/OperationEndoprotheseBasis.xsd>**

attributeFormDefault:

elementFormDefault: **unqualified**

targetNamespace: **<http://xml.ir-d.de/emg>**

Complex types

**[OperationEndoprotheseBasis](#)**

schema location: **<http://xml.ir-d.de/rst/schema/verbindlich/V3.1.2/Bausteine/VorbehandlungEndoprotheseBasis.xsd>**

attributeFormDefault:

elementFormDefault: **unqualified**

targetNamespace: **<http://xml.ir-d.de/emg>**

Complex types

**[VorbehandlungEndoprotheseBasis](#)**

schema location: **<http://xml.ir-d.de/rst/schema/verbindlich/V3.1.2/Bausteine/ProzedurenSchluesselEndoprotheseBasis.xsd>**

attributeFormDefault

:

elementFormDefault: **unqualified**

targetNamespace: **<http://xml.ir-d.de/emg>**

Complex types

**[ProzedurenSchluesselEndoprotheseBasis](#)**

schema location: <http://xml.ir-d.de/rst/schema/verbindlich/V3.1.2/Bausteine/OperationAortenklappeBasis.xsd>  
attributeFormDefault:  
elementFormDefault: **unqualified**  
targetNamespace: **http://xml.ir-d.de/emg**

Complex types  
[OperationAortenklappeBasis](#)

schema location: <http://xml.ir-d.de/rst/schema/verbindlich/V3.1.2/Bausteine/TaviAortenklappeBasis.xsd>  
attributeFormDefault:  
elementFormDefault: **unqualified**  
targetNamespace: **http://xml.ir-d.de/emg**

Complex types  
[TaviAortenklappeBasis](#)

schema location: <http://xml.ir-d.de/rst/schema/verbindlich/V3.1.2/Bausteine/ProzedurenSchluesselAortenklappeBasis.xsd>  
attributeFormDefault:  
:  
elementFormDefault: **unqualified**  
targetNamespace: **http://xml.ir-d.de/emg**

Complex types  
[ProzedurenSchluesselAortenklappeBasis](#)

schema location: <http://xml.ir-d.de/rst/schema/verbindlich/V3.1.2/Bausteine/FailureGrundAortenklappeBasis.xsd>  
attributeFormDefault:  
elementFormDefault: **unqualified**  
targetNamespace: **http://xml.ir-d.de/emg**

Complex types  
[FailureGrundAortenklappeBasis](#)

schema location: <http://xml.ir-d.de/rst/schema/verbindlich/V3.1.2/Bausteine/PciAortenklappeBasis.xsd>  
attributeFormDefault:  
elementFormDefault: **unqualified**  
targetNamespace: **http://xml.ir-d.de/emg**

Complex types  
[PciAortenklappeBasis](#)

schema location: <http://xml.ir-d.de/rst/schema/verbindlich/V3.1.2/Bausteine/KomplikationAortenklappeBasis.xsd>  
attributeFormDefault:  
elementFormDefault: **unqualified**  
targetNamespace: **http://xml.ir-d.de/emg**

Complex types  
[KomplikationAortenklappeBasis](#)

schema location: <http://xml.ir-d.de/rst/schema/verbindlich/V3.1.2/Bausteine/ArtikelidentifikationBasis.xsd>  
attributeFormDefault:  
elementFormDefault: **unqualified**  
targetNamespace: **http://xml.ir-d.de/emg**

Complex types  
[ArtikelidentifikationBasis](#)

schema location: <http://xml.ir-d.de/rst/schema/verbindlich/V3.1.2/Bausteine/Artikelbeschreibung.xsd>  
attributeFormDefault:  
elementFormDefault: **unqualified**  
targetNamespace: **http://xml.ir-d.de/emg**

Complex types  
[Artikelbeschreibung](#)

schema location: <http://xml.ir-d.de/rst/schema/verbindlich/V3.1.2/Bausteine/ZubehoerBasis.xsd>  
attributeFormDefault:  
elementFormDefault: **unqualified**  
targetNamespace: **http://xml.ir-d.de/emg**

Complex types  
[ZubehoerBasis](#)

schema location: <http://xml.ir-d.de/rst/schema/verbindlich/V3.1.2/Bausteine/ZubehoerBrustimplantatBasis.xsd>  
attributeFormDefault:  
elementFormDefault: **unqualified**  
targetNamespace: **http://xml.ir-d.de/emg**

Complex types  
[ZubehoerBrustimplantatBasis](#)

schema location: <http://xml.ir-d.de/rst/schema/verbindlich/V3.1.2/Bausteine/ZubehoerEndoprotheseBasis.xsd>  
attributeFormDefault:  
elementFormDefault: **unqualified**  
targetNamespace: **http://xml.ir-d.de/emg**

Complex types  
[ZubehoerEndoprotheseBasis](#)

schema location: <http://xml.ir-d.de/rst/schema/verbindlich/V3.1.2/Bausteine/PatientenaufnahmeAortenklappeBasis.xsd>  
attributeFormDefault:  
elementFormDefault: **unqualified**  
targetNamespace: **http://xml.ir-d.de/emg**

Complex types  
[PatientenaufnahmeAortenklappeBasis](#)

schema location: <http://xml.ir-d.de/rst/schema/verbindlich/V3.1.2/Bausteine/InfektionAortenklappeBasis.xsd>  
attributeFormDefault:  
elementFormDefault: **unqualified**  
targetNamespace: **http://xml.ir-d.de/emg**

Complex types  
[InfektionAortenklappeBasis](#)

schema location: <http://xml.ir-d.de/rst/schema/verbindlich/V3.1.2/Bausteine/ArtikelbeschreibungBasis.xsd>  
attributeFormDefault:  
elementFormDefault: **unqualified**  
targetNamespace: **http://xml.ir-d.de/emg**

Complex types  
[ArtikelbeschreibungBasis](#)

schema location: <http://xml.ir-d.de/rst/schema/verbindlich/V3.1.2/Bausteine/ArtikelBrustimplantatBasis.xsd>  
attributeFormDefault:  
elementFormDefault: **unqualified**  
targetNamespace: **http://xml.ir-d.de/emg**

Complex types  
[ArtikelBrustimplantatBasis](#)

schema location: <http://xml.ir-d.de/rst/schema/verbindlich/V3.1.2/Bausteine/ArtikelEndoprotheseBasis.xsd>  
 attributeFormDefault:  
 elementFormDefault: **unqualified**  
 targetNamespace: **http://xml.ir-d.de/emg**

Complex types  
[ArtikelEndoprotheseBasis](#)

schema location: <http://xml.ir-d.de/rst/schema/verbindlich/V3.1.2/Bausteine/ArtikelAortenklappeBasis.xsd>  
 attributeFormDefault:  
 elementFormDefault: **unqualified**  
 targetNamespace: **http://xml.ir-d.de/emg**

Complex types  
[ArtikelAortenklappeBasis](#)

### element **GEMeldung**

diagram	 <p>         Meldung einer implantatbezogenen Massnahme nach § 16 IRegG. Hier: Meldung/Korrektur der Gesundheitseinrichtung an die Registerstelle. Die Meldung muss wohlgeformt und im Sinne dieses Schemas gültig sein.          ...       </p>
namespace	<a href="http://xml.ir-d.de/rst">http://xml.ir-d.de/rst</a>
type	<a href="#">emg:GeMeldung</a>
properties	content complex
children	<a href="#">meldung</a>
annotation	documentation Meldung einer implantatbezogenen Massnahme nach § 16 IRegG. Hier: Meldung/Korrektur der Gesundheitseinrichtung an die Registerstelle. Die Meldung muss wohlgeformt und im Sinne dieses Schemas gültig sein.
source	<pre> &lt;element name="GEMeldung" type="emg:GeMeldung"&gt;   &lt;annotation&gt;     &lt;documentation&gt;Meldung einer implantatbezogenen Massnahme nach § 16 IRegG. Hier: Meldung/Korrektur der Gesundheitseinrichtung an die Registerstelle. Die Meldung muss wohlgeformt und im Sinne dieses Schemas gültig sein.     &lt;/documentation&gt;   &lt;/annotation&gt; &lt;/element&gt; </pre>



element **GESelbstauskunft**

diagram	
namespace	http://xml.ir-d.de/rst
type	<a href="#">sak:Geselbstauskunft</a>
properties	content complex
children	<a href="#">meldung</a>
annotation	documentation Selbstauskunftersuchen an die Registerstelle.
source	<pre> &lt;element name="GESelbstauskunft" type="sak:Geselbstauskunft"&gt;   &lt;annotation&gt;     &lt;documentation&gt;Selbstauskunftersuchen an die Registerstelle.&lt;/documentation&gt;   &lt;/annotation&gt; &lt;/element&gt; </pre>

element **GEStorno**

diagram	
namespace	http://xml.ir-d.de/rst
type	<a href="#">stn:GeStorno</a>
properties	content complex
children	<a href="#">meldung</a>
annotation	documentation Stornierung einer Meldung mit allen evtl. erfolgten Korrekturen der Gesundheitseinrichtung an die Registerstelle.
source	<pre> &lt;element name="GEStorno" type="stn:GeStorno"&gt;   &lt;annotation&gt;     &lt;documentation&gt;Stornierung einer Meldung mit allen evtl. erfolgten Korrekturen der Gesundheitseinrichtung an die Registerstelle.&lt;/documentation&gt;   &lt;/annotation&gt; &lt;/element&gt; </pre>

### element IRDMeldungAntwort

diagram	
namespace	http://xml.ir-d.de/rst
type	<a href="#">irdma:meldungAntwort</a>
properties	content complex
children	<a href="#">meldung</a> <a href="#">empfangsbestaetigung</a> <a href="#">fehler</a> <a href="#">warnung</a> <a href="#">bestaetigung</a>
annotation	documentation Antwort der Registerstelle auf eine Meldung/Korrektur der Gesundheitseinrichtung.
source	<pre>&lt;element name="IRDMeldungAntwort" type="irdma:meldungAntwort"&gt;   &lt;annotation&gt;     &lt;documentation&gt;Antwort der Registerstelle auf eine Meldung/Korrektur der     Gesundheitseinrichtung.&lt;/documentation&gt;   &lt;/annotation&gt; &lt;/element&gt;</pre>

### element IRDSelbstauskunftAntwort

diagram	
namespace	http://xml.ir-d.de/rst
type	<a href="#">irdsaa:selbstauskunftAntwort</a>
properties	content complex
children	<a href="#">meldung</a> <a href="#">empfangsbestaetigung</a>
annotation	documentation Antwort der Registerstelle auf ein Selbstauskunftersuchen der Gesundheitseinrichtung.
source	<pre>&lt;element name="IRDSelbstauskunftAntwort" type="irdsaa:selbstauskunftAntwort"&gt;</pre>

```

<annotation>
  <documentation>Antwort der Registerstelle auf ein Selbstauskunftersuchen
der Gesundheitseinrichtung.</documentation>
</annotation>
</element>

```

### element IRDStornoAntwort

diagram	
namespace	http://xml.ir-d.de/rst
type	<a href="#">irdsa:stornoAntwort</a>
properties	content complex
children	<a href="#">meldung</a> <a href="#">empfangsbestaetigung</a> <a href="#">fehler</a>
annotation	documentation Antwort der Registerstelle auf ein Storno einer Meldung mit allen evtl. erfolgten Korrekturen der Gesundheitseinrichtung.
source	<pre> &lt;element name="IRDStornoAntwort" type="irdsa:stornoAntwort"&gt;   &lt;annotation&gt;     &lt;documentation&gt;Antwort der Registerstelle auf ein Storno einer Meldung mit allen evtl. erfolgten Korrekturen der Gesundheitseinrichtung.&lt;/documentation&gt;   &lt;/annotation&gt; &lt;/element&gt; </pre>

### complexType GeMeldung

diagram	
namespace	http://xml.ir-d.de/emg
children	<a href="#">meldung</a>
used by	element <a href="#">GEMeldung</a>
source	<pre> &lt;complexType name="GeMeldung"&gt;   &lt;sequence&gt;     &lt;element name="meldung" type="emg:Meldung"/&gt;   &lt;/sequence&gt; &lt;/complexType&gt; </pre>

### element **GeMeldung/meldung**

diagram	
type	<a href="#">Meldung</a>
properties	content complex
children	<a href="#">MEL_IrdIdGesundheitseinrichtung</a> <a href="#">MEL_StandortId</a> <a href="#">MEL_Bsnr</a> <a href="#">MEL_IrdSpezVersion</a> <a href="#">MEL_SwName</a> <a href="#">MEL_SwHersteller</a> <a href="#">MEL_SwVersion</a> <a href="#">fall</a>
source	<code>&lt;element name="meldung" type="emg:Meldung"/&gt;</code>

### complexType **GeStorno**

diagram	
namespace	http://xml.ir-d.de/stn
children	<a href="#">meldung</a>
used by	element <a href="#">GeStorno</a>
source	<pre> &lt;complexType name="GeStorno"&gt;   &lt;sequence&gt;     &lt;element name="meldung" type="stn:Storno"/&gt;   &lt;/sequence&gt; &lt;/complexType&gt; </pre>

element **GeStorno/meldung**

diagram	
type	<a href="#">Storno</a>
properties	content complex
children	<a href="#">MEL_IrdIdGesundheitseinrichtung</a> <a href="#">fall</a>
source	<code>&lt;element name="meldung" type="stn:Storno"/&gt;</code>

complexType **meldungAntwort**

diagram	
namespace	http://xml.ir-d.de/irdma
children	<a href="#">meldung</a> <a href="#">empfangsbestaetigung</a> <a href="#">fehler</a> <a href="#">warnung</a> <a href="#">bestaetigung</a>
used by	element <a href="#">IRDMeldungAntwort</a>
source	<pre> &lt;complexType name="meldungAntwort"&gt;   &lt;sequence&gt;     &lt;element name="meldung" type="irdma:MeldungIrd"/&gt;     &lt;element name="empfangsbestaetigung" type="irdma:EmpfangsbestaetigungBasis"/&gt;     &lt;choice&gt;       &lt;element name="fehler" type="irdma:HinweisBasis" maxOccurs="unbounded"/&gt;       &lt;element name="warnung" type="irdma:Warnung"/&gt;       &lt;element name="bestaetigung" type="irdma:BestaetigungBasis"/&gt;     &lt;/choice&gt;   &lt;/sequence&gt; &lt;/complexType&gt; </pre>

element **meldungAntwort/meldung**

diagram	
type	<a href="#">MeldungIrd</a>
properties	content complex
children	<a href="#">MEL_IrdIdGesundheitseinrichtung</a> <a href="#">fall</a>
source	<code>&lt;element name="meldung" type="irdma:MeldungIrd"/&gt;</code>

element **meldungAntwort/empfangsbestaetigung**

diagram	
type	<a href="#">EmpfangsbestaetigungBasis</a>
properties	content complex
children	<a href="#">EBG_Empfangsbestaetigung</a> <a href="#">EBG_DatumZeitEmpfang</a>
source	<code>&lt;element name="empfangsbestaetigung" type="irdma:EmpfangsbestaetigungBasis"/&gt;</code>

element **meldungAntwort/fehler**

diagram	
type	<a href="#">HinweisBasis</a>
properties	minOcc 1 maxOcc unbounded content complex
children	<a href="#">HNW_Datenelement</a> <a href="#">HNW_Meldung</a> <a href="#">HNW_Wert</a>
source	<code>&lt;element name="fehler" type="irdma:HinweisBasis" maxOccurs="unbounded"/&gt;</code>

element **meldungAntwort/warnung**

diagram	
type	<a href="#">Warnung</a>
properties	content complex
children	<a href="#">bestaetigung</a> <a href="#">hinweis</a>
source	<code>&lt;element name="warnung" type="irdma:Warnung"/&gt;</code>

element **meldungAntwort/bestaetigung**

diagram	
type	<a href="#">BestaetigungBasis</a>
properties	content complex
children	<a href="#">BEG Meldebestaetigung ID</a> <a href="#">BEG DatumZeitMeldebestaetigung</a> <a href="#">BEG AusloesendeOpsListe</a> <a href="#">BEG Produktzuordnung</a> <a href="#">BEG Hash String</a> <a href="#">BEG Hash Wert</a>
source	<code>&lt;element name="bestaetigung" type="irdma:BestaetigungBasis"/&gt;</code>

complexType **stornoAntwort**

diagram	
namespace	http://xml.ir-d.de/irdsa
children	<a href="#">meldung</a> <a href="#">empfangsbestaetigung</a> <a href="#">fehler</a>
used by	element <a href="#">IRDStornoAntwort</a>
source	<pre> &lt;complexType name="stornoAntwort"&gt;   &lt;sequence&gt;     &lt;element name="meldung" type="irdsa:Storno"/&gt;     &lt;element name="empfangsbestaetigung" type="irdsa:EmpfangsbestaetigungBasis"/&gt;     &lt;element name="fehler" type="irdsa:HinweisBasis" minOccurs="0" </pre>



```

maxOccurs="unbounded"/>
</sequence>
</complexType>

```

### element **stornoAntwort/meldung**

diagram	
type	<b>Storno</b>
properties	content complex
children	<a href="#">MEL_IrdIdGesundheitseinrichtung</a> <a href="#">fall</a>
source	<code>&lt;element name="meldung" type="irdsa:Storno"/&gt;</code>

### element **stornoAntwort/empfangsbestaetigung**

diagram	
type	<b>EmpfangsbestaetigungBasis</b>
properties	content complex
children	<a href="#">EBG_Empfangsbestaetigung</a> <a href="#">EBG_DatumZeitEmpfang</a>
source	<code>&lt;element name="empfangsbestaetigung" type="irdsa:EmpfangsbestaetigungBasis"/&gt;</code>

### element **stornoAntwort/fehler**

diagram	
type	<a href="#">HinweisBasis</a>
properties	minOcc 0 maxOcc unbounded content complex
children	<a href="#">HNW_Datenelement</a> <a href="#">HNW_Meldung</a> <a href="#">HNW_Wert</a>
source	<pre>&lt;element name="fehler" type="irdsa:HinweisBasis" minOccurs="0" maxOccurs="unbounded"/&gt;</pre>

### complexType **GeSelbstauskunft**

diagram	
namespace	http://xml.ir-d.de/sak
children	<a href="#">meldung</a>
used by	element <a href="#">GESelbstauskunft</a>
source	<pre>&lt;complexType name="GeSelbstauskunft"&gt;   &lt;sequence&gt;     &lt;element name="meldung" type="sak:Selbstauskunft"/&gt;   &lt;/sequence&gt; &lt;/complexType&gt;</pre>

### element **GeSelbstauskunft/meldung**

diagram	
type	<a href="#">Selbstauskunft</a>

properties	content complex
children	<a href="#">MEL_IrdIdGesundheitseinrichtung</a> <a href="#">fall</a>
source	<code>&lt;element name="meldung" type="sak:Selbstauskunft"/&gt;</code>

### complexType **selbstauskunftAntwort**

diagram	
namespace	http://xml.ir-d.de/irdsaa
children	<a href="#">meldung</a> <a href="#">empfangsbestaetigung</a>
used by	element <a href="#">IRDSelbstauskunftAntwort</a>
source	<pre>&lt;complexType name="selbstauskunftAntwort"&gt;   &lt;sequence&gt;     &lt;element name="meldung" type="irdsaa:Selbstauskunft"/&gt;     &lt;element name="empfangsbestaetigung"       type="irdsaa:EmpfangsbestaetigungBasis"/&gt;   &lt;/sequence&gt; &lt;/complexType&gt;</pre>

### element **selbstauskunftAntwort/meldung**

diagram	
type	<a href="#">Selbstauskunft</a>
properties	content complex
children	<a href="#">MEL_IrdIdGesundheitseinrichtung</a> <a href="#">fall</a>
source	<code>&lt;element name="meldung" type="irdsaa:Selbstauskunft"/&gt;</code>

element **selbstauskunftAntwort/empfangsbestaetigung**

diagram	
type	<a href="#">EmpfangsbestaetigungBasis</a>
properties	content complex
children	<a href="#">EBG_Empfangsbestaetigung</a> <a href="#">EBG_DatumZeitEmpfang</a>
source	<code>&lt;element name="empfangsbestaetigung" type="irdsaa:EmpfangsbestaetigungBasis"/&gt;</code>

complexType **Meldung**

diagram	
namespace	http://xml.ir-d.de/emg
type	extension of <a href="#">MeldungBasis</a>

properties	base MeldungBasis
children	<a href="#">MEL IrdIdGesundheitseinrichtung</a> <a href="#">MEL StandortId</a> <a href="#">MEL Bsnr</a> <a href="#">MEL IrdSpezVersion</a> <a href="#">MEL SwName</a> <a href="#">MEL SwHersteller</a> <a href="#">MEL SwVersion</a> <a href="#">fall</a>
used by	element <a href="#">GeMeldung/meldung</a>
source	<pre> &lt;complexType name="Meldung"&gt;   &lt;complexContent&gt;     &lt;extension base="MeldungBasis"&gt;       &lt;sequence&gt;         &lt;element name="fall" type="Fall"/&gt;       &lt;/sequence&gt;     &lt;/extension&gt;   &lt;/complexContent&gt; &lt;/complexType&gt; </pre>

element **Meldung/fall**

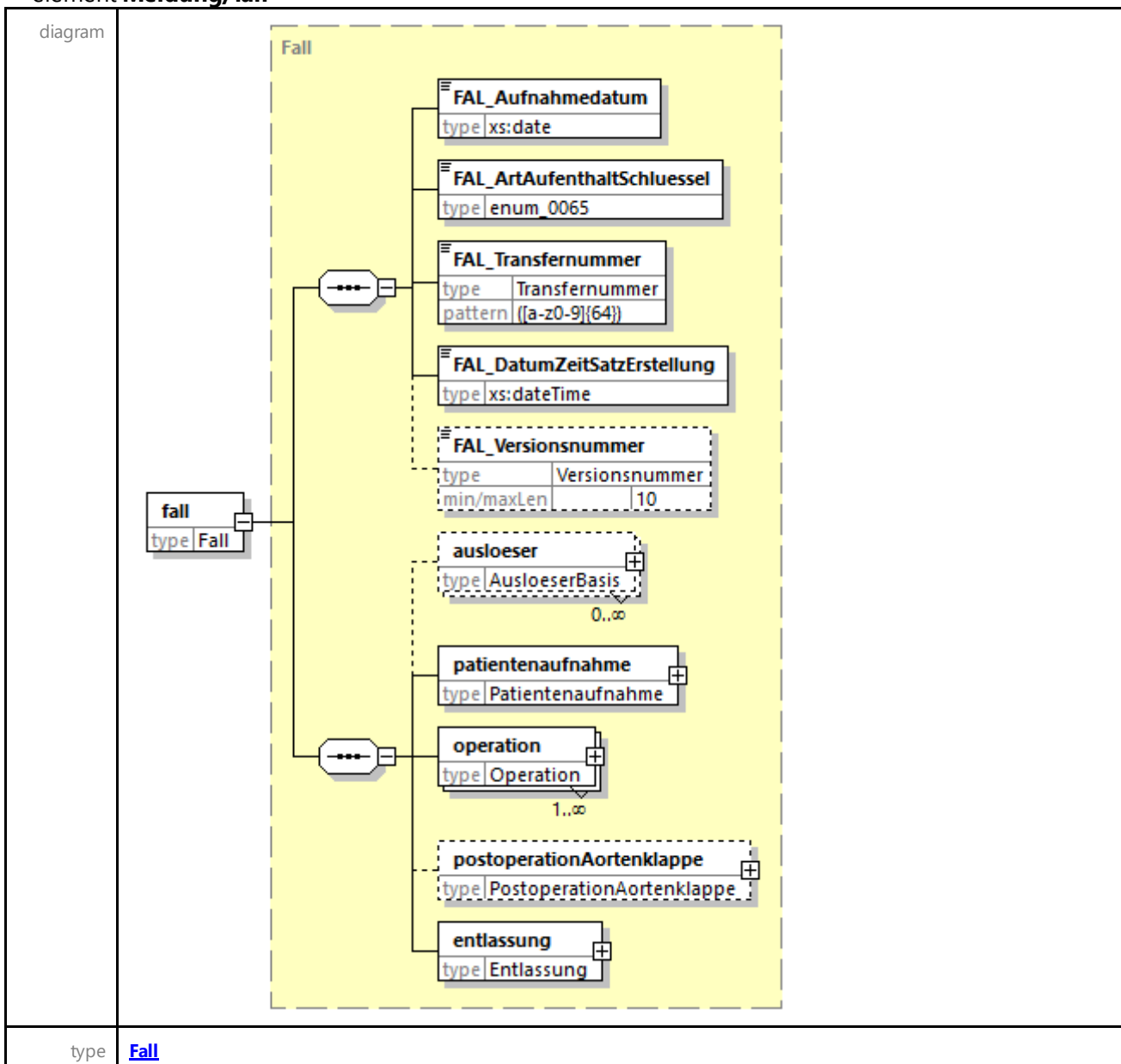

properties	content complex
children	<a href="#">FAL_Aufnahmedatum</a> <a href="#">FAL_ArtAufenthaltSchluessel</a> <a href="#">FAL_Transfernummer</a> <a href="#">FAL_DatumZeitSatzErstellung</a> <a href="#">FAL_Versionsnummer</a> <a href="#">ausloeser</a> <a href="#">patientenaufnahme</a> <a href="#">operation</a> <a href="#">postoperationAortenklappe</a> <a href="#">entlassung</a>
source	<code>&lt;element name="fall" type="Fall"/&gt;</code>

### complexType **Storno**

diagram	
namespace	http://xml.ir-d.de/stn
type	extension of <a href="#">MeldungIrdBasis</a>
properties	base MeldungIrdBasis
children	<a href="#">MEL_IrdIdGesundheitseinrichtung</a> <a href="#">fall</a>
used by	element <a href="#">GeStorno/meldung</a>
source	<pre> &lt;complexType name="Storno"&gt;   &lt;complexContent&gt;     &lt;extension base="MeldungIrdBasis"&gt;       &lt;sequence&gt;         &lt;element name="fall" type="StornoFallBasis"/&gt;       &lt;/sequence&gt;     &lt;/extension&gt;   &lt;/complexContent&gt; &lt;/complexType&gt; </pre>

### element **Storno/fall**

diagram	
type	<a href="#">StornoFallBasis</a>
properties	content complex
children	<a href="#">FAL_Transfernummer</a> <a href="#">FAL_Aufnahmedatum</a>
source	<code>&lt;element name="fall" type="StornoFallBasis"/&gt;</code>

## complexType MeldungIrd

diagram	
namespace	http://xml.ir-d.de/irdma
type	extension of <a href="#">MeldungIrdBasis</a>
properties	base MeldungIrdBasis
children	<a href="#">MEL_IrdIdGesundheitseinrichtung</a> <a href="#">fall</a>
used by	element <a href="#">meldungAntwort/meldung</a>
source	<pre> &lt;complexType name="MeldungIrd"&gt;   &lt;complexContent&gt;     &lt;extension base="MeldungIrdBasis"&gt;       &lt;sequence&gt;         &lt;element name="fall" type="MeldungIrdFallBasis"/&gt;       &lt;/sequence&gt;     &lt;/extension&gt;   &lt;/complexContent&gt; &lt;/complexType&gt; </pre>

## element MeldungIrd/fall

diagram	
type	<a href="#">MeldungIrdFallBasis</a>
properties	content complex
children	<a href="#">FAL_Transfernummer</a> <a href="#">FAL_DatumZeitSatzErstellung</a>
source	<pre> &lt;element name="fall" type="MeldungIrdFallBasis"/&gt; </pre>

### complexType **EmpfangsbestaetigungBasis**

diagram	
namespace	http://xml.ir-d.de/irdma
children	<a href="#">EBG Empfangsbestaetigung</a> <a href="#">EBG DatumZeitEmpfang</a>
used by	element <a href="#">meldungAntwort/empfangsbestaetigung</a>
source	<pre>&lt;complexType name="EmpfangsbestaetigungBasis"&gt;   &lt;sequence&gt;     &lt;element name="EBG_Empfangsbestaetigung" type="Freitext250" fixed="Hiermit wird der Eingang Ihrer Anfrage bestätigt"/&gt;     &lt;element name="EBG_DatumZeitEmpfang" type="xs:dateTime"/&gt;   &lt;/sequence&gt; &lt;/complexType&gt;</pre>

### element **EmpfangsbestaetigungBasis/EBG\_Empfangsbestaetigung**

diagram							
type	<a href="#">Freitext250</a>						
properties	content simple fixed Hiermit wird der Eingang Ihrer Anfrage bestätigt						
facets	<table border="1"> <thead> <tr> <th>Kind</th> <th>Value</th> <th>Annotation</th> </tr> </thead> <tbody> <tr> <td>maxLength</td> <td>250</td> <td></td> </tr> </tbody> </table>	Kind	Value	Annotation	maxLength	250	
Kind	Value	Annotation					
maxLength	250						
source	<pre>&lt;element name="EBG_Empfangsbestaetigung" type="Freitext250" fixed="Hiermit wird der Eingang Ihrer Anfrage bestätigt"/&gt;</pre>						

### element **EmpfangsbestaetigungBasis/EBG\_DatumZeitEmpfang**

diagram	
type	<b>dateTime</b>
properties	content simple
source	<pre>&lt;element name="EBG_DatumZeitEmpfang" type="xs:dateTime"/&gt;</pre>



## complexType **HinweisBasis**

diagram	
namespace	http://xml.ir-d.de/irdma
children	<a href="#">HNW_Datenelement</a> <a href="#">HNW Meldung</a> <a href="#">HNW Wert</a>
used by	elements <a href="#">meldungAntwort/fehler</a> <a href="#">Warnung/hinweis</a>
source	<pre>&lt;complexType name="HinweisBasis"&gt;   &lt;sequence&gt;     &lt;element name="HNW_Datenelement" type="Freitext500"/&gt;     &lt;element name="HNW_Meldung" type="Freitext500"/&gt;     &lt;element name="HNW_Wert" type="Freitext500"/&gt;   &lt;/sequence&gt; &lt;/complexType&gt;</pre>

## element **HinweisBasis/HNW\_Datenelement**

diagram							
type	<a href="#">Freitext500</a>						
properties	content simple						
facets	<table border="1"> <thead> <tr> <th>Kind</th> <th>Value</th> <th>Annotation</th> </tr> </thead> <tbody> <tr> <td>maxLength</td> <td>500</td> <td></td> </tr> </tbody> </table>	Kind	Value	Annotation	maxLength	500	
Kind	Value	Annotation					
maxLength	500						
source	<pre>&lt;element name="HNW_Datenelement" type="Freitext500"/&gt;</pre>						

## element **HinweisBasis/HNW\_Meldung**

diagram							
type	<a href="#">Freitext500</a>						
properties	content simple						
facets	<table border="1"> <thead> <tr> <th>Kind</th> <th>Value</th> <th>Annotation</th> </tr> </thead> <tbody> <tr> <td>maxLength</td> <td>500</td> <td></td> </tr> </tbody> </table>	Kind	Value	Annotation	maxLength	500	
Kind	Value	Annotation					
maxLength	500						
source	<pre>&lt;element name="HNW_Meldung" type="Freitext500"/&gt;</pre>						

### element **HinweisBasis/HNW\_Wert**

diagram							
type	<a href="#">Freitext500</a>						
properties	content simple						
facets	<table border="1"> <tr> <td>Kind</td> <td>Value</td> <td>Annotation</td> </tr> <tr> <td>maxLength</td> <td>500</td> <td></td> </tr> </table>	Kind	Value	Annotation	maxLength	500	
Kind	Value	Annotation					
maxLength	500						
source	<code>&lt;element name="HNW_Wert" type="Freitext500"/&gt;</code>						

### complexType **Warnung**

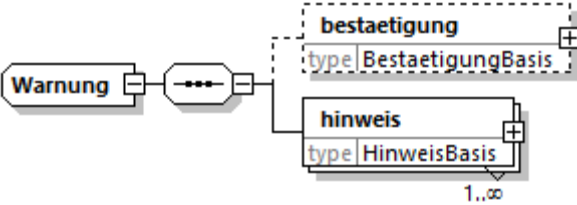
diagram	
namespace	http://xml.ir-d.de/irdma
children	<a href="#">bestaetigung</a> <a href="#">hinweis</a>
used by	element <a href="#">meldungAntwort/warnung</a>
source	<pre> &lt;complexType name="Warnung"&gt;   &lt;sequence&gt;     &lt;element name="bestaetigung" type="BestaetigungBasis" minOccurs="0"/&gt;     &lt;element name="hinweis" type="HinweisBasis" maxOccurs="unbounded"/&gt;   &lt;/sequence&gt; &lt;/complexType&gt; </pre>

element **Warnung/bestaetigung**

diagram	
type	<a href="#">BestaetigungBasis</a>
properties	minOcc 0 maxOcc 1 content complex
children	<a href="#">BEG Meldebestaetigung ID</a> <a href="#">BEG DatumZeitMeldebestaetigung</a> <a href="#">BEG AusloesendeOpsListe</a> <a href="#">BEG Produktzuordnung</a> <a href="#">BEG Hash String</a> <a href="#">BEG Hash Wert</a>
source	<code>&lt;element name="bestaetigung" type="BestaetigungBasis" minOccurs="0"/&gt;</code>

element **Warnung/hinweis**

diagram	
type	<a href="#">HinweisBasis</a>
properties	minOcc 1 maxOcc unbounded content complex

children	<a href="#">HNW Datenelement</a> <a href="#">HNW Meldung</a> <a href="#">HNW Wert</a>
source	<code>&lt;element name="hinweis" type="HinweisBasis" maxOccurs="unbounded"/&gt;</code>

### complexType **BestaetigungBasis**

diagram	
namespace	http://xml.ir-d.de/irdma
children	<a href="#">BEG Meldebestaetigung ID</a> <a href="#">BEG DatumZeitMeldebestaetigung</a> <a href="#">BEG AusloesendeOpsListe</a> <a href="#">BEG Produktzuordnung</a> <a href="#">BEG Hash String</a> <a href="#">BEG Hash Wert</a>
used by	elements <a href="#">meldungAntwort/bestaetigung</a> <a href="#">Warnung/bestaetigung</a>
source	<pre> &lt;complexType name="BestaetigungBasis"&gt;   &lt;sequence&gt;     &lt;element name="BEG_Meldebestaetigung_ID" type="Meldebestaetigung"/&gt;     &lt;element name="BEG_DatumZeitMeldebestaetigung" type="xs:dateTime"/&gt;     &lt;element name="BEG_AusloesendeOpsListe" type="Freitext250" minOccurs="0"/&gt;     &lt;element name="BEG_Produktzuordnung" type="xs:boolean"/&gt;     &lt;element name="BEG_Hash_String" type="HashString"/&gt;     &lt;element name="BEG_Hash_Wert" type="HashWert"/&gt;   &lt;/sequence&gt; &lt;/complexType&gt; </pre>

### element **BestaetigungBasis/BEG\_Meldebestaetigung\_ID**

diagram	
type	<a href="#">Meldebestaetigung</a>
properties	content simple
facets	Kind Value Annotation length 10

source	<code>&lt;element name="BEG_Meldebestaetigung_ID" type="Meldebestaetigung"/&gt;</code>
--------	--

element **BestaetigungBasis/BEG\_DatumZeitMeldebestaetigung**

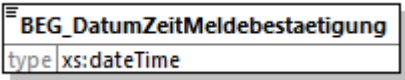
diagram	
type	<b>dateTime</b>
properties	content simple
source	<code>&lt;element name="BEG_DatumZeitMeldebestaetigung" type="xs:dateTime"/&gt;</code>

element **BestaetigungBasis/BEG\_AusloesendeOpsListe**

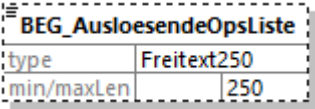
diagram							
type	<a href="#">Freitext250</a>						
properties	minOcc 0 maxOcc 1 content simple						
facets	<table border="1"> <thead> <tr> <th>Kind</th> <th>Value</th> <th>Annotation</th> </tr> </thead> <tbody> <tr> <td>maxLength</td> <td>250</td> <td></td> </tr> </tbody> </table>	Kind	Value	Annotation	maxLength	250	
Kind	Value	Annotation					
maxLength	250						
source	<code>&lt;element name="BEG_AusloesendeOpsListe" type="Freitext250" minOccurs="0"/&gt;</code>						

element **BestaetigungBasis/BEG\_Produktzuordnung**

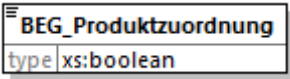
diagram	
type	<b>boolean</b>
properties	content simple
source	<code>&lt;element name="BEG_Produktzuordnung" type="xs:boolean"/&gt;</code>

element **BestaetigungBasis/BEG\_Hash\_String**

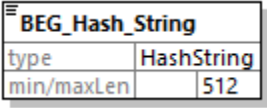
diagram							
type	<a href="#">HashString</a>						
properties	content simple						
facets	<table border="1"> <thead> <tr> <th>Kind</th> <th>Value</th> <th>Annotation</th> </tr> </thead> <tbody> <tr> <td>maxLength</td> <td>512</td> <td></td> </tr> </tbody> </table>	Kind	Value	Annotation	maxLength	512	
Kind	Value	Annotation					
maxLength	512						
source	<code>&lt;element name="BEG_Hash_String" type="HashString"/&gt;</code>						

### element **BestaetigungBasis/BEG\_Hash\_Wert**

diagram	
type	<a href="#">HashWert</a>
properties	content simple
facets	Kind Value Annotation length 64
source	<code>&lt;element name="BEG_Hash_Wert" type="HashWert"/&gt;</code>

### complexType **Storno**

diagram	
namespace	http://xml.ir-d.de/irdsa
type	extension of <a href="#">MeldungIrdBasis</a>
properties	base MeldungIrdBasis
children	<a href="#">MEL_IrdIdGesundheitseinrichtung</a> <a href="#">fall</a>
used by	element <a href="#">stornoAntwort/meldung</a>
source	<pre> &lt;complexType name="Storno"&gt;   &lt;complexContent&gt;     &lt;extension base="MeldungIrdBasis"&gt;       &lt;sequence&gt;         &lt;element name="fall" type="StornoFallBasis"/&gt;       &lt;/sequence&gt;     &lt;/extension&gt;   &lt;/complexContent&gt; &lt;/complexType&gt; </pre>

### element **Storno/fall**

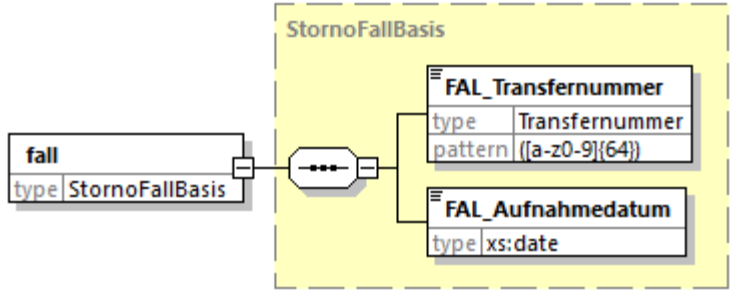
diagram	
type	<a href="#">StornoFallBasis</a>
properties	content complex
children	<a href="#">FAL Transfernummer</a> <a href="#">FAL Aufnahmedatum</a>
source	<code>&lt;element name="fall" type="StornoFallBasis"/&gt;</code>

### complexType **EmpfangsbestaetigungBasis**

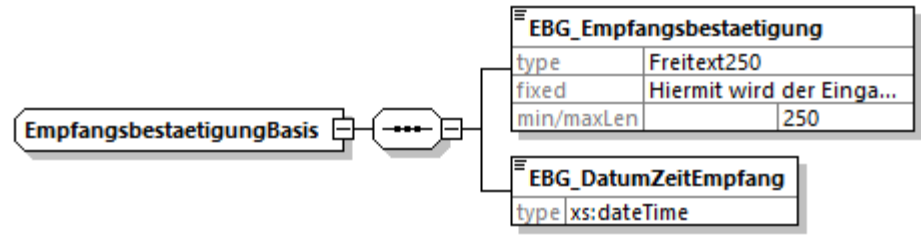
diagram	
namespace	http://xml.ir-d.de/irdsa
children	<a href="#">EBG Empfangsbestaetigung</a> <a href="#">EBG DatumZeitEmpfang</a>
used by	element <a href="#">stornoAntwort/empfangsbestaetigung</a>
source	<pre> &lt;complexType name="EmpfangsbestaetigungBasis"&gt;   &lt;sequence&gt;     &lt;element name="EBG_Empfangsbestaetigung" type="Freitext250" fixed="Hiermit wird der Eingang Ihrer Anfrage bestätigt"/&gt;     &lt;element name="EBG_DatumZeitEmpfang" type="xs:dateTime"/&gt;   &lt;/sequence&gt; &lt;/complexType&gt; </pre>

### element **EmpfangsbestaetigungBasis/EBG\_Empfangsbestaetigung**

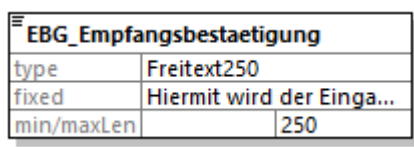
diagram							
type	<a href="#">Freitext250</a>						
properties	content simple fixed Hiermit wird der Eingang Ihrer Anfrage bestätigt						
facets	<table border="1"> <thead> <tr> <th>Kind</th> <th>Value</th> <th>Annotation</th> </tr> </thead> <tbody> <tr> <td>maxLength</td> <td>250</td> <td></td> </tr> </tbody> </table>	Kind	Value	Annotation	maxLength	250	
Kind	Value	Annotation					
maxLength	250						
source	<code>&lt;element name="EBG_Empfangsbestaetigung" type="Freitext250" fixed="Hiermit wird</code>						

der Eingang Ihrer Anfrage bestätigt"/>

#### element **EmpfangsbestaetigungBasis/EBG\_DatumZeitEmpfang**

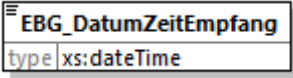
diagram	 <p>The diagram shows a box for the element <b>EBG_DatumZeitEmpfang</b> with the property <code>type xs:dateTime</code>.</p>
type	<b>dateTime</b>
properties	content simple
source	<code>&lt;element name="EBG_DatumZeitEmpfang" type="xs:dateTime"/&gt;</code>

#### complexType **HinweisBasis**

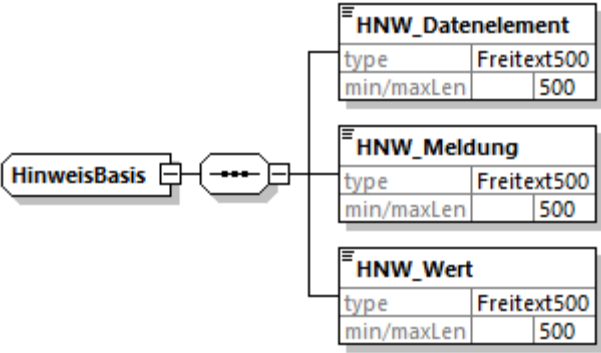
diagram	 <p>The diagram shows a complexType <b>HinweisBasis</b> containing a sequence of three elements: <b>HNW_Datenelement</b>, <b>HNW_Meldung</b>, and <b>HNW_Wert</b>. Each element has the type <code>Freitext500</code> and a <code>min/maxLen</code> of <code>500</code>.</p>
namespace	<a href="http://xml.ir-d.de/irdsa">http://xml.ir-d.de/irdsa</a>
children	<a href="#">HNW_Datenelement</a> <a href="#">HNW_Meldung</a> <a href="#">HNW_Wert</a>
used by	element <a href="#">stornoAntwort/fehler</a>
source	<pre>&lt;complexType name="HinweisBasis"&gt;   &lt;sequence&gt;     &lt;element name="HNW_Datenelement" type="Freitext500"/&gt;     &lt;element name="HNW_Meldung" type="Freitext500"/&gt;     &lt;element name="HNW_Wert" type="Freitext500"/&gt;   &lt;/sequence&gt; &lt;/complexType&gt;</pre>

#### element **HinweisBasis/HNW\_Datenelement**

diagram	 <p>The diagram shows a box for the element <b>HNW_Datenelement</b> with the type <code>Freitext500</code> and <code>min/maxLen</code> of <code>500</code>.</p>						
type	<a href="#">Freitext500</a>						
properties	content simple						
facets	<table border="1"><thead><tr><th>Kind</th><th>Value</th><th>Annotation</th></tr></thead><tbody><tr><td>maxLength</td><td>500</td><td></td></tr></tbody></table>	Kind	Value	Annotation	maxLength	500	
Kind	Value	Annotation					
maxLength	500						
source	<code>&lt;element name="HNW_Datenelement" type="Freitext500"/&gt;</code>						



### element HinweisBasis/HNW\_Meldung

diagram							
type	<a href="#">Freitext500</a>						
properties	content simple						
facets	<table border="1"> <thead> <tr> <th>Kind</th> <th>Value</th> <th>Annotation</th> </tr> </thead> <tbody> <tr> <td>maxLength</td> <td>500</td> <td></td> </tr> </tbody> </table>	Kind	Value	Annotation	maxLength	500	
Kind	Value	Annotation					
maxLength	500						
source	<code>&lt;element name="HNW_Meldung" type="Freitext500"/&gt;</code>						

### element HinweisBasis/HNW\_Wert

diagram							
type	<a href="#">Freitext500</a>						
properties	content simple						
facets	<table border="1"> <thead> <tr> <th>Kind</th> <th>Value</th> <th>Annotation</th> </tr> </thead> <tbody> <tr> <td>maxLength</td> <td>500</td> <td></td> </tr> </tbody> </table>	Kind	Value	Annotation	maxLength	500	
Kind	Value	Annotation					
maxLength	500						
source	<code>&lt;element name="HNW_Wert" type="Freitext500"/&gt;</code>						

### complexType Selbstauskunft

diagram	
namespace	http://xml.ir-d.de/sak
type	extension of <a href="#">MeldungIrdBasis</a>
properties	base MeldungIrdBasis
children	<a href="#">MEL_IrdIdGesundheitseinrichtung</a> <a href="#">fall</a>
used by	element <a href="#">GeSelbstauskunft/meldung</a>
source	<pre> &lt;complexType name="Selbstauskunft"&gt;   &lt;complexContent&gt;     &lt;extension base="MeldungIrdBasis"&gt;       &lt;sequence&gt;         &lt;element name="fall" type="SelbstauskunftFallBasis"/&gt;       &lt;/sequence&gt;     &lt;/extension&gt;   &lt;/complexContent&gt; &lt;/complexType&gt; </pre>

```

</complexContent>
</complexType>

```

### element **Selbstauskunft/fall**

diagram	
type	<a href="#">SelbstauskunftFallBasis</a>
properties	content complex
children	<a href="#">FAL_Transfernummer</a>
source	<code>&lt;element name="fall" type="SelbstauskunftFallBasis"/&gt;</code>

### complexType **Selbstauskunft**

diagram	
namespace	http://xml.ir-d.de/irdsaa
type	extension of <a href="#">MeldungIrdBasis</a>
properties	base MeldungIrdBasis
children	<a href="#">MEL_IrdIdGesundheitseinrichtung</a> <a href="#">fall</a>
used by	element <a href="#">selbstauskunftAntwort/meldung</a>
source	<pre> &lt;complexType name="Selbstauskunft"&gt;   &lt;complexContent&gt;     &lt;extension base="MeldungIrdBasis"&gt;       &lt;sequence&gt;         &lt;element name="fall" type="SelbstauskunftFallBasis"/&gt;       &lt;/sequence&gt;     &lt;/extension&gt;   &lt;/complexContent&gt; &lt;/complexType&gt; </pre>

### element **Selbstauskunft/fall**

diagram	
type	<a href="#">SelbstauskunftFallBasis</a>
properties	content complex
children	<a href="#">FAL_Transfernummer</a>
source	<code>&lt;element name="fall" type="SelbstauskunftFallBasis"/&gt;</code>

### complexType **EmpfangsbestaetigungBasis**

diagram	
namespace	http://xml.ir-d.de/irdsaa
children	<a href="#">EBG_Empfangsbestaetigung</a> <a href="#">EBG_DatumZeitEmpfang</a>
used by	element <a href="#">selbstauskunftAntwort/empfangsbestaetigung</a>
source	<pre> &lt;complexType name="EmpfangsbestaetigungBasis"&gt;   &lt;sequence&gt;     &lt;element name="EBG_Empfangsbestaetigung" type="Freitext250" fixed="Hiermit wird der Eingang Ihrer Anfrage bestätigt"/&gt;     &lt;element name="EBG_DatumZeitEmpfang" type="xs:dateTime"/&gt;   &lt;/sequence&gt; &lt;/complexType&gt; </pre>

### element **EmpfangsbestaetigungBasis/EBG\_Empfangsbestaetigung**

diagram							
type	<a href="#">Freitext250</a>						
properties	content simple fixed Hiermit wird der Eingang Ihrer Anfrage bestätigt						
facets	<table border="1"> <thead> <tr> <th>Kind</th> <th>Value</th> <th>Annotation</th> </tr> </thead> <tbody> <tr> <td>maxLength</td> <td>250</td> <td></td> </tr> </tbody> </table>	Kind	Value	Annotation	maxLength	250	
Kind	Value	Annotation					
maxLength	250						
source	<code>&lt;element name="EBG_Empfangsbestaetigung" type="Freitext250" fixed="Hiermit wird der Eingang Ihrer Anfrage bestätigt"/&gt;</code>						

element **EmpfangsbestaetigungBasis/EBG\_DatumZeitEmpfang**

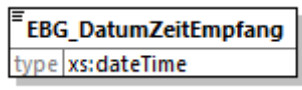
diagram	
type	<b>dateTime</b>
properties	content simple
source	<code>&lt;element name="EBG_DatumZeitEmpfang" type="xs:dateTime"/&gt;</code>

complexType **MeldungBasis**

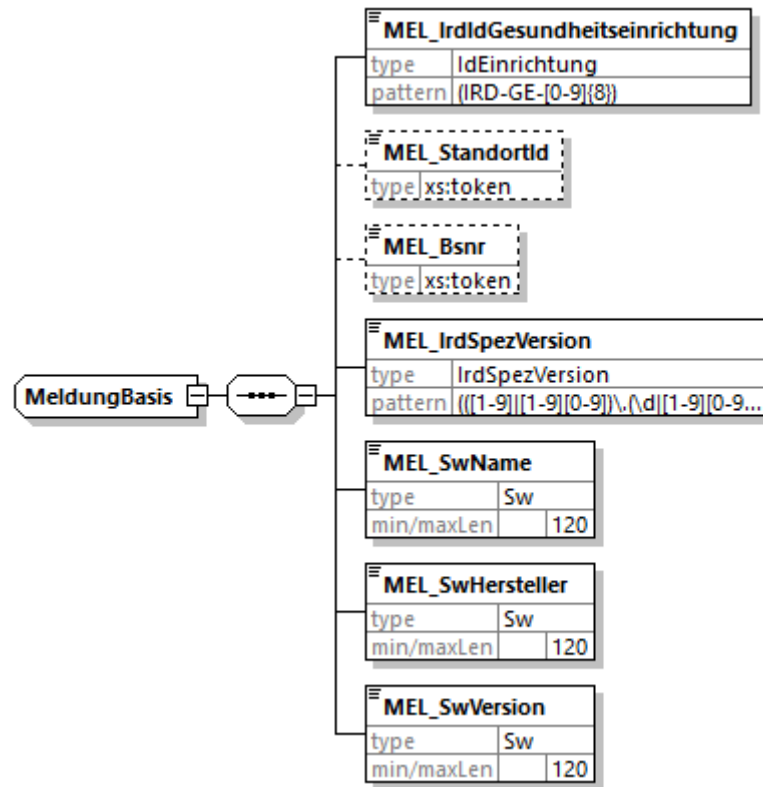
diagram	
namespace	http://xml.ir-d.de/emg
children	<a href="#">MEL_IrdIdGesundheitseinrichtung</a> <a href="#">MEL_StandortId</a> <a href="#">MEL_Bsnr</a> <a href="#">MEL_IrdSpezVersion</a> <a href="#">MEL_SwName</a> <a href="#">MEL_SwHersteller</a> <a href="#">MEL_SwVersion</a>
used by	complexType <a href="#">Meldung</a>
source	<pre>&lt;complexType name="MeldungBasis"&gt;   &lt;sequence&gt;     &lt;element name="MEL_IrdIdGesundheitseinrichtung" type="IdEinrichtung"/&gt;     &lt;element name="MEL_StandortId" type="xs:token" minOccurs="0"/&gt;     &lt;element name="MEL_Bsnr" type="xs:token" minOccurs="0"/&gt;     &lt;element name="MEL_IrdSpezVersion" type="IrdSpezVersion"/&gt;     &lt;element name="MEL_SwName" type="Sw"/&gt;     &lt;element name="MEL_SwHersteller" type="Sw"/&gt;     &lt;element name="MEL_SwVersion" type="Sw"/&gt;   &lt;/sequence&gt; &lt;/complexType&gt;</pre>

element **MeldungBasis/MEL\_IrdIdGesundheitseinrichtung**

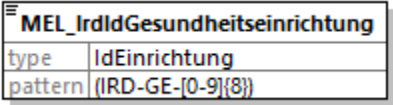
diagram							
type	<a href="#">IdEinrichtung</a>						
properties	content simple						
facets	<table border="1"> <thead> <tr> <th>Kind</th> <th>Value</th> <th>Annotation</th> </tr> </thead> <tbody> <tr> <td>pattern</td> <td>(IRD-GE-[0-9]{8})</td> <td></td> </tr> </tbody> </table>	Kind	Value	Annotation	pattern	(IRD-GE-[0-9]{8})	
Kind	Value	Annotation					
pattern	(IRD-GE-[0-9]{8})						
source	<code>&lt;element name="MEL_IrdIdGesundheitseinrichtung" type="IdEinrichtung"/&gt;</code>						

element **MeldungBasis/MEL\_StandortId**

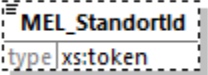
diagram							
type	<b>token</b>						
properties	<table border="1"> <tbody> <tr> <td>minOcc</td> <td>0</td> </tr> <tr> <td>maxOcc</td> <td>1</td> </tr> <tr> <td>content</td> <td>simple</td> </tr> </tbody> </table>	minOcc	0	maxOcc	1	content	simple
minOcc	0						
maxOcc	1						
content	simple						
source	<code>&lt;element name="MEL_StandortId" type="xs:token" minOccurs="0"/&gt;</code>						

element **MeldungBasis/MEL\_Bsnr**

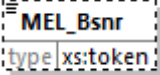
diagram							
type	<b>token</b>						
properties	<table border="1"> <tbody> <tr> <td>minOcc</td> <td>0</td> </tr> <tr> <td>maxOcc</td> <td>1</td> </tr> <tr> <td>content</td> <td>simple</td> </tr> </tbody> </table>	minOcc	0	maxOcc	1	content	simple
minOcc	0						
maxOcc	1						
content	simple						
source	<code>&lt;element name="MEL_Bsnr" type="xs:token" minOccurs="0"/&gt;</code>						

element **MeldungBasis/MEL\_IrdSpezVersion**

diagram							
type	<a href="#">IrdSpezVersion</a>						
properties	content simple						
facets	<table border="1"> <thead> <tr> <th>Kind</th> <th>Value</th> <th>Annotation</th> </tr> </thead> <tbody> <tr> <td>pattern</td> <td>((([1-9] [1-9][0-9])\.\d [1-9][0-9])\.\d [1-9][0-9])\.\d [1-9][0-9]</td> <td></td> </tr> </tbody> </table>	Kind	Value	Annotation	pattern	((([1-9] [1-9][0-9])\.\d [1-9][0-9])\.\d [1-9][0-9])\.\d [1-9][0-9]	
Kind	Value	Annotation					
pattern	((([1-9] [1-9][0-9])\.\d [1-9][0-9])\.\d [1-9][0-9])\.\d [1-9][0-9]						
source	<code>&lt;element name="MEL_IrdSpezVersion" type="IrdSpezVersion"/&gt;</code>						

element **MeldungBasis/MEL\_SwName**

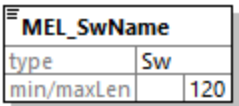
diagram							
type	<a href="#">Sw</a>						
properties	content simple						
facets	<table border="1"> <tr> <td>Kind</td> <td>Value</td> <td>Annotation</td> </tr> <tr> <td>maxLength</td> <td>120</td> <td></td> </tr> </table>	Kind	Value	Annotation	maxLength	120	
Kind	Value	Annotation					
maxLength	120						
source	<code>&lt;element name="MEL_SwName" type="Sw"/&gt;</code>						

element **MeldungBasis/MEL\_SwHersteller**

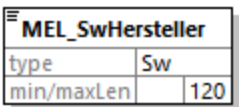
diagram							
type	<a href="#">Sw</a>						
properties	content simple						
facets	<table border="1"> <tr> <td>Kind</td> <td>Value</td> <td>Annotation</td> </tr> <tr> <td>maxLength</td> <td>120</td> <td></td> </tr> </table>	Kind	Value	Annotation	maxLength	120	
Kind	Value	Annotation					
maxLength	120						
source	<code>&lt;element name="MEL_SwHersteller" type="Sw"/&gt;</code>						

element **MeldungBasis/MEL\_SwVersion**

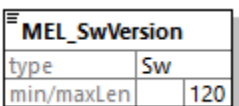
diagram							
type	<a href="#">Sw</a>						
properties	content simple						
facets	<table border="1"> <tr> <td>Kind</td> <td>Value</td> <td>Annotation</td> </tr> <tr> <td>maxLength</td> <td>120</td> <td></td> </tr> </table>	Kind	Value	Annotation	maxLength	120	
Kind	Value	Annotation					
maxLength	120						
source	<code>&lt;element name="MEL_SwVersion" type="Sw"/&gt;</code>						

## complexType **Fall**

<p>diagram</p>	
<p>namespace</p>	<p>http://xml.ir-d.de/emg</p>
<p>type</p>	<p>extension of <a href="#">FallBasis</a></p>
<p>properties</p>	<p>base <a href="#">FallBasis</a></p>
<p>children</p>	<p><a href="#">FAL Aufnahmedatum</a> <a href="#">FAL ArtAufenthaltSchluessel</a> <a href="#">FAL Transfernummer</a> <a href="#">FAL DatumZeitSatzErstellung</a> <a href="#">FAL Versionsnummer</a> <a href="#">ausloeser</a> <a href="#">patientenaufnahme</a> <a href="#">operation</a> <a href="#">postoperationAortenklappe</a> <a href="#">entlassung</a></p>
<p>used by</p>	<p>element <a href="#">Meldung/fall</a></p>
<p>source</p>	<pre>&lt;complexType name="Fall"&gt;   &lt;complexContent&gt;     &lt;extension base="FallBasis"&gt;       &lt;sequence&gt;         &lt;element name="ausloeser" type="AusloeserBasis" minOccurs="0" maxOccurs="unbounded"/&gt;         &lt;element name="patientenaufnahme" type="Patientenaufnahme"/&gt;         &lt;element name="operation" type="Operation" maxOccurs="unbounded"/&gt;         &lt;element name="postoperationAortenklappe" type="PostoperationAortenklappe" minOccurs="0"/&gt;         &lt;element name="entlassung" type="Entlassung"/&gt;       &lt;/sequence&gt;     &lt;/extension&gt;   &lt;/complexContent&gt; &lt;/complexType&gt;</pre>

```

</sequence>
</extension>
</complexContent>
</complexType>

```

### element Fall/ausloeser

diagram	
type	<a href="#">AusloeserBasis</a>
properties	minOcc 0 maxOcc unbounded content complex
children	<a href="#">ALR_ProzedurenSchluessel</a>
source	<code>&lt;element name="ausloeser" type="AusloeserBasis" minOccurs="0" maxOccurs="unbounded"/&gt;</code>

### element Fall/patientenaufnahme

diagram	
type	<a href="#">Patientenaufnahme</a>
properties	content complex
children	<a href="#">PAT Alter</a> <a href="#">PAT Groesse</a> <a href="#">PAT Gewicht</a> <a href="#">PAT GeschlechtSchluessel</a> <a href="#">patientenaufnahmeBrustimplantat</a> <a href="#">patientenaufnahmeKardiologie</a>
source	<code>&lt;element name="patientenaufnahme" type="Patientenaufnahme"/&gt;</code>



element **Fall/operation**

<p>diagram</p>	
<p>type</p>	<p><a href="#">Operation</a></p>
<p>properties</p>	<p>minOcc 1 maxOcc unbounded content complex</p>
<p>children</p>	<p><a href="#">OPE LaufendeNummer</a> <a href="#">OPE Datum</a> <a href="#">OPE SeitenLokalisationSchluessel</a> <a href="#">OPE AsaSchluessel</a> <a href="#">OPE ImplantattypSchluessel</a> <a href="#">operationBrustimplantat</a> <a href="#">operationEndoprothese</a> <a href="#">operationAortenklappe</a> <a href="#">artikelidentifikation</a> <a href="#">zubehoer</a></p>
<p>source</p>	<pre>&lt;element name="operation" type="Operation" maxOccurs="unbounded"/&gt;</pre>

# element Fall/postoperationAortenklappe

diagram

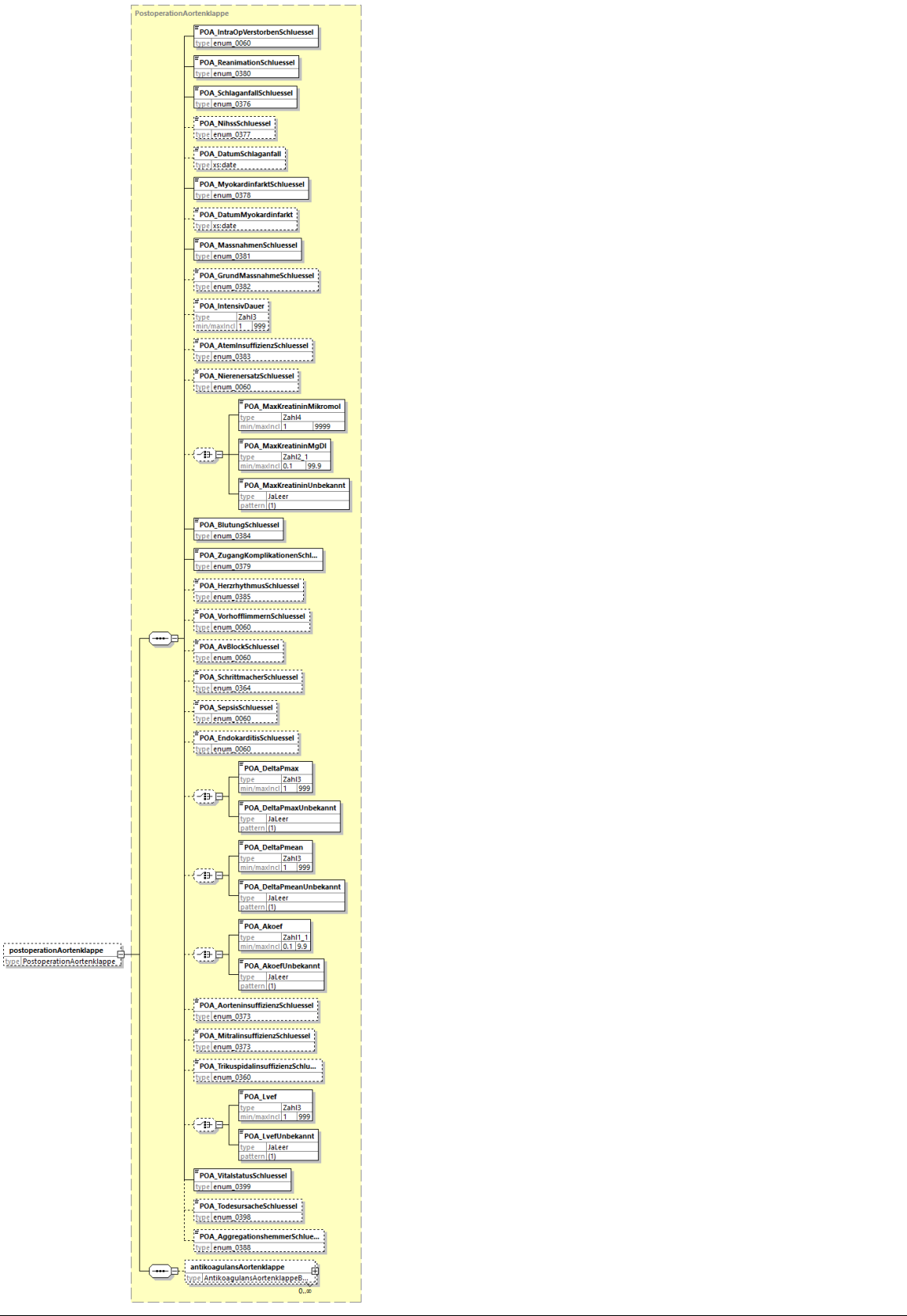

postoperationAortenklappe  
type PostoperationAortenklappe

type	<a href="#">PostoperationAortenklappe</a>
properties	minOcc 0 maxOcc 1 content complex

children	<a href="#">POA IntraOpVerstorbenSchluessel</a> <a href="#">POA ReanimationSchluessel</a> <a href="#">POA SchlaganfallSchluessel</a> <a href="#">POA NihssSchluessel</a> <a href="#">POA DatumSchlaganfall</a> <a href="#">POA MyokardinfarktSchluessel</a> <a href="#">POA DatumMyokardinfarkt</a> <a href="#">POA MassnahmenSchluessel</a> <a href="#">POA GrundMassnahmeSchluessel</a> <a href="#">POA IntensivDauer</a> <a href="#">POA AtemInsuffizienzSchluessel</a> <a href="#">POA NierenersatzSchluessel</a> <a href="#">POA MaxKreatininMikromol</a> <a href="#">POA MaxKreatininMgDI</a> <a href="#">POA MaxKreatininUnbekannt</a> <a href="#">POA BlutungSchluessel</a> <a href="#">POA ZugangKomplikationenSchluessel</a> <a href="#">POA HerzrhythmusSchluessel</a> <a href="#">POA VorhofflimmernSchluessel</a> <a href="#">POA AvBlockSchluessel</a> <a href="#">POA SchrittmacherSchluessel</a> <a href="#">POA SepsisSchluessel</a> <a href="#">POA EndokarditisSchluessel</a> <a href="#">POA DeltaPmax</a> <a href="#">POA DeltaPmaxUnbekannt</a> <a href="#">POA DeltaPmean</a> <a href="#">POA DeltaPmeanUnbekannt</a> <a href="#">POA Akoef</a> <a href="#">POA AkoefUnbekannt</a> <a href="#">POA AorteninsuffizienzSchluessel</a> <a href="#">POA MitralinsuffizienzSchluessel</a> <a href="#">POA TrikuspidalinsuffizienzSchluessel</a> <a href="#">POA Lvef</a> <a href="#">POA LvefUnbekannt</a> <a href="#">POA VitalstatusSchluessel</a> <a href="#">POA TodesursacheSchluessel</a> <a href="#">POA AggregationshemmerSchluessel</a> <a href="#">antikoagulansAortenklappe</a>
source	<pre>&lt;element name="postoperationAortenklappe" type="PostoperationAortenklappe" minOccurs="0"/&gt;</pre>

### element **Fall/entlassung**

diagram	
type	<a href="#">Entlassung</a>
properties	content complex
children	<a href="#">ENT_Datum</a> <a href="#">ENT_GrundSchluessel</a> <a href="#">diagnoseBrustimplantat</a> <a href="#">diagnoseEndoprothese</a> <a href="#">diagnoseAortenklappe</a>
source	<pre>&lt;element name="entlassung" type="Entlassung"/&gt;</pre>

### simpleType **DatumText**

namespace	http://xml.ir-d.de/stn						
type	restriction of <b>token</b>						
properties	base xs:token						
facets	<table border="0"> <tr> <td>Kind</td> <td>Value</td> <td>Annotation</td> </tr> <tr> <td>pattern</td> <td>(([0-9]{4})([0-9]{2})?([0-9]{2})?)</td> <td></td> </tr> </table>	Kind	Value	Annotation	pattern	(([0-9]{4})([0-9]{2})?([0-9]{2})?)	
Kind	Value	Annotation					
pattern	(([0-9]{4})([0-9]{2})?([0-9]{2})?)						
annotation	documentation Facette zur Festlegung des freien Datumformats: JJJJ[-MM][-TT]						

source	<pre> &lt;simpleType name="DatumText"&gt;   &lt;annotation&gt;     &lt;documentation&gt;Facette zur Festlegung des freien Datumformats:     JJJJ[-MM[-TT]]&lt;/documentation&gt;   &lt;/annotation&gt;   &lt;restriction base="xs:token"&gt;     &lt;pattern value="(([\0-9]{4})([-][\0-9]{2})?([-][\0-9]{2})?)"/&gt;   &lt;/restriction&gt; &lt;/simpleType&gt; </pre>
--------	---

### simpleType **Freitext250**

namespace	http://xml.ir-d.de/stn						
type	restriction of <b>token</b>						
properties	base xs:token						
facets	<table border="1"> <thead> <tr> <th>Kind</th> <th>Value</th> <th>Annotation</th> </tr> </thead> <tbody> <tr> <td>maxLength</td> <td>250</td> <td></td> </tr> </tbody> </table>	Kind	Value	Annotation	maxLength	250	
Kind	Value	Annotation					
maxLength	250						
annotation	documentation Facette zur Festlegung des Freitextes von 250 Zeichen						
source	<pre> &lt;simpleType name="Freitext250"&gt;   &lt;annotation&gt;     &lt;documentation&gt;Facette zur Festlegung des Freitextes von 250     Zeichen&lt;/documentation&gt;   &lt;/annotation&gt;   &lt;restriction base="xs:token"&gt;     &lt;maxLength value="250"/&gt;   &lt;/restriction&gt; &lt;/simpleType&gt; </pre>						

### simpleType **Freitext500**

namespace	http://xml.ir-d.de/stn						
type	restriction of <b>token</b>						
properties	base xs:token						
facets	<table border="1"> <thead> <tr> <th>Kind</th> <th>Value</th> <th>Annotation</th> </tr> </thead> <tbody> <tr> <td>maxLength</td> <td>500</td> <td></td> </tr> </tbody> </table>	Kind	Value	Annotation	maxLength	500	
Kind	Value	Annotation					
maxLength	500						
annotation	documentation Facette zur Festlegung des Freitextes von 500 Zeichen						
source	<pre> &lt;simpleType name="Freitext500"&gt;   &lt;annotation&gt;     &lt;documentation&gt;Facette zur Festlegung des Freitextes von 500     Zeichen&lt;/documentation&gt;   &lt;/annotation&gt;   &lt;restriction base="xs:token"&gt;     &lt;maxLength value="500"/&gt;   &lt;/restriction&gt; &lt;/simpleType&gt; </pre>						

### simpleType **HashString**

namespace	http://xml.ir-d.de/stn
-----------	------------------------

type	restriction of <b>token</b>						
properties	base xs:token						
facets	<table border="1"> <thead> <tr> <th>Kind</th> <th>Value</th> <th>Annotation</th> </tr> </thead> <tbody> <tr> <td>maxLength</td> <td>512</td> <td></td> </tr> </tbody> </table>	Kind	Value	Annotation	maxLength	512	
Kind	Value	Annotation					
maxLength	512						
annotation	documentation Facette zur Festlegung des Hash-Strings der Meldebestätigung						
source	<pre>&lt;simpleType name="HashString"&gt;   &lt;annotation&gt;     &lt;documentation&gt;Facette zur Festlegung des Hash-Strings der Meldebestätigung&lt;/documentation&gt;   &lt;/annotation&gt;   &lt;restriction base="xs:token"&gt;     &lt;maxLength value="512"/&gt;   &lt;/restriction&gt; &lt;/simpleType&gt;</pre>						

### simpleType HashWert

namespace	http://xml.ir-d.de/stn						
type	restriction of <b>token</b>						
properties	base xs:token						
facets	<table border="1"> <thead> <tr> <th>Kind</th> <th>Value</th> <th>Annotation</th> </tr> </thead> <tbody> <tr> <td>length</td> <td>64</td> <td></td> </tr> </tbody> </table>	Kind	Value	Annotation	length	64	
Kind	Value	Annotation					
length	64						
annotation	documentation Facette zur Festlegung des Hashwertes der Meldebestätigung						
source	<pre>&lt;simpleType name="HashWert"&gt;   &lt;annotation&gt;     &lt;documentation&gt;Facette zur Festlegung des Hashwertes der Meldebestätigung&lt;/documentation&gt;   &lt;/annotation&gt;   &lt;restriction base="xs:token"&gt;     &lt;length value="64"/&gt;   &lt;/restriction&gt; &lt;/simpleType&gt;</pre>						

### simpleType ICD

namespace	http://xml.ir-d.de/stn						
type	restriction of <b>token</b>						
properties	base xs:token						
facets	<table border="1"> <thead> <tr> <th>Kind</th> <th>Value</th> <th>Annotation</th> </tr> </thead> <tbody> <tr> <td>pattern</td> <td>([a-zA-Z][0-9]{2}\.[0-9]{1,2})?(:[RLB])?</td> <td></td> </tr> </tbody> </table>	Kind	Value	Annotation	pattern	([a-zA-Z][0-9]{2}\.[0-9]{1,2})?(:[RLB])?	
Kind	Value	Annotation					
pattern	([a-zA-Z][0-9]{2}\.[0-9]{1,2})?(:[RLB])?						
annotation	documentation Facette zur Festlegung des ICD Code						
source	<pre>&lt;simpleType name="ICD"&gt;   &lt;annotation&gt;     &lt;documentation&gt;Facette zur Festlegung des ICD Code&lt;/documentation&gt;   &lt;/annotation&gt;   &lt;restriction base="xs:token"&gt;     &lt;pattern value="([a-zA-Z][0-9]{2}\.[0-9]{1,2})?(:[RLB])?" /&gt;   &lt;/restriction&gt; &lt;/simpleType&gt;</pre>						

	<code>&lt;/simpleType&gt;</code>
--	----------------------------------

### simpleType IdEinrichtung

namespace	http://xml.ir-d.de/stn						
type	restriction of <b>token</b>						
properties	base xs:token						
used by	element <a href="#">MeldungIrdBasis/MEL IrdIdGesundheitseinrichtung</a>						
facets	<table border="1"> <thead> <tr> <th>Kind</th> <th>Value</th> <th>Annotation</th> </tr> </thead> <tbody> <tr> <td>pattern</td> <td>(IRD-GE-[0-9]{8})</td> <td></td> </tr> </tbody> </table>	Kind	Value	Annotation	pattern	(IRD-GE-[0-9]{8})	
Kind	Value	Annotation					
pattern	(IRD-GE-[0-9]{8})						
annotation	documentation Facette zur Festlegung der Gesundheitseinrichtung-ID						
source	<pre>&lt;simpleType name="IdEinrichtung"&gt;   &lt;annotation&gt;     &lt;documentation&gt;Facette zur Festlegung der Gesundheitseinrichtung-ID&lt;/documentation&gt;   &lt;/annotation&gt;   &lt;restriction base="xs:token"&gt;     &lt;pattern value="(IRD-GE-[0-9]{8})"/&gt;   &lt;/restriction&gt; &lt;/simpleType&gt;</pre>						

### simpleType IrdArtikelId

namespace	http://xml.ir-d.de/stn						
type	restriction of <b>token</b>						
properties	base xs:token						
facets	<table border="1"> <thead> <tr> <th>Kind</th> <th>Value</th> <th>Annotation</th> </tr> </thead> <tbody> <tr> <td>maxLength</td> <td>16</td> <td></td> </tr> </tbody> </table>	Kind	Value	Annotation	maxLength	16	
Kind	Value	Annotation					
maxLength	16						
annotation	documentation Facette zur Festlegung der IrdNummer						
source	<pre>&lt;simpleType name="IrdArtikelId"&gt;   &lt;annotation&gt;     &lt;documentation&gt;Facette zur Festlegung der IrdNummer&lt;/documentation&gt;   &lt;/annotation&gt;   &lt;restriction base="xs:token"&gt;     &lt;maxLength value="16"/&gt;   &lt;/restriction&gt; &lt;/simpleType&gt;</pre>						

### simpleType IrdSpezVersion

namespace	http://xml.ir-d.de/stn						
type	restriction of <b>token</b>						
properties	base xs:token						
facets	<table border="1"> <thead> <tr> <th>Kind</th> <th>Value</th> <th>Annotation</th> </tr> </thead> <tbody> <tr> <td>pattern</td> <td>(([1-9][1-9][0-9])\.\d{1}[1-9][0-9]\.\d{1}[1-9][0-9])</td> <td></td> </tr> </tbody> </table>	Kind	Value	Annotation	pattern	(([1-9][1-9][0-9])\.\d{1}[1-9][0-9]\.\d{1}[1-9][0-9])	
Kind	Value	Annotation					
pattern	(([1-9][1-9][0-9])\.\d{1}[1-9][0-9]\.\d{1}[1-9][0-9])						
annotation	documentation Facette zur Festlegung der Version der IRD-Spezifikation						

source	<pre> &lt;simpleType name="IrdSpezVersion"&gt;   &lt;annotation&gt;     &lt;documentation&gt;Facette zur Festlegung der Version der IRD-Spezifikation&lt;/documentation&gt;   &lt;/annotation&gt;   &lt;restriction base="xs:token"&gt;     &lt;pattern value="(([1-9] [1-9][0-9])\.(\\d [1-9][0-9])\.(\\d [1-9][0-9]))"/&gt;   &lt;/restriction&gt; &lt;/simpleType&gt; </pre>
--------	---

### simpleType **JaLeer**

namespace	http://xml.ir-d.de/stn						
type	restriction of <b>integer</b>						
properties	base xs:integer						
facets	<table border="1"> <thead> <tr> <th>Kind</th> <th>Value</th> <th>Annotation</th> </tr> </thead> <tbody> <tr> <td>pattern</td> <td>(1)</td> <td></td> </tr> </tbody> </table>	Kind	Value	Annotation	pattern	(1)	
Kind	Value	Annotation					
pattern	(1)						
annotation	documentation Facette zur Festlegung des Unbekannt-Wertes (Bedeutung 1=true)						
source	<pre> &lt;simpleType name="JaLeer"&gt;   &lt;annotation&gt;     &lt;documentation&gt;Facette zur Festlegung des Unbekannt-Wertes (Bedeutung 1=true)&lt;/documentation&gt;   &lt;/annotation&gt;   &lt;restriction base="xs:integer"&gt;     &lt;pattern value="(1)"/&gt;   &lt;/restriction&gt; &lt;/simpleType&gt; </pre>						

### simpleType **Meldebestaetigung**

namespace	http://xml.ir-d.de/stn						
type	restriction of <b>token</b>						
properties	base xs:token						
facets	<table border="1"> <thead> <tr> <th>Kind</th> <th>Value</th> <th>Annotation</th> </tr> </thead> <tbody> <tr> <td>length</td> <td>10</td> <td></td> </tr> </tbody> </table>	Kind	Value	Annotation	length	10	
Kind	Value	Annotation					
length	10						
annotation	documentation Facette zur Festlegung der Meldebestätigungslaenge von 10 Zeichen						
source	<pre> &lt;simpleType name="Meldebestaetigung"&gt;   &lt;annotation&gt;     &lt;documentation&gt;Facette zur Festlegung der Meldebestätigungslaenge von 10 Zeichen&lt;/documentation&gt;   &lt;/annotation&gt;   &lt;restriction base="xs:token"&gt;     &lt;length value="10"/&gt;   &lt;/restriction&gt; &lt;/simpleType&gt; </pre>						

### simpleType **OPS**

namespac	http://xml.ir-d.de/stn
----------	------------------------

e							
type	restriction of <b>token</b>						
properties	base xs:token						
facets	<table border="1"> <thead> <tr> <th>Kind</th> <th>Value</th> <th>Annotation</th> </tr> </thead> <tbody> <tr> <td>pattern</td> <td>(([135689]\-([0-9]){2}([a-zA-Z0-9]){1}\.([a-zA-Z0-9]{1,2}))*(:[RLBr1b])?)</td> <td></td> </tr> </tbody> </table>	Kind	Value	Annotation	pattern	(([135689]\-([0-9]){2}([a-zA-Z0-9]){1}\.([a-zA-Z0-9]{1,2}))*(:[RLBr1b])?)	
Kind	Value	Annotation					
pattern	(([135689]\-([0-9]){2}([a-zA-Z0-9]){1}\.([a-zA-Z0-9]{1,2}))*(:[RLBr1b])?)						
annotation	documentation Facette zur Festlegung des Prozedurenschlüssels						
source	<pre> &lt;simpleType name="OPS"&gt;   &lt;annotation&gt;     &lt;documentation&gt;Facette zur Festlegung des Prozedurenschlüssels&lt;/documentation&gt;   &lt;/annotation&gt;   &lt;restriction base="xs:token"&gt;     &lt;pattern value="([135689]\-([0-9]){2}([a-zA-Z0-9]){1}\.([a-zA-Z0-9]{1,2}))*(:[RLBr1b] ?)" /&gt;   &lt;/restriction&gt; &lt;/simpleType&gt; </pre>						

### simpleType **String2**

namespace	http://xml.ir-d.de/stn						
type	restriction of <b>token</b>						
properties	base xs:token						
facets	<table border="1"> <thead> <tr> <th>Kind</th> <th>Value</th> <th>Annotation</th> </tr> </thead> <tbody> <tr> <td>pattern</td> <td>([0-9]{2})</td> <td></td> </tr> </tbody> </table>	Kind	Value	Annotation	pattern	([0-9]{2})	
Kind	Value	Annotation					
pattern	([0-9]{2})						
annotation	documentation Facette zur Festlegung des kodierten Entlassungsgrundes						
source	<pre> &lt;simpleType name="String2"&gt;   &lt;annotation&gt;     &lt;documentation&gt;Facette zur Festlegung des kodierten Entlassungsgrundes&lt;/documentation&gt;   &lt;/annotation&gt;   &lt;restriction base="xs:token"&gt;     &lt;pattern value="([0-9]{2})" /&gt;   &lt;/restriction&gt; &lt;/simpleType&gt; </pre>						

### simpleType **String20**

namespace	http://xml.ir-d.de/stn						
type	restriction of <b>token</b>						
properties	base xs:token						
facets	<table border="1"> <thead> <tr> <th>Kind</th> <th>Value</th> <th>Annotation</th> </tr> </thead> <tbody> <tr> <td>maxLength</td> <td>20</td> <td></td> </tr> </tbody> </table>	Kind	Value	Annotation	maxLength	20	
Kind	Value	Annotation					
maxLength	20						
annotation	documentation Facette zur Festlegung von: Artikel-, Ident-, Serien-, Lot-Nummer des Produkts						
source	<pre> &lt;simpleType name="String20"&gt;   &lt;annotation&gt;     &lt;documentation&gt;Facette zur Festlegung von: Artikel-, Ident-, Serien-, </pre>						



	<pre> Lot-Nummer des Produkts&lt;/documentation&gt; &lt;/annotation&gt; &lt;restriction base="xs:token"&gt;   &lt;maxLength value="20"/&gt; &lt;/restriction&gt; &lt;/simpleType&gt; </pre>
--	---

### simpleType Sw

namespace	http://xml.ir-d.de/stn						
type	restriction of <b>token</b>						
properties	base xs:token						
facets	<table border="1"> <thead> <tr> <th>Kind</th> <th>Value</th> <th>Annotation</th> </tr> </thead> <tbody> <tr> <td>maxLength</td> <td>120</td> <td></td> </tr> </tbody> </table>	Kind	Value	Annotation	maxLength	120	
Kind	Value	Annotation					
maxLength	120						
annotation	documentation Facette für Merkmale der externen Software						
source	<pre> &lt;simpleType name="Sw"&gt;   &lt;annotation&gt;     &lt;documentation&gt;Facette für Merkmale der externen Software&lt;/documentation&gt;   &lt;/annotation&gt;   &lt;restriction base="xs:token"&gt;     &lt;maxLength value="120"/&gt;   &lt;/restriction&gt; &lt;/simpleType&gt; </pre>						

### simpleType Transfervummer

namespace	http://xml.ir-d.de/stn						
type	restriction of <b>token</b>						
properties	base xs:token						
used by	element <a href="#">StornoFallBasis/FAL Transfervummer</a>						
facets	<table border="1"> <thead> <tr> <th>Kind</th> <th>Value</th> <th>Annotation</th> </tr> </thead> <tbody> <tr> <td>pattern</td> <td>([a-z0-9]{64})</td> <td></td> </tr> </tbody> </table>	Kind	Value	Annotation	pattern	([a-z0-9]{64})	
Kind	Value	Annotation					
pattern	([a-z0-9]{64})						
annotation	documentation Facette zur Festlegung der Transfervummer						
source	<pre> &lt;simpleType name="Transfervummer"&gt;   &lt;annotation&gt;     &lt;documentation&gt;Facette zur Festlegung der Transfervummer&lt;/documentation&gt;   &lt;/annotation&gt;   &lt;restriction base="xs:token"&gt;     &lt;pattern value="([a-z0-9]{64})"/&gt;   &lt;/restriction&gt; &lt;/simpleType&gt; </pre>						

### simpleType Versionsnummer

namespace	http://xml.ir-d.de/stn
type	restriction of <b>token</b>
properties	base xs:token

facets	<table border="1"> <thead> <tr> <th>Kind</th> <th>Value</th> <th>Annotation</th> </tr> </thead> <tbody> <tr> <td>maxLength</td> <td>10</td> <td></td> </tr> </tbody> </table>	Kind	Value	Annotation	maxLength	10	
Kind	Value	Annotation					
maxLength	10						
annotation	<p>documentation Facette zur Festlegung der Versionsnummer des gelieferten Datensatzes</p>						
source	<pre>&lt;simpleType name="Versionsnummer"&gt;   &lt;annotation&gt;     &lt;documentation&gt;Facette zur Festlegung der Versionsnummer des gelieferten Datensatzes&lt;/documentation&gt;   &lt;/annotation&gt;   &lt;restriction base="xs:token"&gt;     &lt;maxLength value="10"/&gt;   &lt;/restriction&gt; &lt;/simpleType&gt;</pre>						

### simpleType Zahl1

namespace	http://xml.ir-d.de/stn									
type	restriction of <b>positivelnteger</b>									
properties	base xs:positivelnteger									
facets	<table border="1"> <thead> <tr> <th>Kind</th> <th>Value</th> <th>Annotation</th> </tr> </thead> <tbody> <tr> <td>minInclusive</td> <td>1</td> <td></td> </tr> <tr> <td>maxInclusive</td> <td>9</td> <td></td> </tr> </tbody> </table>	Kind	Value	Annotation	minInclusive	1		maxInclusive	9	
Kind	Value	Annotation								
minInclusive	1									
maxInclusive	9									
annotation	<p>documentation Facette zur Festlegung der 1-stelligen Ganzzahlenwerte</p>									
source	<pre>&lt;simpleType name="Zahl1"&gt;   &lt;annotation&gt;     &lt;documentation&gt;Facette zur Festlegung der 1-stelligen Ganzzahlenwerte&lt;/documentation&gt;   &lt;/annotation&gt;   &lt;restriction base="xs:positiveInteger"&gt;     &lt;minInclusive value="1"/&gt;     &lt;maxInclusive value="9"/&gt;   &lt;/restriction&gt; &lt;/simpleType&gt;</pre>									

### simpleType Zahl1\_1

namespace	http://xml.ir-d.de/stn															
type	restriction of <b>decimal</b>															
properties	base xs:decimal															
facets	<table border="1"> <thead> <tr> <th>Kind</th> <th>Value</th> <th>Annotation</th> </tr> </thead> <tbody> <tr> <td>minInclusive</td> <td>0.1</td> <td></td> </tr> <tr> <td>maxInclusive</td> <td>9.9</td> <td></td> </tr> <tr> <td>totalDigits</td> <td>2</td> <td></td> </tr> <tr> <td>fractionDigits</td> <td>1</td> <td></td> </tr> </tbody> </table>	Kind	Value	Annotation	minInclusive	0.1		maxInclusive	9.9		totalDigits	2		fractionDigits	1	
Kind	Value	Annotation														
minInclusive	0.1															
maxInclusive	9.9															
totalDigits	2															
fractionDigits	1															
annotation	<p>documentation Facette zur Festlegung des Formats [N].[N]</p>															
source	<pre>&lt;simpleType name="Zahl1_1"&gt;   &lt;annotation&gt;     &lt;documentation&gt;Facette zur Festlegung des Formats [N].[N]&lt;/documentation&gt;   &lt;/annotation&gt;   &lt;restriction base="xs:decimal"&gt;</pre>															

	<pre> &lt;totalDigits value="2"/&gt; &lt;fractionDigits value="1"/&gt; &lt;minInclusive value="0.1"/&gt; &lt;maxInclusive value="9.9"/&gt; &lt;/restriction&gt; &lt;/simpleType&gt; </pre>
--	--

### simpleType Zahl2

namespace	http://xml.ir-d.de/stn									
type	restriction of <b>positiveInteger</b>									
properties	base xs:positiveInteger									
facets	<table border="1"> <thead> <tr> <th>Kind</th> <th>Value</th> <th>Annotation</th> </tr> </thead> <tbody> <tr> <td>minInclusive</td> <td>1</td> <td></td> </tr> <tr> <td>maxInclusive</td> <td>99</td> <td></td> </tr> </tbody> </table>	Kind	Value	Annotation	minInclusive	1		maxInclusive	99	
Kind	Value	Annotation								
minInclusive	1									
maxInclusive	99									
annotation	documentation Facette zur Festlegung der 2-stelligen Ganzzahlenwerte									
source	<pre> &lt;simpleType name="Zahl2"&gt;   &lt;annotation&gt;     &lt;documentation&gt;Facette zur Festlegung der 2-stelligen Ganzzahlenwerte&lt;/documentation&gt;   &lt;/annotation&gt;   &lt;restriction base="xs:positiveInteger"&gt;     &lt;minInclusive value="1"/&gt;     &lt;maxInclusive value="99"/&gt;   &lt;/restriction&gt; &lt;/simpleType&gt; </pre>									

### simpleType Zahl2\_1

namespace	http://xml.ir-d.de/stn															
type	restriction of <b>decimal</b>															
properties	base xs:decimal															
facets	<table border="1"> <thead> <tr> <th>Kind</th> <th>Value</th> <th>Annotation</th> </tr> </thead> <tbody> <tr> <td>minInclusive</td> <td>0.1</td> <td></td> </tr> <tr> <td>maxInclusive</td> <td>99.9</td> <td></td> </tr> <tr> <td>totalDigits</td> <td>3</td> <td></td> </tr> <tr> <td>fractionDigits</td> <td>1</td> <td></td> </tr> </tbody> </table>	Kind	Value	Annotation	minInclusive	0.1		maxInclusive	99.9		totalDigits	3		fractionDigits	1	
Kind	Value	Annotation														
minInclusive	0.1															
maxInclusive	99.9															
totalDigits	3															
fractionDigits	1															
annotation	documentation Facette zur Festlegung des Formats [NN].[N]															
source	<pre> &lt;simpleType name="Zahl2_1"&gt;   &lt;annotation&gt;     &lt;documentation&gt;Facette zur Festlegung des Formats [NN].[N]&lt;/documentation&gt;   &lt;/annotation&gt;   &lt;restriction base="xs:decimal"&gt;     &lt;totalDigits value="3"/&gt;     &lt;fractionDigits value="1"/&gt;     &lt;minInclusive value="0.1"/&gt;     &lt;maxInclusive value="99.9"/&gt;   &lt;/restriction&gt; &lt;/simpleType&gt; </pre>															

### simpleType Zahl3

namespace	http://xml.ir-d.de/stn									
type	restriction of <b>positiveInteger</b>									
properties	base xs:positiveInteger									
facets	<table border="1"> <thead> <tr> <th>Kind</th> <th>Value</th> <th>Annotation</th> </tr> </thead> <tbody> <tr> <td>minInclusive</td> <td>1</td> <td></td> </tr> <tr> <td>maxInclusive</td> <td>999</td> <td></td> </tr> </tbody> </table>	Kind	Value	Annotation	minInclusive	1		maxInclusive	999	
Kind	Value	Annotation								
minInclusive	1									
maxInclusive	999									
annotation	documentation Facette zur Festlegung der 3-stelligen Ganzzahlenwerte									
source	<pre>&lt;simpleType name="Zahl3"&gt;   &lt;annotation&gt;     &lt;documentation&gt;Facette zur Festlegung der 3-stelligen Ganzzahlenwerte&lt;/documentation&gt;   &lt;/annotation&gt;   &lt;restriction base="xs:positiveInteger"&gt;     &lt;minInclusive value="1"/&gt;     &lt;maxInclusive value="999"/&gt;   &lt;/restriction&gt; &lt;/simpleType&gt;</pre>									

### simpleType Zahl3\_1

namespace	http://xml.ir-d.de/stn															
type	restriction of <b>decimal</b>															
properties	base xs:decimal															
facets	<table border="1"> <thead> <tr> <th>Kind</th> <th>Value</th> <th>Annotation</th> </tr> </thead> <tbody> <tr> <td>minInclusive</td> <td>0.1</td> <td></td> </tr> <tr> <td>maxInclusive</td> <td>999.9</td> <td></td> </tr> <tr> <td>totalDigits</td> <td>4</td> <td></td> </tr> <tr> <td>fractionDigits</td> <td>1</td> <td></td> </tr> </tbody> </table>	Kind	Value	Annotation	minInclusive	0.1		maxInclusive	999.9		totalDigits	4		fractionDigits	1	
Kind	Value	Annotation														
minInclusive	0.1															
maxInclusive	999.9															
totalDigits	4															
fractionDigits	1															
annotation	documentation Facette zur Festlegung des Formats [NNN].[N]															
source	<pre>&lt;simpleType name="Zahl3_1"&gt;   &lt;annotation&gt;     &lt;documentation&gt;Facette zur Festlegung des Formats [NNN].[N]&lt;/documentation&gt;   &lt;/annotation&gt;   &lt;restriction base="xs:decimal"&gt;     &lt;totalDigits value="4"/&gt;     &lt;fractionDigits value="1"/&gt;     &lt;minInclusive value="0.1"/&gt;     &lt;maxInclusive value="999.9"/&gt;   &lt;/restriction&gt; &lt;/simpleType&gt;</pre>															

### simpleType Zahl4

namespace	http://xml.ir-d.de/stn
type	restriction of <b>positiveInteger</b>
properties	base xs:positiveInteger

facets	<table border="1"> <thead> <tr> <th>Kind</th> <th>Value</th> <th>Annotation</th> </tr> </thead> <tbody> <tr> <td>minInclusive</td> <td>1</td> <td></td> </tr> <tr> <td>maxInclusive</td> <td>9999</td> <td></td> </tr> </tbody> </table>	Kind	Value	Annotation	minInclusive	1		maxInclusive	9999	
Kind	Value	Annotation								
minInclusive	1									
maxInclusive	9999									
annotation	documentation Facette zur Festlegung der 4-stelligen Ganzzahlenwerte									
source	<pre>&lt;simpleType name="Zahl4"&gt;   &lt;annotation&gt;     &lt;documentation&gt;Facette zur Festlegung der 4-stelligen Ganzzahlenwerte&lt;/documentation&gt;   &lt;/annotation&gt;   &lt;restriction base="xs:positiveInteger"&gt;     &lt;minInclusive value="1"/&gt;     &lt;maxInclusive value="9999"/&gt;   &lt;/restriction&gt; &lt;/simpleType&gt;</pre>									

### simpleType Zahl5

namespace	http://xml.ir-d.de/stn									
type	restriction of <b>positiveInteger</b>									
properties	base xs:positiveInteger									
facets	<table border="1"> <thead> <tr> <th>Kind</th> <th>Value</th> <th>Annotation</th> </tr> </thead> <tbody> <tr> <td>minInclusive</td> <td>1</td> <td></td> </tr> <tr> <td>maxInclusive</td> <td>99999</td> <td></td> </tr> </tbody> </table>	Kind	Value	Annotation	minInclusive	1		maxInclusive	99999	
Kind	Value	Annotation								
minInclusive	1									
maxInclusive	99999									
annotation	documentation Facette zur Festlegung der 5-stelligen Ganzzahlenwerte									
source	<pre>&lt;simpleType name="Zahl5"&gt;   &lt;annotation&gt;     &lt;documentation&gt;Facette zur Festlegung der 5-stelligen Ganzzahlenwerte&lt;/documentation&gt;   &lt;/annotation&gt;   &lt;restriction base="xs:positiveInteger"&gt;     &lt;minInclusive value="1"/&gt;     &lt;maxInclusive value="99999"/&gt;   &lt;/restriction&gt; &lt;/simpleType&gt;</pre>									

### simpleType Zahl5mitNull

namespace	http://xml.ir-d.de/stn									
type	restriction of <b>integer</b>									
properties	base xs:integer									
facets	<table border="1"> <thead> <tr> <th>Kind</th> <th>Value</th> <th>Annotation</th> </tr> </thead> <tbody> <tr> <td>minInclusive</td> <td>0</td> <td></td> </tr> <tr> <td>maxInclusive</td> <td>99999</td> <td></td> </tr> </tbody> </table>	Kind	Value	Annotation	minInclusive	0		maxInclusive	99999	
Kind	Value	Annotation								
minInclusive	0									
maxInclusive	99999									
annotation	documentation Facette zur Festlegung der 5-stelligen Ganzzahlenwerte inklusive "0"									
source	<pre>&lt;simpleType name="Zahl5mitNull"&gt;   &lt;annotation&gt;     &lt;documentation&gt;Facette zur Festlegung der 5-stelligen Ganzzahlenwerte inklusive "0"&lt;/documentation&gt;   &lt;/annotation&gt;</pre>									

```

<restriction base="xs:integer">
  <minInclusive value="0"/>
  <maxInclusive value="99999"/>
</restriction>
</simpleType>

```

### complexType MeldungIrdBasis

diagram	
namespace	http://xml.ir-d.de/stn
children	<a href="#">MEL_IrdIdGesundheitseinrichtung</a>
used by	complexType <a href="#">Storno</a>
source	<pre> &lt;complexType name="MeldungIrdBasis"&gt;   &lt;sequence&gt;     &lt;element name="MEL_IrdIdGesundheitseinrichtung" type="IdEinrichtung"/&gt;   &lt;/sequence&gt; &lt;/complexType&gt; </pre>

### element MeldungIrdBasis/MEL\_IrdIdGesundheitseinrichtung

diagram							
type	<a href="#">IdEinrichtung</a>						
properties	content simple						
facets	<table border="1"> <thead> <tr> <th>Kind</th> <th>Value</th> <th>Annotation</th> </tr> </thead> <tbody> <tr> <td>pattern</td> <td>(IRD-GE-[0-9]{8})</td> <td></td> </tr> </tbody> </table>	Kind	Value	Annotation	pattern	(IRD-GE-[0-9]{8})	
Kind	Value	Annotation					
pattern	(IRD-GE-[0-9]{8})						
source	<pre> &lt;element name="MEL_IrdIdGesundheitseinrichtung" type="IdEinrichtung"/&gt; </pre>						

### complexType StornoFallBasis

diagram	
namespace	http://xml.ir-d.de/stn
children	<a href="#">FAL_Transfernummer</a> <a href="#">FAL_Aufnahmedatum</a>
used by	element <a href="#">Storno/fall</a>
source	<pre> &lt;complexType name="StornoFallBasis"&gt;   &lt;sequence&gt;     &lt;element name="FAL_Transfernummer" type="Transfernummer"/&gt; </pre>

	<pre>&lt;element name="FAL_Aufnahmedatum" type="xs:date"/&gt; &lt;/sequence&gt; &lt;/complexType&gt;</pre>
--	--

#### element **StornoFallBasis/FAL\_Transfernummer**

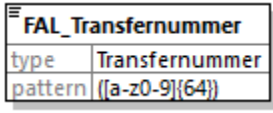
diagram							
type	<a href="#">Transfernummer</a>						
properties	content simple						
facets	<table border="1"> <thead> <tr> <th>Kind</th> <th>Value</th> <th>Annotation</th> </tr> </thead> <tbody> <tr> <td>pattern</td> <td>([a-z0-9]{64})</td> <td></td> </tr> </tbody> </table>	Kind	Value	Annotation	pattern	([a-z0-9]{64})	
Kind	Value	Annotation					
pattern	([a-z0-9]{64})						
source	<pre>&lt;element name="FAL_Transfernummer" type="Transfernummer"/&gt;</pre>						

#### element **StornoFallBasis/FAL\_Aufnahmedatum**

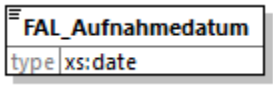
diagram	
type	<b>date</b>
properties	content simple
source	<pre>&lt;element name="FAL_Aufnahmedatum" type="xs:date"/&gt;</pre>

#### simpleType **DatumText**

namespace	http://xml.ir-d.de/irdma						
type	restriction of <b>token</b>						
properties	base xs:token						
facets	<table border="1"> <thead> <tr> <th>Kind</th> <th>Value</th> <th>Annotation</th> </tr> </thead> <tbody> <tr> <td>pattern</td> <td>(([0-9]{4})([0-9]{2})?([0-9]{2})?)</td> <td></td> </tr> </tbody> </table>	Kind	Value	Annotation	pattern	(([0-9]{4})([0-9]{2})?([0-9]{2})?)	
Kind	Value	Annotation					
pattern	(([0-9]{4})([0-9]{2})?([0-9]{2})?)						
annotation	documentation Facette zur Festlegung des freien Datumformats: JJJJ[-MM[-TT]]						
source	<pre>&lt;simpleType name="DatumText"&gt;   &lt;annotation&gt;     &lt;documentation&gt;Facette zur Festlegung des freien Datumformats:     JJJJ[-MM[-TT]]&lt;/documentation&gt;   &lt;/annotation&gt;   &lt;restriction base="xs:token"&gt;     &lt;pattern value="((([0-9]{4})([0-9]{2})?([0-9]{2})?)")/&gt;   &lt;/restriction&gt; &lt;/simpleType&gt;</pre>						

#### simpleType **Freitext250**

namespace	http://xml.ir-d.de/irdma
-----------	--------------------------

type	restriction of <b>token</b>
properties	base xs:token
used by	elements <a href="#">BestaetigungBasis/BEG AusloesendeOpsListe</a> <a href="#">EmpfangsbestaetigungBasis/EBG Empfangsbestaetigung</a>
facets	Kind Value Annotation maxLength 250
annotation	documentation Facette zur Festlegung des Freitextes von 250 Zeichen
source	<pre>&lt;simpleType name="Freitext250"&gt;   &lt;annotation&gt;     &lt;documentation&gt;Facette zur Festlegung des Freitextes von 250 Zeichen&lt;/documentation&gt;   &lt;/annotation&gt;   &lt;restriction base="xs:token"&gt;     &lt;maxLength value="250"/&gt;   &lt;/restriction&gt; &lt;/simpleType&gt;</pre>

### simpleType **Freitext500**

namespace	http://xml.ir-d.de/irdma
type	restriction of <b>token</b>
properties	base xs:token
used by	elements <a href="#">HinweisBasis/HNW Datenelement</a> <a href="#">HinweisBasis/HNW Meldung</a> <a href="#">HinweisBasis/HNW Wert</a>
facets	Kind Value Annotation maxLength 500
annotation	documentation Facette zur Festlegung des Freitextes von 500 Zeichen
source	<pre>&lt;simpleType name="Freitext500"&gt;   &lt;annotation&gt;     &lt;documentation&gt;Facette zur Festlegung des Freitextes von 500 Zeichen&lt;/documentation&gt;   &lt;/annotation&gt;   &lt;restriction base="xs:token"&gt;     &lt;maxLength value="500"/&gt;   &lt;/restriction&gt; &lt;/simpleType&gt;</pre>

### simpleType **HashString**

namespace	http://xml.ir-d.de/irdma
type	restriction of <b>token</b>
properties	base xs:token
used by	element <a href="#">BestaetigungBasis/BEG Hash String</a>
facets	Kind Value Annotation maxLength 512
annotation	documentation Facette zur Festlegung des Hash-Strings der Meldebestätigung
source	<pre>&lt;simpleType name="HashString"&gt;   &lt;annotation&gt;</pre>



	<pre> &lt;documentation&gt;Facette zur Festlegung des Hash-Strings der Meldebestätigung&lt;/documentation&gt; &lt;/annotation&gt; &lt;restriction base="xs:token"&gt;   &lt;maxLength value="512"/&gt; &lt;/restriction&gt; &lt;/simpleType&gt; </pre>
--	--

### simpleType HashWert

namespace	http://xml.ir-d.de/irdma
type	restriction of <b>token</b>
properties	base xs:token
used by	element <a href="#">BestaetigungBasis/BEG Hash Wert</a>
facets	Kind Value Annotation length 64
annotation	documentation Facette zur Festlegung des Hashwertes der Meldebestätigung
source	<pre> &lt;simpleType name="HashWert"&gt;   &lt;annotation&gt;     &lt;documentation&gt;Facette zur Festlegung des Hashwertes der Meldebestätigung&lt;/documentation&gt;   &lt;/annotation&gt;   &lt;restriction base="xs:token"&gt;     &lt;length value="64"/&gt;   &lt;/restriction&gt; &lt;/simpleType&gt; </pre>

### simpleType ICD

namespace	http://xml.ir-d.de/irdma
type	restriction of <b>token</b>
properties	base xs:token
facets	Kind Value Annotation pattern ([a-zA-Z][0-9]{2}(\.[0-9]{1,2})?(:[RLB])?)
annotation	documentation Facette zur Festlegung des ICD Code
source	<pre> &lt;simpleType name="ICD"&gt;   &lt;annotation&gt;     &lt;documentation&gt;Facette zur Festlegung des ICD Code&lt;/documentation&gt;   &lt;/annotation&gt;   &lt;restriction base="xs:token"&gt;     &lt;pattern value="([a-zA-Z][0-9]{2}(\.[0-9]{1,2})?(:[RLB])?)"/&gt;   &lt;/restriction&gt; &lt;/simpleType&gt; </pre>

### simpleType IdEinrichtung

namespace	http://xml.ir-d.de/irdma
type	restriction of <b>token</b>

properties	base xs:token						
used by	element <a href="#">MeldungIrdBasis/MEL_IrdIdGesundheitseinrichtung</a>						
facets	<table border="1"> <thead> <tr> <th>Kind</th> <th>Value</th> <th>Annotation</th> </tr> </thead> <tbody> <tr> <td>pattern</td> <td>(IRD-GE-[0-9]{8})</td> <td></td> </tr> </tbody> </table>	Kind	Value	Annotation	pattern	(IRD-GE-[0-9]{8})	
Kind	Value	Annotation					
pattern	(IRD-GE-[0-9]{8})						
annotation	documentation Facette zur Festlegung der Gesundheitseinrichtung-ID						
source	<pre>&lt;simpleType name="IdEinrichtung"&gt;   &lt;annotation&gt;     &lt;documentation&gt;Facette zur Festlegung der Gesundheitseinrichtung-ID&lt;/documentation&gt;   &lt;/annotation&gt;   &lt;restriction base="xs:token"&gt;     &lt;pattern value="(IRD-GE-[0-9]{8})"/&gt;   &lt;/restriction&gt; &lt;/simpleType&gt;</pre>						

### simpleType IrdArtikelId

namespace	http://xml.ir-d.de/irdma						
type	restriction of <b>token</b>						
properties	base xs:token						
facets	<table border="1"> <thead> <tr> <th>Kind</th> <th>Value</th> <th>Annotation</th> </tr> </thead> <tbody> <tr> <td>maxLength</td> <td>16</td> <td></td> </tr> </tbody> </table>	Kind	Value	Annotation	maxLength	16	
Kind	Value	Annotation					
maxLength	16						
annotation	documentation Facette zur Festlegung der IrdNummer						
source	<pre>&lt;simpleType name="IrdArtikelId"&gt;   &lt;annotation&gt;     &lt;documentation&gt;Facette zur Festlegung der IrdNummer&lt;/documentation&gt;   &lt;/annotation&gt;   &lt;restriction base="xs:token"&gt;     &lt;maxLength value="16"/&gt;   &lt;/restriction&gt; &lt;/simpleType&gt;</pre>						

### simpleType IrdSpezVersion

namespace	http://xml.ir-d.de/irdma						
type	restriction of <b>token</b>						
properties	base xs:token						
facets	<table border="1"> <thead> <tr> <th>Kind</th> <th>Value</th> <th>Annotation</th> </tr> </thead> <tbody> <tr> <td>pattern</td> <td>(([1-9] [1-9][0-9])\.\d{1}[0-9])\.\d{1}[0-9])</td> <td></td> </tr> </tbody> </table>	Kind	Value	Annotation	pattern	(([1-9] [1-9][0-9])\.\d{1}[0-9])\.\d{1}[0-9])	
Kind	Value	Annotation					
pattern	(([1-9] [1-9][0-9])\.\d{1}[0-9])\.\d{1}[0-9])						
annotation	documentation Facette zur Festlegung der Version der IRD-Spezifikation						
source	<pre>&lt;simpleType name="IrdSpezVersion"&gt;   &lt;annotation&gt;     &lt;documentation&gt;Facette zur Festlegung der Version der IRD-Spezifikation&lt;/documentation&gt;   &lt;/annotation&gt;   &lt;restriction base="xs:token"&gt;     &lt;pattern value="(([1-9] [1-9][0-9])\.\d{1}[0-9])\.\d{1}[0-9]"/&gt;   &lt;/restriction&gt; &lt;/simpleType&gt;</pre>						

	<code>&lt;/simpleType&gt;</code>
--	----------------------------------

### simpleType **JaLeer**

namespace	http://xml.ir-d.de/irdma						
type	restriction of <b>integer</b>						
properties	base xs:integer						
facets	<table border="1"> <tr> <th>Kind</th> <th>Value</th> <th>Annotation</th> </tr> <tr> <td>pattern</td> <td>(1)</td> <td></td> </tr> </table>	Kind	Value	Annotation	pattern	(1)	
Kind	Value	Annotation					
pattern	(1)						
annotation	documentation Facette zur Festlegung des Unbekannt-Wertes (Bedeutung 1=true)						
source	<pre> &lt;simpleType name="JaLeer"&gt;   &lt;annotation&gt;     &lt;documentation&gt;Facette zur Festlegung des Unbekannt-Wertes (Bedeutung 1=true)&lt;/documentation&gt;   &lt;/annotation&gt;   &lt;restriction base="xs:integer"&gt;     &lt;pattern value="(1)"/&gt;   &lt;/restriction&gt; &lt;/simpleType&gt;           </pre>						

### simpleType **Meldebestaetigung**

namespace	http://xml.ir-d.de/irdma						
type	restriction of <b>token</b>						
properties	base xs:token						
used by	element <a href="#">BestaetigungBasis/BEG Meldebestaetigung ID</a>						
facets	<table border="1"> <tr> <th>Kind</th> <th>Value</th> <th>Annotation</th> </tr> <tr> <td>length</td> <td>10</td> <td></td> </tr> </table>	Kind	Value	Annotation	length	10	
Kind	Value	Annotation					
length	10						
annotation	documentation Facette zur Festlegung der Meldebestätigungslaenge von 10 Zeichen						
source	<pre> &lt;simpleType name="Meldebestaetigung"&gt;   &lt;annotation&gt;     &lt;documentation&gt;Facette zur Festlegung der Meldebestätigungslaenge von 10 Zeichen&lt;/documentation&gt;   &lt;/annotation&gt;   &lt;restriction base="xs:token"&gt;     &lt;length value="10"/&gt;   &lt;/restriction&gt; &lt;/simpleType&gt;           </pre>						

### simpleType **OPS**

namespace	http://xml.ir-d.de/irdma						
type	restriction of <b>token</b>						
properties	base xs:token						
facets	<table border="1"> <tr> <th>Kind</th> <th>Value</th> <th>Annotation</th> </tr> <tr> <td>pattern</td> <td>((135689)\-(0-9){2}([a-zA-Z0-9]{1}\.([a-zA-Z0-9]{1,2}))*(:[RLBrIb])?)</td> <td></td> </tr> </table>	Kind	Value	Annotation	pattern	((135689)\-(0-9){2}([a-zA-Z0-9]{1}\.([a-zA-Z0-9]{1,2}))*(:[RLBrIb])?)	
Kind	Value	Annotation					
pattern	((135689)\-(0-9){2}([a-zA-Z0-9]{1}\.([a-zA-Z0-9]{1,2}))*(:[RLBrIb])?)						

annotation	documentation Facette zur Festlegung des Prozedurenschlüssels
source	<pre> &lt;simpleType name="OPS"&gt;   &lt;annotation&gt;     &lt;documentation&gt;Facette zur Festlegung des Prozedurenschlüssels&lt;/documentation&gt;   &lt;/annotation&gt;   &lt;restriction base="xs:token"&gt;     &lt;pattern value="([135689]\-([0-9]){2}([a-zA-Z0-9]){1}(\.([a-zA-Z0-9]{1,2}))*(:[RLBr1b]) ?)"&gt;     &lt;/restriction&gt;   &lt;/simpleType&gt; </pre>

### simpleType **String2**

namespace	http://xml.ir-d.de/irdma						
type	restriction of <b>token</b>						
properties	base xs:token						
facets	<table border="1"> <thead> <tr> <th>Kind</th> <th>Value</th> <th>Annotation</th> </tr> </thead> <tbody> <tr> <td>pattern</td> <td>([0-9]{2})</td> <td></td> </tr> </tbody> </table>	Kind	Value	Annotation	pattern	([0-9]{2})	
Kind	Value	Annotation					
pattern	([0-9]{2})						
annotation	documentation Facette zur Festlegung des kodierten Entlassungsgrundes						
source	<pre> &lt;simpleType name="String2"&gt;   &lt;annotation&gt;     &lt;documentation&gt;Facette zur Festlegung des kodierten Entlassungsgrundes&lt;/documentation&gt;   &lt;/annotation&gt;   &lt;restriction base="xs:token"&gt;     &lt;pattern value="([0-9]{2})" /&gt;   &lt;/restriction&gt; &lt;/simpleType&gt; </pre>						

### simpleType **String20**

namespace	http://xml.ir-d.de/irdma						
type	restriction of <b>token</b>						
properties	base xs:token						
facets	<table border="1"> <thead> <tr> <th>Kind</th> <th>Value</th> <th>Annotation</th> </tr> </thead> <tbody> <tr> <td>maxLength</td> <td>20</td> <td></td> </tr> </tbody> </table>	Kind	Value	Annotation	maxLength	20	
Kind	Value	Annotation					
maxLength	20						
annotation	documentation Facette zur Festlegung von: Artikel-, Ident-, Serien-, Lot-Nummer des Produkts						
source	<pre> &lt;simpleType name="String20"&gt;   &lt;annotation&gt;     &lt;documentation&gt;Facette zur Festlegung von: Artikel-, Ident-, Serien-, Lot-Nummer des Produkts&lt;/documentation&gt;   &lt;/annotation&gt;   &lt;restriction base="xs:token"&gt;     &lt;maxLength value="20" /&gt;   &lt;/restriction&gt; &lt;/simpleType&gt; </pre>						

### simpleType Sw

namespace	http://xml.ir-d.de/irdma						
type	restriction of <b>token</b>						
properties	base xs:token						
facets	<table border="1"> <thead> <tr> <th>Kind</th> <th>Value</th> <th>Annotation</th> </tr> </thead> <tbody> <tr> <td>maxLength</td> <td>120</td> <td></td> </tr> </tbody> </table>	Kind	Value	Annotation	maxLength	120	
Kind	Value	Annotation					
maxLength	120						
annotation	documentation Facette für Merkmale der externen Software						
source	<pre> &lt;simpleType name="Sw"&gt;   &lt;annotation&gt;     &lt;documentation&gt;Facette für Merkmale der externen Software&lt;/documentation&gt;   &lt;/annotation&gt;   &lt;restriction base="xs:token"&gt;     &lt;maxLength value="120"/&gt;   &lt;/restriction&gt; &lt;/simpleType&gt;           </pre>						

### simpleType Transfervummer

namespace	http://xml.ir-d.de/irdma						
type	restriction of <b>token</b>						
properties	base xs:token						
used by	element <a href="#">MeldungIrdFallBasis/FAL Transfervummer</a>						
facets	<table border="1"> <thead> <tr> <th>Kind</th> <th>Value</th> <th>Annotation</th> </tr> </thead> <tbody> <tr> <td>pattern</td> <td>([a-z0-9]{64})</td> <td></td> </tr> </tbody> </table>	Kind	Value	Annotation	pattern	([a-z0-9]{64})	
Kind	Value	Annotation					
pattern	([a-z0-9]{64})						
annotation	documentation Facette zur Festlegung der Transfervummer						
source	<pre> &lt;simpleType name="Transfervummer"&gt;   &lt;annotation&gt;     &lt;documentation&gt;Facette zur Festlegung der Transfervummer&lt;/documentation&gt;   &lt;/annotation&gt;   &lt;restriction base="xs:token"&gt;     &lt;pattern value="([a-z0-9]{64})"/&gt;   &lt;/restriction&gt; &lt;/simpleType&gt;           </pre>						

### simpleType Versionsnummer

namespace	http://xml.ir-d.de/irdma						
type	restriction of <b>token</b>						
properties	base xs:token						
facets	<table border="1"> <thead> <tr> <th>Kind</th> <th>Value</th> <th>Annotation</th> </tr> </thead> <tbody> <tr> <td>maxLength</td> <td>10</td> <td></td> </tr> </tbody> </table>	Kind	Value	Annotation	maxLength	10	
Kind	Value	Annotation					
maxLength	10						
annotation	documentation Facette zur Festlegung der Versionsnummer des gelieferten Datensatzes						
source	<pre> &lt;simpleType name="Versionsnummer"&gt;   &lt;annotation&gt;     &lt;documentation&gt;Facette zur Festlegung der Versionsnummer des gelieferten Datensatzes&lt;/documentation&gt;   &lt;/annotation&gt;   &lt;restriction base="xs:token"&gt;     &lt;maxLength value="10"/&gt;   &lt;/restriction&gt; &lt;/simpleType&gt;           </pre>						

	<pre> &lt;/annotation&gt; &lt;restriction base="xs:token"&gt;   &lt;maxLength value="10"/&gt; &lt;/restriction&gt; &lt;/simpleType&gt; </pre>
--	---

### simpleType **Zahl1**

namespace	http://xml.ir-d.de/irdma									
type	restriction of <b>positivelnteger</b>									
properties	base xs:positivelnteger									
facets	<table border="1"> <thead> <tr> <th>Kind</th> <th>Value</th> <th>Annotation</th> </tr> </thead> <tbody> <tr> <td>minInclusive</td> <td>1</td> <td></td> </tr> <tr> <td>maxInclusive</td> <td>9</td> <td></td> </tr> </tbody> </table>	Kind	Value	Annotation	minInclusive	1		maxInclusive	9	
Kind	Value	Annotation								
minInclusive	1									
maxInclusive	9									
annotation	documentation Facette zur Festlegung der 1-stelligen Ganzzahlenwerte									
source	<pre> &lt;simpleType name="Zahl1"&gt;   &lt;annotation&gt;     &lt;documentation&gt;Facette zur Festlegung der 1-stelligen Ganzzahlenwerte&lt;/documentation&gt;   &lt;/annotation&gt;   &lt;restriction base="xs:positiveInteger"&gt;     &lt;minInclusive value="1"/&gt;     &lt;maxInclusive value="9"/&gt;   &lt;/restriction&gt; &lt;/simpleType&gt; </pre>									

### simpleType **Zahl1\_1**

namespace	http://xml.ir-d.de/irdma															
type	restriction of <b>decimal</b>															
properties	base xs:decimal															
facets	<table border="1"> <thead> <tr> <th>Kind</th> <th>Value</th> <th>Annotation</th> </tr> </thead> <tbody> <tr> <td>minInclusive</td> <td>0.1</td> <td></td> </tr> <tr> <td>maxInclusive</td> <td>9.9</td> <td></td> </tr> <tr> <td>totalDigits</td> <td>2</td> <td></td> </tr> <tr> <td>fractionDigits</td> <td>1</td> <td></td> </tr> </tbody> </table>	Kind	Value	Annotation	minInclusive	0.1		maxInclusive	9.9		totalDigits	2		fractionDigits	1	
Kind	Value	Annotation														
minInclusive	0.1															
maxInclusive	9.9															
totalDigits	2															
fractionDigits	1															
annotation	documentation Facette zur Festlegung des Formats [N].[N]															
source	<pre> &lt;simpleType name="Zahl1_1"&gt;   &lt;annotation&gt;     &lt;documentation&gt;Facette zur Festlegung des Formats [N].[N]&lt;/documentation&gt;   &lt;/annotation&gt;   &lt;restriction base="xs:decimal"&gt;     &lt;totalDigits value="2"/&gt;     &lt;fractionDigits value="1"/&gt;     &lt;minInclusive value="0.1"/&gt;     &lt;maxInclusive value="9.9"/&gt;   &lt;/restriction&gt; &lt;/simpleType&gt; </pre>															

### simpleType Zahl2

namespace	http://xml.ir-d.de/irdma									
type	restriction of <b>positiveInteger</b>									
properties	base xs:positiveInteger									
facets	<table><thead><tr><th>Kind</th><th>Value</th><th>Annotation</th></tr></thead><tbody><tr><td>minInclusive</td><td>1</td><td></td></tr><tr><td>maxInclusive</td><td>99</td><td></td></tr></tbody></table>	Kind	Value	Annotation	minInclusive	1		maxInclusive	99	
Kind	Value	Annotation								
minInclusive	1									
maxInclusive	99									
annotation	documentation Facette zur Festlegung der 2-stelligen Ganzzahlenwerte									
source	<pre>&lt;simpleType name="Zahl2"&gt;   &lt;annotation&gt;     &lt;documentation&gt;Facette zur Festlegung der 2-stelligen Ganzzahlenwerte&lt;/documentation&gt;   &lt;/annotation&gt;   &lt;restriction base="xs:positiveInteger"&gt;     &lt;minInclusive value="1"/&gt;     &lt;maxInclusive value="99"/&gt;   &lt;/restriction&gt; &lt;/simpleType&gt;</pre>									

### simpleType Zahl2\_1

namespace	http://xml.ir-d.de/irdma															
type	restriction of <b>decimal</b>															
properties	base xs:decimal															
facets	<table><thead><tr><th>Kind</th><th>Value</th><th>Annotation</th></tr></thead><tbody><tr><td>minInclusive</td><td>0.1</td><td></td></tr><tr><td>maxInclusive</td><td>99.9</td><td></td></tr><tr><td>totalDigits</td><td>3</td><td></td></tr><tr><td>fractionDigits</td><td>1</td><td></td></tr></tbody></table>	Kind	Value	Annotation	minInclusive	0.1		maxInclusive	99.9		totalDigits	3		fractionDigits	1	
Kind	Value	Annotation														
minInclusive	0.1															
maxInclusive	99.9															
totalDigits	3															
fractionDigits	1															
annotation	documentation Facette zur Festlegung des Formats [NN].[N]															
source	<pre>&lt;simpleType name="Zahl2_1"&gt;   &lt;annotation&gt;     &lt;documentation&gt;Facette zur Festlegung des Formats [NN].[N]&lt;/documentation&gt;   &lt;/annotation&gt;   &lt;restriction base="xs:decimal"&gt;     &lt;totalDigits value="3"/&gt;     &lt;fractionDigits value="1"/&gt;     &lt;minInclusive value="0.1"/&gt;     &lt;maxInclusive value="99.9"/&gt;   &lt;/restriction&gt; &lt;/simpleType&gt;</pre>															

### simpleType Zahl3

namespace	http://xml.ir-d.de/irdma
type	restriction of <b>positiveInteger</b>
properties	base xs:positiveInteger

facets	<table border="1"> <thead> <tr> <th>Kind</th> <th>Value</th> <th>Annotation</th> </tr> </thead> <tbody> <tr> <td>minInclusive</td> <td>1</td> <td></td> </tr> <tr> <td>maxInclusive</td> <td>999</td> <td></td> </tr> </tbody> </table>	Kind	Value	Annotation	minInclusive	1		maxInclusive	999	
Kind	Value	Annotation								
minInclusive	1									
maxInclusive	999									
annotation	documentation Facette zur Festlegung der 3-stelligen Ganzzahlenwerte									
source	<pre>&lt;simpleType name="Zahl3"&gt;   &lt;annotation&gt;     &lt;documentation&gt;Facette zur Festlegung der 3-stelligen     Ganzzahlenwerte&lt;/documentation&gt;   &lt;/annotation&gt;   &lt;restriction base="xs:positiveInteger"&gt;     &lt;minInclusive value="1"/&gt;     &lt;maxInclusive value="999"/&gt;   &lt;/restriction&gt; &lt;/simpleType&gt;</pre>									

### simpleType **Zahl3\_1**

namespace	http://xml.ir-d.de/irdma															
type	restriction of <b>decimal</b>															
properties	base xs:decimal															
facets	<table border="1"> <thead> <tr> <th>Kind</th> <th>Value</th> <th>Annotation</th> </tr> </thead> <tbody> <tr> <td>minInclusive</td> <td>0.1</td> <td></td> </tr> <tr> <td>maxInclusive</td> <td>999.9</td> <td></td> </tr> <tr> <td>totalDigits</td> <td>4</td> <td></td> </tr> <tr> <td>fractionDigits</td> <td>1</td> <td></td> </tr> </tbody> </table>	Kind	Value	Annotation	minInclusive	0.1		maxInclusive	999.9		totalDigits	4		fractionDigits	1	
Kind	Value	Annotation														
minInclusive	0.1															
maxInclusive	999.9															
totalDigits	4															
fractionDigits	1															
annotation	documentation Facette zur Festlegung des Formats [NNN].[N]															
source	<pre>&lt;simpleType name="Zahl3_1"&gt;   &lt;annotation&gt;     &lt;documentation&gt;Facette zur Festlegung des Formats [NNN].[N]&lt;/documentation&gt;   &lt;/annotation&gt;   &lt;restriction base="xs:decimal"&gt;     &lt;totalDigits value="4"/&gt;     &lt;fractionDigits value="1"/&gt;     &lt;minInclusive value="0.1"/&gt;     &lt;maxInclusive value="999.9"/&gt;   &lt;/restriction&gt; &lt;/simpleType&gt;</pre>															

### simpleType **Zahl4**

namespace	http://xml.ir-d.de/irdma									
type	restriction of <b>positiveInteger</b>									
properties	base xs:positiveInteger									
facets	<table border="1"> <thead> <tr> <th>Kind</th> <th>Value</th> <th>Annotation</th> </tr> </thead> <tbody> <tr> <td>minInclusive</td> <td>1</td> <td></td> </tr> <tr> <td>maxInclusive</td> <td>9999</td> <td></td> </tr> </tbody> </table>	Kind	Value	Annotation	minInclusive	1		maxInclusive	9999	
Kind	Value	Annotation								
minInclusive	1									
maxInclusive	9999									
annotation	documentation Facette zur Festlegung der 4-stelligen Ganzzahlenwerte									
source	<pre>&lt;simpleType name="Zahl4"&gt;   &lt;annotation&gt;</pre>									



	<pre> &lt;documentation&gt;Facette zur Festlegung der 4-stelligen Ganzzahlenwerte&lt;/documentation&gt; &lt;/annotation&gt; &lt;restriction base="xs:positiveInteger"&gt;   &lt;minInclusive value="1"/&gt;   &lt;maxInclusive value="9999"/&gt; &lt;/restriction&gt; &lt;/simpleType&gt; </pre>
--	--

### simpleType **Zahl5**

namespace	http://xml.ir-d.de/irdma									
type	restriction of <b>positiveInteger</b>									
properties	base xs:positiveInteger									
facets	<table border="1"> <thead> <tr> <th>Kind</th> <th>Value</th> <th>Annotation</th> </tr> </thead> <tbody> <tr> <td>minInclusive</td> <td>1</td> <td></td> </tr> <tr> <td>maxInclusive</td> <td>99999</td> <td></td> </tr> </tbody> </table>	Kind	Value	Annotation	minInclusive	1		maxInclusive	99999	
Kind	Value	Annotation								
minInclusive	1									
maxInclusive	99999									
annotation	documentation Facette zur Festlegung der 5-stelligen Ganzzahlenwerte									
source	<pre> &lt;simpleType name="Zahl5"&gt;   &lt;annotation&gt;     &lt;documentation&gt;Facette zur Festlegung der 5-stelligen Ganzzahlenwerte&lt;/documentation&gt;   &lt;/annotation&gt;   &lt;restriction base="xs:positiveInteger"&gt;     &lt;minInclusive value="1"/&gt;     &lt;maxInclusive value="99999"/&gt;   &lt;/restriction&gt; &lt;/simpleType&gt; </pre>									

### simpleType **Zahl5mitNull**

namespace	http://xml.ir-d.de/irdma									
type	restriction of <b>integer</b>									
properties	base xs:integer									
facets	<table border="1"> <thead> <tr> <th>Kind</th> <th>Value</th> <th>Annotation</th> </tr> </thead> <tbody> <tr> <td>minInclusive</td> <td>0</td> <td></td> </tr> <tr> <td>maxInclusive</td> <td>99999</td> <td></td> </tr> </tbody> </table>	Kind	Value	Annotation	minInclusive	0		maxInclusive	99999	
Kind	Value	Annotation								
minInclusive	0									
maxInclusive	99999									
annotation	documentation Facette zur Festlegung der 5-stelligen Ganzzahlenwerte inklusive "0"									
source	<pre> &lt;simpleType name="Zahl5mitNull"&gt;   &lt;annotation&gt;     &lt;documentation&gt;Facette zur Festlegung der 5-stelligen Ganzzahlenwerte inklusive "0"&lt;/documentation&gt;   &lt;/annotation&gt;   &lt;restriction base="xs:integer"&gt;     &lt;minInclusive value="0"/&gt;     &lt;maxInclusive value="99999"/&gt;   &lt;/restriction&gt; &lt;/simpleType&gt; </pre>									

### complexType MeldungIrdBasis

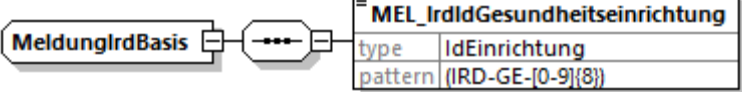
diagram	 <p>The diagram shows a complex type 'MeldungIrdBasis' containing a sequence of one 'MEL_IrdIdGesundheitseinrichtung' element. The 'MEL_IrdIdGesundheitseinrichtung' element is further detailed with a table: type 'IdEinrichtung' and pattern '(IRD-GE-[0-9]{8})'.</p>
namespace	http://xml.ir-d.de/irdma
children	<a href="#">MEL_IrdIdGesundheitseinrichtung</a>
used by	complexType <a href="#">MeldungIrd</a>
source	<pre>&lt;complexType name="MeldungIrdBasis"&gt;   &lt;sequence&gt;     &lt;element name="MEL_IrdIdGesundheitseinrichtung" type="IdEinrichtung"/&gt;   &lt;/sequence&gt; &lt;/complexType&gt;</pre>

### element MeldungIrdBasis/MEL\_IrdIdGesundheitseinrichtung

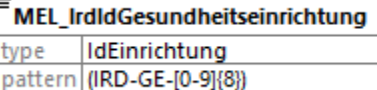
diagram	 <p>The diagram shows the 'MEL_IrdIdGesundheitseinrichtung' element with a table: type 'IdEinrichtung' and pattern '(IRD-GE-[0-9]{8})'.</p>						
type	<a href="#">IdEinrichtung</a>						
properties	content simple						
facets	<table border="1"> <thead> <tr> <th>Kind</th> <th>Value</th> <th>Annotation</th> </tr> </thead> <tbody> <tr> <td>pattern</td> <td>(IRD-GE-[0-9]{8})</td> <td></td> </tr> </tbody> </table>	Kind	Value	Annotation	pattern	(IRD-GE-[0-9]{8})	
Kind	Value	Annotation					
pattern	(IRD-GE-[0-9]{8})						
source	<pre>&lt;element name="MEL_IrdIdGesundheitseinrichtung" type="IdEinrichtung"/&gt;</pre>						

### complexType MeldungIrdFallBasis

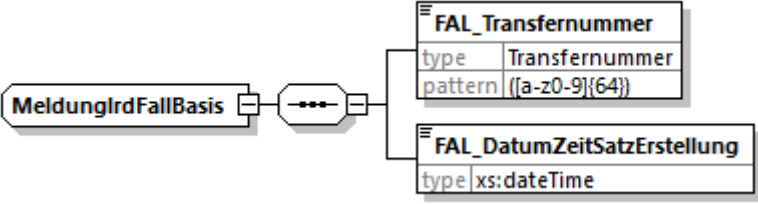
diagram	 <p>The diagram shows a complex type 'MeldungIrdFallBasis' containing a sequence of two elements: 'FAL_Transfernummer' and 'FAL_DatumZeitSatzErstellung'. The 'FAL_Transfernummer' element is detailed with a table: type 'Transfervummer' and pattern '([a-z0-9]{64})'. The 'FAL_DatumZeitSatzErstellung' element is detailed with a table: type 'xs:dateTime'.</p>
namespace	http://xml.ir-d.de/irdma
children	<a href="#">FAL_Transfernummer</a> <a href="#">FAL_DatumZeitSatzErstellung</a>
used by	element <a href="#">MeldungIrd/fall</a>
source	<pre>&lt;complexType name="MeldungIrdFallBasis"&gt;   &lt;sequence&gt;     &lt;element name="FAL_Transfernummer" type="Transfervummer"/&gt;     &lt;element name="FAL_DatumZeitSatzErstellung" type="xs:dateTime"/&gt;   &lt;/sequence&gt; &lt;/complexType&gt;</pre>

### element MeldungIrdFallBasis/FAL\_Transfernummer

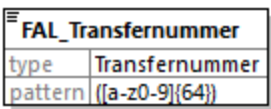
diagram	
type	<a href="#">Transfernummer</a>
properties	content simple
facets	Kind Value Annotation pattern ([a-z0-9]{64})
source	<code>&lt;element name="FAL_Transfernummer" type="Transfernummer"/&gt;</code>

### element MeldungIrdFallBasis/FAL\_DatumZeitSatzErstellung

diagram	
type	<b>dateTime</b>
properties	content simple
source	<code>&lt;element name="FAL_DatumZeitSatzErstellung" type="xs:dateTime"/&gt;</code>

### simpleType DatumText

namespace	http://xml.ir-d.de/irdsa
type	restriction of <b>token</b>
properties	base xs:token
facets	Kind Value Annotation pattern ((([0-9]{4})([0-9]{2})?)([0-9]{2})?)
annotation	documentation Facette zur Festlegung des freien Datumformats: JJJJ[-MM[-TT]]
source	<pre>&lt;simpleType name="DatumText"&gt;   &lt;annotation&gt;     &lt;documentation&gt;Facette zur Festlegung des freien Datumformats:     JJJJ[-MM[-TT]]&lt;/documentation&gt;   &lt;/annotation&gt;   &lt;restriction base="xs:token"&gt;     &lt;pattern value="((([0-9]{4})([0-9]{2})?)([0-9]{2})?)"/&gt;   &lt;/restriction&gt; &lt;/simpleType&gt;</pre>

### simpleType Freitext250

namespace	http://xml.ir-d.de/irdsa
type	restriction of <b>token</b>
properties	base xs:token
used by	element <a href="#">EmpfangsbestaetigungBasis/EBG_Empfangsbestaetigung</a>
facets	Kind Value Annotation maxLength 250

annotation	documentation Facette zur Festlegung des Freitextes von 250 Zeichen
source	<pre>&lt;simpleType name="Freitext250"&gt;   &lt;annotation&gt;     &lt;documentation&gt;Facette zur Festlegung des Freitextes von 250 Zeichen&lt;/documentation&gt;   &lt;/annotation&gt;   &lt;restriction base="xs:token"&gt;     &lt;maxLength value="250"/&gt;   &lt;/restriction&gt; &lt;/simpleType&gt;</pre>

### simpleType **Freitext500**

namespace	http://xml.ir-d.de/irdsa						
type	restriction of <b>token</b>						
properties	base xs:token						
used by	elements <a href="#">HinweisBasis/HNW Datenelement</a> <a href="#">HinweisBasis/HNW Meldung</a> <a href="#">HinweisBasis/HNW Wert</a>						
facets	<table border="1"> <thead> <tr> <th>Kind</th> <th>Value</th> <th>Annotation</th> </tr> </thead> <tbody> <tr> <td>maxLength</td> <td>500</td> <td></td> </tr> </tbody> </table>	Kind	Value	Annotation	maxLength	500	
Kind	Value	Annotation					
maxLength	500						
annotation	documentation Facette zur Festlegung des Freitextes von 500 Zeichen						
source	<pre>&lt;simpleType name="Freitext500"&gt;   &lt;annotation&gt;     &lt;documentation&gt;Facette zur Festlegung des Freitextes von 500 Zeichen&lt;/documentation&gt;   &lt;/annotation&gt;   &lt;restriction base="xs:token"&gt;     &lt;maxLength value="500"/&gt;   &lt;/restriction&gt; &lt;/simpleType&gt;</pre>						

### simpleType **HashString**

namespace	http://xml.ir-d.de/irdsa						
type	restriction of <b>token</b>						
properties	base xs:token						
facets	<table border="1"> <thead> <tr> <th>Kind</th> <th>Value</th> <th>Annotation</th> </tr> </thead> <tbody> <tr> <td>maxLength</td> <td>512</td> <td></td> </tr> </tbody> </table>	Kind	Value	Annotation	maxLength	512	
Kind	Value	Annotation					
maxLength	512						
annotation	documentation Facette zur Festlegung des Hash-Strings der Meldebestätigung						
source	<pre>&lt;simpleType name="HashString"&gt;   &lt;annotation&gt;     &lt;documentation&gt;Facette zur Festlegung des Hash-Strings der Meldebestätigung&lt;/documentation&gt;   &lt;/annotation&gt;   &lt;restriction base="xs:token"&gt;     &lt;maxLength value="512"/&gt;   &lt;/restriction&gt; &lt;/simpleType&gt;</pre>						

### simpleType HashWert

namespace	http://xml.ir-d.de/irdsa						
type	restriction of <b>token</b>						
properties	base xs:token						
facets	<table border="1"> <thead> <tr> <th>Kind</th> <th>Value</th> <th>Annotation</th> </tr> </thead> <tbody> <tr> <td>length</td> <td>64</td> <td></td> </tr> </tbody> </table>	Kind	Value	Annotation	length	64	
Kind	Value	Annotation					
length	64						
annotation	documentation Facette zur Festlegung des Hashwertes der Meldebestätigung						
source	<pre>&lt;simpleType name="HashWert"&gt;   &lt;annotation&gt;     &lt;documentation&gt;Facette zur Festlegung des Hashwertes der Meldebestätigung&lt;/documentation&gt;   &lt;/annotation&gt;   &lt;restriction base="xs:token"&gt;     &lt;length value="64"/&gt;   &lt;/restriction&gt; &lt;/simpleType&gt;</pre>						

### simpleType ICD

namespace	http://xml.ir-d.de/irdsa						
type	restriction of <b>token</b>						
properties	base xs:token						
facets	<table border="1"> <thead> <tr> <th>Kind</th> <th>Value</th> <th>Annotation</th> </tr> </thead> <tbody> <tr> <td>pattern</td> <td>([a-zA-Z][0-9]{2}(\.[0-9]{1,2})?(:[RLB])?)</td> <td></td> </tr> </tbody> </table>	Kind	Value	Annotation	pattern	([a-zA-Z][0-9]{2}(\.[0-9]{1,2})?(:[RLB])?)	
Kind	Value	Annotation					
pattern	([a-zA-Z][0-9]{2}(\.[0-9]{1,2})?(:[RLB])?)						
annotation	documentation Facette zur Festlegung des ICD Code						
source	<pre>&lt;simpleType name="ICD"&gt;   &lt;annotation&gt;     &lt;documentation&gt;Facette zur Festlegung des ICD Code&lt;/documentation&gt;   &lt;/annotation&gt;   &lt;restriction base="xs:token"&gt;     &lt;pattern value="([a-zA-Z][0-9]{2}(\.[0-9]{1,2})?(:[RLB])?)"/&gt;   &lt;/restriction&gt; &lt;/simpleType&gt;</pre>						

### simpleType IdEinrichtung

namespace	http://xml.ir-d.de/irdsa						
type	restriction of <b>token</b>						
properties	base xs:token						
used by	element <a href="#">MeldungIrdBasis/MEL_IrdIdGesundheitseinrichtung</a>						
facets	<table border="1"> <thead> <tr> <th>Kind</th> <th>Value</th> <th>Annotation</th> </tr> </thead> <tbody> <tr> <td>pattern</td> <td>(IRD-GE-[0-9](8))</td> <td></td> </tr> </tbody> </table>	Kind	Value	Annotation	pattern	(IRD-GE-[0-9](8))	
Kind	Value	Annotation					
pattern	(IRD-GE-[0-9](8))						
annotation	documentation Facette zur Festlegung der Gesundheitseinrichtung-ID						
source	<pre>&lt;simpleType name="IdEinrichtung"&gt;   &lt;annotation&gt;     &lt;documentation&gt;Facette zur Festlegung der</pre>						

	<pre> Gesundheitseinrichtung-ID&lt;/documentation&gt; &lt;/annotation&gt; &lt;restriction base="xs:token"&gt;   &lt;pattern value="(IRD-GE-[0-9]{8})"/&gt; &lt;/restriction&gt; &lt;/simpleType&gt; </pre>
--	--

### simpleType IrdArtikelId

namespace	http://xml.ir-d.de/irdsa						
type	restriction of <b>token</b>						
properties	base xs:token						
facets	<table border="1"> <thead> <tr> <th>Kind</th> <th>Value</th> <th>Annotation</th> </tr> </thead> <tbody> <tr> <td>maxLength</td> <td>16</td> <td></td> </tr> </tbody> </table>	Kind	Value	Annotation	maxLength	16	
Kind	Value	Annotation					
maxLength	16						
annotation	documentation Facette zur Festlegung der IrdNummer						
source	<pre> &lt;simpleType name="IrdArtikelId"&gt;   &lt;annotation&gt;     &lt;documentation&gt;Facette zur Festlegung der IrdNummer&lt;/documentation&gt;   &lt;/annotation&gt;   &lt;restriction base="xs:token"&gt;     &lt;maxLength value="16"/&gt;   &lt;/restriction&gt; &lt;/simpleType&gt; </pre>						

### simpleType IrdSpezVersion

namespace	http://xml.ir-d.de/irdsa						
type	restriction of <b>token</b>						
properties	base xs:token						
facets	<table border="1"> <thead> <tr> <th>Kind</th> <th>Value</th> <th>Annotation</th> </tr> </thead> <tbody> <tr> <td>pattern</td> <td>(([1-9] [1-9][0-9])\.\d{1}[0-9])\.\d{1}[0-9])</td> <td></td> </tr> </tbody> </table>	Kind	Value	Annotation	pattern	(([1-9] [1-9][0-9])\.\d{1}[0-9])\.\d{1}[0-9])	
Kind	Value	Annotation					
pattern	(([1-9] [1-9][0-9])\.\d{1}[0-9])\.\d{1}[0-9])						
annotation	documentation Facette zur Festlegung der Version der IRD-Spezifikation						
source	<pre> &lt;simpleType name="IrdSpezVersion"&gt;   &lt;annotation&gt;     &lt;documentation&gt;Facette zur Festlegung der Version der IRD-Spezifikation&lt;/documentation&gt;   &lt;/annotation&gt;   &lt;restriction base="xs:token"&gt;     &lt;pattern value="(([1-9] [1-9][0-9])\.\d{1}[0-9])\.\d{1}[0-9]"/&gt;   &lt;/restriction&gt; &lt;/simpleType&gt; </pre>						

### simpleType JaLeer

namespace	http://xml.ir-d.de/irdsa			
type	restriction of <b>integer</b>			
properties	base xs:integer			
facets	<table border="1"> <thead> <tr> <th>Kind</th> <th>Value</th> <th>Annotation</th> </tr> </thead> <tbody> </tbody> </table>	Kind	Value	Annotation
Kind	Value	Annotation		

	pattern (1)
annotation	documentation Facette zur Festlegung des Unbekannt-Wertes (Bedeutung 1=true)
source	<pre>&lt;simpleType name="JaLeer"&gt;   &lt;annotation&gt;     &lt;documentation&gt;Facette zur Festlegung des Unbekannt-Wertes (Bedeutung 1=true)&lt;/documentation&gt;   &lt;/annotation&gt;   &lt;restriction base="xs:integer"&gt;     &lt;pattern value="(1)"/&gt;   &lt;/restriction&gt; &lt;/simpleType&gt;</pre>

### simpleType **Meldebestaetigung**

namespace	http://xml.ir-d.de/irdsa						
type	restriction of <b>token</b>						
properties	base xs:token						
facets	<table border="1"> <thead> <tr> <th>Kind</th> <th>Value</th> <th>Annotation</th> </tr> </thead> <tbody> <tr> <td>length</td> <td>10</td> <td></td> </tr> </tbody> </table>	Kind	Value	Annotation	length	10	
Kind	Value	Annotation					
length	10						
annotation	documentation Facette zur Festlegung der Meldebestätigungslaenge von 10 Zeichen						
source	<pre>&lt;simpleType name="Meldebestaetigung"&gt;   &lt;annotation&gt;     &lt;documentation&gt;Facette zur Festlegung der Meldebestätigungslaenge von 10 Zeichen&lt;/documentation&gt;   &lt;/annotation&gt;   &lt;restriction base="xs:token"&gt;     &lt;length value="10"/&gt;   &lt;/restriction&gt; &lt;/simpleType&gt;</pre>						

### simpleType **OPS**

namespace	http://xml.ir-d.de/irdsa						
type	restriction of <b>token</b>						
properties	base xs:token						
facets	<table border="1"> <thead> <tr> <th>Kind</th> <th>Value</th> <th>Annotation</th> </tr> </thead> <tbody> <tr> <td>pattern</td> <td>((135689)\-([0-9]){2}([a-zA-Z0-9]){1}\.([a-zA-Z0-9]{1,2}))*(:[RLBr1b])?</td> <td></td> </tr> </tbody> </table>	Kind	Value	Annotation	pattern	((135689)\-([0-9]){2}([a-zA-Z0-9]){1}\.([a-zA-Z0-9]{1,2}))*(:[RLBr1b])?	
Kind	Value	Annotation					
pattern	((135689)\-([0-9]){2}([a-zA-Z0-9]){1}\.([a-zA-Z0-9]{1,2}))*(:[RLBr1b])?						
annotation	documentation Facette zur Festlegung des Prozedurenschlüssels						
source	<pre>&lt;simpleType name="OPS"&gt;   &lt;annotation&gt;     &lt;documentation&gt;Facette zur Festlegung des Prozedurenschlüssels&lt;/documentation&gt;   &lt;/annotation&gt;   &lt;restriction base="xs:token"&gt;     &lt;pattern value="((135689)\-([0-9]){2}([a-zA-Z0-9]){1}\.([a-zA-Z0-9]{1,2}))*(:[RLBr1b])?" /&gt;   &lt;/restriction&gt;</pre>						

	<code>&lt;/simpleType&gt;</code>
--	----------------------------------

### simpleType **String2**

namespace	http://xml.ir-d.de/irdsa						
type	restriction of <b>token</b>						
properties	base xs:token						
facets	<table border="1"> <thead> <tr> <th>Kind</th> <th>Value</th> <th>Annotation</th> </tr> </thead> <tbody> <tr> <td>pattern</td> <td>([0-9]{2})</td> <td></td> </tr> </tbody> </table>	Kind	Value	Annotation	pattern	([0-9]{2})	
Kind	Value	Annotation					
pattern	([0-9]{2})						
annotation	documentation Facette zur Festlegung des kodierten Entlassungsgrundes						
source	<pre>&lt;simpleType name="String2"&gt;   &lt;annotation&gt;     &lt;documentation&gt;Facette zur Festlegung des kodierten Entlassungsgrundes&lt;/documentation&gt;   &lt;/annotation&gt;   &lt;restriction base="xs:token"&gt;     &lt;pattern value="([0-9]{2})"/&gt;   &lt;/restriction&gt; &lt;/simpleType&gt;</pre>						

### simpleType **String20**

namespace	http://xml.ir-d.de/irdsa						
type	restriction of <b>token</b>						
properties	base xs:token						
facets	<table border="1"> <thead> <tr> <th>Kind</th> <th>Value</th> <th>Annotation</th> </tr> </thead> <tbody> <tr> <td>maxLength</td> <td>20</td> <td></td> </tr> </tbody> </table>	Kind	Value	Annotation	maxLength	20	
Kind	Value	Annotation					
maxLength	20						
annotation	documentation Facette zur Festlegung von: Artikel-, Ident-, Serien-, Lot-Nummer des Produkts						
source	<pre>&lt;simpleType name="String20"&gt;   &lt;annotation&gt;     &lt;documentation&gt;Facette zur Festlegung von: Artikel-, Ident-, Serien-, Lot-Nummer des Produkts&lt;/documentation&gt;   &lt;/annotation&gt;   &lt;restriction base="xs:token"&gt;     &lt;maxLength value="20"/&gt;   &lt;/restriction&gt; &lt;/simpleType&gt;</pre>						

### simpleType **Sw**

namespace	http://xml.ir-d.de/irdsa						
type	restriction of <b>token</b>						
properties	base xs:token						
facets	<table border="1"> <thead> <tr> <th>Kind</th> <th>Value</th> <th>Annotation</th> </tr> </thead> <tbody> <tr> <td>maxLength</td> <td>120</td> <td></td> </tr> </tbody> </table>	Kind	Value	Annotation	maxLength	120	
Kind	Value	Annotation					
maxLength	120						
annotation	documentation Facette für Merkmale der externen Software						
source	<pre>&lt;simpleType name="Sw"&gt;</pre>						



	<pre> &lt;annotation&gt;   &lt;documentation&gt;Facette für Merkmale der externen Software&lt;/documentation&gt; &lt;/annotation&gt; &lt;restriction base="xs:token"&gt;   &lt;maxLength value="120"/&gt; &lt;/restriction&gt; &lt;/simpleType&gt; </pre>
--	---

### simpleType **Transfervummer**

namespace	http://xml.ir-d.de/irdsa						
type	restriction of <b>token</b>						
properties	base xs:token						
used by	element <a href="#">StornoFallBasis/FAL Transfervummer</a>						
facets	<table border="1"> <thead> <tr> <th>Kind</th> <th>Value</th> <th>Annotation</th> </tr> </thead> <tbody> <tr> <td>pattern</td> <td>([a-z0-9]{64})</td> <td></td> </tr> </tbody> </table>	Kind	Value	Annotation	pattern	([a-z0-9]{64})	
Kind	Value	Annotation					
pattern	([a-z0-9]{64})						
annotation	documentation Facette zur Festlegung der Transfervummer						
source	<pre> &lt;simpleType name="Transfervummer"&gt;   &lt;annotation&gt;     &lt;documentation&gt;Facette zur Festlegung der Transfervummer&lt;/documentation&gt;   &lt;/annotation&gt;   &lt;restriction base="xs:token"&gt;     &lt;pattern value="([a-z0-9]{64})"/&gt;   &lt;/restriction&gt; &lt;/simpleType&gt; </pre>						

### simpleType **Versionsnummer**

namespace	http://xml.ir-d.de/irdsa						
type	restriction of <b>token</b>						
properties	base xs:token						
facets	<table border="1"> <thead> <tr> <th>Kind</th> <th>Value</th> <th>Annotation</th> </tr> </thead> <tbody> <tr> <td>maxLength</td> <td>10</td> <td></td> </tr> </tbody> </table>	Kind	Value	Annotation	maxLength	10	
Kind	Value	Annotation					
maxLength	10						
annotation	documentation Facette zur Festlegung der Versionsnummer des gelieferten Datensatzes						
source	<pre> &lt;simpleType name="Versionsnummer"&gt;   &lt;annotation&gt;     &lt;documentation&gt;Facette zur Festlegung der Versionsnummer des gelieferten     Datensatzes&lt;/documentation&gt;   &lt;/annotation&gt;   &lt;restriction base="xs:token"&gt;     &lt;maxLength value="10"/&gt;   &lt;/restriction&gt; &lt;/simpleType&gt; </pre>						

### simpleType **Zahl1**

namespace	http://xml.ir-d.de/irdsa
type	restriction of <b>positivelnteger</b>

properties	base xs:positiveInteger									
facets	<table border="1"> <thead> <tr> <th>Kind</th> <th>Value</th> <th>Annotation</th> </tr> </thead> <tbody> <tr> <td>minInclusive</td> <td>1</td> <td></td> </tr> <tr> <td>maxInclusive</td> <td>9</td> <td></td> </tr> </tbody> </table>	Kind	Value	Annotation	minInclusive	1		maxInclusive	9	
Kind	Value	Annotation								
minInclusive	1									
maxInclusive	9									
annotation	documentation Facette zur Festlegung der 1-stelligen Ganzzahlenwerte									
source	<pre>&lt;simpleType name="Zahl1"&gt;   &lt;annotation&gt;     &lt;documentation&gt;Facette zur Festlegung der 1-stelligen Ganzzahlenwerte&lt;/documentation&gt;   &lt;/annotation&gt;   &lt;restriction base="xs:positiveInteger"&gt;     &lt;minInclusive value="1"/&gt;     &lt;maxInclusive value="9"/&gt;   &lt;/restriction&gt; &lt;/simpleType&gt;</pre>									

### simpleType Zahl1\_1

namespace	http://xml.ir-d.de/irdsa															
type	restriction of <b>decimal</b>															
properties	base xs:decimal															
facets	<table border="1"> <thead> <tr> <th>Kind</th> <th>Value</th> <th>Annotation</th> </tr> </thead> <tbody> <tr> <td>minInclusive</td> <td>0.1</td> <td></td> </tr> <tr> <td>maxInclusive</td> <td>9.9</td> <td></td> </tr> <tr> <td>totalDigits</td> <td>2</td> <td></td> </tr> <tr> <td>fractionDigits</td> <td>1</td> <td></td> </tr> </tbody> </table>	Kind	Value	Annotation	minInclusive	0.1		maxInclusive	9.9		totalDigits	2		fractionDigits	1	
Kind	Value	Annotation														
minInclusive	0.1															
maxInclusive	9.9															
totalDigits	2															
fractionDigits	1															
annotation	documentation Facette zur Festlegung des Formats [N].[N]															
source	<pre>&lt;simpleType name="Zahl1_1"&gt;   &lt;annotation&gt;     &lt;documentation&gt;Facette zur Festlegung des Formats [N].[N]&lt;/documentation&gt;   &lt;/annotation&gt;   &lt;restriction base="xs:decimal"&gt;     &lt;totalDigits value="2"/&gt;     &lt;fractionDigits value="1"/&gt;     &lt;minInclusive value="0.1"/&gt;     &lt;maxInclusive value="9.9"/&gt;   &lt;/restriction&gt; &lt;/simpleType&gt;</pre>															

### simpleType Zahl2

namespace	http://xml.ir-d.de/irdsa									
type	restriction of <b>positiveInteger</b>									
properties	base xs:positiveInteger									
facets	<table border="1"> <thead> <tr> <th>Kind</th> <th>Value</th> <th>Annotation</th> </tr> </thead> <tbody> <tr> <td>minInclusive</td> <td>1</td> <td></td> </tr> <tr> <td>maxInclusive</td> <td>99</td> <td></td> </tr> </tbody> </table>	Kind	Value	Annotation	minInclusive	1		maxInclusive	99	
Kind	Value	Annotation								
minInclusive	1									
maxInclusive	99									
annotation	documentation Facette zur Festlegung der 2-stelligen Ganzzahlenwerte									

source	<pre>&lt;simpleType name="Zahl2"&gt;   &lt;annotation&gt;     &lt;documentation&gt;Facette zur Festlegung der 2-stelligen Ganzzahlenwerte&lt;/documentation&gt;   &lt;/annotation&gt;   &lt;restriction base="xs:positiveInteger"&gt;     &lt;minInclusive value="1"/&gt;     &lt;maxInclusive value="99"/&gt;   &lt;/restriction&gt; &lt;/simpleType&gt;</pre>
--------	---

### simpleType Zahl2\_1

namespace	http://xml.ir-d.de/irdsa															
type	restriction of <b>decimal</b>															
properties	base xs:decimal															
facets	<table border="1"> <thead> <tr> <th>Kind</th> <th>Value</th> <th>Annotation</th> </tr> </thead> <tbody> <tr> <td>minInclusive</td> <td>0.1</td> <td></td> </tr> <tr> <td>maxInclusive</td> <td>99.9</td> <td></td> </tr> <tr> <td>totalDigits</td> <td>3</td> <td></td> </tr> <tr> <td>fractionDigits</td> <td>1</td> <td></td> </tr> </tbody> </table>	Kind	Value	Annotation	minInclusive	0.1		maxInclusive	99.9		totalDigits	3		fractionDigits	1	
Kind	Value	Annotation														
minInclusive	0.1															
maxInclusive	99.9															
totalDigits	3															
fractionDigits	1															
annotation	documentation Facette zur Festlegung des Formats [NN].[N]															
source	<pre>&lt;simpleType name="Zahl2_1"&gt;   &lt;annotation&gt;     &lt;documentation&gt;Facette zur Festlegung des Formats [NN].[N]&lt;/documentation&gt;   &lt;/annotation&gt;   &lt;restriction base="xs:decimal"&gt;     &lt;totalDigits value="3"/&gt;     &lt;fractionDigits value="1"/&gt;     &lt;minInclusive value="0.1"/&gt;     &lt;maxInclusive value="99.9"/&gt;   &lt;/restriction&gt; &lt;/simpleType&gt;</pre>															

### simpleType Zahl3

namespace	http://xml.ir-d.de/irdsa									
type	restriction of <b>positiveInteger</b>									
properties	base xs:positiveInteger									
facets	<table border="1"> <thead> <tr> <th>Kind</th> <th>Value</th> <th>Annotation</th> </tr> </thead> <tbody> <tr> <td>minInclusive</td> <td>1</td> <td></td> </tr> <tr> <td>maxInclusive</td> <td>999</td> <td></td> </tr> </tbody> </table>	Kind	Value	Annotation	minInclusive	1		maxInclusive	999	
Kind	Value	Annotation								
minInclusive	1									
maxInclusive	999									
annotation	documentation Facette zur Festlegung der 3-stelligen Ganzzahlenwerte									
source	<pre>&lt;simpleType name="Zahl3"&gt;   &lt;annotation&gt;     &lt;documentation&gt;Facette zur Festlegung der 3-stelligen Ganzzahlenwerte&lt;/documentation&gt;   &lt;/annotation&gt;   &lt;restriction base="xs:positiveInteger"&gt;     &lt;minInclusive value="1"/&gt;   &lt;/restriction&gt; &lt;/simpleType&gt;</pre>									

	<pre> &lt;maxInclusive value="999"/&gt; &lt;/restriction&gt; &lt;/simpleType&gt; </pre>
--	---

### simpleType **Zahl3\_1**

namespace	http://xml.ir-d.de/irdsa															
type	restriction of <b>decimal</b>															
properties	base xs:decimal															
facets	<table border="1"> <thead> <tr> <th>Kind</th> <th>Value</th> <th>Annotation</th> </tr> </thead> <tbody> <tr> <td>minInclusive</td> <td>0.1</td> <td></td> </tr> <tr> <td>maxInclusive</td> <td>999.9</td> <td></td> </tr> <tr> <td>totalDigits</td> <td>4</td> <td></td> </tr> <tr> <td>fractionDigits</td> <td>1</td> <td></td> </tr> </tbody> </table>	Kind	Value	Annotation	minInclusive	0.1		maxInclusive	999.9		totalDigits	4		fractionDigits	1	
Kind	Value	Annotation														
minInclusive	0.1															
maxInclusive	999.9															
totalDigits	4															
fractionDigits	1															
annotation	documentation Facette zur Festlegung des Formats [NNN].[N]															
source	<pre> &lt;simpleType name="Zahl3_1"&gt;   &lt;annotation&gt;     &lt;documentation&gt;Facette zur Festlegung des Formats [NNN].[N]&lt;/documentation&gt;   &lt;/annotation&gt;   &lt;restriction base="xs:decimal"&gt;     &lt;totalDigits value="4"/&gt;     &lt;fractionDigits value="1"/&gt;     &lt;minInclusive value="0.1"/&gt;     &lt;maxInclusive value="999.9"/&gt;   &lt;/restriction&gt; &lt;/simpleType&gt; </pre>															

### simpleType **Zahl4**

namespace	http://xml.ir-d.de/irdsa									
type	restriction of <b>positiveInteger</b>									
properties	base xs:positiveInteger									
facets	<table border="1"> <thead> <tr> <th>Kind</th> <th>Value</th> <th>Annotation</th> </tr> </thead> <tbody> <tr> <td>minInclusive</td> <td>1</td> <td></td> </tr> <tr> <td>maxInclusive</td> <td>9999</td> <td></td> </tr> </tbody> </table>	Kind	Value	Annotation	minInclusive	1		maxInclusive	9999	
Kind	Value	Annotation								
minInclusive	1									
maxInclusive	9999									
annotation	documentation Facette zur Festlegung der 4-stelligen Ganzzahlenwerte									
source	<pre> &lt;simpleType name="Zahl4"&gt;   &lt;annotation&gt;     &lt;documentation&gt;Facette zur Festlegung der 4-stelligen Ganzzahlenwerte&lt;/documentation&gt;   &lt;/annotation&gt;   &lt;restriction base="xs:positiveInteger"&gt;     &lt;minInclusive value="1"/&gt;     &lt;maxInclusive value="9999"/&gt;   &lt;/restriction&gt; &lt;/simpleType&gt; </pre>									

### simpleType **Zahl5**

namespace	http://xml.ir-d.de/irdsa									
type	restriction of <b>positiveInteger</b>									
properties	base xs:positiveInteger									
facets	<table border="1"> <thead> <tr> <th>Kind</th> <th>Value</th> <th>Annotation</th> </tr> </thead> <tbody> <tr> <td>minInclusive</td> <td>1</td> <td></td> </tr> <tr> <td>maxInclusive</td> <td>99999</td> <td></td> </tr> </tbody> </table>	Kind	Value	Annotation	minInclusive	1		maxInclusive	99999	
Kind	Value	Annotation								
minInclusive	1									
maxInclusive	99999									
annotation	documentation Facette zur Festlegung der 5-stelligen Ganzzahlenwerte									
source	<pre> &lt;simpleType name="Zahl5"&gt;   &lt;annotation&gt;     &lt;documentation&gt;Facette zur Festlegung der 5-stelligen     Ganzzahlenwerte&lt;/documentation&gt;   &lt;/annotation&gt;   &lt;restriction base="xs:positiveInteger"&gt;     &lt;minInclusive value="1"/&gt;     &lt;maxInclusive value="99999"/&gt;   &lt;/restriction&gt; &lt;/simpleType&gt;           </pre>									

### simpleType **Zahl5mitNull**

namespace	http://xml.ir-d.de/irdsa									
type	restriction of <b>integer</b>									
properties	base xs:integer									
facets	<table border="1"> <thead> <tr> <th>Kind</th> <th>Value</th> <th>Annotation</th> </tr> </thead> <tbody> <tr> <td>minInclusive</td> <td>0</td> <td></td> </tr> <tr> <td>maxInclusive</td> <td>99999</td> <td></td> </tr> </tbody> </table>	Kind	Value	Annotation	minInclusive	0		maxInclusive	99999	
Kind	Value	Annotation								
minInclusive	0									
maxInclusive	99999									
annotation	documentation Facette zur Festlegung der 5-stelligen Ganzzahlenwerte inklusive "0"									
source	<pre> &lt;simpleType name="Zahl5mitNull"&gt;   &lt;annotation&gt;     &lt;documentation&gt;Facette zur Festlegung der 5-stelligen Ganzzahlenwerte     inklusive "0"&lt;/documentation&gt;   &lt;/annotation&gt;   &lt;restriction base="xs:integer"&gt;     &lt;minInclusive value="0"/&gt;     &lt;maxInclusive value="99999"/&gt;   &lt;/restriction&gt; &lt;/simpleType&gt;           </pre>									

### complexType **MeldungIrdBasis**

diagram	
namespace	http://xml.ir-d.de/irdsa
children	<a href="#">MEL_IrdIdGesundheitseinrichtung</a>
used by	complexType <a href="#">Storno</a>

source	<pre>&lt;complexType name="MeldungIrdBasis"&gt;   &lt;sequence&gt;     &lt;element name="MEL_IrdIdGesundheitseinrichtung" type="IdEinrichtung"/&gt;   &lt;/sequence&gt; &lt;/complexType&gt;</pre>
--------	--

element **MeldungIrdBasis/MEL\_IrdIdGesundheitseinrichtung**

diagram							
type	<a href="#">IdEinrichtung</a>						
properties	content simple						
facets	<table border="1"> <thead> <tr> <th>Kind</th> <th>Value</th> <th>Annotation</th> </tr> </thead> <tbody> <tr> <td>pattern</td> <td>(IRD-GE-[0-9]{8})</td> <td></td> </tr> </tbody> </table>	Kind	Value	Annotation	pattern	(IRD-GE-[0-9]{8})	
Kind	Value	Annotation					
pattern	(IRD-GE-[0-9]{8})						
source	<pre>&lt;element name="MEL_IrdIdGesundheitseinrichtung" type="IdEinrichtung"/&gt;</pre>						

complexType **StornoFallBasis**

diagram	
namespace	http://xml.ir-d.de/irdsa
children	<a href="#">FAL Transfernummer</a> <a href="#">FAL Aufnahmedatum</a>
used by	element <a href="#">Storno/fall</a>
source	<pre>&lt;complexType name="StornoFallBasis"&gt;   &lt;sequence&gt;     &lt;element name="FAL_Transfernummer" type="Transfernummer"/&gt;     &lt;element name="FAL_Aufnahmedatum" type="xs:date"/&gt;   &lt;/sequence&gt; &lt;/complexType&gt;</pre>

element **StornoFallBasis/FAL\_Transfernummer**

diagram							
type	<a href="#">Transfernummer</a>						
properties	content simple						
facets	<table border="1"> <thead> <tr> <th>Kind</th> <th>Value</th> <th>Annotation</th> </tr> </thead> <tbody> <tr> <td>pattern</td> <td>([a-z0-9]{64})</td> <td></td> </tr> </tbody> </table>	Kind	Value	Annotation	pattern	([a-z0-9]{64})	
Kind	Value	Annotation					
pattern	([a-z0-9]{64})						
source	<pre>&lt;element name="FAL_Transfernummer" type="Transfernummer"/&gt;</pre>						

### element **StornoFallBasis/FAL\_Aufnahmedatum**

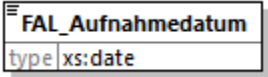
diagram	
type	<b>date</b>
properties	content simple
source	<code>&lt;element name="FAL_Aufnahmedatum" type="xs:date"/&gt;</code>

### simpleType **DatumText**

namespace	http://xml.ir-d.de/sak						
type	restriction of <b>token</b>						
properties	base xs:token						
facets	<table border="1"> <thead> <tr> <th>Kind</th> <th>Value</th> <th>Annotation</th> </tr> </thead> <tbody> <tr> <td>pattern</td> <td><code>(([0-9]{4})(-[0-9]{2})?(-[0-9]{2})?)</code></td> <td></td> </tr> </tbody> </table>	Kind	Value	Annotation	pattern	<code>(([0-9]{4})(-[0-9]{2})?(-[0-9]{2})?)</code>	
Kind	Value	Annotation					
pattern	<code>(([0-9]{4})(-[0-9]{2})?(-[0-9]{2})?)</code>						
annotation	documentation Facette zur Festlegung des freien Datumformats: JJJJ[-MM[-TT]]						
source	<pre>&lt;simpleType name="DatumText"&gt;   &lt;annotation&gt;     &lt;documentation&gt;Facette zur Festlegung des freien Datumformats:     JJJJ[-MM[-TT]]&lt;/documentation&gt;   &lt;/annotation&gt;   &lt;restriction base="xs:token"&gt;     &lt;pattern value="((([0-9]{4})(-[0-9]{2})?(-[0-9]{2})?)"/&gt;   &lt;/restriction&gt; &lt;/simpleType&gt;</pre>						

### simpleType **Freitext250**

namespace	http://xml.ir-d.de/sak						
type	restriction of <b>token</b>						
properties	base xs:token						
facets	<table border="1"> <thead> <tr> <th>Kind</th> <th>Value</th> <th>Annotation</th> </tr> </thead> <tbody> <tr> <td>maxLength</td> <td>250</td> <td></td> </tr> </tbody> </table>	Kind	Value	Annotation	maxLength	250	
Kind	Value	Annotation					
maxLength	250						
annotation	documentation Facette zur Festlegung des Freitextes von 250 Zeichen						
source	<pre>&lt;simpleType name="Freitext250"&gt;   &lt;annotation&gt;     &lt;documentation&gt;Facette zur Festlegung des Freitextes von 250     Zeichen&lt;/documentation&gt;   &lt;/annotation&gt;   &lt;restriction base="xs:token"&gt;     &lt;maxLength value="250"/&gt;   &lt;/restriction&gt; &lt;/simpleType&gt;</pre>						

### simpleType **Freitext500**

namespace	http://xml.ir-d.de/sak						
type	restriction of <b>token</b>						
properties	base xs:token						
facets	<table border="1"> <thead> <tr> <th>Kind</th> <th>Value</th> <th>Annotation</th> </tr> </thead> <tbody> <tr> <td>maxLength</td> <td>500</td> <td></td> </tr> </tbody> </table>	Kind	Value	Annotation	maxLength	500	
Kind	Value	Annotation					
maxLength	500						
annotation	documentation Facette zur Festlegung des Freitextes von 500 Zeichen						
source	<pre> &lt;simpleType name="Freitext500"&gt;   &lt;annotation&gt;     &lt;documentation&gt;Facette zur Festlegung des Freitextes von 500 Zeichen&lt;/documentation&gt;   &lt;/annotation&gt;   &lt;restriction base="xs:token"&gt;     &lt;maxLength value="500"/&gt;   &lt;/restriction&gt; &lt;/simpleType&gt;           </pre>						

### simpleType **HashString**

namespace	http://xml.ir-d.de/sak						
type	restriction of <b>token</b>						
properties	base xs:token						
facets	<table border="1"> <thead> <tr> <th>Kind</th> <th>Value</th> <th>Annotation</th> </tr> </thead> <tbody> <tr> <td>maxLength</td> <td>512</td> <td></td> </tr> </tbody> </table>	Kind	Value	Annotation	maxLength	512	
Kind	Value	Annotation					
maxLength	512						
annotation	documentation Facette zur Festlegung des Hash-Strings der Meldebestätigung						
source	<pre> &lt;simpleType name="HashString"&gt;   &lt;annotation&gt;     &lt;documentation&gt;Facette zur Festlegung des Hash-Strings der Meldebestätigung&lt;/documentation&gt;   &lt;/annotation&gt;   &lt;restriction base="xs:token"&gt;     &lt;maxLength value="512"/&gt;   &lt;/restriction&gt; &lt;/simpleType&gt;           </pre>						

### simpleType **HashWert**

namespace	http://xml.ir-d.de/sak						
type	restriction of <b>token</b>						
properties	base xs:token						
facets	<table border="1"> <thead> <tr> <th>Kind</th> <th>Value</th> <th>Annotation</th> </tr> </thead> <tbody> <tr> <td>length</td> <td>64</td> <td></td> </tr> </tbody> </table>	Kind	Value	Annotation	length	64	
Kind	Value	Annotation					
length	64						
annotation	documentation Facette zur Festlegung des Hashwertes der Meldebestätigung						
source	<pre> &lt;simpleType name="HashWert"&gt;   &lt;annotation&gt;     &lt;documentation&gt;Facette zur Festlegung des Hashwertes der Meldebestätigung&lt;/documentation&gt;   &lt;/annotation&gt;           </pre>						



	<pre> &lt;restriction base="xs:token"&gt;   &lt;length value="64"/&gt; &lt;/restriction&gt; &lt;/simpleType&gt; </pre>
--	--

### simpleType ICD

namespace	http://xml.ir-d.de/sak						
type	restriction of <b>token</b>						
properties	base xs:token						
facets	<table border="1"> <thead> <tr> <th>Kind</th> <th>Value</th> <th>Annotation</th> </tr> </thead> <tbody> <tr> <td>pattern</td> <td>([a-zA-Z][0-9]{2}(\.[0-9]{1,2})?(:[RLB])?)</td> <td></td> </tr> </tbody> </table>	Kind	Value	Annotation	pattern	([a-zA-Z][0-9]{2}(\.[0-9]{1,2})?(:[RLB])?)	
Kind	Value	Annotation					
pattern	([a-zA-Z][0-9]{2}(\.[0-9]{1,2})?(:[RLB])?)						
annotation	documentation Facette zur Festlegung des ICD Code						
source	<pre> &lt;simpleType name="ICD"&gt;   &lt;annotation&gt;     &lt;documentation&gt;Facette zur Festlegung des ICD Code&lt;/documentation&gt;   &lt;/annotation&gt;   &lt;restriction base="xs:token"&gt;     &lt;pattern value="([a-zA-Z][0-9]{2}(\.[0-9]{1,2})?(:[RLB])?)"/&gt;   &lt;/restriction&gt; &lt;/simpleType&gt; </pre>						

### simpleType IdEinrichtung

namespace	http://xml.ir-d.de/sak						
type	restriction of <b>token</b>						
properties	base xs:token						
used by	element <a href="#">MeldungIrdBasis/MEL_IrdIdGesundheitseinrichtung</a>						
facets	<table border="1"> <thead> <tr> <th>Kind</th> <th>Value</th> <th>Annotation</th> </tr> </thead> <tbody> <tr> <td>pattern</td> <td>(IRD-GE-[0-9]{8})</td> <td></td> </tr> </tbody> </table>	Kind	Value	Annotation	pattern	(IRD-GE-[0-9]{8})	
Kind	Value	Annotation					
pattern	(IRD-GE-[0-9]{8})						
annotation	documentation Facette zur Festlegung der Gesundheitseinrichtung-ID						
source	<pre> &lt;simpleType name="IdEinrichtung"&gt;   &lt;annotation&gt;     &lt;documentation&gt;Facette zur Festlegung der     Gesundheitseinrichtung-ID&lt;/documentation&gt;   &lt;/annotation&gt;   &lt;restriction base="xs:token"&gt;     &lt;pattern value="(IRD-GE-[0-9]{8})"/&gt;   &lt;/restriction&gt; &lt;/simpleType&gt; </pre>						

### simpleType IrdArtikeld

namespace	http://xml.ir-d.de/sak						
type	restriction of <b>token</b>						
properties	base xs:token						
facets	<table border="1"> <thead> <tr> <th>Kind</th> <th>Value</th> <th>Annotation</th> </tr> </thead> <tbody> <tr> <td>maxLength</td> <td>16</td> <td></td> </tr> </tbody> </table>	Kind	Value	Annotation	maxLength	16	
Kind	Value	Annotation					
maxLength	16						

annotation	documentation Facette zur Festlegung der IrdNummer
source	<pre>&lt;simpleType name="IrdArtikelId"&gt;   &lt;annotation&gt;     &lt;documentation&gt;Facette zur Festlegung der IrdNummer&lt;/documentation&gt;   &lt;/annotation&gt;   &lt;restriction base="xs:token"&gt;     &lt;maxLength value="16"/&gt;   &lt;/restriction&gt; &lt;/simpleType&gt;</pre>

### simpleType IrdSpezVersion

namespace	http://xml.ir-d.de/sak						
type	restriction of <b>token</b>						
properties	base xs:token						
facets	<table border="1"> <thead> <tr> <th>Kind</th> <th>Value</th> <th>Annotation</th> </tr> </thead> <tbody> <tr> <td>pattern</td> <td>(([1-9][1-9][0-9])\.\d{1-9} \d{1-9})</td> <td></td> </tr> </tbody> </table>	Kind	Value	Annotation	pattern	(([1-9][1-9][0-9])\.\d{1-9} \d{1-9})	
Kind	Value	Annotation					
pattern	(([1-9][1-9][0-9])\.\d{1-9} \d{1-9})						
annotation	documentation Facette zur Festlegung der Version der IRD-Spezifikation						
source	<pre>&lt;simpleType name="IrdSpezVersion"&gt;   &lt;annotation&gt;     &lt;documentation&gt;Facette zur Festlegung der Version der IRD-Spezifikation&lt;/documentation&gt;   &lt;/annotation&gt;   &lt;restriction base="xs:token"&gt;     &lt;pattern value="(([1-9][1-9][0-9])\.\d{1-9} \d{1-9})"/&gt;   &lt;/restriction&gt; &lt;/simpleType&gt;</pre>						

### simpleType JaLeer

namespace	http://xml.ir-d.de/sak						
type	restriction of <b>integer</b>						
properties	base xs:integer						
facets	<table border="1"> <thead> <tr> <th>Kind</th> <th>Value</th> <th>Annotation</th> </tr> </thead> <tbody> <tr> <td>pattern</td> <td>(1)</td> <td></td> </tr> </tbody> </table>	Kind	Value	Annotation	pattern	(1)	
Kind	Value	Annotation					
pattern	(1)						
annotation	documentation Facette zur Festlegung des Unbekannt-Wertes (Bedeutung 1=true)						
source	<pre>&lt;simpleType name="JaLeer"&gt;   &lt;annotation&gt;     &lt;documentation&gt;Facette zur Festlegung des Unbekannt-Wertes (Bedeutung 1=true)&lt;/documentation&gt;   &lt;/annotation&gt;   &lt;restriction base="xs:integer"&gt;     &lt;pattern value="(1)"/&gt;   &lt;/restriction&gt; &lt;/simpleType&gt;</pre>						

### simpleType **Meldebestaetigung**

namespace	http://xml.ir-d.de/sak						
type	restriction of <b>token</b>						
properties	base xs:token						
facets	<table border="1"> <tr> <td>Kind</td> <td>Value</td> <td>Annotation</td> </tr> <tr> <td>length</td> <td>10</td> <td></td> </tr> </table>	Kind	Value	Annotation	length	10	
Kind	Value	Annotation					
length	10						
annotation	documentation Facette zur Festlegung der Meldebestätigungslaenge von 10 Zeichen						
source	<pre> &lt;simpleType name="Meldebestaetigung"&gt;   &lt;annotation&gt;     &lt;documentation&gt;Facette zur Festlegung der Meldebestätigungslaenge von 10     Zeichen&lt;/documentation&gt;   &lt;/annotation&gt;   &lt;restriction base="xs:token"&gt;     &lt;length value="10"/&gt;   &lt;/restriction&gt; &lt;/simpleType&gt;           </pre>						

### simpleType **OPS**

namespace	http://xml.ir-d.de/sak						
type	restriction of <b>token</b>						
properties	base xs:token						
facets	<table border="1"> <tr> <td>Kind</td> <td>Value</td> <td>Annotation</td> </tr> <tr> <td>pattern</td> <td>(([135689]\-([0-9]){2}([a-zA-Z0-9]){1}\.([a-zA-Z0-9]{1,2}))*([:RLBr1b])?)</td> <td></td> </tr> </table>	Kind	Value	Annotation	pattern	(([135689]\-([0-9]){2}([a-zA-Z0-9]){1}\.([a-zA-Z0-9]{1,2}))*([:RLBr1b])?)	
Kind	Value	Annotation					
pattern	(([135689]\-([0-9]){2}([a-zA-Z0-9]){1}\.([a-zA-Z0-9]{1,2}))*([:RLBr1b])?)						
annotation	documentation Facette zur Festlegung des Prozedurenschlüssels						
source	<pre> &lt;simpleType name="OPS"&gt;   &lt;annotation&gt;     &lt;documentation&gt;Facette zur Festlegung des     Prozedurenschlüssels&lt;/documentation&gt;   &lt;/annotation&gt;   &lt;restriction base="xs:token"&gt;     &lt;pattern     value="([135689]\-([0-9]){2}([a-zA-Z0-9]){1}\.([a-zA-Z0-9]{1,2}))*([:RLBr1b])     ?)" /&gt;   &lt;/restriction&gt; &lt;/simpleType&gt;           </pre>						

### simpleType **String2**

namespace	http://xml.ir-d.de/sak						
type	restriction of <b>token</b>						
properties	base xs:token						
facets	<table border="1"> <tr> <td>Kind</td> <td>Value</td> <td>Annotation</td> </tr> <tr> <td>pattern</td> <td>([0-9]{2})</td> <td></td> </tr> </table>	Kind	Value	Annotation	pattern	([0-9]{2})	
Kind	Value	Annotation					
pattern	([0-9]{2})						
annotation	documentation Facette zur Festlegung des kodierten Entlassungsgrundes						
source	<pre> &lt;simpleType name="String2"&gt;           </pre>						

	<pre> &lt;annotation&gt;   &lt;documentation&gt;Facette zur Festlegung des kodierten Entlassungsgrundes&lt;/documentation&gt; &lt;/annotation&gt; &lt;restriction base="xs:token"&gt;   &lt;pattern value="([0-9]{2})"/&gt; &lt;/restriction&gt; &lt;/simpleType&gt; </pre>
--	---

### simpleType **String20**

namespace	http://xml.ir-d.de/sak						
type	restriction of <b>token</b>						
properties	base xs:token						
facets	<table border="1"> <thead> <tr> <th>Kind</th> <th>Value</th> <th>Annotation</th> </tr> </thead> <tbody> <tr> <td>maxLength</td> <td>20</td> <td></td> </tr> </tbody> </table>	Kind	Value	Annotation	maxLength	20	
Kind	Value	Annotation					
maxLength	20						
annotation	documentation Facette zur Festlegung von: Artikel-, Ident-, Serien-, Lot-Nummer des Produkts						
source	<pre> &lt;simpleType name="String20"&gt;   &lt;annotation&gt;     &lt;documentation&gt;Facette zur Festlegung von: Artikel-, Ident-, Serien-, Lot-Nummer des Produkts&lt;/documentation&gt;   &lt;/annotation&gt;   &lt;restriction base="xs:token"&gt;     &lt;maxLength value="20"/&gt;   &lt;/restriction&gt; &lt;/simpleType&gt; </pre>						

### simpleType **Sw**

namespace	http://xml.ir-d.de/sak						
type	restriction of <b>token</b>						
properties	base xs:token						
facets	<table border="1"> <thead> <tr> <th>Kind</th> <th>Value</th> <th>Annotation</th> </tr> </thead> <tbody> <tr> <td>maxLength</td> <td>120</td> <td></td> </tr> </tbody> </table>	Kind	Value	Annotation	maxLength	120	
Kind	Value	Annotation					
maxLength	120						
annotation	documentation Facette für Merkmale der externen Software						
source	<pre> &lt;simpleType name="Sw"&gt;   &lt;annotation&gt;     &lt;documentation&gt;Facette für Merkmale der externen Software&lt;/documentation&gt;   &lt;/annotation&gt;   &lt;restriction base="xs:token"&gt;     &lt;maxLength value="120"/&gt;   &lt;/restriction&gt; &lt;/simpleType&gt; </pre>						

### simpleType **Transfervummer**

namespace	http://xml.ir-d.de/sak
type	restriction of <b>token</b>

properties	base xs:token						
used by	element <a href="#">SelbstauskunftFallBasis/FAL Transfervummer</a>						
facets	<table border="1"> <thead> <tr> <th>Kind</th> <th>Value</th> <th>Annotation</th> </tr> </thead> <tbody> <tr> <td>pattern</td> <td>([a-z0-9]{64})</td> <td></td> </tr> </tbody> </table>	Kind	Value	Annotation	pattern	([a-z0-9]{64})	
Kind	Value	Annotation					
pattern	([a-z0-9]{64})						
annotation	documentation Facette zur Festlegung der Transfervummer						
source	<pre>&lt;simpleType name="Transfervummer"&gt;   &lt;annotation&gt;     &lt;documentation&gt;Facette zur Festlegung der Transfervummer&lt;/documentation&gt;   &lt;/annotation&gt;   &lt;restriction base="xs:token"&gt;     &lt;pattern value="([a-z0-9]{64})"/&gt;   &lt;/restriction&gt; &lt;/simpleType&gt;</pre>						

### simpleType Versionsnummer

namespace	http://xml.ir-d.de/sak						
type	restriction of <b>token</b>						
properties	base xs:token						
facets	<table border="1"> <thead> <tr> <th>Kind</th> <th>Value</th> <th>Annotation</th> </tr> </thead> <tbody> <tr> <td>maxLength</td> <td>10</td> <td></td> </tr> </tbody> </table>	Kind	Value	Annotation	maxLength	10	
Kind	Value	Annotation					
maxLength	10						
annotation	documentation Facette zur Festlegung der Versionsnummer des gelieferten Datensatzes						
source	<pre>&lt;simpleType name="Versionsnummer"&gt;   &lt;annotation&gt;     &lt;documentation&gt;Facette zur Festlegung der Versionsnummer des gelieferten     Datensatzes&lt;/documentation&gt;   &lt;/annotation&gt;   &lt;restriction base="xs:token"&gt;     &lt;maxLength value="10"/&gt;   &lt;/restriction&gt; &lt;/simpleType&gt;</pre>						

### simpleType Zahl1

namespace	http://xml.ir-d.de/sak									
type	restriction of <b>positiveInteger</b>									
properties	base xs:positiveInteger									
facets	<table border="1"> <thead> <tr> <th>Kind</th> <th>Value</th> <th>Annotation</th> </tr> </thead> <tbody> <tr> <td>minInclusive</td> <td>1</td> <td></td> </tr> <tr> <td>maxInclusive</td> <td>9</td> <td></td> </tr> </tbody> </table>	Kind	Value	Annotation	minInclusive	1		maxInclusive	9	
Kind	Value	Annotation								
minInclusive	1									
maxInclusive	9									
annotation	documentation Facette zur Festlegung der 1-stelligen Ganzzahlenwerte									
source	<pre>&lt;simpleType name="Zahl1"&gt;   &lt;annotation&gt;     &lt;documentation&gt;Facette zur Festlegung der 1-stelligen     Ganzzahlenwerte&lt;/documentation&gt;   &lt;/annotation&gt;   &lt;restriction base="xs:positiveInteger"&gt;     &lt;minInclusive value="1"/&gt;   &lt;/restriction&gt; &lt;/simpleType&gt;</pre>									

	<pre> &lt;maxInclusive value="9"/&gt; &lt;/restriction&gt; &lt;/simpleType&gt; </pre>
--	---

### simpleType Zahl1\_1

namespace	http://xml.ir-d.de/sak															
type	restriction of <b>decimal</b>															
properties	base xs:decimal															
facets	<table border="1"> <thead> <tr> <th>Kind</th> <th>Value</th> <th>Annotation</th> </tr> </thead> <tbody> <tr> <td>minInclusive</td> <td>0.1</td> <td></td> </tr> <tr> <td>maxInclusive</td> <td>9.9</td> <td></td> </tr> <tr> <td>totalDigits</td> <td>2</td> <td></td> </tr> <tr> <td>fractionDigits</td> <td>1</td> <td></td> </tr> </tbody> </table>	Kind	Value	Annotation	minInclusive	0.1		maxInclusive	9.9		totalDigits	2		fractionDigits	1	
Kind	Value	Annotation														
minInclusive	0.1															
maxInclusive	9.9															
totalDigits	2															
fractionDigits	1															
annotation	documentation Facette zur Festlegung des Formats [N].[N]															
source	<pre> &lt;simpleType name="Zahl1_1"&gt;   &lt;annotation&gt;     &lt;documentation&gt;Facette zur Festlegung des Formats [N].[N]&lt;/documentation&gt;   &lt;/annotation&gt;   &lt;restriction base="xs:decimal"&gt;     &lt;totalDigits value="2"/&gt;     &lt;fractionDigits value="1"/&gt;     &lt;minInclusive value="0.1"/&gt;     &lt;maxInclusive value="9.9"/&gt;   &lt;/restriction&gt; &lt;/simpleType&gt; </pre>															

### simpleType Zahl2

namespace	http://xml.ir-d.de/sak									
type	restriction of <b>positiveInteger</b>									
properties	base xs:positiveInteger									
facets	<table border="1"> <thead> <tr> <th>Kind</th> <th>Value</th> <th>Annotation</th> </tr> </thead> <tbody> <tr> <td>minInclusive</td> <td>1</td> <td></td> </tr> <tr> <td>maxInclusive</td> <td>99</td> <td></td> </tr> </tbody> </table>	Kind	Value	Annotation	minInclusive	1		maxInclusive	99	
Kind	Value	Annotation								
minInclusive	1									
maxInclusive	99									
annotation	documentation Facette zur Festlegung der 2-stelligen Ganzzahlenwerte									
source	<pre> &lt;simpleType name="Zahl2"&gt;   &lt;annotation&gt;     &lt;documentation&gt;Facette zur Festlegung der 2-stelligen Ganzzahlenwerte&lt;/documentation&gt;   &lt;/annotation&gt;   &lt;restriction base="xs:positiveInteger"&gt;     &lt;minInclusive value="1"/&gt;     &lt;maxInclusive value="99"/&gt;   &lt;/restriction&gt; &lt;/simpleType&gt; </pre>									

### simpleType **Zahl2\_1**

namespace	http://xml.ir-d.de/sak															
type	restriction of <b>decimal</b>															
properties	base xs:decimal															
facets	<table border="1"> <thead> <tr> <th>Kind</th> <th>Value</th> <th>Annotation</th> </tr> </thead> <tbody> <tr> <td>minInclusive</td> <td>0.1</td> <td></td> </tr> <tr> <td>maxInclusive</td> <td>99.9</td> <td></td> </tr> <tr> <td>totalDigits</td> <td>3</td> <td></td> </tr> <tr> <td>fractionDigits</td> <td>1</td> <td></td> </tr> </tbody> </table>	Kind	Value	Annotation	minInclusive	0.1		maxInclusive	99.9		totalDigits	3		fractionDigits	1	
Kind	Value	Annotation														
minInclusive	0.1															
maxInclusive	99.9															
totalDigits	3															
fractionDigits	1															
annotation	documentation Facette zur Festlegung des Formats [NN].[N]															
source	<pre>&lt;simpleType name="Zahl2_1"&gt;   &lt;annotation&gt;     &lt;documentation&gt;Facette zur Festlegung des Formats [NN].[N]&lt;/documentation&gt;   &lt;/annotation&gt;   &lt;restriction base="xs:decimal"&gt;     &lt;totalDigits value="3"/&gt;     &lt;fractionDigits value="1"/&gt;     &lt;minInclusive value="0.1"/&gt;     &lt;maxInclusive value="99.9"/&gt;   &lt;/restriction&gt; &lt;/simpleType&gt;</pre>															

### simpleType **Zahl3**

namespace	http://xml.ir-d.de/sak									
type	restriction of <b>positiveInteger</b>									
properties	base xs:positiveInteger									
facets	<table border="1"> <thead> <tr> <th>Kind</th> <th>Value</th> <th>Annotation</th> </tr> </thead> <tbody> <tr> <td>minInclusive</td> <td>1</td> <td></td> </tr> <tr> <td>maxInclusive</td> <td>999</td> <td></td> </tr> </tbody> </table>	Kind	Value	Annotation	minInclusive	1		maxInclusive	999	
Kind	Value	Annotation								
minInclusive	1									
maxInclusive	999									
annotation	documentation Facette zur Festlegung der 3-stelligen Ganzzahlenwerte									
source	<pre>&lt;simpleType name="Zahl3"&gt;   &lt;annotation&gt;     &lt;documentation&gt;Facette zur Festlegung der 3-stelligen Ganzzahlenwerte&lt;/documentation&gt;   &lt;/annotation&gt;   &lt;restriction base="xs:positiveInteger"&gt;     &lt;minInclusive value="1"/&gt;     &lt;maxInclusive value="999"/&gt;   &lt;/restriction&gt; &lt;/simpleType&gt;</pre>									

### simpleType **Zahl3\_1**

namespace	http://xml.ir-d.de/sak			
type	restriction of <b>decimal</b>			
properties	base xs:decimal			
facets	<table border="1"> <thead> <tr> <th>Kind</th> <th>Value</th> <th>Annotation</th> </tr> </thead> <tbody> </tbody> </table>	Kind	Value	Annotation
Kind	Value	Annotation		

	minInclusive 0.1 maxInclusive 999.9 totalDigits 4 fractionDigits 1
annotation	documentation Facette zur Festlegung des Formats [NNN].[N]
source	<pre> &lt;simpleType name="Zahl3_1"&gt;   &lt;annotation&gt;     &lt;documentation&gt;Facette zur Festlegung des Formats [NNN].[N]&lt;/documentation&gt;   &lt;/annotation&gt;   &lt;restriction base="xs:decimal"&gt;     &lt;totalDigits value="4"/&gt;     &lt;fractionDigits value="1"/&gt;     &lt;minInclusive value="0.1"/&gt;     &lt;maxInclusive value="999.9"/&gt;   &lt;/restriction&gt; &lt;/simpleType&gt; </pre>

### simpleType Zahl4

namespace	http://xml.ir-d.de/sak									
type	restriction of <b>positiveInteger</b>									
properties	base xs:positiveInteger									
facets	<table border="1"> <thead> <tr> <th>Kind</th> <th>Value</th> <th>Annotation</th> </tr> </thead> <tbody> <tr> <td>minInclusive</td> <td>1</td> <td></td> </tr> <tr> <td>maxInclusive</td> <td>9999</td> <td></td> </tr> </tbody> </table>	Kind	Value	Annotation	minInclusive	1		maxInclusive	9999	
Kind	Value	Annotation								
minInclusive	1									
maxInclusive	9999									
annotation	documentation Facette zur Festlegung der 4-stelligen Ganzzahlenwerte									
source	<pre> &lt;simpleType name="Zahl4"&gt;   &lt;annotation&gt;     &lt;documentation&gt;Facette zur Festlegung der 4-stelligen     Ganzzahlenwerte&lt;/documentation&gt;   &lt;/annotation&gt;   &lt;restriction base="xs:positiveInteger"&gt;     &lt;minInclusive value="1"/&gt;     &lt;maxInclusive value="9999"/&gt;   &lt;/restriction&gt; &lt;/simpleType&gt; </pre>									

### simpleType Zahl5

namespace	http://xml.ir-d.de/sak									
type	restriction of <b>positiveInteger</b>									
properties	base xs:positiveInteger									
facets	<table border="1"> <thead> <tr> <th>Kind</th> <th>Value</th> <th>Annotation</th> </tr> </thead> <tbody> <tr> <td>minInclusive</td> <td>1</td> <td></td> </tr> <tr> <td>maxInclusive</td> <td>99999</td> <td></td> </tr> </tbody> </table>	Kind	Value	Annotation	minInclusive	1		maxInclusive	99999	
Kind	Value	Annotation								
minInclusive	1									
maxInclusive	99999									
annotation	documentation Facette zur Festlegung der 5-stelligen Ganzzahlenwerte									
source	<pre> &lt;simpleType name="Zahl5"&gt;   &lt;annotation&gt;     &lt;documentation&gt;Facette zur Festlegung der 5-stelligen </pre>									



	<pre>Ganzzahlenwerte&lt;/documentation&gt; &lt;/annotation&gt; &lt;restriction base="xs:positiveInteger"&gt;   &lt;minInclusive value="1"/&gt;   &lt;maxInclusive value="99999"/&gt; &lt;/restriction&gt; &lt;/simpleType&gt;</pre>
--	---

### simpleType **Zahl5mitNull**

namespace	http://xml.ir-d.de/sak									
type	restriction of <b>integer</b>									
properties	base xs:integer									
facets	<table border="1"> <thead> <tr> <th>Kind</th> <th>Value</th> <th>Annotation</th> </tr> </thead> <tbody> <tr> <td>minInclusive</td> <td>0</td> <td></td> </tr> <tr> <td>maxInclusive</td> <td>99999</td> <td></td> </tr> </tbody> </table>	Kind	Value	Annotation	minInclusive	0		maxInclusive	99999	
Kind	Value	Annotation								
minInclusive	0									
maxInclusive	99999									
annotation	documentation Facette zur Festlegung der 5-stelligen Ganzzahlenwerte inklusive "0"									
source	<pre>&lt;simpleType name="Zahl5mitNull"&gt;   &lt;annotation&gt;     &lt;documentation&gt;Facette zur Festlegung der 5-stelligen Ganzzahlenwerte inklusive "0"&lt;/documentation&gt;   &lt;/annotation&gt;   &lt;restriction base="xs:integer"&gt;     &lt;minInclusive value="0"/&gt;     &lt;maxInclusive value="99999"/&gt;   &lt;/restriction&gt; &lt;/simpleType&gt;</pre>									

### complexType **MeldungIrdBasis**

diagram	
namespace	http://xml.ir-d.de/sak
children	<a href="#">MEL_IrdIdGesundheitseinrichtung</a>
used by	complexType <a href="#">Selbstauskunft</a>
source	<pre>&lt;complexType name="MeldungIrdBasis"&gt;   &lt;sequence&gt;     &lt;element name="MEL_IrdIdGesundheitseinrichtung" type="IdEinrichtung"/&gt;   &lt;/sequence&gt; &lt;/complexType&gt;</pre>

### element **MeldungIrdBasis/MEL\_IrdIdGesundheitseinrichtung**

diagram	
---------	--

type	<a href="#">IdEinrichtung</a>						
properties	content simple						
facets	<table border="1"> <tr> <td>Kind</td> <td>Value</td> <td>Annotation</td> </tr> <tr> <td>pattern</td> <td>(IRD-GE-[0-9]{8})</td> <td></td> </tr> </table>	Kind	Value	Annotation	pattern	(IRD-GE-[0-9]{8})	
Kind	Value	Annotation					
pattern	(IRD-GE-[0-9]{8})						
source	<code>&lt;element name="MEL_IrdIdGesundheitseinrichtung" type="IdEinrichtung"/&gt;</code>						

### complexType **SelbstauskunftFallBasis**

diagram	
namespace	http://xml.ir-d.de/sak
children	<a href="#">FAL_Transfernummer</a>
used by	element <a href="#">Selbstauskunft/fall</a>
source	<pre> &lt;complexType name="SelbstauskunftFallBasis"&gt;   &lt;sequence&gt;     &lt;element name="FAL_Transfernummer" type="Transfernummer"/&gt;   &lt;/sequence&gt; &lt;/complexType&gt; </pre>

### element **SelbstauskunftFallBasis/FAL\_Transfernummer**

diagram							
type	<a href="#">Transfernummer</a>						
properties	content simple						
facets	<table border="1"> <tr> <td>Kind</td> <td>Value</td> <td>Annotation</td> </tr> <tr> <td>pattern</td> <td>([a-z0-9]{64})</td> <td></td> </tr> </table>	Kind	Value	Annotation	pattern	([a-z0-9]{64})	
Kind	Value	Annotation					
pattern	([a-z0-9]{64})						
source	<code>&lt;element name="FAL_Transfernummer" type="Transfernummer"/&gt;</code>						

### simpleType **DatumText**

namespace	http://xml.ir-d.de/irdsaa						
type	restriction of <b>token</b>						
properties	base xs:token						
facets	<table border="1"> <tr> <td>Kind</td> <td>Value</td> <td>Annotation</td> </tr> <tr> <td>pattern</td> <td>(([0-9]{4})([0-9]{2})?([0-9]{2})?)</td> <td></td> </tr> </table>	Kind	Value	Annotation	pattern	(([0-9]{4})([0-9]{2})?([0-9]{2})?)	
Kind	Value	Annotation					
pattern	(([0-9]{4})([0-9]{2})?([0-9]{2})?)						
annotation	documentation Facette zur Festlegung des freien Datumformats: JJJ[-MM[-TT]]						
source	<pre> &lt;simpleType name="DatumText"&gt;   &lt;annotation&gt;     &lt;documentation&gt;Facette zur Festlegung des freien Datumformats: JJJJ[-MM[-TT]]&lt;/documentation&gt;   &lt;/annotation&gt; </pre>						

	<pre> &lt;restriction base="xs:token"&gt;   &lt;pattern value="(([\0-9]{4})([-][\0-9]{2})?([-][\0-9]{2})?)"/&gt; &lt;/restriction&gt; &lt;/simpleType&gt; </pre>
--	--

### simpleType **Freitext250**

namespace	http://xml.ir-d.de/irdsaa						
type	restriction of <b>token</b>						
properties	base xs:token						
used by	element <a href="#">EmpfangsbestaetigungBasis/EBG_Empfangsbestaetigung</a>						
facets	<table border="1"> <thead> <tr> <th>Kind</th> <th>Value</th> <th>Annotation</th> </tr> </thead> <tbody> <tr> <td>maxLength</td> <td>250</td> <td></td> </tr> </tbody> </table>	Kind	Value	Annotation	maxLength	250	
Kind	Value	Annotation					
maxLength	250						
annotation	documentation Facette zur Festlegung des Freitextes von 250 Zeichen						
source	<pre> &lt;simpleType name="Freitext250"&gt;   &lt;annotation&gt;     &lt;documentation&gt;Facette zur Festlegung des Freitextes von 250 Zeichen&lt;/documentation&gt;   &lt;/annotation&gt;   &lt;restriction base="xs:token"&gt;     &lt;maxLength value="250"/&gt;   &lt;/restriction&gt; &lt;/simpleType&gt; </pre>						

### simpleType **Freitext500**

namespace	http://xml.ir-d.de/irdsaa						
type	restriction of <b>token</b>						
properties	base xs:token						
facets	<table border="1"> <thead> <tr> <th>Kind</th> <th>Value</th> <th>Annotation</th> </tr> </thead> <tbody> <tr> <td>maxLength</td> <td>500</td> <td></td> </tr> </tbody> </table>	Kind	Value	Annotation	maxLength	500	
Kind	Value	Annotation					
maxLength	500						
annotation	documentation Facette zur Festlegung des Freitextes von 500 Zeichen						
source	<pre> &lt;simpleType name="Freitext500"&gt;   &lt;annotation&gt;     &lt;documentation&gt;Facette zur Festlegung des Freitextes von 500 Zeichen&lt;/documentation&gt;   &lt;/annotation&gt;   &lt;restriction base="xs:token"&gt;     &lt;maxLength value="500"/&gt;   &lt;/restriction&gt; &lt;/simpleType&gt; </pre>						

### simpleType **HashString**

namespace	http://xml.ir-d.de/irdsaa
type	restriction of <b>token</b>
properties	base xs:token

facets	<table border="1"> <thead> <tr> <th>Kind</th> <th>Value</th> <th>Annotation</th> </tr> </thead> <tbody> <tr> <td>maxLength</td> <td>512</td> <td></td> </tr> </tbody> </table>	Kind	Value	Annotation	maxLength	512	
Kind	Value	Annotation					
maxLength	512						
annotation	<p>documentation Facette zur Festlegung des Hash-Strings der Meldebestätigung</p>						
source	<pre>&lt;simpleType name="HashString"&gt;   &lt;annotation&gt;     &lt;documentation&gt;Facette zur Festlegung des Hash-Strings der Meldebestätigung&lt;/documentation&gt;   &lt;/annotation&gt;   &lt;restriction base="xs:token"&gt;     &lt;maxLength value="512"/&gt;   &lt;/restriction&gt; &lt;/simpleType&gt;</pre>						

### simpleType HashWert

namespace	http://xml.ir-d.de/irdsaa						
type	restriction of <b>token</b>						
properties	base xs:token						
facets	<table border="1"> <thead> <tr> <th>Kind</th> <th>Value</th> <th>Annotation</th> </tr> </thead> <tbody> <tr> <td>length</td> <td>64</td> <td></td> </tr> </tbody> </table>	Kind	Value	Annotation	length	64	
Kind	Value	Annotation					
length	64						
annotation	<p>documentation Facette zur Festlegung des Hashwertes der Meldebestätigung</p>						
source	<pre>&lt;simpleType name="HashWert"&gt;   &lt;annotation&gt;     &lt;documentation&gt;Facette zur Festlegung des Hashwertes der Meldebestätigung&lt;/documentation&gt;   &lt;/annotation&gt;   &lt;restriction base="xs:token"&gt;     &lt;length value="64"/&gt;   &lt;/restriction&gt; &lt;/simpleType&gt;</pre>						

### simpleType ICD

namespace	http://xml.ir-d.de/irdsaa						
type	restriction of <b>token</b>						
properties	base xs:token						
facets	<table border="1"> <thead> <tr> <th>Kind</th> <th>Value</th> <th>Annotation</th> </tr> </thead> <tbody> <tr> <td>pattern</td> <td>([a-zA-Z][0-9]{2}(\.[0-9]{1,2})?(:[RLB])?)</td> <td></td> </tr> </tbody> </table>	Kind	Value	Annotation	pattern	([a-zA-Z][0-9]{2}(\.[0-9]{1,2})?(:[RLB])?)	
Kind	Value	Annotation					
pattern	([a-zA-Z][0-9]{2}(\.[0-9]{1,2})?(:[RLB])?)						
annotation	<p>documentation Facette zur Festlegung des ICD Code</p>						
source	<pre>&lt;simpleType name="ICD"&gt;   &lt;annotation&gt;     &lt;documentation&gt;Facette zur Festlegung des ICD Code&lt;/documentation&gt;   &lt;/annotation&gt;   &lt;restriction base="xs:token"&gt;     &lt;pattern value="([a-zA-Z][0-9]{2}(\.[0-9]{1,2})?(:[RLB])?)"/&gt;   &lt;/restriction&gt; &lt;/simpleType&gt;</pre>						

### simpleType IdEinrichtung

namespace	http://xml.ir-d.de/irdsaa						
type	restriction of <b>token</b>						
properties	base xs:token						
used by	element <a href="#">MeldungIrdBasis/MEL_IrdIdGesundheitseinrichtung</a>						
facets	<table border="1"> <thead> <tr> <th>Kind</th> <th>Value</th> <th>Annotation</th> </tr> </thead> <tbody> <tr> <td>pattern</td> <td>(IRD-GE-[0-9]{8})</td> <td></td> </tr> </tbody> </table>	Kind	Value	Annotation	pattern	(IRD-GE-[0-9]{8})	
Kind	Value	Annotation					
pattern	(IRD-GE-[0-9]{8})						
annotation	documentation Facette zur Festlegung der Gesundheitseinrichtung-ID						
source	<pre>&lt;simpleType name="IdEinrichtung"&gt;   &lt;annotation&gt;     &lt;documentation&gt;Facette zur Festlegung der Gesundheitseinrichtung-ID&lt;/documentation&gt;   &lt;/annotation&gt;   &lt;restriction base="xs:token"&gt;     &lt;pattern value="(IRD-GE-[0-9]{8})"/&gt;   &lt;/restriction&gt; &lt;/simpleType&gt;</pre>						

### simpleType IrdArtikelId

namespace	http://xml.ir-d.de/irdsaa						
type	restriction of <b>token</b>						
properties	base xs:token						
facets	<table border="1"> <thead> <tr> <th>Kind</th> <th>Value</th> <th>Annotation</th> </tr> </thead> <tbody> <tr> <td>maxLength</td> <td>16</td> <td></td> </tr> </tbody> </table>	Kind	Value	Annotation	maxLength	16	
Kind	Value	Annotation					
maxLength	16						
annotation	documentation Facette zur Festlegung der IrdNummer						
source	<pre>&lt;simpleType name="IrdArtikelId"&gt;   &lt;annotation&gt;     &lt;documentation&gt;Facette zur Festlegung der IrdNummer&lt;/documentation&gt;   &lt;/annotation&gt;   &lt;restriction base="xs:token"&gt;     &lt;maxLength value="16"/&gt;   &lt;/restriction&gt; &lt;/simpleType&gt;</pre>						

### simpleType IrdSpezVersion

namespace	http://xml.ir-d.de/irdsaa						
type	restriction of <b>token</b>						
properties	base xs:token						
facets	<table border="1"> <thead> <tr> <th>Kind</th> <th>Value</th> <th>Annotation</th> </tr> </thead> <tbody> <tr> <td>pattern</td> <td>((([1-9] [1-9][0-9])\.\d{1}[0-9])\.\d{1}[0-9])</td> <td></td> </tr> </tbody> </table>	Kind	Value	Annotation	pattern	((([1-9] [1-9][0-9])\.\d{1}[0-9])\.\d{1}[0-9])	
Kind	Value	Annotation					
pattern	((([1-9] [1-9][0-9])\.\d{1}[0-9])\.\d{1}[0-9])						
annotation	documentation Facette zur Festlegung der Version der IRD-Spezifikation						
source	<pre>&lt;simpleType name="IrdSpezVersion"&gt;   &lt;annotation&gt;     &lt;documentation&gt;Facette zur Festlegung der Version der IRD-Spezifikation&lt;/documentation&gt;   &lt;/annotation&gt;</pre>						

	<pre> &lt;/annotation&gt; &lt;restriction base="xs:token"&gt;   &lt;pattern value="((([1-9] [1-9][0-9])\.\(\d [1-9][0-9])\.\(\d [1-9][0-9]))"/&gt; &lt;/restriction&gt; &lt;/simpleType&gt; </pre>
--	--

### simpleType JaLeer

namespace	http://xml.ir-d.de/irdsaa						
type	restriction of <b>integer</b>						
properties	base xs:integer						
facets	<table border="1"> <thead> <tr> <th>Kind</th> <th>Value</th> <th>Annotation</th> </tr> </thead> <tbody> <tr> <td>pattern</td> <td>(1)</td> <td></td> </tr> </tbody> </table>	Kind	Value	Annotation	pattern	(1)	
Kind	Value	Annotation					
pattern	(1)						
annotation	documentation Facette zur Festlegung des Unbekannt-Wertes (Bedeutung 1=true)						
source	<pre> &lt;simpleType name="JaLeer"&gt;   &lt;annotation&gt;     &lt;documentation&gt;Facette zur Festlegung des Unbekannt-Wertes (Bedeutung 1=true)&lt;/documentation&gt;   &lt;/annotation&gt;   &lt;restriction base="xs:integer"&gt;     &lt;pattern value="(1)"/&gt;   &lt;/restriction&gt; &lt;/simpleType&gt; </pre>						

### simpleType Meldebestaetigung

namespace	http://xml.ir-d.de/irdsaa						
type	restriction of <b>token</b>						
properties	base xs:token						
facets	<table border="1"> <thead> <tr> <th>Kind</th> <th>Value</th> <th>Annotation</th> </tr> </thead> <tbody> <tr> <td>length</td> <td>10</td> <td></td> </tr> </tbody> </table>	Kind	Value	Annotation	length	10	
Kind	Value	Annotation					
length	10						
annotation	documentation Facette zur Festlegung der Meldebestätigungslaenge von 10 Zeichen						
source	<pre> &lt;simpleType name="Meldebestaetigung"&gt;   &lt;annotation&gt;     &lt;documentation&gt;Facette zur Festlegung der Meldebestätigungslaenge von 10 Zeichen&lt;/documentation&gt;   &lt;/annotation&gt;   &lt;restriction base="xs:token"&gt;     &lt;length value="10"/&gt;   &lt;/restriction&gt; &lt;/simpleType&gt; </pre>						

### simpleType OPS

namespace	http://xml.ir-d.de/irdsaa
type	restriction of <b>token</b>
properties	base xs:token

facets	Kind pattern	Value ([135689]\-([0-9]){2}([a-zA-Z0-9]){1}\.([a-zA-Z0-9]{1,2}))*(:[RLBr1b])?	Annotation
annotation	documentation Facette zur Festlegung des Prozedurenschlüssels		
source	<pre>&lt;simpleType name="OPS"&gt;   &lt;annotation&gt;     &lt;documentation&gt;Facette zur Festlegung des Prozedurenschlüssels&lt;/documentation&gt;   &lt;/annotation&gt;   &lt;restriction base="xs:token"&gt;     &lt;pattern value="([135689]\-([0-9]){2}([a-zA-Z0-9]){1}\.([a-zA-Z0-9]{1,2}))*(:[RLBr1b]) ?)" /&gt;   &lt;/restriction&gt; &lt;/simpleType&gt;</pre>		

### simpleType **String2**

namespace	http://xml.ir-d.de/irdsaa		
type	restriction of <b>token</b>		
properties	base xs:token		
facets	Kind pattern	Value ([0-9]{2})	Annotation
annotation	documentation Facette zur Festlegung des kodierten Entlassungsgrundes		
source	<pre>&lt;simpleType name="String2"&gt;   &lt;annotation&gt;     &lt;documentation&gt;Facette zur Festlegung des kodierten Entlassungsgrundes&lt;/documentation&gt;   &lt;/annotation&gt;   &lt;restriction base="xs:token"&gt;     &lt;pattern value="([0-9]{2})" /&gt;   &lt;/restriction&gt; &lt;/simpleType&gt;</pre>		

### simpleType **String20**

namespace	http://xml.ir-d.de/irdsaa		
type	restriction of <b>token</b>		
properties	base xs:token		
facets	Kind maxLength	Value 20	Annotation
annotation	documentation Facette zur Festlegung von: Artikel-, Ident-, Serien-, Lot-Nummer des Produkts		
source	<pre>&lt;simpleType name="String20"&gt;   &lt;annotation&gt;     &lt;documentation&gt;Facette zur Festlegung von: Artikel-, Ident-, Serien-, Lot-Nummer des Produkts&lt;/documentation&gt;   &lt;/annotation&gt;   &lt;restriction base="xs:token"&gt;     &lt;maxLength value="20" /&gt;   &lt;/restriction&gt;</pre>		

	<code>&lt;/simpleType&gt;</code>
--	----------------------------------

### simpleType Sw

namespace	http://xml.ir-d.de/irdsaa						
type	restriction of <b>token</b>						
properties	base xs:token						
facets	<table border="1"> <thead> <tr> <th>Kind</th> <th>Value</th> <th>Annotation</th> </tr> </thead> <tbody> <tr> <td>maxLength</td> <td>120</td> <td></td> </tr> </tbody> </table>	Kind	Value	Annotation	maxLength	120	
Kind	Value	Annotation					
maxLength	120						
annotation	documentation Facette für Merkmale der externen Software						
source	<pre>&lt;simpleType name="Sw"&gt;   &lt;annotation&gt;     &lt;documentation&gt;Facette für Merkmale der externen Software&lt;/documentation&gt;   &lt;/annotation&gt;   &lt;restriction base="xs:token"&gt;     &lt;maxLength value="120"/&gt;   &lt;/restriction&gt; &lt;/simpleType&gt;</pre>						

### simpleType Transfervummer

namespace	http://xml.ir-d.de/irdsaa						
type	restriction of <b>token</b>						
properties	base xs:token						
used by	element <a href="#">SelbstauskunftFallBasis/FAL Transfervummer</a>						
facets	<table border="1"> <thead> <tr> <th>Kind</th> <th>Value</th> <th>Annotation</th> </tr> </thead> <tbody> <tr> <td>pattern</td> <td>([a-z0-9]{64})</td> <td></td> </tr> </tbody> </table>	Kind	Value	Annotation	pattern	([a-z0-9]{64})	
Kind	Value	Annotation					
pattern	([a-z0-9]{64})						
annotation	documentation Facette zur Festlegung der Transfervummer						
source	<pre>&lt;simpleType name="Transfervummer"&gt;   &lt;annotation&gt;     &lt;documentation&gt;Facette zur Festlegung der Transfervummer&lt;/documentation&gt;   &lt;/annotation&gt;   &lt;restriction base="xs:token"&gt;     &lt;pattern value="([a-z0-9]{64})"/&gt;   &lt;/restriction&gt; &lt;/simpleType&gt;</pre>						

### simpleType Versionsnummer

namespace	http://xml.ir-d.de/irdsaa						
type	restriction of <b>token</b>						
properties	base xs:token						
facets	<table border="1"> <thead> <tr> <th>Kind</th> <th>Value</th> <th>Annotation</th> </tr> </thead> <tbody> <tr> <td>maxLength</td> <td>10</td> <td></td> </tr> </tbody> </table>	Kind	Value	Annotation	maxLength	10	
Kind	Value	Annotation					
maxLength	10						
annotation	documentation Facette zur Festlegung der Versionsnummer des gelieferten Datensatzes						
source	<pre>&lt;simpleType name="Versionsnummer"&gt;</pre>						



	<pre> &lt;annotation&gt;   &lt;documentation&gt;Facette zur Festlegung der Versionsnummer des gelieferten   Datensatzes&lt;/documentation&gt; &lt;/annotation&gt; &lt;restriction base="xs:token"&gt;   &lt;maxLength value="10"/&gt; &lt;/restriction&gt; &lt;/simpleType&gt; </pre>
--	---

### simpleType Zahl1

namespace	http://xml.ir-d.de/irdsaa									
type	restriction of <b>positiveInteger</b>									
properties	base xs:positiveInteger									
facets	<table border="1"> <thead> <tr> <th>Kind</th> <th>Value</th> <th>Annotation</th> </tr> </thead> <tbody> <tr> <td>minInclusive</td> <td>1</td> <td></td> </tr> <tr> <td>maxInclusive</td> <td>9</td> <td></td> </tr> </tbody> </table>	Kind	Value	Annotation	minInclusive	1		maxInclusive	9	
Kind	Value	Annotation								
minInclusive	1									
maxInclusive	9									
annotation	documentation Facette zur Festlegung der 1-stelligen Ganzzahlenwerte									
source	<pre> &lt;simpleType name="Zahl1"&gt;   &lt;annotation&gt;     &lt;documentation&gt;Facette zur Festlegung der 1-stelligen     Ganzzahlenwerte&lt;/documentation&gt;   &lt;/annotation&gt;   &lt;restriction base="xs:positiveInteger"&gt;     &lt;minInclusive value="1"/&gt;     &lt;maxInclusive value="9"/&gt;   &lt;/restriction&gt; &lt;/simpleType&gt; </pre>									

### simpleType Zahl1\_1

namespace	http://xml.ir-d.de/irdsaa															
type	restriction of <b>decimal</b>															
properties	base xs:decimal															
facets	<table border="1"> <thead> <tr> <th>Kind</th> <th>Value</th> <th>Annotation</th> </tr> </thead> <tbody> <tr> <td>minInclusive</td> <td>0.1</td> <td></td> </tr> <tr> <td>maxInclusive</td> <td>9.9</td> <td></td> </tr> <tr> <td>totalDigits</td> <td>2</td> <td></td> </tr> <tr> <td>fractionDigits</td> <td>1</td> <td></td> </tr> </tbody> </table>	Kind	Value	Annotation	minInclusive	0.1		maxInclusive	9.9		totalDigits	2		fractionDigits	1	
Kind	Value	Annotation														
minInclusive	0.1															
maxInclusive	9.9															
totalDigits	2															
fractionDigits	1															
annotation	documentation Facette zur Festlegung des Formats [N].[N]															
source	<pre> &lt;simpleType name="Zahl1_1"&gt;   &lt;annotation&gt;     &lt;documentation&gt;Facette zur Festlegung des Formats [N].[N]&lt;/documentation&gt;   &lt;/annotation&gt;   &lt;restriction base="xs:decimal"&gt;     &lt;totalDigits value="2"/&gt;     &lt;fractionDigits value="1"/&gt;     &lt;minInclusive value="0.1"/&gt;     &lt;maxInclusive value="9.9"/&gt;   &lt;/restriction&gt; </pre>															

	<code>&lt;/simpleType&gt;</code>
--	----------------------------------

### simpleType **Zahl2**

namespace	http://xml.ir-d.de/irdsaa									
type	restriction of <b>positiveInteger</b>									
properties	base xs:positiveInteger									
facets	<table border="1"> <thead> <tr> <th>Kind</th> <th>Value</th> <th>Annotation</th> </tr> </thead> <tbody> <tr> <td>minInclusive</td> <td>1</td> <td></td> </tr> <tr> <td>maxInclusive</td> <td>99</td> <td></td> </tr> </tbody> </table>	Kind	Value	Annotation	minInclusive	1		maxInclusive	99	
Kind	Value	Annotation								
minInclusive	1									
maxInclusive	99									
annotation	documentation Facette zur Festlegung der 2-stelligen Ganzzahlenwerte									
source	<pre>&lt;simpleType name="Zahl2"&gt;   &lt;annotation&gt;     &lt;documentation&gt;Facette zur Festlegung der 2-stelligen     Ganzzahlenwerte&lt;/documentation&gt;   &lt;/annotation&gt;   &lt;restriction base="xs:positiveInteger"&gt;     &lt;minInclusive value="1"/&gt;     &lt;maxInclusive value="99"/&gt;   &lt;/restriction&gt; &lt;/simpleType&gt;</pre>									

### simpleType **Zahl2\_1**

namespace	http://xml.ir-d.de/irdsaa															
type	restriction of <b>decimal</b>															
properties	base xs:decimal															
facets	<table border="1"> <thead> <tr> <th>Kind</th> <th>Value</th> <th>Annotation</th> </tr> </thead> <tbody> <tr> <td>minInclusive</td> <td>0.1</td> <td></td> </tr> <tr> <td>maxInclusive</td> <td>99.9</td> <td></td> </tr> <tr> <td>totalDigits</td> <td>3</td> <td></td> </tr> <tr> <td>fractionDigits</td> <td>1</td> <td></td> </tr> </tbody> </table>	Kind	Value	Annotation	minInclusive	0.1		maxInclusive	99.9		totalDigits	3		fractionDigits	1	
Kind	Value	Annotation														
minInclusive	0.1															
maxInclusive	99.9															
totalDigits	3															
fractionDigits	1															
annotation	documentation Facette zur Festlegung des Formats [NN].[N]															
source	<pre>&lt;simpleType name="Zahl2_1"&gt;   &lt;annotation&gt;     &lt;documentation&gt;Facette zur Festlegung des Formats [NN].[N]&lt;/documentation&gt;   &lt;/annotation&gt;   &lt;restriction base="xs:decimal"&gt;     &lt;totalDigits value="3"/&gt;     &lt;fractionDigits value="1"/&gt;     &lt;minInclusive value="0.1"/&gt;     &lt;maxInclusive value="99.9"/&gt;   &lt;/restriction&gt; &lt;/simpleType&gt;</pre>															

### simpleType **Zahl3**

namespace	http://xml.ir-d.de/irdsaa
-----------	---------------------------

type	restriction of <b>positiveInteger</b>									
properties	base xs:positiveInteger									
facets	<table border="1"> <thead> <tr> <th>Kind</th> <th>Value</th> <th>Annotation</th> </tr> </thead> <tbody> <tr> <td>minInclusive</td> <td>1</td> <td></td> </tr> <tr> <td>maxInclusive</td> <td>999</td> <td></td> </tr> </tbody> </table>	Kind	Value	Annotation	minInclusive	1		maxInclusive	999	
Kind	Value	Annotation								
minInclusive	1									
maxInclusive	999									
annotation	documentation Facette zur Festlegung der 3-stelligen Ganzzahlenwerte									
source	<pre>&lt;simpleType name="Zahl3"&gt;   &lt;annotation&gt;     &lt;documentation&gt;Facette zur Festlegung der 3-stelligen Ganzzahlenwerte&lt;/documentation&gt;   &lt;/annotation&gt;   &lt;restriction base="xs:positiveInteger"&gt;     &lt;minInclusive value="1"/&gt;     &lt;maxInclusive value="999"/&gt;   &lt;/restriction&gt; &lt;/simpleType&gt;</pre>									

### simpleType **Zahl3\_1**

namespace	http://xml.ir-d.de/irdsaa															
type	restriction of <b>decimal</b>															
properties	base xs:decimal															
facets	<table border="1"> <thead> <tr> <th>Kind</th> <th>Value</th> <th>Annotation</th> </tr> </thead> <tbody> <tr> <td>minInclusive</td> <td>0.1</td> <td></td> </tr> <tr> <td>maxInclusive</td> <td>999.9</td> <td></td> </tr> <tr> <td>totalDigits</td> <td>4</td> <td></td> </tr> <tr> <td>fractionDigits</td> <td>1</td> <td></td> </tr> </tbody> </table>	Kind	Value	Annotation	minInclusive	0.1		maxInclusive	999.9		totalDigits	4		fractionDigits	1	
Kind	Value	Annotation														
minInclusive	0.1															
maxInclusive	999.9															
totalDigits	4															
fractionDigits	1															
annotation	documentation Facette zur Festlegung des Formats [NNN].[N]															
source	<pre>&lt;simpleType name="Zahl3_1"&gt;   &lt;annotation&gt;     &lt;documentation&gt;Facette zur Festlegung des Formats [NNN].[N]&lt;/documentation&gt;   &lt;/annotation&gt;   &lt;restriction base="xs:decimal"&gt;     &lt;totalDigits value="4"/&gt;     &lt;fractionDigits value="1"/&gt;     &lt;minInclusive value="0.1"/&gt;     &lt;maxInclusive value="999.9"/&gt;   &lt;/restriction&gt; &lt;/simpleType&gt;</pre>															

### simpleType **Zahl4**

namespace	http://xml.ir-d.de/irdsaa									
type	restriction of <b>positiveInteger</b>									
properties	base xs:positiveInteger									
facets	<table border="1"> <thead> <tr> <th>Kind</th> <th>Value</th> <th>Annotation</th> </tr> </thead> <tbody> <tr> <td>minInclusive</td> <td>1</td> <td></td> </tr> <tr> <td>maxInclusive</td> <td>9999</td> <td></td> </tr> </tbody> </table>	Kind	Value	Annotation	minInclusive	1		maxInclusive	9999	
Kind	Value	Annotation								
minInclusive	1									
maxInclusive	9999									

annotation	documentation Facette zur Festlegung der 4-stelligen Ganzzahlenwerte
source	<pre>&lt;simpleType name="Zahl4"&gt;   &lt;annotation&gt;     &lt;documentation&gt;Facette zur Festlegung der 4-stelligen Ganzzahlenwerte&lt;/documentation&gt;   &lt;/annotation&gt;   &lt;restriction base="xs:positiveInteger"&gt;     &lt;minInclusive value="1"/&gt;     &lt;maxInclusive value="9999"/&gt;   &lt;/restriction&gt; &lt;/simpleType&gt;</pre>

### simpleType Zahl5

namespace	http://xml.ir-d.de/irdsaa									
type	restriction of <b>positiveInteger</b>									
properties	base xs:positiveInteger									
facets	<table border="1"> <thead> <tr> <th>Kind</th> <th>Value</th> <th>Annotation</th> </tr> </thead> <tbody> <tr> <td>minInclusive</td> <td>1</td> <td></td> </tr> <tr> <td>maxInclusive</td> <td>99999</td> <td></td> </tr> </tbody> </table>	Kind	Value	Annotation	minInclusive	1		maxInclusive	99999	
Kind	Value	Annotation								
minInclusive	1									
maxInclusive	99999									
annotation	documentation Facette zur Festlegung der 5-stelligen Ganzzahlenwerte									
source	<pre>&lt;simpleType name="Zahl5"&gt;   &lt;annotation&gt;     &lt;documentation&gt;Facette zur Festlegung der 5-stelligen Ganzzahlenwerte&lt;/documentation&gt;   &lt;/annotation&gt;   &lt;restriction base="xs:positiveInteger"&gt;     &lt;minInclusive value="1"/&gt;     &lt;maxInclusive value="99999"/&gt;   &lt;/restriction&gt; &lt;/simpleType&gt;</pre>									

### simpleType Zahl5mitNull

namespace	http://xml.ir-d.de/irdsaa									
type	restriction of <b>integer</b>									
properties	base xs:integer									
facets	<table border="1"> <thead> <tr> <th>Kind</th> <th>Value</th> <th>Annotation</th> </tr> </thead> <tbody> <tr> <td>minInclusive</td> <td>0</td> <td></td> </tr> <tr> <td>maxInclusive</td> <td>99999</td> <td></td> </tr> </tbody> </table>	Kind	Value	Annotation	minInclusive	0		maxInclusive	99999	
Kind	Value	Annotation								
minInclusive	0									
maxInclusive	99999									
annotation	documentation Facette zur Festlegung der 5-stelligen Ganzzahlenwerte inklusive "0"									
source	<pre>&lt;simpleType name="Zahl5mitNull"&gt;   &lt;annotation&gt;     &lt;documentation&gt;Facette zur Festlegung der 5-stelligen Ganzzahlenwerte inklusive "0"&lt;/documentation&gt;   &lt;/annotation&gt;   &lt;restriction base="xs:integer"&gt;     &lt;minInclusive value="0"/&gt;     &lt;maxInclusive value="99999"/&gt;   &lt;/restriction&gt; &lt;/simpleType&gt;</pre>									

```

</restriction>
</simpleType>

```

### complexType MeldungIrdBasis

diagram	
namespace	http://xml.ir-d.de/irdsaa
children	<a href="#">MEL_IrdIdGesundheitseinrichtung</a>
used by	complexType <a href="#">Selbstauskunft</a>
source	<pre> &lt;complexType name="MeldungIrdBasis"&gt;   &lt;sequence&gt;     &lt;element name="MEL_IrdIdGesundheitseinrichtung" type="IdEinrichtung"/&gt;   &lt;/sequence&gt; &lt;/complexType&gt; </pre>

### element MeldungIrdBasis/MEL\_IrdIdGesundheitseinrichtung

diagram							
type	<a href="#">IdEinrichtung</a>						
properties	content simple						
facets	<table border="1"> <tr> <td>Kind</td> <td>Value</td> <td>Annotation</td> </tr> <tr> <td>pattern</td> <td>(IRD-GE-[0-9]{8})</td> <td></td> </tr> </table>	Kind	Value	Annotation	pattern	(IRD-GE-[0-9]{8})	
Kind	Value	Annotation					
pattern	(IRD-GE-[0-9]{8})						
source	<pre> &lt;element name="MEL_IrdIdGesundheitseinrichtung" type="IdEinrichtung"/&gt; </pre>						

### complexType SelbstauskunftFallBasis

diagram	
namespace	http://xml.ir-d.de/irdsaa
children	<a href="#">FAL_Transfernummer</a>
used by	element <a href="#">Selbstauskunft/fall</a>
source	<pre> &lt;complexType name="SelbstauskunftFallBasis"&gt;   &lt;sequence&gt;     &lt;element name="FAL_Transfernummer" type="Transfernummer"/&gt;   &lt;/sequence&gt; &lt;/complexType&gt; </pre>

element **SelbstauskunftFalBasis/FAL\_Transfernummer**

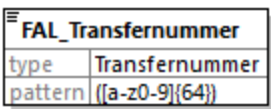
diagram							
type	<a href="#">Transfernummer</a>						
properties	content simple						
facets	<table border="1"> <thead> <tr> <th>Kind</th> <th>Value</th> <th>Annotation</th> </tr> </thead> <tbody> <tr> <td>pattern</td> <td>([a-z0-9]{64})</td> <td></td> </tr> </tbody> </table>	Kind	Value	Annotation	pattern	([a-z0-9]{64})	
Kind	Value	Annotation					
pattern	([a-z0-9]{64})						
source	<code>&lt;element name="FAL_Transfernummer" type="Transfernummer"/&gt;</code>						

simpleType **DatumText**

namespace	http://xml.ir-d.de/emg						
type	restriction of <b>token</b>						
properties	base xs:token						
used by	element <a href="#">ArtikelbeschreibungBasis/ARB DatumImplantierung Explantat</a>						
facets	<table border="1"> <thead> <tr> <th>Kind</th> <th>Value</th> <th>Annotation</th> </tr> </thead> <tbody> <tr> <td>pattern</td> <td>(([0-9]{4})([-][0-9]{2})?([-][0-9]{2})?)</td> <td></td> </tr> </tbody> </table>	Kind	Value	Annotation	pattern	(([0-9]{4})([-][0-9]{2})?([-][0-9]{2})?)	
Kind	Value	Annotation					
pattern	(([0-9]{4})([-][0-9]{2})?([-][0-9]{2})?)						
annotation	documentation Facette zur Festlegung des freien Datumformats: JJJ[-MM[-TT]]						
source	<pre>&lt;simpleType name="DatumText"&gt;   &lt;annotation&gt;     &lt;documentation&gt;Facette zur Festlegung des freien Datumformats:     JJJ[-MM[-TT]]&lt;/documentation&gt;   &lt;/annotation&gt;   &lt;restriction base="xs:token"&gt;     &lt;pattern value="(([0-9]{4})([-][0-9]{2})?([-][0-9]{2})?)"/&gt;   &lt;/restriction&gt; &lt;/simpleType&gt;</pre>						

simpleType **Freitext250**

namespace	http://xml.ir-d.de/emg						
type	restriction of <b>token</b>						
properties	base xs:token						
used by	elements <a href="#">ArtikelAortenklappeBasis/AAK HerstellerSonstiger</a> <a href="#">ArtikelBrustimplantatBasis/ABI HerstellerSonstiger</a> <a href="#">ArtikelEndoprotheseBasis/AEP HerstellerSonstiger</a> <a href="#">ArtikelbeschreibungBasis/ARB Artikelbezeichnung</a> <a href="#">ArtikelbeschreibungBasis/ARB Barcode</a> <a href="#">OperationEndoprotheseBasis/OEP GrundWechselErlaeuterung</a> <a href="#">VorbehandlungEndoprotheseBasis/VEP VorOpErlaeuterung</a> <a href="#">ZubehoerBrustimplantatBasis/ZBI HerstellerSonstiger</a> <a href="#">ZubehoerEndoprotheseBasis/ZEP HerstellerSonstiger</a> <a href="#">ZubehoerBasis/ZUB Artikelbezeichnung</a>						
facets	<table border="1"> <thead> <tr> <th>Kind</th> <th>Value</th> <th>Annotation</th> </tr> </thead> <tbody> <tr> <td>maxLength</td> <td>250</td> <td></td> </tr> </tbody> </table>	Kind	Value	Annotation	maxLength	250	
Kind	Value	Annotation					
maxLength	250						
annotation	documentation Facette zur Festlegung des Freitextes von 250 Zeichen						
source	<pre>&lt;simpleType name="Freitext250"&gt;   &lt;annotation&gt;     &lt;documentation&gt;Facette zur Festlegung des Freitextes von 250</pre>						

	<pre> Zeichen&lt;/documentation&gt; &lt;/annotation&gt; &lt;restriction base="xs:token"&gt;   &lt;maxLength value="250"/&gt; &lt;/restriction&gt; &lt;/simpleType&gt; </pre>
--	--

### simpleType **Freitext500**

namespace	http://xml.ir-d.de/emg						
type	restriction of <b>token</b>						
properties	base xs:token						
facets	<table border="1"> <thead> <tr> <th>Kind</th> <th>Value</th> <th>Annotation</th> </tr> </thead> <tbody> <tr> <td>maxLength</td> <td>500</td> <td></td> </tr> </tbody> </table>	Kind	Value	Annotation	maxLength	500	
Kind	Value	Annotation					
maxLength	500						
annotation	documentation Facette zur Festlegung des Freitextes von 500 Zeichen						
source	<pre> &lt;simpleType name="Freitext500"&gt;   &lt;annotation&gt;     &lt;documentation&gt;Facette zur Festlegung des Freitextes von 500 Zeichen&lt;/documentation&gt;   &lt;/annotation&gt;   &lt;restriction base="xs:token"&gt;     &lt;maxLength value="500"/&gt;   &lt;/restriction&gt; &lt;/simpleType&gt; </pre>						

### simpleType **HashString**

namespace	http://xml.ir-d.de/emg						
type	restriction of <b>token</b>						
properties	base xs:token						
facets	<table border="1"> <thead> <tr> <th>Kind</th> <th>Value</th> <th>Annotation</th> </tr> </thead> <tbody> <tr> <td>maxLength</td> <td>512</td> <td></td> </tr> </tbody> </table>	Kind	Value	Annotation	maxLength	512	
Kind	Value	Annotation					
maxLength	512						
annotation	documentation Facette zur Festlegung des Hash-Strings der Meldebestätigung						
source	<pre> &lt;simpleType name="HashString"&gt;   &lt;annotation&gt;     &lt;documentation&gt;Facette zur Festlegung des Hash-Strings der Meldebestätigung&lt;/documentation&gt;   &lt;/annotation&gt;   &lt;restriction base="xs:token"&gt;     &lt;maxLength value="512"/&gt;   &lt;/restriction&gt; &lt;/simpleType&gt; </pre>						

### simpleType **HashWert**

namespace	http://xml.ir-d.de/emg
type	restriction of <b>token</b>
properties	base xs:token

facets	Kind Value Annotation length 64
annotation	documentation Facette zur Festlegung des Hashwertes der Meldebestätigung
source	<pre>&lt;simpleType name="HashWert"&gt;   &lt;annotation&gt;     &lt;documentation&gt;Facette zur Festlegung des Hashwertes der Meldebestätigung&lt;/documentation&gt;   &lt;/annotation&gt;   &lt;restriction base="xs:token"&gt;     &lt;length value="64"/&gt;   &lt;/restriction&gt; &lt;/simpleType&gt;</pre>

### simpleType ICD

namespace	http://xml.ir-d.de/emg
type	restriction of <b>token</b>
properties	base xs:token
used by	elements <a href="#">DiagnoseAortenklappeBasis/DAK IcdSchluessel</a> <a href="#">DiagnoseBrustimplantatBasis/DBI IcdSchluessel</a> <a href="#">DiagnoseEndoprotheseBasis/DEP IcdSchluessel</a>
facets	Kind Value Annotation pattern ([a-zA-Z][0-9]{2}(\.[0-9]{1,2})?(:[RLB])?)
annotation	documentation Facette zur Festlegung des ICD Code
source	<pre>&lt;simpleType name="ICD"&gt;   &lt;annotation&gt;     &lt;documentation&gt;Facette zur Festlegung des ICD Code&lt;/documentation&gt;   &lt;/annotation&gt;   &lt;restriction base="xs:token"&gt;     &lt;pattern value="([a-zA-Z][0-9]{2}(\.[0-9]{1,2})?(:[RLB])?)"/&gt;   &lt;/restriction&gt; &lt;/simpleType&gt;</pre>

### simpleType IdEinrichtung

namespace	http://xml.ir-d.de/emg
type	restriction of <b>token</b>
properties	base xs:token
used by	element <a href="#">MeldungBasis/MEL IrdIdGesundheitseinrichtung</a>
facets	Kind Value Annotation pattern (IRD-GE-[0-9]{8})
annotation	documentation Facette zur Festlegung der Gesundheitseinrichtung-ID
source	<pre>&lt;simpleType name="IdEinrichtung"&gt;   &lt;annotation&gt;     &lt;documentation&gt;Facette zur Festlegung der Gesundheitseinrichtung-ID&lt;/documentation&gt;   &lt;/annotation&gt;   &lt;restriction base="xs:token"&gt;     &lt;pattern value="(IRD-GE-[0-9]{8})"/&gt;   &lt;/restriction&gt;</pre>



	<code>&lt;/simpleType&gt;</code>
--	----------------------------------

### simpleType IrdArtikelId

namespace	http://xml.ir-d.de/emg						
type	restriction of <b>token</b>						
properties	base xs:token						
used by	element <a href="#">ArtikelidentifikationBasis/ARI IrdNummer</a>						
facets	<table border="1"> <thead> <tr> <th>Kind</th> <th>Value</th> <th>Annotation</th> </tr> </thead> <tbody> <tr> <td>maxLength</td> <td>16</td> <td></td> </tr> </tbody> </table>	Kind	Value	Annotation	maxLength	16	
Kind	Value	Annotation					
maxLength	16						
annotation	documentation Facette zur Festlegung der IrdNummer						
source	<pre>&lt;simpleType name="IrdArtikelId"&gt;   &lt;annotation&gt;     &lt;documentation&gt;Facette zur Festlegung der IrdNummer&lt;/documentation&gt;   &lt;/annotation&gt;   &lt;restriction base="xs:token"&gt;     &lt;maxLength value="16"/&gt;   &lt;/restriction&gt; &lt;/simpleType&gt;</pre>						

### simpleType IrdSpezVersion

namespace	http://xml.ir-d.de/emg						
type	restriction of <b>token</b>						
properties	base xs:token						
used by	element <a href="#">MeldungBasis/MEL IrdSpezVersion</a>						
facets	<table border="1"> <thead> <tr> <th>Kind</th> <th>Value</th> <th>Annotation</th> </tr> </thead> <tbody> <tr> <td>pattern</td> <td>(([1-9] [1-9][0-9])\.\d{1}[0-9])\.\d{1}[0-9])</td> <td></td> </tr> </tbody> </table>	Kind	Value	Annotation	pattern	(([1-9] [1-9][0-9])\.\d{1}[0-9])\.\d{1}[0-9])	
Kind	Value	Annotation					
pattern	(([1-9] [1-9][0-9])\.\d{1}[0-9])\.\d{1}[0-9])						
annotation	documentation Facette zur Festlegung der Version der IRD-Spezifikation						
source	<pre>&lt;simpleType name="IrdSpezVersion"&gt;   &lt;annotation&gt;     &lt;documentation&gt;Facette zur Festlegung der Version der IRD-Spezifikation&lt;/documentation&gt;   &lt;/annotation&gt;   &lt;restriction base="xs:token"&gt;     &lt;pattern value="(([1-9] [1-9][0-9])\.\d{1}[0-9])\.\d{1}[0-9])"/&gt;   &lt;/restriction&gt; &lt;/simpleType&gt;</pre>						

### simpleType JaLeer

namespace	http://xml.ir-d.de/emg
type	restriction of <b>integer</b>
properties	base xs:integer
used by	elements <a href="#">ArtikelAortenklappeBasis/AAK Dislokation</a> <a href="#">ArtikelAortenklappeBasis/AAK HerstellerUnbekannt</a> <a href="#">ArtikelAortenklappeBasis/AAK ProthesenGroesseUnbekannt</a> <a href="#">ArtikelBrustimplantatBasis/ABI FormUnbekannt</a>

	<a href="#">ArtikelBrustimplantatBasis/ABI_FuellungUnbekannt</a> <a href="#">ArtikelBrustimplantatBasis/ABI_HerstellerUnbekannt</a> <a href="#">ArtikelBrustimplantatBasis/ABI_OberflaecheUnbekannt</a> <a href="#">ArtikelBrustimplantatBasis/ABI_VolumenUnbekannt</a> <a href="#">ArtikelEndoprotheseBasis/AEP_HerstellerUnbekannt</a> <a href="#">ArtikelbeschreibungBasis/ARB_DatumImplantierungExplantatUnbekannt</a> <a href="#">ArtikelbeschreibungBasis/ARB_DatumVerfallUnbekannt</a> <a href="#">ArtikelbeschreibungBasis/ARB_LotNummerUnbekannt</a> <a href="#">ArtikelbeschreibungBasis/ARB_SerienNummerUnbekannt</a> <a href="#">ArtikelidentifikationBasis/ARI_ArtikelkennzeichenUnbekannt</a> <a href="#">OperationAortenklappeBasis/OAK_AbklemmzeitUnbekannt</a> <a href="#">OperationAortenklappeBasis/OAK_BypasszeitUnbekannt</a> <a href="#">OperationAortenklappeBasis/OAK_DeltaPmeanNachOpUnbekannt</a> <a href="#">OperationAortenklappeBasis/OAK_DistanzLcaUnbekannt</a> <a href="#">OperationAortenklappeBasis/OAK_DistanzRcaUnbekannt</a> <a href="#">OperationAortenklappeBasis/OAK_PtcaNachDurchmesserUnbekannt</a> <a href="#">OperationAortenklappeBasis/OAK_PtcaVorDurchmesserUnbekannt</a> <a href="#">OperationAortenklappeBasis/OAK_ZugangsGefaessUnbekannt</a> <a href="#">PatientenaufnahmeAortenklappeBasis/PAA_AkoefUnbekannt</a> <a href="#">PatientenaufnahmeAortenklappeBasis/PAA_CtCalciumUnbekannt</a> <a href="#">PatientenaufnahmeAortenklappeBasis/PAA_DeltaPmaxUnbekannt</a> <a href="#">PatientenaufnahmeAortenklappeBasis/PAA_DeltaPmeanUnbekannt</a> <a href="#">PatientenaufnahmeAortenklappeBasis/PAA_DeltaPUnbekannt</a> <a href="#">PatientenaufnahmeKardiologieBasis/PKA_KreatininwertUnbekannt</a> <a href="#">PatientenaufnahmeKardiologieBasis/PKA_LvefUnbekannt</a> <a href="#">PostoperationAortenklappeBasis/POA_AkoefUnbekannt</a> <a href="#">PostoperationAortenklappeBasis/POA_DeltaPmaxUnbekannt</a> <a href="#">PostoperationAortenklappeBasis/POA_DeltaPmeanUnbekannt</a> <a href="#">PostoperationAortenklappeBasis/POA_LvefUnbekannt</a> <a href="#">PostoperationAortenklappeBasis/POA_MaxKreatininUnbekannt</a> <a href="#">ZubehoerBrustimplantatBasis/ZBI_HerstellerUnbekannt</a> <a href="#">ZubehoerEndoprotheseBasis/ZEP_HerstellerUnbekannt</a> <a href="#">ZubehoerBasis/ZUB_ArtikelNummerUnbekannt</a> <a href="#">ZubehoerBasis/ZUB_LotNummerUnbekannt</a> <a href="#">ZubehoerBasis/ZUB_SerienNummerUnbekannt</a>						
facets	<table border="1"> <thead> <tr> <th>Kind</th> <th>Value</th> <th>Annotation</th> </tr> </thead> <tbody> <tr> <td>pattern</td> <td>(1)</td> <td></td> </tr> </tbody> </table>	Kind	Value	Annotation	pattern	(1)	
Kind	Value	Annotation					
pattern	(1)						
annotation	documentation Facette zur Festlegung des Unbekannt-Wertes (Bedeutung 1=true)						
source	<pre>&lt;simpleType name="JaLeer"&gt;   &lt;annotation&gt;     &lt;documentation&gt;Facette zur Festlegung des Unbekannt-Wertes (Bedeutung 1=true)&lt;/documentation&gt;   &lt;/annotation&gt;   &lt;restriction base="xs:integer"&gt;     &lt;pattern value="(1)"/&gt;   &lt;/restriction&gt; &lt;/simpleType&gt;</pre>						

### simpleType Meldebestaetigung

namespace	http://xml.ir-d.de/emg						
type	restriction of <b>token</b>						
properties	base xs:token						
facets	<table border="1"> <thead> <tr> <th>Kind</th> <th>Value</th> <th>Annotation</th> </tr> </thead> <tbody> <tr> <td>length</td> <td>10</td> <td></td> </tr> </tbody> </table>	Kind	Value	Annotation	length	10	
Kind	Value	Annotation					
length	10						
annotation	documentation Facette zur Festlegung der Meldebestätigungslaenge von 10 Zeichen						
source	<pre>&lt;simpleType name="Meldebestaetigung"&gt;   &lt;annotation&gt;</pre>						

	<pre> &lt;documentation&gt;Facette zur Festlegung der Meldebestätigungslaenge von 10 Zeichen&lt;/documentation&gt; &lt;/annotation&gt; &lt;restriction base="xs:token"&gt;   &lt;length value="10"/&gt; &lt;/restriction&gt; &lt;/simpleType&gt; </pre>
--	---

### simpleType OPS

namespace	http://xml.ir-d.de/emg		
type	restriction of <b>token</b>		
properties	base xs:token		
used by	elements <a href="#">AusloeserBasis/ALR ProzedurenSchluessel</a> <a href="#">ProzedurenSchluesselAortenklappeBasis/PAK ProzedurenSchluessel</a> <a href="#">ProzedurenSchluesselBrustimplantatBasis/PBI ProzedurenSchluessel</a> <a href="#">ProzedurenSchluesselEndoprotheseBasis/PEP ProzedurenSchluessel</a>		
facets	Kind	Value	Annotation
	pattern	(([135689]\-([0-9]){2}([a-zA-Z0-9]){1}\.([a-zA-Z0-9]{1,2}))*(:[RLBr1b])?)	
annotation	documentation Facette zur Festlegung des Prozedurenschlüssels		
source	<pre> &lt;simpleType name="OPS"&gt;   &lt;annotation&gt;     &lt;documentation&gt;Facette zur Festlegung des Prozedurenschlüssels&lt;/documentation&gt;   &lt;/annotation&gt;   &lt;restriction base="xs:token"&gt;     &lt;pattern value="([135689]\-([0-9]){2}([a-zA-Z0-9]){1}\.([a-zA-Z0-9]{1,2}))*(:[RLBr1b]) ?)" /&gt;   &lt;/restriction&gt; &lt;/simpleType&gt; </pre>		

### simpleType String2

namespace	http://xml.ir-d.de/emg		
type	restriction of <b>token</b>		
properties	base xs:token		
used by	element <a href="#">EntlassungBasis/ENT GrundSchluessel</a>		
facets	Kind	Value	Annotation
	pattern	(([0-9]{2})	
annotation	documentation Facette zur Festlegung des kodierten Entlassungsgrundes		
source	<pre> &lt;simpleType name="String2"&gt;   &lt;annotation&gt;     &lt;documentation&gt;Facette zur Festlegung des kodierten Entlassungsgrundes&lt;/documentation&gt;   &lt;/annotation&gt;   &lt;restriction base="xs:token"&gt;     &lt;pattern value="([0-9]{2})" /&gt;   &lt;/restriction&gt; </pre>		

	<code>&lt;/simpleType&gt;</code>
--	----------------------------------

### simpleType **String20**

namespace	http://xml.ir-d.de/emg
type	restriction of <b>token</b>
properties	base xs:token
used by	elements <a href="#">ArtikelbeschreibungBasis/ARB DatumVerfall</a> <a href="#">ArtikelbeschreibungBasis/ARB LotNummer</a> <a href="#">ArtikelbeschreibungBasis/ARB SerienNummer</a> <a href="#">ArtikelidentifikationBasis/ARI Artikelkennzeichen</a> <a href="#">ZubehoerBasis/ZUB ArtikelNummer</a> <a href="#">ZubehoerBasis/ZUB LotNummer</a> <a href="#">ZubehoerBasis/ZUB SerienNummer</a>
facets	Kind Value Annotation maxLength 20
annotation	documentation Facette zur Festlegung von: Artikel-, Ident-, Serien-, Lot-Nummer des Produkts
source	<pre>&lt;simpleType name="String20"&gt;   &lt;annotation&gt;     &lt;documentation&gt;Facette zur Festlegung von: Artikel-, Ident-, Serien-,     Lot-Nummer des Produkts&lt;/documentation&gt;   &lt;/annotation&gt;   &lt;restriction base="xs:token"&gt;     &lt;maxLength value="20"/&gt;   &lt;/restriction&gt; &lt;/simpleType&gt;</pre>

### simpleType **Sw**

namespace	http://xml.ir-d.de/emg
type	restriction of <b>token</b>
properties	base xs:token
used by	elements <a href="#">MeldungBasis/MEL SwHersteller</a> <a href="#">MeldungBasis/MEL SwName</a> <a href="#">MeldungBasis/MEL SwVersion</a>
facets	Kind Value Annotation maxLength 120
annotation	documentation Facette für Merkmale der externen Software
source	<pre>&lt;simpleType name="Sw"&gt;   &lt;annotation&gt;     &lt;documentation&gt;Facette für Merkmale der externen Software&lt;/documentation&gt;   &lt;/annotation&gt;   &lt;restriction base="xs:token"&gt;     &lt;maxLength value="120"/&gt;   &lt;/restriction&gt; &lt;/simpleType&gt;</pre>

### simpleType **Transfernummer**

namespace	http://xml.ir-d.de/emg
type	restriction of <b>token</b>
properties	base xs:token

used by	element <a href="#">FallBasis/FAL Transfervummer</a>
facets	Kind Value Annotation pattern ([a-z0-9]{64})
annotation	documentation Facette zur Festlegung der Transfervummer
source	<pre>&lt;simpleType name="Transfervummer"&gt;   &lt;annotation&gt;     &lt;documentation&gt;Facette zur Festlegung der Transfervummer&lt;/documentation&gt;   &lt;/annotation&gt;   &lt;restriction base="xs:token"&gt;     &lt;pattern value="([a-z0-9]{64})"/&gt;   &lt;/restriction&gt; &lt;/simpleType&gt;</pre>

### simpleType Versionsnummer

namespace	http://xml.ir-d.de/emg
type	restriction of <b>token</b>
properties	base xs:token
used by	element <a href="#">FallBasis/FAL Versionsnummer</a>
facets	Kind Value Annotation maxLength 10
annotation	documentation Facette zur Festlegung der Versionsnummer des gelieferten Datensatzes
source	<pre>&lt;simpleType name="Versionsnummer"&gt;   &lt;annotation&gt;     &lt;documentation&gt;Facette zur Festlegung der Versionsnummer des gelieferten     Datensatzes&lt;/documentation&gt;   &lt;/annotation&gt;   &lt;restriction base="xs:token"&gt;     &lt;maxLength value="10"/&gt;   &lt;/restriction&gt; &lt;/simpleType&gt;</pre>

### simpleType Zahl1

namespace	http://xml.ir-d.de/emg
type	restriction of <b>positiveInteger</b>
properties	base xs:positiveInteger
used by	elements <a href="#">OperationAortenklappeBasis/OAK LaesionenAnzahl</a> <a href="#">OperationAortenklappeBasis/OAK ProzedurenAnzahl</a>
facets	Kind Value Annotation minInclusive 1 maxInclusive 9
annotation	documentation Facette zur Festlegung der 1-stelligen Ganzzahlenwerte
source	<pre>&lt;simpleType name="Zahl1"&gt;   &lt;annotation&gt;     &lt;documentation&gt;Facette zur Festlegung der 1-stelligen     Ganzzahlenwerte&lt;/documentation&gt;   &lt;/annotation&gt;</pre>

	<pre> &lt;restriction base="xs:positiveInteger"&gt;   &lt;minInclusive value="1"/&gt;   &lt;maxInclusive value="9"/&gt; &lt;/restriction&gt; &lt;/simpleType&gt; </pre>
--	---

### simpleType **Zahl1\_1**

namespace	http://xml.ir-d.de/emg															
type	restriction of <b>decimal</b>															
properties	base xs:decimal															
used by	elements <a href="#">OperationAortenklappeBasis/OAK ZugangsGefaessdiameter</a> <a href="#">PatientenaufnahmeAortenklappeBasis/PAA Akoef</a> <a href="#">PostoperationAortenklappeBasis/POA Akoef</a>															
facets	<table border="1"> <thead> <tr> <th>Kind</th> <th>Value</th> <th>Annotation</th> </tr> </thead> <tbody> <tr> <td>minInclusive</td> <td>0.1</td> <td></td> </tr> <tr> <td>maxInclusive</td> <td>9.9</td> <td></td> </tr> <tr> <td>totalDigits</td> <td>2</td> <td></td> </tr> <tr> <td>fractionDigits</td> <td>1</td> <td></td> </tr> </tbody> </table>	Kind	Value	Annotation	minInclusive	0.1		maxInclusive	9.9		totalDigits	2		fractionDigits	1	
Kind	Value	Annotation														
minInclusive	0.1															
maxInclusive	9.9															
totalDigits	2															
fractionDigits	1															
annotation	documentation Facette zur Festlegung des Formats [N].[N]															
source	<pre> &lt;simpleType name="Zahl1_1"&gt;   &lt;annotation&gt;     &lt;documentation&gt;Facette zur Festlegung des Formats [N].[N]&lt;/documentation&gt;   &lt;/annotation&gt;   &lt;restriction base="xs:decimal"&gt;     &lt;totalDigits value="2"/&gt;     &lt;fractionDigits value="1"/&gt;     &lt;minInclusive value="0.1"/&gt;     &lt;maxInclusive value="9.9"/&gt;   &lt;/restriction&gt; &lt;/simpleType&gt; </pre>															

### simpleType **Zahl2**

namespace	http://xml.ir-d.de/emg									
type	restriction of <b>positiveInteger</b>									
properties	base xs:positiveInteger									
used by	elements <a href="#">ArtikelAortenklappeBasis/AAK ProthesenGroesse</a> <a href="#">OperationAortenklappeBasis/OAK AortenklappenOpAnzahl</a> <a href="#">OperationAortenklappeBasis/OAK NummerEingriff</a> <a href="#">OperationAortenklappeBasis/OAK PtcaNachAnzahl</a> <a href="#">OperationAortenklappeBasis/OAK PtcaNachDurchmesser</a> <a href="#">OperationAortenklappeBasis/OAK PtcaVorAnzahl</a> <a href="#">OperationAortenklappeBasis/OAK PtcaVorDurchmesser</a>									
facets	<table border="1"> <thead> <tr> <th>Kind</th> <th>Value</th> <th>Annotation</th> </tr> </thead> <tbody> <tr> <td>minInclusive</td> <td>1</td> <td></td> </tr> <tr> <td>maxInclusive</td> <td>99</td> <td></td> </tr> </tbody> </table>	Kind	Value	Annotation	minInclusive	1		maxInclusive	99	
Kind	Value	Annotation								
minInclusive	1									
maxInclusive	99									
annotation	documentation Facette zur Festlegung der 2-stelligen Ganzzahlenwerte									
source	<pre> &lt;simpleType name="Zahl2"&gt;   &lt;annotation&gt;     &lt;documentation&gt;Facette zur Festlegung der 2-stelligen Ganzzahlenwerte&lt;/documentation&gt; </pre>									

	<pre> &lt;/annotation&gt; &lt;restriction base="xs:positiveInteger"&gt;   &lt;minInclusive value="1"/&gt;   &lt;maxInclusive value="99"/&gt; &lt;/restriction&gt; &lt;/simpleType&gt; </pre>
--	--

### simpleType **Zahl2\_1**

namespace	http://xml.ir-d.de/emg															
type	restriction of <b>decimal</b>															
properties	base xs:decimal															
used by	elements <a href="#">PatientenaufnahmeKardiologieBasis/PKA KreatininwertMqdl</a> <a href="#">PostoperationAortenklappeBasis/POA MaxKreatininMqDI</a>															
facets	<table border="1"> <thead> <tr> <th>Kind</th> <th>Value</th> <th>Annotation</th> </tr> </thead> <tbody> <tr> <td>minInclusive</td> <td>0.1</td> <td></td> </tr> <tr> <td>maxInclusive</td> <td>99.9</td> <td></td> </tr> <tr> <td>totalDigits</td> <td>3</td> <td></td> </tr> <tr> <td>fractionDigits</td> <td>1</td> <td></td> </tr> </tbody> </table>	Kind	Value	Annotation	minInclusive	0.1		maxInclusive	99.9		totalDigits	3		fractionDigits	1	
Kind	Value	Annotation														
minInclusive	0.1															
maxInclusive	99.9															
totalDigits	3															
fractionDigits	1															
annotation	documentation Facette zur Festlegung des Formats [NN].[N]															
source	<pre> &lt;simpleType name="Zahl2_1"&gt;   &lt;annotation&gt;     &lt;documentation&gt;Facette zur Festlegung des Formats [NN].[N]&lt;/documentation&gt;   &lt;/annotation&gt;   &lt;restriction base="xs:decimal"&gt;     &lt;totalDigits value="3"/&gt;     &lt;fractionDigits value="1"/&gt;     &lt;minInclusive value="0.1"/&gt;     &lt;maxInclusive value="99.9"/&gt;   &lt;/restriction&gt; &lt;/simpleType&gt; </pre>															

### simpleType **Zahl3**

namespace	http://xml.ir-d.de/emg									
type	restriction of <b>positiveInteger</b>									
properties	base xs:positiveInteger									
used by	elements <a href="#">ArtikelidentifikationBasis/ARI LaufendeNummer</a> <a href="#">OperationAortenklappeBasis/OAK Abklemmzeit</a> <a href="#">OperationAortenklappeBasis/OAK Aortenklappenannulus</a> <a href="#">OperationAortenklappeBasis/OAK Bypasszeit</a> <a href="#">OperationAortenklappeBasis/OAK DeltaPmeanNachOp</a> <a href="#">OperationAortenklappeBasis/OAK DistanzLca</a> <a href="#">OperationAortenklappeBasis/OAK DistanzRca</a> <a href="#">OperationAortenklappeBasis/OAK Eingriffsdauer</a> <a href="#">OperationBasis/OPE LaufendeNummer</a> <a href="#">PatientenaufnahmeAortenklappeBasis/PAA DeltaP</a> <a href="#">PatientenaufnahmeAortenklappeBasis/PAA DeltaPmax</a> <a href="#">PatientenaufnahmeAortenklappeBasis/PAA DeltaPmean</a> <a href="#">PatientenaufnahmeKardiologieBasis/PKA Lvef</a> <a href="#">PostoperationAortenklappeBasis/POA DeltaPmax</a> <a href="#">PostoperationAortenklappeBasis/POA DeltaPmean</a> <a href="#">PostoperationAortenklappeBasis/POA IntensivDauer</a> <a href="#">PostoperationAortenklappeBasis/POA Lvef</a> <a href="#">ZubehoerBasis/ZUB LaufendeNummer</a>									
facets	<table border="1"> <thead> <tr> <th>Kind</th> <th>Value</th> <th>Annotation</th> </tr> </thead> <tbody> <tr> <td>minInclusive</td> <td>1</td> <td></td> </tr> <tr> <td>maxInclusive</td> <td>999</td> <td></td> </tr> </tbody> </table>	Kind	Value	Annotation	minInclusive	1		maxInclusive	999	
Kind	Value	Annotation								
minInclusive	1									
maxInclusive	999									

annotation	documentation Facette zur Festlegung der 3-stelligen Ganzzahlenwerte
source	<pre>&lt;simpleType name="Zahl3"&gt;   &lt;annotation&gt;     &lt;documentation&gt;Facette zur Festlegung der 3-stelligen Ganzzahlenwerte&lt;/documentation&gt;   &lt;/annotation&gt;   &lt;restriction base="xs:positiveInteger"&gt;     &lt;minInclusive value="1"/&gt;     &lt;maxInclusive value="999"/&gt;   &lt;/restriction&gt; &lt;/simpleType&gt;</pre>

### simpleType Zahl3\_1

namespace	http://xml.ir-d.de/emg															
type	restriction of <b>decimal</b>															
properties	base xs:decimal															
used by	elements <a href="#">OperationAortenklappeBasis/OAK Durchleuchtungszeit</a> <a href="#">PatientenaufnahmeAortenklappeBasis/PAA StsScore</a>															
facets	<table border="1"> <thead> <tr> <th>Kind</th> <th>Value</th> <th>Annotation</th> </tr> </thead> <tbody> <tr> <td>minInclusive</td> <td>0.1</td> <td></td> </tr> <tr> <td>maxInclusive</td> <td>999.9</td> <td></td> </tr> <tr> <td>totalDigits</td> <td>4</td> <td></td> </tr> <tr> <td>fractionDigits</td> <td>1</td> <td></td> </tr> </tbody> </table>	Kind	Value	Annotation	minInclusive	0.1		maxInclusive	999.9		totalDigits	4		fractionDigits	1	
Kind	Value	Annotation														
minInclusive	0.1															
maxInclusive	999.9															
totalDigits	4															
fractionDigits	1															
annotation	documentation Facette zur Festlegung des Formats [NNN].[N]															
source	<pre>&lt;simpleType name="Zahl3_1"&gt;   &lt;annotation&gt;     &lt;documentation&gt;Facette zur Festlegung des Formats [NNN].[N]&lt;/documentation&gt;   &lt;/annotation&gt;   &lt;restriction base="xs:decimal"&gt;     &lt;totalDigits value="4"/&gt;     &lt;fractionDigits value="1"/&gt;     &lt;minInclusive value="0.1"/&gt;     &lt;maxInclusive value="999.9"/&gt;   &lt;/restriction&gt; &lt;/simpleType&gt;</pre>															

### simpleType Zahl4

namespace	http://xml.ir-d.de/emg									
type	restriction of <b>positiveInteger</b>									
properties	base xs:positiveInteger									
used by	elements <a href="#">PatientenaufnahmeKardiologieBasis/PKA KreatininwertMikromol</a> <a href="#">PostoperationAortenklappeBasis/POA MaxKreatininMikromol</a>									
facets	<table border="1"> <thead> <tr> <th>Kind</th> <th>Value</th> <th>Annotation</th> </tr> </thead> <tbody> <tr> <td>minInclusive</td> <td>1</td> <td></td> </tr> <tr> <td>maxInclusive</td> <td>9999</td> <td></td> </tr> </tbody> </table>	Kind	Value	Annotation	minInclusive	1		maxInclusive	9999	
Kind	Value	Annotation								
minInclusive	1									
maxInclusive	9999									
annotation	documentation Facette zur Festlegung der 4-stelligen Ganzzahlenwerte									
source	<pre>&lt;simpleType name="Zahl4"&gt;</pre>									



	<pre> &lt;annotation&gt;   &lt;documentation&gt;Facette zur Festlegung der 4-stelligen   Ganzzahlenwerte&lt;/documentation&gt; &lt;/annotation&gt; &lt;restriction base="xs:positiveInteger"&gt;   &lt;minInclusive value="1"/&gt;   &lt;maxInclusive value="9999"/&gt; &lt;/restriction&gt; &lt;/simpleType&gt; </pre>
--	---

### simpleType **Zahl5**

namespace	http://xml.ir-d.de/emg									
type	restriction of <b>positiveInteger</b>									
properties	base xs:positiveInteger									
used by	elements <a href="#">ArtikelBrustimplantatBasis/ABI Volumen</a> <a href="#">PatientenaufnahmeAortenklappeBasis/PAA CtCalcium ZubehoerEndoprotheseBasis/ZEP Menge</a>									
facets	<table border="1"> <thead> <tr> <th>Kind</th> <th>Value</th> <th>Annotation</th> </tr> </thead> <tbody> <tr> <td>minInclusive</td> <td>1</td> <td></td> </tr> <tr> <td>maxInclusive</td> <td>99999</td> <td></td> </tr> </tbody> </table>	Kind	Value	Annotation	minInclusive	1		maxInclusive	99999	
Kind	Value	Annotation								
minInclusive	1									
maxInclusive	99999									
annotation	documentation Facette zur Festlegung der 5-stelligen Ganzzahlenwerte									
source	<pre> &lt;simpleType name="Zahl5"&gt;   &lt;annotation&gt;     &lt;documentation&gt;Facette zur Festlegung der 5-stelligen     Ganzzahlenwerte&lt;/documentation&gt;   &lt;/annotation&gt;   &lt;restriction base="xs:positiveInteger"&gt;     &lt;minInclusive value="1"/&gt;     &lt;maxInclusive value="99999"/&gt;   &lt;/restriction&gt; &lt;/simpleType&gt; </pre>									

### simpleType **Zahl5mitNull**

namespace	http://xml.ir-d.de/emg									
type	restriction of <b>integer</b>									
properties	base xs:integer									
used by	element <a href="#">ArtikelBrustimplantatBasis/ABI IntraoperativesVolumen</a>									
facets	<table border="1"> <thead> <tr> <th>Kind</th> <th>Value</th> <th>Annotation</th> </tr> </thead> <tbody> <tr> <td>minInclusive</td> <td>0</td> <td></td> </tr> <tr> <td>maxInclusive</td> <td>99999</td> <td></td> </tr> </tbody> </table>	Kind	Value	Annotation	minInclusive	0		maxInclusive	99999	
Kind	Value	Annotation								
minInclusive	0									
maxInclusive	99999									
annotation	documentation Facette zur Festlegung der 5-stelligen Ganzzahlenwerte inklusive "0"									
source	<pre> &lt;simpleType name="Zahl5mitNull"&gt;   &lt;annotation&gt;     &lt;documentation&gt;Facette zur Festlegung der 5-stelligen Ganzzahlenwerte     inklusive "0"&lt;/documentation&gt;   &lt;/annotation&gt;   &lt;restriction base="xs:integer"&gt;     &lt;minInclusive value="0"/&gt;     &lt;maxInclusive value="99999"/&gt;   &lt;/restriction&gt; &lt;/simpleType&gt; </pre>									

```

</restriction>
</simpleType>

```

### complexType **FallBasis**

diagram	
namespace	http://xml.ir-d.de/emg
children	<a href="#">FAL Aufnahmedatum</a> <a href="#">FAL ArtAufenthaltSchluessel</a> <a href="#">FAL Transfernummer</a> <a href="#">FAL DatumZeitSatzErstellung</a> <a href="#">FAL Versionsnummer</a>
used by	complexType <a href="#">Fall</a>
source	<pre> &lt;complexType name="FallBasis"&gt;   &lt;sequence&gt;     &lt;element name="FAL_Aufnahmedatum" type="xs:date"/&gt;     &lt;element name="FAL_ArtAufenthaltSchluessel" type="enum_0065"/&gt;     &lt;element name="FAL_Transfernummer" type="Transfernummer"/&gt;     &lt;element name="FAL_DatumZeitSatzErstellung" type="xs:dateTime"/&gt;     &lt;element name="FAL_Versionsnummer" type="Versionsnummer" minOccurs="0"/&gt;   &lt;/sequence&gt; &lt;/complexType&gt; </pre>

### element **FallBasis/FAL\_Aufnahmedatum**

diagram	
type	<b>date</b>
properties	content simple
source	<pre>&lt;element name="FAL_Aufnahmedatum" type="xs:date"/&gt;</pre>

### element **FallBasis/FAL\_ArtAufenthaltSchluessel**

diagram	
---------	--

type	<a href="#">enum_0065</a>		
properties	content simple		
facets	Kind	Value	Annotation
	enumeration	0065001	documentation stationär
	enumeration	0065002	documentation teilstationär
	enumeration	0065003	documentation ambulant
source	<code>&lt;element name="FAL_ArtAufenthaltSchluessel" type="enum_0065"/&gt;</code>		

#### element FallBasis/FAL\_Transfernummer

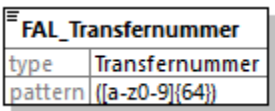
diagram			
type	<a href="#">Transfernummer</a>		
properties	content simple		
facets	Kind	Value	Annotation
	pattern	([a-z0-9]{64})	
source	<code>&lt;element name="FAL_Transfernummer" type="Transfernummer"/&gt;</code>		

#### element FallBasis/FAL\_DatumZeitSatzErstellung

diagram			
type	dateTime		
properties	content simple		
source	<code>&lt;element name="FAL_DatumZeitSatzErstellung" type="xs:dateTime"/&gt;</code>		

#### element FallBasis/FAL\_Versionsnummer

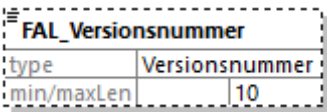
diagram			
type	<a href="#">Versionsnummer</a>		
properties	minOcc	0	
	maxOcc	1	
	content	simple	
facets	Kind	Value	Annotation
	maxLength	10	
source	<code>&lt;element name="FAL_Versionsnummer" type="Versionsnummer" minOccurs="0"/&gt;</code>		

### complexType **AusloeserBasis**

diagram	<p>The diagram shows a complexType <b>AusloeserBasis</b> containing a sequence of <b>ALR_ProzedurenSchluessel</b> elements. The <b>ALR_ProzedurenSchluessel</b> element is defined with type <b>OPS</b> and a pattern <code>(([135689]\-[0-9]){2})([a-zA-Z0-9]{1}\.[a-zA-Z0-9]{1,2})*(:[RLBrlb])?</code>.</p>
namespace	http://xml.ir-d.de/emg
children	<a href="#">ALR_ProzedurenSchluessel</a>
used by	element <a href="#">Fall/ausloeser</a>
source	<pre>&lt;complexType name="AusloeserBasis"&gt;   &lt;sequence&gt;     &lt;element name="ALR_ProzedurenSchluessel" type="OPS"/&gt;   &lt;/sequence&gt; &lt;/complexType&gt;</pre>

### element **AusloeserBasis/ALR\_ProzedurenSchluessel**

diagram	<p>The diagram shows the element <b>ALR_ProzedurenSchluessel</b> with type <b>OPS</b> and a pattern <code>(([135689]\-[0-9]){2})([a-zA-Z0-9]{1}\.[a-zA-Z0-9]{1,2})*(:[RLBrlb])?</code>.</p>						
type	<b>OPS</b>						
properties	content simple						
facets	<table border="1"> <thead> <tr> <th>Kind</th> <th>Value</th> <th>Annotation</th> </tr> </thead> <tbody> <tr> <td>pattern</td> <td><code>(([135689]\-[0-9]){2})([a-zA-Z0-9]{1}\.[a-zA-Z0-9]{1,2})*(:[RLBrlb])?</code></td> <td></td> </tr> </tbody> </table>	Kind	Value	Annotation	pattern	<code>(([135689]\-[0-9]){2})([a-zA-Z0-9]{1}\.[a-zA-Z0-9]{1,2})*(:[RLBrlb])?</code>	
Kind	Value	Annotation					
pattern	<code>(([135689]\-[0-9]){2})([a-zA-Z0-9]{1}\.[a-zA-Z0-9]{1,2})*(:[RLBrlb])?</code>						
source	<pre>&lt;element name="ALR_ProzedurenSchluessel" type="OPS"/&gt;</pre>						

### complexType **Patientenaufnahme**

diagram	<p>The diagram shows the complexType <b>Patientenaufnahme</b>. It is an extension of <b>PatientenaufnahmeBasis (extension)</b>, which contains a sequence of <b>PAT_Alter</b> (type <b>xs:integer</b>), <b>PAT_Groesse</b> (type <b>xs:integer</b>), <b>PAT_Gewicht</b> (type <b>xs:integer</b>), and <b>PAT_GeschlechtSchluessel</b> (type <b>enum_0070</b>). Additionally, <b>Patientenaufnahme</b> has two base types: <b>patientenaufnahmeBrustimplantat</b> (type <b>PatientenaufnahmeBrustimpl...</b>) and <b>patientenaufnahmeKardiologie</b> (type <b>PatientenaufnahmeKardiologie</b>).</p>
namespace	http://xml.ir-d.de/emg

type	extension of <a href="#">PatientenaufnahmeBasis</a>
properties	base <a href="#">PatientenaufnahmeBasis</a>
children	<a href="#">PAT Alter</a> <a href="#">PAT Groesse</a> <a href="#">PAT Gewicht</a> <a href="#">PAT GeschlechtSchluessel</a> <a href="#">patientenaufnahmeBrustimplantat</a> <a href="#">patientenaufnahmeKardiologie</a>
used by	element <a href="#">Fall/patientenaufnahme</a>
source	<pre> &lt;complexType name="Patientenaufnahme"&gt;   &lt;complexContent&gt;     &lt;extension base="PatientenaufnahmeBasis"&gt;       &lt;sequence&gt;         &lt;element name="patientenaufnahmeBrustimplantat" type="PatientenaufnahmeBrustimplantatBasis" minOccurs="0"/&gt;         &lt;element name="patientenaufnahmeKardiologie" type="PatientenaufnahmeKardiologie" minOccurs="0"/&gt;       &lt;/sequence&gt;     &lt;/extension&gt;   &lt;/complexContent&gt; &lt;/complexType&gt; </pre>

element **Patientenaufnahme/patientenaufnahmeBrustimplantat**

diagram	
type	<a href="#">PatientenaufnahmeBrustimplantatBasis</a>
properties	minOcc 0 maxOcc 1 content complex
children	<a href="#">PAB AutoimmunerkrankungSchluessel</a> <a href="#">PAB VerlaufAutoimmunerkrankungSchluessel</a>
source	<pre> &lt;element name="patientenaufnahmeBrustimplantat" type="PatientenaufnahmeBrustimplantatBasis" minOccurs="0"/&gt; </pre>

element **Patientenaufnahme/patientenaufnahmeKardiologie**

<p>diagram</p>	
<p>type</p>	<p><a href="#">PatientenaufnahmeKardiologie</a></p>
<p>properties</p>	<p>minOcc 0 maxOcc 1 content complex</p>
<p>children</p>	<p><a href="#">PKA NyhaSchluessel</a> <a href="#">PKA Lvef</a> <a href="#">PKA LvefUnbekannt</a> <a href="#">PKA DiabetesSchluessel</a> <a href="#">PKA NierenersatzSchluessel</a> <a href="#">PKA KreatininwertMgdl</a> <a href="#">PKA KreatininwertMikromol</a> <a href="#">PKA KreatininwertUnbekannt</a> <a href="#">patientenaufnahmeAortenklappe</a></p>
<p>source</p>	<pre>&lt;element name="patientenaufnahmeKardiologie" type="PatientenaufnahmeKardiologie" minOccurs="0"/&gt;</pre>

## complexType Operation

<p>diagram</p>	
<p>namespace</p>	<p>http://xml.ir-d.de/emg</p>
<p>type</p>	<p>extension of <a href="#">OperationBasis</a></p>
<p>properties</p>	<p>base <a href="#">OperationBasis</a></p>
<p>children</p>	<p><a href="#">OPE LaufendeNummer</a> <a href="#">OPE Datum</a> <a href="#">OPE SeitenLokalisationSchluessel</a> <a href="#">OPE AsaSchluessel</a>  <a href="#">OPE ImplantattypSchluessel</a> <a href="#">operationBrustimplantat</a> <a href="#">operationEndoprothese</a> <a href="#">operationAortenklappe</a>  <a href="#">artikelidentifikation</a> <a href="#">zubehoer</a></p>
<p>used by</p>	<p>element <a href="#">Fall/operation</a></p>
<p>source</p>	<pre>&lt;complexType name="Operation"&gt;   &lt;complexContent&gt;     &lt;extension base="OperationBasis"&gt;       &lt;sequence&gt;         &lt;choice&gt;           &lt;element name="operationBrustimplantat" type="OperationBrustimplantat"/&gt;           &lt;element name="operationEndoprothese" type="OperationEndoprothese"/&gt;           &lt;element name="operationAortenklappe" type="OperationAortenklappe"/&gt;         &lt;/choice&gt;         &lt;element name="artikelidentifikation" type="Artikelidentifikation" cardinality="0..∞"/&gt;         &lt;element name="zubehoer" type="Zubehoer" cardinality="0..∞"/&gt;       &lt;/sequence&gt;     &lt;/extension&gt;   &lt;/complexContent&gt; &lt;/complexType&gt;</pre>

```

minOccurs="0" maxOccurs="unbounded"/>
  <element name="zubehoer" type="Zubehoer" minOccurs="0"
maxOccurs="unbounded"/>
  </sequence>
</extension>
</complexContent>
</complexType>

```

element **Operation/operationBrustimplantat**

diagram

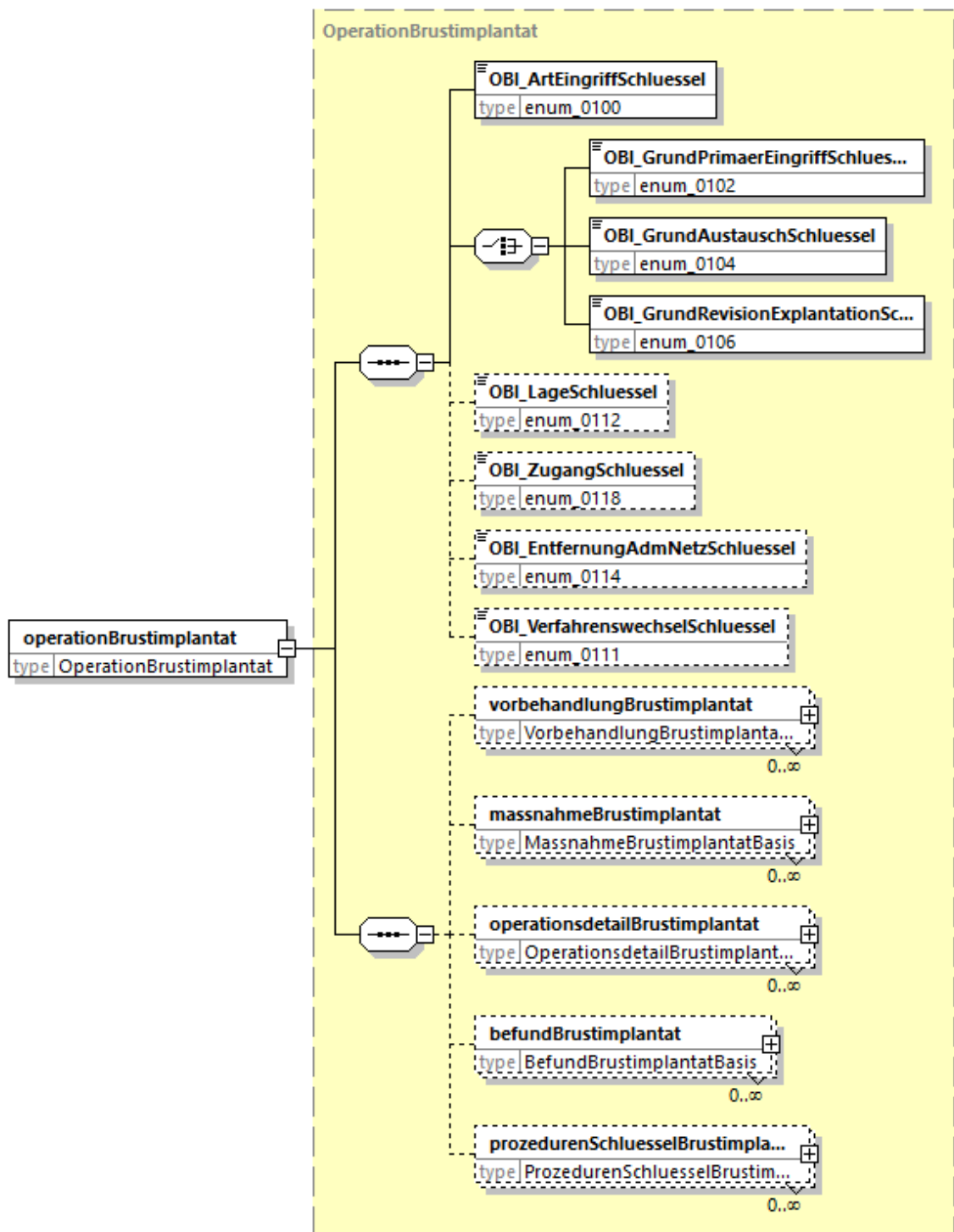



type	<a href="#">OperationBrustimplantat</a>
properties	content complex
children	<a href="#">OBI ArtEingriffSchluessel</a> <a href="#">OBI GrundPrimaerEingriffSchluessel</a> <a href="#">OBI GrundAustauschSchluessel</a> <a href="#">OBI GrundRevisionExplantationSchluessel</a> <a href="#">OBI LageSchluessel</a> <a href="#">OBI ZugangSchluessel</a> <a href="#">OBI EntfernungAdmNetzSchluessel</a> <a href="#">OBI VerfahrenswechselSchluessel</a> <a href="#">vorbehandlungBrustimplantat</a> <a href="#">massnahmeBrustimplantat</a> <a href="#">operationsdetailBrustimplantat</a> <a href="#">befundBrustimplantat</a> <a href="#">prozedurenSchluesselBrustimplantat</a>
source	<element name="operationBrustimplantat" type="OperationBrustimplantat"/>

element **Operation/operationEndoprothese**

diagram

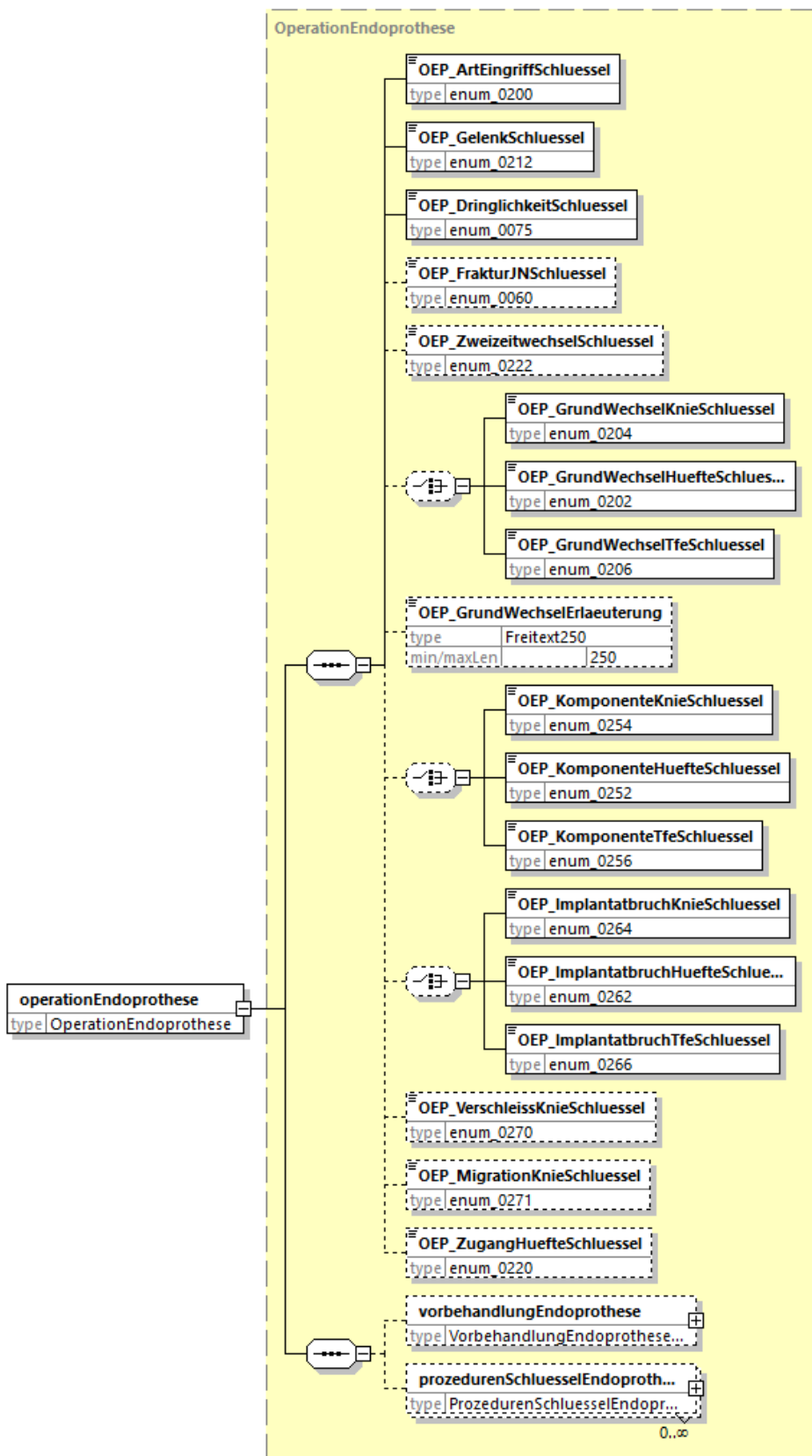

type [OperationEndoprothese](#)

properties content complex

children	<a href="#">OEP ArtEingriffSchluessel</a> <a href="#">OEP GelenkSchluessel</a> <a href="#">OEP DringlichkeitSchluessel</a> <a href="#">OEP FrakturJNSchluessel</a> <a href="#">OEP ZweizeitwechselSchluessel</a> <a href="#">OEP GrundWechselKnieSchluessel</a> <a href="#">OEP GrundWechselHuefteSchluessel</a> <a href="#">OEP GrundWechselTfeSchluessel</a> <a href="#">OEP GrundWechselErlaeuterung</a> <a href="#">OEP KomponenteKnieSchluessel</a> <a href="#">OEP KomponenteHuefteSchluessel</a> <a href="#">OEP KomponenteTfeSchluessel</a> <a href="#">OEP ImplantatbruchKnieSchluessel</a> <a href="#">OEP ImplantatbruchHuefteSchluessel</a> <a href="#">OEP ImplantatbruchTfeSchluessel</a> <a href="#">OEP VerschleissKnieSchluessel</a> <a href="#">OEP MigrationKnieSchluessel</a> <a href="#">OEP ZugangHuefteSchluessel</a> <a href="#">vorbehandlungEndoprothese prozedurenSchluesselEndoprothese</a>
source	<code>&lt;element name="operationEndoprothese" type="OperationEndoprothese"/&gt;</code>



children	<a href="#">OAK NummerEingriff</a> <a href="#">OAK ArtEingriffSchluessel</a> <a href="#">OAK GrundEingriffSchluessel</a> <a href="#">OAK DringlichkeitSchluessel</a> <a href="#">OAK ExplantationSchluessel</a> <a href="#">OAK IsoliertSchluessel</a> <a href="#">OAK ZugangKonventionellSchluessel</a> <a href="#">OAK ZugangKatheterSchluessel</a> <a href="#">OAK KomplikationenSchluessel</a> <a href="#">OAK TherapieLcoSchluessel</a> <a href="#">OAK Durchleuchtungszeit</a> <a href="#">OAK BeatmungSchluessel</a> <a href="#">OAK TroponinSchluessel</a> <a href="#">OAK InotropeSchluessel</a> <a href="#">OAK Eingriffsdauer</a> <a href="#">OAK EingriffsumfangSchluessel</a> <a href="#">OAK ProzedurenAnzahl</a> <a href="#">OAK VorgehenSchluessel</a> <a href="#">OAK Bypasszeit</a> <a href="#">OAK BypasszeitUnbekannt</a> <a href="#">OAK Abklemmzeit</a> <a href="#">OAK AbklemmzeitUnbekannt</a> <a href="#">OAK AortaThorakalSchluessel</a> <a href="#">OAK NeuroprotektionSchluessel</a> <a href="#">OAK KreislaufunterstuetzungSchluessel</a> <a href="#">OAK PraeOpUnterstuetzungSchluessel</a> <a href="#">OAK PraeOpMethodeSchluessel</a> <a href="#">OAK IntraOpUnterstuetzungSchluessel</a> <a href="#">OAK IntraOpMethodeSchluessel</a> <a href="#">OAK AortenklappenOpAnzahl</a> <a href="#">OAK ValveInValveSchluessel</a> <a href="#">OAK ZugangsGefaessdiameter</a> <a href="#">OAK ZugangsGefaessUnbekannt</a> <a href="#">OAK ZugangVerkalkungSchluessel</a> <a href="#">OAK Aortenklappenannulus</a> <a href="#">OAK MessmethodeSchluessel</a> <a href="#">OAK DistanzRca</a> <a href="#">OAK DistanzRcaUnbekannt</a> <a href="#">OAK DistanzLca</a> <a href="#">OAK DistanzLcaUnbekannt</a> <a href="#">OAK PtcaVorSchluessel</a> <a href="#">OAK PtcaVorDurchmesser</a> <a href="#">OAK PtcaVorDurchmesserUnbekannt</a> <a href="#">OAK PtcaVorAnzahl</a> <a href="#">OAK RapidPacingVorSchluessel</a> <a href="#">OAK RapidPacingIntraSchluessel</a> <a href="#">OAK PtcaNachSchluessel</a> <a href="#">OAK PtcaNachDurchmesser</a> <a href="#">OAK PtcaNachDurchmesserUnbekannt</a> <a href="#">OAK PtcaNachAnzahl</a> <a href="#">OAK RapidPacingNachSchluessel</a> <a href="#">OAK KonversionSchluessel</a> <a href="#">OAK SuccessSchluessel</a> <a href="#">OAK AnaesthesieSchluessel</a> <a href="#">OAK DeltaPmeanNachOp</a> <a href="#">OAK DeltaPmeanNachOpUnbekannt</a> <a href="#">OAK ResidualeInsuffizienzSchluessel</a> <a href="#">OAK ZugangVerschlussSchluessel</a> <a href="#">OAK ZusaezlichePciSchluessel</a> <a href="#">OAK PciWegenKhkSchluessel</a> <a href="#">OAK PciWegenKomplikationSchluessel</a> <a href="#">OAK LaesionenAnzahl</a> <a href="#">komplikationAortenklappe</a> <a href="#">taviAortenklappe</a> <a href="#">pciAortenklappe</a> <a href="#">failureGrundAortenklappe</a> <a href="#">prozedurenSchluesselAortenklappe</a>
source	<element name="operationAortenklappe" type="OperationAortenklappe"/>

element **Operation/artikelidentifikation**

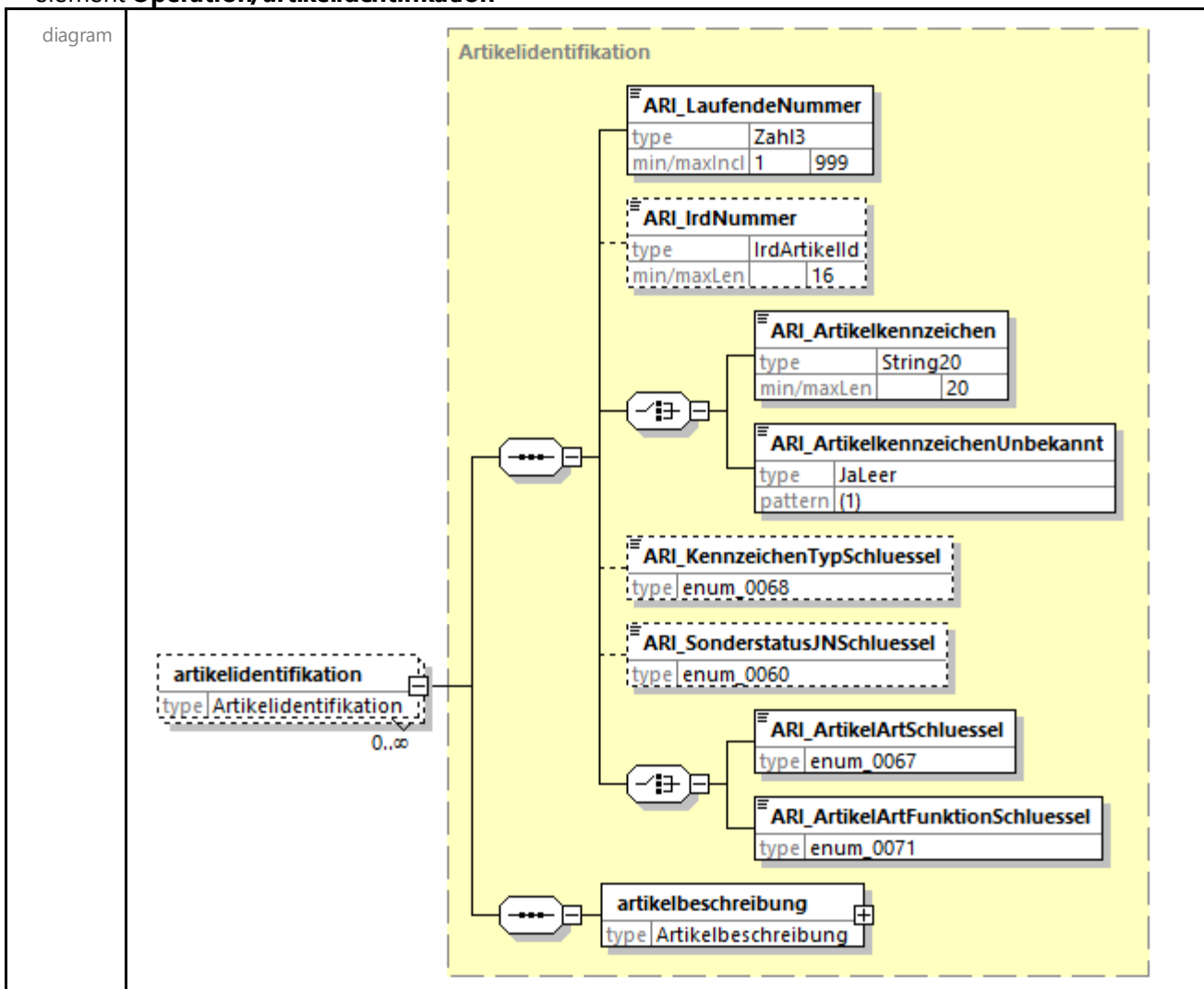

type	<a href="#">Artikelidentifikation</a>
properties	minOcc 0 maxOcc unbounded content complex
children	<a href="#">ARI LaufendeNummer</a> <a href="#">ARI IrdNummer</a> <a href="#">ARI Artikelkennzeichen</a> <a href="#">ARI ArtikelkennzeichenUnbekannt</a> <a href="#">ARI KennzeichenTypSchluessel</a> <a href="#">ARI SonderstatusJNSchluessel</a> <a href="#">ARI ArtikelArtSchluessel</a> <a href="#">ARI ArtikelArtFunktionSchluessel</a> <a href="#">artikelbeschreibung</a>
source	<element name="artikelidentifikation" type="Artikelidentifikation" minOccurs="0" maxOccurs="unbounded"/>

element **Operation/zubehoer**

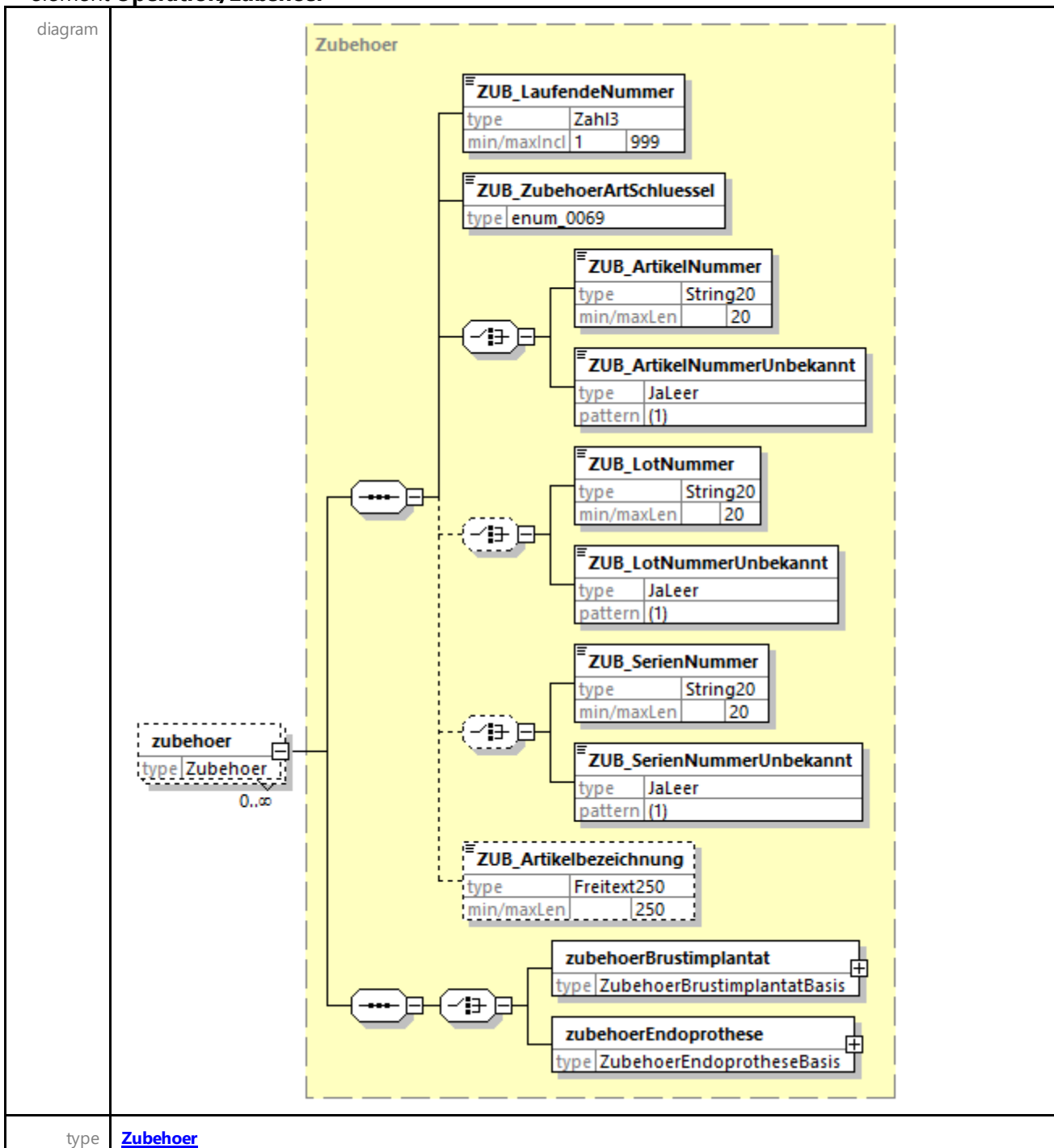

properties	minOcc 0 maxOcc unbounded content complex
children	<a href="#">ZUB LaufendeNummer</a> <a href="#">ZUB ZubehoerArtSchluessel</a> <a href="#">ZUB ArtikelNummer</a> <a href="#">ZUB ArtikelNummerUnbekannt</a> <a href="#">ZUB LotNummer</a> <a href="#">ZUB LotNummerUnbekannt</a> <a href="#">ZUB SerienNummer</a> <a href="#">ZUB SerienNummerUnbekannt</a> <a href="#">ZUB Artikelbezeichnung</a> <a href="#">zubehoerBrustimplantat</a> <a href="#">zubehoerEndoprothese</a>
source	<code>&lt;element name="zubehoer" type="Zubehoer" minOccurs="0" maxOccurs="unbounded"/&gt;</code>

### complexType Entlassung

diagram	
namespace	http://xml.ir-d.de/emg
type	extension of <a href="#">EntlassungBasis</a>
properties	base EntlassungBasis
children	<a href="#">ENT Datum</a> <a href="#">ENT GrundSchluessel</a> <a href="#">diagnoseBrustimplantat</a> <a href="#">diagnoseEndoprothese</a> <a href="#">diagnoseAortenklappe</a>
used by	element <a href="#">Fall/entlassung</a>
source	<pre> &lt;complexType name="Entlassung"&gt;   &lt;complexContent&gt;     &lt;extension base="EntlassungBasis"&gt;       &lt;sequence&gt;         &lt;element name="diagnoseBrustimplantat" type="DiagnoseBrustimplantatBasis" minOccurs="0" maxOccurs="unbounded"/&gt;         &lt;element name="diagnoseEndoprothese" type="DiagnoseEndoprotheseBasis" minOccurs="0" maxOccurs="unbounded"/&gt;         &lt;element name="diagnoseAortenklappe" type="DiagnoseAortenklappeBasis" minOccurs="0" maxOccurs="unbounded"/&gt;       &lt;/sequence&gt;     &lt;/extension&gt;   &lt;/complexContent&gt; &lt;/complexType&gt; </pre>

element **Entlassung/diagnoseBrustimplantat**

diagram	
type	<a href="#">DiagnoseBrustimplantatBasis</a>
properties	minOcc 0 maxOcc unbounded content complex
children	<a href="#">DBI_IcdSchluessel</a>
source	<code>&lt;element name="diagnoseBrustimplantat" type="DiagnoseBrustimplantatBasis" minOccurs="0" maxOccurs="unbounded"/&gt;</code>

element **Entlassung/diagnoseEndoprothese**

diagram	
type	<a href="#">DiagnoseEndoprotheseBasis</a>
properties	minOcc 0 maxOcc unbounded content complex
children	<a href="#">DEP_IcdSchluessel</a>
source	<code>&lt;element name="diagnoseEndoprothese" type="DiagnoseEndoprotheseBasis" minOccurs="0" maxOccurs="unbounded"/&gt;</code>

element **Entlassung/diagnoseAortenklappe**

diagram	
type	<a href="#">DiagnoseAortenklappeBasis</a>
properties	minOcc 0 maxOcc unbounded content complex
children	<a href="#">DAK_IcdSchluessel</a>
source	<code>&lt;element name="diagnoseAortenklappe" type="DiagnoseAortenklappeBasis" minOccurs="0" maxOccurs="unbounded"/&gt;</code>



# complexType PostoperationArtenklappe

diagram

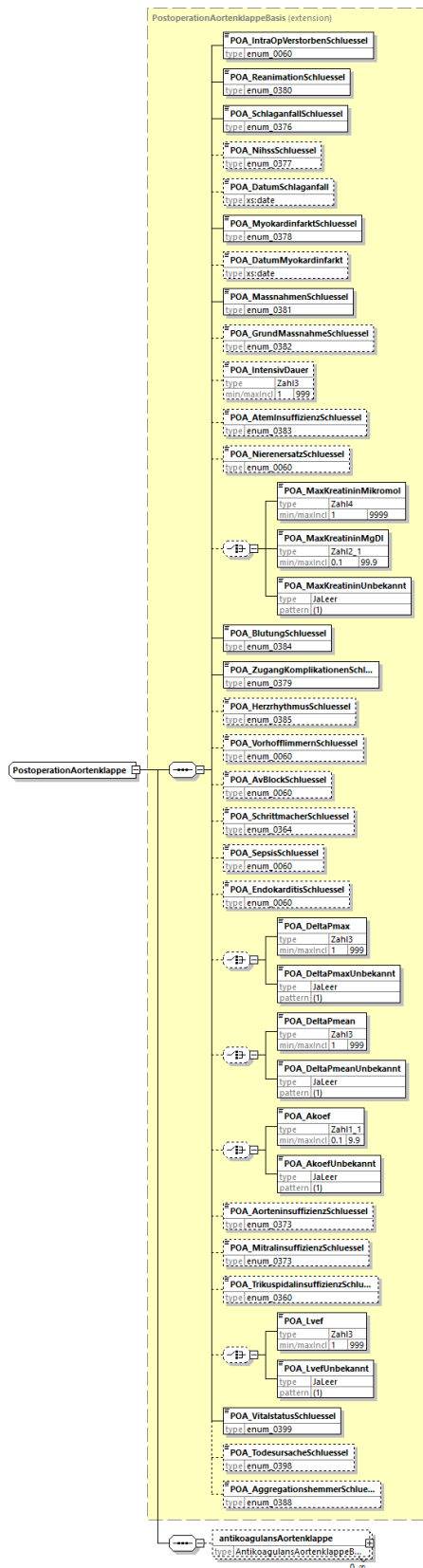

namespace http://xml.ir-d.de/emg

type extension of [PostoperationArtenklappeBasis](#)

properties	base <a href="#">PostoperationAortenklappeBasis</a>
children	<a href="#">POA IntraOpVerstorbenSchluessel</a> <a href="#">POA ReanimationSchluessel</a> <a href="#">POA SchlaganfallSchluessel</a> <a href="#">POA NihssSchluessel</a> <a href="#">POA DatumSchlaganfall</a> <a href="#">POA MyokardinfarktSchluessel</a> <a href="#">POA DatumMyokardinfarkt</a> <a href="#">POA MassnahmenSchluessel</a> <a href="#">POA GrundMassnahmeSchluessel</a> <a href="#">POA IntensivDauer</a> <a href="#">POA AtemInsuffizienzSchluessel</a> <a href="#">POA NierenersatzSchluessel</a> <a href="#">POA MaxKreatininMikromol</a> <a href="#">POA MaxKreatininMgDL</a> <a href="#">POA MaxKreatininUnbekannt</a> <a href="#">POA BlutungSchluessel</a> <a href="#">POA ZugangKomplikationenSchluessel</a> <a href="#">POA HerzrhythmusSchluessel</a> <a href="#">POA VorhofflimmernSchluessel</a> <a href="#">POA AvBlockSchluessel</a> <a href="#">POA SchrittmacherSchluessel</a> <a href="#">POA SepsisSchluessel</a> <a href="#">POA EndokarditisSchluessel</a> <a href="#">POA DeltaPmax</a> <a href="#">POA DeltaPmaxUnbekannt</a> <a href="#">POA DeltaPmean</a> <a href="#">POA DeltaPmeanUnbekannt</a> <a href="#">POA Akoef</a> <a href="#">POA AkoefUnbekannt</a> <a href="#">POA AorteninsuffizienzSchluessel</a> <a href="#">POA MitralinsuffizienzSchluessel</a> <a href="#">POA TrikuspidalinsuffizienzSchluessel</a> <a href="#">POA Lvef</a> <a href="#">POA LvefUnbekannt</a> <a href="#">POA VitalstatusSchluessel</a> <a href="#">POA TodesursacheSchluessel</a> <a href="#">POA AggregationshemmerSchluessel</a> <a href="#">antikoagulansAortenklappe</a>
used by	element <a href="#">Fall/postoperationAortenklappe</a>
source	<pre>&lt;complexType name="PostoperationAortenklappe"&gt;   &lt;complexContent&gt;     &lt;extension base="PostoperationAortenklappeBasis"&gt;       &lt;sequence&gt;         &lt;element name="antikoagulansAortenklappe"           type="AntikoagulansAortenklappeBasis" minOccurs="0" maxOccurs="unbounded"/&gt;       &lt;/sequence&gt;     &lt;/extension&gt;   &lt;/complexContent&gt; &lt;/complexType&gt;</pre>

#### element [PostoperationAortenklappe/antikoagulansAortenklappe](#)

diagram	
type	<a href="#">AntikoagulansAortenklappeBasis</a>
properties	minOcc 0 maxOcc unbounded content complex
children	<a href="#">AKA AntikoagulansSchluessel</a>
source	<pre>&lt;element name="antikoagulansAortenklappe"   type="AntikoagulansAortenklappeBasis" minOccurs="0" maxOccurs="unbounded"/&gt;</pre>

#### simpleType [enum\\_0044](#)

namespace	<a href="http://xml.ir-d.de/stn">http://xml.ir-d.de/stn</a>		
type	restriction of <b>string</b>		
properties	base <a href="#">xs:string</a>		
facets	Kind	Value	Annotation
	enumeration	0044001	documentation 1= normaler, sonst gesunder Patient
	enumeration	0044002	documentation 2= Patient mit leichter Allgemeinerkrankung
	enumeration	0044003	documentation 3= Patient mit schwerer Allgemeinerkrankung
	enumeration	0044004	documentation

	<p>4= Patient mit schwerer Allgemeinerkrankung, die eine ständige Lebensbedrohung darstellt</p> <p>documentation</p> <p>5= moribunder Patient, der ohne die Operation voraussichtlich nicht überleben wird</p>
enumeration 0044005	
annotation	documentation Kat_ASA
source	<pre> &lt;simpleType name="enum_0044"&gt;   &lt;annotation&gt;     &lt;documentation&gt;Kat_ASA&lt;/documentation&gt;   &lt;/annotation&gt;   &lt;restriction base="xs:string"&gt;     &lt;enumeration value="0044001"&gt;       &lt;annotation&gt;         &lt;documentation&gt;1= normaler, sonst gesunder Patient&lt;/documentation&gt;       &lt;/annotation&gt;     &lt;/enumeration&gt;     &lt;enumeration value="0044002"&gt;       &lt;annotation&gt;         &lt;documentation&gt;2= Patient mit leichter Allgemeinerkrankung&lt;/documentation&gt;       &lt;/annotation&gt;     &lt;/enumeration&gt;     &lt;enumeration value="0044003"&gt;       &lt;annotation&gt;         &lt;documentation&gt;3= Patient mit schwerer Allgemeinerkrankung&lt;/documentation&gt;       &lt;/annotation&gt;     &lt;/enumeration&gt;     &lt;enumeration value="0044004"&gt;       &lt;annotation&gt;         &lt;documentation&gt;4= Patient mit schwerer Allgemeinerkrankung, die eine ständige Lebensbedrohung darstellt&lt;/documentation&gt;       &lt;/annotation&gt;     &lt;/enumeration&gt;     &lt;enumeration value="0044005"&gt;       &lt;annotation&gt;         &lt;documentation&gt;5= moribunder Patient, der ohne die Operation voraussichtlich nicht überleben wird&lt;/documentation&gt;       &lt;/annotation&gt;     &lt;/enumeration&gt;   &lt;/restriction&gt; &lt;/simpleType&gt; </pre>

### simpleType enum\_0050

namespace	http://xml.ir-d.de/stn		
type	restriction of <b>string</b>		
properties	base xs:string		
facets	Kind	Value	Annotation
	enumeration	0050001	documentation rechts
	enumeration	0050002	documentation links
annotation	documentation Kat_RechtsLinks		
source	<pre> &lt;simpleType name="enum_0050"&gt;   &lt;annotation&gt; </pre>		

	<pre> &lt;documentation&gt;Kat_RechtsLinks&lt;/documentation&gt; &lt;/annotation&gt; &lt;restriction base="xs:string"&gt;   &lt;enumeration value="0050001"&gt;     &lt;annotation&gt;       &lt;documentation&gt;rechts&lt;/documentation&gt;     &lt;/annotation&gt;   &lt;/enumeration&gt;   &lt;enumeration value="0050002"&gt;     &lt;annotation&gt;       &lt;documentation&gt;links&lt;/documentation&gt;     &lt;/annotation&gt;   &lt;/enumeration&gt; &lt;/restriction&gt; &lt;/simpleType&gt; </pre>
--	--

### simpleType enum\_0060

namespace	http://xml.ir-d.de/stn		
type	restriction of <b>string</b>		
properties	base xs:string		
facets	Kind	Value	Annotation
	enumeration	0060001	documentation ja
	enumeration	0060002	documentation nein
annotation	documentation Kat_JaNein		
source	<pre> &lt;simpleType name="enum_0060"&gt;   &lt;annotation&gt;     &lt;documentation&gt;Kat_JaNein&lt;/documentation&gt;   &lt;/annotation&gt;   &lt;restriction base="xs:string"&gt;     &lt;enumeration value="0060001"&gt;       &lt;annotation&gt;         &lt;documentation&gt;ja&lt;/documentation&gt;       &lt;/annotation&gt;     &lt;/enumeration&gt;     &lt;enumeration value="0060002"&gt;       &lt;annotation&gt;         &lt;documentation&gt;nein&lt;/documentation&gt;       &lt;/annotation&gt;     &lt;/enumeration&gt;   &lt;/restriction&gt; &lt;/simpleType&gt; </pre>		

### simpleType enum\_0061

namespace	http://xml.ir-d.de/stn		
type	restriction of <b>string</b>		
properties	base xs:string		
facets	Kind	Value	Annotation
	enumeration	0061001	documentation ja

	enumeration 0061002 documentation nein enumeration 0061099 documentation unbekannt
annotation	documentation Kat_JaNeinUnbekannt
source	<pre> &lt;simpleType name="enum_0061"&gt;   &lt;annotation&gt;     &lt;documentation&gt;Kat_JaNeinUnbekannt&lt;/documentation&gt;   &lt;/annotation&gt;   &lt;restriction base="xs:string"&gt;     &lt;enumeration value="0061001"&gt;       &lt;annotation&gt;         &lt;documentation&gt;ja&lt;/documentation&gt;       &lt;/annotation&gt;     &lt;/enumeration&gt;     &lt;enumeration value="0061002"&gt;       &lt;annotation&gt;         &lt;documentation&gt;nein&lt;/documentation&gt;       &lt;/annotation&gt;     &lt;/enumeration&gt;     &lt;enumeration value="0061099"&gt;       &lt;annotation&gt;         &lt;documentation&gt;unbekannt&lt;/documentation&gt;       &lt;/annotation&gt;     &lt;/enumeration&gt;   &lt;/restriction&gt; &lt;/simpleType&gt; </pre>

### simpleType enum 0062

namespace	http://xml.ir-d.de/stn		
type	restriction of <b>string</b>		
properties	base xs:string		
facets	Kind	Value	Annotation
	enumeration	0062001	documentation Stück
	enumeration	0062002	documentation g
	enumeration	0062003	documentation mg
	enumeration	0062004	documentation l
	enumeration	0062005	documentation ml
	enumeration	0062006	documentation cm <sup>3</sup>
	enumeration	0062007	documentation mm
	enumeration	0062008	documentation cm
	enumeration	0062009	documentation dm
	enumeration	0062010	documentation m
	enumeration	0062042	documentation andere
annotation	documentation Kat_Einheit		

source

```
<simpleType name="enum_0062">
  <annotation>
    <documentation>Kat_Einheit</documentation>
  </annotation>
  <restriction base="xs:string">
    <enumeration value="0062001">
      <annotation>
        <documentation>Stück</documentation>
      </annotation>
    </enumeration>
    <enumeration value="0062002">
      <annotation>
        <documentation>g</documentation>
      </annotation>
    </enumeration>
    <enumeration value="0062003">
      <annotation>
        <documentation>mg</documentation>
      </annotation>
    </enumeration>
    <enumeration value="0062004">
      <annotation>
        <documentation>l</documentation>
      </annotation>
    </enumeration>
    <enumeration value="0062005">
      <annotation>
        <documentation>ml</documentation>
      </annotation>
    </enumeration>
    <enumeration value="0062006">
      <annotation>
        <documentation>cm3</documentation>
      </annotation>
    </enumeration>
    <enumeration value="0062007">
      <annotation>
        <documentation>mm</documentation>
      </annotation>
    </enumeration>
    <enumeration value="0062008">
      <annotation>
        <documentation>cm</documentation>
      </annotation>
    </enumeration>
    <enumeration value="0062009">
      <annotation>
        <documentation>dm</documentation>
      </annotation>
    </enumeration>
    <enumeration value="0062010">
      <annotation>
        <documentation>m</documentation>
      </annotation>
    </enumeration>
    <enumeration value="0062042">
      <annotation>
        <documentation>andere</documentation>
      </annotation>
    </enumeration>
  </restriction>
</simpleType>
```

	<pre> &lt;/enumeration&gt; &lt;/restriction&gt; &lt;/simpleType&gt; </pre>
--	--

### simpleType enum\_0065

namespace	http://xml.ir-d.de/stn		
type	restriction of <b>string</b>		
properties	base xs:string		
facets	Kind	Value	Annotation
	enumeration	0065001	documentation stationär
	enumeration	0065002	documentation teilstationär
	enumeration	0065003	documentation ambulant
annotation	documentation Kat_ArtAufenthalt		
source	<pre> &lt;simpleType name="enum_0065"&gt;   &lt;annotation&gt;     &lt;documentation&gt;Kat_ArtAufenthalt&lt;/documentation&gt;   &lt;/annotation&gt;   &lt;restriction base="xs:string"&gt;     &lt;enumeration value="0065001"&gt;       &lt;annotation&gt;         &lt;documentation&gt;stationär&lt;/documentation&gt;       &lt;/annotation&gt;     &lt;/enumeration&gt;     &lt;enumeration value="0065002"&gt;       &lt;annotation&gt;         &lt;documentation&gt;teilstationär&lt;/documentation&gt;       &lt;/annotation&gt;     &lt;/enumeration&gt;     &lt;enumeration value="0065003"&gt;       &lt;annotation&gt;         &lt;documentation&gt;ambulant&lt;/documentation&gt;       &lt;/annotation&gt;     &lt;/enumeration&gt;   &lt;/restriction&gt; &lt;/simpleType&gt; </pre>		

### simpleType enum\_0067

namespace	http://xml.ir-d.de/stn		
type	restriction of <b>string</b>		
properties	base xs:string		
facets	Kind	Value	Annotation
	enumeration	0067001	documentation Implantat
	enumeration	0067002	documentation Explantat
annotation	documentation Kat_ArtArtikel		
source	<pre> &lt;simpleType name="enum_0067"&gt; </pre>		

	<pre> &lt;annotation&gt;   &lt;documentation&gt;Kat_ArtArtikel&lt;/documentation&gt; &lt;/annotation&gt; &lt;restriction base="xs:string"&gt;   &lt;enumeration value="0067001"&gt;     &lt;annotation&gt;       &lt;documentation&gt;Implantat&lt;/documentation&gt;     &lt;/annotation&gt;   &lt;/enumeration&gt;   &lt;enumeration value="0067002"&gt;     &lt;annotation&gt;       &lt;documentation&gt;Explantat&lt;/documentation&gt;     &lt;/annotation&gt;   &lt;/enumeration&gt; &lt;/restriction&gt; &lt;/simpleType&gt; </pre>
--	---

### simpleType enum 0068

namespace	http://xml.ir-d.de/stn		
type	restriction of <b>string</b>		
properties	base xs:string		
facets	Kind	Value	Annotation
	enumeration	0068001	documentation UDI
	enumeration	0068002	documentation Referenz (REF)
	enumeration	0068003	documentation Katalognummer
	enumeration	0068042	documentation sonstiger
annotation	documentation Kat_KennzeichenTyp		
source	<pre> &lt;simpleType name="enum_0068"&gt;   &lt;annotation&gt;     &lt;documentation&gt;Kat_KennzeichenTyp&lt;/documentation&gt;   &lt;/annotation&gt;   &lt;restriction base="xs:string"&gt;     &lt;enumeration value="0068001"&gt;       &lt;annotation&gt;         &lt;documentation&gt;UDI&lt;/documentation&gt;       &lt;/annotation&gt;     &lt;/enumeration&gt;     &lt;enumeration value="0068002"&gt;       &lt;annotation&gt;         &lt;documentation&gt;Referenz (REF)&lt;/documentation&gt;       &lt;/annotation&gt;     &lt;/enumeration&gt;     &lt;enumeration value="0068003"&gt;       &lt;annotation&gt;         &lt;documentation&gt;Katalognummer&lt;/documentation&gt;       &lt;/annotation&gt;     &lt;/enumeration&gt;     &lt;enumeration value="0068042"&gt;       &lt;annotation&gt;         &lt;documentation&gt;sonstiger&lt;/documentation&gt;       &lt;/annotation&gt;     &lt;/enumeration&gt;   &lt;/restriction&gt; &lt;/simpleType&gt; </pre>		



	<pre> &lt;/enumeration&gt; &lt;/restriction&gt; &lt;/simpleType&gt; </pre>
--	--

### simpleType enum\_0069

namespace	http://xml.ir-d.de/stn		
type	restriction of <b>string</b>		
properties	base xs:string		
facets	Kind	Value	Annotation
	enumeration	0069001	documentation Implantat
	enumeration	0069002	documentation Explantat
annotation	documentation Kat_ArtZubehoer		
source	<pre> &lt;simpleType name="enum_0069"&gt;   &lt;annotation&gt;     &lt;documentation&gt;Kat_ArtZubehoer&lt;/documentation&gt;   &lt;/annotation&gt;   &lt;restriction base="xs:string"&gt;     &lt;enumeration value="0069001"&gt;       &lt;annotation&gt;         &lt;documentation&gt;Implantat&lt;/documentation&gt;       &lt;/annotation&gt;     &lt;/enumeration&gt;     &lt;enumeration value="0069002"&gt;       &lt;annotation&gt;         &lt;documentation&gt;Explantat&lt;/documentation&gt;       &lt;/annotation&gt;     &lt;/enumeration&gt;   &lt;/restriction&gt; &lt;/simpleType&gt; </pre>		

### simpleType enum\_0070

namespace	http://xml.ir-d.de/stn		
type	restriction of <b>string</b>		
properties	base xs:string		
facets	Kind	Value	Annotation
	enumeration	0070001	documentation weiblich
	enumeration	0070002	documentation männlich
	enumeration	0070003	documentation divers
	enumeration	0070042	documentation unbestimmt
annotation	documentation Kat_Geschlecht		
source	<pre> &lt;simpleType name="enum_0070"&gt;   &lt;annotation&gt;     &lt;documentation&gt;Kat_Geschlecht&lt;/documentation&gt;   &lt;/annotation&gt; </pre>		

	<pre> &lt;restriction base="xs:string"&gt;   &lt;enumeration value="0070001"&gt;     &lt;annotation&gt;       &lt;documentation&gt;weiblich&lt;/documentation&gt;     &lt;/annotation&gt;   &lt;/enumeration&gt;   &lt;enumeration value="0070002"&gt;     &lt;annotation&gt;       &lt;documentation&gt;männlich&lt;/documentation&gt;     &lt;/annotation&gt;   &lt;/enumeration&gt;   &lt;enumeration value="0070003"&gt;     &lt;annotation&gt;       &lt;documentation&gt;divers&lt;/documentation&gt;     &lt;/annotation&gt;   &lt;/enumeration&gt;   &lt;enumeration value="0070042"&gt;     &lt;annotation&gt;       &lt;documentation&gt;unbestimmt&lt;/documentation&gt;     &lt;/annotation&gt;   &lt;/enumeration&gt; &lt;/restriction&gt; &lt;/simpleType&gt; </pre>
--	--

### simpleType enum\_0071

namespace	http://xml.ir-d.de/stn		
type	restriction of <b>string</b>		
properties	base xs:string		
facets	Kind	Value	Annotation
	enumeration	0071001	documentation Implantat
	enumeration	0071002	documentation Explantat
	enumeration	0071003	documentation Degeneriertes/defektes Produkt, das funktionslos im Körper verbleibt
annotation	documentation Kat ArtikelArtFunktion		
source	<pre> &lt;simpleType name="enum_0071"&gt;   &lt;annotation&gt;     &lt;documentation&gt;Kat_ArtikelArtFunktion&lt;/documentation&gt;   &lt;/annotation&gt;   &lt;restriction base="xs:string"&gt;     &lt;enumeration value="0071001"&gt;       &lt;annotation&gt;         &lt;documentation&gt;Implantat&lt;/documentation&gt;       &lt;/annotation&gt;     &lt;/enumeration&gt;     &lt;enumeration value="0071002"&gt;       &lt;annotation&gt;         &lt;documentation&gt;Explantat&lt;/documentation&gt;       &lt;/annotation&gt;     &lt;/enumeration&gt;     &lt;enumeration value="0071003"&gt;       &lt;annotation&gt;         &lt;documentation&gt;Degeneriertes/defektes Produkt, das funktionslos im Körper verbleibt&lt;/documentation&gt;       &lt;/annotation&gt;     &lt;/enumeration&gt;   &lt;/restriction&gt; &lt;/simpleType&gt; </pre>		

```

</annotation>
</enumeration>
</restriction>
</simpleType>

```

### simpleType enum\_0075

namespace	http://xml.ir-d.de/stn		
type	restriction of <b>string</b>		
properties	base xs:string		
facets	Kind	Value	Annotation
	enumeration	0075001	documentation elektiv
	enumeration	0075002	documentation dringlich
	enumeration	0075003	documentation Notfall
annotation	documentation Kat_Dringlichkeit		
source	<pre> &lt;simpleType name="enum_0075"&gt;   &lt;annotation&gt;     &lt;documentation&gt;Kat_Dringlichkeit&lt;/documentation&gt;   &lt;/annotation&gt;   &lt;restriction base="xs:string"&gt;     &lt;enumeration value="0075001"&gt;       &lt;annotation&gt;         &lt;documentation&gt;elektiv&lt;/documentation&gt;       &lt;/annotation&gt;     &lt;/enumeration&gt;     &lt;enumeration value="0075002"&gt;       &lt;annotation&gt;         &lt;documentation&gt;dringlich&lt;/documentation&gt;       &lt;/annotation&gt;     &lt;/enumeration&gt;     &lt;enumeration value="0075003"&gt;       &lt;annotation&gt;         &lt;documentation&gt;Notfall&lt;/documentation&gt;       &lt;/annotation&gt;     &lt;/enumeration&gt;   &lt;/restriction&gt; &lt;/simpleType&gt; </pre>		

### simpleType enum\_0076

namespace	http://xml.ir-d.de/stn		
type	restriction of <b>string</b>		
properties	base xs:string		
facets	Kind	Value	Annotation
	enumeration	0076001	documentation elektiv
	enumeration	0076002	documentation dringlich
	enumeration	0076003	documentation Notfall
	enumeration	0076004	documentation

	Notfall (Reanimation / ultima ratio)
annotation	documentation Kat Dringlichkeit Reanimation
source	<pre> &lt;simpleType name="enum_0076"&gt;   &lt;annotation&gt;     &lt;documentation&gt;Kat_Dringlichkeit_Reanimation&lt;/documentation&gt;   &lt;/annotation&gt;   &lt;restriction base="xs:string"&gt;     &lt;enumeration value="0076001"&gt;       &lt;annotation&gt;         &lt;documentation&gt;elektiv&lt;/documentation&gt;       &lt;/annotation&gt;     &lt;/enumeration&gt;     &lt;enumeration value="0076002"&gt;       &lt;annotation&gt;         &lt;documentation&gt;dringlich&lt;/documentation&gt;       &lt;/annotation&gt;     &lt;/enumeration&gt;     &lt;enumeration value="0076003"&gt;       &lt;annotation&gt;         &lt;documentation&gt;Notfall&lt;/documentation&gt;       &lt;/annotation&gt;     &lt;/enumeration&gt;     &lt;enumeration value="0076004"&gt;       &lt;annotation&gt;         &lt;documentation&gt;Notfall (Reanimation / ultima ratio)&lt;/documentation&gt;       &lt;/annotation&gt;     &lt;/enumeration&gt;   &lt;/restriction&gt; &lt;/simpleType&gt; </pre>

### simpleType enum\_0080

namespace	http://xml.ir-d.de/stn		
type	restriction of <b>string</b>		
properties	base xs:string		
facets	Kind	Value	Annotation
	enumeration	0080001	documentation Endoprothese Hüfte/Knie
	enumeration	0080002	documentation Brustimplantat
	enumeration	0080003	documentation Aortenklappenprothese
annotation	documentation Kat_Implantattyp		
source	<pre> &lt;simpleType name="enum_0080"&gt;   &lt;annotation&gt;     &lt;documentation&gt;Kat_Implantattyp&lt;/documentation&gt;   &lt;/annotation&gt;   &lt;restriction base="xs:string"&gt;     &lt;enumeration value="0080001"&gt;       &lt;annotation&gt;         &lt;documentation&gt;Endoprothese Hüfte/Knie&lt;/documentation&gt;       &lt;/annotation&gt;     &lt;/enumeration&gt;     &lt;enumeration value="0080002"&gt;       &lt;annotation&gt; </pre>		

	<pre> &lt;documentation&gt;Brustimplantat&lt;/documentation&gt; &lt;/annotation&gt; &lt;/enumeration&gt; &lt;enumeration value="0080003"&gt;   &lt;annotation&gt;     &lt;documentation&gt;Aortenklappenprothese&lt;/documentation&gt;   &lt;/annotation&gt; &lt;/enumeration&gt; &lt;/restriction&gt; &lt;/simpleType&gt; </pre>
--	---

### simpleType enum\_0100

namespace	http://xml.ir-d.de/stn		
type	restriction of <b>string</b>		
properties	base xs:string		
facets	Kind	Value	Annotation
	enumeration	0100001	documentation Primäreingriff
	enumeration	0100002	documentation Austausch Expander gegen dauerhaftes Brustimplantat
	enumeration	0100003	documentation Revision
	enumeration	0100004	documentation Nur Explantation
annotation	documentation Kat_BI_ArtEingriff		
source	<pre> &lt;simpleType name="enum_0100"&gt;   &lt;annotation&gt;     &lt;documentation&gt;Kat_BI_ArtEingriff&lt;/documentation&gt;   &lt;/annotation&gt;   &lt;restriction base="xs:string"&gt;     &lt;enumeration value="0100001"&gt;       &lt;annotation&gt;         &lt;documentation&gt;Primäreingriff&lt;/documentation&gt;       &lt;/annotation&gt;     &lt;/enumeration&gt;     &lt;enumeration value="0100002"&gt;       &lt;annotation&gt;         &lt;documentation&gt;Austausch Expander gegen dauerhaftes Brustimplantat&lt;/documentation&gt;       &lt;/annotation&gt;     &lt;/enumeration&gt;     &lt;enumeration value="0100003"&gt;       &lt;annotation&gt;         &lt;documentation&gt;Revision&lt;/documentation&gt;       &lt;/annotation&gt;     &lt;/enumeration&gt;     &lt;enumeration value="0100004"&gt;       &lt;annotation&gt;         &lt;documentation&gt;Nur Explantation&lt;/documentation&gt;       &lt;/annotation&gt;     &lt;/enumeration&gt;   &lt;/restriction&gt; &lt;/simpleType&gt; </pre>		

### simpleType enum\_0102

namespace	http://xml.ir-d.de/stn		
type	restriction of <b>string</b>		
properties	base xs:string		
facets	Kind	Value	Annotation
	enumeration	0102001	documentation kosmetische Augmentation
	enumeration	0102002	documentation Rekonstruktion, benigne
	enumeration	0102003	documentation Rekonstruktion nach Mastektomie aufgrund eines Karzinoms
	enumeration	0102004	documentation Rekonstruktion nach risikoreduzierender Mastektomie
annotation	documentation Kat_BI_GrundPrimaereingriff		
source	<pre> &lt;simpleType name="enum_0102"&gt;   &lt;annotation&gt;     &lt;documentation&gt;Kat_BI_GrundPrimaereingriff&lt;/documentation&gt;   &lt;/annotation&gt;   &lt;restriction base="xs:string"&gt;     &lt;enumeration value="0102001"&gt;       &lt;annotation&gt;         &lt;documentation&gt;kosmetische Augmentation&lt;/documentation&gt;       &lt;/annotation&gt;     &lt;/enumeration&gt;     &lt;enumeration value="0102002"&gt;       &lt;annotation&gt;         &lt;documentation&gt;Rekonstruktion, benigne&lt;/documentation&gt;       &lt;/annotation&gt;     &lt;/enumeration&gt;     &lt;enumeration value="0102003"&gt;       &lt;annotation&gt;         &lt;documentation&gt;Rekonstruktion nach Mastektomie aufgrund eines Karzinoms&lt;/documentation&gt;       &lt;/annotation&gt;     &lt;/enumeration&gt;     &lt;enumeration value="0102004"&gt;       &lt;annotation&gt;         &lt;documentation&gt;Rekonstruktion nach risikoreduzierender Mastektomie&lt;/documentation&gt;       &lt;/annotation&gt;     &lt;/enumeration&gt;   &lt;/restriction&gt; &lt;/simpleType&gt; </pre>		

### simpleType enum\_0103

namespace	http://xml.ir-d.de/stn		
type	restriction of <b>string</b>		
properties	base xs:string		
facets	Kind	Value	Annotation
	enumeration	0103001	documentation simultane Lappendeckung
	enumeration	0103002	documentation

	<p>enumeration 0103003 simultane Eigenfetttransplantation documentation</p> <p>enumeration 0103005 simultane Mastopexie documentation</p> <p>enumeration 0103006 simultane Mastektomie, Ablatio / hautsparend documentation</p> <p>enumeration 0103007 simultane Mastektomie, nippelerhaltend documentation</p> <p>enumeration 0103008 Axilla-Dissektion documentation</p> <p>Drainage</p>
annotation	<p>documentation Kat_BI_OperationsdetailPrimaereingriff</p>
source	<pre> &lt;simpleType name="enum_0103"&gt;   &lt;annotation&gt;     &lt;documentation&gt;Kat_BI_OperationsdetailPrimaereingriff&lt;/documentation&gt;   &lt;/annotation&gt;   &lt;restriction base="xs:string"&gt;     &lt;enumeration value="0103001"&gt;       &lt;annotation&gt;         &lt;documentation&gt;simultane Lappendeckung&lt;/documentation&gt;       &lt;/annotation&gt;     &lt;/enumeration&gt;     &lt;enumeration value="0103002"&gt;       &lt;annotation&gt;         &lt;documentation&gt;simultane Eigenfetttransplantation&lt;/documentation&gt;       &lt;/annotation&gt;     &lt;/enumeration&gt;     &lt;enumeration value="0103003"&gt;       &lt;annotation&gt;         &lt;documentation&gt;simultane Mastopexie&lt;/documentation&gt;       &lt;/annotation&gt;     &lt;/enumeration&gt;     &lt;enumeration value="0103005"&gt;       &lt;annotation&gt;         &lt;documentation&gt;simultane Mastektomie, Ablatio / hautsparend&lt;/documentation&gt;       &lt;/annotation&gt;     &lt;/enumeration&gt;     &lt;enumeration value="0103006"&gt;       &lt;annotation&gt;         &lt;documentation&gt;simultane Mastektomie, nippelerhaltend&lt;/documentation&gt;       &lt;/annotation&gt;     &lt;/enumeration&gt;     &lt;enumeration value="0103007"&gt;       &lt;annotation&gt;         &lt;documentation&gt;Axilla-Dissektion&lt;/documentation&gt;       &lt;/annotation&gt;     &lt;/enumeration&gt;     &lt;enumeration value="0103008"&gt;       &lt;annotation&gt;         &lt;documentation&gt;Drainage&lt;/documentation&gt;       &lt;/annotation&gt;     &lt;/enumeration&gt;   &lt;/restriction&gt; &lt;/simpleType&gt; </pre>

### simpleType enum\_0104

namespace	http://xml.ir-d.de/stn		
type	restriction of <b>string</b>		
properties	base xs:string		
facets	Kind	Value	Annotation
	enumeration	0104001	documentation Austausch Expander gegen dauerhaftes Brustimplantat
annotation	documentation Kat_BI_GrundAustausch		
source	<pre> &lt;simpleType name="enum_0104"&gt;   &lt;annotation&gt;     &lt;documentation&gt;Kat_BI_GrundAustausch&lt;/documentation&gt;   &lt;/annotation&gt;   &lt;restriction base="xs:string"&gt;     &lt;enumeration value="0104001"&gt;       &lt;annotation&gt;         &lt;documentation&gt;Austausch Expander gegen dauerhaftes Brustimplantat&lt;/documentation&gt;       &lt;/annotation&gt;     &lt;/enumeration&gt;   &lt;/restriction&gt; &lt;/simpleType&gt; </pre>		

### simpleType enum\_0105

namespace	http://xml.ir-d.de/stn		
type	restriction of <b>string</b>		
properties	base xs:string		
facets	Kind	Value	Annotation
	enumeration	0105001	documentation simultane Lappendeckung
	enumeration	0105002	documentation simultane Eigenfetttransplantation
	enumeration	0105003	documentation simultane Mastopexie
	enumeration	0105008	documentation Drainage
	enumeration	0105009	documentation Kapsulektomie, komplett
	enumeration	0105010	documentation Kapsulektomie, partiell
	enumeration	0105011	documentation Neopocket
annotation	documentation Kat_BI_OperationsdetailAustausch		
source	<pre> &lt;simpleType name="enum_0105"&gt;   &lt;annotation&gt;     &lt;documentation&gt;Kat_BI_OperationsdetailAustausch&lt;/documentation&gt;   &lt;/annotation&gt;   &lt;restriction base="xs:string"&gt;     &lt;enumeration value="0105001"&gt;       &lt;annotation&gt;         &lt;documentation&gt;simultane Lappendeckung&lt;/documentation&gt;       &lt;/annotation&gt;     &lt;/enumeration&gt;     &lt;enumeration value="0105002"&gt; </pre>		



	<pre> &lt;annotation&gt;   &lt;documentation&gt;simultane Eigenfetttransplantation&lt;/documentation&gt; &lt;/annotation&gt; &lt;/enumeration&gt; &lt;enumeration value="0105003"&gt;   &lt;annotation&gt;     &lt;documentation&gt;simultane Mastopexie&lt;/documentation&gt;   &lt;/annotation&gt; &lt;/enumeration&gt; &lt;enumeration value="0105008"&gt;   &lt;annotation&gt;     &lt;documentation&gt;Drainage&lt;/documentation&gt;   &lt;/annotation&gt; &lt;/enumeration&gt; &lt;enumeration value="0105009"&gt;   &lt;annotation&gt;     &lt;documentation&gt;Kapsulektomie, komplett&lt;/documentation&gt;   &lt;/annotation&gt; &lt;/enumeration&gt; &lt;enumeration value="0105010"&gt;   &lt;annotation&gt;     &lt;documentation&gt;Kapsulektomie, partiell&lt;/documentation&gt;   &lt;/annotation&gt; &lt;/enumeration&gt; &lt;enumeration value="0105011"&gt;   &lt;annotation&gt;     &lt;documentation&gt;Neopocket&lt;/documentation&gt;   &lt;/annotation&gt; &lt;/enumeration&gt; &lt;/restriction&gt; &lt;/simpleType&gt; </pre>
--	--

### simpleType enum\_0106

namespace	http://xml.ir-d.de/stn		
type	restriction of <b>string</b>		
properties	base xs:string		
facets	Kind	Value	Annotation
	enumeration	0106001	documentation Patientenwunsch
	enumeration	0106002	documentation asymptomatisch
	enumeration	0106003	documentation Komplikation
annotation	documentation Kat_BI_GrundRevisionExplantation		
source	<pre> &lt;simpleType name="enum_0106"&gt;   &lt;annotation&gt;     &lt;documentation&gt;Kat_BI_GrundRevisionExplantation&lt;/documentation&gt;   &lt;/annotation&gt;   &lt;restriction base="xs:string"&gt;     &lt;enumeration value="0106001"&gt;       &lt;annotation&gt;         &lt;documentation&gt;Patientenwunsch&lt;/documentation&gt;       &lt;/annotation&gt;     &lt;/enumeration&gt;     &lt;enumeration value="0106002"&gt; </pre>		

	<pre> &lt;annotation&gt;   &lt;documentation&gt;asymptomatisch&lt;/documentation&gt; &lt;/annotation&gt; &lt;/enumeration&gt; &lt;enumeration value="0106003"&gt;   &lt;annotation&gt;     &lt;documentation&gt;Komplikation&lt;/documentation&gt;   &lt;/annotation&gt; &lt;/enumeration&gt; &lt;/restriction&gt; &lt;/simpleType&gt; </pre>
--	---

### simpleType enum\_0107

namespace	http://xml.ir-d.de/stn		
type	restriction of <b>string</b>		
properties	base xs:string		
facets	Kind	Value	Annotation
	enumeration	0107001	documentation simultane Lappendeckung
	enumeration	0107002	documentation simultane Eigenfetttransplantation
	enumeration	0107003	documentation simultane Mastopexie
	enumeration	0107005	documentation simultane Mastektomie, Ablatio / hautsparend
	enumeration	0107006	documentation simultane Mastektomie, nippelerhaltend
	enumeration	0107007	documentation Axilla-Dissektion
	enumeration	0107008	documentation Drainage
	enumeration	0107009	documentation Kapsulektomie, komplett
	enumeration	0107010	documentation Kapsulektomie, partiell
	enumeration	0107011	documentation Neopocket
annotation	documentation Kat_BI_OperationsdetailRevision		
source	<pre> &lt;simpleType name="enum_0107"&gt;   &lt;annotation&gt;     &lt;documentation&gt;Kat_BI_OperationsdetailRevision&lt;/documentation&gt;   &lt;/annotation&gt;   &lt;restriction base="xs:string"&gt;     &lt;enumeration value="0107001"&gt;       &lt;annotation&gt;         &lt;documentation&gt;simultane Lappendeckung&lt;/documentation&gt;       &lt;/annotation&gt;     &lt;/enumeration&gt;     &lt;enumeration value="0107002"&gt;       &lt;annotation&gt;         &lt;documentation&gt;simultane Eigenfetttransplantation&lt;/documentation&gt;       &lt;/annotation&gt;     &lt;/enumeration&gt;     &lt;enumeration value="0107003"&gt;       &lt;annotation&gt;         &lt;documentation&gt;simultane Mastopexie&lt;/documentation&gt; </pre>		

```

</annotation>
</enumeration>
<enumeration value="0107005">
  <annotation>
    <documentation>simultane Mastektomie, Ablatio /
hautsparend</documentation>
  </annotation>
</enumeration>
<enumeration value="0107006">
  <annotation>
    <documentation>simultane Mastektomie, nippelerhaltend</documentation>
  </annotation>
</enumeration>
<enumeration value="0107007">
  <annotation>
    <documentation>Axilla-Dissektion</documentation>
  </annotation>
</enumeration>
<enumeration value="0107008">
  <annotation>
    <documentation>Drainage</documentation>
  </annotation>
</enumeration>
<enumeration value="0107009">
  <annotation>
    <documentation>Kapsulektomie, komplett</documentation>
  </annotation>
</enumeration>
<enumeration value="0107010">
  <annotation>
    <documentation>Kapsulektomie, partiell</documentation>
  </annotation>
</enumeration>
<enumeration value="0107011">
  <annotation>
    <documentation>Neopocket</documentation>
  </annotation>
</enumeration>
</restriction>
</simpleType>

```

simpleType **enum\_0110**

namespace	http://xml.ir-d.de/stn		
type	restriction of <b>string</b>		
properties	base xs:string		
facets	Kind	Value	Annotation
	enumeration	0110001	documentation Bestrahlung
annotation	documentation Kat_BI_VorbehandlungLokal		
source	<simpleType name="enum_0110">   <annotation>     <documentation>Kat_BI_VorbehandlungLokal</documentation>   </annotation>   <restriction base="xs:string">		

	<pre> &lt;enumeration value="0110001"&gt;   &lt;annotation&gt;     &lt;documentation&gt;Bestrahlung&lt;/documentation&gt;   &lt;/annotation&gt; &lt;/enumeration&gt; &lt;/restriction&gt; &lt;/simpleType&gt; </pre>
--	--

### simpleType enum\_0111

namespace	http://xml.ir-d.de/stn		
type	restriction of <b>string</b>		
properties	base xs:string		
facets	Kind	Value	Annotation
	enumeration	0111001	documentation nein
	enumeration	0111002	documentation Lipofilling
	enumeration	0111003	documentation Eigengewebsrekonstruktion
annotation	documentation Kat_BI_Verfahrenswechsel		
source	<pre> &lt;simpleType name="enum_0111"&gt;   &lt;annotation&gt;     &lt;documentation&gt;Kat_BI_Verfahrenswechsel&lt;/documentation&gt;   &lt;/annotation&gt;   &lt;restriction base="xs:string"&gt;     &lt;enumeration value="0111001"&gt;       &lt;annotation&gt;         &lt;documentation&gt;nein&lt;/documentation&gt;       &lt;/annotation&gt;     &lt;/enumeration&gt;     &lt;enumeration value="0111002"&gt;       &lt;annotation&gt;         &lt;documentation&gt;Lipofilling&lt;/documentation&gt;       &lt;/annotation&gt;     &lt;/enumeration&gt;     &lt;enumeration value="0111003"&gt;       &lt;annotation&gt;         &lt;documentation&gt;Eigengewebsrekonstruktion&lt;/documentation&gt;       &lt;/annotation&gt;     &lt;/enumeration&gt;   &lt;/restriction&gt; &lt;/simpleType&gt; </pre>		

### simpleType enum\_0112

namespace	http://xml.ir-d.de/stn		
type	restriction of <b>string</b>		
properties	base xs:string		
facets	Kind	Value	Annotation
	enumeration	0112001	documentation subglandulär / epipektoral
	enumeration	0112002	documentation

	<p>enumeration 0112003 subpektoral documentation subfaszial</p> <p>enumeration 0112004 documentation sub-flap</p> <p>enumeration 0112005 documentation subkutan</p> <p>enumeration 0112006 documentation dual plane</p> <p>enumeration 0112042 documentation andere</p>
annotation	documentation Kat BI_LageImplantat
source	<pre> &lt;simpleType name="enum_0112"&gt;   &lt;annotation&gt;     &lt;documentation&gt;Kat_BI_LageImplantat&lt;/documentation&gt;   &lt;/annotation&gt;   &lt;restriction base="xs:string"&gt;     &lt;enumeration value="0112001"&gt;       &lt;annotation&gt;         &lt;documentation&gt;subglandulär / epipektoral&lt;/documentation&gt;       &lt;/annotation&gt;     &lt;/enumeration&gt;     &lt;enumeration value="0112002"&gt;       &lt;annotation&gt;         &lt;documentation&gt;subpektoral&lt;/documentation&gt;       &lt;/annotation&gt;     &lt;/enumeration&gt;     &lt;enumeration value="0112003"&gt;       &lt;annotation&gt;         &lt;documentation&gt;subfaszial&lt;/documentation&gt;       &lt;/annotation&gt;     &lt;/enumeration&gt;     &lt;enumeration value="0112004"&gt;       &lt;annotation&gt;         &lt;documentation&gt;sub-flap&lt;/documentation&gt;       &lt;/annotation&gt;     &lt;/enumeration&gt;     &lt;enumeration value="0112005"&gt;       &lt;annotation&gt;         &lt;documentation&gt;subkutan&lt;/documentation&gt;       &lt;/annotation&gt;     &lt;/enumeration&gt;     &lt;enumeration value="0112006"&gt;       &lt;annotation&gt;         &lt;documentation&gt;dual plane&lt;/documentation&gt;       &lt;/annotation&gt;     &lt;/enumeration&gt;     &lt;enumeration value="0112042"&gt;       &lt;annotation&gt;         &lt;documentation&gt;andere&lt;/documentation&gt;       &lt;/annotation&gt;     &lt;/enumeration&gt;   &lt;/restriction&gt; &lt;/simpleType&gt; </pre>

### simpleType enum\_0113

namespace	http://xml.ir-d.de/stn		
type	restriction of <b>string</b>		
properties	base xs:string		
facets	Kind	Value	Annotation
	enumeration	0113001	documentation Chemotherapie innerhalb der letzten drei Monate
annotation	documentation Kat_BI_VorbehandlungSystemisch		
source	<pre>&lt;simpleType name="enum_0113"&gt;   &lt;annotation&gt;     &lt;documentation&gt;Kat_BI_VorbehandlungSystemisch&lt;/documentation&gt;   &lt;/annotation&gt;   &lt;restriction base="xs:string"&gt;     &lt;enumeration value="0113001"&gt;       &lt;annotation&gt;         &lt;documentation&gt;Chemotherapie innerhalb der letzten drei Monate&lt;/documentation&gt;       &lt;/annotation&gt;     &lt;/enumeration&gt;   &lt;/restriction&gt; &lt;/simpleType&gt;</pre>		

### simpleType enum\_0114

namespace	http://xml.ir-d.de/stn		
type	restriction of <b>string</b>		
properties	base xs:string		
facets	Kind	Value	Annotation
	enumeration	0114001	documentation vollständig
	enumeration	0114002	documentation nein
	enumeration	0114003	documentation teilweise
	enumeration	0114004	documentation nicht vorhanden
annotation	documentation Kat_BI_EntfernungADMNetz		
source	<pre>&lt;simpleType name="enum_0114"&gt;   &lt;annotation&gt;     &lt;documentation&gt;Kat_BI_EntfernungADMNetz&lt;/documentation&gt;   &lt;/annotation&gt;   &lt;restriction base="xs:string"&gt;     &lt;enumeration value="0114001"&gt;       &lt;annotation&gt;         &lt;documentation&gt;vollständig&lt;/documentation&gt;       &lt;/annotation&gt;     &lt;/enumeration&gt;     &lt;enumeration value="0114002"&gt;       &lt;annotation&gt;         &lt;documentation&gt;nein&lt;/documentation&gt;       &lt;/annotation&gt;     &lt;/enumeration&gt;     &lt;enumeration value="0114003"&gt;</pre>		

	<pre> &lt;annotation&gt;   &lt;documentation&gt;teilweise&lt;/documentation&gt; &lt;/annotation&gt; &lt;/enumeration&gt; &lt;enumeration value="0114004"&gt;   &lt;annotation&gt;     &lt;documentation&gt;nicht vorhanden&lt;/documentation&gt;   &lt;/annotation&gt; &lt;/enumeration&gt; &lt;/restriction&gt; &lt;/simpleType&gt; </pre>
--	---

### simpleType enum\_0116

namespace	http://xml.ir-d.de/stn		
type	restriction of <b>string</b>		
properties	base xs:string		
facets	Kind	Value	Annotation
	enumeration	0116001	documentation Spülung, antibiotisch
	enumeration	0116002	documentation Spülung, antiseptisch
	enumeration	0116003	documentation Spülung, wirkstofffrei
	enumeration	0116004	documentation Spülung, andere
	enumeration	0116005	documentation prä-/perioperative Antibiotika
	enumeration	0116006	documentation postoperative Antibiotika
	enumeration	0116007	documentation Handschuhwechsel vor Implantation
	enumeration	0116008	documentation Implantationshilfe
annotation	documentation Kat_BI_Operationsmassnahme		
source	<pre> &lt;simpleType name="enum_0116"&gt;   &lt;annotation&gt;     &lt;documentation&gt;Kat_BI_Operationsmassnahme&lt;/documentation&gt;   &lt;/annotation&gt;   &lt;restriction base="xs:string"&gt;     &lt;enumeration value="0116001"&gt;       &lt;annotation&gt;         &lt;documentation&gt;Spülung, antibiotisch&lt;/documentation&gt;       &lt;/annotation&gt;     &lt;/enumeration&gt;     &lt;enumeration value="0116002"&gt;       &lt;annotation&gt;         &lt;documentation&gt;Spülung, antiseptisch&lt;/documentation&gt;       &lt;/annotation&gt;     &lt;/enumeration&gt;     &lt;enumeration value="0116003"&gt;       &lt;annotation&gt;         &lt;documentation&gt;Spülung, wirkstofffrei&lt;/documentation&gt;       &lt;/annotation&gt;     &lt;/enumeration&gt;     &lt;enumeration value="0116004"&gt;       &lt;annotation&gt; </pre>		

	<pre> &lt;documentation&gt;Spülung, andere&lt;/documentation&gt; &lt;/annotation&gt; &lt;/enumeration&gt; &lt;enumeration value="0116005"&gt;   &lt;annotation&gt;     &lt;documentation&gt;prä-/perioperative Antibiotika&lt;/documentation&gt;   &lt;/annotation&gt; &lt;/enumeration&gt; &lt;enumeration value="0116006"&gt;   &lt;annotation&gt;     &lt;documentation&gt;postoperative Antibiotika&lt;/documentation&gt;   &lt;/annotation&gt; &lt;/enumeration&gt; &lt;enumeration value="0116007"&gt;   &lt;annotation&gt;     &lt;documentation&gt;Handschuhwechsel vor Implantation&lt;/documentation&gt;   &lt;/annotation&gt; &lt;/enumeration&gt; &lt;enumeration value="0116008"&gt;   &lt;annotation&gt;     &lt;documentation&gt;Implantationshilfe&lt;/documentation&gt;   &lt;/annotation&gt; &lt;/enumeration&gt; &lt;/restriction&gt; &lt;/simpleType&gt; </pre>
--	---

### simpleType enum\_0118

namespace	http://xml.ir-d.de/stn		
type	restriction of <b>string</b>		
properties	base xs:string		
facets	Kind	Value	Annotation
	enumeration	0118001	documentation axillär
	enumeration	0118002	documentation periareolär
	enumeration	0118003	documentation inframammär
	enumeration	0118004	documentation Mastektomienarbe
	enumeration	0118042	documentation anderer
annotation	documentation Kat_BI_Operationszugang		
source	<pre> &lt;simpleType name="enum_0118"&gt;   &lt;annotation&gt;     &lt;documentation&gt;Kat_BI_Operationszugang&lt;/documentation&gt;   &lt;/annotation&gt;   &lt;restriction base="xs:string"&gt;     &lt;enumeration value="0118001"&gt;       &lt;annotation&gt;         &lt;documentation&gt;axillär&lt;/documentation&gt;       &lt;/annotation&gt;     &lt;/enumeration&gt;     &lt;enumeration value="0118002"&gt;       &lt;annotation&gt;         &lt;documentation&gt;periareolär&lt;/documentation&gt;       &lt;/annotation&gt;     &lt;/enumeration&gt;   &lt;/restriction&gt; </pre>		



	<pre> &lt;/annotation&gt; &lt;/enumeration&gt; &lt;enumeration value="0118003"&gt;   &lt;annotation&gt;     &lt;documentation&gt;inframammär&lt;/documentation&gt;   &lt;/annotation&gt; &lt;/enumeration&gt; &lt;enumeration value="0118004"&gt;   &lt;annotation&gt;     &lt;documentation&gt;Mastektomienarbe&lt;/documentation&gt;   &lt;/annotation&gt; &lt;/enumeration&gt; &lt;enumeration value="0118042"&gt;   &lt;annotation&gt;     &lt;documentation&gt;anderer&lt;/documentation&gt;   &lt;/annotation&gt; &lt;/enumeration&gt; &lt;/restriction&gt; &lt;/simpleType&gt; </pre>
--	--

### simpleType enum\_0120

namespace	http://xml.ir-d.de/stn		
type	restriction of <b>string</b>		
properties	base xs:string		
facets	Kind	Value	Annotation
	enumeration	0120001	documentation Expander defekt
annotation	documentation Kat_BI_BefundAustausch		
source	<pre> &lt;simpleType name="enum_0120"&gt;   &lt;annotation&gt;     &lt;documentation&gt;Kat_BI_BefundAustausch&lt;/documentation&gt;   &lt;/annotation&gt;   &lt;restriction base="xs:string"&gt;     &lt;enumeration value="0120001"&gt;       &lt;annotation&gt;         &lt;documentation&gt;Expander defekt&lt;/documentation&gt;       &lt;/annotation&gt;     &lt;/enumeration&gt;   &lt;/restriction&gt; &lt;/simpleType&gt; </pre>		

### simpleType enum\_0121

namespace	http://xml.ir-d.de/stn		
type	restriction of <b>string</b>		
properties	base xs:string		
facets	Kind	Value	Annotation
	enumeration	0121001	documentation Infektion
	enumeration	0121002	documentation Serom
	enumeration	0121003	documentation

	<p>enumeration 0121004 Hämatom documentation</p> <p>enumeration 0121005 Kapselfibrose documentation</p> <p>enumeration 0121006 Implantatruptur documentation</p> <p>enumeration 0121007 Fehlpositionierung/Rotation documentation</p> <p>enumeration 0121008 BIA-ALCL/-SCC, Verdacht documentation</p> <p>enumeration 0121009 BIA-ALCL/-SCC, pathologisch bestätigt documentation</p> <p>enumeration 0121010 Brustschmerzen documentation</p> <p>enumeration 0121011 Doppelkapsel documentation</p> <p>enumeration 0121012 Netz-/ADM-bedingte Komplikation, Non-Integration documentation</p> <p>enumeration 0121013 Netz-/ADM-bedingte Komplikation, andere documentation</p> <p>enumeration 0121014 Hautnekrose/exponiertes Implantat documentation</p> <p>enumeration 0121015 BII/ASIA (Brustimplantat assoziierte Symptome), Verdacht documentation</p> <p>enumeration 0121016 Lymphadenopathie documentation</p> <p>Brustkrebs, neu aufgetreten/Rezidiv</p>
annotation	documentation Kat BI BefundKomplett
source	<pre> &lt;simpleType name="enum_0121"&gt;   &lt;annotation&gt;     &lt;documentation&gt;Kat_BI_BefundKomplett&lt;/documentation&gt;   &lt;/annotation&gt;   &lt;restriction base="xs:string"&gt;     &lt;enumeration value="0121001"&gt;       &lt;annotation&gt;         &lt;documentation&gt;Infektion&lt;/documentation&gt;       &lt;/annotation&gt;     &lt;/enumeration&gt;     &lt;enumeration value="0121002"&gt;       &lt;annotation&gt;         &lt;documentation&gt;Serom&lt;/documentation&gt;       &lt;/annotation&gt;     &lt;/enumeration&gt;     &lt;enumeration value="0121003"&gt;       &lt;annotation&gt;         &lt;documentation&gt;Hämatom&lt;/documentation&gt;       &lt;/annotation&gt;     &lt;/enumeration&gt;     &lt;enumeration value="0121004"&gt;       &lt;annotation&gt;         &lt;documentation&gt;Kapselfibrose&lt;/documentation&gt;       &lt;/annotation&gt;     &lt;/enumeration&gt;     &lt;enumeration value="0121005"&gt;       &lt;annotation&gt;         &lt;documentation&gt;Implantatruptur&lt;/documentation&gt;       &lt;/annotation&gt;     &lt;/enumeration&gt;     &lt;enumeration value="0121006"&gt;       &lt;annotation&gt; </pre>

```

    <documentation>Fehlpositionierung/Rotation</documentation>
  </annotation>
</enumeration>
<enumeration value="0121007">
  <annotation>
    <documentation>BIA-ALCL/-SCC, Verdacht</documentation>
  </annotation>
</enumeration>
<enumeration value="0121008">
  <annotation>
    <documentation>BIA-ALCL/-SCC, pathologisch bestätigt</documentation>
  </annotation>
</enumeration>
<enumeration value="0121009">
  <annotation>
    <documentation>Brustschmerzen</documentation>
  </annotation>
</enumeration>
<enumeration value="0121010">
  <annotation>
    <documentation>Doppelkapsel</documentation>
  </annotation>
</enumeration>
<enumeration value="0121011">
  <annotation>
    <documentation>Netz-/ADM-bedingte Komplikation,
Non-Integration</documentation>
  </annotation>
</enumeration>
<enumeration value="0121012">
  <annotation>
    <documentation>Netz-/ADM-bedingte Komplikation, andere</documentation>
  </annotation>
</enumeration>
<enumeration value="0121013">
  <annotation>
    <documentation>Hautnekrose/exponiertes Implantat</documentation>
  </annotation>
</enumeration>
<enumeration value="0121014">
  <annotation>
    <documentation>BII/ASIA (Brustimplantat assoziierte Symptome),
Verdacht</documentation>
  </annotation>
</enumeration>
<enumeration value="0121015">
  <annotation>
    <documentation>Lymphadenopathie</documentation>
  </annotation>
</enumeration>
<enumeration value="0121016">
  <annotation>
    <documentation>Brustkrebs, neu aufgetreten/Rezidiv</documentation>
  </annotation>
</enumeration>
</restriction>
</simpleType>

```

### simpleType enum\_0122

namespace	http://xml.ir-d.de/stn		
type	restriction of <b>string</b>		
properties	base xs:string		
facets	Kind	Value	Annotation
	enumeration	0122001	documentation ja, ärztlich nachgewiesen
	enumeration	0122002	documentation nein
	enumeration	0122042	documentation unbekannt
annotation	documentation Kat_BI_Autoimmunerkrankung		
source	<pre> &lt;simpleType name="enum_0122"&gt;   &lt;annotation&gt;     &lt;documentation&gt;Kat_BI_Autoimmunerkrankung&lt;/documentation&gt;   &lt;/annotation&gt;   &lt;restriction base="xs:string"&gt;     &lt;enumeration value="0122001"&gt;       &lt;annotation&gt;         &lt;documentation&gt;ja, ärztlich nachgewiesen&lt;/documentation&gt;       &lt;/annotation&gt;     &lt;/enumeration&gt;     &lt;enumeration value="0122002"&gt;       &lt;annotation&gt;         &lt;documentation&gt;nein&lt;/documentation&gt;       &lt;/annotation&gt;     &lt;/enumeration&gt;     &lt;enumeration value="0122042"&gt;       &lt;annotation&gt;         &lt;documentation&gt;unbekannt&lt;/documentation&gt;       &lt;/annotation&gt;     &lt;/enumeration&gt;   &lt;/restriction&gt; &lt;/simpleType&gt; </pre>		

### simpleType enum\_0123

namespace	http://xml.ir-d.de/stn		
type	restriction of <b>string</b>		
properties	base xs:string		
facets	Kind	Value	Annotation
	enumeration	0123001	documentation neu aufgetreten
	enumeration	0123002	documentation verschlechtert
	enumeration	0123003	documentation keine Veränderung
	enumeration	0123004	documentation nicht relevant, da Primäreingriff
	enumeration	0123042	documentation unbekannt
annotation	documentation Kat_BI_VerlaufAutoimmunerkrankung		

source	<pre> &lt;simpleType name="enum_0123"&gt;   &lt;annotation&gt;     &lt;documentation&gt;Kat_BI_VerlaufAutoimmunerkrankung&lt;/documentation&gt;   &lt;/annotation&gt;   &lt;restriction base="xs:string"&gt;     &lt;enumeration value="0123001"&gt;       &lt;annotation&gt;         &lt;documentation&gt;neu aufgetreten&lt;/documentation&gt;       &lt;/annotation&gt;     &lt;/enumeration&gt;     &lt;enumeration value="0123002"&gt;       &lt;annotation&gt;         &lt;documentation&gt;verschlechtert&lt;/documentation&gt;       &lt;/annotation&gt;     &lt;/enumeration&gt;     &lt;enumeration value="0123003"&gt;       &lt;annotation&gt;         &lt;documentation&gt;keine Veränderung&lt;/documentation&gt;       &lt;/annotation&gt;     &lt;/enumeration&gt;     &lt;enumeration value="0123004"&gt;       &lt;annotation&gt;         &lt;documentation&gt;nicht relevant, da Primäreingriff&lt;/documentation&gt;       &lt;/annotation&gt;     &lt;/enumeration&gt;     &lt;enumeration value="0123042"&gt;       &lt;annotation&gt;         &lt;documentation&gt;unbekannt&lt;/documentation&gt;       &lt;/annotation&gt;     &lt;/enumeration&gt;   &lt;/restriction&gt; &lt;/simpleType&gt; </pre>
--------	--

### simpleType enum\_0124

namespace	http://xml.ir-d.de/stn		
type	restriction of <b>string</b>		
properties	base xs:string		
facets	Kind	Value	Annotation
	enumeration	0124001	documentation Salzlösung
	enumeration	0124002	documentation Silikongel
	enumeration	0124003	documentation Kombination Silikongel und Salzlösung
	enumeration	0124042	documentation sonstige
annotation	documentation Kat_BI_Fuellung		
source	<pre> &lt;simpleType name="enum_0124"&gt;   &lt;annotation&gt;     &lt;documentation&gt;Kat_BI_Fuellung&lt;/documentation&gt;   &lt;/annotation&gt;   &lt;restriction base="xs:string"&gt;     &lt;enumeration value="0124001"&gt;       &lt;annotation&gt;         &lt;documentation&gt;Salzlösung&lt;/documentation&gt; </pre>		

	<pre> &lt;/annotation&gt; &lt;/enumeration&gt; &lt;enumeration value="0124002"&gt;   &lt;annotation&gt;     &lt;documentation&gt;Silikongel&lt;/documentation&gt;   &lt;/annotation&gt; &lt;/enumeration&gt; &lt;enumeration value="0124003"&gt;   &lt;annotation&gt;     &lt;documentation&gt;Kombination Silikongel und Salzlösung&lt;/documentation&gt;   &lt;/annotation&gt; &lt;/enumeration&gt; &lt;enumeration value="0124042"&gt;   &lt;annotation&gt;     &lt;documentation&gt;sonstige&lt;/documentation&gt;   &lt;/annotation&gt; &lt;/enumeration&gt; &lt;/restriction&gt; &lt;/simpleType&gt; </pre>
--	---

### simpleType enum 0126

namespace	http://xml.ir-d.de/stn		
type	restriction of <b>string</b>		
properties	base xs:string		
facets	Kind	Value	Annotation
	enumeration	0126001	documentation anatomisch (tropfenförmig)
	enumeration	0126002	documentation rund (punktsymmetrisch)
	enumeration	0126042	documentation sonstige
annotation	documentation Kat_BI_Form		
source	<pre> &lt;simpleType name="enum_0126"&gt;   &lt;annotation&gt;     &lt;documentation&gt;Kat_BI_Form&lt;/documentation&gt;   &lt;/annotation&gt;   &lt;restriction base="xs:string"&gt;     &lt;enumeration value="0126001"&gt;       &lt;annotation&gt;         &lt;documentation&gt;anatomisch (tropfenförmig)&lt;/documentation&gt;       &lt;/annotation&gt;     &lt;/enumeration&gt;     &lt;enumeration value="0126002"&gt;       &lt;annotation&gt;         &lt;documentation&gt;rund (punktsymmetrisch)&lt;/documentation&gt;       &lt;/annotation&gt;     &lt;/enumeration&gt;     &lt;enumeration value="0126042"&gt;       &lt;annotation&gt;         &lt;documentation&gt;sonstige&lt;/documentation&gt;       &lt;/annotation&gt;     &lt;/enumeration&gt;   &lt;/restriction&gt; &lt;/simpleType&gt; </pre>		

### simpleType enum\_0128

namespace	http://xml.ir-d.de/stn		
type	restriction of <b>string</b>		
properties	base xs:string		
facets	Kind	Value	Annotation
	enumeration	0128001	documentation glattwandig
	enumeration	0128002	documentation beschichtet
	enumeration	0128003	documentation texturiert
annotation	documentation Kat_BI_Oberflaeche		
source	<pre> &lt;simpleType name="enum_0128"&gt;   &lt;annotation&gt;     &lt;documentation&gt;Kat_BI_Oberflaeche&lt;/documentation&gt;   &lt;/annotation&gt;   &lt;restriction base="xs:string"&gt;     &lt;enumeration value="0128001"&gt;       &lt;annotation&gt;         &lt;documentation&gt;glattwandig&lt;/documentation&gt;       &lt;/annotation&gt;     &lt;/enumeration&gt;     &lt;enumeration value="0128002"&gt;       &lt;annotation&gt;         &lt;documentation&gt;beschichtet&lt;/documentation&gt;       &lt;/annotation&gt;     &lt;/enumeration&gt;     &lt;enumeration value="0128003"&gt;       &lt;annotation&gt;         &lt;documentation&gt;texturiert&lt;/documentation&gt;       &lt;/annotation&gt;     &lt;/enumeration&gt;   &lt;/restriction&gt; &lt;/simpleType&gt; </pre>		

### simpleType enum\_0130

namespace	http://xml.ir-d.de/stn		
type	restriction of <b>string</b>		
properties	base xs:string		
facets	Kind	Value	Annotation
	enumeration	0130001	documentation Allergan
	enumeration	0130002	documentation Cereplas
	enumeration	0130003	documentation CUI (Cox Uphoff Implants)
	enumeration	0130004	documentation EMSI Biomedical
	enumeration	0130005	documentation Establishment labs
	enumeration	0130006	documentation Eurosilicone

	<p>enumeration 0130007 documentation Nagor</p> <p>enumeration 0130008 documentation Groupe Sebbin</p> <p>enumeration 0130009 documentation Laboratoires Arion</p> <p>enumeration 0130010 documentation Mentor</p> <p>enumeration 0130011 documentation Pérouse Plastie SAS</p> <p>enumeration 0130012 documentation PIP M-Implants</p> <p>enumeration 0130013 documentation Polytech Health &amp; Aesthetics</p> <p>enumeration 0130014 documentation Silimed</p> <p>enumeration 0130015 documentation Surgitek</p> <p>enumeration 0130016 documentation G&amp;G Biotechnology</p> <p>enumeration 0130017 documentation nicht belegter Wert</p> <p>enumeration 0130018 documentation nicht belegter Wert</p> <p>enumeration 0130019 documentation nicht belegter Wert</p> <p>enumeration 0130020 documentation nicht belegter Wert</p> <p>enumeration 0130021 documentation nicht belegter Wert</p> <p>enumeration 0130042 documentation sonstiger</p>
annotation	documentation Kat_BI_Hersteller
source	<pre> &lt;simpleType name="enum_0130"&gt;   &lt;annotation&gt;     &lt;documentation&gt;Kat_BI_Hersteller&lt;/documentation&gt;   &lt;/annotation&gt;   &lt;restriction base="xs:string"&gt;     &lt;enumeration value="0130001"&gt;       &lt;annotation&gt;         &lt;documentation&gt;Allergan&lt;/documentation&gt;       &lt;/annotation&gt;     &lt;/enumeration&gt;     &lt;enumeration value="0130002"&gt;       &lt;annotation&gt;         &lt;documentation&gt;Cereplas&lt;/documentation&gt;       &lt;/annotation&gt;     &lt;/enumeration&gt;     &lt;enumeration value="0130003"&gt;       &lt;annotation&gt;         &lt;documentation&gt;CUI (Cox Uphoff Implants)&lt;/documentation&gt;       &lt;/annotation&gt;     &lt;/enumeration&gt;     &lt;enumeration value="0130004"&gt;       &lt;annotation&gt;         &lt;documentation&gt;EMSI Biomedical&lt;/documentation&gt;       &lt;/annotation&gt;     &lt;/enumeration&gt;     &lt;enumeration value="0130005"&gt;       &lt;annotation&gt;         &lt;documentation&gt;Establishment labs&lt;/documentation&gt;       &lt;/annotation&gt;     &lt;/enumeration&gt;   &lt;/restriction&gt; &lt;/simpleType&gt; </pre>



```
</annotation>
</enumeration>
<enumeration value="0130006">
  <annotation>
    <documentation>Eurosilicone</documentation>
  </annotation>
</enumeration>
<enumeration value="0130007">
  <annotation>
    <documentation>Nagor</documentation>
  </annotation>
</enumeration>
<enumeration value="0130008">
  <annotation>
    <documentation>Groupe Sebbin</documentation>
  </annotation>
</enumeration>
<enumeration value="0130009">
  <annotation>
    <documentation>Laboratoires Arion</documentation>
  </annotation>
</enumeration>
<enumeration value="0130010">
  <annotation>
    <documentation>Mentor</documentation>
  </annotation>
</enumeration>
<enumeration value="0130011">
  <annotation>
    <documentation>Pérouse Plastie SAS</documentation>
  </annotation>
</enumeration>
<enumeration value="0130012">
  <annotation>
    <documentation>PIP M-Implants</documentation>
  </annotation>
</enumeration>
<enumeration value="0130013">
  <annotation>
    <documentation>Polytech Health & Aesthetics</documentation>
  </annotation>
</enumeration>
<enumeration value="0130014">
  <annotation>
    <documentation>Silimed</documentation>
  </annotation>
</enumeration>
<enumeration value="0130015">
  <annotation>
    <documentation>Surgitek</documentation>
  </annotation>
</enumeration>
<enumeration value="0130016">
  <annotation>
    <documentation>G&G Biotechnology</documentation>
  </annotation>
</enumeration>
<enumeration value="0130017">
  <annotation>
```

```

    <documentation>nicht belegter Wert</documentation>
  </annotation>
</enumeration>
<enumeration value="0130018">
  <annotation>
    <documentation>nicht belegter Wert</documentation>
  </annotation>
</enumeration>
<enumeration value="0130019">
  <annotation>
    <documentation>nicht belegter Wert</documentation>
  </annotation>
</enumeration>
<enumeration value="0130020">
  <annotation>
    <documentation>nicht belegter Wert</documentation>
  </annotation>
</enumeration>
<enumeration value="0130021">
  <annotation>
    <documentation>nicht belegter Wert</documentation>
  </annotation>
</enumeration>
<enumeration value="0130042">
  <annotation>
    <documentation>sonstiger</documentation>
  </annotation>
</enumeration>
</restriction>
</simpleType>

```

simpleType enum\_0131

namespace	http://xml.ir-d.de/stn		
type	restriction of <b>string</b>		
properties	base xs:string		
facets	Kind	Value	Annotation
	enumeration	0131001	documentation Allergan
	enumeration	0131002	documentation Establishment labs
	enumeration	0131003	documentation Eurosilicone
	enumeration	0131004	documentation Galatea
	enumeration	0131005	documentation Integra
	enumeration	0131006	documentation Lifecell
	enumeration	0131007	documentation MBP (Medical Biomaterial Products)
	enumeration	0131008	documentation Mentor
	enumeration	0131009	documentation Novus Scientific
	enumeration	0131010	documentation pfmMedical
	enumeration	0131011	documentation

	<p>enumeration 0131012 nicht belegter Wert documentation nicht belegter Wert</p> <p>enumeration 0131013 documentation nicht belegter Wert</p> <p>enumeration 0131014 documentation nicht belegter Wert</p> <p>enumeration 0131015 documentation nicht belegter Wert</p> <p>enumeration 0131042 documentation sonstiger</p>
annotation	documentation Kat BI_ZubehoerHersteller
source	<pre> &lt;simpleType name="enum_0131"&gt;   &lt;annotation&gt;     &lt;documentation&gt;Kat_BI_ZubehoerHersteller&lt;/documentation&gt;   &lt;/annotation&gt;   &lt;restriction base="xs:string"&gt;     &lt;enumeration value="0131001"&gt;       &lt;annotation&gt;         &lt;documentation&gt;Allergan&lt;/documentation&gt;       &lt;/annotation&gt;     &lt;/enumeration&gt;     &lt;enumeration value="0131002"&gt;       &lt;annotation&gt;         &lt;documentation&gt;Establishment labs&lt;/documentation&gt;       &lt;/annotation&gt;     &lt;/enumeration&gt;     &lt;enumeration value="0131003"&gt;       &lt;annotation&gt;         &lt;documentation&gt;Eurosilicone&lt;/documentation&gt;       &lt;/annotation&gt;     &lt;/enumeration&gt;     &lt;enumeration value="0131004"&gt;       &lt;annotation&gt;         &lt;documentation&gt;Galatea&lt;/documentation&gt;       &lt;/annotation&gt;     &lt;/enumeration&gt;     &lt;enumeration value="0131005"&gt;       &lt;annotation&gt;         &lt;documentation&gt;Integra&lt;/documentation&gt;       &lt;/annotation&gt;     &lt;/enumeration&gt;     &lt;enumeration value="0131006"&gt;       &lt;annotation&gt;         &lt;documentation&gt;Lifecell&lt;/documentation&gt;       &lt;/annotation&gt;     &lt;/enumeration&gt;     &lt;enumeration value="0131007"&gt;       &lt;annotation&gt;         &lt;documentation&gt;MBP (Medical Biomaterial Products)&lt;/documentation&gt;       &lt;/annotation&gt;     &lt;/enumeration&gt;     &lt;enumeration value="0131008"&gt;       &lt;annotation&gt;         &lt;documentation&gt;Mentor&lt;/documentation&gt;       &lt;/annotation&gt;     &lt;/enumeration&gt;     &lt;enumeration value="0131009"&gt;       &lt;annotation&gt; </pre>

```

    <documentation>Novus Scientific</documentation>
  </annotation>
</enumeration>
<enumeration value="0131010">
  <annotation>
    <documentation>pfmMedical</documentation>
  </annotation>
</enumeration>
<enumeration value="0131011">
  <annotation>
    <documentation>nicht belegter Wert</documentation>
  </annotation>
</enumeration>
<enumeration value="0131012">
  <annotation>
    <documentation>nicht belegter Wert</documentation>
  </annotation>
</enumeration>
<enumeration value="0131013">
  <annotation>
    <documentation>nicht belegter Wert</documentation>
  </annotation>
</enumeration>
<enumeration value="0131014">
  <annotation>
    <documentation>nicht belegter Wert</documentation>
  </annotation>
</enumeration>
<enumeration value="0131015">
  <annotation>
    <documentation>nicht belegter Wert</documentation>
  </annotation>
</enumeration>
<enumeration value="0131042">
  <annotation>
    <documentation>sonstiger</documentation>
  </annotation>
</enumeration>
</restriction>
</simpleType>

```

simpleType **enum\_0190**

namespace	http://xml.ir-d.de/stn		
type	restriction of <b>string</b>		
properties	base xs:string		
facets	Kind	Value	Annotation
	enumeration	0190001	documentation Brustimplantat
	enumeration	0190003	documentation Brustexpander
annotation	documentation Kat_BI_Artikeltyp		
source	<pre> &lt;simpleType name="enum_0190"&gt;   &lt;annotation&gt;     &lt;documentation&gt;Kat_BI_Artikeltyp&lt;/documentation&gt;   &lt;/annotation&gt; </pre>		

	<pre> &lt;restriction base="xs:string"&gt;   &lt;enumeration value="0190001"&gt;     &lt;annotation&gt;       &lt;documentation&gt;Brustimplantat&lt;/documentation&gt;     &lt;/annotation&gt;   &lt;/enumeration&gt;   &lt;enumeration value="0190003"&gt;     &lt;annotation&gt;       &lt;documentation&gt;Brustexpander&lt;/documentation&gt;     &lt;/annotation&gt;   &lt;/enumeration&gt; &lt;/restriction&gt; &lt;/simpleType&gt; </pre>
--	---

### simpleType enum\_0191

namespace	http://xml.ir-d.de/stn		
type	restriction of <b>string</b>		
properties	base xs:string		
facets	Kind	Value	Annotation
	enumeration	0191001	documentation Netz
	enumeration	0191002	documentation ADM
annotation	documentation Kat_BI_ZubehoerTyp		
source	<pre> &lt;simpleType name="enum_0191"&gt;   &lt;annotation&gt;     &lt;documentation&gt;Kat_BI_ZubehoerTyp&lt;/documentation&gt;   &lt;/annotation&gt;   &lt;restriction base="xs:string"&gt;     &lt;enumeration value="0191001"&gt;       &lt;annotation&gt;         &lt;documentation&gt;Netz&lt;/documentation&gt;       &lt;/annotation&gt;     &lt;/enumeration&gt;     &lt;enumeration value="0191002"&gt;       &lt;annotation&gt;         &lt;documentation&gt;ADM&lt;/documentation&gt;       &lt;/annotation&gt;     &lt;/enumeration&gt;   &lt;/restriction&gt; &lt;/simpleType&gt; </pre>		

### simpleType enum\_0200

namespace	http://xml.ir-d.de/stn		
type	restriction of <b>string</b>		
properties	base xs:string		
facets	Kind	Value	Annotation
	enumeration	0200001	documentation Erst-OP
	enumeration	0200002	documentation Folgeeingriff

annotation	documentation Kat_EP_ArtEingriff
source	<pre> &lt;simpleType name="enum_0200"&gt;   &lt;annotation&gt;     &lt;documentation&gt;Kat_EP_ArtEingriff&lt;/documentation&gt;   &lt;/annotation&gt;   &lt;restriction base="xs:string"&gt;     &lt;enumeration value="0200001"&gt;       &lt;annotation&gt;         &lt;documentation&gt;Erst-OP&lt;/documentation&gt;       &lt;/annotation&gt;     &lt;/enumeration&gt;     &lt;enumeration value="0200002"&gt;       &lt;annotation&gt;         &lt;documentation&gt;Folgeeingriff&lt;/documentation&gt;       &lt;/annotation&gt;     &lt;/enumeration&gt;   &lt;/restriction&gt; &lt;/simpleType&gt; </pre>

### simpleType enum\_0202

namespace	http://xml.ir-d.de/stn		
type	restriction of <b>string</b>		
properties	base xs:string		
facets	Kind	Value	Annotation
	enumeration	0202001	documentation Lockerung
	enumeration	0202002	documentation Infektion, Verdacht auf
	enumeration	0202003	documentation Infektion, gesichert
	enumeration	0202004	documentation Luxation, Inlay aus der Pfanne
	enumeration	0202005	documentation Luxation, Kopf aus Pfanne/Inlay
	enumeration	0202006	documentation Periprothetische Fraktur
	enumeration	0202007	documentation Verschleiß des PE-Inlays
	enumeration	0202008	documentation Implantatbruch
	enumeration	0202009	documentation Implantatfehlage/Malalignent
	enumeration	0202010	documentation Osteolysen bei festem Implantat
	enumeration	0202011	documentation Progression der Grunderkrankung
	enumeration	0202012	documentation ARMD
	enumeration	0202013	documentation Verdacht auf allergische Reaktion
	enumeration	0202021	documentation Zustand nach Prothesenentfernung
	enumeration	0202042	documentation andere Gründe
annotation	documentation Kat_EP_GrundWechselHuefte		
source	<pre> &lt;simpleType name="enum_0202"&gt; </pre>		

```

<annotation>
  <documentation>Kat_EP_GrundWechselHuefte</documentation>
</annotation>
<restriction base="xs:string">
  <enumeration value="0202001">
    <annotation>
      <documentation>Lockerung</documentation>
    </annotation>
  </enumeration>
  <enumeration value="0202002">
    <annotation>
      <documentation>Infektion, Verdacht auf</documentation>
    </annotation>
  </enumeration>
  <enumeration value="0202003">
    <annotation>
      <documentation>Infektion, gesichert</documentation>
    </annotation>
  </enumeration>
  <enumeration value="0202004">
    <annotation>
      <documentation>Luxation, Inlay aus der Pfanne</documentation>
    </annotation>
  </enumeration>
  <enumeration value="0202005">
    <annotation>
      <documentation>Luxation, Kopf aus Pfanne/Inlay</documentation>
    </annotation>
  </enumeration>
  <enumeration value="0202006">
    <annotation>
      <documentation>Periprothetische Fraktur</documentation>
    </annotation>
  </enumeration>
  <enumeration value="0202007">
    <annotation>
      <documentation>Verschleiß des PE-Inlays</documentation>
    </annotation>
  </enumeration>
  <enumeration value="0202008">
    <annotation>
      <documentation>Implantatbruch</documentation>
    </annotation>
  </enumeration>
  <enumeration value="0202009">
    <annotation>
      <documentation>Implantatfehllage/Malalignent</documentation>
    </annotation>
  </enumeration>
  <enumeration value="0202010">
    <annotation>
      <documentation>Osteolysen bei festem Implantat</documentation>
    </annotation>
  </enumeration>
  <enumeration value="0202011">
    <annotation>
      <documentation>Progression der Grunderkrankung</documentation>
    </annotation>
  </enumeration>
</restriction>

```

```

<enumeration value="0202012">
  <annotation>
    <documentation>ARMD</documentation>
  </annotation>
</enumeration>
<enumeration value="0202013">
  <annotation>
    <documentation>Verdacht auf allergische Reaktion</documentation>
  </annotation>
</enumeration>
<enumeration value="0202021">
  <annotation>
    <documentation>Zustand nach Prothesenentfernung</documentation>
  </annotation>
</enumeration>
<enumeration value="0202042">
  <annotation>
    <documentation>andere Gründe</documentation>
  </annotation>
</enumeration>
</restriction>
</simpleType>

```

simpleType enum\_0204

namespace	http://xml.ir-d.de/stn		
type	restriction of <b>string</b>		
properties	base xs:string		
facets	Kind	Value	Annotation
	enumeration	0204001	documentation Lockerung
	enumeration	0204002	documentation Infektion, Verdacht auf
	enumeration	0204003	documentation Infektion, gesichert
	enumeration	0204006	documentation Periprothetische Fraktur
	enumeration	0204007	documentation Verschleiß
	enumeration	0204008	documentation Implantatbruch
	enumeration	0204009	documentation Implantatfehlage/Malalignent
	enumeration	0204010	documentation Osteolysen bei festem Implantat
	enumeration	0204011	documentation Progression der Grunderkrankung
	enumeration	0204012	documentation ARMD
	enumeration	0204013	documentation Verdacht auf allergische Reaktion
	enumeration	0204014	documentation Dislokation/Migration von Komponenten
	enumeration	0204015	documentation Bandinstabilität
	enumeration	0204016	documentation Bewegungseinschränkung
	enumeration	0204021	documentation Zustand nach Prothesenentfernung



	enumeration 0204042 documentation andere Gründe
annotation	documentation Kat_EP_GrundWechselKnie
source	<pre> &lt;simpleType name="enum_0204"&gt;   &lt;annotation&gt;     &lt;documentation&gt;Kat_EP_GrundWechselKnie&lt;/documentation&gt;   &lt;/annotation&gt;   &lt;restriction base="xs:string"&gt;     &lt;enumeration value="0204001"&gt;       &lt;annotation&gt;         &lt;documentation&gt;Lockerung&lt;/documentation&gt;       &lt;/annotation&gt;     &lt;/enumeration&gt;     &lt;enumeration value="0204002"&gt;       &lt;annotation&gt;         &lt;documentation&gt;Infektion, Verdacht auf&lt;/documentation&gt;       &lt;/annotation&gt;     &lt;/enumeration&gt;     &lt;enumeration value="0204003"&gt;       &lt;annotation&gt;         &lt;documentation&gt;Infektion, gesichert&lt;/documentation&gt;       &lt;/annotation&gt;     &lt;/enumeration&gt;     &lt;enumeration value="0204006"&gt;       &lt;annotation&gt;         &lt;documentation&gt;Periprothetische Fraktur&lt;/documentation&gt;       &lt;/annotation&gt;     &lt;/enumeration&gt;     &lt;enumeration value="0204007"&gt;       &lt;annotation&gt;         &lt;documentation&gt;Verschleiß&lt;/documentation&gt;       &lt;/annotation&gt;     &lt;/enumeration&gt;     &lt;enumeration value="0204008"&gt;       &lt;annotation&gt;         &lt;documentation&gt;Implantatbruch&lt;/documentation&gt;       &lt;/annotation&gt;     &lt;/enumeration&gt;     &lt;enumeration value="0204009"&gt;       &lt;annotation&gt;         &lt;documentation&gt;Implantatfehllage/Malalignent&lt;/documentation&gt;       &lt;/annotation&gt;     &lt;/enumeration&gt;     &lt;enumeration value="0204010"&gt;       &lt;annotation&gt;         &lt;documentation&gt;Osteolysen bei festem Implantat&lt;/documentation&gt;       &lt;/annotation&gt;     &lt;/enumeration&gt;     &lt;enumeration value="0204011"&gt;       &lt;annotation&gt;         &lt;documentation&gt;Progression der Grunderkrankung&lt;/documentation&gt;       &lt;/annotation&gt;     &lt;/enumeration&gt;     &lt;enumeration value="0204012"&gt;       &lt;annotation&gt;         &lt;documentation&gt;ARMD&lt;/documentation&gt;       &lt;/annotation&gt;     &lt;/enumeration&gt;   &lt;/restriction&gt; &lt;/simpleType&gt; </pre>

```

<enumeration value="0204013">
  <annotation>
    <documentation>Verdacht auf allergische Reaktion</documentation>
  </annotation>
</enumeration>
<enumeration value="0204014">
  <annotation>
    <documentation>Dislokation/Migration von Komponenten</documentation>
  </annotation>
</enumeration>
<enumeration value="0204015">
  <annotation>
    <documentation>Bandinstabilität</documentation>
  </annotation>
</enumeration>
<enumeration value="0204016">
  <annotation>
    <documentation>Bewegungseinschränkung</documentation>
  </annotation>
</enumeration>
<enumeration value="0204021">
  <annotation>
    <documentation>Zustand nach Prothesenentfernung</documentation>
  </annotation>
</enumeration>
<enumeration value="0204042">
  <annotation>
    <documentation>andere Gründe</documentation>
  </annotation>
</enumeration>
</restriction>
</simpleType>

```

### simpleType enum\_0206

namespace	http://xml.ir-d.de/stn		
type	restriction of <b>string</b>		
properties	base xs:string		
facets	Kind	Value	Annotation
	enumeration	0206001	documentation Lockerung
	enumeration	0206002	documentation Infektion, Verdacht auf
	enumeration	0206003	documentation Infektion, gesichert
	enumeration	0206004	documentation Luxation, Inlay aus der Pfanne
	enumeration	0206005	documentation Luxation, Kopf aus Pfanne/Inlay
	enumeration	0206006	documentation Periprothetische Fraktur
	enumeration	0206007	documentation Verschleiß
	enumeration	0206008	documentation Implantatbruch
	enumeration	0206009	documentation Implantatfehlage/Malalignent
	enumeration	0206010	documentation

	<p>enumeration 0206011 Osteolysen bei festem Implantat documentation Progression der Grunderkrankung</p> <p>enumeration 0206012 documentation ARMD</p> <p>enumeration 0206013 documentation Verdacht auf allergische Reaktion</p> <p>enumeration 0206014 documentation Dislokation/Migration von Komponenten</p> <p>enumeration 0206015 documentation Bandinstabilität</p> <p>enumeration 0206016 documentation Bewegungseinschränkung</p> <p>enumeration 0206021 documentation Zustand nach Prothesenentfernung</p> <p>enumeration 0206042 documentation andere Gründe</p>
annotation	documentation Kat_EP_GrundWechselTFE
source	<pre> &lt;simpleType name="enum_0206"&gt;   &lt;annotation&gt;     &lt;documentation&gt;Kat_EP_GrundWechselTFE&lt;/documentation&gt;   &lt;/annotation&gt;   &lt;restriction base="xs:string"&gt;     &lt;enumeration value="0206001"&gt;       &lt;annotation&gt;         &lt;documentation&gt;Lockerung&lt;/documentation&gt;       &lt;/annotation&gt;     &lt;/enumeration&gt;     &lt;enumeration value="0206002"&gt;       &lt;annotation&gt;         &lt;documentation&gt;Infektion, Verdacht auf&lt;/documentation&gt;       &lt;/annotation&gt;     &lt;/enumeration&gt;     &lt;enumeration value="0206003"&gt;       &lt;annotation&gt;         &lt;documentation&gt;Infektion, gesichert&lt;/documentation&gt;       &lt;/annotation&gt;     &lt;/enumeration&gt;     &lt;enumeration value="0206004"&gt;       &lt;annotation&gt;         &lt;documentation&gt;Luxation, Inlay aus der Pfanne&lt;/documentation&gt;       &lt;/annotation&gt;     &lt;/enumeration&gt;     &lt;enumeration value="0206005"&gt;       &lt;annotation&gt;         &lt;documentation&gt;Luxation, Kopf aus Pfanne/Inlay&lt;/documentation&gt;       &lt;/annotation&gt;     &lt;/enumeration&gt;     &lt;enumeration value="0206006"&gt;       &lt;annotation&gt;         &lt;documentation&gt;Periprothetische Fraktur&lt;/documentation&gt;       &lt;/annotation&gt;     &lt;/enumeration&gt;     &lt;enumeration value="0206007"&gt;       &lt;annotation&gt;         &lt;documentation&gt;Verschleiß&lt;/documentation&gt;       &lt;/annotation&gt;     &lt;/enumeration&gt;     &lt;enumeration value="0206008"&gt; </pre>

```
<annotation>
  <documentation>Implantatbruch</documentation>
</annotation>
</enumeration>
<enumeration value="0206009">
  <annotation>
    <documentation>Implantatfehllage/Malalignent</documentation>
  </annotation>
</enumeration>
<enumeration value="0206010">
  <annotation>
    <documentation>Osteolysen bei festem Implantat</documentation>
  </annotation>
</enumeration>
<enumeration value="0206011">
  <annotation>
    <documentation>Progression der Grunderkrankung</documentation>
  </annotation>
</enumeration>
<enumeration value="0206012">
  <annotation>
    <documentation>ARMD</documentation>
  </annotation>
</enumeration>
<enumeration value="0206013">
  <annotation>
    <documentation>Verdacht auf allergische Reaktion</documentation>
  </annotation>
</enumeration>
<enumeration value="0206014">
  <annotation>
    <documentation>Dislokation/Migration von Komponenten</documentation>
  </annotation>
</enumeration>
<enumeration value="0206015">
  <annotation>
    <documentation>Bandinstabilität</documentation>
  </annotation>
</enumeration>
<enumeration value="0206016">
  <annotation>
    <documentation>Bewegungseinschränkung</documentation>
  </annotation>
</enumeration>
<enumeration value="0206021">
  <annotation>
    <documentation>Zustand nach Prothesenentfernung</documentation>
  </annotation>
</enumeration>
<enumeration value="0206042">
  <annotation>
    <documentation>andere Gründe</documentation>
  </annotation>
</enumeration>
</restriction>
</simpleType>
```

### simpleType enum\_0210

namespace	http://xml.ir-d.de/strn		
type	restriction of <b>string</b>		
properties	base xs:string		
facets	Kind	Value	Annotation
	enumeration	0210001	documentation keine relevante Voroperation
	enumeration	0210002	documentation Osteosynthese/Osteotomie (Becken)
	enumeration	0210003	documentation Osteosynthese/Osteotomie (Femur)
	enumeration	0210004	documentation Osteosynthese/Osteotomie (beides)
	enumeration	0210005	documentation Operation bei Hüftkopfnekrose
	enumeration	0210006	documentation Arthrodese
	enumeration	0210042	documentation andere
annotation	documentation Kat_EP_VoroperationHuefte		
source	<pre> &lt;simpleType name="enum_0210"&gt;   &lt;annotation&gt;     &lt;documentation&gt;Kat_EP_VoroperationHuefte&lt;/documentation&gt;   &lt;/annotation&gt;   &lt;restriction base="xs:string"&gt;     &lt;enumeration value="0210001"&gt;       &lt;annotation&gt;         &lt;documentation&gt;keine relevante Voroperation&lt;/documentation&gt;       &lt;/annotation&gt;     &lt;/enumeration&gt;     &lt;enumeration value="0210002"&gt;       &lt;annotation&gt;         &lt;documentation&gt;Osteosynthese/Osteotomie (Becken)&lt;/documentation&gt;       &lt;/annotation&gt;     &lt;/enumeration&gt;     &lt;enumeration value="0210003"&gt;       &lt;annotation&gt;         &lt;documentation&gt;Osteosynthese/Osteotomie (Femur)&lt;/documentation&gt;       &lt;/annotation&gt;     &lt;/enumeration&gt;     &lt;enumeration value="0210004"&gt;       &lt;annotation&gt;         &lt;documentation&gt;Osteosynthese/Osteotomie (beides)&lt;/documentation&gt;       &lt;/annotation&gt;     &lt;/enumeration&gt;     &lt;enumeration value="0210005"&gt;       &lt;annotation&gt;         &lt;documentation&gt;Operation bei Hüftkopfnekrose&lt;/documentation&gt;       &lt;/annotation&gt;     &lt;/enumeration&gt;     &lt;enumeration value="0210006"&gt;       &lt;annotation&gt;         &lt;documentation&gt;Arthrodese&lt;/documentation&gt;       &lt;/annotation&gt;     &lt;/enumeration&gt;     &lt;enumeration value="0210042"&gt;       &lt;annotation&gt; </pre>		

	<pre> &lt;documentation&gt;andere&lt;/documentation&gt; &lt;/annotation&gt; &lt;/enumeration&gt; &lt;/restriction&gt; &lt;/simpleType&gt; </pre>
--	--

### simpleType enum\_0211

namespace	http://xml.ir-d.de/stn		
type	restriction of <b>string</b>		
properties	base xs:string		
facets	Kind	Value	Annotation
	enumeration	0211001	documentation keine relevante Voroperation
	enumeration	0211002	documentation Osteosynthese/Osteotomie (Femur)
	enumeration	0211003	documentation Osteosynthese/Osteotomie (Tibia)
	enumeration	0211004	documentation Osteosynthese/Osteotomie (Patella)
	enumeration	0211005	documentation Osteosynthese/Osteotomie (mehrere)
	enumeration	0211006	documentation Kapsel-/Bandapparat
	enumeration	0211007	documentation Arthrodese
	enumeration	0211042	documentation andere
annotation	documentation Kat_EP_VoroperationKnie		
source	<pre> &lt;simpleType name="enum_0211"&gt;   &lt;annotation&gt;     &lt;documentation&gt;Kat_EP_VoroperationKnie&lt;/documentation&gt;   &lt;/annotation&gt;   &lt;restriction base="xs:string"&gt;     &lt;enumeration value="0211001"&gt;       &lt;annotation&gt;         &lt;documentation&gt;keine relevante Voroperation&lt;/documentation&gt;       &lt;/annotation&gt;     &lt;/enumeration&gt;     &lt;enumeration value="0211002"&gt;       &lt;annotation&gt;         &lt;documentation&gt;Osteosynthese/Osteotomie (Femur)&lt;/documentation&gt;       &lt;/annotation&gt;     &lt;/enumeration&gt;     &lt;enumeration value="0211003"&gt;       &lt;annotation&gt;         &lt;documentation&gt;Osteosynthese/Osteotomie (Tibia)&lt;/documentation&gt;       &lt;/annotation&gt;     &lt;/enumeration&gt;     &lt;enumeration value="0211004"&gt;       &lt;annotation&gt;         &lt;documentation&gt;Osteosynthese/Osteotomie (Patella)&lt;/documentation&gt;       &lt;/annotation&gt;     &lt;/enumeration&gt;     &lt;enumeration value="0211005"&gt;       &lt;annotation&gt;         &lt;documentation&gt;Osteosynthese/Osteotomie (mehrere)&lt;/documentation&gt; </pre>		

	<pre> &lt;/annotation&gt; &lt;/enumeration&gt; &lt;enumeration value="0211006"&gt;   &lt;annotation&gt;     &lt;documentation&gt;Kapsel-/Bandapparat&lt;/documentation&gt;   &lt;/annotation&gt; &lt;/enumeration&gt; &lt;enumeration value="0211007"&gt;   &lt;annotation&gt;     &lt;documentation&gt;Arthrodesse&lt;/documentation&gt;   &lt;/annotation&gt; &lt;/enumeration&gt; &lt;enumeration value="0211042"&gt;   &lt;annotation&gt;     &lt;documentation&gt;andere&lt;/documentation&gt;   &lt;/annotation&gt; &lt;/enumeration&gt; &lt;/restriction&gt; &lt;/simpleType&gt; </pre>
--	--

### simpleType enum 0212

namespace	http://xml.ir-d.de/stn		
type	restriction of <b>string</b>		
properties	base xs:string		
facets	Kind	Value	Annotation
	enumeration	0212001	documentation Hüfte
	enumeration	0212002	documentation Knie
	enumeration	0212003	documentation Totaler Femurersatz inkl. Durchsteck-Prothese
annotation	documentation Kat_EP_Gelenk		
source	<pre> &lt;simpleType name="enum_0212"&gt;   &lt;annotation&gt;     &lt;documentation&gt;Kat_EP_Gelenk&lt;/documentation&gt;   &lt;/annotation&gt;   &lt;restriction base="xs:string"&gt;     &lt;enumeration value="0212001"&gt;       &lt;annotation&gt;         &lt;documentation&gt;Hüfte&lt;/documentation&gt;       &lt;/annotation&gt;     &lt;/enumeration&gt;     &lt;enumeration value="0212002"&gt;       &lt;annotation&gt;         &lt;documentation&gt;Knie&lt;/documentation&gt;       &lt;/annotation&gt;     &lt;/enumeration&gt;     &lt;enumeration value="0212003"&gt;       &lt;annotation&gt;         &lt;documentation&gt;Totaler Femurersatz inkl. Durchsteck-Prothese&lt;/documentation&gt;       &lt;/annotation&gt;     &lt;/enumeration&gt;   &lt;/restriction&gt; </pre>		

	<code>&lt;/simpleType&gt;</code>
--	----------------------------------

### simpleType enum\_0220

namespace	http://xml.ir-d.de/stn																								
type	restriction of <b>string</b>																								
properties	base xs:string																								
facets	<table><thead><tr><th>Kind</th><th>Value</th><th>Annotation</th></tr></thead><tbody><tr><td>enumeration</td><td>0220001</td><td>documentation anterior</td></tr><tr><td>enumeration</td><td>0220002</td><td>documentation anterolateral</td></tr><tr><td>enumeration</td><td>0220003</td><td>documentation lateral</td></tr><tr><td>enumeration</td><td>0220004</td><td>documentation posterior</td></tr><tr><td>enumeration</td><td>0220005</td><td>documentation posterolateral</td></tr><tr><td>enumeration</td><td>0220006</td><td>documentation 2-Inzisionen-Zugang</td></tr><tr><td>enumeration</td><td>0220042</td><td>documentation sonstiges/unbekannt</td></tr></tbody></table>	Kind	Value	Annotation	enumeration	0220001	documentation anterior	enumeration	0220002	documentation anterolateral	enumeration	0220003	documentation lateral	enumeration	0220004	documentation posterior	enumeration	0220005	documentation posterolateral	enumeration	0220006	documentation 2-Inzisionen-Zugang	enumeration	0220042	documentation sonstiges/unbekannt
Kind	Value	Annotation																							
enumeration	0220001	documentation anterior																							
enumeration	0220002	documentation anterolateral																							
enumeration	0220003	documentation lateral																							
enumeration	0220004	documentation posterior																							
enumeration	0220005	documentation posterolateral																							
enumeration	0220006	documentation 2-Inzisionen-Zugang																							
enumeration	0220042	documentation sonstiges/unbekannt																							
annotation	documentation Kat_EP_Operationszugang																								
source	<pre>&lt;simpleType name="enum_0220"&gt;   &lt;annotation&gt;     &lt;documentation&gt;Kat_EP_Operationszugang&lt;/documentation&gt;   &lt;/annotation&gt;   &lt;restriction base="xs:string"&gt;     &lt;enumeration value="0220001"&gt;       &lt;annotation&gt;         &lt;documentation&gt;anterior&lt;/documentation&gt;       &lt;/annotation&gt;     &lt;/enumeration&gt;     &lt;enumeration value="0220002"&gt;       &lt;annotation&gt;         &lt;documentation&gt;anterolateral&lt;/documentation&gt;       &lt;/annotation&gt;     &lt;/enumeration&gt;     &lt;enumeration value="0220003"&gt;       &lt;annotation&gt;         &lt;documentation&gt;lateral&lt;/documentation&gt;       &lt;/annotation&gt;     &lt;/enumeration&gt;     &lt;enumeration value="0220004"&gt;       &lt;annotation&gt;         &lt;documentation&gt;posterior&lt;/documentation&gt;       &lt;/annotation&gt;     &lt;/enumeration&gt;     &lt;enumeration value="0220005"&gt;       &lt;annotation&gt;         &lt;documentation&gt;posterolateral&lt;/documentation&gt;       &lt;/annotation&gt;     &lt;/enumeration&gt;     &lt;enumeration value="0220006"&gt;       &lt;annotation&gt;         &lt;documentation&gt;2-Inzisionen-Zugang&lt;/documentation&gt;       &lt;/annotation&gt;     &lt;/enumeration&gt;   &lt;/restriction&gt; &lt;/simpleType&gt;</pre>																								



	<pre> &lt;/annotation&gt; &lt;/enumeration&gt; &lt;enumeration value="0220042"&gt;   &lt;annotation&gt;     &lt;documentation&gt;sonstiges/unbekannt&lt;/documentation&gt;   &lt;/annotation&gt; &lt;/enumeration&gt; &lt;/restriction&gt; &lt;/simpleType&gt; </pre>
--	---

### simpleType enum\_0222

namespace	http://xml.ir-d.de/stn		
type	restriction of <b>string</b>		
properties	base xs:string		
facets	Kind	Value	Annotation
	enumeration	0222001	documentation nein
	enumeration	0222002	documentation ja- Ausbau
	enumeration	0222003	documentation ja- Einbau
annotation	documentation Kat_EP_Zweizeitwechsel		
source	<pre> &lt;simpleType name="enum_0222"&gt;   &lt;annotation&gt;     &lt;documentation&gt;Kat_EP_Zweizeitwechsel&lt;/documentation&gt;   &lt;/annotation&gt;   &lt;restriction base="xs:string"&gt;     &lt;enumeration value="0222001"&gt;       &lt;annotation&gt;         &lt;documentation&gt;nein&lt;/documentation&gt;       &lt;/annotation&gt;     &lt;/enumeration&gt;     &lt;enumeration value="0222002"&gt;       &lt;annotation&gt;         &lt;documentation&gt;ja- Ausbau&lt;/documentation&gt;       &lt;/annotation&gt;     &lt;/enumeration&gt;     &lt;enumeration value="0222003"&gt;       &lt;annotation&gt;         &lt;documentation&gt;ja- Einbau&lt;/documentation&gt;       &lt;/annotation&gt;     &lt;/enumeration&gt;   &lt;/restriction&gt; &lt;/simpleType&gt; </pre>		

### simpleType enum\_0230

namespace	http://xml.ir-d.de/stn		
type	restriction of <b>string</b>		
properties	base xs:string		
facets	Kind	Value	Annotation
	enumeration	0230001	documentation

	enumeration	0230002	Smith & Nephew GmbH documentation
	enumeration	0230003	Mathys Orthopädie GmbH documentation
	enumeration	0230004	Ceramtec AG documentation
	enumeration	0230005	Biomet documentation
	enumeration	0230006	Peter Brehm GmbH documentation
	enumeration	0230007	Amplitude GmbH documentation
	enumeration	0230008	Exactech Deutschland documentation
	enumeration	0230009	Globus Medical documentation
	enumeration	0230010	Implantcast GmbH documentation
	enumeration	0230011	DePuy Orthopädie GmbH (J&J) documentation
	enumeration	0230012	IO-International Orthopaedics documentation
	enumeration	0230013	Joint Replacement Ltd. Instrumentation documentation
	enumeration	0230014	Merete documentation
	enumeration	0230015	S&G Implants GmbH documentation
	enumeration	0230016	Speetec Implantate GmbH documentation
	enumeration	0230017	Stemcup Medical Products GmbH documentation
	enumeration	0230018	Symbios Deutschland GmbH documentation
	enumeration	0230019	Tantum AG documentation
	enumeration	0230020	Tornier GmbH documentation
	enumeration	0230021	MicroPort Orthopedics GmbH documentation
	enumeration	0230022	aap Implanate AG documentation
	enumeration	0230023	AQImplants documentation
	enumeration	0230024	ESKA Orthodynamics GmbH documentation
	enumeration	0230025	Atesos medical AG documentation
	enumeration	0230026	Chiropro GmbH documentation
	enumeration	0230027	Medacta documentation
	enumeration	0230028	OHST Medizintechnik AG documentation
	enumeration	0230029	Lima Deutschland GmbH documentation
	enumeration	0230030	alloPlus GmbH documentation
	enumeration	0230031	Heraeus Medical GmbH documentation
	enumeration	0230032	ImplanTec Deutschland GmbH documentation
	enumeration	0230033	Falcon Medical GmbH documentation
			Meril GmbH

	enumeration 0230034 documentation Zimmer Germany GmbH
	enumeration 0230035 documentation Stryker GmbH & Co. KG
	enumeration 0230036 documentation Aesculap AG
	enumeration 0230037 documentation Waldemar Link GmbH & Co. KG
	enumeration 0230038 documentation Corin Germany GmbH
	enumeration 0230039 documentation ARTIQO
	enumeration 0230040 documentation EuromedImplants
	enumeration 0230041 documentation EvolutisGroup
	enumeration 0230042 documentation sonstige
	enumeration 0230043 documentation TEKNIMED SAS
	enumeration 0230044 documentation HiPer Medical AG
	enumeration 0230045 documentation Link Italia S.p.A.
	enumeration 0230046 documentation Johnson & Johnson Medical GmbH
	enumeration 0230047 documentation MatOrtho Limited
	enumeration 0230048 documentation Adler Ortho S.P.A.
	enumeration 0230049 documentation Lincotek Bologna SRL
	enumeration 0230050 documentation Materialise
	enumeration 0230051 documentation Maxx Orthopedics Inc.
	enumeration 0230052 documentation JRI Orthopaedics
	enumeration 0230053 documentation nicht belegter Wert
	enumeration 0230054 documentation nicht belegter Wert
	enumeration 0230055 documentation nicht belegter Wert
	enumeration 0230056 documentation nicht belegter Wert
	enumeration 0230057 documentation nicht belegter Wert
	enumeration 0230058 documentation nicht belegter Wert
	enumeration 0230059 documentation nicht belegter Wert
annotation	documentation Kat_EP_Hersteller
source	<pre> &lt;simpleType name="enum_0230"&gt;   &lt;annotation&gt;     &lt;documentation&gt;Kat_EP_Hersteller&lt;/documentation&gt;   &lt;/annotation&gt;   &lt;restriction base="xs:string"&gt;     &lt;enumeration value="0230001"&gt;       &lt;annotation&gt;         &lt;documentation&gt;Smith &amp; Nephew GmbH&lt;/documentation&gt;       &lt;/annotation&gt;     &lt;/enumeration&gt;   &lt;/restriction&gt; &lt;/simpleType&gt; </pre>

```
<enumeration value="0230002">
  <annotation>
    <documentation>Mathys Orthopädie GmbH</documentation>
  </annotation>
</enumeration>
<enumeration value="0230003">
  <annotation>
    <documentation>Ceramtec AG</documentation>
  </annotation>
</enumeration>
<enumeration value="0230004">
  <annotation>
    <documentation>Biomet</documentation>
  </annotation>
</enumeration>
<enumeration value="0230005">
  <annotation>
    <documentation>Peter Brehm GmbH</documentation>
  </annotation>
</enumeration>
<enumeration value="0230006">
  <annotation>
    <documentation>Amplitude GmbH</documentation>
  </annotation>
</enumeration>
<enumeration value="0230007">
  <annotation>
    <documentation>Exactech Deutschland</documentation>
  </annotation>
</enumeration>
<enumeration value="0230008">
  <annotation>
    <documentation>Globus Medical</documentation>
  </annotation>
</enumeration>
<enumeration value="0230009">
  <annotation>
    <documentation>Implantcast GmbH</documentation>
  </annotation>
</enumeration>
<enumeration value="0230010">
  <annotation>
    <documentation>DePuy Orthopädie GmbH (J&J)</documentation>
  </annotation>
</enumeration>
<enumeration value="0230011">
  <annotation>
    <documentation>IO-International Orthopaedics</documentation>
  </annotation>
</enumeration>
<enumeration value="0230012">
  <annotation>
    <documentation>Joint Replacement Ltd. Instrumentation</documentation>
  </annotation>
</enumeration>
<enumeration value="0230013">
  <annotation>
    <documentation>Merete</documentation>
  </annotation>
</enumeration>
```

```
</enumeration>
<enumeration value="0230014">
  <annotation>
    <documentation>S&amp;G Implants GmbH</documentation>
  </annotation>
</enumeration>
<enumeration value="0230015">
  <annotation>
    <documentation>Speetec Implantate GmbH</documentation>
  </annotation>
</enumeration>
<enumeration value="0230016">
  <annotation>
    <documentation>Stemcup Medical Products GmbH</documentation>
  </annotation>
</enumeration>
<enumeration value="0230017">
  <annotation>
    <documentation>Symbios Deutschland GmbH</documentation>
  </annotation>
</enumeration>
<enumeration value="0230018">
  <annotation>
    <documentation>Tantum AG</documentation>
  </annotation>
</enumeration>
<enumeration value="0230019">
  <annotation>
    <documentation>Tornier GmbH</documentation>
  </annotation>
</enumeration>
<enumeration value="0230020">
  <annotation>
    <documentation>MicroPort Orthopedics GmbH</documentation>
  </annotation>
</enumeration>
<enumeration value="0230021">
  <annotation>
    <documentation>aap Implanate AG</documentation>
  </annotation>
</enumeration>
<enumeration value="0230022">
  <annotation>
    <documentation>AQImplants</documentation>
  </annotation>
</enumeration>
<enumeration value="0230023">
  <annotation>
    <documentation>ESKA Orthodynamics GmbH</documentation>
  </annotation>
</enumeration>
<enumeration value="0230024">
  <annotation>
    <documentation>Atecos medical AG</documentation>
  </annotation>
</enumeration>
<enumeration value="0230025">
  <annotation>
    <documentation>Chiropro GmbH</documentation>
  </annotation>
</enumeration>
```

```
</annotation>
</enumeration>
<enumeration value="0230026">
  <annotation>
    <documentation>Medacta</documentation>
  </annotation>
</enumeration>
<enumeration value="0230027">
  <annotation>
    <documentation>OHST Medizintechnik AG</documentation>
  </annotation>
</enumeration>
<enumeration value="0230028">
  <annotation>
    <documentation>Lima Deutschland GmbH</documentation>
  </annotation>
</enumeration>
<enumeration value="0230029">
  <annotation>
    <documentation>alloPlus GmbH</documentation>
  </annotation>
</enumeration>
<enumeration value="0230030">
  <annotation>
    <documentation>Heraeus Medical GmbH</documentation>
  </annotation>
</enumeration>
<enumeration value="0230031">
  <annotation>
    <documentation>ImplanTec Deutschland GmbH</documentation>
  </annotation>
</enumeration>
<enumeration value="0230032">
  <annotation>
    <documentation>Falcon Medical GmbH</documentation>
  </annotation>
</enumeration>
<enumeration value="0230033">
  <annotation>
    <documentation>Meril GmbH</documentation>
  </annotation>
</enumeration>
<enumeration value="0230034">
  <annotation>
    <documentation>Zimmer Germany GmbH</documentation>
  </annotation>
</enumeration>
<enumeration value="0230035">
  <annotation>
    <documentation>Stryker GmbH & Co. KG</documentation>
  </annotation>
</enumeration>
<enumeration value="0230036">
  <annotation>
    <documentation>Aesculap AG</documentation>
  </annotation>
</enumeration>
<enumeration value="0230037">
  <annotation>
```

```
<documentation>Waldemar Link GmbH & Co. KG</documentation>
</annotation>
</enumeration>
<enumeration value="0230038">
  <annotation>
    <documentation>Corin Germany GmbH</documentation>
  </annotation>
</enumeration>
<enumeration value="0230039">
  <annotation>
    <documentation>ARTIQO</documentation>
  </annotation>
</enumeration>
<enumeration value="0230040">
  <annotation>
    <documentation>EuromedImplants</documentation>
  </annotation>
</enumeration>
<enumeration value="0230041">
  <annotation>
    <documentation>EvolutisGroup</documentation>
  </annotation>
</enumeration>
<enumeration value="0230042">
  <annotation>
    <documentation>sonstige</documentation>
  </annotation>
</enumeration>
<enumeration value="0230043">
  <annotation>
    <documentation>TEKNIMED SAS</documentation>
  </annotation>
</enumeration>
<enumeration value="0230044">
  <annotation>
    <documentation>HiPer Medical AG</documentation>
  </annotation>
</enumeration>
<enumeration value="0230045">
  <annotation>
    <documentation>Link Italia S.p.A.</documentation>
  </annotation>
</enumeration>
<enumeration value="0230046">
  <annotation>
    <documentation>Johnson & Johnson Medical GmbH</documentation>
  </annotation>
</enumeration>
<enumeration value="0230047">
  <annotation>
    <documentation>MatOrtho Limited</documentation>
  </annotation>
</enumeration>
<enumeration value="0230048">
  <annotation>
    <documentation>Adler Ortho S.P.A.</documentation>
  </annotation>
</enumeration>
<enumeration value="0230049">
```

```
<annotation>
  <documentation>Lincotek Bologna SRL</documentation>
</annotation>
</enumeration>
<enumeration value="0230050">
  <annotation>
    <documentation>Materialise</documentation>
  </annotation>
</enumeration>
<enumeration value="0230051">
  <annotation>
    <documentation>Maxx Orthopedics Inc.</documentation>
  </annotation>
</enumeration>
<enumeration value="0230052">
  <annotation>
    <documentation>JRI Orthopaedics</documentation>
  </annotation>
</enumeration>
<enumeration value="0230053">
  <annotation>
    <documentation>nicht belegter Wert</documentation>
  </annotation>
</enumeration>
<enumeration value="0230054">
  <annotation>
    <documentation>nicht belegter Wert</documentation>
  </annotation>
</enumeration>
<enumeration value="0230055">
  <annotation>
    <documentation>nicht belegter Wert</documentation>
  </annotation>
</enumeration>
<enumeration value="0230056">
  <annotation>
    <documentation>nicht belegter Wert</documentation>
  </annotation>
</enumeration>
<enumeration value="0230057">
  <annotation>
    <documentation>nicht belegter Wert</documentation>
  </annotation>
</enumeration>
<enumeration value="0230058">
  <annotation>
    <documentation>nicht belegter Wert</documentation>
  </annotation>
</enumeration>
<enumeration value="0230059">
  <annotation>
    <documentation>nicht belegter Wert</documentation>
  </annotation>
</enumeration>
</restriction>
</simpleType>
```



### simpleType enum\_0252

namespace	http://xml.ir-d.de/stn		
type	restriction of <b>string</b>		
properties	base xs:string		
facets	Kind	Value	Annotation
	enumeration	0252001	documentation Pfanne
	enumeration	0252002	documentation Schaft
	enumeration	0252003	documentation beides
annotation	documentation Kat_EP_KomponenteHuefte		
source	<pre> &lt;simpleType name="enum_0252"&gt;   &lt;annotation&gt;     &lt;documentation&gt;Kat_EP_KomponenteHuefte&lt;/documentation&gt;   &lt;/annotation&gt;   &lt;restriction base="xs:string"&gt;     &lt;enumeration value="0252001"&gt;       &lt;annotation&gt;         &lt;documentation&gt;Pfanne&lt;/documentation&gt;       &lt;/annotation&gt;     &lt;/enumeration&gt;     &lt;enumeration value="0252002"&gt;       &lt;annotation&gt;         &lt;documentation&gt;Schaft&lt;/documentation&gt;       &lt;/annotation&gt;     &lt;/enumeration&gt;     &lt;enumeration value="0252003"&gt;       &lt;annotation&gt;         &lt;documentation&gt;beides&lt;/documentation&gt;       &lt;/annotation&gt;     &lt;/enumeration&gt;   &lt;/restriction&gt; &lt;/simpleType&gt; </pre>		

### simpleType enum\_0254

namespace	http://xml.ir-d.de/stn		
type	restriction of <b>string</b>		
properties	base xs:string		
facets	Kind	Value	Annotation
	enumeration	0254001	documentation Femur
	enumeration	0254002	documentation Tibia
	enumeration	0254003	documentation Patella
	enumeration	0254004	documentation mehrere
annotation	documentation Kat_EP_KomponenteKnie		
source	<pre> &lt;simpleType name="enum_0254"&gt;   &lt;annotation&gt;     &lt;documentation&gt;Kat EP KomponenteKnie&lt;/documentation&gt;   &lt;/annotation&gt; </pre>		

	<pre> &lt;/annotation&gt; &lt;restriction base="xs:string"&gt;   &lt;enumeration value="0254001"&gt;     &lt;annotation&gt;       &lt;documentation&gt;Femur&lt;/documentation&gt;     &lt;/annotation&gt;   &lt;/enumeration&gt;   &lt;enumeration value="0254002"&gt;     &lt;annotation&gt;       &lt;documentation&gt;Tibia&lt;/documentation&gt;     &lt;/annotation&gt;   &lt;/enumeration&gt;   &lt;enumeration value="0254003"&gt;     &lt;annotation&gt;       &lt;documentation&gt;Patella&lt;/documentation&gt;     &lt;/annotation&gt;   &lt;/enumeration&gt;   &lt;enumeration value="0254004"&gt;     &lt;annotation&gt;       &lt;documentation&gt;mehrere&lt;/documentation&gt;     &lt;/annotation&gt;   &lt;/enumeration&gt; &lt;/restriction&gt; &lt;/simpleType&gt; </pre>
--	--

### simpleType enum\_0256

namespace	http://xml.ir-d.de/stn		
type	restriction of <b>string</b>		
properties	base xs:string		
facets	Kind	Value	Annotation
	enumeration	0256001	documentation Pfanne
	enumeration	0256002	documentation Schaft
	enumeration	0256003	documentation Pfanne und Schaft
	enumeration	0256004	documentation Femur
	enumeration	0256005	documentation Tibia
	enumeration	0256006	documentation Patella
	enumeration	0256007	documentation mehrere
annotation	documentation Kat_EP_KomponenteTFE		
source	<pre> &lt;simpleType name="enum_0256"&gt;   &lt;annotation&gt;     &lt;documentation&gt;Kat_EP_KomponenteTFE&lt;/documentation&gt;   &lt;/annotation&gt;   &lt;restriction base="xs:string"&gt;     &lt;enumeration value="0256001"&gt;       &lt;annotation&gt;         &lt;documentation&gt;Pfanne&lt;/documentation&gt;       &lt;/annotation&gt;     &lt;/enumeration&gt; </pre>		

```

<enumeration value="0256002">
  <annotation>
    <documentation>Schaft</documentation>
  </annotation>
</enumeration>
<enumeration value="0256003">
  <annotation>
    <documentation>Pfanne und Schaft</documentation>
  </annotation>
</enumeration>
<enumeration value="0256004">
  <annotation>
    <documentation>Femur</documentation>
  </annotation>
</enumeration>
<enumeration value="0256005">
  <annotation>
    <documentation>Tibia</documentation>
  </annotation>
</enumeration>
<enumeration value="0256006">
  <annotation>
    <documentation>Patella</documentation>
  </annotation>
</enumeration>
<enumeration value="0256007">
  <annotation>
    <documentation>mehrere</documentation>
  </annotation>
</enumeration>
</restriction>
</simpleType>

```

simpleType **enum\_0262**

namespace	http://xml.ir-d.de/stn		
type	restriction of <b>string</b>		
properties	base xs:string		
facets	Kind	Value	Annotation
	enumeration	0262001	documentation Pfanne
	enumeration	0262002	documentation Schaft
	enumeration	0262003	documentation Kopf
	enumeration	0262004	documentation Inlay
	enumeration	0262005	documentation Adapter
	enumeration	0262006	documentation mehrere
annotation	documentation Kat_EP_ImplantatbruchHuefte		
source	<pre> &lt;simpleType name="enum_0262"&gt;   &lt;annotation&gt;     &lt;documentation&gt;Kat_EP_ImplantatbruchHuefte&lt;/documentation&gt;   &lt;/annotation&gt; </pre>		

```

<restriction base="xs:string">
  <enumeration value="0262001">
    <annotation>
      <documentation>Pfanne</documentation>
    </annotation>
  </enumeration>
  <enumeration value="0262002">
    <annotation>
      <documentation>Schaft</documentation>
    </annotation>
  </enumeration>
  <enumeration value="0262003">
    <annotation>
      <documentation>Kopf</documentation>
    </annotation>
  </enumeration>
  <enumeration value="0262004">
    <annotation>
      <documentation>Inlay</documentation>
    </annotation>
  </enumeration>
  <enumeration value="0262005">
    <annotation>
      <documentation>Adapter</documentation>
    </annotation>
  </enumeration>
  <enumeration value="0262006">
    <annotation>
      <documentation>mehrere</documentation>
    </annotation>
  </enumeration>
</restriction>
</simpleType>

```

### simpleType enum\_0264

namespace	http://xml.lir-d.de/stn		
type	restriction of <b>string</b>		
properties	base xs:string		
facets	Kind	Value	Annotation
	enumeration	0264001	documentation Femur
	enumeration	0264002	documentation Tibia
	enumeration	0264003	documentation Inlay
	enumeration	0264004	documentation Adapter
	enumeration	0264005	documentation Verlängerung
	enumeration	0264006	documentation Schrauben
	enumeration	0264007	documentation mehrere
	enumeration	0264042	documentation andere
annotation	documentation Kat_EP_ImplantatbruchKnie		

source	<pre> &lt;simpleType name="enum_0264"&gt;   &lt;annotation&gt;     &lt;documentation&gt;Kat_EP_ImplantatbruchKnie&lt;/documentation&gt;   &lt;/annotation&gt;   &lt;restriction base="xs:string"&gt;     &lt;enumeration value="0264001"&gt;       &lt;annotation&gt;         &lt;documentation&gt;Femur&lt;/documentation&gt;       &lt;/annotation&gt;     &lt;/enumeration&gt;     &lt;enumeration value="0264002"&gt;       &lt;annotation&gt;         &lt;documentation&gt;Tibia&lt;/documentation&gt;       &lt;/annotation&gt;     &lt;/enumeration&gt;     &lt;enumeration value="0264003"&gt;       &lt;annotation&gt;         &lt;documentation&gt;Inlay&lt;/documentation&gt;       &lt;/annotation&gt;     &lt;/enumeration&gt;     &lt;enumeration value="0264004"&gt;       &lt;annotation&gt;         &lt;documentation&gt;Adapter&lt;/documentation&gt;       &lt;/annotation&gt;     &lt;/enumeration&gt;     &lt;enumeration value="0264005"&gt;       &lt;annotation&gt;         &lt;documentation&gt;Verlängerung&lt;/documentation&gt;       &lt;/annotation&gt;     &lt;/enumeration&gt;     &lt;enumeration value="0264006"&gt;       &lt;annotation&gt;         &lt;documentation&gt;Schrauben&lt;/documentation&gt;       &lt;/annotation&gt;     &lt;/enumeration&gt;     &lt;enumeration value="0264007"&gt;       &lt;annotation&gt;         &lt;documentation&gt;mehrere&lt;/documentation&gt;       &lt;/annotation&gt;     &lt;/enumeration&gt;     &lt;enumeration value="0264042"&gt;       &lt;annotation&gt;         &lt;documentation&gt;andere&lt;/documentation&gt;       &lt;/annotation&gt;     &lt;/enumeration&gt;   &lt;/restriction&gt; &lt;/simpleType&gt; </pre>
--------	--

### simpleType enum\_0266

namespace	http://xml.lir-d.de/stn		
type	restriction of <b>string</b>		
properties	base xs:string		
facets	Kind enumeration	Value 0266001	Annotation documentation Pfanne

	enumeration 0266002 documentation Schaft enumeration 0266003 documentation Kopf enumeration 0266004 documentation Inlay enumeration 0266005 documentation Adapter enumeration 0266006 documentation Femur enumeration 0266007 documentation Tibia enumeration 0266008 documentation Verlängerung enumeration 0266009 documentation Schrauben enumeration 0266010 documentation mehrere enumeration 0266042 documentation andere
annotation	documentation Kat_EP_ImplantatbruchTFE
source	<pre> &lt;simpleType name="enum_0266"&gt;   &lt;annotation&gt;     &lt;documentation&gt;Kat_EP_ImplantatbruchTFE&lt;/documentation&gt;   &lt;/annotation&gt;   &lt;restriction base="xs:string"&gt;     &lt;enumeration value="0266001"&gt;       &lt;annotation&gt;         &lt;documentation&gt;Pfanne&lt;/documentation&gt;       &lt;/annotation&gt;     &lt;/enumeration&gt;     &lt;enumeration value="0266002"&gt;       &lt;annotation&gt;         &lt;documentation&gt;Schaft&lt;/documentation&gt;       &lt;/annotation&gt;     &lt;/enumeration&gt;     &lt;enumeration value="0266003"&gt;       &lt;annotation&gt;         &lt;documentation&gt;Kopf&lt;/documentation&gt;       &lt;/annotation&gt;     &lt;/enumeration&gt;     &lt;enumeration value="0266004"&gt;       &lt;annotation&gt;         &lt;documentation&gt;Inlay&lt;/documentation&gt;       &lt;/annotation&gt;     &lt;/enumeration&gt;     &lt;enumeration value="0266005"&gt;       &lt;annotation&gt;         &lt;documentation&gt;Adapter&lt;/documentation&gt;       &lt;/annotation&gt;     &lt;/enumeration&gt;     &lt;enumeration value="0266006"&gt;       &lt;annotation&gt;         &lt;documentation&gt;Femur&lt;/documentation&gt;       &lt;/annotation&gt;     &lt;/enumeration&gt;     &lt;enumeration value="0266007"&gt;       &lt;annotation&gt;         &lt;documentation&gt;Tibia&lt;/documentation&gt;       &lt;/annotation&gt;     &lt;/enumeration&gt;   &lt;/restriction&gt; &lt;/simpleType&gt; </pre>

	<pre> &lt;/enumeration&gt; &lt;enumeration value="0266008"&gt;   &lt;annotation&gt;     &lt;documentation&gt;Verlängerung&lt;/documentation&gt;   &lt;/annotation&gt; &lt;/enumeration&gt; &lt;enumeration value="0266009"&gt;   &lt;annotation&gt;     &lt;documentation&gt;Schrauben&lt;/documentation&gt;   &lt;/annotation&gt; &lt;/enumeration&gt; &lt;enumeration value="0266010"&gt;   &lt;annotation&gt;     &lt;documentation&gt;mehrere&lt;/documentation&gt;   &lt;/annotation&gt; &lt;/enumeration&gt; &lt;enumeration value="0266042"&gt;   &lt;annotation&gt;     &lt;documentation&gt;andere&lt;/documentation&gt;   &lt;/annotation&gt; &lt;/enumeration&gt; &lt;/restriction&gt; &lt;/simpleType&gt; </pre>
--	--

### simpleType enum\_0270

namespace	http://xml.ir-d.de/stn		
type	restriction of <b>string</b>		
properties	base xs:string		
facets	Kind	Value	Annotation
	enumeration	0270001	documentation PE-Inlay
	enumeration	0270002	documentation patellare Komponente
	enumeration	0270003	documentation beides
annotation	documentation Kat EP VerschleissKnie		
source	<pre> &lt;simpleType name="enum_0270"&gt;   &lt;annotation&gt;     &lt;documentation&gt;Kat_EP_VerschleissKnie&lt;/documentation&gt;   &lt;/annotation&gt;   &lt;restriction base="xs:string"&gt;     &lt;enumeration value="0270001"&gt;       &lt;annotation&gt;         &lt;documentation&gt;PE-Inlay&lt;/documentation&gt;       &lt;/annotation&gt;     &lt;/enumeration&gt;     &lt;enumeration value="0270002"&gt;       &lt;annotation&gt;         &lt;documentation&gt;patellare Komponente&lt;/documentation&gt;       &lt;/annotation&gt;     &lt;/enumeration&gt;     &lt;enumeration value="0270003"&gt;       &lt;annotation&gt;         &lt;documentation&gt;beides&lt;/documentation&gt;       &lt;/annotation&gt;     &lt;/enumeration&gt;   &lt;/restriction&gt; &lt;/simpleType&gt; </pre>		

	<pre> &lt;/enumeration&gt; &lt;/restriction&gt; &lt;/simpleType&gt; </pre>
--	--

### simpleType enum\_0271

namespace	http://xml.ir-d.de/stn		
type	restriction of <b>string</b>		
properties	base xs:string		
facets	Kind	Value	Annotation
	enumeration	0271001	documentation Schraube
	enumeration	0271002	documentation Inlay
	enumeration	0271003	documentation patellare Komponente
	enumeration	0271004	documentation Kopplung
	enumeration	0271005	documentation mehrere
	enumeration	0271042	documentation andere
annotation	documentation Kat_EP_MigrationKnie		
source	<pre> &lt;simpleType name="enum_0271"&gt;   &lt;annotation&gt;     &lt;documentation&gt;Kat_EP_MigrationKnie&lt;/documentation&gt;   &lt;/annotation&gt;   &lt;restriction base="xs:string"&gt;     &lt;enumeration value="0271001"&gt;       &lt;annotation&gt;         &lt;documentation&gt;Schraube&lt;/documentation&gt;       &lt;/annotation&gt;     &lt;/enumeration&gt;     &lt;enumeration value="0271002"&gt;       &lt;annotation&gt;         &lt;documentation&gt;Inlay&lt;/documentation&gt;       &lt;/annotation&gt;     &lt;/enumeration&gt;     &lt;enumeration value="0271003"&gt;       &lt;annotation&gt;         &lt;documentation&gt;patellare Komponente&lt;/documentation&gt;       &lt;/annotation&gt;     &lt;/enumeration&gt;     &lt;enumeration value="0271004"&gt;       &lt;annotation&gt;         &lt;documentation&gt;Kopplung&lt;/documentation&gt;       &lt;/annotation&gt;     &lt;/enumeration&gt;     &lt;enumeration value="0271005"&gt;       &lt;annotation&gt;         &lt;documentation&gt;mehrere&lt;/documentation&gt;       &lt;/annotation&gt;     &lt;/enumeration&gt;     &lt;enumeration value="0271042"&gt;       &lt;annotation&gt;         &lt;documentation&gt;andere&lt;/documentation&gt;       &lt;/annotation&gt;     &lt;/enumeration&gt;   &lt;/restriction&gt; &lt;/simpleType&gt; </pre>		



```

</annotation>
</enumeration>
</restriction>
</simpleType>

```

### simpleType enum\_0290

namespace	http://xml.ir-d.de/stn		
type	restriction of <b>string</b>		
properties	base xs:string		
facets	Kind	Value	Annotation
	enumeration	0290001	documentation Hüft-Komponente
	enumeration	0290002	documentation Knie-Komponente
	enumeration	0290003	documentation Modulare Komponente (Hüfte/Knie)
annotation	documentation Kat_EP_Artikeltyp		
source	<pre> &lt;simpleType name="enum_0290"&gt;   &lt;annotation&gt;     &lt;documentation&gt;Kat_EP_Artikeltyp&lt;/documentation&gt;   &lt;/annotation&gt;   &lt;restriction base="xs:string"&gt;     &lt;enumeration value="0290001"&gt;       &lt;annotation&gt;         &lt;documentation&gt;Hüft-Komponente&lt;/documentation&gt;       &lt;/annotation&gt;     &lt;/enumeration&gt;     &lt;enumeration value="0290002"&gt;       &lt;annotation&gt;         &lt;documentation&gt;Knie-Komponente&lt;/documentation&gt;       &lt;/annotation&gt;     &lt;/enumeration&gt;     &lt;enumeration value="0290003"&gt;       &lt;annotation&gt;         &lt;documentation&gt;Modulare Komponente (Hüfte/Knie)&lt;/documentation&gt;       &lt;/annotation&gt;     &lt;/enumeration&gt;   &lt;/restriction&gt; &lt;/simpleType&gt; </pre>		

### simpleType enum\_0291

namespace	http://xml.ir-d.de/stn		
type	restriction of <b>string</b>		
properties	base xs:string		
facets	Kind	Value	Annotation
	enumeration	0291001	documentation Knochen-Zement
	enumeration	0291002	documentation sonstiges Zubehör
annotation	documentation Kat_EP_ZubehoerTyp		

source	<pre> &lt;simpleType name="enum_0291"&gt;   &lt;annotation&gt;     &lt;documentation&gt;Kat_EP_ZubehoerTyp&lt;/documentation&gt;   &lt;/annotation&gt;   &lt;restriction base="xs:string"&gt;     &lt;enumeration value="0291001"&gt;       &lt;annotation&gt;         &lt;documentation&gt;Knochen-Zement&lt;/documentation&gt;       &lt;/annotation&gt;     &lt;/enumeration&gt;     &lt;enumeration value="0291002"&gt;       &lt;annotation&gt;         &lt;documentation&gt;sonstiges Zubehör&lt;/documentation&gt;       &lt;/annotation&gt;     &lt;/enumeration&gt;   &lt;/restriction&gt; &lt;/simpleType&gt; </pre>
--------	--

### simpleType enum\_0300

namespace	http://xml.ir-d.de/stn		
type	restriction of <b>string</b>		
properties	base xs:string		
facets	Kind	Value	Annotation
	enumeration	0300001	documentation konventioneller Aortenklappenersatz
	enumeration	0300002	documentation kathetergestützte Aortenklappenimplantation (TAVI)
annotation	documentation Kat AK ArtEingriff		
source	<pre> &lt;simpleType name="enum_0300"&gt;   &lt;annotation&gt;     &lt;documentation&gt;Kat_AK_ArtEingriff&lt;/documentation&gt;   &lt;/annotation&gt;   &lt;restriction base="xs:string"&gt;     &lt;enumeration value="0300001"&gt;       &lt;annotation&gt;         &lt;documentation&gt;konventioneller Aortenklappenersatz&lt;/documentation&gt;       &lt;/annotation&gt;     &lt;/enumeration&gt;     &lt;enumeration value="0300002"&gt;       &lt;annotation&gt;         &lt;documentation&gt;kathetergestützte Aortenklappenimplantation (TAVI)&lt;/documentation&gt;       &lt;/annotation&gt;     &lt;/enumeration&gt;   &lt;/restriction&gt; &lt;/simpleType&gt; </pre>		

### simpleType enum\_0302

namespace	http://xml.ir-d.de/stn		
type	restriction of <b>string</b>		
properties	base xs:string		

facets	<table border="1"> <thead> <tr> <th>Kind</th> <th>Value</th> <th>Annotation</th> </tr> </thead> <tbody> <tr> <td>enumeration</td> <td>0302001</td> <td>documentation Stenose</td> </tr> <tr> <td>enumeration</td> <td>0302002</td> <td>documentation Insuffizienz</td> </tr> <tr> <td>enumeration</td> <td>0302003</td> <td>documentation Stenose und Insuffizienz</td> </tr> </tbody> </table>	Kind	Value	Annotation	enumeration	0302001	documentation Stenose	enumeration	0302002	documentation Insuffizienz	enumeration	0302003	documentation Stenose und Insuffizienz
Kind	Value	Annotation											
enumeration	0302001	documentation Stenose											
enumeration	0302002	documentation Insuffizienz											
enumeration	0302003	documentation Stenose und Insuffizienz											
annotation	documentation Kat_AK_GrundEingriff												
source	<pre> &lt;simpleType name="enum_0302"&gt;   &lt;annotation&gt;     &lt;documentation&gt;Kat_AK_GrundEingriff&lt;/documentation&gt;   &lt;/annotation&gt;   &lt;restriction base="xs:string"&gt;     &lt;enumeration value="0302001"&gt;       &lt;annotation&gt;         &lt;documentation&gt;Stenose&lt;/documentation&gt;       &lt;/annotation&gt;     &lt;/enumeration&gt;     &lt;enumeration value="0302002"&gt;       &lt;annotation&gt;         &lt;documentation&gt;Insuffizienz&lt;/documentation&gt;       &lt;/annotation&gt;     &lt;/enumeration&gt;     &lt;enumeration value="0302003"&gt;       &lt;annotation&gt;         &lt;documentation&gt;Stenose und Insuffizienz&lt;/documentation&gt;       &lt;/annotation&gt;     &lt;/enumeration&gt;   &lt;/restriction&gt; &lt;/simpleType&gt; </pre>												

### simpleType enum\_0318

namespace	http://xml.ir-d.de/stn																		
type	restriction of <b>string</b>																		
properties	base xs:string																		
facets	<table border="1"> <thead> <tr> <th>Kind</th> <th>Value</th> <th>Annotation</th> </tr> </thead> <tbody> <tr> <td>enumeration</td> <td>0318001</td> <td>documentation transapikal</td> </tr> <tr> <td>enumeration</td> <td>0318002</td> <td>documentation transaortal</td> </tr> <tr> <td>enumeration</td> <td>0318003</td> <td>documentation transfemoral</td> </tr> <tr> <td>enumeration</td> <td>0318004</td> <td>documentation transaxillär</td> </tr> <tr> <td>enumeration</td> <td>0318042</td> <td>documentation anderer Zugangsweg</td> </tr> </tbody> </table>	Kind	Value	Annotation	enumeration	0318001	documentation transapikal	enumeration	0318002	documentation transaortal	enumeration	0318003	documentation transfemoral	enumeration	0318004	documentation transaxillär	enumeration	0318042	documentation anderer Zugangsweg
Kind	Value	Annotation																	
enumeration	0318001	documentation transapikal																	
enumeration	0318002	documentation transaortal																	
enumeration	0318003	documentation transfemoral																	
enumeration	0318004	documentation transaxillär																	
enumeration	0318042	documentation anderer Zugangsweg																	
annotation	documentation Kat_AK_ZugangKatheter																		
source	<pre> &lt;simpleType name="enum_0318"&gt;   &lt;annotation&gt;     &lt;documentation&gt;Kat_AK_ZugangKatheter&lt;/documentation&gt;   &lt;/annotation&gt;   &lt;restriction base="xs:string"&gt;     &lt;enumeration value="0318001"&gt;       &lt;annotation&gt;         &lt;documentation&gt;transapikal&lt;/documentation&gt;       &lt;/annotation&gt;     &lt;/enumeration&gt;   &lt;/restriction&gt; &lt;/simpleType&gt; </pre>																		

	<pre> &lt;/annotation&gt; &lt;/enumeration&gt; &lt;enumeration value="0318002"&gt;   &lt;annotation&gt;     &lt;documentation&gt;transaortal&lt;/documentation&gt;   &lt;/annotation&gt; &lt;/enumeration&gt; &lt;enumeration value="0318003"&gt;   &lt;annotation&gt;     &lt;documentation&gt;transfemoral&lt;/documentation&gt;   &lt;/annotation&gt; &lt;/enumeration&gt; &lt;enumeration value="0318004"&gt;   &lt;annotation&gt;     &lt;documentation&gt;transaxillär&lt;/documentation&gt;   &lt;/annotation&gt; &lt;/enumeration&gt; &lt;enumeration value="0318042"&gt;   &lt;annotation&gt;     &lt;documentation&gt;anderer Zugangsweg&lt;/documentation&gt;   &lt;/annotation&gt; &lt;/enumeration&gt; &lt;/restriction&gt; &lt;/simpleType&gt; </pre>
--	---

### simpleType enum\_0320

namespace	http://xml.ir-d.de/stn		
type	restriction of <b>string</b>		
properties	base xs:string		
facets	Kind	Value	Annotation
	enumeration	0320001	documentation konventionelle Sternotomie
	enumeration	0320002	documentation partielle Sternotomie
	enumeration	0320003	documentation parastemaler Zugang
	enumeration	0320042	documentation anderer Zugangsweg
annotation	documentation Kat_AK_ZugangKonventionell		
source	<pre> &lt;simpleType name="enum_0320"&gt;   &lt;annotation&gt;     &lt;documentation&gt;Kat_AK_ZugangKonventionell&lt;/documentation&gt;   &lt;/annotation&gt;   &lt;restriction base="xs:string"&gt;     &lt;enumeration value="0320001"&gt;       &lt;annotation&gt;         &lt;documentation&gt;konventionelle Sternotomie&lt;/documentation&gt;       &lt;/annotation&gt;     &lt;/enumeration&gt;     &lt;enumeration value="0320002"&gt;       &lt;annotation&gt;         &lt;documentation&gt;partielle Sternotomie&lt;/documentation&gt;       &lt;/annotation&gt;     &lt;/enumeration&gt;     &lt;enumeration value="0320003"&gt; </pre>		

	<pre> &lt;annotation&gt;   &lt;documentation&gt;parasternaler Zugang&lt;/documentation&gt; &lt;/annotation&gt; &lt;/enumeration&gt; &lt;enumeration value="0320042"&gt;   &lt;annotation&gt;     &lt;documentation&gt;anderer Zugangsweg&lt;/documentation&gt;   &lt;/annotation&gt; &lt;/enumeration&gt; &lt;/restriction&gt; &lt;/simpleType&gt; </pre>
--	---

### simpleType enum\_0322

namespace	http://xml.ir-d.de/stn		
type	restriction of <b>string</b>		
properties	base xs:string		
facets	Kind	Value	Annotation
	enumeration	0322001	documentation nein
	enumeration	0322002	documentation ja, diätetisch behandelt
	enumeration	0322003	documentation ja, orale Medikation
	enumeration	0322004	documentation ja, mit Insulin behandelt
	enumeration	0322005	documentation ja, unbehandelt
	enumeration	0322099	documentation unbekannt
annotation	documentation Kat_AK_Diabetes		
source	<pre> &lt;simpleType name="enum_0322"&gt;   &lt;annotation&gt;     &lt;documentation&gt;Kat_AK_Diabetes&lt;/documentation&gt;   &lt;/annotation&gt;   &lt;restriction base="xs:string"&gt;     &lt;enumeration value="0322001"&gt;       &lt;annotation&gt;         &lt;documentation&gt;nein&lt;/documentation&gt;       &lt;/annotation&gt;     &lt;/enumeration&gt;     &lt;enumeration value="0322002"&gt;       &lt;annotation&gt;         &lt;documentation&gt;ja, diätetisch behandelt&lt;/documentation&gt;       &lt;/annotation&gt;     &lt;/enumeration&gt;     &lt;enumeration value="0322003"&gt;       &lt;annotation&gt;         &lt;documentation&gt;ja, orale Medikation&lt;/documentation&gt;       &lt;/annotation&gt;     &lt;/enumeration&gt;     &lt;enumeration value="0322004"&gt;       &lt;annotation&gt;         &lt;documentation&gt;ja, mit Insulin behandelt&lt;/documentation&gt;       &lt;/annotation&gt;     &lt;/enumeration&gt;   &lt;/restriction&gt; &lt;/simpleType&gt; </pre>		

	<pre> &lt;enumeration value="0322005"&gt;   &lt;annotation&gt;     &lt;documentation&gt;ja, unbehandelt&lt;/documentation&gt;   &lt;/annotation&gt; &lt;/enumeration&gt; &lt;enumeration value="0322099"&gt;   &lt;annotation&gt;     &lt;documentation&gt;unbekannt&lt;/documentation&gt;   &lt;/annotation&gt; &lt;/enumeration&gt; &lt;/restriction&gt; &lt;/simpleType&gt; </pre>
--	---

### simpleType enum\_0324

namespace	http://xml.ir-d.de/stn		
type	restriction of <b>string</b>		
properties	base xs:string		
facets	Kind	Value	Annotation
	enumeration	0324001	documentation (I): Beschwerdefreiheit, normale körperliche Belastbarkeit
	enumeration	0324002	documentation (II): Beschwerden bei stärkerer körperlicher Belastung
	enumeration	0324003	documentation (III): Beschwerden bei leichter körperlicher Belastung
	enumeration	0324004	documentation (IV): Beschwerden in Ruhe
annotation	documentation Kat_AK_NYHA		
source	<pre> &lt;simpleType name="enum_0324"&gt;   &lt;annotation&gt;     &lt;documentation&gt;Kat_AK_NYHA&lt;/documentation&gt;   &lt;/annotation&gt;   &lt;restriction base="xs:string"&gt;     &lt;enumeration value="0324001"&gt;       &lt;annotation&gt;         &lt;documentation&gt;(I): Beschwerdefreiheit, normale körperliche Belastbarkeit&lt;/documentation&gt;       &lt;/annotation&gt;     &lt;/enumeration&gt;     &lt;enumeration value="0324002"&gt;       &lt;annotation&gt;         &lt;documentation&gt;(II): Beschwerden bei stärkerer körperlicher Belastung&lt;/documentation&gt;       &lt;/annotation&gt;     &lt;/enumeration&gt;     &lt;enumeration value="0324003"&gt;       &lt;annotation&gt;         &lt;documentation&gt;(III): Beschwerden bei leichter körperlicher Belastung&lt;/documentation&gt;       &lt;/annotation&gt;     &lt;/enumeration&gt;     &lt;enumeration value="0324004"&gt;       &lt;annotation&gt;         &lt;documentation&gt;(IV): Beschwerden in Ruhe&lt;/documentation&gt;       &lt;/annotation&gt;     &lt;/enumeration&gt;   &lt;/restriction&gt; &lt;/simpleType&gt; </pre>		

```

</restriction>
</simpleType>

```

### simpleType enum\_0330

namespace	http://xml.ir-d.de/stn		
type	restriction of <b>string</b>		
properties	base xs:string		
facets	Kind	Value	Annotation
	enumeration	0330001	documentation ATS Medical
	enumeration	0330002	documentation Edwards Lifesciences
	enumeration	0330003	documentation Medtronic
	enumeration	0330004	documentation JenaValve
	enumeration	0330005	documentation Corcym
	enumeration	0330006	documentation Abbott Medical / St. Jude
	enumeration	0330007	documentation Symetis
	enumeration	0330008	documentation Direct Flow Medical
	enumeration	0330009	documentation Boston Scientific
	enumeration	0330010	documentation Artivion
	enumeration	0330011	documentation Biosensors
	enumeration	0330012	documentation LivaNova
	enumeration	0330013	documentation Meril
	enumeration	0330014	documentation Sahajanand Medical Technologies
	enumeration	0330015	documentation nicht belegter Wert
	enumeration	0330016	documentation nicht belegter Wert
	enumeration	0330017	documentation nicht belegter Wert
	enumeration	0330018	documentation nicht belegter Wert
	enumeration	0330042	documentation sonstiger Hersteller
annotation	documentation Kat AK Hersteller		
source	<pre> &lt;simpleType name="enum_0330"&gt;   &lt;annotation&gt;     &lt;documentation&gt;Kat_AK_Hersteller&lt;/documentation&gt;   &lt;/annotation&gt;   &lt;restriction base="xs:string"&gt;     &lt;enumeration value="0330001"&gt;       &lt;annotation&gt;         &lt;documentation&gt;ATS Medical&lt;/documentation&gt;       &lt;/annotation&gt;     &lt;/enumeration&gt;     &lt;enumeration value="0330002"&gt; </pre>		

```
<annotation>
  <documentation>Edwards Lifesciences</documentation>
</annotation>
</enumeration>
<enumeration value="0330003">
  <annotation>
    <documentation>Medtronic</documentation>
  </annotation>
</enumeration>
<enumeration value="0330004">
  <annotation>
    <documentation>JenaValve</documentation>
  </annotation>
</enumeration>
<enumeration value="0330005">
  <annotation>
    <documentation>Corcym</documentation>
  </annotation>
</enumeration>
<enumeration value="0330006">
  <annotation>
    <documentation>Abbott Medical / St. Jude</documentation>
  </annotation>
</enumeration>
<enumeration value="0330007">
  <annotation>
    <documentation>Symetis</documentation>
  </annotation>
</enumeration>
<enumeration value="0330008">
  <annotation>
    <documentation>Direct Flow Medical</documentation>
  </annotation>
</enumeration>
<enumeration value="0330009">
  <annotation>
    <documentation>Boston Scientific</documentation>
  </annotation>
</enumeration>
<enumeration value="0330010">
  <annotation>
    <documentation>Artivion</documentation>
  </annotation>
</enumeration>
<enumeration value="0330011">
  <annotation>
    <documentation>Biosensors</documentation>
  </annotation>
</enumeration>
<enumeration value="0330012">
  <annotation>
    <documentation>LivaNova</documentation>
  </annotation>
</enumeration>
<enumeration value="0330013">
  <annotation>
    <documentation>Meril</documentation>
  </annotation>
</enumeration>
```



	<pre> &lt;enumeration value="0330014"&gt;   &lt;annotation&gt;     &lt;documentation&gt;Sahajanand Medical Technologies&lt;/documentation&gt;   &lt;/annotation&gt; &lt;/enumeration&gt; &lt;enumeration value="0330015"&gt;   &lt;annotation&gt;     &lt;documentation&gt;nicht belegter Wert&lt;/documentation&gt;   &lt;/annotation&gt; &lt;/enumeration&gt; &lt;enumeration value="0330016"&gt;   &lt;annotation&gt;     &lt;documentation&gt;nicht belegter Wert&lt;/documentation&gt;   &lt;/annotation&gt; &lt;/enumeration&gt; &lt;enumeration value="0330017"&gt;   &lt;annotation&gt;     &lt;documentation&gt;nicht belegter Wert&lt;/documentation&gt;   &lt;/annotation&gt; &lt;/enumeration&gt; &lt;enumeration value="0330018"&gt;   &lt;annotation&gt;     &lt;documentation&gt;nicht belegter Wert&lt;/documentation&gt;   &lt;/annotation&gt; &lt;/enumeration&gt; &lt;enumeration value="0330042"&gt;   &lt;annotation&gt;     &lt;documentation&gt;sonstiger Hersteller&lt;/documentation&gt;   &lt;/annotation&gt; &lt;/enumeration&gt; &lt;/restriction&gt; &lt;/simpleType&gt; </pre>
--	--

### simpleType enum\_0338

namespace	http://xml.ir-d.de/stn		
type	restriction of <b>string</b>		
properties	base xs:string		
facets	Kind	Value	Annotation
	enumeration	0338001	documentation LAD
	enumeration	0338002	documentation RCA
	enumeration	0338003	documentation RCX
	enumeration	0338004	documentation Hauptstamm
annotation	documentation Kat_AK_PCIArterien		
source	<pre> &lt;simpleType name="enum_0338"&gt;   &lt;annotation&gt;     &lt;documentation&gt;Kat_AK_PCIArterien&lt;/documentation&gt;   &lt;/annotation&gt;   &lt;restriction base="xs:string"&gt;     &lt;enumeration value="0338001"&gt;       &lt;annotation&gt;         &lt;documentation&gt;LAD&lt;/documentation&gt; </pre>		

	<pre> &lt;/annotation&gt; &lt;/enumeration&gt; &lt;enumeration value="0338002"&gt;   &lt;annotation&gt;     &lt;documentation&gt;RCA&lt;/documentation&gt;   &lt;/annotation&gt; &lt;/enumeration&gt; &lt;enumeration value="0338003"&gt;   &lt;annotation&gt;     &lt;documentation&gt;RCX&lt;/documentation&gt;   &lt;/annotation&gt; &lt;/enumeration&gt; &lt;enumeration value="0338004"&gt;   &lt;annotation&gt;     &lt;documentation&gt;Hauptstamm&lt;/documentation&gt;   &lt;/annotation&gt; &lt;/enumeration&gt; &lt;/restriction&gt; &lt;/simpleType&gt; </pre>
--	--

### simpleType enum 0339

namespace	http://xml.ir-d.de/stn		
type	restriction of <b>string</b>		
properties	base xs:string		
facets	Kind	Value	Annotation
	enumeration	0339001	documentation TEE
	enumeration	0339002	documentation CT
	enumeration	0339042	documentation andere
annotation	documentation Kat_AK_AnnulusMessmethode		
source	<pre> &lt;simpleType name="enum_0339"&gt;   &lt;annotation&gt;     &lt;documentation&gt;Kat_AK_AnnulusMessmethode&lt;/documentation&gt;   &lt;/annotation&gt;   &lt;restriction base="xs:string"&gt;     &lt;enumeration value="0339001"&gt;       &lt;annotation&gt;         &lt;documentation&gt;TEE&lt;/documentation&gt;       &lt;/annotation&gt;     &lt;/enumeration&gt;     &lt;enumeration value="0339002"&gt;       &lt;annotation&gt;         &lt;documentation&gt;CT&lt;/documentation&gt;       &lt;/annotation&gt;     &lt;/enumeration&gt;     &lt;enumeration value="0339042"&gt;       &lt;annotation&gt;         &lt;documentation&gt;andere&lt;/documentation&gt;       &lt;/annotation&gt;     &lt;/enumeration&gt;   &lt;/restriction&gt; &lt;/simpleType&gt; </pre>		

### simpleType enum 0341

namespace	http://xml.ir-d.de/stn		
type	restriction of <b>string</b>		
properties	base xs:string		
facets	Kind	Value	Annotation
	enumeration	0341001	documentation intraprozedural verstorben
	enumeration	0341002	documentation Implantation von mehr als einer Prothese
	enumeration	0341003	documentation gravierende Gefäß- oder Zugangskomplikation (gemäß VARC-3)
	enumeration	0341004	documentation erforderlicher chirurgischer oder interventioneller Eingriff wegen einer Klappenfehlfunktion (gemäß VARC-3)
	enumeration	0341005	documentation &gt;= große strukturelle kardiale Komplikation (gemäß VARC-3)
annotation	documentation Kat_AK_FailureGrund		
source	<pre> &lt;simpleType name="enum_0341"&gt;   &lt;annotation&gt;     &lt;documentation&gt;Kat_AK_FailureGrund&lt;/documentation&gt;   &lt;/annotation&gt;   &lt;restriction base="xs:string"&gt;     &lt;enumeration value="0341001"&gt;       &lt;annotation&gt;         &lt;documentation&gt;intraprozedural verstorben&lt;/documentation&gt;       &lt;/annotation&gt;     &lt;/enumeration&gt;     &lt;enumeration value="0341002"&gt;       &lt;annotation&gt;         &lt;documentation&gt;Implantation von mehr als einer Prothese&lt;/documentation&gt;       &lt;/annotation&gt;     &lt;/enumeration&gt;     &lt;enumeration value="0341003"&gt;       &lt;annotation&gt;         &lt;documentation&gt;gravierende Gefäß- oder Zugangskomplikation (gemäß VARC-3)&lt;/documentation&gt;       &lt;/annotation&gt;     &lt;/enumeration&gt;     &lt;enumeration value="0341004"&gt;       &lt;annotation&gt;         &lt;documentation&gt;erforderlicher chirurgischer oder interventioneller Eingriff wegen einer Klappenfehlfunktion (gemäß VARC-3)&lt;/documentation&gt;       &lt;/annotation&gt;     &lt;/enumeration&gt;     &lt;enumeration value="0341005"&gt;       &lt;annotation&gt;         &lt;documentation&gt;&amp;gt;= große strukturelle kardiale Komplikation (gemäß VARC-3)&lt;/documentation&gt;       &lt;/annotation&gt;     &lt;/enumeration&gt;   &lt;/restriction&gt; &lt;/simpleType&gt; </pre>		

### simpleType enum\_0342

namespace	http://xml.ir-d.de/stn		
type	restriction of <b>string</b>		
properties	base xs:string		
facets	Kind	Value	Annotation
	enumeration	0342001	documentation Alter
	enumeration	0342002	documentation Frailty
	enumeration	0342003	documentation Hochrisiko
	enumeration	0342004	documentation Prognose-limitierende Zweiterkrankung
	enumeration	0342005	documentation Porzellan-Aorta
	enumeration	0342042	documentation Sonstige
annotation	documentation Kat_AK_Tavi		
source	<pre> &lt;simpleType name="enum_0342"&gt;   &lt;annotation&gt;     &lt;documentation&gt;Kat_AK_Tavi&lt;/documentation&gt;   &lt;/annotation&gt;   &lt;restriction base="xs:string"&gt;     &lt;enumeration value="0342001"&gt;       &lt;annotation&gt;         &lt;documentation&gt;Alter&lt;/documentation&gt;       &lt;/annotation&gt;     &lt;/enumeration&gt;     &lt;enumeration value="0342002"&gt;       &lt;annotation&gt;         &lt;documentation&gt;Frailty&lt;/documentation&gt;       &lt;/annotation&gt;     &lt;/enumeration&gt;     &lt;enumeration value="0342003"&gt;       &lt;annotation&gt;         &lt;documentation&gt;Hochrisiko&lt;/documentation&gt;       &lt;/annotation&gt;     &lt;/enumeration&gt;     &lt;enumeration value="0342004"&gt;       &lt;annotation&gt;         &lt;documentation&gt;Prognose-limitierende Zweiterkrankung&lt;/documentation&gt;       &lt;/annotation&gt;     &lt;/enumeration&gt;     &lt;enumeration value="0342005"&gt;       &lt;annotation&gt;         &lt;documentation&gt;Porzellan-Aorta&lt;/documentation&gt;       &lt;/annotation&gt;     &lt;/enumeration&gt;     &lt;enumeration value="0342042"&gt;       &lt;annotation&gt;         &lt;documentation&gt;Sonstige&lt;/documentation&gt;       &lt;/annotation&gt;     &lt;/enumeration&gt;   &lt;/restriction&gt; &lt;/simpleType&gt; </pre>		

### simpleType enum\_0343

namespace	http://xml.ir-d.de/stn		
type	restriction of <b>string</b>		
properties	base xs:string		
facets	Kind	Value	Annotation
	enumeration	0343001	documentation Device-Fehlpositionierung
	enumeration	0343002	documentation Koronarostienverschluss
	enumeration	0343003	documentation Aortendissektion
	enumeration	0343004	documentation Aortenregurgitation &gt; = 2. Grades
	enumeration	0343005	documentation Annulus-Ruptur
	enumeration	0343006	documentation Ruptur-/Perforation einer Herzhöhle ohne Therapiebedarf
	enumeration	0343007	documentation Ruptur-/Perforation einer Herzhöhle mit Therapiebedarf
	enumeration	0343008	documentation Perikardtamponade
	enumeration	0343009	documentation kardiale Dekompensation
	enumeration	0343010	documentation Himembolie
	enumeration	0343011	documentation Rhythmusstörungen
	enumeration	0343012	documentation Device-Embolisation
	enumeration	0343013	documentation vaskuläre Komplikation
	enumeration	0343014	documentation Low Cardiac Output
	enumeration	0343015	documentation schwerwiegende Blutungen (intraprozedural)
	enumeration	0343016	documentation lebensbedrohliche Blutungen (intraprozedural)
	enumeration	0343017	documentation Patient verstarb im OP/Katheterlabor
	enumeration	0343042	documentation sonstige intraprozedurale Komplikationen
annotation	documentation Kat_AK_KomplikationTyp		
source	<pre> &lt;simpleType name="enum_0343"&gt;   &lt;annotation&gt;     &lt;documentation&gt;Kat_AK_KomplikationTyp&lt;/documentation&gt;   &lt;/annotation&gt;   &lt;restriction base="xs:string"&gt;     &lt;enumeration value="0343001"&gt;       &lt;annotation&gt;         &lt;documentation&gt;Device-Fehlpositionierung&lt;/documentation&gt;       &lt;/annotation&gt;     &lt;/enumeration&gt;     &lt;enumeration value="0343002"&gt;       &lt;annotation&gt;         &lt;documentation&gt;Koronarostienverschluss&lt;/documentation&gt;       &lt;/annotation&gt;     &lt;/enumeration&gt;     &lt;enumeration value="0343003"&gt; </pre>		

```

    <annotation>
      <documentation>Aortendissektion</documentation>
    </annotation>
  </enumeration>
  <enumeration value="0343004">
    <annotation>
      <documentation>Aortenregurgitation &gt; = 2. Grades</documentation>
    </annotation>
  </enumeration>
  <enumeration value="0343005">
    <annotation>
      <documentation>Annulus-Ruptur</documentation>
    </annotation>
  </enumeration>
  <enumeration value="0343006">
    <annotation>
      <documentation>Ruptur-/Perforation einer Herzhöhle ohne
Therapiebedarf</documentation>
    </annotation>
  </enumeration>
  <enumeration value="0343007">
    <annotation>
      <documentation>Ruptur-/Perforation einer Herzhöhle mit
Therapiebedarf</documentation>
    </annotation>
  </enumeration>
  <enumeration value="0343008">
    <annotation>
      <documentation>Perikardtamponade</documentation>
    </annotation>
  </enumeration>
  <enumeration value="0343009">
    <annotation>
      <documentation>kardiale Dekompensation</documentation>
    </annotation>
  </enumeration>
  <enumeration value="0343010">
    <annotation>
      <documentation>Hirnembolie</documentation>
    </annotation>
  </enumeration>
  <enumeration value="0343011">
    <annotation>
      <documentation>Rhythmusstörungen</documentation>
    </annotation>
  </enumeration>
  <enumeration value="0343012">
    <annotation>
      <documentation>Device-Embolisation</documentation>
    </annotation>
  </enumeration>
  <enumeration value="0343013">
    <annotation>
      <documentation>vaskuläre Komplikation</documentation>
    </annotation>
  </enumeration>
  <enumeration value="0343014">
    <annotation>
      <documentation>Low Cardiac Output</documentation>
    </annotation>
  </enumeration>

```

	<pre> &lt;/annotation&gt; &lt;/enumeration&gt; &lt;enumeration value="0343015"&gt;   &lt;annotation&gt;     &lt;documentation&gt;schwerwiegende Blutungen (intraprozedural)&lt;/documentation&gt;   &lt;/annotation&gt; &lt;/enumeration&gt; &lt;enumeration value="0343016"&gt;   &lt;annotation&gt;     &lt;documentation&gt;lebensbedrohliche Blutungen (intraprozedural)&lt;/documentation&gt;   &lt;/annotation&gt; &lt;/enumeration&gt; &lt;enumeration value="0343017"&gt;   &lt;annotation&gt;     &lt;documentation&gt;Patient verstarb im OP/Katheterlabor&lt;/documentation&gt;   &lt;/annotation&gt; &lt;/enumeration&gt; &lt;enumeration value="0343042"&gt;   &lt;annotation&gt;     &lt;documentation&gt;sonstige intraprozedurale Komplikationen&lt;/documentation&gt;   &lt;/annotation&gt; &lt;/enumeration&gt; &lt;/restriction&gt; &lt;/simpleType&gt; </pre>
--	---

simpleType **enum\_0346**

namespace	http://xml.ir-d.de/stn		
type	restriction of <b>string</b>		
properties	base xs:string		
facets	Kind	Value	Annotation
	enumeration	0346001	documentation keine Therapie erforderlich
	enumeration	0346002	documentation medikamentös
	enumeration	0346003	documentation IABP
	enumeration	0346004	documentation VAD
	enumeration	0346005	documentation ECMO
	enumeration	0346042	documentation sonstige
annotation	documentation Kat_AK_TherapieLCO		
source	<pre> &lt;simpleType name="enum_0346"&gt;   &lt;annotation&gt;     &lt;documentation&gt;Kat_AK_TherapieLCO&lt;/documentation&gt;   &lt;/annotation&gt;   &lt;restriction base="xs:string"&gt;     &lt;enumeration value="0346001"&gt;       &lt;annotation&gt;         &lt;documentation&gt;keine Therapie erforderlich&lt;/documentation&gt;       &lt;/annotation&gt;     &lt;/enumeration&gt;   &lt;/restriction&gt; &lt;/simpleType&gt; </pre>		

	<pre> &lt;/enumeration&gt; &lt;enumeration value="0346002"&gt;   &lt;annotation&gt;     &lt;documentation&gt;medikamentös&lt;/documentation&gt;   &lt;/annotation&gt; &lt;/enumeration&gt; &lt;enumeration value="0346003"&gt;   &lt;annotation&gt;     &lt;documentation&gt;IABP&lt;/documentation&gt;   &lt;/annotation&gt; &lt;/enumeration&gt; &lt;enumeration value="0346004"&gt;   &lt;annotation&gt;     &lt;documentation&gt;VAD&lt;/documentation&gt;   &lt;/annotation&gt; &lt;/enumeration&gt; &lt;enumeration value="0346005"&gt;   &lt;annotation&gt;     &lt;documentation&gt;ECMO&lt;/documentation&gt;   &lt;/annotation&gt; &lt;/enumeration&gt; &lt;enumeration value="0346042"&gt;   &lt;annotation&gt;     &lt;documentation&gt;sonstige&lt;/documentation&gt;   &lt;/annotation&gt; &lt;/enumeration&gt; &lt;/restriction&gt; &lt;/simpleType&gt; </pre>
--	---

### simpleType enum\_0347

namespace	http://xml.ir-d.de/stn		
type	restriction of <b>string</b>		
properties	base xs:string		
facets	Kind	Value	Annotation
	enumeration	0347001	documentation Einzeleingriff
	enumeration	0347002	documentation Kombinationseingriff mit mehreren Prozeduren
annotation	documentation Kat_AK_Eingriffsumfang		
source	<pre> &lt;simpleType name="enum_0347"&gt;   &lt;annotation&gt;     &lt;documentation&gt;Kat_AK_Eingriffsumfang&lt;/documentation&gt;   &lt;/annotation&gt;   &lt;restriction base="xs:string"&gt;     &lt;enumeration value="0347001"&gt;       &lt;annotation&gt;         &lt;documentation&gt;Einzeleingriff&lt;/documentation&gt;       &lt;/annotation&gt;     &lt;/enumeration&gt;     &lt;enumeration value="0347002"&gt;       &lt;annotation&gt;         &lt;documentation&gt;Kombinationseingriff mit mehreren Prozeduren&lt;/documentation&gt;       &lt;/annotation&gt;     &lt;/enumeration&gt;   &lt;/restriction&gt; </pre>		



	<pre> &lt;/restriction&gt; &lt;/simpleType&gt; </pre>
--	---

### simpleType enum\_0348

namespace	http://xml.ir-d.de/stn		
type	restriction of <b>string</b>		
properties	base xs:string		
facets	Kind	Value	Annotation
	enumeration	0348001	documentation mit HLM
	enumeration	0348002	documentation ohne HLM
	enumeration	0348003	documentation Umstieg von OP ohne HLM auf OP mit HLM
annotation	documentation Kat_AK_OPVorgehen		
source	<pre> &lt;simpleType name="enum_0348"&gt;   &lt;annotation&gt;     &lt;documentation&gt;Kat_AK_OPVorgehen&lt;/documentation&gt;   &lt;/annotation&gt;   &lt;restriction base="xs:string"&gt;     &lt;enumeration value="0348001"&gt;       &lt;annotation&gt;         &lt;documentation&gt;mit HLM&lt;/documentation&gt;       &lt;/annotation&gt;     &lt;/enumeration&gt;     &lt;enumeration value="0348002"&gt;       &lt;annotation&gt;         &lt;documentation&gt;ohne HLM&lt;/documentation&gt;       &lt;/annotation&gt;     &lt;/enumeration&gt;     &lt;enumeration value="0348003"&gt;       &lt;annotation&gt;         &lt;documentation&gt;Umstieg von OP ohne HLM auf OP mit HLM&lt;/documentation&gt;       &lt;/annotation&gt;     &lt;/enumeration&gt;   &lt;/restriction&gt; &lt;/simpleType&gt; </pre>		

### simpleType enum\_0350

namespace	http://xml.ir-d.de/stn		
type	restriction of <b>string</b>		
properties	base xs:string		
facets	Kind	Value	Annotation
	enumeration	0350001	documentation IABP
	enumeration	0350002	documentation Impella
	enumeration	0350003	documentation vv ECMO
	enumeration	0350004	documentation va ECMO
	enumeration	0350042	documentation

	andere
annotation	documentation Kat AK Methode
source	<pre> &lt;simpleType name="enum_0350"&gt;   &lt;annotation&gt;     &lt;documentation&gt;Kat_AK_Methode&lt;/documentation&gt;   &lt;/annotation&gt;   &lt;restriction base="xs:string"&gt;     &lt;enumeration value="0350001"&gt;       &lt;annotation&gt;         &lt;documentation&gt;IABP&lt;/documentation&gt;       &lt;/annotation&gt;     &lt;/enumeration&gt;     &lt;enumeration value="0350002"&gt;       &lt;annotation&gt;         &lt;documentation&gt;Impella&lt;/documentation&gt;       &lt;/annotation&gt;     &lt;/enumeration&gt;     &lt;enumeration value="0350003"&gt;       &lt;annotation&gt;         &lt;documentation&gt;vv ECMO&lt;/documentation&gt;       &lt;/annotation&gt;     &lt;/enumeration&gt;     &lt;enumeration value="0350004"&gt;       &lt;annotation&gt;         &lt;documentation&gt;va ECMO&lt;/documentation&gt;       &lt;/annotation&gt;     &lt;/enumeration&gt;     &lt;enumeration value="0350042"&gt;       &lt;annotation&gt;         &lt;documentation&gt;andere&lt;/documentation&gt;       &lt;/annotation&gt;     &lt;/enumeration&gt;   &lt;/restriction&gt; &lt;/simpleType&gt; </pre>

### simpleType enum\_0351

namespace	http://xml.ir-d.de/stn		
type	restriction of <b>string</b>		
properties	base xs:string		
facets	Kind	Value	Annotation
	enumeration	0351001	documentation nein
	enumeration	0351002	documentation ja, zu Stenotomie
	enumeration	0351003	documentation ja, zu transapikal
	enumeration	0351004	documentation ja, zu transaortal
	enumeration	0351005	documentation ja, zu transfemoral
	enumeration	0351006	documentation ja, zu transaxillär
	enumeration	0351007	documentation ja, zu anderem endovaskulären Zugang
	enumeration	0351042	documentation ja, zu anderem Zugang

annotation	documentation Kat_AK_Konversion
source	<pre> &lt;simpleType name="enum_0351"&gt;   &lt;annotation&gt;     &lt;documentation&gt;Kat_AK_Konversion&lt;/documentation&gt;   &lt;/annotation&gt;   &lt;restriction base="xs:string"&gt;     &lt;enumeration value="0351001"&gt;       &lt;annotation&gt;         &lt;documentation&gt;nein&lt;/documentation&gt;       &lt;/annotation&gt;     &lt;/enumeration&gt;     &lt;enumeration value="0351002"&gt;       &lt;annotation&gt;         &lt;documentation&gt;ja, zu Sternotomie&lt;/documentation&gt;       &lt;/annotation&gt;     &lt;/enumeration&gt;     &lt;enumeration value="0351003"&gt;       &lt;annotation&gt;         &lt;documentation&gt;ja, zu transapikal&lt;/documentation&gt;       &lt;/annotation&gt;     &lt;/enumeration&gt;     &lt;enumeration value="0351004"&gt;       &lt;annotation&gt;         &lt;documentation&gt;ja, zu transaortal&lt;/documentation&gt;       &lt;/annotation&gt;     &lt;/enumeration&gt;     &lt;enumeration value="0351005"&gt;       &lt;annotation&gt;         &lt;documentation&gt;ja, zu transfemoral&lt;/documentation&gt;       &lt;/annotation&gt;     &lt;/enumeration&gt;     &lt;enumeration value="0351006"&gt;       &lt;annotation&gt;         &lt;documentation&gt;ja, zu transaxillär&lt;/documentation&gt;       &lt;/annotation&gt;     &lt;/enumeration&gt;     &lt;enumeration value="0351007"&gt;       &lt;annotation&gt;         &lt;documentation&gt;ja, zu anderem endovaskulären Zugang&lt;/documentation&gt;       &lt;/annotation&gt;     &lt;/enumeration&gt;     &lt;enumeration value="0351042"&gt;       &lt;annotation&gt;         &lt;documentation&gt;ja, zu anderem Zugang&lt;/documentation&gt;       &lt;/annotation&gt;     &lt;/enumeration&gt;   &lt;/restriction&gt; &lt;/simpleType&gt; </pre>

### simpleType enum\_0352

namespace	http://xml.ir-d.de/stn		
type	restriction of <b>string</b>		
properties	base	xs:string	
facets	Kind	Value	Annotation

	enumeration 0352001 documentation nein enumeration 0352002 documentation ja, Intubationsnarkose enumeration 0352003 documentation ja, Maskenbeatmung, incl. LAMA enumeration 0352042 documentation ja, unbekannt welche
annotation	documentation Kat_AK_Anaesthesie
source	<pre> &lt;simpleType name="enum_0352"&gt;   &lt;annotation&gt;     &lt;documentation&gt;Kat_AK_Anaesthesie&lt;/documentation&gt;   &lt;/annotation&gt;   &lt;restriction base="xs:string"&gt;     &lt;enumeration value="0352001"&gt;       &lt;annotation&gt;         &lt;documentation&gt;nein&lt;/documentation&gt;       &lt;/annotation&gt;     &lt;/enumeration&gt;     &lt;enumeration value="0352002"&gt;       &lt;annotation&gt;         &lt;documentation&gt;ja, Intubationsnarkose&lt;/documentation&gt;       &lt;/annotation&gt;     &lt;/enumeration&gt;     &lt;enumeration value="0352003"&gt;       &lt;annotation&gt;         &lt;documentation&gt;ja, Maskenbeatmung, incl. LAMA&lt;/documentation&gt;       &lt;/annotation&gt;     &lt;/enumeration&gt;     &lt;enumeration value="0352042"&gt;       &lt;annotation&gt;         &lt;documentation&gt;ja, unbekannt welche&lt;/documentation&gt;       &lt;/annotation&gt;     &lt;/enumeration&gt;   &lt;/restriction&gt; &lt;/simpleType&gt; </pre>

### simpleType enum\_0353

namespace	http://xml.ir-d.de/stn		
type	restriction of <b>string</b>		
properties	base xs:string		
facets	Kind	Value	Annotation
	enumeration	0353001	documentation keine
	enumeration	0353002	documentation leichtgradig
	enumeration	0353003	documentation mittelgradig
	enumeration	0353004	documentation hochgradig
	enumeration	0353099	documentation nicht bestimmbar
annotation	documentation Kat_AK_ResidualeAorteninsuffizienz		
source	<pre> &lt;simpleType name="enum_0353"&gt;   &lt;annotation&gt; </pre>		

	<pre> &lt;documentation&gt;Kat_AK_ResidualeAorteninsuffizienz&lt;/documentation&gt; &lt;/annotation&gt; &lt;restriction base="xs:string"&gt;   &lt;enumeration value="0353001"&gt;     &lt;annotation&gt;       &lt;documentation&gt;keine&lt;/documentation&gt;     &lt;/annotation&gt;   &lt;/enumeration&gt;   &lt;enumeration value="0353002"&gt;     &lt;annotation&gt;       &lt;documentation&gt;leichtgradig&lt;/documentation&gt;     &lt;/annotation&gt;   &lt;/enumeration&gt;   &lt;enumeration value="0353003"&gt;     &lt;annotation&gt;       &lt;documentation&gt;mittelgradig&lt;/documentation&gt;     &lt;/annotation&gt;   &lt;/enumeration&gt;   &lt;enumeration value="0353004"&gt;     &lt;annotation&gt;       &lt;documentation&gt;hochgradig&lt;/documentation&gt;     &lt;/annotation&gt;   &lt;/enumeration&gt;   &lt;enumeration value="0353099"&gt;     &lt;annotation&gt;       &lt;documentation&gt;nicht bestimmbar&lt;/documentation&gt;     &lt;/annotation&gt;   &lt;/enumeration&gt; &lt;/restriction&gt; &lt;/simpleType&gt; </pre>
--	---

#### simpleType enum\_0354

namespace	http://xml.ir-d.de/stn		
type	restriction of <b>string</b>		
properties	base xs:string		
facets	Kind	Value	Annotation
	enumeration	0354001	documentation chirurgisch-offen
	enumeration	0354002	documentation Verschluss-System
	enumeration	0354042	documentation sonstige
annotation	documentation Kat_AK_Zugangswegverschluss		
source	<pre> &lt;simpleType name="enum_0354"&gt;   &lt;annotation&gt;     &lt;documentation&gt;Kat_AK_Zugangswegverschluss&lt;/documentation&gt;   &lt;/annotation&gt;   &lt;restriction base="xs:string"&gt;     &lt;enumeration value="0354001"&gt;       &lt;annotation&gt;         &lt;documentation&gt;chirurgisch-offen&lt;/documentation&gt;       &lt;/annotation&gt;     &lt;/enumeration&gt;     &lt;enumeration value="0354002"&gt;       &lt;annotation&gt; </pre>		

	<pre> &lt;documentation&gt;Verschluss-System&lt;/documentation&gt; &lt;/annotation&gt; &lt;/enumeration&gt; &lt;enumeration value="0354042"&gt;   &lt;annotation&gt;     &lt;documentation&gt;sonstige&lt;/documentation&gt;   &lt;/annotation&gt; &lt;/enumeration&gt; &lt;/restriction&gt; &lt;/simpleType&gt; </pre>
--	---

### simpleType enum\_0357

namespace	http://xml.ir-d.de/stn		
type	restriction of <b>string</b>		
properties	base xs:string		
facets	Kind	Value	Annotation
	enumeration	0357001	documentation keine KHK
	enumeration	0357002	documentation 1-Gefäßerkrankung
	enumeration	0357003	documentation 2-Gefäßerkrankung
	enumeration	0357004	documentation 3-Gefäßerkrankung
	enumeration	0357005	documentation keine koronare Bildgebung
annotation	documentation Kat_AK_BefundBildgebung		
source	<pre> &lt;simpleType name="enum_0357"&gt;   &lt;annotation&gt;     &lt;documentation&gt;Kat_AK_BefundBildgebung&lt;/documentation&gt;   &lt;/annotation&gt;   &lt;restriction base="xs:string"&gt;     &lt;enumeration value="0357001"&gt;       &lt;annotation&gt;         &lt;documentation&gt;keine KHK&lt;/documentation&gt;       &lt;/annotation&gt;     &lt;/enumeration&gt;     &lt;enumeration value="0357002"&gt;       &lt;annotation&gt;         &lt;documentation&gt;1-Gefäßerkrankung&lt;/documentation&gt;       &lt;/annotation&gt;     &lt;/enumeration&gt;     &lt;enumeration value="0357003"&gt;       &lt;annotation&gt;         &lt;documentation&gt;2-Gefäßerkrankung&lt;/documentation&gt;       &lt;/annotation&gt;     &lt;/enumeration&gt;     &lt;enumeration value="0357004"&gt;       &lt;annotation&gt;         &lt;documentation&gt;3-Gefäßerkrankung&lt;/documentation&gt;       &lt;/annotation&gt;     &lt;/enumeration&gt;     &lt;enumeration value="0357005"&gt;       &lt;annotation&gt;         &lt;documentation&gt;keine koronare Bildgebung&lt;/documentation&gt;       &lt;/annotation&gt;     &lt;/enumeration&gt;   &lt;/restriction&gt; &lt;/simpleType&gt; </pre>		

```

</annotation>
</enumeration>
</restriction>
</simpleType>

```

### simpleType enum\_0358

namespace	http://xml.ir-d.de/stn		
type	restriction of <b>string</b>		
properties	base xs:string		
facets	Kind	Value	Annotation
	enumeration	0358001	documentation 0
	enumeration	0358002	documentation 1
	enumeration	0358003	documentation 2
	enumeration	0358004	documentation 3
	enumeration	0358005	documentation 4
	enumeration	0358006	documentation 5 oder mehr
	enumeration	0358098	documentation genaue Anzahl unbekannt (aber mind. 1)
	enumeration	0358099	documentation unbekannt
annotation	documentation Kat_AK_AnzahlVorOP		
source	<pre> &lt;simpleType name="enum_0358"&gt;   &lt;annotation&gt;     &lt;documentation&gt;Kat_AK_AnzahlVorOP&lt;/documentation&gt;   &lt;/annotation&gt;   &lt;restriction base="xs:string"&gt;     &lt;enumeration value="0358001"&gt;       &lt;annotation&gt;         &lt;documentation&gt;0&lt;/documentation&gt;       &lt;/annotation&gt;     &lt;/enumeration&gt;     &lt;enumeration value="0358002"&gt;       &lt;annotation&gt;         &lt;documentation&gt;1&lt;/documentation&gt;       &lt;/annotation&gt;     &lt;/enumeration&gt;     &lt;enumeration value="0358003"&gt;       &lt;annotation&gt;         &lt;documentation&gt;2&lt;/documentation&gt;       &lt;/annotation&gt;     &lt;/enumeration&gt;     &lt;enumeration value="0358004"&gt;       &lt;annotation&gt;         &lt;documentation&gt;3&lt;/documentation&gt;       &lt;/annotation&gt;     &lt;/enumeration&gt;     &lt;enumeration value="0358005"&gt;       &lt;annotation&gt;         &lt;documentation&gt;4&lt;/documentation&gt;       &lt;/annotation&gt;     &lt;/enumeration&gt;   &lt;/restriction&gt; &lt;/simpleType&gt; </pre>		

	<pre> &lt;/enumeration&gt; &lt;enumeration value="0358006"&gt;   &lt;annotation&gt;     &lt;documentation&gt;5 oder mehr&lt;/documentation&gt;   &lt;/annotation&gt; &lt;/enumeration&gt; &lt;enumeration value="0358098"&gt;   &lt;annotation&gt;     &lt;documentation&gt;genaue Anzahl unbekannt (aber mind. 1)&lt;/documentation&gt;   &lt;/annotation&gt; &lt;/enumeration&gt; &lt;enumeration value="0358099"&gt;   &lt;annotation&gt;     &lt;documentation&gt;unbekannt&lt;/documentation&gt;   &lt;/annotation&gt; &lt;/enumeration&gt; &lt;/restriction&gt; &lt;/simpleType&gt; </pre>
--	--

### simpleType **enum\_0359**

namespace	http://xml.ir-d.de/stn		
type	restriction of <b>string</b>		
properties	base xs:string		
facets	Kind	Value	Annotation
	enumeration	0359001	documentation nein
	enumeration	0359002	documentation ja - einseitig
	enumeration	0359003	documentation ja - beidseitig
	enumeration	0359042	documentation unbekannt
annotation	documentation Kat_AK_LVOT		
source	<pre> &lt;simpleType name="enum_0359"&gt;   &lt;annotation&gt;     &lt;documentation&gt;Kat_AK_LVOT&lt;/documentation&gt;   &lt;/annotation&gt;   &lt;restriction base="xs:string"&gt;     &lt;enumeration value="0359001"&gt;       &lt;annotation&gt;         &lt;documentation&gt;nein&lt;/documentation&gt;       &lt;/annotation&gt;     &lt;/enumeration&gt;     &lt;enumeration value="0359002"&gt;       &lt;annotation&gt;         &lt;documentation&gt;ja - einseitig&lt;/documentation&gt;       &lt;/annotation&gt;     &lt;/enumeration&gt;     &lt;enumeration value="0359003"&gt;       &lt;annotation&gt;         &lt;documentation&gt;ja - beidseitig&lt;/documentation&gt;       &lt;/annotation&gt;     &lt;/enumeration&gt;     &lt;enumeration value="0359042"&gt;       &lt;annotation&gt; </pre>		



```

    <documentation>unbekannt</documentation>
  </annotation>
</enumeration>
</restriction>
</simpleType>

```

### simpleType enum\_0360

namespace	http://xml.ir-d.de/stn		
type	restriction of <b>string</b>		
properties	base xs:string		
facets	Kind	Value	Annotation
	enumeration	0360001	documentation keine
	enumeration	0360002	documentation leichtgradig
	enumeration	0360003	documentation mittelgradig
	enumeration	0360004	documentation hochgradig
	enumeration	0360005	documentation massive
	enumeration	0360006	documentation torrential
	enumeration	0360099	documentation unbekannt
annotation	documentation Kat_AK_TriskupidalInsuffizienz		
source	<pre> &lt;simpleType name="enum_0360"&gt;   &lt;annotation&gt;     &lt;documentation&gt;Kat_AK_TriskupidalInsuffizienz&lt;/documentation&gt;   &lt;/annotation&gt;   &lt;restriction base="xs:string"&gt;     &lt;enumeration value="0360001"&gt;       &lt;annotation&gt;         &lt;documentation&gt;keine&lt;/documentation&gt;       &lt;/annotation&gt;     &lt;/enumeration&gt;     &lt;enumeration value="0360002"&gt;       &lt;annotation&gt;         &lt;documentation&gt;leichtgradig&lt;/documentation&gt;       &lt;/annotation&gt;     &lt;/enumeration&gt;     &lt;enumeration value="0360003"&gt;       &lt;annotation&gt;         &lt;documentation&gt;mittelgradig&lt;/documentation&gt;       &lt;/annotation&gt;     &lt;/enumeration&gt;     &lt;enumeration value="0360004"&gt;       &lt;annotation&gt;         &lt;documentation&gt;hochgradig&lt;/documentation&gt;       &lt;/annotation&gt;     &lt;/enumeration&gt;     &lt;enumeration value="0360005"&gt;       &lt;annotation&gt;         &lt;documentation&gt;massive&lt;/documentation&gt;       &lt;/annotation&gt;     &lt;/enumeration&gt;   &lt;/restriction&gt; &lt;/simpleType&gt; </pre>		

	<pre> &lt;/enumeration&gt; &lt;enumeration value="0360006"&gt;   &lt;annotation&gt;     &lt;documentation&gt;torrential&lt;/documentation&gt;   &lt;/annotation&gt; &lt;/enumeration&gt; &lt;enumeration value="0360099"&gt;   &lt;annotation&gt;     &lt;documentation&gt;unbekannt&lt;/documentation&gt;   &lt;/annotation&gt; &lt;/enumeration&gt; &lt;/restriction&gt; &lt;/simpleType&gt; </pre>
--	---

### simpleType enum\_0361

namespace	http://xml.ir-d.de/stn																					
type	restriction of <b>string</b>																					
properties	base xs:string																					
facets	<table border="1"> <thead> <tr> <th>Kind</th> <th>Value</th> <th>Annotation</th> </tr> </thead> <tbody> <tr> <td>enumeration</td> <td>0361001</td> <td>documentation nein</td> </tr> <tr> <td>enumeration</td> <td>0361002</td> <td>documentation ja, letzte(r) innerhalb der letzten 48 Stunden</td> </tr> <tr> <td>enumeration</td> <td>0361003</td> <td>documentation ja, letzte(r) innerhalb der letzten 21 Tage</td> </tr> <tr> <td>enumeration</td> <td>0361004</td> <td>documentation ja, letzte(r) länger als 21 Tage</td> </tr> <tr> <td>enumeration</td> <td>0361098</td> <td>documentation ja, letzter Zeitpunkt unbekannt</td> </tr> <tr> <td>enumeration</td> <td>0361099</td> <td>documentation unbekannt</td> </tr> </tbody> </table>	Kind	Value	Annotation	enumeration	0361001	documentation nein	enumeration	0361002	documentation ja, letzte(r) innerhalb der letzten 48 Stunden	enumeration	0361003	documentation ja, letzte(r) innerhalb der letzten 21 Tage	enumeration	0361004	documentation ja, letzte(r) länger als 21 Tage	enumeration	0361098	documentation ja, letzter Zeitpunkt unbekannt	enumeration	0361099	documentation unbekannt
Kind	Value	Annotation																				
enumeration	0361001	documentation nein																				
enumeration	0361002	documentation ja, letzte(r) innerhalb der letzten 48 Stunden																				
enumeration	0361003	documentation ja, letzte(r) innerhalb der letzten 21 Tage																				
enumeration	0361004	documentation ja, letzte(r) länger als 21 Tage																				
enumeration	0361098	documentation ja, letzter Zeitpunkt unbekannt																				
enumeration	0361099	documentation unbekannt																				
annotation	documentation Kat_AK_SchockReanimation																					
source	<pre> &lt;simpleType name="enum_0361"&gt;   &lt;annotation&gt;     &lt;documentation&gt;Kat_AK_SchockReanimation&lt;/documentation&gt;   &lt;/annotation&gt;   &lt;restriction base="xs:string"&gt;     &lt;enumeration value="0361001"&gt;       &lt;annotation&gt;         &lt;documentation&gt;nein&lt;/documentation&gt;       &lt;/annotation&gt;     &lt;/enumeration&gt;     &lt;enumeration value="0361002"&gt;       &lt;annotation&gt;         &lt;documentation&gt;ja, letzte(r) innerhalb der letzten 48 Stunden&lt;/documentation&gt;       &lt;/annotation&gt;     &lt;/enumeration&gt;     &lt;enumeration value="0361003"&gt;       &lt;annotation&gt;         &lt;documentation&gt;ja, letzte(r) innerhalb der letzten 21 Tage&lt;/documentation&gt;       &lt;/annotation&gt;     &lt;/enumeration&gt;     &lt;enumeration value="0361004"&gt; </pre>																					

	<pre> &lt;annotation&gt;   &lt;documentation&gt;ja, letzte(r) länger als 21 Tage&lt;/documentation&gt; &lt;/annotation&gt; &lt;/enumeration&gt; &lt;enumeration value="0361098"&gt;   &lt;annotation&gt;     &lt;documentation&gt;ja, letzter Zeitpunkt unbekannt&lt;/documentation&gt;   &lt;/annotation&gt; &lt;/enumeration&gt; &lt;enumeration value="0361099"&gt;   &lt;annotation&gt;     &lt;documentation&gt;unbekannt&lt;/documentation&gt;   &lt;/annotation&gt; &lt;/enumeration&gt; &lt;/restriction&gt; &lt;/simpleType&gt; </pre>
--	---

### simpleType enum 0362

namespace	http://xml.ir-d.de/stn		
type	restriction of <b>string</b>		
properties	base xs:string		
facets	Kind	Value	Annotation
	enumeration	0362001	documentation Sinusrhythmus
	enumeration	0362002	documentation Vorhofflimmern
	enumeration	0362042	documentation anderer Herzrhythmus
annotation	documentation Kat_AK_Herzrhythmus		
source	<pre> &lt;simpleType name="enum_0362"&gt;   &lt;annotation&gt;     &lt;documentation&gt;Kat_AK_Herzrhythmus&lt;/documentation&gt;   &lt;/annotation&gt;   &lt;restriction base="xs:string"&gt;     &lt;enumeration value="0362001"&gt;       &lt;annotation&gt;         &lt;documentation&gt;Sinusrhythmus&lt;/documentation&gt;       &lt;/annotation&gt;     &lt;/enumeration&gt;     &lt;enumeration value="0362002"&gt;       &lt;annotation&gt;         &lt;documentation&gt;Vorhofflimmern&lt;/documentation&gt;       &lt;/annotation&gt;     &lt;/enumeration&gt;     &lt;enumeration value="0362042"&gt;       &lt;annotation&gt;         &lt;documentation&gt;anderer Herzrhythmus&lt;/documentation&gt;       &lt;/annotation&gt;     &lt;/enumeration&gt;   &lt;/restriction&gt; &lt;/simpleType&gt; </pre>		

### simpleType enum\_0363

namespace	http://xml.ir-d.de/stn		
type	restriction of <b>string</b>		
properties	base xs:string		
facets	Kind	Value	Annotation
	enumeration	0363001	documentation nein
	enumeration	0363002	documentation paroxysmal
	enumeration	0363003	documentation persistierend
	enumeration	0363004	documentation permanent
annotation	documentation Kat_AK_Vorhofflimmern		
source	<pre> &lt;simpleType name="enum_0363"&gt;   &lt;annotation&gt;     &lt;documentation&gt;Kat_AK_Vorhofflimmern&lt;/documentation&gt;   &lt;/annotation&gt;   &lt;restriction base="xs:string"&gt;     &lt;enumeration value="0363001"&gt;       &lt;annotation&gt;         &lt;documentation&gt;nein&lt;/documentation&gt;       &lt;/annotation&gt;     &lt;/enumeration&gt;     &lt;enumeration value="0363002"&gt;       &lt;annotation&gt;         &lt;documentation&gt;paroxysmal&lt;/documentation&gt;       &lt;/annotation&gt;     &lt;/enumeration&gt;     &lt;enumeration value="0363003"&gt;       &lt;annotation&gt;         &lt;documentation&gt;persistierend&lt;/documentation&gt;       &lt;/annotation&gt;     &lt;/enumeration&gt;     &lt;enumeration value="0363004"&gt;       &lt;annotation&gt;         &lt;documentation&gt;permanent&lt;/documentation&gt;       &lt;/annotation&gt;     &lt;/enumeration&gt;   &lt;/restriction&gt; &lt;/simpleType&gt; </pre>		

### simpleType enum\_0364

namespace	http://xml.ir-d.de/stn		
type	restriction of <b>string</b>		
properties	base xs:string		
facets	Kind	Value	Annotation
	enumeration	0364001	documentation nein
	enumeration	0364002	documentation Schrittmacher ohne CRT-System
	enumeration	0364003	documentation Schrittmacher mit CRT-System
	enumeration	0364004	documentation

	enumeration 0364005 Defibrillator ohne CRT-System documentation Defibrillator mit CRT-System
annotation	documentation Kat_AK_SchrittmacherDefi
source	<pre> &lt;simpleType name="enum_0364"&gt;   &lt;annotation&gt;     &lt;documentation&gt;Kat_AK_SchrittmacherDefi&lt;/documentation&gt;   &lt;/annotation&gt;   &lt;restriction base="xs:string"&gt;     &lt;enumeration value="0364001"&gt;       &lt;annotation&gt;         &lt;documentation&gt;nein&lt;/documentation&gt;       &lt;/annotation&gt;     &lt;/enumeration&gt;     &lt;enumeration value="0364002"&gt;       &lt;annotation&gt;         &lt;documentation&gt;Schrittmacher ohne CRT-System&lt;/documentation&gt;       &lt;/annotation&gt;     &lt;/enumeration&gt;     &lt;enumeration value="0364003"&gt;       &lt;annotation&gt;         &lt;documentation&gt;Schrittmacher mit CRT-System&lt;/documentation&gt;       &lt;/annotation&gt;     &lt;/enumeration&gt;     &lt;enumeration value="0364004"&gt;       &lt;annotation&gt;         &lt;documentation&gt;Defibrillator ohne CRT-System&lt;/documentation&gt;       &lt;/annotation&gt;     &lt;/enumeration&gt;     &lt;enumeration value="0364005"&gt;       &lt;annotation&gt;         &lt;documentation&gt;Defibrillator mit CRT-System&lt;/documentation&gt;       &lt;/annotation&gt;     &lt;/enumeration&gt;   &lt;/restriction&gt; &lt;/simpleType&gt; </pre>

### simpleType enum\_0365

namespace	http://xml.ir-d.de/stn		
type	restriction of <b>string</b>		
properties	base xs:string		
facets	Kind	Value	Annotation
	enumeration	0365001	documentation nein
	enumeration	0365002	documentation ja, operativ
	enumeration	0365003	documentation ja, interventionell
annotation	documentation Kat_AK_MyokardRevaskularisation		
source	<pre> &lt;simpleType name="enum_0365"&gt;   &lt;annotation&gt;     &lt;documentation&gt;Kat_AK_MyokardRevaskularisation&lt;/documentation&gt;   &lt;/annotation&gt;   &lt;restriction base="xs:string"&gt; </pre>		

	<pre> &lt;enumeration value="0365001"&gt;   &lt;annotation&gt;     &lt;documentation&gt;nein&lt;/documentation&gt;   &lt;/annotation&gt; &lt;/enumeration&gt; &lt;enumeration value="0365002"&gt;   &lt;annotation&gt;     &lt;documentation&gt;ja, operativ&lt;/documentation&gt;   &lt;/annotation&gt; &lt;/enumeration&gt; &lt;enumeration value="0365003"&gt;   &lt;annotation&gt;     &lt;documentation&gt;ja, interventionell&lt;/documentation&gt;   &lt;/annotation&gt; &lt;/enumeration&gt; &lt;/restriction&gt; &lt;/simpleType&gt; </pre>
--	--

### simpleType enum 0366

namespace	http://xml.ir-d.de/stn		
type	restriction of <b>string</b>		
properties	base xs:string		
facets	Kind	Value	Annotation
	enumeration	0366001	documentation nein
	enumeration	0366002	documentation ja, &lt;= 6 Stunden
	enumeration	0366003	documentation ja, &gt; 6 Stunden bis &lt;= 3 Monate
	enumeration	0366004	documentation ja, &gt; 3 Monate
	enumeration	0366099	documentation unbekannt
annotation	documentation Kat_AK_PCI		
source	<pre> &lt;simpleType name="enum_0366"&gt;   &lt;annotation&gt;     &lt;documentation&gt;Kat_AK_PCI&lt;/documentation&gt;   &lt;/annotation&gt;   &lt;restriction base="xs:string"&gt;     &lt;enumeration value="0366001"&gt;       &lt;annotation&gt;         &lt;documentation&gt;nein&lt;/documentation&gt;       &lt;/annotation&gt;     &lt;/enumeration&gt;     &lt;enumeration value="0366002"&gt;       &lt;annotation&gt;         &lt;documentation&gt;ja, &amp;lt;= 6 Stunden&lt;/documentation&gt;       &lt;/annotation&gt;     &lt;/enumeration&gt;     &lt;enumeration value="0366003"&gt;       &lt;annotation&gt;         &lt;documentation&gt;ja, &amp;gt; 6 Stunden bis &amp;lt;= 3 Monate&lt;/documentation&gt;       &lt;/annotation&gt;     &lt;/enumeration&gt;     &lt;enumeration value="0366004"&gt; </pre>		

	<pre> &lt;annotation&gt;   &lt;documentation&gt;ja, &amp;gt; 3 Monate&lt;/documentation&gt; &lt;/annotation&gt; &lt;/enumeration&gt; &lt;enumeration value="0366099"&gt;   &lt;annotation&gt;     &lt;documentation&gt;unbekannt&lt;/documentation&gt;   &lt;/annotation&gt; &lt;/enumeration&gt; &lt;/restriction&gt; &lt;/simpleType&gt; </pre>
--	---

### simpleType enum\_0367

namespace	http://xml.ir-d.de/stn		
type	restriction of <b>string</b>		
properties	base xs:string		
facets	Kind	Value	Annotation
	enumeration	0367001	documentation keine
	enumeration	0367002	documentation Mediastinitis
	enumeration	0367003	documentation Sepsis
	enumeration	0367004	documentation broncho-pulmonale Infektion
	enumeration	0367005	documentation oto-laryngologische Infektion
	enumeration	0367006	documentation floride Endokarditis
	enumeration	0367007	documentation Peritonitis
	enumeration	0367008	documentation Wundinfektion Thorax
	enumeration	0367009	documentation Pleuraempyem
	enumeration	0367010	documentation Venenkatheterinfektion
	enumeration	0367011	documentation Harnwegsinfektion
	enumeration	0367012	documentation Wundinfektion untere Extremitäten
	enumeration	0367013	documentation HIV-Infektion
	enumeration	0367014	documentation Hepatitis B oder C
	enumeration	0367015	documentation andere Wundinfektion
	enumeration	0367042	documentation sonstige Infektion
annotation	documentation Kat_AK_Infektion		
source	<pre> &lt;simpleType name="enum_0367"&gt;   &lt;annotation&gt;     &lt;documentation&gt;Kat_AK_Infektion&lt;/documentation&gt;   &lt;/annotation&gt;   &lt;restriction base="xs:string"&gt;     &lt;enumeration value="0367001"&gt;       &lt;annotation&gt; </pre>		

```
<documentation>keine</documentation>
</annotation>
</enumeration>
<enumeration value="0367002">
  <annotation>
    <documentation>Mediastinitis</documentation>
  </annotation>
</enumeration>
<enumeration value="0367003">
  <annotation>
    <documentation>Sepsis</documentation>
  </annotation>
</enumeration>
<enumeration value="0367004">
  <annotation>
    <documentation>broncho-pulmonale Infektion</documentation>
  </annotation>
</enumeration>
<enumeration value="0367005">
  <annotation>
    <documentation>oto-laryngologische Infektion</documentation>
  </annotation>
</enumeration>
<enumeration value="0367006">
  <annotation>
    <documentation>floride Endokarditis</documentation>
  </annotation>
</enumeration>
<enumeration value="0367007">
  <annotation>
    <documentation>Peritonitis</documentation>
  </annotation>
</enumeration>
<enumeration value="0367008">
  <annotation>
    <documentation>Wundinfektion Thorax</documentation>
  </annotation>
</enumeration>
<enumeration value="0367009">
  <annotation>
    <documentation>Pleuraempyem</documentation>
  </annotation>
</enumeration>
<enumeration value="0367010">
  <annotation>
    <documentation>Venenkatheterinfektion</documentation>
  </annotation>
</enumeration>
<enumeration value="0367011">
  <annotation>
    <documentation>Harnwegsinfektion</documentation>
  </annotation>
</enumeration>
<enumeration value="0367012">
  <annotation>
    <documentation>Wundinfektion untere Extremitäten</documentation>
  </annotation>
</enumeration>
<enumeration value="0367013">
```



	<pre> &lt;annotation&gt;   &lt;documentation&gt;HIV-Infektion&lt;/documentation&gt; &lt;/annotation&gt; &lt;/enumeration&gt; &lt;enumeration value="0367014"&gt;   &lt;annotation&gt;     &lt;documentation&gt;Hepatitis B oder C&lt;/documentation&gt;   &lt;/annotation&gt; &lt;/enumeration&gt; &lt;enumeration value="0367015"&gt;   &lt;annotation&gt;     &lt;documentation&gt;andere Wundinfektion&lt;/documentation&gt;   &lt;/annotation&gt; &lt;/enumeration&gt; &lt;enumeration value="0367042"&gt;   &lt;annotation&gt;     &lt;documentation&gt;sonstige Infektion&lt;/documentation&gt;   &lt;/annotation&gt; &lt;/enumeration&gt; &lt;/restriction&gt; &lt;/simpleType&gt; </pre>
--	--

### simpleType enum 0368

namespace	http://xml.ir-d.de/stn		
type	restriction of <b>string</b>		
properties	base xs:string		
facets	Kind	Value	Annotation
	enumeration	0368001	documentation nein
	enumeration	0368002	documentation ja, COPD mit Dauermedikation
	enumeration	0368003	documentation ja, COPD ohne Dauermedikation
	enumeration	0368004	documentation ja, andere Lungenerkrankungen
	enumeration	0368099	documentation unbekannt
annotation	documentation Kat_AK_Lungenerkrankung		
source	<pre> &lt;simpleType name="enum_0368"&gt;   &lt;annotation&gt;     &lt;documentation&gt;Kat_AK_Lungenerkrankung&lt;/documentation&gt;   &lt;/annotation&gt;   &lt;restriction base="xs:string"&gt;     &lt;enumeration value="0368001"&gt;       &lt;annotation&gt;         &lt;documentation&gt;nein&lt;/documentation&gt;       &lt;/annotation&gt;     &lt;/enumeration&gt;     &lt;enumeration value="0368002"&gt;       &lt;annotation&gt;         &lt;documentation&gt;ja, COPD mit Dauermedikation&lt;/documentation&gt;       &lt;/annotation&gt;     &lt;/enumeration&gt;     &lt;enumeration value="0368003"&gt;       &lt;annotation&gt; </pre>		

	<pre> &lt;documentation&gt;ja, COPD ohne Dauermedikation&lt;/documentation&gt; &lt;/annotation&gt; &lt;/enumeration&gt; &lt;enumeration value="0368004"&gt;   &lt;annotation&gt;     &lt;documentation&gt;ja, andere Lungenerkrankungen&lt;/documentation&gt;   &lt;/annotation&gt; &lt;/enumeration&gt; &lt;enumeration value="0368099"&gt;   &lt;annotation&gt;     &lt;documentation&gt;unbekannt&lt;/documentation&gt;   &lt;/annotation&gt; &lt;/enumeration&gt; &lt;/restriction&gt; &lt;/simpleType&gt; </pre>
--	---

### simpleType enum 0369

namespace	http://xml.ir-d.de/stn		
type	restriction of <b>string</b>		
properties	base xs:string		
facets	Kind	Value	Annotation
	enumeration	0369001	documentation nein
	enumeration	0369002	documentation akut
	enumeration	0369003	documentation chronisch
annotation	documentation Kat_AK_Nierenersatztherapie		
source	<pre> &lt;simpleType name="enum_0369"&gt;   &lt;annotation&gt;     &lt;documentation&gt;Kat_AK_Nierenersatztherapie&lt;/documentation&gt;   &lt;/annotation&gt;   &lt;restriction base="xs:string"&gt;     &lt;enumeration value="0369001"&gt;       &lt;annotation&gt;         &lt;documentation&gt;nein&lt;/documentation&gt;       &lt;/annotation&gt;     &lt;/enumeration&gt;     &lt;enumeration value="0369002"&gt;       &lt;annotation&gt;         &lt;documentation&gt;akut&lt;/documentation&gt;       &lt;/annotation&gt;     &lt;/enumeration&gt;     &lt;enumeration value="0369003"&gt;       &lt;annotation&gt;         &lt;documentation&gt;chronisch&lt;/documentation&gt;       &lt;/annotation&gt;     &lt;/enumeration&gt;   &lt;/restriction&gt; &lt;/simpleType&gt; </pre>		

### simpleType enum\_0370

namespace	http://xml.ir-d.de/stn		
type	restriction of <b>string</b>		
properties	base xs:string		
facets	Kind	Value	Annotation
	enumeration	0370001	documentation Echokardiographie
	enumeration	0370002	documentation Herzkatheter
	enumeration	0370042	documentation andere
annotation	documentation Kat_AK_AKOEFMessmethode		
source	<pre> &lt;simpleType name="enum_0370"&gt;   &lt;annotation&gt;     &lt;documentation&gt;Kat_AK_AKOEFMessmethode&lt;/documentation&gt;   &lt;/annotation&gt;   &lt;restriction base="xs:string"&gt;     &lt;enumeration value="0370001"&gt;       &lt;annotation&gt;         &lt;documentation&gt;Echokardiographie&lt;/documentation&gt;       &lt;/annotation&gt;     &lt;/enumeration&gt;     &lt;enumeration value="0370002"&gt;       &lt;annotation&gt;         &lt;documentation&gt;Herzkatheter&lt;/documentation&gt;       &lt;/annotation&gt;     &lt;/enumeration&gt;     &lt;enumeration value="0370042"&gt;       &lt;annotation&gt;         &lt;documentation&gt;andere&lt;/documentation&gt;       &lt;/annotation&gt;     &lt;/enumeration&gt;   &lt;/restriction&gt; &lt;/simpleType&gt; </pre>		

### simpleType enum\_0371

namespace	http://xml.ir-d.de/stn		
type	restriction of <b>string</b>		
properties	base xs:string		
facets	Kind	Value	Annotation
	enumeration	0371001	documentation keine
	enumeration	0371002	documentation leicht
	enumeration	0371003	documentation mittel
	enumeration	0371004	documentation schwer
	enumeration	0371099	documentation unbekannt
annotation	documentation Kat_AK_Verkalkungsgrad		
source	<pre> &lt;simpleType name="enum_0371"&gt;   &lt;annotation&gt; </pre>		

	<pre> &lt;documentation&gt;Kat_AK_Verkalkungsgrad&lt;/documentation&gt; &lt;/annotation&gt; &lt;restriction base="xs:string"&gt;   &lt;enumeration value="0371001"&gt;     &lt;annotation&gt;       &lt;documentation&gt;keine&lt;/documentation&gt;     &lt;/annotation&gt;   &lt;/enumeration&gt;   &lt;enumeration value="0371002"&gt;     &lt;annotation&gt;       &lt;documentation&gt;leicht&lt;/documentation&gt;     &lt;/annotation&gt;   &lt;/enumeration&gt;   &lt;enumeration value="0371003"&gt;     &lt;annotation&gt;       &lt;documentation&gt;mittel&lt;/documentation&gt;     &lt;/annotation&gt;   &lt;/enumeration&gt;   &lt;enumeration value="0371004"&gt;     &lt;annotation&gt;       &lt;documentation&gt;schwer&lt;/documentation&gt;     &lt;/annotation&gt;   &lt;/enumeration&gt;   &lt;enumeration value="0371099"&gt;     &lt;annotation&gt;       &lt;documentation&gt;unbekannt&lt;/documentation&gt;     &lt;/annotation&gt;   &lt;/enumeration&gt; &lt;/restriction&gt; &lt;/simpleType&gt; </pre>
--	--

### simpleType enum\_0372

namespace	http://xml.ir-d.de/stn		
type	restriction of <b>string</b>		
properties	base xs:string		
facets	Kind	Value	Annotation
	enumeration	0372001	documentation nein
	enumeration	0372002	documentation ja, bicuspide
	enumeration	0372003	documentation ja, unicuspide
	enumeration	0372099	documentation unbekannt
annotation	documentation Kat_AK_BiUnicuspideKlappe		
source	<pre> &lt;simpleType name="enum_0372"&gt;   &lt;annotation&gt;     &lt;documentation&gt;Kat_AK_BiUnicuspideKlappe&lt;/documentation&gt;   &lt;/annotation&gt;   &lt;restriction base="xs:string"&gt;     &lt;enumeration value="0372001"&gt;       &lt;annotation&gt;         &lt;documentation&gt;nein&lt;/documentation&gt;       &lt;/annotation&gt;     &lt;/enumeration&gt; </pre>		

	<pre> &lt;enumeration value="0372002"&gt;   &lt;annotation&gt;     &lt;documentation&gt;ja, bicuspide&lt;/documentation&gt;   &lt;/annotation&gt; &lt;/enumeration&gt; &lt;enumeration value="0372003"&gt;   &lt;annotation&gt;     &lt;documentation&gt;ja, unicuspide&lt;/documentation&gt;   &lt;/annotation&gt; &lt;/enumeration&gt; &lt;enumeration value="0372099"&gt;   &lt;annotation&gt;     &lt;documentation&gt;unbekannt&lt;/documentation&gt;   &lt;/annotation&gt; &lt;/enumeration&gt; &lt;/restriction&gt; &lt;/simpleType&gt; </pre>
--	---

### simpleType enum 0373

namespace	http://xml.ir-d.de/stn		
type	restriction of <b>string</b>		
properties	base xs:string		
facets	Kind	Value	Annotation
	enumeration	0373001	documentation keine
	enumeration	0373002	documentation leichtgradig
	enumeration	0373003	documentation mittelgradig
	enumeration	0373004	documentation hochgradig
	enumeration	0373099	documentation unbekannt
annotation	documentation Kat_AK_Grad		
source	<pre> &lt;simpleType name="enum_0373"&gt;   &lt;annotation&gt;     &lt;documentation&gt;Kat_AK_Grad&lt;/documentation&gt;   &lt;/annotation&gt;   &lt;restriction base="xs:string"&gt;     &lt;enumeration value="0373001"&gt;       &lt;annotation&gt;         &lt;documentation&gt;keine&lt;/documentation&gt;       &lt;/annotation&gt;     &lt;/enumeration&gt;     &lt;enumeration value="0373002"&gt;       &lt;annotation&gt;         &lt;documentation&gt;leichtgradig&lt;/documentation&gt;       &lt;/annotation&gt;     &lt;/enumeration&gt;     &lt;enumeration value="0373003"&gt;       &lt;annotation&gt;         &lt;documentation&gt;mittelgradig&lt;/documentation&gt;       &lt;/annotation&gt;     &lt;/enumeration&gt;     &lt;enumeration value="0373004"&gt; </pre>		

	<pre> &lt;annotation&gt;   &lt;documentation&gt;hochgradig&lt;/documentation&gt; &lt;/annotation&gt; &lt;/enumeration&gt; &lt;enumeration value="0373099"&gt;   &lt;annotation&gt;     &lt;documentation&gt;unbekannt&lt;/documentation&gt;   &lt;/annotation&gt; &lt;/enumeration&gt; &lt;/restriction&gt; &lt;/simpleType&gt; </pre>
--	--

### simpleType enum\_0374

namespace	http://xml.ir-d.de/stn		
type	restriction of <b>string</b>		
properties	base xs:string		
facets	Kind	Value	Annotation
	enumeration	0374001	documentation nein
	enumeration	0374002	documentation ja, &lt;= 6 Stunden
	enumeration	0374003	documentation ja, &gt; 6 Stunden bis &lt;= 24 Stunden
	enumeration	0374004	documentation ja, &gt; 1 bis 7 Tage
	enumeration	0374005	documentation ja, &gt; 7 bis 21 Tage
	enumeration	0374006	documentation ja, &gt; 21 Tage
	enumeration	0374099	documentation unbekannt
annotation	documentation Kat_AK_InfarktAnamnese		
source	<pre> &lt;simpleType name="enum_0374"&gt;   &lt;annotation&gt;     &lt;documentation&gt;Kat_AK_InfarktAnamnese&lt;/documentation&gt;   &lt;/annotation&gt;   &lt;restriction base="xs:string"&gt;     &lt;enumeration value="0374001"&gt;       &lt;annotation&gt;         &lt;documentation&gt;nein&lt;/documentation&gt;       &lt;/annotation&gt;     &lt;/enumeration&gt;     &lt;enumeration value="0374002"&gt;       &lt;annotation&gt;         &lt;documentation&gt;ja, &amp;lt;= 6 Stunden&lt;/documentation&gt;       &lt;/annotation&gt;     &lt;/enumeration&gt;     &lt;enumeration value="0374003"&gt;       &lt;annotation&gt;         &lt;documentation&gt;ja, &amp;gt; 6 Stunden bis &amp;lt;= 24 Stunden&lt;/documentation&gt;       &lt;/annotation&gt;     &lt;/enumeration&gt;     &lt;enumeration value="0374004"&gt;       &lt;annotation&gt;         &lt;documentation&gt;ja, &amp;gt; 1 bis 7 Tage&lt;/documentation&gt; </pre>		

	<pre> &lt;/annotation&gt; &lt;/enumeration&gt; &lt;enumeration value="0374005"&gt;   &lt;annotation&gt;     &lt;documentation&gt;ja, &amp;gt; 7 bis 21 Tage&lt;/documentation&gt;   &lt;/annotation&gt; &lt;/enumeration&gt; &lt;enumeration value="0374006"&gt;   &lt;annotation&gt;     &lt;documentation&gt;ja, &amp;gt; 21 Tage&lt;/documentation&gt;   &lt;/annotation&gt; &lt;/enumeration&gt; &lt;enumeration value="0374099"&gt;   &lt;annotation&gt;     &lt;documentation&gt;unbekannt&lt;/documentation&gt;   &lt;/annotation&gt; &lt;/enumeration&gt; &lt;/restriction&gt; &lt;/simpleType&gt; </pre>
--	---

### simpleType enum 0375

namespace	http://xml.ir-d.de/stn		
type	restriction of <b>string</b>		
properties	base xs:string		
facets	Kind	Value	Annotation
	enumeration	0375001	documentation keine Symptome oder Angina
	enumeration	0375002	documentation Symptome, aber keine Ischämiezeichen
	enumeration	0375003	documentation stabile Angina
	enumeration	0375004	documentation instabile Angina
	enumeration	0375005	documentation Infarkt ohne ST-Hebung (Non-STEMI)
	enumeration	0375006	documentation Infarkt mit ST-Hebung (STEMI)
	enumeration	0375042	documentation unbekannt
annotation	documentation Kat_AK_KardialeSymptome		
source	<pre> &lt;simpleType name="enum_0375"&gt;   &lt;annotation&gt;     &lt;documentation&gt;Kat_AK_KardialeSymptome&lt;/documentation&gt;   &lt;/annotation&gt;   &lt;restriction base="xs:string"&gt;     &lt;enumeration value="0375001"&gt;       &lt;annotation&gt;         &lt;documentation&gt;keine Symptome oder Angina&lt;/documentation&gt;       &lt;/annotation&gt;     &lt;/enumeration&gt;     &lt;enumeration value="0375002"&gt;       &lt;annotation&gt;         &lt;documentation&gt;Symptome, aber keine Ischämiezeichen&lt;/documentation&gt;       &lt;/annotation&gt;     &lt;/enumeration&gt;   &lt;/restriction&gt; </pre>		

	<pre> &lt;enumeration value="0375003"&gt;   &lt;annotation&gt;     &lt;documentation&gt;stabile Angina&lt;/documentation&gt;   &lt;/annotation&gt; &lt;/enumeration&gt; &lt;enumeration value="0375004"&gt;   &lt;annotation&gt;     &lt;documentation&gt;instabile Angina&lt;/documentation&gt;   &lt;/annotation&gt; &lt;/enumeration&gt; &lt;enumeration value="0375005"&gt;   &lt;annotation&gt;     &lt;documentation&gt;Infarkt ohne ST-Hebung (Non-STEMI)&lt;/documentation&gt;   &lt;/annotation&gt; &lt;/enumeration&gt; &lt;enumeration value="0375006"&gt;   &lt;annotation&gt;     &lt;documentation&gt;Infarkt mit ST-Hebung (STEMI)&lt;/documentation&gt;   &lt;/annotation&gt; &lt;/enumeration&gt; &lt;enumeration value="0375042"&gt;   &lt;annotation&gt;     &lt;documentation&gt;unbekannt&lt;/documentation&gt;   &lt;/annotation&gt; &lt;/enumeration&gt; &lt;/restriction&gt; &lt;/simpleType&gt; </pre>
--	---

### simpleType enum\_0376

namespace	http://xml.ir-d.de/stn		
type	restriction of <b>string</b>		
properties	base xs:string		
facets	Kind	Value	Annotation
	enumeration	0376001	documentation nein
	enumeration	0376002	documentation ja, ZNS, zerebrovaskuläre Blutung
	enumeration	0376003	documentation ja, ZNS, zerebrovaskuläre Ischämie
	enumeration	0376042	documentation ja, ZNS, andere
annotation	documentation Kat_AK_Schlaganfall		
source	<pre> &lt;simpleType name="enum_0376"&gt;   &lt;annotation&gt;     &lt;documentation&gt;Kat_AK_Schlaganfall&lt;/documentation&gt;   &lt;/annotation&gt;   &lt;restriction base="xs:string"&gt;     &lt;enumeration value="0376001"&gt;       &lt;annotation&gt;         &lt;documentation&gt;nein&lt;/documentation&gt;       &lt;/annotation&gt;     &lt;/enumeration&gt;     &lt;enumeration value="0376002"&gt;       &lt;annotation&gt;         &lt;documentation&gt;ja, ZNS, zerebrovaskuläre Blutung&lt;/documentation&gt; </pre>		



	<pre> &lt;/annotation&gt; &lt;/enumeration&gt; &lt;enumeration value="0376003"&gt;   &lt;annotation&gt;     &lt;documentation&gt;ja, ZNS, zerebrovaskuläre Ischämie&lt;/documentation&gt;   &lt;/annotation&gt; &lt;/enumeration&gt; &lt;enumeration value="0376042"&gt;   &lt;annotation&gt;     &lt;documentation&gt;ja, ZNS, andere&lt;/documentation&gt;   &lt;/annotation&gt; &lt;/enumeration&gt; &lt;/restriction&gt; &lt;/simpleType&gt; </pre>
--	---

### simpleType enum\_0377

namespace	http://xml.lir-d.de/stn		
type	restriction of <b>string</b>		
properties	base xs:string		
facets	Kind	Value	Annotation
	enumeration	0377001	documentation ja, mild neurological dysfunction: NIHSS 0-5
	enumeration	0377002	documentation ja, moderate neurological dysfunction: NIHSS 6-14
	enumeration	0377003	documentation ja, severe neurological dysfunction: NIHSS &gt;=15
annotation	documentation Kat_AK_Nihss		
source	<pre> &lt;simpleType name="enum_0377"&gt;   &lt;annotation&gt;     &lt;documentation&gt;Kat_AK_Nihss&lt;/documentation&gt;   &lt;/annotation&gt;   &lt;restriction base="xs:string"&gt;     &lt;enumeration value="0377001"&gt;       &lt;annotation&gt;         &lt;documentation&gt;ja, mild neurological dysfunction: NIHSS 0-5&lt;/documentation&gt;       &lt;/annotation&gt;     &lt;/enumeration&gt;     &lt;enumeration value="0377002"&gt;       &lt;annotation&gt;         &lt;documentation&gt;ja, moderate neurological dysfunction: NIHSS 6-14&lt;/documentation&gt;       &lt;/annotation&gt;     &lt;/enumeration&gt;     &lt;enumeration value="0377003"&gt;       &lt;annotation&gt;         &lt;documentation&gt; ja, severe neurological dysfunction: NIHSS &amp;gt;=15&lt;/documentation&gt;       &lt;/annotation&gt;     &lt;/enumeration&gt;   &lt;/restriction&gt; &lt;/simpleType&gt; </pre>		

### simpleType enum\_0378

namespace	http://xml.ir-d.de/stn		
type	restriction of <b>string</b>		
properties	base xs:string		
facets	Kind	Value	Annotation
	enumeration	0378001	documentation nein
	enumeration	0378002	documentation ja, &lt; 48h gemäss VARC-3-Definition
	enumeration	0378003	documentation ja, &gt;= 48h - &lt;= 72h gemäß VARC-3-Definition
	enumeration	0378004	documentation ja, &gt; 72 h gemäß VARC-3 Definition
annotation	documentation Kat_AK_Myokardinfarkt		
source	<pre> &lt;simpleType name="enum_0378"&gt;   &lt;annotation&gt;     &lt;documentation&gt;Kat_AK_Myokardinfarkt&lt;/documentation&gt;   &lt;/annotation&gt;   &lt;restriction base="xs:string"&gt;     &lt;enumeration value="0378001"&gt;       &lt;annotation&gt;         &lt;documentation&gt;nein&lt;/documentation&gt;       &lt;/annotation&gt;     &lt;/enumeration&gt;     &lt;enumeration value="0378002"&gt;       &lt;annotation&gt;         &lt;documentation&gt;ja, &amp;lt; 48h gemäss VARC-3-Definition&lt;/documentation&gt;       &lt;/annotation&gt;     &lt;/enumeration&gt;     &lt;enumeration value="0378003"&gt;       &lt;annotation&gt;         &lt;documentation&gt;ja, &amp;gt;= 48h - &amp;lt;= 72h gemäß VARC-3-Definition&lt;/documentation&gt;       &lt;/annotation&gt;     &lt;/enumeration&gt;     &lt;enumeration value="0378004"&gt;       &lt;annotation&gt;         &lt;documentation&gt;ja, &amp;gt; 72 h gemäß VARC-3 Definition&lt;/documentation&gt;       &lt;/annotation&gt;     &lt;/enumeration&gt;   &lt;/restriction&gt; &lt;/simpleType&gt; </pre>		

### simpleType enum\_0379

namespace	http://xml.ir-d.de/stn		
type	restriction of <b>string</b>		
properties	base xs:string		
facets	Kind	Value	Annotation
	enumeration	0379001	documentation Keine gefäss- oder zugangsassozierte Komplikationen
	enumeration	0379002	documentation Versagen des perkutanen Verschlusssystems
	enumeration	0379003	documentation Geringfügige Gefäßkomplikationen

	enumeration 0379004 documentation Erhebliche Gefäßkomplikationen
annotation	documentation Kat_AK_ZugangKomplikationen
source	<pre> &lt;simpleType name="enum_0379"&gt;   &lt;annotation&gt;     &lt;documentation&gt;Kat_AK_ZugangKomplikationen&lt;/documentation&gt;   &lt;/annotation&gt;   &lt;restriction base="xs:string"&gt;     &lt;enumeration value="0379001"&gt;       &lt;annotation&gt;         &lt;documentation&gt;Keine gefäss- oder zugangsassoziierte Komplikationen&lt;/documentation&gt;       &lt;/annotation&gt;     &lt;/enumeration&gt;     &lt;enumeration value="0379002"&gt;       &lt;annotation&gt;         &lt;documentation&gt;Versagen des perkutanen Verschlussystems&lt;/documentation&gt;       &lt;/annotation&gt;     &lt;/enumeration&gt;     &lt;enumeration value="0379003"&gt;       &lt;annotation&gt;         &lt;documentation&gt;Geringfügige Gefäßkomplikationen&lt;/documentation&gt;       &lt;/annotation&gt;     &lt;/enumeration&gt;     &lt;enumeration value="0379004"&gt;       &lt;annotation&gt;         &lt;documentation&gt;Erhebliche Gefäßkomplikationen&lt;/documentation&gt;       &lt;/annotation&gt;     &lt;/enumeration&gt;   &lt;/restriction&gt; &lt;/simpleType&gt; </pre>

### simpleType enum\_0380

namespace	http://xml.ir-d.de/stn		
type	restriction of <b>string</b>		
properties	base xs:string		
facets	Kind	Value	Annotation
	enumeration	0380001	documentation nein
	enumeration	0380002	documentation ja, intraprozedural
	enumeration	0380003	documentation ja, postprozedural
	enumeration	0380004	documentation ja, Zeitpunkt nicht bekannt
annotation	documentation Kat_AK_Reanimation		
source	<pre> &lt;simpleType name="enum_0380"&gt;   &lt;annotation&gt;     &lt;documentation&gt;Kat_AK_Reanimation&lt;/documentation&gt;   &lt;/annotation&gt;   &lt;restriction base="xs:string"&gt;     &lt;enumeration value="0380001"&gt;       &lt;annotation&gt; </pre>		

	<pre>       &lt;documentation&gt;nein&lt;/documentation&gt;     &lt;/annotation&gt;   &lt;/enumeration&gt; &lt;enumeration value="0380002"&gt;   &lt;annotation&gt;     &lt;documentation&gt;ja, intraprozedural&lt;/documentation&gt;   &lt;/annotation&gt; &lt;/enumeration&gt; &lt;enumeration value="0380003"&gt;   &lt;annotation&gt;     &lt;documentation&gt;ja, postprozedural&lt;/documentation&gt;   &lt;/annotation&gt; &lt;/enumeration&gt; &lt;enumeration value="0380004"&gt;   &lt;annotation&gt;     &lt;documentation&gt;ja, Zeitpunkt nicht bekannt&lt;/documentation&gt;   &lt;/annotation&gt; &lt;/enumeration&gt; &lt;/restriction&gt; &lt;/simpleType&gt; </pre>
--	--

### simpleType enum\_0381

namespace	http://xml.ir-d.de/stn		
type	restriction of <b>string</b>		
properties	base xs:string		
facets	Kind	Value	Annotation
	enumeration	0381001	documentation nein
	enumeration	0381002	documentation Thorakotomie/Rethorakotomie
	enumeration	0381003	documentation kathetergestützte Reintervention
	enumeration	0381004	documentation lokale Reinterventionen
	enumeration	0381005	documentation andere Reintervention
annotation	documentation Kat_AK_Massnahmen		
source	<pre> &lt;simpleType name="enum_0381"&gt;   &lt;annotation&gt;     &lt;documentation&gt;Kat_AK_Massnahmen&lt;/documentation&gt;   &lt;/annotation&gt;   &lt;restriction base="xs:string"&gt;     &lt;enumeration value="0381001"&gt;       &lt;annotation&gt;         &lt;documentation&gt;nein&lt;/documentation&gt;       &lt;/annotation&gt;     &lt;/enumeration&gt;     &lt;enumeration value="0381002"&gt;       &lt;annotation&gt;         &lt;documentation&gt;Thorakotomie/Rethorakotomie&lt;/documentation&gt;       &lt;/annotation&gt;     &lt;/enumeration&gt;     &lt;enumeration value="0381003"&gt;       &lt;annotation&gt;         &lt;documentation&gt;kathetergestützte Reintervention&lt;/documentation&gt; </pre>		

	<pre> &lt;/annotation&gt; &lt;/enumeration&gt; &lt;enumeration value="0381004"&gt;   &lt;annotation&gt;     &lt;documentation&gt;lokale Reinterventionen&lt;/documentation&gt;   &lt;/annotation&gt; &lt;/enumeration&gt; &lt;enumeration value="0381005"&gt;   &lt;annotation&gt;     &lt;documentation&gt;andere Reintervention&lt;/documentation&gt;   &lt;/annotation&gt; &lt;/enumeration&gt; &lt;/restriction&gt; &lt;/simpleType&gt; </pre>
--	--

### simpleType enum\_0382

namespace	http://xml.ir-d.de/stn		
type	restriction of <b>string</b>		
properties	base xs:string		
facets	Kind	Value	Annotation
	enumeration	0382001	documentation keine Rethorakotomie / kein weiterer Grund
	enumeration	0382002	documentation Blutung/Hämatom
	enumeration	0382003	documentation Low Cardiac Output
	enumeration	0382004	documentation Tamponade
	enumeration	0382005	documentation Graftprobleme, Ischämie
	enumeration	0382006	documentation Wundinfektion, Mediastinitis
	enumeration	0382007	documentation Dissektion
	enumeration	0382008	documentation Prothesendysfunktion
	enumeration	0382009	documentation instabiles Sternum
	enumeration	0382010	documentation Chylothorax
	enumeration	0382011	documentation lokale Revision im Bereich des Zugangsweges
	enumeration	0382042	documentation anderer Grund
annotation	documentation Kat_AK_Komplikation		
source	<pre> &lt;simpleType name="enum_0382"&gt;   &lt;annotation&gt;     &lt;documentation&gt;Kat_AK_Komplikation&lt;/documentation&gt;   &lt;/annotation&gt;   &lt;restriction base="xs:string"&gt;     &lt;enumeration value="0382001"&gt;       &lt;annotation&gt;         &lt;documentation&gt;keine Rethorakotomie / kein weiterer Grund&lt;/documentation&gt;       &lt;/annotation&gt;     &lt;/enumeration&gt; </pre>		

```

<enumeration value="0382002">
  <annotation>
    <documentation>Blutung/Hämatom</documentation>
  </annotation>
</enumeration>
<enumeration value="0382003">
  <annotation>
    <documentation>Low Cardiac Output</documentation>
  </annotation>
</enumeration>
<enumeration value="0382004">
  <annotation>
    <documentation>Tamponade</documentation>
  </annotation>
</enumeration>
<enumeration value="0382005">
  <annotation>
    <documentation>Graftprobleme, Ischämie</documentation>
  </annotation>
</enumeration>
<enumeration value="0382006">
  <annotation>
    <documentation>Wundinfektion, Mediastinitis</documentation>
  </annotation>
</enumeration>
<enumeration value="0382007">
  <annotation>
    <documentation>Dissektion</documentation>
  </annotation>
</enumeration>
<enumeration value="0382008">
  <annotation>
    <documentation>Prothesendysfunktion</documentation>
  </annotation>
</enumeration>
<enumeration value="0382009">
  <annotation>
    <documentation>instabiles Sternum</documentation>
  </annotation>
</enumeration>
<enumeration value="0382010">
  <annotation>
    <documentation>Chylothorax</documentation>
  </annotation>
</enumeration>
<enumeration value="0382011">
  <annotation>
    <documentation>lokale Revision im Bereich des
Zugangsweges</documentation>
  </annotation>
</enumeration>
<enumeration value="0382042">
  <annotation>
    <documentation>anderer Grund</documentation>
  </annotation>
</enumeration>
</restriction>
</simpleType>

```

### simpleType enum\_0383

namespace	http://xml.ir-d.de/stn		
type	restriction of <b>string</b>		
properties	base xs:string		
facets	Kind	Value	Annotation
	enumeration	0383001	documentation nein
	enumeration	0383002	documentation ja, mit forcierter Atemtherapie
	enumeration	0383003	documentation ja, Reintubation oder längerfristige Beatmung
	enumeration	0383004	documentation ja, Tracheotomie
annotation	documentation Kat_AK_RespiratorischeInsuffizienz		
source	<pre> &lt;simpleType name="enum_0383"&gt;   &lt;annotation&gt;     &lt;documentation&gt;Kat_AK_RespiratorischeInsuffizienz&lt;/documentation&gt;   &lt;/annotation&gt;   &lt;restriction base="xs:string"&gt;     &lt;enumeration value="0383001"&gt;       &lt;annotation&gt;         &lt;documentation&gt;nein&lt;/documentation&gt;       &lt;/annotation&gt;     &lt;/enumeration&gt;     &lt;enumeration value="0383002"&gt;       &lt;annotation&gt;         &lt;documentation&gt;ja, mit forcierter Atemtherapie&lt;/documentation&gt;       &lt;/annotation&gt;     &lt;/enumeration&gt;     &lt;enumeration value="0383003"&gt;       &lt;annotation&gt;         &lt;documentation&gt;ja, Reintubation oder längerfristige Beatmung&lt;/documentation&gt;       &lt;/annotation&gt;     &lt;/enumeration&gt;     &lt;enumeration value="0383004"&gt;       &lt;annotation&gt;         &lt;documentation&gt;ja, Tracheotomie&lt;/documentation&gt;       &lt;/annotation&gt;     &lt;/enumeration&gt;   &lt;/restriction&gt; &lt;/simpleType&gt; </pre>		

### simpleType enum\_0384

namespace	http://xml.ir-d.de/stn		
type	restriction of <b>string</b>		
properties	base xs:string		
facets	Kind	Value	Annotation
	enumeration	0384001	documentation keine Blutungskomplikationen
	enumeration	0384002	documentation Geringfügige Blutung (Minor Bleeding - BARC type 2 or 3a)

	<p>enumeration 0384003 documentation Starke Blutung (Major Bleeding - BARC type 3a)</p> <p>enumeration 0384004 documentation Lebensbedrohliche Blutung (Life-threatening or disabling bleeding - BARC type 3b or 3c or type 5)</p>
annotation	documentation Kat_AK_Blutungskomplikation
source	<pre> &lt;simpleType name="enum_0384"&gt;   &lt;annotation&gt;     &lt;documentation&gt;Kat_AK_Blutungskomplikation&lt;/documentation&gt;   &lt;/annotation&gt;   &lt;restriction base="xs:string"&gt;     &lt;enumeration value="0384001"&gt;       &lt;annotation&gt;         &lt;documentation&gt;keine Blutungskomplikationen&lt;/documentation&gt;       &lt;/annotation&gt;     &lt;/enumeration&gt;     &lt;enumeration value="0384002"&gt;       &lt;annotation&gt;         &lt;documentation&gt;Geringfügige Blutung (Minor Bleeding - BARC type 2 or 3a)&lt;/documentation&gt;       &lt;/annotation&gt;     &lt;/enumeration&gt;     &lt;enumeration value="0384003"&gt;       &lt;annotation&gt;         &lt;documentation&gt;Starke Blutung (Major Bleeding - BARC type 3a)&lt;/documentation&gt;       &lt;/annotation&gt;     &lt;/enumeration&gt;     &lt;enumeration value="0384004"&gt;       &lt;annotation&gt;         &lt;documentation&gt;Lebensbedrohliche Blutung (Life-threatening or disabling bleeding - BARC type 3b or 3c or type 5)&lt;/documentation&gt;       &lt;/annotation&gt;     &lt;/enumeration&gt;   &lt;/restriction&gt; &lt;/simpleType&gt; </pre>

### simpleType enum\_0385

namespace	http://xml.ir-d.de/stn		
type	restriction of <b>string</b>		
properties	base xs:string		
facets	Kind	Value	Annotation
	enumeration	0385001	documentation Sinusrhythmus
	enumeration	0385002	documentation Vorhofflimmern
	enumeration	0385003	documentation Patient verstorben (kein Herzrhythmus)
	enumeration	0385042	documentation anderer Rhythmus
annotation	documentation Kat_AK_HerzrhythmusEntlassung		
source	<pre> &lt;simpleType name="enum_0385"&gt;   &lt;annotation&gt;     &lt;documentation&gt;Kat_AK_HerzrhythmusEntlassung&lt;/documentation&gt; </pre>		



	<pre> &lt;/annotation&gt; &lt;restriction base="xs:string"&gt;   &lt;enumeration value="0385001"&gt;     &lt;annotation&gt;       &lt;documentation&gt;Sinusrhythmus&lt;/documentation&gt;     &lt;/annotation&gt;   &lt;/enumeration&gt;   &lt;enumeration value="0385002"&gt;     &lt;annotation&gt;       &lt;documentation&gt;Vorhofflimmern&lt;/documentation&gt;     &lt;/annotation&gt;   &lt;/enumeration&gt;   &lt;enumeration value="0385003"&gt;     &lt;annotation&gt;       &lt;documentation&gt;Patient verstorben (kein Herzrhythmus)&lt;/documentation&gt;     &lt;/annotation&gt;   &lt;/enumeration&gt;   &lt;enumeration value="0385042"&gt;     &lt;annotation&gt;       &lt;documentation&gt;anderer Rhythmus&lt;/documentation&gt;     &lt;/annotation&gt;   &lt;/enumeration&gt; &lt;/restriction&gt; &lt;/simpleType&gt; </pre>
--	---

### simpleType enum\_0388

namespace	http://xml.ir-d.de/stn		
type	restriction of <b>string</b>		
properties	base xs:string		
facets	Kind	Value	Annotation
	enumeration	0388001	documentation nein
	enumeration	0388002	documentation ASS
	enumeration	0388003	documentation ADP-Rezeptor-Antagonist
	enumeration	0388004	documentation Kombination ASS und ADP-Rezeptor-Antagonist
	enumeration	0388042	documentation ja, andere
	enumeration	0388099	documentation unbekannt
annotation	documentation Kat_AK_Plaettchenaggregationshemmer		
source	<pre> &lt;simpleType name="enum_0388"&gt;   &lt;annotation&gt;     &lt;documentation&gt;Kat_AK_Plaettchenaggregationshemmer&lt;/documentation&gt;   &lt;/annotation&gt;   &lt;restriction base="xs:string"&gt;     &lt;enumeration value="0388001"&gt;       &lt;annotation&gt;         &lt;documentation&gt;nein&lt;/documentation&gt;       &lt;/annotation&gt;     &lt;/enumeration&gt;     &lt;enumeration value="0388002"&gt;       &lt;annotation&gt; </pre>		

	<pre> &lt;documentation&gt;ASS&lt;/documentation&gt; &lt;/annotation&gt; &lt;/enumeration&gt; &lt;enumeration value="0388003"&gt;   &lt;annotation&gt;     &lt;documentation&gt;ADP-Rezeptor-Antagonist&lt;/documentation&gt;   &lt;/annotation&gt; &lt;/enumeration&gt; &lt;enumeration value="0388004"&gt;   &lt;annotation&gt;     &lt;documentation&gt;Kombination ASS und ADP-Rezeptor-Antagonist&lt;/documentation&gt;   &lt;/annotation&gt; &lt;/enumeration&gt; &lt;enumeration value="0388042"&gt;   &lt;annotation&gt;     &lt;documentation&gt;ja, andere&lt;/documentation&gt;   &lt;/annotation&gt; &lt;/enumeration&gt; &lt;enumeration value="0388099"&gt;   &lt;annotation&gt;     &lt;documentation&gt;unbekannt&lt;/documentation&gt;   &lt;/annotation&gt; &lt;/enumeration&gt; &lt;/restriction&gt; &lt;/simpleType&gt; </pre>
--	--

### simpleType enum\_0389

namespace	http://xml.ir-d.de/stn		
type	restriction of <b>string</b>		
properties	base xs:string		
facets	Kind	Value	Annotation
	enumeration	0389001	documentation nein
	enumeration	0389002	documentation Cumarin-Derivate
	enumeration	0389003	documentation Heparinoide
	enumeration	0389004	documentation orale Thrombinantagonisten
	enumeration	0389005	documentation Kombination Heparinoide und Cumarin-Derivate
	enumeration	0389006	documentation Direkte orale Antikoagulantien (DOAK / NOAK)
	enumeration	0389042	documentation ja, andere
	enumeration	0389099	documentation unbekannt
annotation	documentation Kat AK Antikoagulantien		
source	<pre> &lt;simpleType name="enum_0389"&gt;   &lt;annotation&gt;     &lt;documentation&gt;Kat_AK_Antikoagulantien&lt;/documentation&gt;   &lt;/annotation&gt;   &lt;restriction base="xs:string"&gt;     &lt;enumeration value="0389001"&gt;       &lt;annotation&gt; </pre>		

```

        <documentation>nein</documentation>
    </annotation>
</enumeration>
<enumeration value="0389002">
    <annotation>
        <documentation>Cumarin-Derivate</documentation>
    </annotation>
</enumeration>
<enumeration value="0389003">
    <annotation>
        <documentation>Heparinoide</documentation>
    </annotation>
</enumeration>
<enumeration value="0389004">
    <annotation>
        <documentation>orale Thrombinantagonisten</documentation>
    </annotation>
</enumeration>
<enumeration value="0389005">
    <annotation>
        <documentation>Kombination Heparinoide und
Cumarin-Derivate</documentation>
    </annotation>
</enumeration>
<enumeration value="0389006">
    <annotation>
        <documentation>Direkte orale Antikoagulantien (DOAK /
NOAK)</documentation>
    </annotation>
</enumeration>
<enumeration value="0389042">
    <annotation>
        <documentation>ja, andere</documentation>
    </annotation>
</enumeration>
<enumeration value="0389099">
    <annotation>
        <documentation>unbekannt</documentation>
    </annotation>
</enumeration>
</restriction>
</simpleType>

```

simpleType **enum\_0390**

namespace	http://xml.ir-d.de/stn		
type	restriction of <b>string</b>		
properties	base xs:string		
facets	Kind	Value	Annotation
	enumeration	0390001	documentation biologisches Klappenmodell
	enumeration	0390002	documentation mechanisches Klappenmodell
annotation	documentation Kat_AK_Artikeltyp		
source	<simpleType name="enum_0390"> <annotation>		

	<pre> &lt;documentation&gt;Kat_AK_Artikeltyp&lt;/documentation&gt; &lt;/annotation&gt; &lt;restriction base="xs:string"&gt;   &lt;enumeration value="0390001"&gt;     &lt;annotation&gt;       &lt;documentation&gt;biologisches Klappenmodell&lt;/documentation&gt;     &lt;/annotation&gt;   &lt;/enumeration&gt;   &lt;enumeration value="0390002"&gt;     &lt;annotation&gt;       &lt;documentation&gt;mechanisches Klappenmodell&lt;/documentation&gt;     &lt;/annotation&gt;   &lt;/enumeration&gt; &lt;/restriction&gt; &lt;/simpleType&gt; </pre>
--	---

### simpleType enum 0398

namespace	http://xml.ir-d.de/stn		
type	restriction of <b>string</b>		
properties	base xs:string		
facets	Kind	Value	Annotation
	enumeration	0398001	documentation kardiovaskuläre Ursache
	enumeration	0398002	documentation nicht-kardiovaskuläre Ursache
	enumeration	0398099	documentation Todesursache unbekannt
annotation	documentation Kat_AK_Todesursache		
source	<pre> &lt;simpleType name="enum_0398"&gt;   &lt;annotation&gt;     &lt;documentation&gt;Kat_AK_Todesursache&lt;/documentation&gt;   &lt;/annotation&gt;   &lt;restriction base="xs:string"&gt;     &lt;enumeration value="0398001"&gt;       &lt;annotation&gt;         &lt;documentation&gt;kardiovaskuläre Ursache&lt;/documentation&gt;       &lt;/annotation&gt;     &lt;/enumeration&gt;     &lt;enumeration value="0398002"&gt;       &lt;annotation&gt;         &lt;documentation&gt;nicht-kardiovaskuläre Ursache&lt;/documentation&gt;       &lt;/annotation&gt;     &lt;/enumeration&gt;     &lt;enumeration value="0398099"&gt;       &lt;annotation&gt;         &lt;documentation&gt;Todesursache unbekannt&lt;/documentation&gt;       &lt;/annotation&gt;     &lt;/enumeration&gt;   &lt;/restriction&gt; &lt;/simpleType&gt; </pre>		

### simpleType enum\_0399

namespace	http://xml.ir-d.de/stn		
type	restriction of <b>string</b>		
properties	base xs:string		
facets	Kind	Value	Annotation
	enumeration	0399001	documentation Patient lebt
	enumeration	0399002	documentation Patient im Krankenhaus verstorben
annotation	documentation Kat_AK_Vitalstatus		
source	<pre> &lt;simpleType name="enum_0399"&gt;   &lt;annotation&gt;     &lt;documentation&gt;Kat_AK_Vitalstatus&lt;/documentation&gt;   &lt;/annotation&gt;   &lt;restriction base="xs:string"&gt;     &lt;enumeration value="0399001"&gt;       &lt;annotation&gt;         &lt;documentation&gt;Patient lebt&lt;/documentation&gt;       &lt;/annotation&gt;     &lt;/enumeration&gt;     &lt;enumeration value="0399002"&gt;       &lt;annotation&gt;         &lt;documentation&gt;Patient im Krankenhaus verstorben&lt;/documentation&gt;       &lt;/annotation&gt;     &lt;/enumeration&gt;   &lt;/restriction&gt; &lt;/simpleType&gt; </pre>		

### simpleType enum\_0044

namespace	http://xml.ir-d.de/irdma		
type	restriction of <b>string</b>		
properties	base xs:string		
facets	Kind	Value	Annotation
	enumeration	0044001	documentation 1= normaler, sonst gesunder Patient
	enumeration	0044002	documentation 2= Patient mit leichter Allgemeinerkrankung
	enumeration	0044003	documentation 3= Patient mit schwerer Allgemeinerkrankung
	enumeration	0044004	documentation 4= Patient mit schwerer Allgemeinerkrankung, die eine ständige Lebensbedrohung darstellt
	enumeration	0044005	documentation 5= moribunder Patient, der ohne die Operation voraussichtlich nicht überleben wird
annotation	documentation Kat_ASA		
source	<pre> &lt;simpleType name="enum_0044"&gt;   &lt;annotation&gt;     &lt;documentation&gt;Kat_ASA&lt;/documentation&gt;   &lt;/annotation&gt;   &lt;restriction base="xs:string"&gt;     &lt;enumeration value="0044001"&gt;       &lt;annotation&gt; </pre>		

	<pre>       &lt;documentation&gt;1= normaler, sonst gesunder Patient&lt;/documentation&gt;     &lt;/annotation&gt;   &lt;/enumeration&gt;   &lt;enumeration value="0044002"&gt;     &lt;annotation&gt;       &lt;documentation&gt;2= Patient mit leichter Allgemeinerkrankung&lt;/documentation&gt;     &lt;/annotation&gt;   &lt;/enumeration&gt;   &lt;enumeration value="0044003"&gt;     &lt;annotation&gt;       &lt;documentation&gt;3= Patient mit schwerer Allgemeinerkrankung&lt;/documentation&gt;     &lt;/annotation&gt;   &lt;/enumeration&gt;   &lt;enumeration value="0044004"&gt;     &lt;annotation&gt;       &lt;documentation&gt;4= Patient mit schwerer Allgemeinerkrankung, die eine ständige Lebensbedrohung darstellt&lt;/documentation&gt;     &lt;/annotation&gt;   &lt;/enumeration&gt;   &lt;enumeration value="0044005"&gt;     &lt;annotation&gt;       &lt;documentation&gt;5= moribunder Patient, der ohne die Operation voraussichtlich nicht überleben wird&lt;/documentation&gt;     &lt;/annotation&gt;   &lt;/enumeration&gt; &lt;/restriction&gt; &lt;/simpleType&gt; </pre>
--	---

### simpleType enum\_0050

namespace	http://xml.ir-d.de/irdma		
type	restriction of <b>string</b>		
properties	base xs:string		
facets	Kind	Value	Annotation
	enumeration	0050001	documentation rechts
	enumeration	0050002	documentation links
annotation	documentation Kat_RechtsLinks		
source	<pre> &lt;simpleType name="enum_0050"&gt;   &lt;annotation&gt;     &lt;documentation&gt;Kat_RechtsLinks&lt;/documentation&gt;   &lt;/annotation&gt;   &lt;restriction base="xs:string"&gt;     &lt;enumeration value="0050001"&gt;       &lt;annotation&gt;         &lt;documentation&gt;rechts&lt;/documentation&gt;       &lt;/annotation&gt;     &lt;/enumeration&gt;     &lt;enumeration value="0050002"&gt;       &lt;annotation&gt;         &lt;documentation&gt;links&lt;/documentation&gt;       &lt;/annotation&gt;     &lt;/enumeration&gt;   &lt;/restriction&gt; &lt;/simpleType&gt; </pre>		

	<pre> &lt;/restriction&gt; &lt;/simpleType&gt; </pre>
--	---

### simpleType enum\_0060

namespace	http://xml.ir-d.de/irdma		
type	restriction of <b>string</b>		
properties	base xs:string		
facets	Kind	Value	Annotation
	enumeration	0060001	documentation ja
	enumeration	0060002	documentation nein
annotation	documentation Kat_JaNein		
source	<pre> &lt;simpleType name="enum_0060"&gt;   &lt;annotation&gt;     &lt;documentation&gt;Kat_JaNein&lt;/documentation&gt;   &lt;/annotation&gt;   &lt;restriction base="xs:string"&gt;     &lt;enumeration value="0060001"&gt;       &lt;annotation&gt;         &lt;documentation&gt;ja&lt;/documentation&gt;       &lt;/annotation&gt;     &lt;/enumeration&gt;     &lt;enumeration value="0060002"&gt;       &lt;annotation&gt;         &lt;documentation&gt;nein&lt;/documentation&gt;       &lt;/annotation&gt;     &lt;/enumeration&gt;   &lt;/restriction&gt; &lt;/simpleType&gt; </pre>		

### simpleType enum\_0061

namespace	http://xml.ir-d.de/irdma		
type	restriction of <b>string</b>		
properties	base xs:string		
facets	Kind	Value	Annotation
	enumeration	0061001	documentation ja
	enumeration	0061002	documentation nein
	enumeration	0061099	documentation unbekannt
annotation	documentation Kat_JaNeinUnbekannt		
source	<pre> &lt;simpleType name="enum_0061"&gt;   &lt;annotation&gt;     &lt;documentation&gt;Kat_JaNeinUnbekannt&lt;/documentation&gt;   &lt;/annotation&gt;   &lt;restriction base="xs:string"&gt;     &lt;enumeration value="0061001"&gt;       &lt;annotation&gt; </pre>		

	<pre>         &lt;documentation&gt;ja&lt;/documentation&gt;       &lt;/annotation&gt;     &lt;/enumeration&gt;     &lt;enumeration value="0061002"&gt;       &lt;annotation&gt;         &lt;documentation&gt;nein&lt;/documentation&gt;       &lt;/annotation&gt;     &lt;/enumeration&gt;     &lt;enumeration value="0061099"&gt;       &lt;annotation&gt;         &lt;documentation&gt;unbekannt&lt;/documentation&gt;       &lt;/annotation&gt;     &lt;/enumeration&gt;   &lt;/restriction&gt; &lt;/simpleType&gt; </pre>
--	---

### simpleType enum\_0062

namespace	http://xml.ir-d.de/irdma		
type	restriction of <b>string</b>		
properties	base xs:string		
facets	Kind	Value	Annotation
	enumeration	0062001	documentation Stück
	enumeration	0062002	documentation g
	enumeration	0062003	documentation mg
	enumeration	0062004	documentation l
	enumeration	0062005	documentation ml
	enumeration	0062006	documentation cm <sup>3</sup>
	enumeration	0062007	documentation mm
	enumeration	0062008	documentation cm
	enumeration	0062009	documentation dm
	enumeration	0062010	documentation m
	enumeration	0062042	documentation andere
annotation	documentation Kat Einheit		
source	<pre> &lt;simpleType name="enum_0062"&gt;   &lt;annotation&gt;     &lt;documentation&gt;Kat_Einheit&lt;/documentation&gt;   &lt;/annotation&gt;   &lt;restriction base="xs:string"&gt;     &lt;enumeration value="0062001"&gt;       &lt;annotation&gt;         &lt;documentation&gt;Stück&lt;/documentation&gt;       &lt;/annotation&gt;     &lt;/enumeration&gt;     &lt;enumeration value="0062002"&gt;       &lt;annotation&gt; </pre>		



```

    <documentation>g</documentation>
  </annotation>
</enumeration>
<enumeration value="0062003">
  <annotation>
    <documentation>mg</documentation>
  </annotation>
</enumeration>
<enumeration value="0062004">
  <annotation>
    <documentation>l</documentation>
  </annotation>
</enumeration>
<enumeration value="0062005">
  <annotation>
    <documentation>ml</documentation>
  </annotation>
</enumeration>
<enumeration value="0062006">
  <annotation>
    <documentation>cm3</documentation>
  </annotation>
</enumeration>
<enumeration value="0062007">
  <annotation>
    <documentation>mm</documentation>
  </annotation>
</enumeration>
<enumeration value="0062008">
  <annotation>
    <documentation>cm</documentation>
  </annotation>
</enumeration>
<enumeration value="0062009">
  <annotation>
    <documentation>dm</documentation>
  </annotation>
</enumeration>
<enumeration value="0062010">
  <annotation>
    <documentation>m</documentation>
  </annotation>
</enumeration>
<enumeration value="0062042">
  <annotation>
    <documentation>andere</documentation>
  </annotation>
</enumeration>
</restriction>
</simpleType>

```

#### simpleType enum\_0065

namespace	http://xml.ir-d.de/irdma
type	restriction of <b>string</b>
properties	base xs:string

facets	<table border="1"> <thead> <tr> <th>Kind</th> <th>Value</th> <th>Annotation</th> </tr> </thead> <tbody> <tr> <td>enumeration</td> <td>0065001</td> <td>documentation stationär</td> </tr> <tr> <td>enumeration</td> <td>0065002</td> <td>documentation teilstationär</td> </tr> <tr> <td>enumeration</td> <td>0065003</td> <td>documentation ambulanz</td> </tr> </tbody> </table>	Kind	Value	Annotation	enumeration	0065001	documentation stationär	enumeration	0065002	documentation teilstationär	enumeration	0065003	documentation ambulanz
Kind	Value	Annotation											
enumeration	0065001	documentation stationär											
enumeration	0065002	documentation teilstationär											
enumeration	0065003	documentation ambulanz											
annotation	documentation Kat_ArtAufenthalt												
source	<pre>&lt;simpleType name="enum_0065"&gt;   &lt;annotation&gt;     &lt;documentation&gt;Kat_ArtAufenthalt&lt;/documentation&gt;   &lt;/annotation&gt;   &lt;restriction base="xs:string"&gt;     &lt;enumeration value="0065001"&gt;       &lt;annotation&gt;         &lt;documentation&gt;stationär&lt;/documentation&gt;       &lt;/annotation&gt;     &lt;/enumeration&gt;     &lt;enumeration value="0065002"&gt;       &lt;annotation&gt;         &lt;documentation&gt;teilstationär&lt;/documentation&gt;       &lt;/annotation&gt;     &lt;/enumeration&gt;     &lt;enumeration value="0065003"&gt;       &lt;annotation&gt;         &lt;documentation&gt;ambulanz&lt;/documentation&gt;       &lt;/annotation&gt;     &lt;/enumeration&gt;   &lt;/restriction&gt; &lt;/simpleType&gt;</pre>												

### simpleType enum\_0067

namespace	http://xml.ir-d.de/irdma									
type	restriction of <b>string</b>									
properties	base xs:string									
facets	<table border="1"> <thead> <tr> <th>Kind</th> <th>Value</th> <th>Annotation</th> </tr> </thead> <tbody> <tr> <td>enumeration</td> <td>0067001</td> <td>documentation Implantat</td> </tr> <tr> <td>enumeration</td> <td>0067002</td> <td>documentation Explantat</td> </tr> </tbody> </table>	Kind	Value	Annotation	enumeration	0067001	documentation Implantat	enumeration	0067002	documentation Explantat
Kind	Value	Annotation								
enumeration	0067001	documentation Implantat								
enumeration	0067002	documentation Explantat								
annotation	documentation Kat_ArtArtikel									
source	<pre>&lt;simpleType name="enum_0067"&gt;   &lt;annotation&gt;     &lt;documentation&gt;Kat_ArtArtikel&lt;/documentation&gt;   &lt;/annotation&gt;   &lt;restriction base="xs:string"&gt;     &lt;enumeration value="0067001"&gt;       &lt;annotation&gt;         &lt;documentation&gt;Implantat&lt;/documentation&gt;       &lt;/annotation&gt;     &lt;/enumeration&gt;     &lt;enumeration value="0067002"&gt;       &lt;annotation&gt;         &lt;documentation&gt;Explantat&lt;/documentation&gt;       &lt;/annotation&gt;     &lt;/enumeration&gt;   &lt;/restriction&gt; &lt;/simpleType&gt;</pre>									

	<pre> &lt;/annotation&gt; &lt;/enumeration&gt; &lt;/restriction&gt; &lt;/simpleType&gt; </pre>
--	--

### simpleType enum\_0068

namespace	http://xml.ir-d.de/irdma		
type	restriction of <b>string</b>		
properties	base xs:string		
facets	Kind	Value	Annotation
	enumeration	0068001	documentation UDI
	enumeration	0068002	documentation Referenz (REF)
	enumeration	0068003	documentation Katalognummer
	enumeration	0068042	documentation sonstiger
annotation	documentation Kat_KennzeichenTyp		
source	<pre> &lt;simpleType name="enum_0068"&gt;   &lt;annotation&gt;     &lt;documentation&gt;Kat_KennzeichenTyp&lt;/documentation&gt;   &lt;/annotation&gt;   &lt;restriction base="xs:string"&gt;     &lt;enumeration value="0068001"&gt;       &lt;annotation&gt;         &lt;documentation&gt;UDI&lt;/documentation&gt;       &lt;/annotation&gt;     &lt;/enumeration&gt;     &lt;enumeration value="0068002"&gt;       &lt;annotation&gt;         &lt;documentation&gt;Referenz (REF)&lt;/documentation&gt;       &lt;/annotation&gt;     &lt;/enumeration&gt;     &lt;enumeration value="0068003"&gt;       &lt;annotation&gt;         &lt;documentation&gt;Katalognummer&lt;/documentation&gt;       &lt;/annotation&gt;     &lt;/enumeration&gt;     &lt;enumeration value="0068042"&gt;       &lt;annotation&gt;         &lt;documentation&gt;sonstiger&lt;/documentation&gt;       &lt;/annotation&gt;     &lt;/enumeration&gt;   &lt;/restriction&gt; &lt;/simpleType&gt; </pre>		

### simpleType enum\_0069

namespace	http://xml.ir-d.de/irdma		
type	restriction of <b>string</b>		
properties	base xs:string		

facets	<table border="1"> <thead> <tr> <th>Kind</th> <th>Value</th> <th>Annotation</th> </tr> </thead> <tbody> <tr> <td>enumeration</td> <td>0069001</td> <td>documentation Implantat</td> </tr> <tr> <td>enumeration</td> <td>0069002</td> <td>documentation Explantat</td> </tr> </tbody> </table>	Kind	Value	Annotation	enumeration	0069001	documentation Implantat	enumeration	0069002	documentation Explantat
Kind	Value	Annotation								
enumeration	0069001	documentation Implantat								
enumeration	0069002	documentation Explantat								
annotation	documentation Kat_ArtZubehoer									
source	<pre> &lt;simpleType name="enum_0069"&gt;   &lt;annotation&gt;     &lt;documentation&gt;Kat_ArtZubehoer&lt;/documentation&gt;   &lt;/annotation&gt;   &lt;restriction base="xs:string"&gt;     &lt;enumeration value="0069001"&gt;       &lt;annotation&gt;         &lt;documentation&gt;Implantat&lt;/documentation&gt;       &lt;/annotation&gt;     &lt;/enumeration&gt;     &lt;enumeration value="0069002"&gt;       &lt;annotation&gt;         &lt;documentation&gt;Explantat&lt;/documentation&gt;       &lt;/annotation&gt;     &lt;/enumeration&gt;   &lt;/restriction&gt; &lt;/simpleType&gt; </pre>									

### simpleType enum\_0070

namespace	http://xml.ir-d.de/irdma															
type	restriction of <b>string</b>															
properties	base xs:string															
facets	<table border="1"> <thead> <tr> <th>Kind</th> <th>Value</th> <th>Annotation</th> </tr> </thead> <tbody> <tr> <td>enumeration</td> <td>0070001</td> <td>documentation weiblich</td> </tr> <tr> <td>enumeration</td> <td>0070002</td> <td>documentation männlich</td> </tr> <tr> <td>enumeration</td> <td>0070003</td> <td>documentation divers</td> </tr> <tr> <td>enumeration</td> <td>0070042</td> <td>documentation unbestimmt</td> </tr> </tbody> </table>	Kind	Value	Annotation	enumeration	0070001	documentation weiblich	enumeration	0070002	documentation männlich	enumeration	0070003	documentation divers	enumeration	0070042	documentation unbestimmt
Kind	Value	Annotation														
enumeration	0070001	documentation weiblich														
enumeration	0070002	documentation männlich														
enumeration	0070003	documentation divers														
enumeration	0070042	documentation unbestimmt														
annotation	documentation Kat_Geschlecht															
source	<pre> &lt;simpleType name="enum_0070"&gt;   &lt;annotation&gt;     &lt;documentation&gt;Kat_Geschlecht&lt;/documentation&gt;   &lt;/annotation&gt;   &lt;restriction base="xs:string"&gt;     &lt;enumeration value="0070001"&gt;       &lt;annotation&gt;         &lt;documentation&gt;weiblich&lt;/documentation&gt;       &lt;/annotation&gt;     &lt;/enumeration&gt;     &lt;enumeration value="0070002"&gt;       &lt;annotation&gt;         &lt;documentation&gt;männlich&lt;/documentation&gt;       &lt;/annotation&gt;     &lt;/enumeration&gt;     &lt;enumeration value="0070003"&gt; </pre>															

	<pre> &lt;annotation&gt;   &lt;documentation&gt;divers&lt;/documentation&gt; &lt;/annotation&gt; &lt;/enumeration&gt; &lt;enumeration value="0070042"&gt;   &lt;annotation&gt;     &lt;documentation&gt;unbestimmt&lt;/documentation&gt;   &lt;/annotation&gt; &lt;/enumeration&gt; &lt;/restriction&gt; &lt;/simpleType&gt; </pre>
--	---

### simpleType enum\_0071

namespace	http://xml.ir-d.de/irdma		
type	restriction of <b>string</b>		
properties	base xs:string		
facets	Kind	Value	Annotation
	enumeration	0071001	documentation Implantat
	enumeration	0071002	documentation Explantat
	enumeration	0071003	documentation Degeneriertes/defektes Produkt, das funktionslos im Körper verbleibt
annotation	documentation Kat_ArtikelArtFunktion		
source	<pre> &lt;simpleType name="enum_0071"&gt;   &lt;annotation&gt;     &lt;documentation&gt;Kat_ArtikelArtFunktion&lt;/documentation&gt;   &lt;/annotation&gt;   &lt;restriction base="xs:string"&gt;     &lt;enumeration value="0071001"&gt;       &lt;annotation&gt;         &lt;documentation&gt;Implantat&lt;/documentation&gt;       &lt;/annotation&gt;     &lt;/enumeration&gt;     &lt;enumeration value="0071002"&gt;       &lt;annotation&gt;         &lt;documentation&gt;Explantat&lt;/documentation&gt;       &lt;/annotation&gt;     &lt;/enumeration&gt;     &lt;enumeration value="0071003"&gt;       &lt;annotation&gt;         &lt;documentation&gt;Degeneriertes/defektes Produkt, das funktionslos im         Körper verbleibt&lt;/documentation&gt;       &lt;/annotation&gt;     &lt;/enumeration&gt;   &lt;/restriction&gt; &lt;/simpleType&gt; </pre>		

### simpleType enum\_0075

namespace	http://xml.ir-d.de/irdma
type	restriction of <b>string</b>

properties	base xs:string												
facets	<table border="1"> <thead> <tr> <th>Kind</th> <th>Value</th> <th>Annotation</th> </tr> </thead> <tbody> <tr> <td>enumeration</td> <td>0075001</td> <td>documentation elektiv</td> </tr> <tr> <td>enumeration</td> <td>0075002</td> <td>documentation dringlich</td> </tr> <tr> <td>enumeration</td> <td>0075003</td> <td>documentation Notfall</td> </tr> </tbody> </table>	Kind	Value	Annotation	enumeration	0075001	documentation elektiv	enumeration	0075002	documentation dringlich	enumeration	0075003	documentation Notfall
Kind	Value	Annotation											
enumeration	0075001	documentation elektiv											
enumeration	0075002	documentation dringlich											
enumeration	0075003	documentation Notfall											
annotation	documentation Kat_Dringlichkeit												
source	<pre> &lt;simpleType name="enum_0075"&gt;   &lt;annotation&gt;     &lt;documentation&gt;Kat_Dringlichkeit&lt;/documentation&gt;   &lt;/annotation&gt;   &lt;restriction base="xs:string"&gt;     &lt;enumeration value="0075001"&gt;       &lt;annotation&gt;         &lt;documentation&gt;elektiv&lt;/documentation&gt;       &lt;/annotation&gt;     &lt;/enumeration&gt;     &lt;enumeration value="0075002"&gt;       &lt;annotation&gt;         &lt;documentation&gt;dringlich&lt;/documentation&gt;       &lt;/annotation&gt;     &lt;/enumeration&gt;     &lt;enumeration value="0075003"&gt;       &lt;annotation&gt;         &lt;documentation&gt;Notfall&lt;/documentation&gt;       &lt;/annotation&gt;     &lt;/enumeration&gt;   &lt;/restriction&gt; &lt;/simpleType&gt; </pre>												

### simpleType enum\_0076

namespace	http://xml.ir-d.de/irdma															
type	restriction of <b>string</b>															
properties	base xs:string															
facets	<table border="1"> <thead> <tr> <th>Kind</th> <th>Value</th> <th>Annotation</th> </tr> </thead> <tbody> <tr> <td>enumeration</td> <td>0076001</td> <td>documentation elektiv</td> </tr> <tr> <td>enumeration</td> <td>0076002</td> <td>documentation dringlich</td> </tr> <tr> <td>enumeration</td> <td>0076003</td> <td>documentation Notfall</td> </tr> <tr> <td>enumeration</td> <td>0076004</td> <td>documentation Notfall (Reanimation / ultima ratio)</td> </tr> </tbody> </table>	Kind	Value	Annotation	enumeration	0076001	documentation elektiv	enumeration	0076002	documentation dringlich	enumeration	0076003	documentation Notfall	enumeration	0076004	documentation Notfall (Reanimation / ultima ratio)
Kind	Value	Annotation														
enumeration	0076001	documentation elektiv														
enumeration	0076002	documentation dringlich														
enumeration	0076003	documentation Notfall														
enumeration	0076004	documentation Notfall (Reanimation / ultima ratio)														
annotation	documentation Kat_Dringlichkeit_Reanimation															
source	<pre> &lt;simpleType name="enum_0076"&gt;   &lt;annotation&gt;     &lt;documentation&gt;Kat_Dringlichkeit_Reanimation&lt;/documentation&gt;   &lt;/annotation&gt;   &lt;restriction base="xs:string"&gt;     &lt;enumeration value="0076001"&gt;       &lt;annotation&gt;         &lt;documentation&gt;elektiv&lt;/documentation&gt;       &lt;/annotation&gt;     &lt;/enumeration&gt;   &lt;/restriction&gt; &lt;/simpleType&gt; </pre>															

	<pre> &lt;/annotation&gt; &lt;/enumeration&gt; &lt;enumeration value="0076002"&gt;   &lt;annotation&gt;     &lt;documentation&gt;dringlich&lt;/documentation&gt;   &lt;/annotation&gt; &lt;/enumeration&gt; &lt;enumeration value="0076003"&gt;   &lt;annotation&gt;     &lt;documentation&gt;Notfall&lt;/documentation&gt;   &lt;/annotation&gt; &lt;/enumeration&gt; &lt;enumeration value="0076004"&gt;   &lt;annotation&gt;     &lt;documentation&gt;Notfall (Reanimation / ultima ratio)&lt;/documentation&gt;   &lt;/annotation&gt; &lt;/enumeration&gt; &lt;/restriction&gt; &lt;/simpleType&gt; </pre>
--	--

### simpleType enum\_0080

namespace	http://xml.ir-d.de/irdma		
type	restriction of <b>string</b>		
properties	base xs:string		
facets	Kind	Value	Annotation
	enumeration	0080001	documentation Endoprothese Hüfte/Knie
	enumeration	0080002	documentation Brustimplantat
	enumeration	0080003	documentation Aortenklappenprothese
annotation	documentation Kat_Implantattyp		
source	<pre> &lt;simpleType name="enum_0080"&gt;   &lt;annotation&gt;     &lt;documentation&gt;Kat_Implantattyp&lt;/documentation&gt;   &lt;/annotation&gt;   &lt;restriction base="xs:string"&gt;     &lt;enumeration value="0080001"&gt;       &lt;annotation&gt;         &lt;documentation&gt;Endoprothese Hüfte/Knie&lt;/documentation&gt;       &lt;/annotation&gt;     &lt;/enumeration&gt;     &lt;enumeration value="0080002"&gt;       &lt;annotation&gt;         &lt;documentation&gt;Brustimplantat&lt;/documentation&gt;       &lt;/annotation&gt;     &lt;/enumeration&gt;     &lt;enumeration value="0080003"&gt;       &lt;annotation&gt;         &lt;documentation&gt;Aortenklappenprothese&lt;/documentation&gt;       &lt;/annotation&gt;     &lt;/enumeration&gt;   &lt;/restriction&gt; &lt;/simpleType&gt; </pre>		

### simpleType enum\_0100

namespace	http://xml.ir-d.de/irdma		
type	restriction of <b>string</b>		
properties	base xs:string		
facets	Kind	Value	Annotation
	enumeration	0100001	documentation Primäreingriff
	enumeration	0100002	documentation Austausch Expander gegen dauerhaftes Brustimplantat
	enumeration	0100003	documentation Revision
	enumeration	0100004	documentation Nur Explantation
annotation	documentation Kat BI_ArtEingriff		
source	<pre> &lt;simpleType name="enum_0100"&gt;   &lt;annotation&gt;     &lt;documentation&gt;Kat BI_ArtEingriff&lt;/documentation&gt;   &lt;/annotation&gt;   &lt;restriction base="xs:string"&gt;     &lt;enumeration value="0100001"&gt;       &lt;annotation&gt;         &lt;documentation&gt;Primäreingriff&lt;/documentation&gt;       &lt;/annotation&gt;     &lt;/enumeration&gt;     &lt;enumeration value="0100002"&gt;       &lt;annotation&gt;         &lt;documentation&gt;Austausch Expander gegen dauerhaftes Brustimplantat&lt;/documentation&gt;       &lt;/annotation&gt;     &lt;/enumeration&gt;     &lt;enumeration value="0100003"&gt;       &lt;annotation&gt;         &lt;documentation&gt;Revision&lt;/documentation&gt;       &lt;/annotation&gt;     &lt;/enumeration&gt;     &lt;enumeration value="0100004"&gt;       &lt;annotation&gt;         &lt;documentation&gt;Nur Explantation&lt;/documentation&gt;       &lt;/annotation&gt;     &lt;/enumeration&gt;   &lt;/restriction&gt; &lt;/simpleType&gt; </pre>		

### simpleType enum\_0102

namespace	http://xml.ir-d.de/irdma		
type	restriction of <b>string</b>		
properties	base xs:string		
facets	Kind	Value	Annotation
	enumeration	0102001	documentation kosmetische Augmentation
	enumeration	0102002	documentation



	enumeration 0102003 enumeration 0102004	Rekonstruktion, benigne documentation Rekonstruktion nach Mastektomie aufgrund eines Karzinoms documentation Rekonstruktion nach risikoreduzierender Mastektomie
annotation	documentation Kat_BI_GrundPrimaereingriff	
source	<pre> &lt;simpleType name="enum_0102"&gt;   &lt;annotation&gt;     &lt;documentation&gt;Kat_BI_GrundPrimaereingriff&lt;/documentation&gt;   &lt;/annotation&gt;   &lt;restriction base="xs:string"&gt;     &lt;enumeration value="0102001"&gt;       &lt;annotation&gt;         &lt;documentation&gt;kosmetische Augmentation&lt;/documentation&gt;       &lt;/annotation&gt;     &lt;/enumeration&gt;     &lt;enumeration value="0102002"&gt;       &lt;annotation&gt;         &lt;documentation&gt;Rekonstruktion, benigne&lt;/documentation&gt;       &lt;/annotation&gt;     &lt;/enumeration&gt;     &lt;enumeration value="0102003"&gt;       &lt;annotation&gt;         &lt;documentation&gt;Rekonstruktion nach Mastektomie aufgrund eines Karzinoms&lt;/documentation&gt;       &lt;/annotation&gt;     &lt;/enumeration&gt;     &lt;enumeration value="0102004"&gt;       &lt;annotation&gt;         &lt;documentation&gt;Rekonstruktion nach risikoreduzierender Mastektomie&lt;/documentation&gt;       &lt;/annotation&gt;     &lt;/enumeration&gt;   &lt;/restriction&gt; &lt;/simpleType&gt; </pre>	

### simpleType enum\_0103

namespace	http://xml.ir-d.de/irdma		
type	restriction of <b>string</b>		
properties	base	xs:string	
facets	Kind	Value	Annotation
	enumeration	0103001	documentation simultane Lappendeckung
	enumeration	0103002	documentation simultane Eigenfetttransplantation
	enumeration	0103003	documentation simultane Mastopexie
	enumeration	0103005	documentation simultane Mastektomie, Ablatio / hautsparend
	enumeration	0103006	documentation simultane Mastektomie, nippelerhaltend
	enumeration	0103007	documentation Axilla-Dissektion
	enumeration	0103008	documentation Drainage

annotation	documentation Kat_BI_OperationsdetailPrimaereingriff
source	<pre> &lt;simpleType name="enum_0103"&gt;   &lt;annotation&gt;     &lt;documentation&gt;Kat_BI_OperationsdetailPrimaereingriff&lt;/documentation&gt;   &lt;/annotation&gt;   &lt;restriction base="xs:string"&gt;     &lt;enumeration value="0103001"&gt;       &lt;annotation&gt;         &lt;documentation&gt;simultane Lappendeckung&lt;/documentation&gt;       &lt;/annotation&gt;     &lt;/enumeration&gt;     &lt;enumeration value="0103002"&gt;       &lt;annotation&gt;         &lt;documentation&gt;simultane Eigenfetttransplantation&lt;/documentation&gt;       &lt;/annotation&gt;     &lt;/enumeration&gt;     &lt;enumeration value="0103003"&gt;       &lt;annotation&gt;         &lt;documentation&gt;simultane Mastopexie&lt;/documentation&gt;       &lt;/annotation&gt;     &lt;/enumeration&gt;     &lt;enumeration value="0103005"&gt;       &lt;annotation&gt;         &lt;documentation&gt;simultane Mastektomie, Ablatio / hautsparend&lt;/documentation&gt;       &lt;/annotation&gt;     &lt;/enumeration&gt;     &lt;enumeration value="0103006"&gt;       &lt;annotation&gt;         &lt;documentation&gt;simultane Mastektomie, nippelerhaltend&lt;/documentation&gt;       &lt;/annotation&gt;     &lt;/enumeration&gt;     &lt;enumeration value="0103007"&gt;       &lt;annotation&gt;         &lt;documentation&gt;Axilla-Dissektion&lt;/documentation&gt;       &lt;/annotation&gt;     &lt;/enumeration&gt;     &lt;enumeration value="0103008"&gt;       &lt;annotation&gt;         &lt;documentation&gt;Drainage&lt;/documentation&gt;       &lt;/annotation&gt;     &lt;/enumeration&gt;   &lt;/restriction&gt; &lt;/simpleType&gt; </pre>

### simpleType enum\_0104

namespace	http://xml.ir-d.de/irdma		
type	restriction of <b>string</b>		
properties	base xs:string		
facets	Kind	Value	Annotation
	enumeration	0104001	documentation Austausch Expander gegen dauerhaftes Brustimplantat
annotation	documentation Kat_BI_GrundAustausch		

source	<pre> &lt;simpleType name="enum_0104"&gt;   &lt;annotation&gt;     &lt;documentation&gt;Kat_BI_GrundAustausch&lt;/documentation&gt;   &lt;/annotation&gt;   &lt;restriction base="xs:string"&gt;     &lt;enumeration value="0104001"&gt;       &lt;annotation&gt;         &lt;documentation&gt;Austausch Expander gegen dauerhaftes Brustimplantat&lt;/documentation&gt;       &lt;/annotation&gt;     &lt;/enumeration&gt;   &lt;/restriction&gt; &lt;/simpleType&gt; </pre>
--------	---

### simpleType enum\_0105

namespace	http://xml.ir-d.de/irdma		
type	restriction of <b>string</b>		
properties	base xs:string		
facets	Kind	Value	Annotation
	enumeration	0105001	documentation simultane Lappendeckung
	enumeration	0105002	documentation simultane Eigenfetttransplantation
	enumeration	0105003	documentation simultane Mastopexie
	enumeration	0105008	documentation Drainage
	enumeration	0105009	documentation Kapsulektomie, komplett
	enumeration	0105010	documentation Kapsulektomie, partiell
	enumeration	0105011	documentation Neopocket
annotation	documentation Kat_BI_OperationsdetailAustausch		
source	<pre> &lt;simpleType name="enum_0105"&gt;   &lt;annotation&gt;     &lt;documentation&gt;Kat_BI_OperationsdetailAustausch&lt;/documentation&gt;   &lt;/annotation&gt;   &lt;restriction base="xs:string"&gt;     &lt;enumeration value="0105001"&gt;       &lt;annotation&gt;         &lt;documentation&gt;simultane Lappendeckung&lt;/documentation&gt;       &lt;/annotation&gt;     &lt;/enumeration&gt;     &lt;enumeration value="0105002"&gt;       &lt;annotation&gt;         &lt;documentation&gt;simultane Eigenfetttransplantation&lt;/documentation&gt;       &lt;/annotation&gt;     &lt;/enumeration&gt;     &lt;enumeration value="0105003"&gt;       &lt;annotation&gt;         &lt;documentation&gt;simultane Mastopexie&lt;/documentation&gt;       &lt;/annotation&gt;     &lt;/enumeration&gt;     &lt;enumeration value="0105008"&gt; </pre>		

	<pre> &lt;annotation&gt;   &lt;documentation&gt;Drainage&lt;/documentation&gt; &lt;/annotation&gt; &lt;/enumeration&gt; &lt;enumeration value="0105009"&gt;   &lt;annotation&gt;     &lt;documentation&gt;Kapsulektomie, komplett&lt;/documentation&gt;   &lt;/annotation&gt; &lt;/enumeration&gt; &lt;enumeration value="0105010"&gt;   &lt;annotation&gt;     &lt;documentation&gt;Kapsulektomie, partiell&lt;/documentation&gt;   &lt;/annotation&gt; &lt;/enumeration&gt; &lt;enumeration value="0105011"&gt;   &lt;annotation&gt;     &lt;documentation&gt;Neopocket&lt;/documentation&gt;   &lt;/annotation&gt; &lt;/enumeration&gt; &lt;/restriction&gt; &lt;/simpleType&gt; </pre>
--	--

### simpleType enum\_0106

namespace	http://xml.ir-d.de/irdma		
type	restriction of <b>string</b>		
properties	base xs:string		
facets	Kind	Value	Annotation
	enumeration	0106001	documentation Patientenwunsch
	enumeration	0106002	documentation asymptomatisch
	enumeration	0106003	documentation Komplikation
annotation	documentation Kat_BI_GrundRevisionExplantation		
source	<pre> &lt;simpleType name="enum_0106"&gt;   &lt;annotation&gt;     &lt;documentation&gt;Kat_BI_GrundRevisionExplantation&lt;/documentation&gt;   &lt;/annotation&gt;   &lt;restriction base="xs:string"&gt;     &lt;enumeration value="0106001"&gt;       &lt;annotation&gt;         &lt;documentation&gt;Patientenwunsch&lt;/documentation&gt;       &lt;/annotation&gt;     &lt;/enumeration&gt;     &lt;enumeration value="0106002"&gt;       &lt;annotation&gt;         &lt;documentation&gt;asymptomatisch&lt;/documentation&gt;       &lt;/annotation&gt;     &lt;/enumeration&gt;     &lt;enumeration value="0106003"&gt;       &lt;annotation&gt;         &lt;documentation&gt;Komplikation&lt;/documentation&gt;       &lt;/annotation&gt;     &lt;/enumeration&gt;   &lt;/restriction&gt; </pre>		

	<code>&lt;/simpleType&gt;</code>
--	----------------------------------

### simpleType enum\_0107

namespace	http://xml.ir-d.de/irdma																																	
type	restriction of <b>string</b>																																	
properties	base xs:string																																	
facets	<table><thead><tr><th>Kind</th><th>Value</th><th>Annotation</th></tr></thead><tbody><tr><td>enumeration</td><td>0107001</td><td>documentation simultane Lappendeckung</td></tr><tr><td>enumeration</td><td>0107002</td><td>documentation simultane Eigenfetttransplantation</td></tr><tr><td>enumeration</td><td>0107003</td><td>documentation simultane Mastopexie</td></tr><tr><td>enumeration</td><td>0107005</td><td>documentation simultane Mastektomie, Ablatio / hautsparend</td></tr><tr><td>enumeration</td><td>0107006</td><td>documentation simultane Mastektomie, nippelerhaltend</td></tr><tr><td>enumeration</td><td>0107007</td><td>documentation Axilla-Dissektion</td></tr><tr><td>enumeration</td><td>0107008</td><td>documentation Drainage</td></tr><tr><td>enumeration</td><td>0107009</td><td>documentation Kapsulektomie, komplett</td></tr><tr><td>enumeration</td><td>0107010</td><td>documentation Kapsulektomie, partiell</td></tr><tr><td>enumeration</td><td>0107011</td><td>documentation Neopocket</td></tr></tbody></table>	Kind	Value	Annotation	enumeration	0107001	documentation simultane Lappendeckung	enumeration	0107002	documentation simultane Eigenfetttransplantation	enumeration	0107003	documentation simultane Mastopexie	enumeration	0107005	documentation simultane Mastektomie, Ablatio / hautsparend	enumeration	0107006	documentation simultane Mastektomie, nippelerhaltend	enumeration	0107007	documentation Axilla-Dissektion	enumeration	0107008	documentation Drainage	enumeration	0107009	documentation Kapsulektomie, komplett	enumeration	0107010	documentation Kapsulektomie, partiell	enumeration	0107011	documentation Neopocket
Kind	Value	Annotation																																
enumeration	0107001	documentation simultane Lappendeckung																																
enumeration	0107002	documentation simultane Eigenfetttransplantation																																
enumeration	0107003	documentation simultane Mastopexie																																
enumeration	0107005	documentation simultane Mastektomie, Ablatio / hautsparend																																
enumeration	0107006	documentation simultane Mastektomie, nippelerhaltend																																
enumeration	0107007	documentation Axilla-Dissektion																																
enumeration	0107008	documentation Drainage																																
enumeration	0107009	documentation Kapsulektomie, komplett																																
enumeration	0107010	documentation Kapsulektomie, partiell																																
enumeration	0107011	documentation Neopocket																																
annotation	documentation Kat_BI_OperationsdetailRevision																																	
source	<pre>&lt;simpleType name="enum_0107"&gt;   &lt;annotation&gt;     &lt;documentation&gt;Kat_BI_OperationsdetailRevision&lt;/documentation&gt;   &lt;/annotation&gt;   &lt;restriction base="xs:string"&gt;     &lt;enumeration value="0107001"&gt;       &lt;annotation&gt;         &lt;documentation&gt;simultane Lappendeckung&lt;/documentation&gt;       &lt;/annotation&gt;     &lt;/enumeration&gt;     &lt;enumeration value="0107002"&gt;       &lt;annotation&gt;         &lt;documentation&gt;simultane Eigenfetttransplantation&lt;/documentation&gt;       &lt;/annotation&gt;     &lt;/enumeration&gt;     &lt;enumeration value="0107003"&gt;       &lt;annotation&gt;         &lt;documentation&gt;simultane Mastopexie&lt;/documentation&gt;       &lt;/annotation&gt;     &lt;/enumeration&gt;     &lt;enumeration value="0107005"&gt;       &lt;annotation&gt;         &lt;documentation&gt;simultane Mastektomie, Ablatio / hautsparend&lt;/documentation&gt;       &lt;/annotation&gt;     &lt;/enumeration&gt;     &lt;enumeration value="0107006"&gt;       &lt;annotation&gt;</pre>																																	

	<pre>       &lt;documentation&gt;simultane Mastektomie, nippelerhaltend&lt;/documentation&gt;     &lt;/annotation&gt;   &lt;/enumeration&gt;   &lt;enumeration value="0107007"&gt;     &lt;annotation&gt;       &lt;documentation&gt;Axilla-Dissektion&lt;/documentation&gt;     &lt;/annotation&gt;   &lt;/enumeration&gt;   &lt;enumeration value="0107008"&gt;     &lt;annotation&gt;       &lt;documentation&gt;Drainage&lt;/documentation&gt;     &lt;/annotation&gt;   &lt;/enumeration&gt;   &lt;enumeration value="0107009"&gt;     &lt;annotation&gt;       &lt;documentation&gt;Kapsulektomie, komplett&lt;/documentation&gt;     &lt;/annotation&gt;   &lt;/enumeration&gt;   &lt;enumeration value="0107010"&gt;     &lt;annotation&gt;       &lt;documentation&gt;Kapsulektomie, partiell&lt;/documentation&gt;     &lt;/annotation&gt;   &lt;/enumeration&gt;   &lt;enumeration value="0107011"&gt;     &lt;annotation&gt;       &lt;documentation&gt;Neopocket&lt;/documentation&gt;     &lt;/annotation&gt;   &lt;/enumeration&gt; &lt;/restriction&gt; &lt;/simpleType&gt; </pre>
--	--

### simpleType enum\_0110

namespace	http://xml.ir-d.de/irdma						
type	restriction of <b>string</b>						
properties	base xs:string						
facets	<table border="1"> <thead> <tr> <th>Kind</th> <th>Value</th> <th>Annotation</th> </tr> </thead> <tbody> <tr> <td>enumeration</td> <td>0110001</td> <td>documentation Bestrahlung</td> </tr> </tbody> </table>	Kind	Value	Annotation	enumeration	0110001	documentation Bestrahlung
Kind	Value	Annotation					
enumeration	0110001	documentation Bestrahlung					
annotation	documentation Kat_BI_VorbehandlungLokal						
source	<pre> &lt;simpleType name="enum_0110"&gt;   &lt;annotation&gt;     &lt;documentation&gt;Kat_BI_VorbehandlungLokal&lt;/documentation&gt;   &lt;/annotation&gt;   &lt;restriction base="xs:string"&gt;     &lt;enumeration value="0110001"&gt;       &lt;annotation&gt;         &lt;documentation&gt;Bestrahlung&lt;/documentation&gt;       &lt;/annotation&gt;     &lt;/enumeration&gt;   &lt;/restriction&gt; &lt;/simpleType&gt; </pre>						

### simpleType enum\_0111

namespace	http://xml.ir-d.de/irdma		
type	restriction of <b>string</b>		
properties	base xs:string		
facets	Kind	Value	Annotation
	enumeration	0111001	documentation nein
	enumeration	0111002	documentation Lipofilling
	enumeration	0111003	documentation Eigengewebsrekonstruktion
annotation	documentation Kat_BI_Verfahrenswechsel		
source	<pre> &lt;simpleType name="enum_0111"&gt;   &lt;annotation&gt;     &lt;documentation&gt;Kat_BI_Verfahrenswechsel&lt;/documentation&gt;   &lt;/annotation&gt;   &lt;restriction base="xs:string"&gt;     &lt;enumeration value="0111001"&gt;       &lt;annotation&gt;         &lt;documentation&gt;nein&lt;/documentation&gt;       &lt;/annotation&gt;     &lt;/enumeration&gt;     &lt;enumeration value="0111002"&gt;       &lt;annotation&gt;         &lt;documentation&gt;Lipofilling&lt;/documentation&gt;       &lt;/annotation&gt;     &lt;/enumeration&gt;     &lt;enumeration value="0111003"&gt;       &lt;annotation&gt;         &lt;documentation&gt;Eigengewebsrekonstruktion&lt;/documentation&gt;       &lt;/annotation&gt;     &lt;/enumeration&gt;   &lt;/restriction&gt; &lt;/simpleType&gt; </pre>		

### simpleType enum\_0112

namespace	http://xml.ir-d.de/irdma		
type	restriction of <b>string</b>		
properties	base xs:string		
facets	Kind	Value	Annotation
	enumeration	0112001	documentation subglandulär / epipektoral
	enumeration	0112002	documentation subpektoral
	enumeration	0112003	documentation subfaszial
	enumeration	0112004	documentation sub-flap
	enumeration	0112005	documentation subkutan
	enumeration	0112006	documentation dual plane
	enumeration	0112042	documentation andere

annotation	documentation Kat_BI_LageImplantat
source	<pre> &lt;simpleType name="enum_0112"&gt;   &lt;annotation&gt;     &lt;documentation&gt;Kat_BI_LageImplantat&lt;/documentation&gt;   &lt;/annotation&gt;   &lt;restriction base="xs:string"&gt;     &lt;enumeration value="0112001"&gt;       &lt;annotation&gt;         &lt;documentation&gt;subglandulär / epipektoral&lt;/documentation&gt;       &lt;/annotation&gt;     &lt;/enumeration&gt;     &lt;enumeration value="0112002"&gt;       &lt;annotation&gt;         &lt;documentation&gt;subpektoral&lt;/documentation&gt;       &lt;/annotation&gt;     &lt;/enumeration&gt;     &lt;enumeration value="0112003"&gt;       &lt;annotation&gt;         &lt;documentation&gt;subfaszial&lt;/documentation&gt;       &lt;/annotation&gt;     &lt;/enumeration&gt;     &lt;enumeration value="0112004"&gt;       &lt;annotation&gt;         &lt;documentation&gt;sub-flap&lt;/documentation&gt;       &lt;/annotation&gt;     &lt;/enumeration&gt;     &lt;enumeration value="0112005"&gt;       &lt;annotation&gt;         &lt;documentation&gt;subkutan&lt;/documentation&gt;       &lt;/annotation&gt;     &lt;/enumeration&gt;     &lt;enumeration value="0112006"&gt;       &lt;annotation&gt;         &lt;documentation&gt;dual plane&lt;/documentation&gt;       &lt;/annotation&gt;     &lt;/enumeration&gt;     &lt;enumeration value="0112042"&gt;       &lt;annotation&gt;         &lt;documentation&gt;andere&lt;/documentation&gt;       &lt;/annotation&gt;     &lt;/enumeration&gt;   &lt;/restriction&gt; &lt;/simpleType&gt; </pre>

### simpleType enum 0113

namespace	http://xml.ir-d.de/irdma		
type	restriction of <b>string</b>		
properties	base xs:string		
facets	Kind enumeration	Value 0113001	Annotation documentation Chemotherapie innerhalb der letzten drei Monate
annotation	documentation Kat_BI_VorbehandlungSystemisch		
source	<simpleType name="enum_0113">		



	<pre> &lt;annotation&gt;   &lt;documentation&gt;Kat_BI_VorbehandlungSystemisch&lt;/documentation&gt; &lt;/annotation&gt; &lt;restriction base="xs:string"&gt;   &lt;enumeration value="0113001"&gt;     &lt;annotation&gt;       &lt;documentation&gt;Chemotherapie innerhalb der letzten drei Monate&lt;/documentation&gt;     &lt;/annotation&gt;   &lt;/enumeration&gt; &lt;/restriction&gt; &lt;/simpleType&gt; </pre>
--	--

### simpleType enum\_0114

namespace	http://xml.ir-d.de/irdma		
type	restriction of <b>string</b>		
properties	base xs:string		
facets	Kind	Value	Annotation
	enumeration	0114001	documentation vollständig
	enumeration	0114002	documentation nein
	enumeration	0114003	documentation teilweise
	enumeration	0114004	documentation nicht vorhanden
annotation	documentation Kat_BI_EntfernungADMNetz		
source	<pre> &lt;simpleType name="enum_0114"&gt;   &lt;annotation&gt;     &lt;documentation&gt;Kat_BI_EntfernungADMNetz&lt;/documentation&gt;   &lt;/annotation&gt;   &lt;restriction base="xs:string"&gt;     &lt;enumeration value="0114001"&gt;       &lt;annotation&gt;         &lt;documentation&gt;vollständig&lt;/documentation&gt;       &lt;/annotation&gt;     &lt;/enumeration&gt;     &lt;enumeration value="0114002"&gt;       &lt;annotation&gt;         &lt;documentation&gt;nein&lt;/documentation&gt;       &lt;/annotation&gt;     &lt;/enumeration&gt;     &lt;enumeration value="0114003"&gt;       &lt;annotation&gt;         &lt;documentation&gt;teilweise&lt;/documentation&gt;       &lt;/annotation&gt;     &lt;/enumeration&gt;     &lt;enumeration value="0114004"&gt;       &lt;annotation&gt;         &lt;documentation&gt;nicht vorhanden&lt;/documentation&gt;       &lt;/annotation&gt;     &lt;/enumeration&gt;   &lt;/restriction&gt; &lt;/simpleType&gt; </pre>		

## simpleType enum 0116

namespace	http://xml.ir-d.de/irdma		
type	restriction of <b>string</b>		
properties	base xs:string		
facets	Kind	Value	Annotation
	enumeration	0116001	documentation Spülung, antibiotisch
	enumeration	0116002	documentation Spülung, antiseptisch
	enumeration	0116003	documentation Spülung, wirkstofffrei
	enumeration	0116004	documentation Spülung, andere
	enumeration	0116005	documentation prä-/perioperative Antibiotika
	enumeration	0116006	documentation postoperative Antibiotika
	enumeration	0116007	documentation Handschuhwechsel vor Implantation
	enumeration	0116008	documentation Implantationshilfe
annotation	documentation Kat_BI_Operationsmassnahme		
source	<pre> &lt;simpleType name="enum_0116"&gt;   &lt;annotation&gt;     &lt;documentation&gt;Kat_BI_Operationsmassnahme&lt;/documentation&gt;   &lt;/annotation&gt;   &lt;restriction base="xs:string"&gt;     &lt;enumeration value="0116001"&gt;       &lt;annotation&gt;         &lt;documentation&gt;Spülung, antibiotisch&lt;/documentation&gt;       &lt;/annotation&gt;     &lt;/enumeration&gt;     &lt;enumeration value="0116002"&gt;       &lt;annotation&gt;         &lt;documentation&gt;Spülung, antiseptisch&lt;/documentation&gt;       &lt;/annotation&gt;     &lt;/enumeration&gt;     &lt;enumeration value="0116003"&gt;       &lt;annotation&gt;         &lt;documentation&gt;Spülung, wirkstofffrei&lt;/documentation&gt;       &lt;/annotation&gt;     &lt;/enumeration&gt;     &lt;enumeration value="0116004"&gt;       &lt;annotation&gt;         &lt;documentation&gt;Spülung, andere&lt;/documentation&gt;       &lt;/annotation&gt;     &lt;/enumeration&gt;     &lt;enumeration value="0116005"&gt;       &lt;annotation&gt;         &lt;documentation&gt;prä-/perioperative Antibiotika&lt;/documentation&gt;       &lt;/annotation&gt;     &lt;/enumeration&gt;     &lt;enumeration value="0116006"&gt;       &lt;annotation&gt;         &lt;documentation&gt;postoperative Antibiotika&lt;/documentation&gt;       &lt;/annotation&gt;     &lt;/enumeration&gt;   &lt;/restriction&gt; &lt;/simpleType&gt; </pre>		

	<pre> &lt;/annotation&gt; &lt;/enumeration&gt; &lt;enumeration value="0116007"&gt;   &lt;annotation&gt;     &lt;documentation&gt;Handschuhwechsel vor Implantation&lt;/documentation&gt;   &lt;/annotation&gt; &lt;/enumeration&gt; &lt;enumeration value="0116008"&gt;   &lt;annotation&gt;     &lt;documentation&gt;Implantationshilfe&lt;/documentation&gt;   &lt;/annotation&gt; &lt;/enumeration&gt; &lt;/restriction&gt; &lt;/simpleType&gt; </pre>
--	---

### simpleType enum\_0118

namespace	http://xml.lir-d.de/irdma		
type	restriction of <b>string</b>		
properties	base xs:string		
facets	Kind	Value	Annotation
	enumeration	0118001	documentation axillär
	enumeration	0118002	documentation periareolär
	enumeration	0118003	documentation inframammär
	enumeration	0118004	documentation Mastektomienarbe
	enumeration	0118042	documentation anderer
annotation	documentation Kat_BI_Operationszugang		
source	<pre> &lt;simpleType name="enum_0118"&gt;   &lt;annotation&gt;     &lt;documentation&gt;Kat_BI_Operationszugang&lt;/documentation&gt;   &lt;/annotation&gt;   &lt;restriction base="xs:string"&gt;     &lt;enumeration value="0118001"&gt;       &lt;annotation&gt;         &lt;documentation&gt;axillär&lt;/documentation&gt;       &lt;/annotation&gt;     &lt;/enumeration&gt;     &lt;enumeration value="0118002"&gt;       &lt;annotation&gt;         &lt;documentation&gt;periareolär&lt;/documentation&gt;       &lt;/annotation&gt;     &lt;/enumeration&gt;     &lt;enumeration value="0118003"&gt;       &lt;annotation&gt;         &lt;documentation&gt;inframammär&lt;/documentation&gt;       &lt;/annotation&gt;     &lt;/enumeration&gt;     &lt;enumeration value="0118004"&gt;       &lt;annotation&gt;         &lt;documentation&gt;Mastektomienarbe&lt;/documentation&gt;       &lt;/annotation&gt;     &lt;/enumeration&gt;   &lt;/restriction&gt; &lt;/simpleType&gt; </pre>		

	<pre> &lt;/enumeration&gt; &lt;enumeration value="0118042"&gt;   &lt;annotation&gt;     &lt;documentation&gt;anderer&lt;/documentation&gt;   &lt;/annotation&gt; &lt;/enumeration&gt; &lt;/restriction&gt; &lt;/simpleType&gt; </pre>
--	---

### simpleType enum\_0120

namespace	http://xml.ir-d.de/irdma		
type	restriction of <b>string</b>		
properties	base xs:string		
facets	Kind	Value	Annotation
	enumeration	0120001	documentation Expander defekt
annotation	documentation Kat_BI_BefundAustausch		
source	<pre> &lt;simpleType name="enum_0120"&gt;   &lt;annotation&gt;     &lt;documentation&gt;Kat_BI_BefundAustausch&lt;/documentation&gt;   &lt;/annotation&gt;   &lt;restriction base="xs:string"&gt;     &lt;enumeration value="0120001"&gt;       &lt;annotation&gt;         &lt;documentation&gt;Expander defekt&lt;/documentation&gt;       &lt;/annotation&gt;     &lt;/enumeration&gt;   &lt;/restriction&gt; &lt;/simpleType&gt; </pre>		

### simpleType enum\_0121

namespace	http://xml.ir-d.de/irdma		
type	restriction of <b>string</b>		
properties	base xs:string		
facets	Kind	Value	Annotation
	enumeration	0121001	documentation Infektion
	enumeration	0121002	documentation Serom
	enumeration	0121003	documentation Hämatom
	enumeration	0121004	documentation Kapsel fibrose
	enumeration	0121005	documentation Implantatruptur
	enumeration	0121006	documentation Fehlpositionierung/Rotation
	enumeration	0121007	documentation BIA-ALCL/-SCC, Verdacht
	enumeration	0121008	documentation BIA-ALCL/-SCC, pathologisch bestätigt
	enumeration	0121009	documentation

	<p>enumeration 0121010 Brustschmerzen documentation Doppelkapsel</p> <p>enumeration 0121011 documentation Netz-/ADM-bedingte Komplikation, Non-Integration</p> <p>enumeration 0121012 documentation Netz-/ADM-bedingte Komplikation, andere</p> <p>enumeration 0121013 documentation Hautnekrose/exponiertes Implantat</p> <p>enumeration 0121014 documentation BII/ASIA (Brustimplantat assoziierte Symptome), Verdacht</p> <p>enumeration 0121015 documentation Lymphadenopathie</p> <p>enumeration 0121016 documentation Brustkrebs, neu aufgetreten/Rezidiv</p>
annotation	documentation Kat_BI_BefundKomplett
source	<pre> &lt;simpleType name="enum_0121"&gt;   &lt;annotation&gt;     &lt;documentation&gt;Kat_BI_BefundKomplett&lt;/documentation&gt;   &lt;/annotation&gt;   &lt;restriction base="xs:string"&gt;     &lt;enumeration value="0121001"&gt;       &lt;annotation&gt;         &lt;documentation&gt;Infektion&lt;/documentation&gt;       &lt;/annotation&gt;     &lt;/enumeration&gt;     &lt;enumeration value="0121002"&gt;       &lt;annotation&gt;         &lt;documentation&gt;Serom&lt;/documentation&gt;       &lt;/annotation&gt;     &lt;/enumeration&gt;     &lt;enumeration value="0121003"&gt;       &lt;annotation&gt;         &lt;documentation&gt;Hämatom&lt;/documentation&gt;       &lt;/annotation&gt;     &lt;/enumeration&gt;     &lt;enumeration value="0121004"&gt;       &lt;annotation&gt;         &lt;documentation&gt;Kapsel fibrose&lt;/documentation&gt;       &lt;/annotation&gt;     &lt;/enumeration&gt;     &lt;enumeration value="0121005"&gt;       &lt;annotation&gt;         &lt;documentation&gt;Implantatruptur&lt;/documentation&gt;       &lt;/annotation&gt;     &lt;/enumeration&gt;     &lt;enumeration value="0121006"&gt;       &lt;annotation&gt;         &lt;documentation&gt;Fehlpositionierung/Rotation&lt;/documentation&gt;       &lt;/annotation&gt;     &lt;/enumeration&gt;     &lt;enumeration value="0121007"&gt;       &lt;annotation&gt;         &lt;documentation&gt;BIA-ALCL/-SCC, Verdacht&lt;/documentation&gt;       &lt;/annotation&gt;     &lt;/enumeration&gt;     &lt;enumeration value="0121008"&gt;       &lt;annotation&gt;         &lt;documentation&gt;BIA-ALCL/-SCC, pathologisch bestätigt&lt;/documentation&gt;       &lt;/annotation&gt;     &lt;/enumeration&gt;   &lt;/restriction&gt; &lt;/simpleType&gt; </pre>

```

</annotation>
</enumeration>
<enumeration value="0121009">
  <annotation>
    <documentation>Brustschmerzen</documentation>
  </annotation>
</enumeration>
<enumeration value="0121010">
  <annotation>
    <documentation>Doppelkapsel</documentation>
  </annotation>
</enumeration>
<enumeration value="0121011">
  <annotation>
    <documentation>Netz-/ADM-bedingte Komplikation,
Non-Integration</documentation>
  </annotation>
</enumeration>
<enumeration value="0121012">
  <annotation>
    <documentation>Netz-/ADM-bedingte Komplikation, andere</documentation>
  </annotation>
</enumeration>
<enumeration value="0121013">
  <annotation>
    <documentation>Hautnekrose/exponiertes Implantat</documentation>
  </annotation>
</enumeration>
<enumeration value="0121014">
  <annotation>
    <documentation>BII/ASIA (Brustimplantat assoziierte Symptome),
Verdacht</documentation>
  </annotation>
</enumeration>
<enumeration value="0121015">
  <annotation>
    <documentation>Lymphadenopathie</documentation>
  </annotation>
</enumeration>
<enumeration value="0121016">
  <annotation>
    <documentation>Brustkrebs, neu aufgetreten/Rezidiv</documentation>
  </annotation>
</enumeration>
</restriction>
</simpleType>

```

### simpleType enum\_0122

namespace	http://xml.ir-d.de/irdma		
type	restriction of <b>string</b>		
properties	base xs:string		
facets	Kind	Value	Annotation
	enumeration	0122001	documentation ja, ärztlich nachgewiesen
	enumeration	0122002	documentation nein

	enumeration 0122042 documentation unbekannt
annotation	documentation Kat_BI_Autoimmunerkrankung
source	<pre> &lt;simpleType name="enum_0122"&gt;   &lt;annotation&gt;     &lt;documentation&gt;Kat_BI_Autoimmunerkrankung&lt;/documentation&gt;   &lt;/annotation&gt;   &lt;restriction base="xs:string"&gt;     &lt;enumeration value="0122001"&gt;       &lt;annotation&gt;         &lt;documentation&gt;ja, ärztlich nachgewiesen&lt;/documentation&gt;       &lt;/annotation&gt;     &lt;/enumeration&gt;     &lt;enumeration value="0122002"&gt;       &lt;annotation&gt;         &lt;documentation&gt;nein&lt;/documentation&gt;       &lt;/annotation&gt;     &lt;/enumeration&gt;     &lt;enumeration value="0122042"&gt;       &lt;annotation&gt;         &lt;documentation&gt;unbekannt&lt;/documentation&gt;       &lt;/annotation&gt;     &lt;/enumeration&gt;   &lt;/restriction&gt; &lt;/simpleType&gt; </pre>

### simpleType enum\_0123

namespace	http://xml.ir-d.de/irdma		
type	restriction of <b>string</b>		
properties	base	xs:string	
facets	Kind	Value	Annotation
	enumeration	0123001	documentation neu aufgetreten
	enumeration	0123002	documentation verschlechtert
	enumeration	0123003	documentation keine Veränderung
	enumeration	0123004	documentation nicht relevant, da Primäreingriff
	enumeration	0123042	documentation unbekannt
annotation	documentation Kat_BI_VerlaufAutoimmunerkrankung		
source	<pre> &lt;simpleType name="enum_0123"&gt;   &lt;annotation&gt;     &lt;documentation&gt;Kat_BI_VerlaufAutoimmunerkrankung&lt;/documentation&gt;   &lt;/annotation&gt;   &lt;restriction base="xs:string"&gt;     &lt;enumeration value="0123001"&gt;       &lt;annotation&gt;         &lt;documentation&gt;neu aufgetreten&lt;/documentation&gt;       &lt;/annotation&gt;     &lt;/enumeration&gt;     &lt;enumeration value="0123002"&gt;       &lt;annotation&gt; </pre>		

	<pre> &lt;documentation&gt;verschlechtert&lt;/documentation&gt; &lt;/annotation&gt; &lt;/enumeration&gt; &lt;enumeration value="0123003"&gt;   &lt;annotation&gt;     &lt;documentation&gt;keine Veränderung&lt;/documentation&gt;   &lt;/annotation&gt; &lt;/enumeration&gt; &lt;enumeration value="0123004"&gt;   &lt;annotation&gt;     &lt;documentation&gt;nicht relevant, da Primäreingriff&lt;/documentation&gt;   &lt;/annotation&gt; &lt;/enumeration&gt; &lt;enumeration value="0123042"&gt;   &lt;annotation&gt;     &lt;documentation&gt;unbekannt&lt;/documentation&gt;   &lt;/annotation&gt; &lt;/enumeration&gt; &lt;/restriction&gt; &lt;/simpleType&gt; </pre>
--	---

### simpleType enum\_0124

namespace	http://xml.ir-d.de/irdma		
type	restriction of <b>string</b>		
properties	base xs:string		
facets	Kind	Value	Annotation
	enumeration	0124001	documentation Salzlösung
	enumeration	0124002	documentation Silikongel
	enumeration	0124003	documentation Kombination Silikongel und Salzlösung
	enumeration	0124042	documentation sonstige
annotation	documentation Kat_BI_Fuellung		
source	<pre> &lt;simpleType name="enum_0124"&gt;   &lt;annotation&gt;     &lt;documentation&gt;Kat_BI_Fuellung&lt;/documentation&gt;   &lt;/annotation&gt;   &lt;restriction base="xs:string"&gt;     &lt;enumeration value="0124001"&gt;       &lt;annotation&gt;         &lt;documentation&gt;Salzlösung&lt;/documentation&gt;       &lt;/annotation&gt;     &lt;/enumeration&gt;     &lt;enumeration value="0124002"&gt;       &lt;annotation&gt;         &lt;documentation&gt;Silikongel&lt;/documentation&gt;       &lt;/annotation&gt;     &lt;/enumeration&gt;     &lt;enumeration value="0124003"&gt;       &lt;annotation&gt;         &lt;documentation&gt;Kombination Silikongel und Salzlösung&lt;/documentation&gt;       &lt;/annotation&gt;     &lt;/enumeration&gt;   &lt;/restriction&gt; &lt;/simpleType&gt; </pre>		



	<pre> &lt;enumeration value="0124042"&gt;   &lt;annotation&gt;     &lt;documentation&gt;sonstige&lt;/documentation&gt;   &lt;/annotation&gt; &lt;/enumeration&gt; &lt;/restriction&gt; &lt;/simpleType&gt; </pre>
--	---

### simpleType enum\_0126

namespace	http://xml.ir-d.de/irdma		
type	restriction of <b>string</b>		
properties	base xs:string		
facets	Kind	Value	Annotation
	enumeration	0126001	documentation anatomisch (tropfenförmig)
	enumeration	0126002	documentation rund (punktsymmetrisch)
	enumeration	0126042	documentation sonstige
annotation	documentation Kat_BI_Form		
source	<pre> &lt;simpleType name="enum_0126"&gt;   &lt;annotation&gt;     &lt;documentation&gt;Kat_BI_Form&lt;/documentation&gt;   &lt;/annotation&gt;   &lt;restriction base="xs:string"&gt;     &lt;enumeration value="0126001"&gt;       &lt;annotation&gt;         &lt;documentation&gt;anatomisch (tropfenförmig)&lt;/documentation&gt;       &lt;/annotation&gt;     &lt;/enumeration&gt;     &lt;enumeration value="0126002"&gt;       &lt;annotation&gt;         &lt;documentation&gt;rund (punktsymmetrisch)&lt;/documentation&gt;       &lt;/annotation&gt;     &lt;/enumeration&gt;     &lt;enumeration value="0126042"&gt;       &lt;annotation&gt;         &lt;documentation&gt;sonstige&lt;/documentation&gt;       &lt;/annotation&gt;     &lt;/enumeration&gt;   &lt;/restriction&gt; &lt;/simpleType&gt; </pre>		

### simpleType enum\_0128

namespace	http://xml.ir-d.de/irdma		
type	restriction of <b>string</b>		
properties	base xs:string		
facets	Kind	Value	Annotation
	enumeration	0128001	documentation glattwandig
	enumeration	0128002	documentation

	enumeration 0128003 documentation beschichtet texturiert
annotation	documentation Kat_BI_Oberflaeche
source	<pre> &lt;simpleType name="enum_0128"&gt;   &lt;annotation&gt;     &lt;documentation&gt;Kat_BI_Oberflaeche&lt;/documentation&gt;   &lt;/annotation&gt;   &lt;restriction base="xs:string"&gt;     &lt;enumeration value="0128001"&gt;       &lt;annotation&gt;         &lt;documentation&gt;glattwandig&lt;/documentation&gt;       &lt;/annotation&gt;     &lt;/enumeration&gt;     &lt;enumeration value="0128002"&gt;       &lt;annotation&gt;         &lt;documentation&gt;beschichtet&lt;/documentation&gt;       &lt;/annotation&gt;     &lt;/enumeration&gt;     &lt;enumeration value="0128003"&gt;       &lt;annotation&gt;         &lt;documentation&gt;texturiert&lt;/documentation&gt;       &lt;/annotation&gt;     &lt;/enumeration&gt;   &lt;/restriction&gt; &lt;/simpleType&gt; </pre>

### simpleType enum\_0130

namespace	http://xml.ir-d.de/irdma		
type	restriction of <b>string</b>		
properties	base xs:string		
facets	Kind	Value	Annotation
	enumeration	0130001	documentation Allergan
	enumeration	0130002	documentation Cereplas
	enumeration	0130003	documentation CUI (Cox Uphoff Implants)
	enumeration	0130004	documentation EMSI Biomedical
	enumeration	0130005	documentation Establishment labs
	enumeration	0130006	documentation Eurosilicone
	enumeration	0130007	documentation Nagor
	enumeration	0130008	documentation Groupe Sebbin
	enumeration	0130009	documentation Laboratoires Arion
	enumeration	0130010	documentation Mentor
	enumeration	0130011	documentation Pérouse Plastie SAS
	enumeration	0130012	documentation PIP M-Implants
	enumeration	0130013	documentation

	<p>enumeration 0130014 Polytech Health &amp; Aesthetics documentation Sillimed</p> <p>enumeration 0130015 documentation Surgitek</p> <p>enumeration 0130016 documentation G&amp;G Biotechnology</p> <p>enumeration 0130017 documentation nicht belegter Wert</p> <p>enumeration 0130018 documentation nicht belegter Wert</p> <p>enumeration 0130019 documentation nicht belegter Wert</p> <p>enumeration 0130020 documentation nicht belegter Wert</p> <p>enumeration 0130021 documentation nicht belegter Wert</p> <p>enumeration 0130042 documentation sonstiger</p>
annotation	documentation Kat_BI_Hersteller
source	<pre> &lt;simpleType name="enum_0130"&gt;   &lt;annotation&gt;     &lt;documentation&gt;Kat_BI_Hersteller&lt;/documentation&gt;   &lt;/annotation&gt;   &lt;restriction base="xs:string"&gt;     &lt;enumeration value="0130001"&gt;       &lt;annotation&gt;         &lt;documentation&gt;Allergan&lt;/documentation&gt;       &lt;/annotation&gt;     &lt;/enumeration&gt;     &lt;enumeration value="0130002"&gt;       &lt;annotation&gt;         &lt;documentation&gt;Cereplas&lt;/documentation&gt;       &lt;/annotation&gt;     &lt;/enumeration&gt;     &lt;enumeration value="0130003"&gt;       &lt;annotation&gt;         &lt;documentation&gt;CUI (Cox Uphoff Implants)&lt;/documentation&gt;       &lt;/annotation&gt;     &lt;/enumeration&gt;     &lt;enumeration value="0130004"&gt;       &lt;annotation&gt;         &lt;documentation&gt;EMSI Biomedical&lt;/documentation&gt;       &lt;/annotation&gt;     &lt;/enumeration&gt;     &lt;enumeration value="0130005"&gt;       &lt;annotation&gt;         &lt;documentation&gt;Establishment labs&lt;/documentation&gt;       &lt;/annotation&gt;     &lt;/enumeration&gt;     &lt;enumeration value="0130006"&gt;       &lt;annotation&gt;         &lt;documentation&gt;Eurosilicone&lt;/documentation&gt;       &lt;/annotation&gt;     &lt;/enumeration&gt;     &lt;enumeration value="0130007"&gt;       &lt;annotation&gt;         &lt;documentation&gt;Nagor&lt;/documentation&gt;       &lt;/annotation&gt;     &lt;/enumeration&gt;   &lt;/restriction&gt; &lt;/simpleType&gt; </pre>

```
<enumeration value="0130008">
  <annotation>
    <documentation>Groupe Sebbin</documentation>
  </annotation>
</enumeration>
<enumeration value="0130009">
  <annotation>
    <documentation>Laboratoires Arion</documentation>
  </annotation>
</enumeration>
<enumeration value="0130010">
  <annotation>
    <documentation>Mentor</documentation>
  </annotation>
</enumeration>
<enumeration value="0130011">
  <annotation>
    <documentation>Pérouse Plastie SAS</documentation>
  </annotation>
</enumeration>
<enumeration value="0130012">
  <annotation>
    <documentation>PIP M-Implants</documentation>
  </annotation>
</enumeration>
<enumeration value="0130013">
  <annotation>
    <documentation>Polytech Health & Aesthetics</documentation>
  </annotation>
</enumeration>
<enumeration value="0130014">
  <annotation>
    <documentation>Silimed</documentation>
  </annotation>
</enumeration>
<enumeration value="0130015">
  <annotation>
    <documentation>Surgitek</documentation>
  </annotation>
</enumeration>
<enumeration value="0130016">
  <annotation>
    <documentation>G&G Biotechnology</documentation>
  </annotation>
</enumeration>
<enumeration value="0130017">
  <annotation>
    <documentation>nicht belegter Wert</documentation>
  </annotation>
</enumeration>
<enumeration value="0130018">
  <annotation>
    <documentation>nicht belegter Wert</documentation>
  </annotation>
</enumeration>
<enumeration value="0130019">
  <annotation>
    <documentation>nicht belegter Wert</documentation>
  </annotation>
</enumeration>
```

```

</enumeration>
<enumeration value="0130020">
  <annotation>
    <documentation>nicht belegter Wert</documentation>
  </annotation>
</enumeration>
<enumeration value="0130021">
  <annotation>
    <documentation>nicht belegter Wert</documentation>
  </annotation>
</enumeration>
<enumeration value="0130042">
  <annotation>
    <documentation>sonstiger</documentation>
  </annotation>
</enumeration>
</restriction>
</simpleType>

```

simpleType **enum\_0131**

namespace	http://xml.ir-d.de/irdma		
type	restriction of <b>string</b>		
properties	base xs:string		
facets	Kind	Value	Annotation
	enumeration	0131001	documentation Allergan
	enumeration	0131002	documentation Establishment labs
	enumeration	0131003	documentation Eurosilicone
	enumeration	0131004	documentation Galatea
	enumeration	0131005	documentation Integra
	enumeration	0131006	documentation Lifecell
	enumeration	0131007	documentation MBP (Medical Biomaterial Products)
	enumeration	0131008	documentation Mentor
	enumeration	0131009	documentation Novus Scientific
	enumeration	0131010	documentation pfmMedical
	enumeration	0131011	documentation nicht belegter Wert
	enumeration	0131012	documentation nicht belegter Wert
	enumeration	0131013	documentation nicht belegter Wert
	enumeration	0131014	documentation nicht belegter Wert
	enumeration	0131015	documentation nicht belegter Wert
	enumeration	0131042	documentation sonstiger
annotation	documentation Kat BI ZubehoerHersteller		

source

```
<simpleType name="enum_0131">
  <annotation>
    <documentation>Kat_BI_ZubehoerHersteller</documentation>
  </annotation>
  <restriction base="xs:string">
    <enumeration value="0131001">
      <annotation>
        <documentation>Allergan</documentation>
      </annotation>
    </enumeration>
    <enumeration value="0131002">
      <annotation>
        <documentation>Establishment labs</documentation>
      </annotation>
    </enumeration>
    <enumeration value="0131003">
      <annotation>
        <documentation>Eurosilicone</documentation>
      </annotation>
    </enumeration>
    <enumeration value="0131004">
      <annotation>
        <documentation>Galatea</documentation>
      </annotation>
    </enumeration>
    <enumeration value="0131005">
      <annotation>
        <documentation>Integra</documentation>
      </annotation>
    </enumeration>
    <enumeration value="0131006">
      <annotation>
        <documentation>Lifecell</documentation>
      </annotation>
    </enumeration>
    <enumeration value="0131007">
      <annotation>
        <documentation>MBP (Medical Biomaterial Products)</documentation>
      </annotation>
    </enumeration>
    <enumeration value="0131008">
      <annotation>
        <documentation>Mentor</documentation>
      </annotation>
    </enumeration>
    <enumeration value="0131009">
      <annotation>
        <documentation>Novus Scientific</documentation>
      </annotation>
    </enumeration>
    <enumeration value="0131010">
      <annotation>
        <documentation>pfmMedical</documentation>
      </annotation>
    </enumeration>
    <enumeration value="0131011">
      <annotation>
        <documentation>nicht belegter Wert</documentation>
      </annotation>
    </enumeration>
  </restriction>
</simpleType>
```

	<pre> &lt;/enumeration&gt; &lt;enumeration value="0131012"&gt;   &lt;annotation&gt;     &lt;documentation&gt;nicht belegter Wert&lt;/documentation&gt;   &lt;/annotation&gt; &lt;/enumeration&gt; &lt;enumeration value="0131013"&gt;   &lt;annotation&gt;     &lt;documentation&gt;nicht belegter Wert&lt;/documentation&gt;   &lt;/annotation&gt; &lt;/enumeration&gt; &lt;enumeration value="0131014"&gt;   &lt;annotation&gt;     &lt;documentation&gt;nicht belegter Wert&lt;/documentation&gt;   &lt;/annotation&gt; &lt;/enumeration&gt; &lt;enumeration value="0131015"&gt;   &lt;annotation&gt;     &lt;documentation&gt;nicht belegter Wert&lt;/documentation&gt;   &lt;/annotation&gt; &lt;/enumeration&gt; &lt;enumeration value="0131042"&gt;   &lt;annotation&gt;     &lt;documentation&gt;sonstiger&lt;/documentation&gt;   &lt;/annotation&gt; &lt;/enumeration&gt; &lt;/restriction&gt; &lt;/simpleType&gt; </pre>
--	---

### simpleType enum\_0190

namespace	http://xml.ir-d.de/irdma		
type	restriction of <b>string</b>		
properties	base xs:string		
facets	Kind	Value	Annotation
	enumeration	0190001	documentation Brustimplantat
	enumeration	0190003	documentation Brustexpander
annotation	documentation Kat_BI_Artikeltyp		
source	<pre> &lt;simpleType name="enum_0190"&gt;   &lt;annotation&gt;     &lt;documentation&gt;Kat_BI_Artikeltyp&lt;/documentation&gt;   &lt;/annotation&gt;   &lt;restriction base="xs:string"&gt;     &lt;enumeration value="0190001"&gt;       &lt;annotation&gt;         &lt;documentation&gt;Brustimplantat&lt;/documentation&gt;       &lt;/annotation&gt;     &lt;/enumeration&gt;     &lt;enumeration value="0190003"&gt;       &lt;annotation&gt;         &lt;documentation&gt;Brustexpander&lt;/documentation&gt;       &lt;/annotation&gt;     &lt;/enumeration&gt;   &lt;/restriction&gt; </pre>		

	<code>&lt;/simpleType&gt;</code>
--	----------------------------------

### simpleType enum\_0191

namespace	http://xml.ir-d.de/irdma		
type	restriction of <b>string</b>		
properties	base xs:string		
facets	Kind	Value	Annotation
	enumeration	0191001	documentation Netz
	enumeration	0191002	documentation ADM
annotation	documentation Kat_BI_ZubehoerTyp		
source	<pre> &lt;simpleType name="enum_0191"&gt;   &lt;annotation&gt;     &lt;documentation&gt;Kat_BI_ZubehoerTyp&lt;/documentation&gt;   &lt;/annotation&gt;   &lt;restriction base="xs:string"&gt;     &lt;enumeration value="0191001"&gt;       &lt;annotation&gt;         &lt;documentation&gt;Netz&lt;/documentation&gt;       &lt;/annotation&gt;     &lt;/enumeration&gt;     &lt;enumeration value="0191002"&gt;       &lt;annotation&gt;         &lt;documentation&gt;ADM&lt;/documentation&gt;       &lt;/annotation&gt;     &lt;/enumeration&gt;   &lt;/restriction&gt; &lt;/simpleType&gt; </pre>		

### simpleType enum\_0200

namespace	http://xml.ir-d.de/irdma		
type	restriction of <b>string</b>		
properties	base xs:string		
facets	Kind	Value	Annotation
	enumeration	0200001	documentation Erst-OP
	enumeration	0200002	documentation Folgeeingriff
annotation	documentation Kat_EP_ArtEingriff		
source	<pre> &lt;simpleType name="enum_0200"&gt;   &lt;annotation&gt;     &lt;documentation&gt;Kat_EP_ArtEingriff&lt;/documentation&gt;   &lt;/annotation&gt;   &lt;restriction base="xs:string"&gt;     &lt;enumeration value="0200001"&gt;       &lt;annotation&gt;         &lt;documentation&gt;Erst-OP&lt;/documentation&gt;       &lt;/annotation&gt;     &lt;/enumeration&gt; </pre>		



	<pre> &lt;enumeration value="0200002"&gt;   &lt;annotation&gt;     &lt;documentation&gt;Folgeeingriff&lt;/documentation&gt;   &lt;/annotation&gt; &lt;/enumeration&gt; &lt;/restriction&gt; &lt;/simpleType&gt; </pre>
--	--

### simpleType enum\_0202

namespace	http://xml.ir-d.de/irdma		
type	restriction of <b>string</b>		
properties	base xs:string		
facets	Kind	Value	Annotation
	enumeration	0202001	documentation Lockerung
	enumeration	0202002	documentation Infektion, Verdacht auf
	enumeration	0202003	documentation Infektion, gesichert
	enumeration	0202004	documentation Luxation, Inlay aus der Pfanne
	enumeration	0202005	documentation Luxation, Kopf aus Pfanne/Inlay
	enumeration	0202006	documentation Periprothetische Fraktur
	enumeration	0202007	documentation Verschleiß des PE-Inlays
	enumeration	0202008	documentation Implantatbruch
	enumeration	0202009	documentation Implantatfehlage/Malalignent
	enumeration	0202010	documentation Osteolysen bei festem Implantat
	enumeration	0202011	documentation Progression der Grunderkrankung
	enumeration	0202012	documentation ARMD
	enumeration	0202013	documentation Verdacht auf allergische Reaktion
	enumeration	0202021	documentation Zustand nach Prothesenentfernung
	enumeration	0202042	documentation andere Gründe
annotation	documentation Kat_EP_GrundWechselHuefte		
source	<pre> &lt;simpleType name="enum_0202"&gt;   &lt;annotation&gt;     &lt;documentation&gt;Kat_EP_GrundWechselHuefte&lt;/documentation&gt;   &lt;/annotation&gt;   &lt;restriction base="xs:string"&gt;     &lt;enumeration value="0202001"&gt;       &lt;annotation&gt;         &lt;documentation&gt;Lockerung&lt;/documentation&gt;       &lt;/annotation&gt;     &lt;/enumeration&gt;     &lt;enumeration value="0202002"&gt;       &lt;annotation&gt;         &lt;documentation&gt;Infektion, Verdacht auf&lt;/documentation&gt;       &lt;/annotation&gt;     &lt;/enumeration&gt;   &lt;/restriction&gt; &lt;/simpleType&gt; </pre>		

```
</annotation>
</enumeration>
<enumeration value="0202003">
  <annotation>
    <documentation>Infektion, gesichert</documentation>
  </annotation>
</enumeration>
<enumeration value="0202004">
  <annotation>
    <documentation>Luxation, Inlay aus der Pfanne</documentation>
  </annotation>
</enumeration>
<enumeration value="0202005">
  <annotation>
    <documentation>Luxation, Kopf aus Pfanne/Inlay</documentation>
  </annotation>
</enumeration>
<enumeration value="0202006">
  <annotation>
    <documentation>Periprothetische Fraktur</documentation>
  </annotation>
</enumeration>
<enumeration value="0202007">
  <annotation>
    <documentation>Verschleiß des PE-Inlays</documentation>
  </annotation>
</enumeration>
<enumeration value="0202008">
  <annotation>
    <documentation>Implantatbruch</documentation>
  </annotation>
</enumeration>
<enumeration value="0202009">
  <annotation>
    <documentation>Implantatfehllage/Malalignent</documentation>
  </annotation>
</enumeration>
<enumeration value="0202010">
  <annotation>
    <documentation>Osteolysen bei festem Implantat</documentation>
  </annotation>
</enumeration>
<enumeration value="0202011">
  <annotation>
    <documentation>Progression der Grunderkrankung</documentation>
  </annotation>
</enumeration>
<enumeration value="0202012">
  <annotation>
    <documentation>ARMD</documentation>
  </annotation>
</enumeration>
<enumeration value="0202013">
  <annotation>
    <documentation>Verdacht auf allergische Reaktion</documentation>
  </annotation>
</enumeration>
<enumeration value="0202021">
  <annotation>
```

	<pre> &lt;documentation&gt;Zustand nach Prothesenentfernung&lt;/documentation&gt; &lt;/annotation&gt; &lt;/enumeration&gt; &lt;enumeration value="0202042"&gt;   &lt;annotation&gt;     &lt;documentation&gt;andere Gründe&lt;/documentation&gt;   &lt;/annotation&gt; &lt;/enumeration&gt; &lt;/restriction&gt; &lt;/simpleType&gt; </pre>
--	---

### simpleType enum\_0204

namespace	http://xml.ir-d.de/irdma		
type	restriction of <b>string</b>		
properties	base xs:string		
facets	Kind	Value	Annotation
	enumeration	0204001	documentation Lockerung
	enumeration	0204002	documentation Infektion, Verdacht auf
	enumeration	0204003	documentation Infektion, gesichert
	enumeration	0204006	documentation Periprothetische Fraktur
	enumeration	0204007	documentation Verschleiß
	enumeration	0204008	documentation Implantatbruch
	enumeration	0204009	documentation Implantatfehlage/Malalignent
	enumeration	0204010	documentation Osteolysen bei festem Implantat
	enumeration	0204011	documentation Progression der Grunderkrankung
	enumeration	0204012	documentation ARMD
	enumeration	0204013	documentation Verdacht auf allergische Reaktion
	enumeration	0204014	documentation Dislokation/Migration von Komponenten
	enumeration	0204015	documentation Bandinstabilität
	enumeration	0204016	documentation Bewegungseinschränkung
	enumeration	0204021	documentation Zustand nach Prothesenentfernung
	enumeration	0204042	documentation andere Gründe
annotation	documentation Kat_EP_GrundWechselKnie		
source	<pre> &lt;simpleType name="enum_0204"&gt;   &lt;annotation&gt;     &lt;documentation&gt;Kat_EP_GrundWechselKnie&lt;/documentation&gt;   &lt;/annotation&gt;   &lt;restriction base="xs:string"&gt;     &lt;enumeration value="0204001"&gt;       &lt;annotation&gt;         &lt;documentation&gt;Lockerung&lt;/documentation&gt; </pre>		

```
</annotation>
</enumeration>
<enumeration value="0204002">
  <annotation>
    <documentation>Infektion, Verdacht auf</documentation>
  </annotation>
</enumeration>
<enumeration value="0204003">
  <annotation>
    <documentation>Infektion, gesichert</documentation>
  </annotation>
</enumeration>
<enumeration value="0204006">
  <annotation>
    <documentation>Periprothetische Fraktur</documentation>
  </annotation>
</enumeration>
<enumeration value="0204007">
  <annotation>
    <documentation>Verschleiß</documentation>
  </annotation>
</enumeration>
<enumeration value="0204008">
  <annotation>
    <documentation>Implantatbruch</documentation>
  </annotation>
</enumeration>
<enumeration value="0204009">
  <annotation>
    <documentation>Implantatfehlage/Malalignent</documentation>
  </annotation>
</enumeration>
<enumeration value="0204010">
  <annotation>
    <documentation>Osteolysen bei festem Implantat</documentation>
  </annotation>
</enumeration>
<enumeration value="0204011">
  <annotation>
    <documentation>Progression der Grunderkrankung</documentation>
  </annotation>
</enumeration>
<enumeration value="0204012">
  <annotation>
    <documentation>ARMD</documentation>
  </annotation>
</enumeration>
<enumeration value="0204013">
  <annotation>
    <documentation>Verdacht auf allergische Reaktion</documentation>
  </annotation>
</enumeration>
<enumeration value="0204014">
  <annotation>
    <documentation>Dislokation/Migration von Komponenten</documentation>
  </annotation>
</enumeration>
<enumeration value="0204015">
  <annotation>
```

```

    <documentation>Bandinstabilität</documentation>
  </annotation>
</enumeration>
<enumeration value="0204016">
  <annotation>
    <documentation>Bewegungseinschränkung</documentation>
  </annotation>
</enumeration>
<enumeration value="0204021">
  <annotation>
    <documentation>Zustand nach Prothesenentfernung</documentation>
  </annotation>
</enumeration>
<enumeration value="0204042">
  <annotation>
    <documentation>andere Gründe</documentation>
  </annotation>
</enumeration>
</restriction>
</simpleType>

```

simpleType **enum\_0206**

namespace	http://xml.ir-d.de/irdma		
type	restriction of <b>string</b>		
properties	base xs:string		
facets	Kind	Value	Annotation
	enumeration	0206001	documentation Lockerung
	enumeration	0206002	documentation Infektion, Verdacht auf
	enumeration	0206003	documentation Infektion, gesichert
	enumeration	0206004	documentation Luxation, Inlay aus der Pfanne
	enumeration	0206005	documentation Luxation, Kopf aus Pfanne/Inlay
	enumeration	0206006	documentation Periprothetische Fraktur
	enumeration	0206007	documentation Verschleiß
	enumeration	0206008	documentation Implantatbruch
	enumeration	0206009	documentation Implantatfehlage/Malalignent
	enumeration	0206010	documentation Osteolysen bei festem Implantat
	enumeration	0206011	documentation Progression der Grunderkrankung
	enumeration	0206012	documentation ARMD
	enumeration	0206013	documentation Verdacht auf allergische Reaktion
	enumeration	0206014	documentation Dislokation/Migration von Komponenten
	enumeration	0206015	documentation Bandinstabilität
	enumeration	0206016	documentation Bewegungseinschränkung

	<p>enumeration 0206021 documentation Zustand nach Prothesenentfernung</p> <p>enumeration 0206042 documentation andere Gründe</p>
annotation	<p>documentation Kat_EP_GrundWechselTFE</p>
source	<pre> &lt;simpleType name="enum_0206"&gt;   &lt;annotation&gt;     &lt;documentation&gt;Kat_EP_GrundWechselTFE&lt;/documentation&gt;   &lt;/annotation&gt;   &lt;restriction base="xs:string"&gt;     &lt;enumeration value="0206001"&gt;       &lt;annotation&gt;         &lt;documentation&gt;Lockerung&lt;/documentation&gt;       &lt;/annotation&gt;     &lt;/enumeration&gt;     &lt;enumeration value="0206002"&gt;       &lt;annotation&gt;         &lt;documentation&gt;Infektion, Verdacht auf&lt;/documentation&gt;       &lt;/annotation&gt;     &lt;/enumeration&gt;     &lt;enumeration value="0206003"&gt;       &lt;annotation&gt;         &lt;documentation&gt;Infektion, gesichert&lt;/documentation&gt;       &lt;/annotation&gt;     &lt;/enumeration&gt;     &lt;enumeration value="0206004"&gt;       &lt;annotation&gt;         &lt;documentation&gt;Luxation, Inlay aus der Pfanne&lt;/documentation&gt;       &lt;/annotation&gt;     &lt;/enumeration&gt;     &lt;enumeration value="0206005"&gt;       &lt;annotation&gt;         &lt;documentation&gt;Luxation, Kopf aus Pfanne/Inlay&lt;/documentation&gt;       &lt;/annotation&gt;     &lt;/enumeration&gt;     &lt;enumeration value="0206006"&gt;       &lt;annotation&gt;         &lt;documentation&gt;Periprothetische Fraktur&lt;/documentation&gt;       &lt;/annotation&gt;     &lt;/enumeration&gt;     &lt;enumeration value="0206007"&gt;       &lt;annotation&gt;         &lt;documentation&gt;Verschleiß&lt;/documentation&gt;       &lt;/annotation&gt;     &lt;/enumeration&gt;     &lt;enumeration value="0206008"&gt;       &lt;annotation&gt;         &lt;documentation&gt;Implantatbruch&lt;/documentation&gt;       &lt;/annotation&gt;     &lt;/enumeration&gt;     &lt;enumeration value="0206009"&gt;       &lt;annotation&gt;         &lt;documentation&gt;Implantatfehllage/Malalignent&lt;/documentation&gt;       &lt;/annotation&gt;     &lt;/enumeration&gt;     &lt;enumeration value="0206010"&gt;       &lt;annotation&gt;         &lt;documentation&gt;Osteolysen bei festem Implantat&lt;/documentation&gt;       &lt;/annotation&gt;     &lt;/enumeration&gt;   &lt;/restriction&gt; &lt;/simpleType&gt; </pre>

```

</annotation>
</enumeration>
<enumeration value="0206011">
  <annotation>
    <documentation>Progression der Grunderkrankung</documentation>
  </annotation>
</enumeration>
<enumeration value="0206012">
  <annotation>
    <documentation>ARMD</documentation>
  </annotation>
</enumeration>
<enumeration value="0206013">
  <annotation>
    <documentation>Verdacht auf allergische Reaktion</documentation>
  </annotation>
</enumeration>
<enumeration value="0206014">
  <annotation>
    <documentation>Dislokation/Migration von Komponenten</documentation>
  </annotation>
</enumeration>
<enumeration value="0206015">
  <annotation>
    <documentation>Bandinstabilität</documentation>
  </annotation>
</enumeration>
<enumeration value="0206016">
  <annotation>
    <documentation>Bewegungseinschränkung</documentation>
  </annotation>
</enumeration>
<enumeration value="0206021">
  <annotation>
    <documentation>Zustand nach Prothesenentfernung</documentation>
  </annotation>
</enumeration>
<enumeration value="0206042">
  <annotation>
    <documentation>andere Gründe</documentation>
  </annotation>
</enumeration>
</restriction>
</simpleType>

```

### simpleType enum\_0210

namespace	http://xml.ir-d.de/irdma		
type	restriction of <b>string</b>		
properties	base xs:string		
facets	Kind	Value	Annotation
	enumeration	0210001	documentation keine relevante Voroperation
	enumeration	0210002	documentation Osteosynthese/Osteotomie (Becken)
	enumeration	0210003	documentation Osteosynthese/Osteotomie (Femur)

	enumeration 0210004 documentation Osteosynthese/Osteotomie (beides) enumeration 0210005 documentation Operation bei Hüftkopfnekrose enumeration 0210006 documentation Arthrodese enumeration 0210042 documentation andere
annotation	documentation Kat_EP_VoroperationHuefte
source	<pre> &lt;simpleType name="enum_0210"&gt;   &lt;annotation&gt;     &lt;documentation&gt;Kat_EP_VoroperationHuefte&lt;/documentation&gt;   &lt;/annotation&gt;   &lt;restriction base="xs:string"&gt;     &lt;enumeration value="0210001"&gt;       &lt;annotation&gt;         &lt;documentation&gt;keine relevante Voroperation&lt;/documentation&gt;       &lt;/annotation&gt;     &lt;/enumeration&gt;     &lt;enumeration value="0210002"&gt;       &lt;annotation&gt;         &lt;documentation&gt;Osteosynthese/Osteotomie (Becken)&lt;/documentation&gt;       &lt;/annotation&gt;     &lt;/enumeration&gt;     &lt;enumeration value="0210003"&gt;       &lt;annotation&gt;         &lt;documentation&gt;Osteosynthese/Osteotomie (Femur)&lt;/documentation&gt;       &lt;/annotation&gt;     &lt;/enumeration&gt;     &lt;enumeration value="0210004"&gt;       &lt;annotation&gt;         &lt;documentation&gt;Osteosynthese/Osteotomie (beides)&lt;/documentation&gt;       &lt;/annotation&gt;     &lt;/enumeration&gt;     &lt;enumeration value="0210005"&gt;       &lt;annotation&gt;         &lt;documentation&gt;Operation bei Hüftkopfnekrose&lt;/documentation&gt;       &lt;/annotation&gt;     &lt;/enumeration&gt;     &lt;enumeration value="0210006"&gt;       &lt;annotation&gt;         &lt;documentation&gt;Arthrodese&lt;/documentation&gt;       &lt;/annotation&gt;     &lt;/enumeration&gt;     &lt;enumeration value="0210042"&gt;       &lt;annotation&gt;         &lt;documentation&gt;andere&lt;/documentation&gt;       &lt;/annotation&gt;     &lt;/enumeration&gt;   &lt;/restriction&gt; &lt;/simpleType&gt; </pre>

### simpleType enum\_0211

namespace	http://xml.ir-d.de/irdma
type	restriction of <b>string</b>



properties	base xs:string																											
facets	<table border="1"> <thead> <tr> <th>Kind</th> <th>Value</th> <th>Annotation</th> </tr> </thead> <tbody> <tr> <td>enumeration</td> <td>0211001</td> <td>documentation keine relevante Voroperation</td> </tr> <tr> <td>enumeration</td> <td>0211002</td> <td>documentation Osteosynthese/Osteotomie (Femur)</td> </tr> <tr> <td>enumeration</td> <td>0211003</td> <td>documentation Osteosynthese/Osteotomie (Tibia)</td> </tr> <tr> <td>enumeration</td> <td>0211004</td> <td>documentation Osteosynthese/Osteotomie (Patella)</td> </tr> <tr> <td>enumeration</td> <td>0211005</td> <td>documentation Osteosynthese/Osteotomie (mehrere)</td> </tr> <tr> <td>enumeration</td> <td>0211006</td> <td>documentation Kapsel-/Bandapparat</td> </tr> <tr> <td>enumeration</td> <td>0211007</td> <td>documentation Arthrodese</td> </tr> <tr> <td>enumeration</td> <td>0211042</td> <td>documentation andere</td> </tr> </tbody> </table>	Kind	Value	Annotation	enumeration	0211001	documentation keine relevante Voroperation	enumeration	0211002	documentation Osteosynthese/Osteotomie (Femur)	enumeration	0211003	documentation Osteosynthese/Osteotomie (Tibia)	enumeration	0211004	documentation Osteosynthese/Osteotomie (Patella)	enumeration	0211005	documentation Osteosynthese/Osteotomie (mehrere)	enumeration	0211006	documentation Kapsel-/Bandapparat	enumeration	0211007	documentation Arthrodese	enumeration	0211042	documentation andere
Kind	Value	Annotation																										
enumeration	0211001	documentation keine relevante Voroperation																										
enumeration	0211002	documentation Osteosynthese/Osteotomie (Femur)																										
enumeration	0211003	documentation Osteosynthese/Osteotomie (Tibia)																										
enumeration	0211004	documentation Osteosynthese/Osteotomie (Patella)																										
enumeration	0211005	documentation Osteosynthese/Osteotomie (mehrere)																										
enumeration	0211006	documentation Kapsel-/Bandapparat																										
enumeration	0211007	documentation Arthrodese																										
enumeration	0211042	documentation andere																										
annotation	documentation Kat_EP_VoroperationKnie																											
source	<pre> &lt;simpleType name="enum_0211"&gt;   &lt;annotation&gt;     &lt;documentation&gt;Kat_EP_VoroperationKnie&lt;/documentation&gt;   &lt;/annotation&gt;   &lt;restriction base="xs:string"&gt;     &lt;enumeration value="0211001"&gt;       &lt;annotation&gt;         &lt;documentation&gt;keine relevante Voroperation&lt;/documentation&gt;       &lt;/annotation&gt;     &lt;/enumeration&gt;     &lt;enumeration value="0211002"&gt;       &lt;annotation&gt;         &lt;documentation&gt;Osteosynthese/Osteotomie (Femur)&lt;/documentation&gt;       &lt;/annotation&gt;     &lt;/enumeration&gt;     &lt;enumeration value="0211003"&gt;       &lt;annotation&gt;         &lt;documentation&gt;Osteosynthese/Osteotomie (Tibia)&lt;/documentation&gt;       &lt;/annotation&gt;     &lt;/enumeration&gt;     &lt;enumeration value="0211004"&gt;       &lt;annotation&gt;         &lt;documentation&gt;Osteosynthese/Osteotomie (Patella)&lt;/documentation&gt;       &lt;/annotation&gt;     &lt;/enumeration&gt;     &lt;enumeration value="0211005"&gt;       &lt;annotation&gt;         &lt;documentation&gt;Osteosynthese/Osteotomie (mehrere)&lt;/documentation&gt;       &lt;/annotation&gt;     &lt;/enumeration&gt;     &lt;enumeration value="0211006"&gt;       &lt;annotation&gt;         &lt;documentation&gt;Kapsel-/Bandapparat&lt;/documentation&gt;       &lt;/annotation&gt;     &lt;/enumeration&gt;     &lt;enumeration value="0211007"&gt;       &lt;annotation&gt;         &lt;documentation&gt;Arthrodese&lt;/documentation&gt;       &lt;/annotation&gt;     &lt;/enumeration&gt;   &lt;/restriction&gt; &lt;/simpleType&gt; </pre>																											

	<pre> &lt;enumeration value="0211042"&gt;   &lt;annotation&gt;     &lt;documentation&gt;andere&lt;/documentation&gt;   &lt;/annotation&gt; &lt;/enumeration&gt; &lt;/restriction&gt; &lt;/simpleType&gt; </pre>
--	---

### simpleType enum\_0212

namespace	http://xml.ir-d.de/irdma		
type	restriction of <b>string</b>		
properties	base xs:string		
facets	Kind	Value	Annotation
	enumeration	0212001	documentation Hüfte
	enumeration	0212002	documentation Knie
	enumeration	0212003	documentation Totaler Femurersatz inkl. Durchsteck-Prothese
annotation	documentation Kat_EP_Gelenk		
source	<pre> &lt;simpleType name="enum_0212"&gt;   &lt;annotation&gt;     &lt;documentation&gt;Kat_EP_Gelenk&lt;/documentation&gt;   &lt;/annotation&gt;   &lt;restriction base="xs:string"&gt;     &lt;enumeration value="0212001"&gt;       &lt;annotation&gt;         &lt;documentation&gt;Hüfte&lt;/documentation&gt;       &lt;/annotation&gt;     &lt;/enumeration&gt;     &lt;enumeration value="0212002"&gt;       &lt;annotation&gt;         &lt;documentation&gt;Knie&lt;/documentation&gt;       &lt;/annotation&gt;     &lt;/enumeration&gt;     &lt;enumeration value="0212003"&gt;       &lt;annotation&gt;         &lt;documentation&gt;Totaler Femurersatz inkl. Durchsteck-Prothese&lt;/documentation&gt;       &lt;/annotation&gt;     &lt;/enumeration&gt;   &lt;/restriction&gt; &lt;/simpleType&gt; </pre>		

### simpleType enum\_0220

namespace	http://xml.ir-d.de/irdma		
type	restriction of <b>string</b>		
properties	base xs:string		
facets	Kind	Value	Annotation
	enumeration	0220001	documentation anterior

	enumeration 0220002 documentation anterolateral enumeration 0220003 documentation lateral enumeration 0220004 documentation posterior enumeration 0220005 documentation posterolateral enumeration 0220006 documentation 2-Inzisionen-Zugang enumeration 0220042 documentation sonstiges/unbekannt
annotation	documentation Kat_EP_Operationszugang
source	<pre> &lt;simpleType name="enum_0220"&gt;   &lt;annotation&gt;     &lt;documentation&gt;Kat_EP_Operationszugang&lt;/documentation&gt;   &lt;/annotation&gt;   &lt;restriction base="xs:string"&gt;     &lt;enumeration value="0220001"&gt;       &lt;annotation&gt;         &lt;documentation&gt;anterior&lt;/documentation&gt;       &lt;/annotation&gt;     &lt;/enumeration&gt;     &lt;enumeration value="0220002"&gt;       &lt;annotation&gt;         &lt;documentation&gt;anterolateral&lt;/documentation&gt;       &lt;/annotation&gt;     &lt;/enumeration&gt;     &lt;enumeration value="0220003"&gt;       &lt;annotation&gt;         &lt;documentation&gt;lateral&lt;/documentation&gt;       &lt;/annotation&gt;     &lt;/enumeration&gt;     &lt;enumeration value="0220004"&gt;       &lt;annotation&gt;         &lt;documentation&gt;posterior&lt;/documentation&gt;       &lt;/annotation&gt;     &lt;/enumeration&gt;     &lt;enumeration value="0220005"&gt;       &lt;annotation&gt;         &lt;documentation&gt;posterolateral&lt;/documentation&gt;       &lt;/annotation&gt;     &lt;/enumeration&gt;     &lt;enumeration value="0220006"&gt;       &lt;annotation&gt;         &lt;documentation&gt;2-Inzisionen-Zugang&lt;/documentation&gt;       &lt;/annotation&gt;     &lt;/enumeration&gt;     &lt;enumeration value="0220042"&gt;       &lt;annotation&gt;         &lt;documentation&gt;sonstiges/unbekannt&lt;/documentation&gt;       &lt;/annotation&gt;     &lt;/enumeration&gt;   &lt;/restriction&gt; &lt;/simpleType&gt; </pre>

### simpleType enum\_0222

namespace	http://xml.ir-d.de/irdma		
type	restriction of <b>string</b>		
properties	base xs:string		
facets	Kind	Value	Annotation
	enumeration	0222001	documentation nein
	enumeration	0222002	documentation ja- Ausbau
	enumeration	0222003	documentation ja- Einbau
annotation	documentation Kat_EP_Zweizeitwechsel		
source	<pre> &lt;simpleType name="enum_0222"&gt;   &lt;annotation&gt;     &lt;documentation&gt;Kat_EP_Zweizeitwechsel&lt;/documentation&gt;   &lt;/annotation&gt;   &lt;restriction base="xs:string"&gt;     &lt;enumeration value="0222001"&gt;       &lt;annotation&gt;         &lt;documentation&gt;nein&lt;/documentation&gt;       &lt;/annotation&gt;     &lt;/enumeration&gt;     &lt;enumeration value="0222002"&gt;       &lt;annotation&gt;         &lt;documentation&gt;ja- Ausbau&lt;/documentation&gt;       &lt;/annotation&gt;     &lt;/enumeration&gt;     &lt;enumeration value="0222003"&gt;       &lt;annotation&gt;         &lt;documentation&gt;ja- Einbau&lt;/documentation&gt;       &lt;/annotation&gt;     &lt;/enumeration&gt;   &lt;/restriction&gt; &lt;/simpleType&gt; </pre>		

### simpleType enum\_0230

namespace	http://xml.ir-d.de/irdma		
type	restriction of <b>string</b>		
properties	base xs:string		
facets	Kind	Value	Annotation
	enumeration	0230001	documentation Smith & Nephew GmbH
	enumeration	0230002	documentation Mathys Orthopädie GmbH
	enumeration	0230003	documentation Ceramtec AG
	enumeration	0230004	documentation Biomet
	enumeration	0230005	documentation Peter Brehm GmbH
	enumeration	0230006	documentation Amplitude GmbH
	enumeration	0230007	documentation Exactech Deutschland

enumeration	0230008	documentation Globus Medical
enumeration	0230009	documentation Implantcast GmbH
enumeration	0230010	documentation DePuy Orthopädie GmbH (J&J)
enumeration	0230011	documentation IO-International Orthopaedics
enumeration	0230012	documentation Joint Replacement Ltd. Instrumentation
enumeration	0230013	documentation Merete
enumeration	0230014	documentation S&G Implants GmbH
enumeration	0230015	documentation Speetec Implantate GmbH
enumeration	0230016	documentation Stemcup Medical Products GmbH
enumeration	0230017	documentation Symbios Deutschland GmbH
enumeration	0230018	documentation Tantum AG
enumeration	0230019	documentation Tomier GmbH
enumeration	0230020	documentation MicroPort Orthopedics GmbH
enumeration	0230021	documentation aap Implanate AG
enumeration	0230022	documentation AQImplants
enumeration	0230023	documentation ESKA Orthodynamics GmbH
enumeration	0230024	documentation Ateos medical AG
enumeration	0230025	documentation Chiropro GmbH
enumeration	0230026	documentation Medacta
enumeration	0230027	documentation OHST Medizintechnik AG
enumeration	0230028	documentation Lima Deutschland GmbH
enumeration	0230029	documentation alloPlus GmbH
enumeration	0230030	documentation Heraeus Medical GmbH
enumeration	0230031	documentation ImplanTec Deutschland GmbH
enumeration	0230032	documentation Falcon Medical GmbH
enumeration	0230033	documentation Meril GmbH
enumeration	0230034	documentation Zimmer Germany GmbH
enumeration	0230035	documentation Stryker GmbH & Co. KG
enumeration	0230036	documentation Aesculap AG
enumeration	0230037	documentation Waldemar Link GmbH & Co. KG
enumeration	0230038	documentation Corin Germany GmbH
enumeration	0230039	documentation ARTIQO
enumeration	0230040	documentation

	<p>enumeration 0230041 EuromedImplants documentation EvolutisGroup</p> <p>enumeration 0230042 documentation sonstige</p> <p>enumeration 0230043 documentation TEKNIMED SAS</p> <p>enumeration 0230044 documentation HiPer Medical AG</p> <p>enumeration 0230045 documentation Link Italia S.p.A.</p> <p>enumeration 0230046 documentation Johnson &amp; Johnson Medical GmbH</p> <p>enumeration 0230047 documentation MatOrtho Limited</p> <p>enumeration 0230048 documentation Adler Ortho S.P.A.</p> <p>enumeration 0230049 documentation Lincotek Bologna SRL</p> <p>enumeration 0230050 documentation Materialise</p> <p>enumeration 0230051 documentation Maxx Orthopedics Inc.</p> <p>enumeration 0230052 documentation JRI Orthopaedics</p> <p>enumeration 0230053 documentation nicht belegter Wert</p> <p>enumeration 0230054 documentation nicht belegter Wert</p> <p>enumeration 0230055 documentation nicht belegter Wert</p> <p>enumeration 0230056 documentation nicht belegter Wert</p> <p>enumeration 0230057 documentation nicht belegter Wert</p> <p>enumeration 0230058 documentation nicht belegter Wert</p> <p>enumeration 0230059 documentation nicht belegter Wert</p>
annotation	documentation Kat_EP_Hersteller
source	<pre> &lt;simpleType name="enum_0230"&gt;   &lt;annotation&gt;     &lt;documentation&gt;Kat_EP_Hersteller&lt;/documentation&gt;   &lt;/annotation&gt;   &lt;restriction base="xs:string"&gt;     &lt;enumeration value="0230001"&gt;       &lt;annotation&gt;         &lt;documentation&gt;Smith &amp; Nephew GmbH&lt;/documentation&gt;       &lt;/annotation&gt;     &lt;/enumeration&gt;     &lt;enumeration value="0230002"&gt;       &lt;annotation&gt;         &lt;documentation&gt;Mathys Orthopädie GmbH&lt;/documentation&gt;       &lt;/annotation&gt;     &lt;/enumeration&gt;     &lt;enumeration value="0230003"&gt;       &lt;annotation&gt;         &lt;documentation&gt;Ceramtec AG&lt;/documentation&gt;       &lt;/annotation&gt;     &lt;/enumeration&gt;     &lt;enumeration value="0230004"&gt; </pre>

```
<annotation>
  <documentation>Biomet</documentation>
</annotation>
</enumeration>
<enumeration value="0230005">
  <annotation>
    <documentation>Peter Brehm GmbH</documentation>
  </annotation>
</enumeration>
<enumeration value="0230006">
  <annotation>
    <documentation>Amplitude GmbH</documentation>
  </annotation>
</enumeration>
<enumeration value="0230007">
  <annotation>
    <documentation>Exactech Deutschland</documentation>
  </annotation>
</enumeration>
<enumeration value="0230008">
  <annotation>
    <documentation>Globus Medical</documentation>
  </annotation>
</enumeration>
<enumeration value="0230009">
  <annotation>
    <documentation>Implantcast GmbH</documentation>
  </annotation>
</enumeration>
<enumeration value="0230010">
  <annotation>
    <documentation>DePuy Orthopädie GmbH (J&J)</documentation>
  </annotation>
</enumeration>
<enumeration value="0230011">
  <annotation>
    <documentation>IO-International Orthopaedics</documentation>
  </annotation>
</enumeration>
<enumeration value="0230012">
  <annotation>
    <documentation>Joint Replacement Ltd. Instrumentation</documentation>
  </annotation>
</enumeration>
<enumeration value="0230013">
  <annotation>
    <documentation>Merete</documentation>
  </annotation>
</enumeration>
<enumeration value="0230014">
  <annotation>
    <documentation>S&G Implants GmbH</documentation>
  </annotation>
</enumeration>
<enumeration value="0230015">
  <annotation>
    <documentation>Speetec Implantate GmbH</documentation>
  </annotation>
</enumeration>
```

```
<enumeration value="0230016">
  <annotation>
    <documentation>Stemcup Medical Products GmbH</documentation>
  </annotation>
</enumeration>
<enumeration value="0230017">
  <annotation>
    <documentation>Symbios Deutschland GmbH</documentation>
  </annotation>
</enumeration>
<enumeration value="0230018">
  <annotation>
    <documentation>Tantum AG</documentation>
  </annotation>
</enumeration>
<enumeration value="0230019">
  <annotation>
    <documentation>Tornier GmbH</documentation>
  </annotation>
</enumeration>
<enumeration value="0230020">
  <annotation>
    <documentation>MicroPort Orthopedics GmbH</documentation>
  </annotation>
</enumeration>
<enumeration value="0230021">
  <annotation>
    <documentation>aap Implanate AG</documentation>
  </annotation>
</enumeration>
<enumeration value="0230022">
  <annotation>
    <documentation>AQImplants</documentation>
  </annotation>
</enumeration>
<enumeration value="0230023">
  <annotation>
    <documentation>ESKA Orthodynamics GmbH</documentation>
  </annotation>
</enumeration>
<enumeration value="0230024">
  <annotation>
    <documentation>Ateos medical AG</documentation>
  </annotation>
</enumeration>
<enumeration value="0230025">
  <annotation>
    <documentation>Chiropro GmbH</documentation>
  </annotation>
</enumeration>
<enumeration value="0230026">
  <annotation>
    <documentation>Medacta</documentation>
  </annotation>
</enumeration>
<enumeration value="0230027">
  <annotation>
    <documentation>OHST Medizintechnik AG</documentation>
  </annotation>
</enumeration>
```



```
</enumeration>
<enumeration value="0230028">
  <annotation>
    <documentation>Lima Deutschland GmbH</documentation>
  </annotation>
</enumeration>
<enumeration value="0230029">
  <annotation>
    <documentation>alloPlus GmbH</documentation>
  </annotation>
</enumeration>
<enumeration value="0230030">
  <annotation>
    <documentation>Heraeus Medical GmbH</documentation>
  </annotation>
</enumeration>
<enumeration value="0230031">
  <annotation>
    <documentation>ImplanTec Deutschland GmbH</documentation>
  </annotation>
</enumeration>
<enumeration value="0230032">
  <annotation>
    <documentation>Falcon Medical GmbH</documentation>
  </annotation>
</enumeration>
<enumeration value="0230033">
  <annotation>
    <documentation>Meril GmbH</documentation>
  </annotation>
</enumeration>
<enumeration value="0230034">
  <annotation>
    <documentation>Zimmer Germany GmbH</documentation>
  </annotation>
</enumeration>
<enumeration value="0230035">
  <annotation>
    <documentation>Stryker GmbH & Co. KG</documentation>
  </annotation>
</enumeration>
<enumeration value="0230036">
  <annotation>
    <documentation>Aesculap AG</documentation>
  </annotation>
</enumeration>
<enumeration value="0230037">
  <annotation>
    <documentation>Waldemar Link GmbH & Co. KG</documentation>
  </annotation>
</enumeration>
<enumeration value="0230038">
  <annotation>
    <documentation>Corin Germany GmbH</documentation>
  </annotation>
</enumeration>
<enumeration value="0230039">
  <annotation>
    <documentation>ARTIQO</documentation>
  </annotation>
</enumeration>
```

```
</annotation>
</enumeration>
<enumeration value="0230040">
  <annotation>
    <documentation>EuromedImplants</documentation>
  </annotation>
</enumeration>
<enumeration value="0230041">
  <annotation>
    <documentation>EvolutisGroup</documentation>
  </annotation>
</enumeration>
<enumeration value="0230042">
  <annotation>
    <documentation>sonstige</documentation>
  </annotation>
</enumeration>
<enumeration value="0230043">
  <annotation>
    <documentation>TEKNIMED SAS</documentation>
  </annotation>
</enumeration>
<enumeration value="0230044">
  <annotation>
    <documentation>HiPer Medical AG</documentation>
  </annotation>
</enumeration>
<enumeration value="0230045">
  <annotation>
    <documentation>Link Italia S.p.A.</documentation>
  </annotation>
</enumeration>
<enumeration value="0230046">
  <annotation>
    <documentation>Johnson & Johnson Medical GmbH</documentation>
  </annotation>
</enumeration>
<enumeration value="0230047">
  <annotation>
    <documentation>MatOrtho Limited</documentation>
  </annotation>
</enumeration>
<enumeration value="0230048">
  <annotation>
    <documentation>Adler Ortho S.P.A.</documentation>
  </annotation>
</enumeration>
<enumeration value="0230049">
  <annotation>
    <documentation>Lincotek Bologna SRL</documentation>
  </annotation>
</enumeration>
<enumeration value="0230050">
  <annotation>
    <documentation>Materialise</documentation>
  </annotation>
</enumeration>
<enumeration value="0230051">
  <annotation>
```

```

    <documentation>Maxx Orthopedics Inc.</documentation>
  </annotation>
</enumeration>
<enumeration value="0230052">
  <annotation>
    <documentation>JRI Orthopaedics</documentation>
  </annotation>
</enumeration>
<enumeration value="0230053">
  <annotation>
    <documentation>nicht belegter Wert</documentation>
  </annotation>
</enumeration>
<enumeration value="0230054">
  <annotation>
    <documentation>nicht belegter Wert</documentation>
  </annotation>
</enumeration>
<enumeration value="0230055">
  <annotation>
    <documentation>nicht belegter Wert</documentation>
  </annotation>
</enumeration>
<enumeration value="0230056">
  <annotation>
    <documentation>nicht belegter Wert</documentation>
  </annotation>
</enumeration>
<enumeration value="0230057">
  <annotation>
    <documentation>nicht belegter Wert</documentation>
  </annotation>
</enumeration>
<enumeration value="0230058">
  <annotation>
    <documentation>nicht belegter Wert</documentation>
  </annotation>
</enumeration>
<enumeration value="0230059">
  <annotation>
    <documentation>nicht belegter Wert</documentation>
  </annotation>
</enumeration>
</restriction>
</simpleType>

```

### simpleType enum\_0252

namespace	http://xml.ir-d.de/irdma		
type	restriction of <b>string</b>		
properties	base xs:string		
facets	Kind	Value	Annotation
	enumeration	0252001	documentation Pfanne
	enumeration	0252002	documentation Schaft
	enumeration	0252003	documentation

	beides
annotation	documentation Kat_EP_KomponenteHuefte
source	<pre> &lt;simpleType name="enum_0252"&gt;   &lt;annotation&gt;     &lt;documentation&gt;Kat_EP_KomponenteHuefte&lt;/documentation&gt;   &lt;/annotation&gt;   &lt;restriction base="xs:string"&gt;     &lt;enumeration value="0252001"&gt;       &lt;annotation&gt;         &lt;documentation&gt;Pfanne&lt;/documentation&gt;       &lt;/annotation&gt;     &lt;/enumeration&gt;     &lt;enumeration value="0252002"&gt;       &lt;annotation&gt;         &lt;documentation&gt;Schaft&lt;/documentation&gt;       &lt;/annotation&gt;     &lt;/enumeration&gt;     &lt;enumeration value="0252003"&gt;       &lt;annotation&gt;         &lt;documentation&gt;beides&lt;/documentation&gt;       &lt;/annotation&gt;     &lt;/enumeration&gt;   &lt;/restriction&gt; &lt;/simpleType&gt; </pre>

### simpleType **enum\_0254**

namespace	http://xml.ir-d.de/irdma		
type	restriction of <b>string</b>		
properties	base xs:string		
facets	Kind	Value	Annotation
	enumeration	0254001	documentation Femur
	enumeration	0254002	documentation Tibia
	enumeration	0254003	documentation Patella
	enumeration	0254004	documentation mehrere
annotation	documentation Kat_EP_KomponenteKnie		
source	<pre> &lt;simpleType name="enum_0254"&gt;   &lt;annotation&gt;     &lt;documentation&gt;Kat_EP_KomponenteKnie&lt;/documentation&gt;   &lt;/annotation&gt;   &lt;restriction base="xs:string"&gt;     &lt;enumeration value="0254001"&gt;       &lt;annotation&gt;         &lt;documentation&gt;Femur&lt;/documentation&gt;       &lt;/annotation&gt;     &lt;/enumeration&gt;     &lt;enumeration value="0254002"&gt;       &lt;annotation&gt;         &lt;documentation&gt;Tibia&lt;/documentation&gt;       &lt;/annotation&gt;     &lt;/enumeration&gt;   &lt;/restriction&gt; </pre>		

	<pre> &lt;enumeration value="0254003"&gt;   &lt;annotation&gt;     &lt;documentation&gt;Patella&lt;/documentation&gt;   &lt;/annotation&gt; &lt;/enumeration&gt; &lt;enumeration value="0254004"&gt;   &lt;annotation&gt;     &lt;documentation&gt;mehrere&lt;/documentation&gt;   &lt;/annotation&gt; &lt;/enumeration&gt; &lt;/restriction&gt; &lt;/simpleType&gt; </pre>
--	---

### simpleType enum\_0256

namespace	http://xml.ir-d.de/irdma		
type	restriction of <b>string</b>		
properties	base xs:string		
facets	Kind	Value	Annotation
	enumeration	0256001	documentation Pfanne
	enumeration	0256002	documentation Schaft
	enumeration	0256003	documentation Pfanne und Schaft
	enumeration	0256004	documentation Femur
	enumeration	0256005	documentation Tibia
	enumeration	0256006	documentation Patella
	enumeration	0256007	documentation mehrere
annotation	documentation Kat_EP_KomponenteTFE		
source	<pre> &lt;simpleType name="enum_0256"&gt;   &lt;annotation&gt;     &lt;documentation&gt;Kat_EP_KomponenteTFE&lt;/documentation&gt;   &lt;/annotation&gt;   &lt;restriction base="xs:string"&gt;     &lt;enumeration value="0256001"&gt;       &lt;annotation&gt;         &lt;documentation&gt;Pfanne&lt;/documentation&gt;       &lt;/annotation&gt;     &lt;/enumeration&gt;     &lt;enumeration value="0256002"&gt;       &lt;annotation&gt;         &lt;documentation&gt;Schaft&lt;/documentation&gt;       &lt;/annotation&gt;     &lt;/enumeration&gt;     &lt;enumeration value="0256003"&gt;       &lt;annotation&gt;         &lt;documentation&gt;Pfanne und Schaft&lt;/documentation&gt;       &lt;/annotation&gt;     &lt;/enumeration&gt;     &lt;enumeration value="0256004"&gt;       &lt;annotation&gt; </pre>		

	<pre> &lt;documentation&gt;Femur&lt;/documentation&gt; &lt;/annotation&gt; &lt;/enumeration&gt; &lt;enumeration value="0256005"&gt;   &lt;annotation&gt;     &lt;documentation&gt;Tibia&lt;/documentation&gt;   &lt;/annotation&gt; &lt;/enumeration&gt; &lt;enumeration value="0256006"&gt;   &lt;annotation&gt;     &lt;documentation&gt;Patella&lt;/documentation&gt;   &lt;/annotation&gt; &lt;/enumeration&gt; &lt;enumeration value="0256007"&gt;   &lt;annotation&gt;     &lt;documentation&gt;mehrere&lt;/documentation&gt;   &lt;/annotation&gt; &lt;/enumeration&gt; &lt;/restriction&gt; &lt;/simpleType&gt; </pre>
--	--

### simpleType enum\_0262

namespace	http://xml.ir-d.de/irdma		
type	restriction of <b>string</b>		
properties	base xs:string		
facets	Kind	Value	Annotation
	enumeration	0262001	documentation Pfanne
	enumeration	0262002	documentation Schaft
	enumeration	0262003	documentation Kopf
	enumeration	0262004	documentation Inlay
	enumeration	0262005	documentation Adapter
	enumeration	0262006	documentation mehrere
annotation	documentation Kat_EP_ImplantatbruchHuefte		
source	<pre> &lt;simpleType name="enum_0262"&gt;   &lt;annotation&gt;     &lt;documentation&gt;Kat_EP_ImplantatbruchHuefte&lt;/documentation&gt;   &lt;/annotation&gt;   &lt;restriction base="xs:string"&gt;     &lt;enumeration value="0262001"&gt;       &lt;annotation&gt;         &lt;documentation&gt;Pfanne&lt;/documentation&gt;       &lt;/annotation&gt;     &lt;/enumeration&gt;     &lt;enumeration value="0262002"&gt;       &lt;annotation&gt;         &lt;documentation&gt;Schaft&lt;/documentation&gt;       &lt;/annotation&gt;     &lt;/enumeration&gt;     &lt;enumeration value="0262003"&gt; </pre>		

	<pre> &lt;annotation&gt;   &lt;documentation&gt;Kopf&lt;/documentation&gt; &lt;/annotation&gt; &lt;/enumeration&gt; &lt;enumeration value="0262004"&gt;   &lt;annotation&gt;     &lt;documentation&gt;Inlay&lt;/documentation&gt;   &lt;/annotation&gt; &lt;/enumeration&gt; &lt;enumeration value="0262005"&gt;   &lt;annotation&gt;     &lt;documentation&gt;Adapter&lt;/documentation&gt;   &lt;/annotation&gt; &lt;/enumeration&gt; &lt;enumeration value="0262006"&gt;   &lt;annotation&gt;     &lt;documentation&gt;mehrere&lt;/documentation&gt;   &lt;/annotation&gt; &lt;/enumeration&gt; &lt;/restriction&gt; &lt;/simpleType&gt; </pre>
--	--

#### simpleType enum 0264

namespace	http://xml.ir-d.de/irdma		
type	restriction of <b>string</b>		
properties	base xs:string		
facets	Kind	Value	Annotation
	enumeration	0264001	documentation Femur
	enumeration	0264002	documentation Tibia
	enumeration	0264003	documentation Inlay
	enumeration	0264004	documentation Adapter
	enumeration	0264005	documentation Verlängerung
	enumeration	0264006	documentation Schrauben
	enumeration	0264007	documentation mehrere
	enumeration	0264042	documentation andere
annotation	documentation Kat_EP_ImplantatbruchKnie		
source	<pre> &lt;simpleType name="enum_0264"&gt;   &lt;annotation&gt;     &lt;documentation&gt;Kat_EP_ImplantatbruchKnie&lt;/documentation&gt;   &lt;/annotation&gt;   &lt;restriction base="xs:string"&gt;     &lt;enumeration value="0264001"&gt;       &lt;annotation&gt;         &lt;documentation&gt;Femur&lt;/documentation&gt;       &lt;/annotation&gt;     &lt;/enumeration&gt;     &lt;enumeration value="0264002"&gt;       &lt;annotation&gt; </pre>		

```

    <documentation>Tibia</documentation>
  </annotation>
</enumeration>
<enumeration value="0264003">
  <annotation>
    <documentation>Inlay</documentation>
  </annotation>
</enumeration>
<enumeration value="0264004">
  <annotation>
    <documentation>Adapter</documentation>
  </annotation>
</enumeration>
<enumeration value="0264005">
  <annotation>
    <documentation>Verlängerung</documentation>
  </annotation>
</enumeration>
<enumeration value="0264006">
  <annotation>
    <documentation>Schrauben</documentation>
  </annotation>
</enumeration>
<enumeration value="0264007">
  <annotation>
    <documentation>mehrere</documentation>
  </annotation>
</enumeration>
<enumeration value="0264042">
  <annotation>
    <documentation>andere</documentation>
  </annotation>
</enumeration>
</restriction>
</simpleType>

```

### simpleType enum 0266

namespace	http://xml.ir-d.de/irdma		
type	restriction of <b>string</b>		
properties	base xs:string		
facets	Kind	Value	Annotation
	enumeration	0266001	documentation Pfanne
	enumeration	0266002	documentation Schaft
	enumeration	0266003	documentation Kopf
	enumeration	0266004	documentation Inlay
	enumeration	0266005	documentation Adapter
	enumeration	0266006	documentation Femur
	enumeration	0266007	documentation Tibia
	enumeration	0266008	documentation Verlängerung



	enumeration 0266009 documentation Schrauben enumeration 0266010 documentation mehrere enumeration 0266042 documentation andere
annotation	documentation Kat_EP_ImplantatbruchTFE
source	<pre> &lt;simpleType name="enum_0266"&gt;   &lt;annotation&gt;     &lt;documentation&gt;Kat_EP_ImplantatbruchTFE&lt;/documentation&gt;   &lt;/annotation&gt;   &lt;restriction base="xs:string"&gt;     &lt;enumeration value="0266001"&gt;       &lt;annotation&gt;         &lt;documentation&gt;Pfanne&lt;/documentation&gt;       &lt;/annotation&gt;     &lt;/enumeration&gt;     &lt;enumeration value="0266002"&gt;       &lt;annotation&gt;         &lt;documentation&gt;Schaft&lt;/documentation&gt;       &lt;/annotation&gt;     &lt;/enumeration&gt;     &lt;enumeration value="0266003"&gt;       &lt;annotation&gt;         &lt;documentation&gt;Kopf&lt;/documentation&gt;       &lt;/annotation&gt;     &lt;/enumeration&gt;     &lt;enumeration value="0266004"&gt;       &lt;annotation&gt;         &lt;documentation&gt;Inlay&lt;/documentation&gt;       &lt;/annotation&gt;     &lt;/enumeration&gt;     &lt;enumeration value="0266005"&gt;       &lt;annotation&gt;         &lt;documentation&gt;Adapter&lt;/documentation&gt;       &lt;/annotation&gt;     &lt;/enumeration&gt;     &lt;enumeration value="0266006"&gt;       &lt;annotation&gt;         &lt;documentation&gt;Femur&lt;/documentation&gt;       &lt;/annotation&gt;     &lt;/enumeration&gt;     &lt;enumeration value="0266007"&gt;       &lt;annotation&gt;         &lt;documentation&gt;Tibia&lt;/documentation&gt;       &lt;/annotation&gt;     &lt;/enumeration&gt;     &lt;enumeration value="0266008"&gt;       &lt;annotation&gt;         &lt;documentation&gt;Verlängerung&lt;/documentation&gt;       &lt;/annotation&gt;     &lt;/enumeration&gt;     &lt;enumeration value="0266009"&gt;       &lt;annotation&gt;         &lt;documentation&gt;Schrauben&lt;/documentation&gt;       &lt;/annotation&gt;     &lt;/enumeration&gt;     &lt;enumeration value="0266010"&gt; </pre>

	<pre> &lt;annotation&gt;   &lt;documentation&gt;mehrere&lt;/documentation&gt; &lt;/annotation&gt; &lt;/enumeration&gt; &lt;enumeration value="0266042"&gt;   &lt;annotation&gt;     &lt;documentation&gt;andere&lt;/documentation&gt;   &lt;/annotation&gt; &lt;/enumeration&gt; &lt;/restriction&gt; &lt;/simpleType&gt; </pre>
--	--

### simpleType enum\_0270

namespace	http://xml.ir-d.de/irdma		
type	restriction of <b>string</b>		
properties	base xs:string		
facets	Kind	Value	Annotation
	enumeration	0270001	documentation PE-Inlay
	enumeration	0270002	documentation patellare Komponente
	enumeration	0270003	documentation beides
annotation	documentation Kat_EP_VerschleissKnie		
source	<pre> &lt;simpleType name="enum_0270"&gt;   &lt;annotation&gt;     &lt;documentation&gt;Kat_EP_VerschleissKnie&lt;/documentation&gt;   &lt;/annotation&gt;   &lt;restriction base="xs:string"&gt;     &lt;enumeration value="0270001"&gt;       &lt;annotation&gt;         &lt;documentation&gt;PE-Inlay&lt;/documentation&gt;       &lt;/annotation&gt;     &lt;/enumeration&gt;     &lt;enumeration value="0270002"&gt;       &lt;annotation&gt;         &lt;documentation&gt;patellare Komponente&lt;/documentation&gt;       &lt;/annotation&gt;     &lt;/enumeration&gt;     &lt;enumeration value="0270003"&gt;       &lt;annotation&gt;         &lt;documentation&gt;beides&lt;/documentation&gt;       &lt;/annotation&gt;     &lt;/enumeration&gt;   &lt;/restriction&gt; &lt;/simpleType&gt; </pre>		

### simpleType enum\_0271

namespace	http://xml.ir-d.de/irdma		
type	restriction of <b>string</b>		
properties	base xs:string		

facets	<table border="1"> <thead> <tr> <th>Kind</th> <th>Value</th> <th>Annotation</th> </tr> </thead> <tbody> <tr> <td>enumeration</td> <td>0271001</td> <td>documentation Schraube</td> </tr> <tr> <td>enumeration</td> <td>0271002</td> <td>documentation Inlay</td> </tr> <tr> <td>enumeration</td> <td>0271003</td> <td>documentation patellare Komponente</td> </tr> <tr> <td>enumeration</td> <td>0271004</td> <td>documentation Kopplung</td> </tr> <tr> <td>enumeration</td> <td>0271005</td> <td>documentation mehrere</td> </tr> <tr> <td>enumeration</td> <td>0271042</td> <td>documentation andere</td> </tr> </tbody> </table>	Kind	Value	Annotation	enumeration	0271001	documentation Schraube	enumeration	0271002	documentation Inlay	enumeration	0271003	documentation patellare Komponente	enumeration	0271004	documentation Kopplung	enumeration	0271005	documentation mehrere	enumeration	0271042	documentation andere
Kind	Value	Annotation																				
enumeration	0271001	documentation Schraube																				
enumeration	0271002	documentation Inlay																				
enumeration	0271003	documentation patellare Komponente																				
enumeration	0271004	documentation Kopplung																				
enumeration	0271005	documentation mehrere																				
enumeration	0271042	documentation andere																				
annotation	documentation Kat_EP_MigrationKnie																					
source	<pre> &lt;simpleType name="enum_0271"&gt;   &lt;annotation&gt;     &lt;documentation&gt;Kat_EP_MigrationKnie&lt;/documentation&gt;   &lt;/annotation&gt;   &lt;restriction base="xs:string"&gt;     &lt;enumeration value="0271001"&gt;       &lt;annotation&gt;         &lt;documentation&gt;Schraube&lt;/documentation&gt;       &lt;/annotation&gt;     &lt;/enumeration&gt;     &lt;enumeration value="0271002"&gt;       &lt;annotation&gt;         &lt;documentation&gt;Inlay&lt;/documentation&gt;       &lt;/annotation&gt;     &lt;/enumeration&gt;     &lt;enumeration value="0271003"&gt;       &lt;annotation&gt;         &lt;documentation&gt;patellare Komponente&lt;/documentation&gt;       &lt;/annotation&gt;     &lt;/enumeration&gt;     &lt;enumeration value="0271004"&gt;       &lt;annotation&gt;         &lt;documentation&gt;Kopplung&lt;/documentation&gt;       &lt;/annotation&gt;     &lt;/enumeration&gt;     &lt;enumeration value="0271005"&gt;       &lt;annotation&gt;         &lt;documentation&gt;mehrere&lt;/documentation&gt;       &lt;/annotation&gt;     &lt;/enumeration&gt;     &lt;enumeration value="0271042"&gt;       &lt;annotation&gt;         &lt;documentation&gt;andere&lt;/documentation&gt;       &lt;/annotation&gt;     &lt;/enumeration&gt;   &lt;/restriction&gt; &lt;/simpleType&gt; </pre>																					

### simpleType enum\_0290

namespace	http://xml.ir-d.de/irdma
type	restriction of <b>string</b>

properties	base xs:string												
facets	<table border="1"> <thead> <tr> <th>Kind</th> <th>Value</th> <th>Annotation</th> </tr> </thead> <tbody> <tr> <td>enumeration</td> <td>0290001</td> <td>documentation Hüft-Komponente</td> </tr> <tr> <td>enumeration</td> <td>0290002</td> <td>documentation Knie-Komponente</td> </tr> <tr> <td>enumeration</td> <td>0290003</td> <td>documentation Modulare Komponente (Hüfte/Knie)</td> </tr> </tbody> </table>	Kind	Value	Annotation	enumeration	0290001	documentation Hüft-Komponente	enumeration	0290002	documentation Knie-Komponente	enumeration	0290003	documentation Modulare Komponente (Hüfte/Knie)
Kind	Value	Annotation											
enumeration	0290001	documentation Hüft-Komponente											
enumeration	0290002	documentation Knie-Komponente											
enumeration	0290003	documentation Modulare Komponente (Hüfte/Knie)											
annotation	documentation Kat_EP_Artikeltyp												
source	<pre> &lt;simpleType name="enum_0290"&gt;   &lt;annotation&gt;     &lt;documentation&gt;Kat_EP_Artikeltyp&lt;/documentation&gt;   &lt;/annotation&gt;   &lt;restriction base="xs:string"&gt;     &lt;enumeration value="0290001"&gt;       &lt;annotation&gt;         &lt;documentation&gt;Hüft-Komponente&lt;/documentation&gt;       &lt;/annotation&gt;     &lt;/enumeration&gt;     &lt;enumeration value="0290002"&gt;       &lt;annotation&gt;         &lt;documentation&gt;Knie-Komponente&lt;/documentation&gt;       &lt;/annotation&gt;     &lt;/enumeration&gt;     &lt;enumeration value="0290003"&gt;       &lt;annotation&gt;         &lt;documentation&gt;Modulare Komponente (Hüfte/Knie)&lt;/documentation&gt;       &lt;/annotation&gt;     &lt;/enumeration&gt;   &lt;/restriction&gt; &lt;/simpleType&gt; </pre>												

### simpleType **enum\_0291**

namespace	http://xml.ir-d.de/irdma									
type	restriction of <b>string</b>									
properties	base xs:string									
facets	<table border="1"> <thead> <tr> <th>Kind</th> <th>Value</th> <th>Annotation</th> </tr> </thead> <tbody> <tr> <td>enumeration</td> <td>0291001</td> <td>documentation Knochen-Zement</td> </tr> <tr> <td>enumeration</td> <td>0291002</td> <td>documentation sonstiges Zubehör</td> </tr> </tbody> </table>	Kind	Value	Annotation	enumeration	0291001	documentation Knochen-Zement	enumeration	0291002	documentation sonstiges Zubehör
Kind	Value	Annotation								
enumeration	0291001	documentation Knochen-Zement								
enumeration	0291002	documentation sonstiges Zubehör								
annotation	documentation Kat_EP_ZubehoerTyp									
source	<pre> &lt;simpleType name="enum_0291"&gt;   &lt;annotation&gt;     &lt;documentation&gt;Kat_EP_ZubehoerTyp&lt;/documentation&gt;   &lt;/annotation&gt;   &lt;restriction base="xs:string"&gt;     &lt;enumeration value="0291001"&gt;       &lt;annotation&gt;         &lt;documentation&gt;Knochen-Zement&lt;/documentation&gt;       &lt;/annotation&gt;     &lt;/enumeration&gt;     &lt;enumeration value="0291002"&gt; </pre>									

	<pre> &lt;annotation&gt;   &lt;documentation&gt;sonstiges Zubehör&lt;/documentation&gt; &lt;/annotation&gt; &lt;/enumeration&gt; &lt;/restriction&gt; &lt;/simpleType&gt; </pre>
--	--

### simpleType enum\_0300

namespace	http://xml.ir-d.de/irdma		
type	restriction of <b>string</b>		
properties	base xs:string		
facets	Kind	Value	Annotation
	enumeration	0300001	documentation konventioneller Aortenklappenersatz
	enumeration	0300002	documentation kathetergestützte Aortenklappenimplantation (TAVI)
annotation	documentation Kat_AK_ArtEingriff		
source	<pre> &lt;simpleType name="enum_0300"&gt;   &lt;annotation&gt;     &lt;documentation&gt;Kat_AK_ArtEingriff&lt;/documentation&gt;   &lt;/annotation&gt;   &lt;restriction base="xs:string"&gt;     &lt;enumeration value="0300001"&gt;       &lt;annotation&gt;         &lt;documentation&gt;konventioneller Aortenklappenersatz&lt;/documentation&gt;       &lt;/annotation&gt;     &lt;/enumeration&gt;     &lt;enumeration value="0300002"&gt;       &lt;annotation&gt;         &lt;documentation&gt;kathetergestützte Aortenklappenimplantation (TAVI)&lt;/documentation&gt;       &lt;/annotation&gt;     &lt;/enumeration&gt;   &lt;/restriction&gt; &lt;/simpleType&gt; </pre>		

### simpleType enum\_0302

namespace	http://xml.ir-d.de/irdma		
type	restriction of <b>string</b>		
properties	base xs:string		
facets	Kind	Value	Annotation
	enumeration	0302001	documentation Stenose
	enumeration	0302002	documentation Insuffizienz
	enumeration	0302003	documentation Stenose und Insuffizienz
annotation	documentation Kat_AK_GrundEingriff		
source	<pre> &lt;simpleType name="enum_0302"&gt;   &lt;annotation&gt; </pre>		

	<pre> &lt;documentation&gt;Kat_AK_GrundEingriff&lt;/documentation&gt; &lt;/annotation&gt; &lt;restriction base="xs:string"&gt;   &lt;enumeration value="0302001"&gt;     &lt;annotation&gt;       &lt;documentation&gt;Stenose&lt;/documentation&gt;     &lt;/annotation&gt;   &lt;/enumeration&gt;   &lt;enumeration value="0302002"&gt;     &lt;annotation&gt;       &lt;documentation&gt;Insuffizienz&lt;/documentation&gt;     &lt;/annotation&gt;   &lt;/enumeration&gt;   &lt;enumeration value="0302003"&gt;     &lt;annotation&gt;       &lt;documentation&gt;Stenose und Insuffizienz&lt;/documentation&gt;     &lt;/annotation&gt;   &lt;/enumeration&gt; &lt;/restriction&gt; &lt;/simpleType&gt; </pre>
--	---

### simpleType enum\_0318

namespace	http://xml.ir-d.de/irdma		
type	restriction of <b>string</b>		
properties	base xs:string		
facets	Kind	Value	Annotation
	enumeration	0318001	documentation transapikal
	enumeration	0318002	documentation transaortal
	enumeration	0318003	documentation transfemoral
	enumeration	0318004	documentation transaxillär
	enumeration	0318042	documentation anderer Zugangsweg
annotation	documentation Kat_AK_ZugangKatheter		
source	<pre> &lt;simpleType name="enum_0318"&gt;   &lt;annotation&gt;     &lt;documentation&gt;Kat_AK_ZugangKatheter&lt;/documentation&gt;   &lt;/annotation&gt;   &lt;restriction base="xs:string"&gt;     &lt;enumeration value="0318001"&gt;       &lt;annotation&gt;         &lt;documentation&gt;transapikal&lt;/documentation&gt;       &lt;/annotation&gt;     &lt;/enumeration&gt;     &lt;enumeration value="0318002"&gt;       &lt;annotation&gt;         &lt;documentation&gt;transaortal&lt;/documentation&gt;       &lt;/annotation&gt;     &lt;/enumeration&gt;     &lt;enumeration value="0318003"&gt;       &lt;annotation&gt;         &lt;documentation&gt;transfemoral&lt;/documentation&gt; </pre>		

	<pre> &lt;/annotation&gt; &lt;/enumeration&gt; &lt;enumeration value="0318004"&gt;   &lt;annotation&gt;     &lt;documentation&gt;transaxillär&lt;/documentation&gt;   &lt;/annotation&gt; &lt;/enumeration&gt; &lt;enumeration value="0318042"&gt;   &lt;annotation&gt;     &lt;documentation&gt;anderer Zugangsweg&lt;/documentation&gt;   &lt;/annotation&gt; &lt;/enumeration&gt; &lt;/restriction&gt; &lt;/simpleType&gt; </pre>
--	--

### simpleType enum\_0320

namespace	http://xml.lir-d.de/irdma		
type	restriction of <b>string</b>		
properties	base xs:string		
facets	Kind	Value	Annotation
	enumeration	0320001	documentation konventionelle Sternotomie
	enumeration	0320002	documentation partielle Sternotomie
	enumeration	0320003	documentation parasternaler Zugang
	enumeration	0320042	documentation anderer Zugangsweg
annotation	documentation Kat_AK_ZugangKonventionell		
source	<pre> &lt;simpleType name="enum_0320"&gt;   &lt;annotation&gt;     &lt;documentation&gt;Kat_AK_ZugangKonventionell&lt;/documentation&gt;   &lt;/annotation&gt;   &lt;restriction base="xs:string"&gt;     &lt;enumeration value="0320001"&gt;       &lt;annotation&gt;         &lt;documentation&gt;konventionelle Sternotomie&lt;/documentation&gt;       &lt;/annotation&gt;     &lt;/enumeration&gt;     &lt;enumeration value="0320002"&gt;       &lt;annotation&gt;         &lt;documentation&gt;partielle Sternotomie&lt;/documentation&gt;       &lt;/annotation&gt;     &lt;/enumeration&gt;     &lt;enumeration value="0320003"&gt;       &lt;annotation&gt;         &lt;documentation&gt;parasternaler Zugang&lt;/documentation&gt;       &lt;/annotation&gt;     &lt;/enumeration&gt;     &lt;enumeration value="0320042"&gt;       &lt;annotation&gt;         &lt;documentation&gt;anderer Zugangsweg&lt;/documentation&gt;       &lt;/annotation&gt;     &lt;/enumeration&gt;   &lt;/restriction&gt; </pre>		

	<code>&lt;/simpleType&gt;</code>
--	----------------------------------

### simpleType enum\_0322

namespace	http://xml.ir-d.de/irdma																					
type	restriction of <b>string</b>																					
properties	base xs:string																					
facets	<table><thead><tr><th>Kind</th><th>Value</th><th>Annotation</th></tr></thead><tbody><tr><td>enumeration</td><td>0322001</td><td>documentation nein</td></tr><tr><td>enumeration</td><td>0322002</td><td>documentation ja, diätetisch behandelt</td></tr><tr><td>enumeration</td><td>0322003</td><td>documentation ja, orale Medikation</td></tr><tr><td>enumeration</td><td>0322004</td><td>documentation ja, mit Insulin behandelt</td></tr><tr><td>enumeration</td><td>0322005</td><td>documentation ja, unbehandelt</td></tr><tr><td>enumeration</td><td>0322099</td><td>documentation unbekannt</td></tr></tbody></table>	Kind	Value	Annotation	enumeration	0322001	documentation nein	enumeration	0322002	documentation ja, diätetisch behandelt	enumeration	0322003	documentation ja, orale Medikation	enumeration	0322004	documentation ja, mit Insulin behandelt	enumeration	0322005	documentation ja, unbehandelt	enumeration	0322099	documentation unbekannt
Kind	Value	Annotation																				
enumeration	0322001	documentation nein																				
enumeration	0322002	documentation ja, diätetisch behandelt																				
enumeration	0322003	documentation ja, orale Medikation																				
enumeration	0322004	documentation ja, mit Insulin behandelt																				
enumeration	0322005	documentation ja, unbehandelt																				
enumeration	0322099	documentation unbekannt																				
annotation	documentation Kat AK Diabetes																					
source	<pre>&lt;simpleType name="enum_0322"&gt;   &lt;annotation&gt;     &lt;documentation&gt;Kat_AK_Diabetes&lt;/documentation&gt;   &lt;/annotation&gt;   &lt;restriction base="xs:string"&gt;     &lt;enumeration value="0322001"&gt;       &lt;annotation&gt;         &lt;documentation&gt;nein&lt;/documentation&gt;       &lt;/annotation&gt;     &lt;/enumeration&gt;     &lt;enumeration value="0322002"&gt;       &lt;annotation&gt;         &lt;documentation&gt;ja, diätetisch behandelt&lt;/documentation&gt;       &lt;/annotation&gt;     &lt;/enumeration&gt;     &lt;enumeration value="0322003"&gt;       &lt;annotation&gt;         &lt;documentation&gt;ja, orale Medikation&lt;/documentation&gt;       &lt;/annotation&gt;     &lt;/enumeration&gt;     &lt;enumeration value="0322004"&gt;       &lt;annotation&gt;         &lt;documentation&gt;ja, mit Insulin behandelt&lt;/documentation&gt;       &lt;/annotation&gt;     &lt;/enumeration&gt;     &lt;enumeration value="0322005"&gt;       &lt;annotation&gt;         &lt;documentation&gt;ja, unbehandelt&lt;/documentation&gt;       &lt;/annotation&gt;     &lt;/enumeration&gt;     &lt;enumeration value="0322099"&gt;       &lt;annotation&gt;         &lt;documentation&gt;unbekannt&lt;/documentation&gt;       &lt;/annotation&gt;     &lt;/enumeration&gt;   &lt;/restriction&gt; &lt;/simpleType&gt;</pre>																					



	<pre> &lt;/restriction&gt; &lt;/simpleType&gt; </pre>
--	---

### simpleType enum\_0324

namespace	http://xml.ir-d.de/irdma		
type	restriction of <b>string</b>		
properties	base xs:string		
facets	Kind	Value	Annotation
	enumeration	0324001	documentation (I): Beschwerdefreiheit, normale körperliche Belastbarkeit
	enumeration	0324002	documentation (II): Beschwerden bei stärkerer körperlicher Belastung
	enumeration	0324003	documentation (III): Beschwerden bei leichter körperlicher Belastung
	enumeration	0324004	documentation (IV): Beschwerden in Ruhe
annotation	documentation Kat_AK_NYHA		
source	<pre> &lt;simpleType name="enum_0324"&gt;   &lt;annotation&gt;     &lt;documentation&gt;Kat_AK_NYHA&lt;/documentation&gt;   &lt;/annotation&gt;   &lt;restriction base="xs:string"&gt;     &lt;enumeration value="0324001"&gt;       &lt;annotation&gt;         &lt;documentation&gt;(I): Beschwerdefreiheit, normale körperliche Belastbarkeit&lt;/documentation&gt;       &lt;/annotation&gt;     &lt;/enumeration&gt;     &lt;enumeration value="0324002"&gt;       &lt;annotation&gt;         &lt;documentation&gt;(II): Beschwerden bei stärkerer körperlicher Belastung&lt;/documentation&gt;       &lt;/annotation&gt;     &lt;/enumeration&gt;     &lt;enumeration value="0324003"&gt;       &lt;annotation&gt;         &lt;documentation&gt;(III): Beschwerden bei leichter körperlicher Belastung&lt;/documentation&gt;       &lt;/annotation&gt;     &lt;/enumeration&gt;     &lt;enumeration value="0324004"&gt;       &lt;annotation&gt;         &lt;documentation&gt;(IV): Beschwerden in Ruhe&lt;/documentation&gt;       &lt;/annotation&gt;     &lt;/enumeration&gt;   &lt;/restriction&gt; &lt;/simpleType&gt; </pre>		

### simpleType enum\_0330

namespace	http://xml.ir-d.de/irdma
type	restriction of <b>string</b>

properties	base xs:string																																																												
facets	<table border="1"> <thead> <tr> <th>Kind</th> <th>Value</th> <th>Annotation</th> </tr> </thead> <tbody> <tr> <td>enumeration</td> <td>0330001</td> <td>documentation ATS Medical</td> </tr> <tr> <td>enumeration</td> <td>0330002</td> <td>documentation Edwards Lifesciences</td> </tr> <tr> <td>enumeration</td> <td>0330003</td> <td>documentation Medtronic</td> </tr> <tr> <td>enumeration</td> <td>0330004</td> <td>documentation JenaValve</td> </tr> <tr> <td>enumeration</td> <td>0330005</td> <td>documentation Corcym</td> </tr> <tr> <td>enumeration</td> <td>0330006</td> <td>documentation Abbott Medical / St. Jude</td> </tr> <tr> <td>enumeration</td> <td>0330007</td> <td>documentation Symetis</td> </tr> <tr> <td>enumeration</td> <td>0330008</td> <td>documentation Direct Flow Medical</td> </tr> <tr> <td>enumeration</td> <td>0330009</td> <td>documentation Boston Scientific</td> </tr> <tr> <td>enumeration</td> <td>0330010</td> <td>documentation Artivion</td> </tr> <tr> <td>enumeration</td> <td>0330011</td> <td>documentation Biosensors</td> </tr> <tr> <td>enumeration</td> <td>0330012</td> <td>documentation LivaNova</td> </tr> <tr> <td>enumeration</td> <td>0330013</td> <td>documentation Meril</td> </tr> <tr> <td>enumeration</td> <td>0330014</td> <td>documentation Sahajanand Medical Technologies</td> </tr> <tr> <td>enumeration</td> <td>0330015</td> <td>documentation nicht belegter Wert</td> </tr> <tr> <td>enumeration</td> <td>0330016</td> <td>documentation nicht belegter Wert</td> </tr> <tr> <td>enumeration</td> <td>0330017</td> <td>documentation nicht belegter Wert</td> </tr> <tr> <td>enumeration</td> <td>0330018</td> <td>documentation nicht belegter Wert</td> </tr> <tr> <td>enumeration</td> <td>0330042</td> <td>documentation sonstiger Hersteller</td> </tr> </tbody> </table>	Kind	Value	Annotation	enumeration	0330001	documentation ATS Medical	enumeration	0330002	documentation Edwards Lifesciences	enumeration	0330003	documentation Medtronic	enumeration	0330004	documentation JenaValve	enumeration	0330005	documentation Corcym	enumeration	0330006	documentation Abbott Medical / St. Jude	enumeration	0330007	documentation Symetis	enumeration	0330008	documentation Direct Flow Medical	enumeration	0330009	documentation Boston Scientific	enumeration	0330010	documentation Artivion	enumeration	0330011	documentation Biosensors	enumeration	0330012	documentation LivaNova	enumeration	0330013	documentation Meril	enumeration	0330014	documentation Sahajanand Medical Technologies	enumeration	0330015	documentation nicht belegter Wert	enumeration	0330016	documentation nicht belegter Wert	enumeration	0330017	documentation nicht belegter Wert	enumeration	0330018	documentation nicht belegter Wert	enumeration	0330042	documentation sonstiger Hersteller
Kind	Value	Annotation																																																											
enumeration	0330001	documentation ATS Medical																																																											
enumeration	0330002	documentation Edwards Lifesciences																																																											
enumeration	0330003	documentation Medtronic																																																											
enumeration	0330004	documentation JenaValve																																																											
enumeration	0330005	documentation Corcym																																																											
enumeration	0330006	documentation Abbott Medical / St. Jude																																																											
enumeration	0330007	documentation Symetis																																																											
enumeration	0330008	documentation Direct Flow Medical																																																											
enumeration	0330009	documentation Boston Scientific																																																											
enumeration	0330010	documentation Artivion																																																											
enumeration	0330011	documentation Biosensors																																																											
enumeration	0330012	documentation LivaNova																																																											
enumeration	0330013	documentation Meril																																																											
enumeration	0330014	documentation Sahajanand Medical Technologies																																																											
enumeration	0330015	documentation nicht belegter Wert																																																											
enumeration	0330016	documentation nicht belegter Wert																																																											
enumeration	0330017	documentation nicht belegter Wert																																																											
enumeration	0330018	documentation nicht belegter Wert																																																											
enumeration	0330042	documentation sonstiger Hersteller																																																											
annotation	documentation Kat AK Hersteller																																																												
source	<pre> &lt;simpleType name="enum_0330"&gt;   &lt;annotation&gt;     &lt;documentation&gt;Kat_AK_Hersteller&lt;/documentation&gt;   &lt;/annotation&gt;   &lt;restriction base="xs:string"&gt;     &lt;enumeration value="0330001"&gt;       &lt;annotation&gt;         &lt;documentation&gt;ATS Medical&lt;/documentation&gt;       &lt;/annotation&gt;     &lt;/enumeration&gt;     &lt;enumeration value="0330002"&gt;       &lt;annotation&gt;         &lt;documentation&gt;Edwards Lifesciences&lt;/documentation&gt;       &lt;/annotation&gt;     &lt;/enumeration&gt;     &lt;enumeration value="0330003"&gt;       &lt;annotation&gt;         &lt;documentation&gt;Medtronic&lt;/documentation&gt;       &lt;/annotation&gt;     &lt;/enumeration&gt;   &lt;/restriction&gt; &lt;/simpleType&gt; </pre>																																																												

```
<enumeration value="0330004">
  <annotation>
    <documentation>JenaValve</documentation>
  </annotation>
</enumeration>
<enumeration value="0330005">
  <annotation>
    <documentation>Corcym</documentation>
  </annotation>
</enumeration>
<enumeration value="0330006">
  <annotation>
    <documentation>Abbott Medical / St. Jude</documentation>
  </annotation>
</enumeration>
<enumeration value="0330007">
  <annotation>
    <documentation>Symetis</documentation>
  </annotation>
</enumeration>
<enumeration value="0330008">
  <annotation>
    <documentation>Direct Flow Medical</documentation>
  </annotation>
</enumeration>
<enumeration value="0330009">
  <annotation>
    <documentation>Boston Scientific</documentation>
  </annotation>
</enumeration>
<enumeration value="0330010">
  <annotation>
    <documentation>Artivion</documentation>
  </annotation>
</enumeration>
<enumeration value="0330011">
  <annotation>
    <documentation>Biosensors</documentation>
  </annotation>
</enumeration>
<enumeration value="0330012">
  <annotation>
    <documentation>LivaNova</documentation>
  </annotation>
</enumeration>
<enumeration value="0330013">
  <annotation>
    <documentation>Meril</documentation>
  </annotation>
</enumeration>
<enumeration value="0330014">
  <annotation>
    <documentation>Sahajanand Medical Technologies</documentation>
  </annotation>
</enumeration>
<enumeration value="0330015">
  <annotation>
    <documentation>nicht belegter Wert</documentation>
  </annotation>
</enumeration>
```

	<pre> &lt;/enumeration&gt; &lt;enumeration value="0330016"&gt;   &lt;annotation&gt;     &lt;documentation&gt;nicht belegter Wert&lt;/documentation&gt;   &lt;/annotation&gt; &lt;/enumeration&gt; &lt;enumeration value="0330017"&gt;   &lt;annotation&gt;     &lt;documentation&gt;nicht belegter Wert&lt;/documentation&gt;   &lt;/annotation&gt; &lt;/enumeration&gt; &lt;enumeration value="0330018"&gt;   &lt;annotation&gt;     &lt;documentation&gt;nicht belegter Wert&lt;/documentation&gt;   &lt;/annotation&gt; &lt;/enumeration&gt; &lt;enumeration value="0330042"&gt;   &lt;annotation&gt;     &lt;documentation&gt;sonstiger Hersteller&lt;/documentation&gt;   &lt;/annotation&gt; &lt;/enumeration&gt; &lt;/restriction&gt; &lt;/simpleType&gt; </pre>
--	---

### simpleType enum\_0338

namespace	http://xml.ir-d.de/irdma		
type	restriction of <b>string</b>		
properties	base xs:string		
facets	Kind	Value	Annotation
	enumeration	0338001	documentation LAD
	enumeration	0338002	documentation RCA
	enumeration	0338003	documentation RCX
	enumeration	0338004	documentation Hauptstamm
annotation	documentation Kat_AK_PCIArterien		
source	<pre> &lt;simpleType name="enum_0338"&gt;   &lt;annotation&gt;     &lt;documentation&gt;Kat_AK_PCIArterien&lt;/documentation&gt;   &lt;/annotation&gt;   &lt;restriction base="xs:string"&gt;     &lt;enumeration value="0338001"&gt;       &lt;annotation&gt;         &lt;documentation&gt;LAD&lt;/documentation&gt;       &lt;/annotation&gt;     &lt;/enumeration&gt;     &lt;enumeration value="0338002"&gt;       &lt;annotation&gt;         &lt;documentation&gt;RCA&lt;/documentation&gt;       &lt;/annotation&gt;     &lt;/enumeration&gt;     &lt;enumeration value="0338003"&gt;       &lt;annotation&gt; </pre>		

	<pre> &lt;documentation&gt;RCX&lt;/documentation&gt; &lt;/annotation&gt; &lt;/enumeration&gt; &lt;enumeration value="0338004"&gt;   &lt;annotation&gt;     &lt;documentation&gt;Hauptstamm&lt;/documentation&gt;   &lt;/annotation&gt; &lt;/enumeration&gt; &lt;/restriction&gt; &lt;/simpleType&gt; </pre>
--	---

### simpleType enum\_0339

namespace	http://xml.ir-d.de/irdma		
type	restriction of <b>string</b>		
properties	base xs:string		
facets	Kind	Value	Annotation
	enumeration	0339001	documentation TEE
	enumeration	0339002	documentation CT
	enumeration	0339042	documentation andere
annotation	documentation Kat_AK_AnnulusMessmethode		
source	<pre> &lt;simpleType name="enum_0339"&gt;   &lt;annotation&gt;     &lt;documentation&gt;Kat_AK_AnnulusMessmethode&lt;/documentation&gt;   &lt;/annotation&gt;   &lt;restriction base="xs:string"&gt;     &lt;enumeration value="0339001"&gt;       &lt;annotation&gt;         &lt;documentation&gt;TEE&lt;/documentation&gt;       &lt;/annotation&gt;     &lt;/enumeration&gt;     &lt;enumeration value="0339002"&gt;       &lt;annotation&gt;         &lt;documentation&gt;CT&lt;/documentation&gt;       &lt;/annotation&gt;     &lt;/enumeration&gt;     &lt;enumeration value="0339042"&gt;       &lt;annotation&gt;         &lt;documentation&gt;andere&lt;/documentation&gt;       &lt;/annotation&gt;     &lt;/enumeration&gt;   &lt;/restriction&gt; &lt;/simpleType&gt; </pre>		

### simpleType enum\_0341

namespace	http://xml.ir-d.de/irdma		
type	restriction of <b>string</b>		
properties	base xs:string		

facets	<table border="1"> <thead> <tr> <th>Kind</th> <th>Value</th> <th>Annotation</th> </tr> </thead> <tbody> <tr> <td>enumeration</td> <td>0341001</td> <td>documentation intraprozedural verstorben</td> </tr> <tr> <td>enumeration</td> <td>0341002</td> <td>documentation Implantation von mehr als einer Prothese</td> </tr> <tr> <td>enumeration</td> <td>0341003</td> <td>documentation gravierende Gefäß- oder Zugangskomplikation (gemäß VARC-3)</td> </tr> <tr> <td>enumeration</td> <td>0341004</td> <td>documentation erforderlicher chirurgischer oder interventioneller Eingriff wegen einer Klappenfehlfunktion (gemäß VARC-3)</td> </tr> <tr> <td>enumeration</td> <td>0341005</td> <td>documentation &amp;gt;= große strukturelle kardiale Komplikation (gemäß VARC-3)</td> </tr> </tbody> </table>	Kind	Value	Annotation	enumeration	0341001	documentation intraprozedural verstorben	enumeration	0341002	documentation Implantation von mehr als einer Prothese	enumeration	0341003	documentation gravierende Gefäß- oder Zugangskomplikation (gemäß VARC-3)	enumeration	0341004	documentation erforderlicher chirurgischer oder interventioneller Eingriff wegen einer Klappenfehlfunktion (gemäß VARC-3)	enumeration	0341005	documentation &gt;= große strukturelle kardiale Komplikation (gemäß VARC-3)
Kind	Value	Annotation																	
enumeration	0341001	documentation intraprozedural verstorben																	
enumeration	0341002	documentation Implantation von mehr als einer Prothese																	
enumeration	0341003	documentation gravierende Gefäß- oder Zugangskomplikation (gemäß VARC-3)																	
enumeration	0341004	documentation erforderlicher chirurgischer oder interventioneller Eingriff wegen einer Klappenfehlfunktion (gemäß VARC-3)																	
enumeration	0341005	documentation &gt;= große strukturelle kardiale Komplikation (gemäß VARC-3)																	
annotation	documentation Kat_AK_FailureGrund																		
source	<pre> &lt;simpleType name="enum_0341"&gt;   &lt;annotation&gt;     &lt;documentation&gt;Kat_AK_FailureGrund&lt;/documentation&gt;   &lt;/annotation&gt;   &lt;restriction base="xs:string"&gt;     &lt;enumeration value="0341001"&gt;       &lt;annotation&gt;         &lt;documentation&gt;intraprozedural verstorben&lt;/documentation&gt;       &lt;/annotation&gt;     &lt;/enumeration&gt;     &lt;enumeration value="0341002"&gt;       &lt;annotation&gt;         &lt;documentation&gt;Implantation von mehr als einer Prothese&lt;/documentation&gt;       &lt;/annotation&gt;     &lt;/enumeration&gt;     &lt;enumeration value="0341003"&gt;       &lt;annotation&gt;         &lt;documentation&gt;gravierende Gefäß- oder Zugangskomplikation (gemäß VARC-3)&lt;/documentation&gt;       &lt;/annotation&gt;     &lt;/enumeration&gt;     &lt;enumeration value="0341004"&gt;       &lt;annotation&gt;         &lt;documentation&gt;erforderlicher chirurgischer oder interventioneller Eingriff wegen einer Klappenfehlfunktion (gemäß VARC-3)&lt;/documentation&gt;       &lt;/annotation&gt;     &lt;/enumeration&gt;     &lt;enumeration value="0341005"&gt;       &lt;annotation&gt;         &lt;documentation&gt;&amp;gt;= große strukturelle kardiale Komplikation (gemäß VARC-3)&lt;/documentation&gt;       &lt;/annotation&gt;     &lt;/enumeration&gt;   &lt;/restriction&gt; &lt;/simpleType&gt; </pre>																		

### simpleType enum\_0342

namespace	http://xml.ir-d.de/irdma						
type	restriction of <b>string</b>						
properties	base xs:string						
facets	<table border="1"> <thead> <tr> <th>Kind</th> <th>Value</th> <th>Annotation</th> </tr> </thead> <tbody> <tr> <td>enumeration</td> <td>0342001</td> <td>documentation</td> </tr> </tbody> </table>	Kind	Value	Annotation	enumeration	0342001	documentation
Kind	Value	Annotation					
enumeration	0342001	documentation					

	<p>enumeration 0342002 Alter documentation Frailty</p> <p>enumeration 0342003 documentation Hochrisiko</p> <p>enumeration 0342004 documentation Prognose-limitierende Zweiterkrankung</p> <p>enumeration 0342005 documentation Porzellan-Aorta</p> <p>enumeration 0342042 documentation Sonstige</p>
annotation	documentation Kat AK Tavi
source	<pre> &lt;simpleType name="enum_0342"&gt;   &lt;annotation&gt;     &lt;documentation&gt;Kat_AK_Tavi&lt;/documentation&gt;   &lt;/annotation&gt;   &lt;restriction base="xs:string"&gt;     &lt;enumeration value="0342001"&gt;       &lt;annotation&gt;         &lt;documentation&gt;Alter&lt;/documentation&gt;       &lt;/annotation&gt;     &lt;/enumeration&gt;     &lt;enumeration value="0342002"&gt;       &lt;annotation&gt;         &lt;documentation&gt;Frailty&lt;/documentation&gt;       &lt;/annotation&gt;     &lt;/enumeration&gt;     &lt;enumeration value="0342003"&gt;       &lt;annotation&gt;         &lt;documentation&gt;Hochrisiko&lt;/documentation&gt;       &lt;/annotation&gt;     &lt;/enumeration&gt;     &lt;enumeration value="0342004"&gt;       &lt;annotation&gt;         &lt;documentation&gt;Prognose-limitierende Zweiterkrankung&lt;/documentation&gt;       &lt;/annotation&gt;     &lt;/enumeration&gt;     &lt;enumeration value="0342005"&gt;       &lt;annotation&gt;         &lt;documentation&gt;Porzellan-Aorta&lt;/documentation&gt;       &lt;/annotation&gt;     &lt;/enumeration&gt;     &lt;enumeration value="0342042"&gt;       &lt;annotation&gt;         &lt;documentation&gt;Sonstige&lt;/documentation&gt;       &lt;/annotation&gt;     &lt;/enumeration&gt;   &lt;/restriction&gt; &lt;/simpleType&gt; </pre>

### simpleType enum\_0343

namespace	http://xml.ir-d.de/irdma		
type	restriction of <b>string</b>		
properties	base xs:string		
facets	Kind	Value	Annotation

	<p>enumeration 0343001 documentation Device-Fehlpositionierung</p> <p>enumeration 0343002 documentation Koronarostienverschluss</p> <p>enumeration 0343003 documentation Aortendissektion</p> <p>enumeration 0343004 documentation Aortenregurgitation &amp;gt; = 2. Grades</p> <p>enumeration 0343005 documentation Annulus-Ruptur</p> <p>enumeration 0343006 documentation Ruptur-/Perforation einer Herzhöhle ohne Therapiebedarf</p> <p>enumeration 0343007 documentation Ruptur-/Perforation einer Herzhöhle mit Therapiebedarf</p> <p>enumeration 0343008 documentation Perikardtamponade</p> <p>enumeration 0343009 documentation kardiale Dekompensation</p> <p>enumeration 0343010 documentation Hirnembolie</p> <p>enumeration 0343011 documentation Rhythmusstörungen</p> <p>enumeration 0343012 documentation Device-Embolisation</p> <p>enumeration 0343013 documentation vaskuläre Komplikation</p> <p>enumeration 0343014 documentation Low Cardiac Output</p> <p>enumeration 0343015 documentation schwerwiegende Blutungen (intraprozedural)</p> <p>enumeration 0343016 documentation lebensbedrohliche Blutungen (intraprozedural)</p> <p>enumeration 0343017 documentation Patient verstarb im OP/Katheterlabor</p> <p>enumeration 0343042 documentation sonstige intraprozedurale Komplikationen</p>
annotation	documentation Kat_AK_KomplikationTyp
source	<pre> &lt;simpleType name="enum_0343"&gt;   &lt;annotation&gt;     &lt;documentation&gt;Kat_AK_KomplikationTyp&lt;/documentation&gt;   &lt;/annotation&gt;   &lt;restriction base="xs:string"&gt;     &lt;enumeration value="0343001"&gt;       &lt;annotation&gt;         &lt;documentation&gt;Device-Fehlpositionierung&lt;/documentation&gt;       &lt;/annotation&gt;     &lt;/enumeration&gt;     &lt;enumeration value="0343002"&gt;       &lt;annotation&gt;         &lt;documentation&gt;Koronarostienverschluss&lt;/documentation&gt;       &lt;/annotation&gt;     &lt;/enumeration&gt;     &lt;enumeration value="0343003"&gt;       &lt;annotation&gt;         &lt;documentation&gt;Aortendissektion&lt;/documentation&gt;       &lt;/annotation&gt;     &lt;/enumeration&gt;     &lt;enumeration value="0343004"&gt;       &lt;annotation&gt;         &lt;documentation&gt;Aortenregurgitation &amp;gt; = 2. Grades&lt;/documentation&gt;       &lt;/annotation&gt;     &lt;/enumeration&gt;   &lt;/restriction&gt; &lt;/simpleType&gt; </pre>



```

</enumeration>
<enumeration value="0343005">
  <annotation>
    <documentation>Annulus-Ruptur</documentation>
  </annotation>
</enumeration>
<enumeration value="0343006">
  <annotation>
    <documentation>Ruptur-/Perforation einer Herzhöhle ohne
Therapiebedarf</documentation>
  </annotation>
</enumeration>
<enumeration value="0343007">
  <annotation>
    <documentation>Ruptur-/Perforation einer Herzhöhle mit
Therapiebedarf</documentation>
  </annotation>
</enumeration>
<enumeration value="0343008">
  <annotation>
    <documentation>Perikardtamponade</documentation>
  </annotation>
</enumeration>
<enumeration value="0343009">
  <annotation>
    <documentation>kardiale Dekompensation</documentation>
  </annotation>
</enumeration>
<enumeration value="0343010">
  <annotation>
    <documentation>Hirnembolie</documentation>
  </annotation>
</enumeration>
<enumeration value="0343011">
  <annotation>
    <documentation>Rhythmusstörungen</documentation>
  </annotation>
</enumeration>
<enumeration value="0343012">
  <annotation>
    <documentation>Device-Embolisation</documentation>
  </annotation>
</enumeration>
<enumeration value="0343013">
  <annotation>
    <documentation>vaskuläre Komplikation</documentation>
  </annotation>
</enumeration>
<enumeration value="0343014">
  <annotation>
    <documentation>Low Cardiac Output</documentation>
  </annotation>
</enumeration>
<enumeration value="0343015">
  <annotation>
    <documentation>schwerwiegende Blutungen
(intraprozedural)</documentation>
  </annotation>
</enumeration>

```

	<pre> &lt;enumeration value="0343016"&gt;   &lt;annotation&gt;     &lt;documentation&gt;lebensbedrohliche Blutungen (intraprozedural)&lt;/documentation&gt;   &lt;/annotation&gt; &lt;/enumeration&gt; &lt;enumeration value="0343017"&gt;   &lt;annotation&gt;     &lt;documentation&gt;Patient verstarb im OP/Katheterlabor&lt;/documentation&gt;   &lt;/annotation&gt; &lt;/enumeration&gt; &lt;enumeration value="0343042"&gt;   &lt;annotation&gt;     &lt;documentation&gt;sonstige intraprozedurale Komplikationen&lt;/documentation&gt;   &lt;/annotation&gt; &lt;/enumeration&gt; &lt;/restriction&gt; &lt;/simpleType&gt; </pre>
--	--

### simpleType enum 0346

namespace	http://xml.ir-d.de/irdma		
type	restriction of <b>string</b>		
properties	base xs:string		
facets	Kind	Value	Annotation
	enumeration	0346001	documentation keine Therapie erforderlich
	enumeration	0346002	documentation medikamentös
	enumeration	0346003	documentation IABP
	enumeration	0346004	documentation VAD
	enumeration	0346005	documentation ECMO
	enumeration	0346042	documentation sonstige
annotation	documentation Kat_AK_TherapieLCO		
source	<pre> &lt;simpleType name="enum_0346"&gt;   &lt;annotation&gt;     &lt;documentation&gt;Kat_AK_TherapieLCO&lt;/documentation&gt;   &lt;/annotation&gt;   &lt;restriction base="xs:string"&gt;     &lt;enumeration value="0346001"&gt;       &lt;annotation&gt;         &lt;documentation&gt;keine Therapie erforderlich&lt;/documentation&gt;       &lt;/annotation&gt;     &lt;/enumeration&gt;     &lt;enumeration value="0346002"&gt;       &lt;annotation&gt;         &lt;documentation&gt;medikamentös&lt;/documentation&gt;       &lt;/annotation&gt;     &lt;/enumeration&gt;     &lt;enumeration value="0346003"&gt;       &lt;annotation&gt; </pre>		

	<pre> &lt;documentation&gt;IABP&lt;/documentation&gt; &lt;/annotation&gt; &lt;/enumeration&gt; &lt;enumeration value="0346004"&gt;   &lt;annotation&gt;     &lt;documentation&gt;VAD&lt;/documentation&gt;   &lt;/annotation&gt; &lt;/enumeration&gt; &lt;enumeration value="0346005"&gt;   &lt;annotation&gt;     &lt;documentation&gt;ECMO&lt;/documentation&gt;   &lt;/annotation&gt; &lt;/enumeration&gt; &lt;enumeration value="0346042"&gt;   &lt;annotation&gt;     &lt;documentation&gt;sonstige&lt;/documentation&gt;   &lt;/annotation&gt; &lt;/enumeration&gt; &lt;/restriction&gt; &lt;/simpleType&gt; </pre>
--	---

### simpleType enum\_0347

namespace	http://xml.ir-d.de/irdma		
type	restriction of <b>string</b>		
properties	base xs:string		
facets	Kind	Value	Annotation
	enumeration	0347001	documentation Einzeleingriff
	enumeration	0347002	documentation Kombinationseingriff mit mehreren Prozeduren
annotation	documentation Kat_AK_Eingriffsumfang		
source	<pre> &lt;simpleType name="enum_0347"&gt;   &lt;annotation&gt;     &lt;documentation&gt;Kat_AK_Eingriffsumfang&lt;/documentation&gt;   &lt;/annotation&gt;   &lt;restriction base="xs:string"&gt;     &lt;enumeration value="0347001"&gt;       &lt;annotation&gt;         &lt;documentation&gt;Einzeleingriff&lt;/documentation&gt;       &lt;/annotation&gt;     &lt;/enumeration&gt;     &lt;enumeration value="0347002"&gt;       &lt;annotation&gt;         &lt;documentation&gt;Kombinationseingriff mit mehreren Prozeduren&lt;/documentation&gt;       &lt;/annotation&gt;     &lt;/enumeration&gt;   &lt;/restriction&gt; &lt;/simpleType&gt; </pre>		

### simpleType enum\_0348

namespace	http://xml.ir-d.de/irdma
-----------	--------------------------

type	restriction of <b>string</b>												
properties	base xs:string												
facets	<table border="1"> <thead> <tr> <th>Kind</th> <th>Value</th> <th>Annotation</th> </tr> </thead> <tbody> <tr> <td>enumeration</td> <td>0348001</td> <td>documentation mit HLM</td> </tr> <tr> <td>enumeration</td> <td>0348002</td> <td>documentation ohne HLM</td> </tr> <tr> <td>enumeration</td> <td>0348003</td> <td>documentation Umstieg von OP ohne HLM auf OP mit HLM</td> </tr> </tbody> </table>	Kind	Value	Annotation	enumeration	0348001	documentation mit HLM	enumeration	0348002	documentation ohne HLM	enumeration	0348003	documentation Umstieg von OP ohne HLM auf OP mit HLM
Kind	Value	Annotation											
enumeration	0348001	documentation mit HLM											
enumeration	0348002	documentation ohne HLM											
enumeration	0348003	documentation Umstieg von OP ohne HLM auf OP mit HLM											
annotation	documentation Kat_AK_OPVorgehen												
source	<pre> &lt;simpleType name="enum_0348"&gt;   &lt;annotation&gt;     &lt;documentation&gt;Kat_AK_OPVorgehen&lt;/documentation&gt;   &lt;/annotation&gt;   &lt;restriction base="xs:string"&gt;     &lt;enumeration value="0348001"&gt;       &lt;annotation&gt;         &lt;documentation&gt;mit HLM&lt;/documentation&gt;       &lt;/annotation&gt;     &lt;/enumeration&gt;     &lt;enumeration value="0348002"&gt;       &lt;annotation&gt;         &lt;documentation&gt;ohne HLM&lt;/documentation&gt;       &lt;/annotation&gt;     &lt;/enumeration&gt;     &lt;enumeration value="0348003"&gt;       &lt;annotation&gt;         &lt;documentation&gt;Umstieg von OP ohne HLM auf OP mit HLM&lt;/documentation&gt;       &lt;/annotation&gt;     &lt;/enumeration&gt;   &lt;/restriction&gt; &lt;/simpleType&gt; </pre>												

### simpleType **enum\_0350**

namespace	http://xml.ir-d.de/irdma																		
type	restriction of <b>string</b>																		
properties	base xs:string																		
facets	<table border="1"> <thead> <tr> <th>Kind</th> <th>Value</th> <th>Annotation</th> </tr> </thead> <tbody> <tr> <td>enumeration</td> <td>0350001</td> <td>documentation IABP</td> </tr> <tr> <td>enumeration</td> <td>0350002</td> <td>documentation Impella</td> </tr> <tr> <td>enumeration</td> <td>0350003</td> <td>documentation vv ECMO</td> </tr> <tr> <td>enumeration</td> <td>0350004</td> <td>documentation va ECMO</td> </tr> <tr> <td>enumeration</td> <td>0350042</td> <td>documentation andere</td> </tr> </tbody> </table>	Kind	Value	Annotation	enumeration	0350001	documentation IABP	enumeration	0350002	documentation Impella	enumeration	0350003	documentation vv ECMO	enumeration	0350004	documentation va ECMO	enumeration	0350042	documentation andere
Kind	Value	Annotation																	
enumeration	0350001	documentation IABP																	
enumeration	0350002	documentation Impella																	
enumeration	0350003	documentation vv ECMO																	
enumeration	0350004	documentation va ECMO																	
enumeration	0350042	documentation andere																	
annotation	documentation Kat_AK_Methode																		
source	<pre> &lt;simpleType name="enum_0350"&gt;   &lt;annotation&gt;     &lt;documentation&gt;Kat_AK_Methode&lt;/documentation&gt;   &lt;/annotation&gt; </pre>																		

```

<restriction base="xs:string">
  <enumeration value="0350001">
    <annotation>
      <documentation>IABP</documentation>
    </annotation>
  </enumeration>
  <enumeration value="0350002">
    <annotation>
      <documentation>Impella</documentation>
    </annotation>
  </enumeration>
  <enumeration value="0350003">
    <annotation>
      <documentation>vv ECMO</documentation>
    </annotation>
  </enumeration>
  <enumeration value="0350004">
    <annotation>
      <documentation>va ECMO</documentation>
    </annotation>
  </enumeration>
  <enumeration value="0350042">
    <annotation>
      <documentation>andere</documentation>
    </annotation>
  </enumeration>
</restriction>
</simpleType>

```

simpleType enum\_0351

namespace	http://xml.ir-d.de/irdma		
type	restriction of <b>string</b>		
properties	base xs:string		
facets	Kind	Value	Annotation
	enumeration	0351001	documentation nein
	enumeration	0351002	documentation ja, zu Sternotomie
	enumeration	0351003	documentation ja, zu transapikal
	enumeration	0351004	documentation ja, zu transaortal
	enumeration	0351005	documentation ja, zu transfemoral
	enumeration	0351006	documentation ja, zu transaxillär
	enumeration	0351007	documentation ja, zu anderem endovaskulären Zugang
	enumeration	0351042	documentation ja, zu anderem Zugang
annotation	documentation Kat_AK_Konversion		
source	<pre> &lt;simpleType name="enum_0351"&gt;   &lt;annotation&gt;     &lt;documentation&gt;Kat_AK_Konversion&lt;/documentation&gt;   &lt;/annotation&gt; &lt;/restriction base="xs:string"&gt; </pre>		

```

<enumeration value="0351001">
  <annotation>
    <documentation>nein</documentation>
  </annotation>
</enumeration>
<enumeration value="0351002">
  <annotation>
    <documentation>ja, zu Sternotomie</documentation>
  </annotation>
</enumeration>
<enumeration value="0351003">
  <annotation>
    <documentation>ja, zu transapikal</documentation>
  </annotation>
</enumeration>
<enumeration value="0351004">
  <annotation>
    <documentation>ja, zu transaortal</documentation>
  </annotation>
</enumeration>
<enumeration value="0351005">
  <annotation>
    <documentation>ja, zu transfemoral</documentation>
  </annotation>
</enumeration>
<enumeration value="0351006">
  <annotation>
    <documentation>ja, zu transaxillär</documentation>
  </annotation>
</enumeration>
<enumeration value="0351007">
  <annotation>
    <documentation>ja, zu anderem endovaskulären Zugang</documentation>
  </annotation>
</enumeration>
<enumeration value="0351042">
  <annotation>
    <documentation>ja, zu anderem Zugang</documentation>
  </annotation>
</enumeration>
</restriction>
</simpleType>

```

### simpleType enum\_0352

namespace	http://xml.ir-d.de/irdma		
type	restriction of <b>string</b>		
properties	base xs:string		
facets	Kind	Value	Annotation
	enumeration	0352001	documentation nein
	enumeration	0352002	documentation ja, Intubationsnarkose
	enumeration	0352003	documentation ja, Maskenbeatmung, incl. LAMA
	enumeration	0352042	documentation ja, unbekannt welche

annotation	documentation Kat_AK_Anaesthesie
source	<pre> &lt;simpleType name="enum_0352"&gt;   &lt;annotation&gt;     &lt;documentation&gt;Kat_AK_Anaesthesie&lt;/documentation&gt;   &lt;/annotation&gt;   &lt;restriction base="xs:string"&gt;     &lt;enumeration value="0352001"&gt;       &lt;annotation&gt;         &lt;documentation&gt;nein&lt;/documentation&gt;       &lt;/annotation&gt;     &lt;/enumeration&gt;     &lt;enumeration value="0352002"&gt;       &lt;annotation&gt;         &lt;documentation&gt;ja, Intubationsnarkose&lt;/documentation&gt;       &lt;/annotation&gt;     &lt;/enumeration&gt;     &lt;enumeration value="0352003"&gt;       &lt;annotation&gt;         &lt;documentation&gt;ja, Maskenbeatmung, incl. LAMA&lt;/documentation&gt;       &lt;/annotation&gt;     &lt;/enumeration&gt;     &lt;enumeration value="0352042"&gt;       &lt;annotation&gt;         &lt;documentation&gt;ja, unbekannt welche&lt;/documentation&gt;       &lt;/annotation&gt;     &lt;/enumeration&gt;   &lt;/restriction&gt; &lt;/simpleType&gt; </pre>

### simpleType enum\_0353

namespace	http://xml.ir-d.de/irdma		
type	restriction of <b>string</b>		
properties	base xs:string		
facets	Kind	Value	Annotation
	enumeration	0353001	documentation keine
	enumeration	0353002	documentation leichtgradig
	enumeration	0353003	documentation mittelgradig
	enumeration	0353004	documentation hochgradig
	enumeration	0353099	documentation nicht bestimmbar
annotation	documentation Kat_AK_ResidualeArteninsuffizienz		
source	<pre> &lt;simpleType name="enum_0353"&gt;   &lt;annotation&gt;     &lt;documentation&gt;Kat_AK_ResidualeArteninsuffizienz&lt;/documentation&gt;   &lt;/annotation&gt;   &lt;restriction base="xs:string"&gt;     &lt;enumeration value="0353001"&gt;       &lt;annotation&gt;         &lt;documentation&gt;keine&lt;/documentation&gt;       &lt;/annotation&gt;     &lt;/enumeration&gt;   &lt;/restriction&gt; &lt;/simpleType&gt; </pre>		

	<pre> &lt;/enumeration&gt; &lt;enumeration value="0353002"&gt;   &lt;annotation&gt;     &lt;documentation&gt;leichtgradig&lt;/documentation&gt;   &lt;/annotation&gt; &lt;/enumeration&gt; &lt;enumeration value="0353003"&gt;   &lt;annotation&gt;     &lt;documentation&gt;mittelgradig&lt;/documentation&gt;   &lt;/annotation&gt; &lt;/enumeration&gt; &lt;enumeration value="0353004"&gt;   &lt;annotation&gt;     &lt;documentation&gt;hochgradig&lt;/documentation&gt;   &lt;/annotation&gt; &lt;/enumeration&gt; &lt;enumeration value="0353099"&gt;   &lt;annotation&gt;     &lt;documentation&gt;nicht bestimmbar&lt;/documentation&gt;   &lt;/annotation&gt; &lt;/enumeration&gt; &lt;/restriction&gt; &lt;/simpleType&gt; </pre>
--	--

#### simpleType enum\_0354

namespace	http://xml.ir-d.de/irdma		
type	restriction of <b>string</b>		
properties	base xs:string		
facets	Kind	Value	Annotation
	enumeration	0354001	documentation chirurgisch-offen
	enumeration	0354002	documentation Verschluss-System
	enumeration	0354042	documentation sonstige
annotation	documentation Kat AK Zugangswegverschluss		
source	<pre> &lt;simpleType name="enum_0354"&gt;   &lt;annotation&gt;     &lt;documentation&gt;Kat_AK_Zugangswegverschluss&lt;/documentation&gt;   &lt;/annotation&gt;   &lt;restriction base="xs:string"&gt;     &lt;enumeration value="0354001"&gt;       &lt;annotation&gt;         &lt;documentation&gt;chirurgisch-offen&lt;/documentation&gt;       &lt;/annotation&gt;     &lt;/enumeration&gt;     &lt;enumeration value="0354002"&gt;       &lt;annotation&gt;         &lt;documentation&gt;Verschluss-System&lt;/documentation&gt;       &lt;/annotation&gt;     &lt;/enumeration&gt;     &lt;enumeration value="0354042"&gt;       &lt;annotation&gt;         &lt;documentation&gt;sonstige&lt;/documentation&gt;       &lt;/annotation&gt;     &lt;/enumeration&gt;   &lt;/restriction&gt; &lt;/simpleType&gt; </pre>		



```

</enumeration>
</restriction>
</simpleType>

```

### simpleType enum\_0357

namespace	http://xml.ir-d.de/irdma		
type	restriction of <b>string</b>		
properties	base xs:string		
facets	Kind	Value	Annotation
	enumeration	0357001	documentation keine KHK
	enumeration	0357002	documentation 1-Gefäßerkrankung
	enumeration	0357003	documentation 2-Gefäßerkrankung
	enumeration	0357004	documentation 3-Gefäßerkrankung
	enumeration	0357005	documentation keine koronare Bildgebung
annotation	documentation Kat_AK_BefundBildgebung		
source	<pre> &lt;simpleType name="enum_0357"&gt;   &lt;annotation&gt;     &lt;documentation&gt;Kat_AK_BefundBildgebung&lt;/documentation&gt;   &lt;/annotation&gt;   &lt;restriction base="xs:string"&gt;     &lt;enumeration value="0357001"&gt;       &lt;annotation&gt;         &lt;documentation&gt;keine KHK&lt;/documentation&gt;       &lt;/annotation&gt;     &lt;/enumeration&gt;     &lt;enumeration value="0357002"&gt;       &lt;annotation&gt;         &lt;documentation&gt;1-Gefäßerkrankung&lt;/documentation&gt;       &lt;/annotation&gt;     &lt;/enumeration&gt;     &lt;enumeration value="0357003"&gt;       &lt;annotation&gt;         &lt;documentation&gt;2-Gefäßerkrankung&lt;/documentation&gt;       &lt;/annotation&gt;     &lt;/enumeration&gt;     &lt;enumeration value="0357004"&gt;       &lt;annotation&gt;         &lt;documentation&gt;3-Gefäßerkrankung&lt;/documentation&gt;       &lt;/annotation&gt;     &lt;/enumeration&gt;     &lt;enumeration value="0357005"&gt;       &lt;annotation&gt;         &lt;documentation&gt;keine koronare Bildgebung&lt;/documentation&gt;       &lt;/annotation&gt;     &lt;/enumeration&gt;   &lt;/restriction&gt; &lt;/simpleType&gt; </pre>		

### simpleType enum\_0358

namespace	http://xml.ir-d.de/irdma		
type	restriction of <b>string</b>		
properties	base xs:string		
facets	Kind	Value	Annotation
	enumeration	0358001	documentation 0
	enumeration	0358002	documentation 1
	enumeration	0358003	documentation 2
	enumeration	0358004	documentation 3
	enumeration	0358005	documentation 4
	enumeration	0358006	documentation 5 oder mehr
	enumeration	0358098	documentation genaue Anzahl unbekannt (aber mind. 1)
	enumeration	0358099	documentation unbekannt
annotation	documentation Kat_AK_AnzahlVorOP		
source	<pre> &lt;simpleType name="enum_0358"&gt;   &lt;annotation&gt;     &lt;documentation&gt;Kat_AK_AnzahlVorOP&lt;/documentation&gt;   &lt;/annotation&gt;   &lt;restriction base="xs:string"&gt;     &lt;enumeration value="0358001"&gt;       &lt;annotation&gt;         &lt;documentation&gt;0&lt;/documentation&gt;       &lt;/annotation&gt;     &lt;/enumeration&gt;     &lt;enumeration value="0358002"&gt;       &lt;annotation&gt;         &lt;documentation&gt;1&lt;/documentation&gt;       &lt;/annotation&gt;     &lt;/enumeration&gt;     &lt;enumeration value="0358003"&gt;       &lt;annotation&gt;         &lt;documentation&gt;2&lt;/documentation&gt;       &lt;/annotation&gt;     &lt;/enumeration&gt;     &lt;enumeration value="0358004"&gt;       &lt;annotation&gt;         &lt;documentation&gt;3&lt;/documentation&gt;       &lt;/annotation&gt;     &lt;/enumeration&gt;     &lt;enumeration value="0358005"&gt;       &lt;annotation&gt;         &lt;documentation&gt;4&lt;/documentation&gt;       &lt;/annotation&gt;     &lt;/enumeration&gt;     &lt;enumeration value="0358006"&gt;       &lt;annotation&gt;         &lt;documentation&gt;5 oder mehr&lt;/documentation&gt;       &lt;/annotation&gt;     &lt;/enumeration&gt;   &lt;/restriction&gt; &lt;/simpleType&gt; </pre>		

	<pre> &lt;enumeration value="0358098"&gt;   &lt;annotation&gt;     &lt;documentation&gt;genaue Anzahl unbekannt (aber mind. 1)&lt;/documentation&gt;   &lt;/annotation&gt; &lt;/enumeration&gt; &lt;enumeration value="0358099"&gt;   &lt;annotation&gt;     &lt;documentation&gt;unbekannt&lt;/documentation&gt;   &lt;/annotation&gt; &lt;/enumeration&gt; &lt;/restriction&gt; &lt;/simpleType&gt; </pre>
--	--

### simpleType enum\_0359

namespace	http://xml.ir-d.de/irdma		
type	restriction of <b>string</b>		
properties	base xs:string		
facets	Kind	Value	Annotation
	enumeration	0359001	documentation nein
	enumeration	0359002	documentation ja - einseitig
	enumeration	0359003	documentation ja - beidseitig
	enumeration	0359042	documentation unbekannt
annotation	documentation Kat_AK_LVOT		
source	<pre> &lt;simpleType name="enum_0359"&gt;   &lt;annotation&gt;     &lt;documentation&gt;Kat_AK_LVOT&lt;/documentation&gt;   &lt;/annotation&gt;   &lt;restriction base="xs:string"&gt;     &lt;enumeration value="0359001"&gt;       &lt;annotation&gt;         &lt;documentation&gt;nein&lt;/documentation&gt;       &lt;/annotation&gt;     &lt;/enumeration&gt;     &lt;enumeration value="0359002"&gt;       &lt;annotation&gt;         &lt;documentation&gt;ja - einseitig&lt;/documentation&gt;       &lt;/annotation&gt;     &lt;/enumeration&gt;     &lt;enumeration value="0359003"&gt;       &lt;annotation&gt;         &lt;documentation&gt;ja - beidseitig&lt;/documentation&gt;       &lt;/annotation&gt;     &lt;/enumeration&gt;     &lt;enumeration value="0359042"&gt;       &lt;annotation&gt;         &lt;documentation&gt;unbekannt&lt;/documentation&gt;       &lt;/annotation&gt;     &lt;/enumeration&gt;   &lt;/restriction&gt; &lt;/simpleType&gt; </pre>		

### simpleType enum 0360

namespace	http://xml.ir-d.de/irdma		
type	restriction of <b>string</b>		
properties	base xs:string		
facets	Kind	Value	Annotation
	enumeration	0360001	documentation keine
	enumeration	0360002	documentation leichtgradig
	enumeration	0360003	documentation mittelgradig
	enumeration	0360004	documentation hochgradig
	enumeration	0360005	documentation massive
	enumeration	0360006	documentation torrential
	enumeration	0360099	documentation unbekannt
annotation	documentation Kat_AK_TriskupidalInsuffizienz		
source	<pre> &lt;simpleType name="enum_0360"&gt;   &lt;annotation&gt;     &lt;documentation&gt;Kat_AK_TriskupidalInsuffizienz&lt;/documentation&gt;   &lt;/annotation&gt;   &lt;restriction base="xs:string"&gt;     &lt;enumeration value="0360001"&gt;       &lt;annotation&gt;         &lt;documentation&gt;keine&lt;/documentation&gt;       &lt;/annotation&gt;     &lt;/enumeration&gt;     &lt;enumeration value="0360002"&gt;       &lt;annotation&gt;         &lt;documentation&gt;leichtgradig&lt;/documentation&gt;       &lt;/annotation&gt;     &lt;/enumeration&gt;     &lt;enumeration value="0360003"&gt;       &lt;annotation&gt;         &lt;documentation&gt;mittelgradig&lt;/documentation&gt;       &lt;/annotation&gt;     &lt;/enumeration&gt;     &lt;enumeration value="0360004"&gt;       &lt;annotation&gt;         &lt;documentation&gt;hochgradig&lt;/documentation&gt;       &lt;/annotation&gt;     &lt;/enumeration&gt;     &lt;enumeration value="0360005"&gt;       &lt;annotation&gt;         &lt;documentation&gt;massive&lt;/documentation&gt;       &lt;/annotation&gt;     &lt;/enumeration&gt;     &lt;enumeration value="0360006"&gt;       &lt;annotation&gt;         &lt;documentation&gt;torrential&lt;/documentation&gt;       &lt;/annotation&gt;     &lt;/enumeration&gt;   &lt;/restriction&gt; &lt;/simpleType&gt; </pre>		

	<pre> &lt;enumeration value="0360099"&gt;   &lt;annotation&gt;     &lt;documentation&gt;unbekannt&lt;/documentation&gt;   &lt;/annotation&gt; &lt;/enumeration&gt; &lt;/restriction&gt; &lt;/simpleType&gt; </pre>
--	--

### simpleType enum\_0361

namespace	http://xml.ir-d.de/irdma		
type	restriction of <b>string</b>		
properties	base xs:string		
facets	Kind	Value	Annotation
	enumeration	0361001	documentation nein
	enumeration	0361002	documentation ja, letzte(r) innerhalb der letzten 48 Stunden
	enumeration	0361003	documentation ja, letzte(r) innerhalb der letzten 21 Tage
	enumeration	0361004	documentation ja, letzte(r) länger als 21 Tage
	enumeration	0361098	documentation ja, letzter Zeitpunkt unbekannt
	enumeration	0361099	documentation unbekannt
annotation	documentation Kat AK SchockReanimation		
source	<pre> &lt;simpleType name="enum_0361"&gt;   &lt;annotation&gt;     &lt;documentation&gt;Kat_AK_SchockReanimation&lt;/documentation&gt;   &lt;/annotation&gt;   &lt;restriction base="xs:string"&gt;     &lt;enumeration value="0361001"&gt;       &lt;annotation&gt;         &lt;documentation&gt;nein&lt;/documentation&gt;       &lt;/annotation&gt;     &lt;/enumeration&gt;     &lt;enumeration value="0361002"&gt;       &lt;annotation&gt;         &lt;documentation&gt;ja, letzte(r) innerhalb der letzten 48 Stunden&lt;/documentation&gt;       &lt;/annotation&gt;     &lt;/enumeration&gt;     &lt;enumeration value="0361003"&gt;       &lt;annotation&gt;         &lt;documentation&gt;ja, letzte(r) innerhalb der letzten 21 Tage&lt;/documentation&gt;       &lt;/annotation&gt;     &lt;/enumeration&gt;     &lt;enumeration value="0361004"&gt;       &lt;annotation&gt;         &lt;documentation&gt;ja, letzte(r) länger als 21 Tage&lt;/documentation&gt;       &lt;/annotation&gt;     &lt;/enumeration&gt;     &lt;enumeration value="0361098"&gt;       &lt;annotation&gt; </pre>		

	<pre> &lt;documentation&gt;ja, letzter Zeitpunkt unbekannt&lt;/documentation&gt; &lt;/annotation&gt; &lt;/enumeration&gt; &lt;enumeration value="0361099"&gt;   &lt;annotation&gt;     &lt;documentation&gt;unbekannt&lt;/documentation&gt;   &lt;/annotation&gt; &lt;/enumeration&gt; &lt;/restriction&gt; &lt;/simpleType&gt; </pre>
--	--

### simpleType enum\_0362

namespace	http://xml.ir-d.de/irdma		
type	restriction of <b>string</b>		
properties	base xs:string		
facets	Kind	Value	Annotation
	enumeration	0362001	documentation Sinusrhythmus
	enumeration	0362002	documentation Vorhofflimmern
	enumeration	0362042	documentation anderer Herzrhythmus
annotation	documentation Kat_AK_Herzrhythmus		
source	<pre> &lt;simpleType name="enum_0362"&gt;   &lt;annotation&gt;     &lt;documentation&gt;Kat_AK_Herzrhythmus&lt;/documentation&gt;   &lt;/annotation&gt;   &lt;restriction base="xs:string"&gt;     &lt;enumeration value="0362001"&gt;       &lt;annotation&gt;         &lt;documentation&gt;Sinusrhythmus&lt;/documentation&gt;       &lt;/annotation&gt;     &lt;/enumeration&gt;     &lt;enumeration value="0362002"&gt;       &lt;annotation&gt;         &lt;documentation&gt;Vorhofflimmern&lt;/documentation&gt;       &lt;/annotation&gt;     &lt;/enumeration&gt;     &lt;enumeration value="0362042"&gt;       &lt;annotation&gt;         &lt;documentation&gt;anderer Herzrhythmus&lt;/documentation&gt;       &lt;/annotation&gt;     &lt;/enumeration&gt;   &lt;/restriction&gt; &lt;/simpleType&gt; </pre>		

### simpleType enum\_0363

namespace	http://xml.ir-d.de/irdma		
type	restriction of <b>string</b>		
properties	base xs:string		

facets	<table border="1"> <thead> <tr> <th>Kind</th> <th>Value</th> <th>Annotation</th> </tr> </thead> <tbody> <tr> <td>enumeration</td> <td>0363001</td> <td>documentation nein</td> </tr> <tr> <td>enumeration</td> <td>0363002</td> <td>documentation paroxysmal</td> </tr> <tr> <td>enumeration</td> <td>0363003</td> <td>documentation persistierend</td> </tr> <tr> <td>enumeration</td> <td>0363004</td> <td>documentation permanent</td> </tr> </tbody> </table>	Kind	Value	Annotation	enumeration	0363001	documentation nein	enumeration	0363002	documentation paroxysmal	enumeration	0363003	documentation persistierend	enumeration	0363004	documentation permanent
Kind	Value	Annotation														
enumeration	0363001	documentation nein														
enumeration	0363002	documentation paroxysmal														
enumeration	0363003	documentation persistierend														
enumeration	0363004	documentation permanent														
annotation	documentation Kat_AK_Vorhofflimmern															
source	<pre> &lt;simpleType name="enum_0363"&gt;   &lt;annotation&gt;     &lt;documentation&gt;Kat_AK_Vorhofflimmern&lt;/documentation&gt;   &lt;/annotation&gt;   &lt;restriction base="xs:string"&gt;     &lt;enumeration value="0363001"&gt;       &lt;annotation&gt;         &lt;documentation&gt;nein&lt;/documentation&gt;       &lt;/annotation&gt;     &lt;/enumeration&gt;     &lt;enumeration value="0363002"&gt;       &lt;annotation&gt;         &lt;documentation&gt;paroxysmal&lt;/documentation&gt;       &lt;/annotation&gt;     &lt;/enumeration&gt;     &lt;enumeration value="0363003"&gt;       &lt;annotation&gt;         &lt;documentation&gt;persistierend&lt;/documentation&gt;       &lt;/annotation&gt;     &lt;/enumeration&gt;     &lt;enumeration value="0363004"&gt;       &lt;annotation&gt;         &lt;documentation&gt;permanent&lt;/documentation&gt;       &lt;/annotation&gt;     &lt;/enumeration&gt;   &lt;/restriction&gt; &lt;/simpleType&gt; </pre>															

### simpleType enum\_0364

namespace	http://xml.ir-d.de/irdma																		
type	restriction of <b>string</b>																		
properties	base xs:string																		
facets	<table border="1"> <thead> <tr> <th>Kind</th> <th>Value</th> <th>Annotation</th> </tr> </thead> <tbody> <tr> <td>enumeration</td> <td>0364001</td> <td>documentation nein</td> </tr> <tr> <td>enumeration</td> <td>0364002</td> <td>documentation Schrittmacher ohne CRT-System</td> </tr> <tr> <td>enumeration</td> <td>0364003</td> <td>documentation Schrittmacher mit CRT-System</td> </tr> <tr> <td>enumeration</td> <td>0364004</td> <td>documentation Defibrillator ohne CRT-System</td> </tr> <tr> <td>enumeration</td> <td>0364005</td> <td>documentation Defibrillator mit CRT-System</td> </tr> </tbody> </table>	Kind	Value	Annotation	enumeration	0364001	documentation nein	enumeration	0364002	documentation Schrittmacher ohne CRT-System	enumeration	0364003	documentation Schrittmacher mit CRT-System	enumeration	0364004	documentation Defibrillator ohne CRT-System	enumeration	0364005	documentation Defibrillator mit CRT-System
Kind	Value	Annotation																	
enumeration	0364001	documentation nein																	
enumeration	0364002	documentation Schrittmacher ohne CRT-System																	
enumeration	0364003	documentation Schrittmacher mit CRT-System																	
enumeration	0364004	documentation Defibrillator ohne CRT-System																	
enumeration	0364005	documentation Defibrillator mit CRT-System																	
annotation	documentation Kat_AK_SchrittmacherDefi																		

source	<pre> &lt;simpleType name="enum_0364"&gt;   &lt;annotation&gt;     &lt;documentation&gt;Kat_AK_SchrittmacherDefi&lt;/documentation&gt;   &lt;/annotation&gt;   &lt;restriction base="xs:string"&gt;     &lt;enumeration value="0364001"&gt;       &lt;annotation&gt;         &lt;documentation&gt;nein&lt;/documentation&gt;       &lt;/annotation&gt;     &lt;/enumeration&gt;     &lt;enumeration value="0364002"&gt;       &lt;annotation&gt;         &lt;documentation&gt;Schrittmacher ohne CRT-System&lt;/documentation&gt;       &lt;/annotation&gt;     &lt;/enumeration&gt;     &lt;enumeration value="0364003"&gt;       &lt;annotation&gt;         &lt;documentation&gt;Schrittmacher mit CRT-System&lt;/documentation&gt;       &lt;/annotation&gt;     &lt;/enumeration&gt;     &lt;enumeration value="0364004"&gt;       &lt;annotation&gt;         &lt;documentation&gt;Defibrillator ohne CRT-System&lt;/documentation&gt;       &lt;/annotation&gt;     &lt;/enumeration&gt;     &lt;enumeration value="0364005"&gt;       &lt;annotation&gt;         &lt;documentation&gt;Defibrillator mit CRT-System&lt;/documentation&gt;       &lt;/annotation&gt;     &lt;/enumeration&gt;   &lt;/restriction&gt; &lt;/simpleType&gt; </pre>
--------	---

### simpleType enum\_0365

namespace	http://xml.ir-d.de/irdma		
type	restriction of <b>string</b>		
properties	base xs:string		
facets	Kind	Value	Annotation
	enumeration	0365001	documentation nein
	enumeration	0365002	documentation ja, operativ
	enumeration	0365003	documentation ja, interventionell
annotation	documentation Kat_AK_MyokardRevaskularisation		
source	<pre> &lt;simpleType name="enum_0365"&gt;   &lt;annotation&gt;     &lt;documentation&gt;Kat_AK_MyokardRevaskularisation&lt;/documentation&gt;   &lt;/annotation&gt;   &lt;restriction base="xs:string"&gt;     &lt;enumeration value="0365001"&gt;       &lt;annotation&gt;         &lt;documentation&gt;nein&lt;/documentation&gt;       &lt;/annotation&gt;     &lt;/enumeration&gt;   &lt;/restriction&gt; &lt;/simpleType&gt; </pre>		



	<pre> &lt;/enumeration&gt; &lt;enumeration value="0365002"&gt;   &lt;annotation&gt;     &lt;documentation&gt;ja, operativ&lt;/documentation&gt;   &lt;/annotation&gt; &lt;/enumeration&gt; &lt;enumeration value="0365003"&gt;   &lt;annotation&gt;     &lt;documentation&gt;ja, interventionell&lt;/documentation&gt;   &lt;/annotation&gt; &lt;/enumeration&gt; &lt;/restriction&gt; &lt;/simpleType&gt; </pre>
--	---

### simpleType enum\_0366

namespace	http://xml.ir-d.de/irdma		
type	restriction of <b>string</b>		
properties	base xs:string		
facets	Kind	Value	Annotation
	enumeration	0366001	documentation nein
	enumeration	0366002	documentation ja, &lt;= 6 Stunden
	enumeration	0366003	documentation ja, &gt; 6 Stunden bis &lt;= 3 Monate
	enumeration	0366004	documentation ja, &gt; 3 Monate
	enumeration	0366099	documentation unbekannt
annotation	documentation Kat_AK_PCI		
source	<pre> &lt;simpleType name="enum_0366"&gt;   &lt;annotation&gt;     &lt;documentation&gt;Kat_AK_PCI&lt;/documentation&gt;   &lt;/annotation&gt;   &lt;restriction base="xs:string"&gt;     &lt;enumeration value="0366001"&gt;       &lt;annotation&gt;         &lt;documentation&gt;nein&lt;/documentation&gt;       &lt;/annotation&gt;     &lt;/enumeration&gt;     &lt;enumeration value="0366002"&gt;       &lt;annotation&gt;         &lt;documentation&gt;ja, &amp;lt;= 6 Stunden&lt;/documentation&gt;       &lt;/annotation&gt;     &lt;/enumeration&gt;     &lt;enumeration value="0366003"&gt;       &lt;annotation&gt;         &lt;documentation&gt;ja, &amp;gt; 6 Stunden bis &amp;lt;= 3 Monate&lt;/documentation&gt;       &lt;/annotation&gt;     &lt;/enumeration&gt;     &lt;enumeration value="0366004"&gt;       &lt;annotation&gt;         &lt;documentation&gt;ja, &amp;gt; 3 Monate&lt;/documentation&gt;       &lt;/annotation&gt;     &lt;/enumeration&gt;   &lt;/restriction&gt; &lt;/simpleType&gt; </pre>		

	<pre> &lt;enumeration value="0366099"&gt;   &lt;annotation&gt;     &lt;documentation&gt;unbekannt&lt;/documentation&gt;   &lt;/annotation&gt; &lt;/enumeration&gt; &lt;/restriction&gt; &lt;/simpleType&gt; </pre>
--	--

### simpleType enum\_0367

namespace	http://xml.ir-d.de/irdma		
type	restriction of <b>string</b>		
properties	base xs:string		
facets	Kind	Value	Annotation
	enumeration	0367001	documentation keine
	enumeration	0367002	documentation Mediastinitis
	enumeration	0367003	documentation Sepsis
	enumeration	0367004	documentation broncho-pulmonale Infektion
	enumeration	0367005	documentation oto-laryngologische Infektion
	enumeration	0367006	documentation floride Endokarditis
	enumeration	0367007	documentation Peritonitis
	enumeration	0367008	documentation Wundinfektion Thorax
	enumeration	0367009	documentation Pleuraempyem
	enumeration	0367010	documentation Venenkatheterinfektion
	enumeration	0367011	documentation Harnwegsinfektion
	enumeration	0367012	documentation Wundinfektion untere Extremitäten
	enumeration	0367013	documentation HIV-Infektion
	enumeration	0367014	documentation Hepatitis B oder C
	enumeration	0367015	documentation andere Wundinfektion
	enumeration	0367042	documentation sonstige Infektion
annotation	documentation Kat_AK_Infektion		
source	<pre> &lt;simpleType name="enum_0367"&gt;   &lt;annotation&gt;     &lt;documentation&gt;Kat_AK_Infektion&lt;/documentation&gt;   &lt;/annotation&gt;   &lt;restriction base="xs:string"&gt;     &lt;enumeration value="0367001"&gt;       &lt;annotation&gt;         &lt;documentation&gt;keine&lt;/documentation&gt;       &lt;/annotation&gt;     &lt;/enumeration&gt;     &lt;enumeration value="0367002"&gt; </pre>		

```
<annotation>
  <documentation>Mediastinitis</documentation>
</annotation>
</enumeration>
<enumeration value="0367003">
  <annotation>
    <documentation>Sepsis</documentation>
  </annotation>
</enumeration>
<enumeration value="0367004">
  <annotation>
    <documentation>broncho-pulmonale Infektion</documentation>
  </annotation>
</enumeration>
<enumeration value="0367005">
  <annotation>
    <documentation>oto-laryngologische Infektion</documentation>
  </annotation>
</enumeration>
<enumeration value="0367006">
  <annotation>
    <documentation>floride Endokarditis</documentation>
  </annotation>
</enumeration>
<enumeration value="0367007">
  <annotation>
    <documentation>Peritonitis</documentation>
  </annotation>
</enumeration>
<enumeration value="0367008">
  <annotation>
    <documentation>Wundinfektion Thorax</documentation>
  </annotation>
</enumeration>
<enumeration value="0367009">
  <annotation>
    <documentation>Pleuraempyem</documentation>
  </annotation>
</enumeration>
<enumeration value="0367010">
  <annotation>
    <documentation>Venenkatheterinfektion</documentation>
  </annotation>
</enumeration>
<enumeration value="0367011">
  <annotation>
    <documentation>Harnwegsinfektion</documentation>
  </annotation>
</enumeration>
<enumeration value="0367012">
  <annotation>
    <documentation>Wundinfektion untere Extremitäten</documentation>
  </annotation>
</enumeration>
<enumeration value="0367013">
  <annotation>
    <documentation>HIV-Infektion</documentation>
  </annotation>
</enumeration>
```

	<pre> &lt;enumeration value="0367014"&gt;   &lt;annotation&gt;     &lt;documentation&gt;Hepatitis B oder C&lt;/documentation&gt;   &lt;/annotation&gt; &lt;/enumeration&gt; &lt;enumeration value="0367015"&gt;   &lt;annotation&gt;     &lt;documentation&gt;andere Wundinfektion&lt;/documentation&gt;   &lt;/annotation&gt; &lt;/enumeration&gt; &lt;enumeration value="0367042"&gt;   &lt;annotation&gt;     &lt;documentation&gt;sonstige Infektion&lt;/documentation&gt;   &lt;/annotation&gt; &lt;/enumeration&gt; &lt;/restriction&gt; &lt;/simpleType&gt; </pre>
--	---

### simpleType enum 0368

namespace	http://xml.ir-d.de/irdma		
type	restriction of <b>string</b>		
properties	base xs:string		
facets	Kind	Value	Annotation
	enumeration	0368001	documentation nein
	enumeration	0368002	documentation ja, COPD mit Dauermedikation
	enumeration	0368003	documentation ja, COPD ohne Dauermedikation
	enumeration	0368004	documentation ja, andere Lungenerkrankungen
	enumeration	0368099	documentation unbekannt
annotation	documentation Kat_AK_Lungenerkrankung		
source	<pre> &lt;simpleType name="enum_0368"&gt;   &lt;annotation&gt;     &lt;documentation&gt;Kat_AK_Lungenerkrankung&lt;/documentation&gt;   &lt;/annotation&gt;   &lt;restriction base="xs:string"&gt;     &lt;enumeration value="0368001"&gt;       &lt;annotation&gt;         &lt;documentation&gt;nein&lt;/documentation&gt;       &lt;/annotation&gt;     &lt;/enumeration&gt;     &lt;enumeration value="0368002"&gt;       &lt;annotation&gt;         &lt;documentation&gt;ja, COPD mit Dauermedikation&lt;/documentation&gt;       &lt;/annotation&gt;     &lt;/enumeration&gt;     &lt;enumeration value="0368003"&gt;       &lt;annotation&gt;         &lt;documentation&gt;ja, COPD ohne Dauermedikation&lt;/documentation&gt;       &lt;/annotation&gt;     &lt;/enumeration&gt;     &lt;enumeration value="0368004"&gt; </pre>		

	<pre> &lt;annotation&gt;   &lt;documentation&gt;ja, andere Lungenerkrankungen&lt;/documentation&gt; &lt;/annotation&gt; &lt;/enumeration&gt; &lt;enumeration value="0368099"&gt;   &lt;annotation&gt;     &lt;documentation&gt;unbekannt&lt;/documentation&gt;   &lt;/annotation&gt; &lt;/enumeration&gt; &lt;/restriction&gt; &lt;/simpleType&gt; </pre>
--	---

### simpleType enum\_0369

namespace	http://xml.ir-d.de/irdma		
type	restriction of <b>string</b>		
properties	base xs:string		
facets	Kind	Value	Annotation
	enumeration	0369001	documentation nein
	enumeration	0369002	documentation akut
	enumeration	0369003	documentation chronisch
annotation	documentation Kat_AK_Nierenersatztherapie		
source	<pre> &lt;simpleType name="enum_0369"&gt;   &lt;annotation&gt;     &lt;documentation&gt;Kat_AK_Nierenersatztherapie&lt;/documentation&gt;   &lt;/annotation&gt;   &lt;restriction base="xs:string"&gt;     &lt;enumeration value="0369001"&gt;       &lt;annotation&gt;         &lt;documentation&gt;nein&lt;/documentation&gt;       &lt;/annotation&gt;     &lt;/enumeration&gt;     &lt;enumeration value="0369002"&gt;       &lt;annotation&gt;         &lt;documentation&gt;akut&lt;/documentation&gt;       &lt;/annotation&gt;     &lt;/enumeration&gt;     &lt;enumeration value="0369003"&gt;       &lt;annotation&gt;         &lt;documentation&gt;chronisch&lt;/documentation&gt;       &lt;/annotation&gt;     &lt;/enumeration&gt;   &lt;/restriction&gt; &lt;/simpleType&gt; </pre>		

### simpleType enum\_0370

namespace	http://xml.ir-d.de/irdma		
type	restriction of <b>string</b>		
properties	base xs:string		

facets	<table border="1"> <thead> <tr> <th>Kind</th> <th>Value</th> <th>Annotation</th> </tr> </thead> <tbody> <tr> <td>enumeration</td> <td>0370001</td> <td>documentation Echokardiographie</td> </tr> <tr> <td>enumeration</td> <td>0370002</td> <td>documentation Herzkatheter</td> </tr> <tr> <td>enumeration</td> <td>0370042</td> <td>documentation andere</td> </tr> </tbody> </table>	Kind	Value	Annotation	enumeration	0370001	documentation Echokardiographie	enumeration	0370002	documentation Herzkatheter	enumeration	0370042	documentation andere
Kind	Value	Annotation											
enumeration	0370001	documentation Echokardiographie											
enumeration	0370002	documentation Herzkatheter											
enumeration	0370042	documentation andere											
annotation	documentation Kat_AK_AKOEFMessmethode												
source	<pre>&lt;simpleType name="enum_0370"&gt;   &lt;annotation&gt;     &lt;documentation&gt;Kat_AK_AKOEFMessmethode&lt;/documentation&gt;   &lt;/annotation&gt;   &lt;restriction base="xs:string"&gt;     &lt;enumeration value="0370001"&gt;       &lt;annotation&gt;         &lt;documentation&gt;Echokardiographie&lt;/documentation&gt;       &lt;/annotation&gt;     &lt;/enumeration&gt;     &lt;enumeration value="0370002"&gt;       &lt;annotation&gt;         &lt;documentation&gt;Herzkatheter&lt;/documentation&gt;       &lt;/annotation&gt;     &lt;/enumeration&gt;     &lt;enumeration value="0370042"&gt;       &lt;annotation&gt;         &lt;documentation&gt;andere&lt;/documentation&gt;       &lt;/annotation&gt;     &lt;/enumeration&gt;   &lt;/restriction&gt; &lt;/simpleType&gt;</pre>												

### simpleType enum\_0371

namespace	http://xml.ir-d.de/irdma																		
type	restriction of <b>string</b>																		
properties	base xs:string																		
facets	<table border="1"> <thead> <tr> <th>Kind</th> <th>Value</th> <th>Annotation</th> </tr> </thead> <tbody> <tr> <td>enumeration</td> <td>0371001</td> <td>documentation keine</td> </tr> <tr> <td>enumeration</td> <td>0371002</td> <td>documentation leicht</td> </tr> <tr> <td>enumeration</td> <td>0371003</td> <td>documentation mittel</td> </tr> <tr> <td>enumeration</td> <td>0371004</td> <td>documentation schwer</td> </tr> <tr> <td>enumeration</td> <td>0371099</td> <td>documentation unbekannt</td> </tr> </tbody> </table>	Kind	Value	Annotation	enumeration	0371001	documentation keine	enumeration	0371002	documentation leicht	enumeration	0371003	documentation mittel	enumeration	0371004	documentation schwer	enumeration	0371099	documentation unbekannt
Kind	Value	Annotation																	
enumeration	0371001	documentation keine																	
enumeration	0371002	documentation leicht																	
enumeration	0371003	documentation mittel																	
enumeration	0371004	documentation schwer																	
enumeration	0371099	documentation unbekannt																	
annotation	documentation Kat_AK_Verkalkungsgrad																		
source	<pre>&lt;simpleType name="enum_0371"&gt;   &lt;annotation&gt;     &lt;documentation&gt;Kat_AK_Verkalkungsgrad&lt;/documentation&gt;   &lt;/annotation&gt;   &lt;restriction base="xs:string"&gt;     &lt;enumeration value="0371001"&gt;       &lt;annotation&gt;         &lt;documentation&gt;keine&lt;/documentation&gt;       &lt;/annotation&gt;     &lt;/enumeration&gt;   &lt;/restriction&gt; &lt;/simpleType&gt;</pre>																		

	<pre> &lt;/annotation&gt; &lt;/enumeration&gt; &lt;enumeration value="0371002"&gt;   &lt;annotation&gt;     &lt;documentation&gt;leicht&lt;/documentation&gt;   &lt;/annotation&gt; &lt;/enumeration&gt; &lt;enumeration value="0371003"&gt;   &lt;annotation&gt;     &lt;documentation&gt;mittel&lt;/documentation&gt;   &lt;/annotation&gt; &lt;/enumeration&gt; &lt;enumeration value="0371004"&gt;   &lt;annotation&gt;     &lt;documentation&gt;schwer&lt;/documentation&gt;   &lt;/annotation&gt; &lt;/enumeration&gt; &lt;enumeration value="0371099"&gt;   &lt;annotation&gt;     &lt;documentation&gt;unbekannt&lt;/documentation&gt;   &lt;/annotation&gt; &lt;/enumeration&gt; &lt;/restriction&gt; &lt;/simpleType&gt; </pre>
--	---

### simpleType enum\_0372

namespace	http://xml.ir-d.de/irdma		
type	restriction of <b>string</b>		
properties	base xs:string		
facets	Kind	Value	Annotation
	enumeration	0372001	documentation nein
	enumeration	0372002	documentation ja, bicuspide
	enumeration	0372003	documentation ja, unicuspide
	enumeration	0372099	documentation unbekannt
annotation	documentation Kat_AK_BiUnicuspideKlappe		
source	<pre> &lt;simpleType name="enum_0372"&gt;   &lt;annotation&gt;     &lt;documentation&gt;Kat_AK_BiUnicuspideKlappe&lt;/documentation&gt;   &lt;/annotation&gt;   &lt;restriction base="xs:string"&gt;     &lt;enumeration value="0372001"&gt;       &lt;annotation&gt;         &lt;documentation&gt;nein&lt;/documentation&gt;       &lt;/annotation&gt;     &lt;/enumeration&gt;     &lt;enumeration value="0372002"&gt;       &lt;annotation&gt;         &lt;documentation&gt;ja, bicuspide&lt;/documentation&gt;       &lt;/annotation&gt;     &lt;/enumeration&gt;     &lt;enumeration value="0372003"&gt; </pre>		

	<pre> &lt;annotation&gt;   &lt;documentation&gt;ja, unicuspide&lt;/documentation&gt; &lt;/annotation&gt; &lt;/enumeration&gt; &lt;enumeration value="0372099"&gt;   &lt;annotation&gt;     &lt;documentation&gt;unbekannt&lt;/documentation&gt;   &lt;/annotation&gt; &lt;/enumeration&gt; &lt;/restriction&gt; &lt;/simpleType&gt; </pre>
--	--

### simpleType enum\_0373

namespace	http://xml.ir-d.de/irdma		
type	restriction of <b>string</b>		
properties	base xs:string		
facets	Kind	Value	Annotation
	enumeration	0373001	documentation keine
	enumeration	0373002	documentation leichtgradig
	enumeration	0373003	documentation mittelgradig
	enumeration	0373004	documentation hochgradig
	enumeration	0373099	documentation unbekannt
annotation	documentation Kat_AK_Grad		
source	<pre> &lt;simpleType name="enum_0373"&gt;   &lt;annotation&gt;     &lt;documentation&gt;Kat_AK_Grad&lt;/documentation&gt;   &lt;/annotation&gt;   &lt;restriction base="xs:string"&gt;     &lt;enumeration value="0373001"&gt;       &lt;annotation&gt;         &lt;documentation&gt;keine&lt;/documentation&gt;       &lt;/annotation&gt;     &lt;/enumeration&gt;     &lt;enumeration value="0373002"&gt;       &lt;annotation&gt;         &lt;documentation&gt;leichtgradig&lt;/documentation&gt;       &lt;/annotation&gt;     &lt;/enumeration&gt;     &lt;enumeration value="0373003"&gt;       &lt;annotation&gt;         &lt;documentation&gt;mittelgradig&lt;/documentation&gt;       &lt;/annotation&gt;     &lt;/enumeration&gt;     &lt;enumeration value="0373004"&gt;       &lt;annotation&gt;         &lt;documentation&gt;hochgradig&lt;/documentation&gt;       &lt;/annotation&gt;     &lt;/enumeration&gt;     &lt;enumeration value="0373099"&gt;       &lt;annotation&gt; </pre>		



```

    <documentation>unbekannt</documentation>
  </annotation>
</enumeration>
</restriction>
</simpleType>

```

### simpleType enum\_0374

namespace	http://xml.ir-d.de/irdma		
type	restriction of <b>string</b>		
properties	base xs:string		
facets	Kind	Value	Annotation
	enumeration	0374001	documentation nein
	enumeration	0374002	documentation ja, &lt;= 6 Stunden
	enumeration	0374003	documentation ja, &gt; 6 Stunden bis &lt;= 24 Stunden
	enumeration	0374004	documentation ja, &gt; 1 bis 7 Tage
	enumeration	0374005	documentation ja, &gt; 7 bis 21 Tage
	enumeration	0374006	documentation ja, &gt; 21 Tage
	enumeration	0374099	documentation unbekannt
annotation	documentation Kat_AK_InfarktAnamnese		
source	<pre> &lt;simpleType name="enum_0374"&gt;   &lt;annotation&gt;     &lt;documentation&gt;Kat_AK_InfarktAnamnese&lt;/documentation&gt;   &lt;/annotation&gt;   &lt;restriction base="xs:string"&gt;     &lt;enumeration value="0374001"&gt;       &lt;annotation&gt;         &lt;documentation&gt;nein&lt;/documentation&gt;       &lt;/annotation&gt;     &lt;/enumeration&gt;     &lt;enumeration value="0374002"&gt;       &lt;annotation&gt;         &lt;documentation&gt;ja, &amp;lt;= 6 Stunden&lt;/documentation&gt;       &lt;/annotation&gt;     &lt;/enumeration&gt;     &lt;enumeration value="0374003"&gt;       &lt;annotation&gt;         &lt;documentation&gt;ja, &amp;gt; 6 Stunden bis &amp;lt;= 24 Stunden&lt;/documentation&gt;       &lt;/annotation&gt;     &lt;/enumeration&gt;     &lt;enumeration value="0374004"&gt;       &lt;annotation&gt;         &lt;documentation&gt;ja, &amp;gt; 1 bis 7 Tage&lt;/documentation&gt;       &lt;/annotation&gt;     &lt;/enumeration&gt;     &lt;enumeration value="0374005"&gt;       &lt;annotation&gt;         &lt;documentation&gt;ja, &amp;gt; 7 bis 21 Tage&lt;/documentation&gt;       &lt;/annotation&gt;     &lt;/enumeration&gt;   &lt;/restriction&gt; &lt;/simpleType&gt; </pre>		

	<pre> &lt;/enumeration&gt; &lt;enumeration value="0374006"&gt;   &lt;annotation&gt;     &lt;documentation&gt;ja, &amp;gt; 21 Tage&lt;/documentation&gt;   &lt;/annotation&gt; &lt;/enumeration&gt; &lt;enumeration value="0374099"&gt;   &lt;annotation&gt;     &lt;documentation&gt;unbekannt&lt;/documentation&gt;   &lt;/annotation&gt; &lt;/enumeration&gt; &lt;/restriction&gt; &lt;/simpleType&gt; </pre>
--	---

### simpleType enum\_0375

namespace	http://xml.ir-d.de/irdma		
type	restriction of <b>string</b>		
properties	base xs:string		
facets	Kind	Value	Annotation
	enumeration	0375001	documentation keine Symptome oder Angina
	enumeration	0375002	documentation Symptome, aber keine Ischämiezeichen
	enumeration	0375003	documentation stabile Angina
	enumeration	0375004	documentation instabile Angina
	enumeration	0375005	documentation Infarkt ohne ST-Hebung (Non-STEMI)
	enumeration	0375006	documentation Infarkt mit ST-Hebung (STEMI)
	enumeration	0375042	documentation unbekannt
annotation	documentation Kat_AK_KardialeSymptome		
source	<pre> &lt;simpleType name="enum_0375"&gt;   &lt;annotation&gt;     &lt;documentation&gt;Kat_AK_KardialeSymptome&lt;/documentation&gt;   &lt;/annotation&gt;   &lt;restriction base="xs:string"&gt;     &lt;enumeration value="0375001"&gt;       &lt;annotation&gt;         &lt;documentation&gt;keine Symptome oder Angina&lt;/documentation&gt;       &lt;/annotation&gt;     &lt;/enumeration&gt;     &lt;enumeration value="0375002"&gt;       &lt;annotation&gt;         &lt;documentation&gt;Symptome, aber keine Ischämiezeichen&lt;/documentation&gt;       &lt;/annotation&gt;     &lt;/enumeration&gt;     &lt;enumeration value="0375003"&gt;       &lt;annotation&gt;         &lt;documentation&gt;stabile Angina&lt;/documentation&gt;       &lt;/annotation&gt;     &lt;/enumeration&gt;     &lt;enumeration value="0375004"&gt; </pre>		

	<pre> &lt;annotation&gt;   &lt;documentation&gt;instabile Angina&lt;/documentation&gt; &lt;/annotation&gt; &lt;/enumeration&gt; &lt;enumeration value="0375005"&gt;   &lt;annotation&gt;     &lt;documentation&gt;Infarkt ohne ST-Hebung (Non-STEMI)&lt;/documentation&gt;   &lt;/annotation&gt; &lt;/enumeration&gt; &lt;enumeration value="0375006"&gt;   &lt;annotation&gt;     &lt;documentation&gt;Infarkt mit ST-Hebung (STEMI)&lt;/documentation&gt;   &lt;/annotation&gt; &lt;/enumeration&gt; &lt;enumeration value="0375042"&gt;   &lt;annotation&gt;     &lt;documentation&gt;unbekannt&lt;/documentation&gt;   &lt;/annotation&gt; &lt;/enumeration&gt; &lt;/restriction&gt; &lt;/simpleType&gt; </pre>
--	---

### simpleType enum 0376

namespace	http://xml.ir-d.de/irdma		
type	restriction of <b>string</b>		
properties	base xs:string		
facets	Kind	Value	Annotation
	enumeration	0376001	documentation nein
	enumeration	0376002	documentation ja, ZNS, zerebrovaskuläre Blutung
	enumeration	0376003	documentation ja, ZNS, zerebrovaskuläre Ischämie
	enumeration	0376042	documentation ja, ZNS, andere
annotation	documentation Kat_AK_Schlaganfall		
source	<pre> &lt;simpleType name="enum_0376"&gt;   &lt;annotation&gt;     &lt;documentation&gt;Kat_AK_Schlaganfall&lt;/documentation&gt;   &lt;/annotation&gt;   &lt;restriction base="xs:string"&gt;     &lt;enumeration value="0376001"&gt;       &lt;annotation&gt;         &lt;documentation&gt;nein&lt;/documentation&gt;       &lt;/annotation&gt;     &lt;/enumeration&gt;     &lt;enumeration value="0376002"&gt;       &lt;annotation&gt;         &lt;documentation&gt;ja, ZNS, zerebrovaskuläre Blutung&lt;/documentation&gt;       &lt;/annotation&gt;     &lt;/enumeration&gt;     &lt;enumeration value="0376003"&gt;       &lt;annotation&gt;         &lt;documentation&gt;ja, ZNS, zerebrovaskuläre Ischämie&lt;/documentation&gt;       &lt;/annotation&gt;     &lt;/enumeration&gt;   &lt;/restriction&gt; &lt;/simpleType&gt; </pre>		

	<pre> &lt;/enumeration&gt; &lt;enumeration value="0376042"&gt;   &lt;annotation&gt;     &lt;documentation&gt;ja, ZNS, andere&lt;/documentation&gt;   &lt;/annotation&gt; &lt;/enumeration&gt; &lt;/restriction&gt; &lt;/simpleType&gt; </pre>
--	---

### simpleType enum\_0377

namespace	http://xml.ir-d.de/irdma		
type	restriction of <b>string</b>		
properties	base xs:string		
facets	Kind	Value	Annotation
	enumeration	0377001	documentation ja, mild neurological dysfunction: NIHSS 0-5
	enumeration	0377002	documentation ja, moderate neurological dysfunction: NIHSS 6-14
	enumeration	0377003	documentation ja, severe neurological dysfunction: NIHSS &gt;=15
annotation	documentation Kat_AK_Nihss		
source	<pre> &lt;simpleType name="enum_0377"&gt;   &lt;annotation&gt;     &lt;documentation&gt;Kat_AK_Nihss&lt;/documentation&gt;   &lt;/annotation&gt;   &lt;restriction base="xs:string"&gt;     &lt;enumeration value="0377001"&gt;       &lt;annotation&gt;         &lt;documentation&gt;ja, mild neurological dysfunction: NIHSS 0-5&lt;/documentation&gt;       &lt;/annotation&gt;     &lt;/enumeration&gt;     &lt;enumeration value="0377002"&gt;       &lt;annotation&gt;         &lt;documentation&gt;ja, moderate neurological dysfunction: NIHSS 6-14&lt;/documentation&gt;       &lt;/annotation&gt;     &lt;/enumeration&gt;     &lt;enumeration value="0377003"&gt;       &lt;annotation&gt;         &lt;documentation&gt; ja, severe neurological dysfunction: NIHSS &amp;gt;=15&lt;/documentation&gt;       &lt;/annotation&gt;     &lt;/enumeration&gt;   &lt;/restriction&gt; &lt;/simpleType&gt; </pre>		

### simpleType enum\_0378

namespace	http://xml.ir-d.de/irdma		
type	restriction of <b>string</b>		
properties	base xs:string		

facets	<table border="1"> <thead> <tr> <th>Kind</th> <th>Value</th> <th>Annotation</th> </tr> </thead> <tbody> <tr> <td>enumeration</td> <td>0378001</td> <td>documentation nein</td> </tr> <tr> <td>enumeration</td> <td>0378002</td> <td>documentation ja, &amp;lt; 48h gemäss VARC-3-Definition</td> </tr> <tr> <td>enumeration</td> <td>0378003</td> <td>documentation ja, &amp;gt;= 48h - &amp;lt;= 72h gemäß VARC-3-Definition</td> </tr> <tr> <td>enumeration</td> <td>0378004</td> <td>documentation ja, &amp;gt; 72 h gemäß VARC-3 Definition</td> </tr> </tbody> </table>	Kind	Value	Annotation	enumeration	0378001	documentation nein	enumeration	0378002	documentation ja, &lt; 48h gemäss VARC-3-Definition	enumeration	0378003	documentation ja, &gt;= 48h - &lt;= 72h gemäß VARC-3-Definition	enumeration	0378004	documentation ja, &gt; 72 h gemäß VARC-3 Definition
Kind	Value	Annotation														
enumeration	0378001	documentation nein														
enumeration	0378002	documentation ja, &lt; 48h gemäss VARC-3-Definition														
enumeration	0378003	documentation ja, &gt;= 48h - &lt;= 72h gemäß VARC-3-Definition														
enumeration	0378004	documentation ja, &gt; 72 h gemäß VARC-3 Definition														
annotation	documentation Kat_AK_Myokardinfarkt															
source	<pre> &lt;simpleType name="enum_0378"&gt;   &lt;annotation&gt;     &lt;documentation&gt;Kat_AK_Myokardinfarkt&lt;/documentation&gt;   &lt;/annotation&gt;   &lt;restriction base="xs:string"&gt;     &lt;enumeration value="0378001"&gt;       &lt;annotation&gt;         &lt;documentation&gt;nein&lt;/documentation&gt;       &lt;/annotation&gt;     &lt;/enumeration&gt;     &lt;enumeration value="0378002"&gt;       &lt;annotation&gt;         &lt;documentation&gt;ja, &amp;lt; 48h gemäss VARC-3-Definition&lt;/documentation&gt;       &lt;/annotation&gt;     &lt;/enumeration&gt;     &lt;enumeration value="0378003"&gt;       &lt;annotation&gt;         &lt;documentation&gt;ja, &amp;gt;= 48h - &amp;lt;= 72h gemäß VARC-3-Definition&lt;/documentation&gt;       &lt;/annotation&gt;     &lt;/enumeration&gt;     &lt;enumeration value="0378004"&gt;       &lt;annotation&gt;         &lt;documentation&gt;ja, &amp;gt; 72 h gemäß VARC-3 Definition&lt;/documentation&gt;       &lt;/annotation&gt;     &lt;/enumeration&gt;   &lt;/restriction&gt; &lt;/simpleType&gt; </pre>															

### simpleType enum\_0379

namespace	http://xml.ir-d.de/irdma															
type	restriction of <b>string</b>															
properties	base xs:string															
facets	<table border="1"> <thead> <tr> <th>Kind</th> <th>Value</th> <th>Annotation</th> </tr> </thead> <tbody> <tr> <td>enumeration</td> <td>0379001</td> <td>documentation Keine gefäss- oder zugangsassoziierte Komplikationen</td> </tr> <tr> <td>enumeration</td> <td>0379002</td> <td>documentation Versagen des perkutanen Verschlusssystems</td> </tr> <tr> <td>enumeration</td> <td>0379003</td> <td>documentation Geringfügige Gefäßkomplkationen</td> </tr> <tr> <td>enumeration</td> <td>0379004</td> <td>documentation Erhebliche Gefäßkomplkationen</td> </tr> </tbody> </table>	Kind	Value	Annotation	enumeration	0379001	documentation Keine gefäss- oder zugangsassoziierte Komplikationen	enumeration	0379002	documentation Versagen des perkutanen Verschlusssystems	enumeration	0379003	documentation Geringfügige Gefäßkomplkationen	enumeration	0379004	documentation Erhebliche Gefäßkomplkationen
Kind	Value	Annotation														
enumeration	0379001	documentation Keine gefäss- oder zugangsassoziierte Komplikationen														
enumeration	0379002	documentation Versagen des perkutanen Verschlusssystems														
enumeration	0379003	documentation Geringfügige Gefäßkomplkationen														
enumeration	0379004	documentation Erhebliche Gefäßkomplkationen														
annotation	documentation Kat_AK_ZugangKomplikationen															
source	<pre> &lt;simpleType name="enum_0379"&gt;   &lt;annotation&gt; </pre>															

	<pre> &lt;documentation&gt;Kat_AK_ZugangKomplikationen&lt;/documentation&gt; &lt;/annotation&gt; &lt;restriction base="xs:string"&gt;   &lt;enumeration value="0379001"&gt;     &lt;annotation&gt;       &lt;documentation&gt;Keine gefäss- oder zugangsassozierte Komplikationen&lt;/documentation&gt;     &lt;/annotation&gt;   &lt;/enumeration&gt;   &lt;enumeration value="0379002"&gt;     &lt;annotation&gt;       &lt;documentation&gt;Versagen des perkutanen Verschlussystems&lt;/documentation&gt;     &lt;/annotation&gt;   &lt;/enumeration&gt;   &lt;enumeration value="0379003"&gt;     &lt;annotation&gt;       &lt;documentation&gt;Geringfügige Gefäßkomplikationen&lt;/documentation&gt;     &lt;/annotation&gt;   &lt;/enumeration&gt;   &lt;enumeration value="0379004"&gt;     &lt;annotation&gt;       &lt;documentation&gt;Erhebliche Gefäßkomplikationen&lt;/documentation&gt;     &lt;/annotation&gt;   &lt;/enumeration&gt; &lt;/restriction&gt; &lt;/simpleType&gt; </pre>
--	--

### simpleType enum\_0380

namespace	http://xml.ir-d.de/irdma		
type	restriction of <b>string</b>		
properties	base xs:string		
facets	Kind	Value	Annotation
	enumeration	0380001	documentation nein
	enumeration	0380002	documentation ja, intraprozedural
	enumeration	0380003	documentation ja, postprozedural
	enumeration	0380004	documentation ja, Zeitpunkt nicht bekannt
annotation	documentation Kat_AK_Reanimation		
source	<pre> &lt;simpleType name="enum_0380"&gt;   &lt;annotation&gt;     &lt;documentation&gt;Kat_AK_Reanimation&lt;/documentation&gt;   &lt;/annotation&gt;   &lt;restriction base="xs:string"&gt;     &lt;enumeration value="0380001"&gt;       &lt;annotation&gt;         &lt;documentation&gt;nein&lt;/documentation&gt;       &lt;/annotation&gt;     &lt;/enumeration&gt;     &lt;enumeration value="0380002"&gt;       &lt;annotation&gt;         &lt;documentation&gt;ja, intraprozedural&lt;/documentation&gt;       &lt;/annotation&gt;     &lt;/enumeration&gt;   &lt;/restriction&gt; &lt;/simpleType&gt; </pre>		

	<pre> &lt;/annotation&gt; &lt;/enumeration&gt; &lt;enumeration value="0380003"&gt;   &lt;annotation&gt;     &lt;documentation&gt;ja, postprozedural&lt;/documentation&gt;   &lt;/annotation&gt; &lt;/enumeration&gt; &lt;enumeration value="0380004"&gt;   &lt;annotation&gt;     &lt;documentation&gt;ja, Zeitpunkt nicht bekannt&lt;/documentation&gt;   &lt;/annotation&gt; &lt;/enumeration&gt; &lt;/restriction&gt; &lt;/simpleType&gt; </pre>
--	---

### simpleType enum\_0381

namespace	http://xml.lir-d.de/irdma		
type	restriction of <b>string</b>		
properties	base xs:string		
facets	Kind	Value	Annotation
	enumeration	0381001	documentation nein
	enumeration	0381002	documentation Thorakotomie/Rethorakotomie
	enumeration	0381003	documentation kathetergestützte Reintervention
	enumeration	0381004	documentation lokale Reinterventionen
	enumeration	0381005	documentation andere Reintervention
annotation	documentation Kat_AK_Massnahmen		
source	<pre> &lt;simpleType name="enum_0381"&gt;   &lt;annotation&gt;     &lt;documentation&gt;Kat_AK_Massnahmen&lt;/documentation&gt;   &lt;/annotation&gt;   &lt;restriction base="xs:string"&gt;     &lt;enumeration value="0381001"&gt;       &lt;annotation&gt;         &lt;documentation&gt;nein&lt;/documentation&gt;       &lt;/annotation&gt;     &lt;/enumeration&gt;     &lt;enumeration value="0381002"&gt;       &lt;annotation&gt;         &lt;documentation&gt;Thorakotomie/Rethorakotomie&lt;/documentation&gt;       &lt;/annotation&gt;     &lt;/enumeration&gt;     &lt;enumeration value="0381003"&gt;       &lt;annotation&gt;         &lt;documentation&gt;kathetergestützte Reintervention&lt;/documentation&gt;       &lt;/annotation&gt;     &lt;/enumeration&gt;     &lt;enumeration value="0381004"&gt;       &lt;annotation&gt;         &lt;documentation&gt;lokale Reinterventionen&lt;/documentation&gt;       &lt;/annotation&gt;     &lt;/enumeration&gt;   &lt;/restriction&gt; &lt;/simpleType&gt; </pre>		

	<pre> &lt;/enumeration&gt; &lt;enumeration value="0381005"&gt;   &lt;annotation&gt;     &lt;documentation&gt;andere Reintervention&lt;/documentation&gt;   &lt;/annotation&gt; &lt;/enumeration&gt; &lt;/restriction&gt; &lt;/simpleType&gt; </pre>
--	---

### simpleType enum\_0382

namespace	http://xml.ir-d.de/irdma		
type	restriction of <b>string</b>		
properties	base xs:string		
facets	Kind	Value	Annotation
	enumeration	0382001	documentation keine Rethorakotomie / kein weiterer Grund
	enumeration	0382002	documentation Blutung/Hämatom
	enumeration	0382003	documentation Low Cardiac Output
	enumeration	0382004	documentation Tamponade
	enumeration	0382005	documentation Graftprobleme, Ischämie
	enumeration	0382006	documentation Wundinfektion, Mediastinitis
	enumeration	0382007	documentation Dissektion
	enumeration	0382008	documentation Prothesendysfunktion
	enumeration	0382009	documentation instabiles Sternum
	enumeration	0382010	documentation Chylothorax
	enumeration	0382011	documentation lokale Revision im Bereich des Zugangsweges
	enumeration	0382042	documentation anderer Grund
annotation	documentation Kat_AK_Komplikation		
source	<pre> &lt;simpleType name="enum_0382"&gt;   &lt;annotation&gt;     &lt;documentation&gt;Kat_AK_Komplikation&lt;/documentation&gt;   &lt;/annotation&gt;   &lt;restriction base="xs:string"&gt;     &lt;enumeration value="0382001"&gt;       &lt;annotation&gt;         &lt;documentation&gt;keine Rethorakotomie / kein weiterer Grund&lt;/documentation&gt;       &lt;/annotation&gt;     &lt;/enumeration&gt;     &lt;enumeration value="0382002"&gt;       &lt;annotation&gt;         &lt;documentation&gt;Blutung/Hämatom&lt;/documentation&gt;       &lt;/annotation&gt;     &lt;/enumeration&gt;     &lt;enumeration value="0382003"&gt; </pre>		



```

    <annotation>
      <documentation>Low Cardiac Output</documentation>
    </annotation>
  </enumeration>
  <enumeration value="0382004">
    <annotation>
      <documentation>Tamponade</documentation>
    </annotation>
  </enumeration>
  <enumeration value="0382005">
    <annotation>
      <documentation>Graftprobleme, Ischämie</documentation>
    </annotation>
  </enumeration>
  <enumeration value="0382006">
    <annotation>
      <documentation>Wundinfektion, Mediastinitis</documentation>
    </annotation>
  </enumeration>
  <enumeration value="0382007">
    <annotation>
      <documentation>Dissektion</documentation>
    </annotation>
  </enumeration>
  <enumeration value="0382008">
    <annotation>
      <documentation>Prothesendysfunktion</documentation>
    </annotation>
  </enumeration>
  <enumeration value="0382009">
    <annotation>
      <documentation>instabiles Sternum</documentation>
    </annotation>
  </enumeration>
  <enumeration value="0382010">
    <annotation>
      <documentation>Chylothorax</documentation>
    </annotation>
  </enumeration>
  <enumeration value="0382011">
    <annotation>
      <documentation>lokale Revision im Bereich des
Zugangsweges</documentation>
    </annotation>
  </enumeration>
  <enumeration value="0382042">
    <annotation>
      <documentation>anderer Grund</documentation>
    </annotation>
  </enumeration>
</restriction>
</simpleType>

```

### simpleType enum\_0383

namespace	http://xml.ir-d.de/irdma
type	restriction of <b>string</b>

properties	base xs:string															
facets	<table border="1"> <thead> <tr> <th>Kind</th> <th>Value</th> <th>Annotation</th> </tr> </thead> <tbody> <tr> <td>enumeration</td> <td>0383001</td> <td>documentation nein</td> </tr> <tr> <td>enumeration</td> <td>0383002</td> <td>documentation ja, mit forcierter Atemtherapie</td> </tr> <tr> <td>enumeration</td> <td>0383003</td> <td>documentation ja, Reintubation oder längerfristige Beatmung</td> </tr> <tr> <td>enumeration</td> <td>0383004</td> <td>documentation ja, Tracheotomie</td> </tr> </tbody> </table>	Kind	Value	Annotation	enumeration	0383001	documentation nein	enumeration	0383002	documentation ja, mit forcierter Atemtherapie	enumeration	0383003	documentation ja, Reintubation oder längerfristige Beatmung	enumeration	0383004	documentation ja, Tracheotomie
Kind	Value	Annotation														
enumeration	0383001	documentation nein														
enumeration	0383002	documentation ja, mit forcierter Atemtherapie														
enumeration	0383003	documentation ja, Reintubation oder längerfristige Beatmung														
enumeration	0383004	documentation ja, Tracheotomie														
annotation	documentation Kat_AK_RespiratorischeInsuffizienz															
source	<pre> &lt;simpleType name="enum_0383"&gt;   &lt;annotation&gt;     &lt;documentation&gt;Kat_AK_RespiratorischeInsuffizienz&lt;/documentation&gt;   &lt;/annotation&gt;   &lt;restriction base="xs:string"&gt;     &lt;enumeration value="0383001"&gt;       &lt;annotation&gt;         &lt;documentation&gt;nein&lt;/documentation&gt;       &lt;/annotation&gt;     &lt;/enumeration&gt;     &lt;enumeration value="0383002"&gt;       &lt;annotation&gt;         &lt;documentation&gt;ja, mit forcierter Atemtherapie&lt;/documentation&gt;       &lt;/annotation&gt;     &lt;/enumeration&gt;     &lt;enumeration value="0383003"&gt;       &lt;annotation&gt;         &lt;documentation&gt;ja, Reintubation oder längerfristige Beatmung&lt;/documentation&gt;       &lt;/annotation&gt;     &lt;/enumeration&gt;     &lt;enumeration value="0383004"&gt;       &lt;annotation&gt;         &lt;documentation&gt;ja, Tracheotomie&lt;/documentation&gt;       &lt;/annotation&gt;     &lt;/enumeration&gt;   &lt;/restriction&gt; &lt;/simpleType&gt; </pre>															

### simpleType enum\_0384

namespace	http://xml.ir-d.de/irdma															
type	restriction of <b>string</b>															
properties	base xs:string															
facets	<table border="1"> <thead> <tr> <th>Kind</th> <th>Value</th> <th>Annotation</th> </tr> </thead> <tbody> <tr> <td>enumeration</td> <td>0384001</td> <td>documentation keine Blutungskomplikationen</td> </tr> <tr> <td>enumeration</td> <td>0384002</td> <td>documentation Geringfügige Blutung (Minor Bleeding - BARC type 2 or 3a)</td> </tr> <tr> <td>enumeration</td> <td>0384003</td> <td>documentation Starke Blutung (Major Bleeding - BARC type 3a)</td> </tr> <tr> <td>enumeration</td> <td>0384004</td> <td>documentation Lebensbedrohliche Blutung (Life-threatening or disabling bleeding - BARC type 3b or 3c or type 5)</td> </tr> </tbody> </table>	Kind	Value	Annotation	enumeration	0384001	documentation keine Blutungskomplikationen	enumeration	0384002	documentation Geringfügige Blutung (Minor Bleeding - BARC type 2 or 3a)	enumeration	0384003	documentation Starke Blutung (Major Bleeding - BARC type 3a)	enumeration	0384004	documentation Lebensbedrohliche Blutung (Life-threatening or disabling bleeding - BARC type 3b or 3c or type 5)
Kind	Value	Annotation														
enumeration	0384001	documentation keine Blutungskomplikationen														
enumeration	0384002	documentation Geringfügige Blutung (Minor Bleeding - BARC type 2 or 3a)														
enumeration	0384003	documentation Starke Blutung (Major Bleeding - BARC type 3a)														
enumeration	0384004	documentation Lebensbedrohliche Blutung (Life-threatening or disabling bleeding - BARC type 3b or 3c or type 5)														
annotation	documentation															

	Kat_AK_Blutungskomplikation
source	<pre> &lt;simpleType name="enum_0384"&gt;   &lt;annotation&gt;     &lt;documentation&gt;Kat_AK_Blutungskomplikation&lt;/documentation&gt;   &lt;/annotation&gt;   &lt;restriction base="xs:string"&gt;     &lt;enumeration value="0384001"&gt;       &lt;annotation&gt;         &lt;documentation&gt;keine Blutungskomplikationen&lt;/documentation&gt;       &lt;/annotation&gt;     &lt;/enumeration&gt;     &lt;enumeration value="0384002"&gt;       &lt;annotation&gt;         &lt;documentation&gt;Geringfügige Blutung (Minor Bleeding - BARC type 2 or 3a)&lt;/documentation&gt;       &lt;/annotation&gt;     &lt;/enumeration&gt;     &lt;enumeration value="0384003"&gt;       &lt;annotation&gt;         &lt;documentation&gt;Starke Blutung (Major Bleeding - BARC type 3a)&lt;/documentation&gt;       &lt;/annotation&gt;     &lt;/enumeration&gt;     &lt;enumeration value="0384004"&gt;       &lt;annotation&gt;         &lt;documentation&gt;Lebensbedrohliche Blutung (Life-threatening or disabling bleeding - BARC type 3b or 3c or type 5)&lt;/documentation&gt;       &lt;/annotation&gt;     &lt;/enumeration&gt;   &lt;/restriction&gt; &lt;/simpleType&gt; </pre>

### simpleType enum\_0385

namespace	http://xml.ir-d.de/irdma		
type	restriction of <b>string</b>		
properties	base xs:string		
facets	Kind	Value	Annotation
	enumeration	0385001	documentation Sinusrhythmus
	enumeration	0385002	documentation Vorhofflimmern
	enumeration	0385003	documentation Patient verstorben (kein Herzrhythmus)
	enumeration	0385042	documentation anderer Rhythmus
annotation	documentation Kat_AK_HerzrhythmusEntlassung		
source	<pre> &lt;simpleType name="enum_0385"&gt;   &lt;annotation&gt;     &lt;documentation&gt;Kat_AK_HerzrhythmusEntlassung&lt;/documentation&gt;   &lt;/annotation&gt;   &lt;restriction base="xs:string"&gt;     &lt;enumeration value="0385001"&gt;       &lt;annotation&gt;         &lt;documentation&gt;Sinusrhythmus&lt;/documentation&gt;       &lt;/annotation&gt; </pre>		

```

</enumeration>
<enumeration value="0385002">
  <annotation>
    <documentation>Vorhofflimmern</documentation>
  </annotation>
</enumeration>
<enumeration value="0385003">
  <annotation>
    <documentation>Patient verstorben (kein Herzrhythmus)</documentation>
  </annotation>
</enumeration>
<enumeration value="0385042">
  <annotation>
    <documentation>anderer Rhythmus</documentation>
  </annotation>
</enumeration>
</restriction>
</simpleType>

```

simpleType **enum\_0388**

namespace	http://xml.ir-d.de/irdma		
type	restriction of <b>string</b>		
properties	base xs:string		
facets	Kind	Value	Annotation
	enumeration	0388001	documentation nein
	enumeration	0388002	documentation ASS
	enumeration	0388003	documentation ADP-Rezeptor-Antagonist
	enumeration	0388004	documentation Kombination ASS und ADP-Rezeptor-Antagonist
	enumeration	0388042	documentation ja, andere
	enumeration	0388099	documentation unbekannt
annotation	documentation Kat AK Plaettchenaggregationshemmer		
source	<pre> &lt;simpleType name="enum_0388"&gt;   &lt;annotation&gt;     &lt;documentation&gt;Kat_AK_Plaettchenaggregationshemmer&lt;/documentation&gt;   &lt;/annotation&gt;   &lt;restriction base="xs:string"&gt;     &lt;enumeration value="0388001"&gt;       &lt;annotation&gt;         &lt;documentation&gt;nein&lt;/documentation&gt;       &lt;/annotation&gt;     &lt;/enumeration&gt;     &lt;enumeration value="0388002"&gt;       &lt;annotation&gt;         &lt;documentation&gt;ASS&lt;/documentation&gt;       &lt;/annotation&gt;     &lt;/enumeration&gt;     &lt;enumeration value="0388003"&gt;       &lt;annotation&gt;         &lt;documentation&gt;ADP-Rezeptor-Antagonist&lt;/documentation&gt;       &lt;/annotation&gt;     &lt;/enumeration&gt;   &lt;/restriction&gt; </pre>		

	<pre> &lt;/annotation&gt; &lt;/enumeration&gt; &lt;enumeration value="0388004"&gt;   &lt;annotation&gt;     &lt;documentation&gt;Kombination ASS und ADP-Rezeptor-Antagonist&lt;/documentation&gt;   &lt;/annotation&gt; &lt;/enumeration&gt; &lt;enumeration value="0388042"&gt;   &lt;annotation&gt;     &lt;documentation&gt;ja, andere&lt;/documentation&gt;   &lt;/annotation&gt; &lt;/enumeration&gt; &lt;enumeration value="0388099"&gt;   &lt;annotation&gt;     &lt;documentation&gt;unbekannt&lt;/documentation&gt;   &lt;/annotation&gt; &lt;/enumeration&gt; &lt;/restriction&gt; &lt;/simpleType&gt; </pre>
--	--

### simpleType enum\_0389

namespace	http://xml.ir-d.de/irdma		
type	restriction of <b>string</b>		
properties	base xs:string		
facets	Kind	Value	Annotation
	enumeration	0389001	documentation nein
	enumeration	0389002	documentation Cumarin-Derivate
	enumeration	0389003	documentation Heparinoide
	enumeration	0389004	documentation orale Thrombinantagonisten
	enumeration	0389005	documentation Kombination Heparinoide und Cumarin-Derivate
	enumeration	0389006	documentation Direkte orale Antikoagulantien (DOAK / NOAK)
	enumeration	0389042	documentation ja, andere
	enumeration	0389099	documentation unbekannt
annotation	documentation Kat_AK_Antikoagulantien		
source	<pre> &lt;simpleType name="enum_0389"&gt;   &lt;annotation&gt;     &lt;documentation&gt;Kat_AK_Antikoagulantien&lt;/documentation&gt;   &lt;/annotation&gt;   &lt;restriction base="xs:string"&gt;     &lt;enumeration value="0389001"&gt;       &lt;annotation&gt;         &lt;documentation&gt;nein&lt;/documentation&gt;       &lt;/annotation&gt;     &lt;/enumeration&gt;     &lt;enumeration value="0389002"&gt;       &lt;annotation&gt;         &lt;documentation&gt;Cumarin-Derivate&lt;/documentation&gt; </pre>		

```

</annotation>
</enumeration>
<enumeration value="0389003">
  <annotation>
    <documentation>Heparinoide</documentation>
  </annotation>
</enumeration>
<enumeration value="0389004">
  <annotation>
    <documentation>orale Thrombinantagonisten</documentation>
  </annotation>
</enumeration>
<enumeration value="0389005">
  <annotation>
    <documentation>Kombination Heparinoide und
Cumarin-Derivate</documentation>
  </annotation>
</enumeration>
<enumeration value="0389006">
  <annotation>
    <documentation>Direkte orale Antikoagulantien (DOAK /
NOAK)</documentation>
  </annotation>
</enumeration>
<enumeration value="0389042">
  <annotation>
    <documentation>ja, andere</documentation>
  </annotation>
</enumeration>
<enumeration value="0389099">
  <annotation>
    <documentation>unbekannt</documentation>
  </annotation>
</enumeration>
</restriction>
</simpleType>

```

**simpleType enum 0390**

namespace	http://xml.ir-d.de/irdma		
type	restriction of <b>string</b>		
properties	base xs:string		
facets	Kind	Value	Annotation
	enumeration	0390001	documentation biologisches Klappenmodell
	enumeration	0390002	documentation mechanisches Klappenmodell
annotation	documentation Kat_AK_Artikeltyp		
source	<simpleType name="enum_0390">   <annotation>     <documentation>Kat_AK_Artikeltyp</documentation>   </annotation>   <restriction base="xs:string">     <enumeration value="0390001">       <annotation>         <documentation>biologisches Klappenmodell</documentation>       </annotation>     </enumeration>   </restriction> </simpleType>		

	<pre> &lt;/annotation&gt; &lt;/enumeration&gt; &lt;enumeration value="0390002"&gt;   &lt;annotation&gt;     &lt;documentation&gt;mechanisches Klappenmodell&lt;/documentation&gt;   &lt;/annotation&gt; &lt;/enumeration&gt; &lt;/restriction&gt; &lt;/simpleType&gt; </pre>
--	--

### simpleType enum\_0398

namespace	http://xml.ir-d.de/irdma		
type	restriction of <b>string</b>		
properties	base xs:string		
facets	Kind	Value	Annotation
	enumeration	0398001	documentation kardiovaskuläre Ursache
	enumeration	0398002	documentation nicht-kardiovaskuläre Ursache
	enumeration	0398099	documentation Todesursache unbekannt
annotation	documentation Kat AK Todesursache		
source	<pre> &lt;simpleType name="enum_0398"&gt;   &lt;annotation&gt;     &lt;documentation&gt;Kat_AK_Todesursache&lt;/documentation&gt;   &lt;/annotation&gt;   &lt;restriction base="xs:string"&gt;     &lt;enumeration value="0398001"&gt;       &lt;annotation&gt;         &lt;documentation&gt;kardiovaskuläre Ursache&lt;/documentation&gt;       &lt;/annotation&gt;     &lt;/enumeration&gt;     &lt;enumeration value="0398002"&gt;       &lt;annotation&gt;         &lt;documentation&gt;nicht-kardiovaskuläre Ursache&lt;/documentation&gt;       &lt;/annotation&gt;     &lt;/enumeration&gt;     &lt;enumeration value="0398099"&gt;       &lt;annotation&gt;         &lt;documentation&gt;Todesursache unbekannt&lt;/documentation&gt;       &lt;/annotation&gt;     &lt;/enumeration&gt;   &lt;/restriction&gt; &lt;/simpleType&gt; </pre>		

### simpleType enum\_0399

namespace	http://xml.ir-d.de/irdma		
type	restriction of <b>string</b>		
properties	base xs:string		
facets	Kind	Value	Annotation
	enumeration	0399001	documentation

	enumeration 0399002 documentation Patient lebt Patient im Krankenhaus verstorben
annotation	documentation Kat_AK_Vitalstatus
source	<pre> &lt;simpleType name="enum_0399"&gt;   &lt;annotation&gt;     &lt;documentation&gt;Kat_AK_Vitalstatus&lt;/documentation&gt;   &lt;/annotation&gt;   &lt;restriction base="xs:string"&gt;     &lt;enumeration value="0399001"&gt;       &lt;annotation&gt;         &lt;documentation&gt;Patient lebt&lt;/documentation&gt;       &lt;/annotation&gt;     &lt;/enumeration&gt;     &lt;enumeration value="0399002"&gt;       &lt;annotation&gt;         &lt;documentation&gt;Patient im Krankenhaus verstorben&lt;/documentation&gt;       &lt;/annotation&gt;     &lt;/enumeration&gt;   &lt;/restriction&gt; &lt;/simpleType&gt; </pre>

#### simpleType enum\_0044

namespace	http://xml.ir-d.de/irdsa		
type	restriction of <b>string</b>		
properties	base xs:string		
facets	Kind	Value	Annotation
	enumeration	0044001	documentation 1= normaler, sonst gesunder Patient
	enumeration	0044002	documentation 2= Patient mit leichter Allgemeinerkrankung
	enumeration	0044003	documentation 3= Patient mit schwerer Allgemeinerkrankung
	enumeration	0044004	documentation 4= Patient mit schwerer Allgemeinerkrankung, die eine ständige Lebensbedrohung darstellt
	enumeration	0044005	documentation 5= moribunder Patient, der ohne die Operation voraussichtlich nicht überleben wird
annotation	documentation Kat ASA		
source	<pre> &lt;simpleType name="enum_0044"&gt;   &lt;annotation&gt;     &lt;documentation&gt;Kat_ASA&lt;/documentation&gt;   &lt;/annotation&gt;   &lt;restriction base="xs:string"&gt;     &lt;enumeration value="0044001"&gt;       &lt;annotation&gt;         &lt;documentation&gt;1= normaler, sonst gesunder Patient&lt;/documentation&gt;       &lt;/annotation&gt;     &lt;/enumeration&gt;     &lt;enumeration value="0044002"&gt;       &lt;annotation&gt;         &lt;documentation&gt;2= Patient mit leichter Allgemeinerkrankung&lt;/documentation&gt;       &lt;/annotation&gt; </pre>		



	<pre> &lt;/enumeration&gt; &lt;enumeration value="0044003"&gt;   &lt;annotation&gt;     &lt;documentation&gt;3= Patient mit schwerer Allgemeinerkrankung&lt;/documentation&gt;   &lt;/annotation&gt; &lt;/enumeration&gt; &lt;enumeration value="0044004"&gt;   &lt;annotation&gt;     &lt;documentation&gt;4= Patient mit schwerer Allgemeinerkrankung, die eine ständige Lebensbedrohung darstellt&lt;/documentation&gt;   &lt;/annotation&gt; &lt;/enumeration&gt; &lt;enumeration value="0044005"&gt;   &lt;annotation&gt;     &lt;documentation&gt;5= moribunder Patient, der ohne die Operation voraussichtlich nicht überleben wird&lt;/documentation&gt;   &lt;/annotation&gt; &lt;/enumeration&gt; &lt;/restriction&gt; &lt;/simpleType&gt; </pre>
--	---

#### simpleType enum\_0050

namespace	http://xml.ir-d.de/irdsa		
type	restriction of <b>string</b>		
properties	base xs:string		
facets	Kind	Value	Annotation
	enumeration	0050001	documentation rechts
	enumeration	0050002	documentation links
annotation	documentation Kat_RechtsLinks		
source	<pre> &lt;simpleType name="enum_0050"&gt;   &lt;annotation&gt;     &lt;documentation&gt;Kat_RechtsLinks&lt;/documentation&gt;   &lt;/annotation&gt;   &lt;restriction base="xs:string"&gt;     &lt;enumeration value="0050001"&gt;       &lt;annotation&gt;         &lt;documentation&gt;rechts&lt;/documentation&gt;       &lt;/annotation&gt;     &lt;/enumeration&gt;     &lt;enumeration value="0050002"&gt;       &lt;annotation&gt;         &lt;documentation&gt;links&lt;/documentation&gt;       &lt;/annotation&gt;     &lt;/enumeration&gt;   &lt;/restriction&gt; &lt;/simpleType&gt; </pre>		

#### simpleType enum\_0060

namespace	http://xml.ir-d.de/irdsa
-----------	--------------------------

type	restriction of <b>string</b>		
properties	base xs:string		
facets	Kind	Value	Annotation
	enumeration	0060001	documentation ja
	enumeration	0060002	documentation nein
annotation	documentation Kat_JaNein		
source	<pre> &lt;simpleType name="enum_0060"&gt;   &lt;annotation&gt;     &lt;documentation&gt;Kat_JaNein&lt;/documentation&gt;   &lt;/annotation&gt;   &lt;restriction base="xs:string"&gt;     &lt;enumeration value="0060001"&gt;       &lt;annotation&gt;         &lt;documentation&gt;ja&lt;/documentation&gt;       &lt;/annotation&gt;     &lt;/enumeration&gt;     &lt;enumeration value="0060002"&gt;       &lt;annotation&gt;         &lt;documentation&gt;nein&lt;/documentation&gt;       &lt;/annotation&gt;     &lt;/enumeration&gt;   &lt;/restriction&gt; &lt;/simpleType&gt; </pre>		

### simpleType **enum\_0061**

namespace	http://xml.ir-d.de/irdsa		
type	restriction of <b>string</b>		
properties	base xs:string		
facets	Kind	Value	Annotation
	enumeration	0061001	documentation ja
	enumeration	0061002	documentation nein
	enumeration	0061099	documentation unbekannt
annotation	documentation Kat_JaNeinUnbekannt		
source	<pre> &lt;simpleType name="enum_0061"&gt;   &lt;annotation&gt;     &lt;documentation&gt;Kat_JaNeinUnbekannt&lt;/documentation&gt;   &lt;/annotation&gt;   &lt;restriction base="xs:string"&gt;     &lt;enumeration value="0061001"&gt;       &lt;annotation&gt;         &lt;documentation&gt;ja&lt;/documentation&gt;       &lt;/annotation&gt;     &lt;/enumeration&gt;     &lt;enumeration value="0061002"&gt;       &lt;annotation&gt;         &lt;documentation&gt;nein&lt;/documentation&gt;       &lt;/annotation&gt;     &lt;/enumeration&gt;   &lt;/restriction&gt; &lt;/simpleType&gt; </pre>		

	<pre> &lt;enumeration value="0061099"&gt;   &lt;annotation&gt;     &lt;documentation&gt;unbekannt&lt;/documentation&gt;   &lt;/annotation&gt; &lt;/enumeration&gt; &lt;/restriction&gt; &lt;/simpleType&gt; </pre>
--	--

### simpleType enum\_0062

namespace	http://xml.ir-d.de/irdsa		
type	restriction of <b>string</b>		
properties	base xs:string		
facets	Kind	Value	Annotation
	enumeration	0062001	documentation Stück
	enumeration	0062002	documentation g
	enumeration	0062003	documentation mg
	enumeration	0062004	documentation l
	enumeration	0062005	documentation ml
	enumeration	0062006	documentation cm <sup>3</sup>
	enumeration	0062007	documentation mm
	enumeration	0062008	documentation cm
	enumeration	0062009	documentation dm
	enumeration	0062010	documentation m
	enumeration	0062042	documentation andere
annotation	documentation Kat_Einheit		
source	<pre> &lt;simpleType name="enum_0062"&gt;   &lt;annotation&gt;     &lt;documentation&gt;Kat_Einheit&lt;/documentation&gt;   &lt;/annotation&gt;   &lt;restriction base="xs:string"&gt;     &lt;enumeration value="0062001"&gt;       &lt;annotation&gt;         &lt;documentation&gt;Stück&lt;/documentation&gt;       &lt;/annotation&gt;     &lt;/enumeration&gt;     &lt;enumeration value="0062002"&gt;       &lt;annotation&gt;         &lt;documentation&gt;g&lt;/documentation&gt;       &lt;/annotation&gt;     &lt;/enumeration&gt;     &lt;enumeration value="0062003"&gt;       &lt;annotation&gt;         &lt;documentation&gt;mg&lt;/documentation&gt;       &lt;/annotation&gt;     &lt;/enumeration&gt; </pre>		

```

<enumeration value="0062004">
  <annotation>
    <documentation>l</documentation>
  </annotation>
</enumeration>
<enumeration value="0062005">
  <annotation>
    <documentation>ml</documentation>
  </annotation>
</enumeration>
<enumeration value="0062006">
  <annotation>
    <documentation>cm3</documentation>
  </annotation>
</enumeration>
<enumeration value="0062007">
  <annotation>
    <documentation>mm</documentation>
  </annotation>
</enumeration>
<enumeration value="0062008">
  <annotation>
    <documentation>cm</documentation>
  </annotation>
</enumeration>
<enumeration value="0062009">
  <annotation>
    <documentation>dm</documentation>
  </annotation>
</enumeration>
<enumeration value="0062010">
  <annotation>
    <documentation>m</documentation>
  </annotation>
</enumeration>
<enumeration value="0062042">
  <annotation>
    <documentation>andere</documentation>
  </annotation>
</enumeration>
</restriction>
</simpleType>

```

### simpleType enum\_0065

namespace	http://xml.ir-d.de/irdsa		
type	restriction of <b>string</b>		
properties	base xs:string		
facets	Kind	Value	Annotation
	enumeration	0065001	documentation stationär
	enumeration	0065002	documentation teilstationär
	enumeration	0065003	documentation ambulant
annotation	documentation Kat_ArtAufenthalt		

source	<pre> &lt;simpleType name="enum_0065"&gt;   &lt;annotation&gt;     &lt;documentation&gt;Kat_ArtAufenthalt&lt;/documentation&gt;   &lt;/annotation&gt;   &lt;restriction base="xs:string"&gt;     &lt;enumeration value="0065001"&gt;       &lt;annotation&gt;         &lt;documentation&gt;stationär&lt;/documentation&gt;       &lt;/annotation&gt;     &lt;/enumeration&gt;     &lt;enumeration value="0065002"&gt;       &lt;annotation&gt;         &lt;documentation&gt;teilstationär&lt;/documentation&gt;       &lt;/annotation&gt;     &lt;/enumeration&gt;     &lt;enumeration value="0065003"&gt;       &lt;annotation&gt;         &lt;documentation&gt;ambulant&lt;/documentation&gt;       &lt;/annotation&gt;     &lt;/enumeration&gt;   &lt;/restriction&gt; &lt;/simpleType&gt; </pre>
--------	--

### simpleType enum\_0067

namespace	http://xml.ir-d.de/irdsa		
type	restriction of <b>string</b>		
properties	base xs:string		
facets	Kind	Value	Annotation
	enumeration	0067001	documentation Implantat
	enumeration	0067002	documentation Explantat
annotation	documentation Kat_ArtArtikel		
source	<pre> &lt;simpleType name="enum_0067"&gt;   &lt;annotation&gt;     &lt;documentation&gt;Kat_ArtArtikel&lt;/documentation&gt;   &lt;/annotation&gt;   &lt;restriction base="xs:string"&gt;     &lt;enumeration value="0067001"&gt;       &lt;annotation&gt;         &lt;documentation&gt;Implantat&lt;/documentation&gt;       &lt;/annotation&gt;     &lt;/enumeration&gt;     &lt;enumeration value="0067002"&gt;       &lt;annotation&gt;         &lt;documentation&gt;Explantat&lt;/documentation&gt;       &lt;/annotation&gt;     &lt;/enumeration&gt;   &lt;/restriction&gt; &lt;/simpleType&gt; </pre>		

### simpleType enum\_0068

namespace	http://xml.ir-d.de/irdsa		
type	restriction of <b>string</b>		
properties	base xs:string		
facets	Kind	Value	Annotation
	enumeration	0068001	documentation UDI
	enumeration	0068002	documentation Referenz (REF)
	enumeration	0068003	documentation Katalognummer
	enumeration	0068042	documentation sonstiger
annotation	documentation Kat_KennzeichenTyp		
source	<pre> &lt;simpleType name="enum_0068"&gt;   &lt;annotation&gt;     &lt;documentation&gt;Kat_KennzeichenTyp&lt;/documentation&gt;   &lt;/annotation&gt;   &lt;restriction base="xs:string"&gt;     &lt;enumeration value="0068001"&gt;       &lt;annotation&gt;         &lt;documentation&gt;UDI&lt;/documentation&gt;       &lt;/annotation&gt;     &lt;/enumeration&gt;     &lt;enumeration value="0068002"&gt;       &lt;annotation&gt;         &lt;documentation&gt;Referenz (REF)&lt;/documentation&gt;       &lt;/annotation&gt;     &lt;/enumeration&gt;     &lt;enumeration value="0068003"&gt;       &lt;annotation&gt;         &lt;documentation&gt;Katalognummer&lt;/documentation&gt;       &lt;/annotation&gt;     &lt;/enumeration&gt;     &lt;enumeration value="0068042"&gt;       &lt;annotation&gt;         &lt;documentation&gt;sonstiger&lt;/documentation&gt;       &lt;/annotation&gt;     &lt;/enumeration&gt;   &lt;/restriction&gt; &lt;/simpleType&gt; </pre>		

### simpleType enum\_0069

namespace	http://xml.ir-d.de/irdsa		
type	restriction of <b>string</b>		
properties	base xs:string		
facets	Kind	Value	Annotation
	enumeration	0069001	documentation Implantat
	enumeration	0069002	documentation Explantat
annotation	documentation Kat_ArtZubehoer		

source	<pre> &lt;simpleType name="enum_0069"&gt;   &lt;annotation&gt;     &lt;documentation&gt;Kat_ArtZubehoer&lt;/documentation&gt;   &lt;/annotation&gt;   &lt;restriction base="xs:string"&gt;     &lt;enumeration value="0069001"&gt;       &lt;annotation&gt;         &lt;documentation&gt;Implantat&lt;/documentation&gt;       &lt;/annotation&gt;     &lt;/enumeration&gt;     &lt;enumeration value="0069002"&gt;       &lt;annotation&gt;         &lt;documentation&gt;Explantat&lt;/documentation&gt;       &lt;/annotation&gt;     &lt;/enumeration&gt;   &lt;/restriction&gt; &lt;/simpleType&gt; </pre>
--------	--

### simpleType enum\_0070

namespace	http://xml.ir-d.de/irdsa		
type	restriction of <b>string</b>		
properties	base xs:string		
facets	Kind	Value	Annotation
	enumeration	0070001	documentation weiblich
	enumeration	0070002	documentation männlich
	enumeration	0070003	documentation divers
	enumeration	0070042	documentation unbestimmt
annotation	documentation Kat_Geschlecht		
source	<pre> &lt;simpleType name="enum_0070"&gt;   &lt;annotation&gt;     &lt;documentation&gt;Kat_Geschlecht&lt;/documentation&gt;   &lt;/annotation&gt;   &lt;restriction base="xs:string"&gt;     &lt;enumeration value="0070001"&gt;       &lt;annotation&gt;         &lt;documentation&gt;weiblich&lt;/documentation&gt;       &lt;/annotation&gt;     &lt;/enumeration&gt;     &lt;enumeration value="0070002"&gt;       &lt;annotation&gt;         &lt;documentation&gt;männlich&lt;/documentation&gt;       &lt;/annotation&gt;     &lt;/enumeration&gt;     &lt;enumeration value="0070003"&gt;       &lt;annotation&gt;         &lt;documentation&gt;divers&lt;/documentation&gt;       &lt;/annotation&gt;     &lt;/enumeration&gt;     &lt;enumeration value="0070042"&gt;       &lt;annotation&gt;         &lt;documentation&gt;unbestimmt&lt;/documentation&gt;       &lt;/annotation&gt;     &lt;/enumeration&gt;   &lt;/restriction&gt; &lt;/simpleType&gt; </pre>		

```

</annotation>
</enumeration>
</restriction>
</simpleType>

```

### simpleType enum\_0071

namespace	http://xml.ir-d.de/irdsa		
type	restriction of <b>string</b>		
properties	base xs:string		
facets	Kind	Value	Annotation
	enumeration	0071001	documentation Implantat
	enumeration	0071002	documentation Explantat
	enumeration	0071003	documentation Degeneriertes/defektes Produkt, das funktionslos im Körper verbleibt
annotation	documentation Kat_ArtikelArtFunktion		
source	<pre> &lt;simpleType name="enum_0071"&gt;   &lt;annotation&gt;     &lt;documentation&gt;Kat_ArtikelArtFunktion&lt;/documentation&gt;   &lt;/annotation&gt;   &lt;restriction base="xs:string"&gt;     &lt;enumeration value="0071001"&gt;       &lt;annotation&gt;         &lt;documentation&gt;Implantat&lt;/documentation&gt;       &lt;/annotation&gt;     &lt;/enumeration&gt;     &lt;enumeration value="0071002"&gt;       &lt;annotation&gt;         &lt;documentation&gt;Explantat&lt;/documentation&gt;       &lt;/annotation&gt;     &lt;/enumeration&gt;     &lt;enumeration value="0071003"&gt;       &lt;annotation&gt;         &lt;documentation&gt;Degeneriertes/defektes Produkt, das funktionslos im         Körper verbleibt&lt;/documentation&gt;       &lt;/annotation&gt;     &lt;/enumeration&gt;   &lt;/restriction&gt; &lt;/simpleType&gt; </pre>		

### simpleType enum\_0075

namespace	http://xml.ir-d.de/irdsa		
type	restriction of <b>string</b>		
properties	base xs:string		
facets	Kind	Value	Annotation
	enumeration	0075001	documentation elektiv
	enumeration	0075002	documentation dringlich
	enumeration	0075003	documentation Notfall



annotation	documentation Kat_Dringlichkeit
source	<pre> &lt;simpleType name="enum_0075"&gt;   &lt;annotation&gt;     &lt;documentation&gt;Kat_Dringlichkeit&lt;/documentation&gt;   &lt;/annotation&gt;   &lt;restriction base="xs:string"&gt;     &lt;enumeration value="0075001"&gt;       &lt;annotation&gt;         &lt;documentation&gt;elektiv&lt;/documentation&gt;       &lt;/annotation&gt;     &lt;/enumeration&gt;     &lt;enumeration value="0075002"&gt;       &lt;annotation&gt;         &lt;documentation&gt;dringlich&lt;/documentation&gt;       &lt;/annotation&gt;     &lt;/enumeration&gt;     &lt;enumeration value="0075003"&gt;       &lt;annotation&gt;         &lt;documentation&gt;Notfall&lt;/documentation&gt;       &lt;/annotation&gt;     &lt;/enumeration&gt;   &lt;/restriction&gt; &lt;/simpleType&gt; </pre>

### simpleType **enum\_0076**

namespace	http://xml.ir-d.de/irdsa		
type	restriction of <b>string</b>		
properties	base xs:string		
facets	Kind	Value	Annotation
	enumeration	0076001	documentation elektiv
	enumeration	0076002	documentation dringlich
	enumeration	0076003	documentation Notfall
	enumeration	0076004	documentation Notfall (Reanimation / ultima ratio)
annotation	documentation Kat_Dringlichkeit_Reanimation		
source	<pre> &lt;simpleType name="enum_0076"&gt;   &lt;annotation&gt;     &lt;documentation&gt;Kat_Dringlichkeit_Reanimation&lt;/documentation&gt;   &lt;/annotation&gt;   &lt;restriction base="xs:string"&gt;     &lt;enumeration value="0076001"&gt;       &lt;annotation&gt;         &lt;documentation&gt;elektiv&lt;/documentation&gt;       &lt;/annotation&gt;     &lt;/enumeration&gt;     &lt;enumeration value="0076002"&gt;       &lt;annotation&gt;         &lt;documentation&gt;dringlich&lt;/documentation&gt;       &lt;/annotation&gt;     &lt;/enumeration&gt;     &lt;enumeration value="0076003"&gt; </pre>		

	<pre> &lt;annotation&gt;   &lt;documentation&gt;Notfall&lt;/documentation&gt; &lt;/annotation&gt; &lt;/enumeration&gt; &lt;enumeration value="0076004"&gt;   &lt;annotation&gt;     &lt;documentation&gt;Notfall (Reanimation / ultima ratio)&lt;/documentation&gt;   &lt;/annotation&gt; &lt;/enumeration&gt; &lt;/restriction&gt; &lt;/simpleType&gt; </pre>
--	--

### simpleType enum\_0080

namespace	http://xml.ir-d.de/irdsa		
type	restriction of <b>string</b>		
properties	base xs:string		
facets	Kind	Value	Annotation
	enumeration	0080001	documentation Endoprothese Hüfte/Knie
	enumeration	0080002	documentation Brustimplantat
	enumeration	0080003	documentation Aortenklappenprothese
annotation	documentation Kat_Implantattyp		
source	<pre> &lt;simpleType name="enum_0080"&gt;   &lt;annotation&gt;     &lt;documentation&gt;Kat_Implantattyp&lt;/documentation&gt;   &lt;/annotation&gt;   &lt;restriction base="xs:string"&gt;     &lt;enumeration value="0080001"&gt;       &lt;annotation&gt;         &lt;documentation&gt;Endoprothese Hüfte/Knie&lt;/documentation&gt;       &lt;/annotation&gt;     &lt;/enumeration&gt;     &lt;enumeration value="0080002"&gt;       &lt;annotation&gt;         &lt;documentation&gt;Brustimplantat&lt;/documentation&gt;       &lt;/annotation&gt;     &lt;/enumeration&gt;     &lt;enumeration value="0080003"&gt;       &lt;annotation&gt;         &lt;documentation&gt;Aortenklappenprothese&lt;/documentation&gt;       &lt;/annotation&gt;     &lt;/enumeration&gt;   &lt;/restriction&gt; &lt;/simpleType&gt; </pre>		

### simpleType enum\_0100

namespace	http://xml.ir-d.de/irdsa		
type	restriction of <b>string</b>		
properties	base xs:string		

facets	<table border="1"> <thead> <tr> <th>Kind</th> <th>Value</th> <th>Annotation</th> </tr> </thead> <tbody> <tr> <td>enumeration</td> <td>0100001</td> <td>documentation Primäreingriff</td> </tr> <tr> <td>enumeration</td> <td>0100002</td> <td>documentation Austausch Expander gegen dauerhaftes Brustimplantat</td> </tr> <tr> <td>enumeration</td> <td>0100003</td> <td>documentation Revision</td> </tr> <tr> <td>enumeration</td> <td>0100004</td> <td>documentation Nur Explantation</td> </tr> </tbody> </table>	Kind	Value	Annotation	enumeration	0100001	documentation Primäreingriff	enumeration	0100002	documentation Austausch Expander gegen dauerhaftes Brustimplantat	enumeration	0100003	documentation Revision	enumeration	0100004	documentation Nur Explantation
Kind	Value	Annotation														
enumeration	0100001	documentation Primäreingriff														
enumeration	0100002	documentation Austausch Expander gegen dauerhaftes Brustimplantat														
enumeration	0100003	documentation Revision														
enumeration	0100004	documentation Nur Explantation														
annotation	documentation Kat_BI_ArtEingriff															
source	<pre> &lt;simpleType name="enum_0100"&gt;   &lt;annotation&gt;     &lt;documentation&gt;Kat_BI_ArtEingriff&lt;/documentation&gt;   &lt;/annotation&gt;   &lt;restriction base="xs:string"&gt;     &lt;enumeration value="0100001"&gt;       &lt;annotation&gt;         &lt;documentation&gt;Primäreingriff&lt;/documentation&gt;       &lt;/annotation&gt;     &lt;/enumeration&gt;     &lt;enumeration value="0100002"&gt;       &lt;annotation&gt;         &lt;documentation&gt;Austausch Expander gegen dauerhaftes Brustimplantat&lt;/documentation&gt;       &lt;/annotation&gt;     &lt;/enumeration&gt;     &lt;enumeration value="0100003"&gt;       &lt;annotation&gt;         &lt;documentation&gt;Revision&lt;/documentation&gt;       &lt;/annotation&gt;     &lt;/enumeration&gt;     &lt;enumeration value="0100004"&gt;       &lt;annotation&gt;         &lt;documentation&gt;Nur Explantation&lt;/documentation&gt;       &lt;/annotation&gt;     &lt;/enumeration&gt;   &lt;/restriction&gt; &lt;/simpleType&gt; </pre>															

### simpleType enum\_0102

namespace	http://xml.ir-d.de/irdsa															
type	restriction of <b>string</b>															
properties	base xs:string															
facets	<table border="1"> <thead> <tr> <th>Kind</th> <th>Value</th> <th>Annotation</th> </tr> </thead> <tbody> <tr> <td>enumeration</td> <td>0102001</td> <td>documentation kosmetische Augmentation</td> </tr> <tr> <td>enumeration</td> <td>0102002</td> <td>documentation Rekonstruktion, benigne</td> </tr> <tr> <td>enumeration</td> <td>0102003</td> <td>documentation Rekonstruktion nach Mastektomie aufgrund eines Karzinoms</td> </tr> <tr> <td>enumeration</td> <td>0102004</td> <td>documentation Rekonstruktion nach risikoreduzierender Mastektomie</td> </tr> </tbody> </table>	Kind	Value	Annotation	enumeration	0102001	documentation kosmetische Augmentation	enumeration	0102002	documentation Rekonstruktion, benigne	enumeration	0102003	documentation Rekonstruktion nach Mastektomie aufgrund eines Karzinoms	enumeration	0102004	documentation Rekonstruktion nach risikoreduzierender Mastektomie
Kind	Value	Annotation														
enumeration	0102001	documentation kosmetische Augmentation														
enumeration	0102002	documentation Rekonstruktion, benigne														
enumeration	0102003	documentation Rekonstruktion nach Mastektomie aufgrund eines Karzinoms														
enumeration	0102004	documentation Rekonstruktion nach risikoreduzierender Mastektomie														
annotation	documentation Kat_BI_GrundPrimaereingriff															
source	<pre> &lt;simpleType name="enum_0102"&gt;   &lt;annotation&gt; </pre>															

	<pre> &lt;documentation&gt;Kat_BI_GrundPrimaereingriff&lt;/documentation&gt; &lt;/annotation&gt; &lt;restriction base="xs:string"&gt;   &lt;enumeration value="0102001"&gt;     &lt;annotation&gt;       &lt;documentation&gt;kosmetische Augmentation&lt;/documentation&gt;     &lt;/annotation&gt;   &lt;/enumeration&gt;   &lt;enumeration value="0102002"&gt;     &lt;annotation&gt;       &lt;documentation&gt;Rekonstruktion, benigne&lt;/documentation&gt;     &lt;/annotation&gt;   &lt;/enumeration&gt;   &lt;enumeration value="0102003"&gt;     &lt;annotation&gt;       &lt;documentation&gt;Rekonstruktion nach Mastektomie aufgrund eines Karzinoms&lt;/documentation&gt;     &lt;/annotation&gt;   &lt;/enumeration&gt;   &lt;enumeration value="0102004"&gt;     &lt;annotation&gt;       &lt;documentation&gt;Rekonstruktion nach risikoreduzierender Mastektomie&lt;/documentation&gt;     &lt;/annotation&gt;   &lt;/enumeration&gt; &lt;/restriction&gt; &lt;/simpleType&gt; </pre>
--	---

### simpleType enum\_0103

namespace	http://xml.ir-d.de/irdsa		
type	restriction of <b>string</b>		
properties	base xs:string		
facets	Kind	Value	Annotation
	enumeration	0103001	documentation simultane Lappendeckung
	enumeration	0103002	documentation simultane Eigenfetttransplantation
	enumeration	0103003	documentation simultane Mastopexie
	enumeration	0103005	documentation simultane Mastektomie, Ablatio / hautsparend
	enumeration	0103006	documentation simultane Mastektomie, nippelerhaltend
	enumeration	0103007	documentation Axilla-Dissektion
	enumeration	0103008	documentation Drainage
annotation	documentation Kat_BI_OperationsdetailPrimaereingriff		
source	<pre> &lt;simpleType name="enum_0103"&gt;   &lt;annotation&gt;     &lt;documentation&gt;Kat_BI_OperationsdetailPrimaereingriff&lt;/documentation&gt;   &lt;/annotation&gt;   &lt;restriction base="xs:string"&gt;     &lt;enumeration value="0103001"&gt;       &lt;annotation&gt; </pre>		

	<pre> &lt;documentation&gt;simultane Lappendeckung&lt;/documentation&gt; &lt;/annotation&gt; &lt;/enumeration&gt; &lt;enumeration value="0103002"&gt;   &lt;annotation&gt;     &lt;documentation&gt;simultane Eigenfetttransplantation&lt;/documentation&gt;   &lt;/annotation&gt; &lt;/enumeration&gt; &lt;enumeration value="0103003"&gt;   &lt;annotation&gt;     &lt;documentation&gt;simultane Mastopexie&lt;/documentation&gt;   &lt;/annotation&gt; &lt;/enumeration&gt; &lt;enumeration value="0103005"&gt;   &lt;annotation&gt;     &lt;documentation&gt;simultane Mastektomie, Ablatio / hautsparend&lt;/documentation&gt;   &lt;/annotation&gt; &lt;/enumeration&gt; &lt;enumeration value="0103006"&gt;   &lt;annotation&gt;     &lt;documentation&gt;simultane Mastektomie, nippelerhaltend&lt;/documentation&gt;   &lt;/annotation&gt; &lt;/enumeration&gt; &lt;enumeration value="0103007"&gt;   &lt;annotation&gt;     &lt;documentation&gt;Axilla-Dissektion&lt;/documentation&gt;   &lt;/annotation&gt; &lt;/enumeration&gt; &lt;enumeration value="0103008"&gt;   &lt;annotation&gt;     &lt;documentation&gt;Drainage&lt;/documentation&gt;   &lt;/annotation&gt; &lt;/enumeration&gt; &lt;/restriction&gt; &lt;/simpleType&gt; </pre>
--	--

#### simpleType enum\_0104

namespace	http://xml.ir-d.de/irdsa		
type	restriction of <b>string</b>		
properties	base xs:string		
facets	Kind	Value	Annotation
	enumeration	0104001	documentation Austausch Expander gegen dauerhaftes Brustimplantat
annotation	documentation Kat_BI_GrundAustausch		
source	<pre> &lt;simpleType name="enum_0104"&gt;   &lt;annotation&gt;     &lt;documentation&gt;Kat_BI_GrundAustausch&lt;/documentation&gt;   &lt;/annotation&gt;   &lt;restriction base="xs:string"&gt;     &lt;enumeration value="0104001"&gt;       &lt;annotation&gt;         &lt;documentation&gt;Austausch Expander gegen dauerhaftes Brustimplantat&lt;/documentation&gt; </pre>		

```

    </annotation>
  </enumeration>
</restriction>
</simpleType>

```

### simpleType enum\_0105

namespace	http://xml.ir-d.de/irdsa		
type	restriction of <b>string</b>		
properties	base xs:string		
facets	Kind	Value	Annotation
	enumeration	0105001	documentation simultane Lappendeckung
	enumeration	0105002	documentation simultane Eigenfetttransplantation
	enumeration	0105003	documentation simultane Mastopexie
	enumeration	0105008	documentation Drainage
	enumeration	0105009	documentation Kapsulektomie, komplett
	enumeration	0105010	documentation Kapsulektomie, partiell
	enumeration	0105011	documentation Neopocket
annotation	documentation Kat_BI_OperationsdetailAustausch		
source	<pre> &lt;simpleType name="enum_0105"&gt;   &lt;annotation&gt;     &lt;documentation&gt;Kat_BI_OperationsdetailAustausch&lt;/documentation&gt;   &lt;/annotation&gt;   &lt;restriction base="xs:string"&gt;     &lt;enumeration value="0105001"&gt;       &lt;annotation&gt;         &lt;documentation&gt;simultane Lappendeckung&lt;/documentation&gt;       &lt;/annotation&gt;     &lt;/enumeration&gt;     &lt;enumeration value="0105002"&gt;       &lt;annotation&gt;         &lt;documentation&gt;simultane Eigenfetttransplantation&lt;/documentation&gt;       &lt;/annotation&gt;     &lt;/enumeration&gt;     &lt;enumeration value="0105003"&gt;       &lt;annotation&gt;         &lt;documentation&gt;simultane Mastopexie&lt;/documentation&gt;       &lt;/annotation&gt;     &lt;/enumeration&gt;     &lt;enumeration value="0105008"&gt;       &lt;annotation&gt;         &lt;documentation&gt;Drainage&lt;/documentation&gt;       &lt;/annotation&gt;     &lt;/enumeration&gt;     &lt;enumeration value="0105009"&gt;       &lt;annotation&gt;         &lt;documentation&gt;Kapsulektomie, komplett&lt;/documentation&gt;       &lt;/annotation&gt;     &lt;/enumeration&gt;   &lt;/restriction&gt; &lt;/simpleType&gt; </pre>		

	<pre> &lt;enumeration value="0105010"&gt;   &lt;annotation&gt;     &lt;documentation&gt;Kapsulektomie, partiell&lt;/documentation&gt;   &lt;/annotation&gt; &lt;/enumeration&gt; &lt;enumeration value="0105011"&gt;   &lt;annotation&gt;     &lt;documentation&gt;Neopocket&lt;/documentation&gt;   &lt;/annotation&gt; &lt;/enumeration&gt; &lt;/restriction&gt; &lt;/simpleType&gt; </pre>
--	---

### simpleType enum\_0106

namespace	http://xml.ir-d.de/irdsa		
type	restriction of <b>string</b>		
properties	base xs:string		
facets	Kind	Value	Annotation
	enumeration	0106001	documentation Patientenwunsch
	enumeration	0106002	documentation asymptomatisch
	enumeration	0106003	documentation Komplikation
annotation	documentation Kat_BI_GrundRevisionExplantation		
source	<pre> &lt;simpleType name="enum_0106"&gt;   &lt;annotation&gt;     &lt;documentation&gt;Kat_BI_GrundRevisionExplantation&lt;/documentation&gt;   &lt;/annotation&gt;   &lt;restriction base="xs:string"&gt;     &lt;enumeration value="0106001"&gt;       &lt;annotation&gt;         &lt;documentation&gt;Patientenwunsch&lt;/documentation&gt;       &lt;/annotation&gt;     &lt;/enumeration&gt;     &lt;enumeration value="0106002"&gt;       &lt;annotation&gt;         &lt;documentation&gt;asymptomatisch&lt;/documentation&gt;       &lt;/annotation&gt;     &lt;/enumeration&gt;     &lt;enumeration value="0106003"&gt;       &lt;annotation&gt;         &lt;documentation&gt;Komplikation&lt;/documentation&gt;       &lt;/annotation&gt;     &lt;/enumeration&gt;   &lt;/restriction&gt; &lt;/simpleType&gt; </pre>		

### simpleType enum\_0107

namespace	http://xml.ir-d.de/irdsa
type	restriction of <b>string</b>

properties	base xs:string																																	
facets	<table border="1"> <thead> <tr> <th>Kind</th> <th>Value</th> <th>Annotation</th> </tr> </thead> <tbody> <tr> <td>enumeration</td> <td>0107001</td> <td>documentation simultane Lappendeckung</td> </tr> <tr> <td>enumeration</td> <td>0107002</td> <td>documentation simultane Eigenfetttransplantation</td> </tr> <tr> <td>enumeration</td> <td>0107003</td> <td>documentation simultane Mastopexie</td> </tr> <tr> <td>enumeration</td> <td>0107005</td> <td>documentation simultane Mastektomie, Ablatio / hautsparend</td> </tr> <tr> <td>enumeration</td> <td>0107006</td> <td>documentation simultane Mastektomie, nippelerhaltend</td> </tr> <tr> <td>enumeration</td> <td>0107007</td> <td>documentation Axilla-Dissektion</td> </tr> <tr> <td>enumeration</td> <td>0107008</td> <td>documentation Drainage</td> </tr> <tr> <td>enumeration</td> <td>0107009</td> <td>documentation Kapsulektomie, komplett</td> </tr> <tr> <td>enumeration</td> <td>0107010</td> <td>documentation Kapsulektomie, partiell</td> </tr> <tr> <td>enumeration</td> <td>0107011</td> <td>documentation Neopocket</td> </tr> </tbody> </table>	Kind	Value	Annotation	enumeration	0107001	documentation simultane Lappendeckung	enumeration	0107002	documentation simultane Eigenfetttransplantation	enumeration	0107003	documentation simultane Mastopexie	enumeration	0107005	documentation simultane Mastektomie, Ablatio / hautsparend	enumeration	0107006	documentation simultane Mastektomie, nippelerhaltend	enumeration	0107007	documentation Axilla-Dissektion	enumeration	0107008	documentation Drainage	enumeration	0107009	documentation Kapsulektomie, komplett	enumeration	0107010	documentation Kapsulektomie, partiell	enumeration	0107011	documentation Neopocket
Kind	Value	Annotation																																
enumeration	0107001	documentation simultane Lappendeckung																																
enumeration	0107002	documentation simultane Eigenfetttransplantation																																
enumeration	0107003	documentation simultane Mastopexie																																
enumeration	0107005	documentation simultane Mastektomie, Ablatio / hautsparend																																
enumeration	0107006	documentation simultane Mastektomie, nippelerhaltend																																
enumeration	0107007	documentation Axilla-Dissektion																																
enumeration	0107008	documentation Drainage																																
enumeration	0107009	documentation Kapsulektomie, komplett																																
enumeration	0107010	documentation Kapsulektomie, partiell																																
enumeration	0107011	documentation Neopocket																																
annotation	documentation Kat_BI_OperationsdetailRevision																																	
source	<pre> &lt;simpleType name="enum_0107"&gt;   &lt;annotation&gt;     &lt;documentation&gt;Kat_BI_OperationsdetailRevision&lt;/documentation&gt;   &lt;/annotation&gt;   &lt;restriction base="xs:string"&gt;     &lt;enumeration value="0107001"&gt;       &lt;annotation&gt;         &lt;documentation&gt;simultane Lappendeckung&lt;/documentation&gt;       &lt;/annotation&gt;     &lt;/enumeration&gt;     &lt;enumeration value="0107002"&gt;       &lt;annotation&gt;         &lt;documentation&gt;simultane Eigenfetttransplantation&lt;/documentation&gt;       &lt;/annotation&gt;     &lt;/enumeration&gt;     &lt;enumeration value="0107003"&gt;       &lt;annotation&gt;         &lt;documentation&gt;simultane Mastopexie&lt;/documentation&gt;       &lt;/annotation&gt;     &lt;/enumeration&gt;     &lt;enumeration value="0107005"&gt;       &lt;annotation&gt;         &lt;documentation&gt;simultane Mastektomie, Ablatio / hautsparend&lt;/documentation&gt;       &lt;/annotation&gt;     &lt;/enumeration&gt;     &lt;enumeration value="0107006"&gt;       &lt;annotation&gt;         &lt;documentation&gt;simultane Mastektomie, nippelerhaltend&lt;/documentation&gt;       &lt;/annotation&gt;     &lt;/enumeration&gt;     &lt;enumeration value="0107007"&gt;       &lt;annotation&gt;         &lt;documentation&gt;Axilla-Dissektion&lt;/documentation&gt;       &lt;/annotation&gt;     &lt;/enumeration&gt;   &lt;/restriction&gt; &lt;/simpleType&gt; </pre>																																	



	<pre> &lt;enumeration value="0107008"&gt;   &lt;annotation&gt;     &lt;documentation&gt;Drainage&lt;/documentation&gt;   &lt;/annotation&gt; &lt;/enumeration&gt; &lt;enumeration value="0107009"&gt;   &lt;annotation&gt;     &lt;documentation&gt;Kapsulektomie, komplett&lt;/documentation&gt;   &lt;/annotation&gt; &lt;/enumeration&gt; &lt;enumeration value="0107010"&gt;   &lt;annotation&gt;     &lt;documentation&gt;Kapsulektomie, partiell&lt;/documentation&gt;   &lt;/annotation&gt; &lt;/enumeration&gt; &lt;enumeration value="0107011"&gt;   &lt;annotation&gt;     &lt;documentation&gt;Neopocket&lt;/documentation&gt;   &lt;/annotation&gt; &lt;/enumeration&gt; &lt;/restriction&gt; &lt;/simpleType&gt; </pre>
--	--

#### simpleType enum\_0110

namespace	http://xml.ir-d.de/irdsa		
type	restriction of <b>string</b>		
properties	base xs:string		
facets	Kind	Value	Annotation
	enumeration	0110001	documentation Bestrahlung
annotation	documentation Kat_BI_VorbehandlungLokal		
source	<pre> &lt;simpleType name="enum_0110"&gt;   &lt;annotation&gt;     &lt;documentation&gt;Kat_BI_VorbehandlungLokal&lt;/documentation&gt;   &lt;/annotation&gt;   &lt;restriction base="xs:string"&gt;     &lt;enumeration value="0110001"&gt;       &lt;annotation&gt;         &lt;documentation&gt;Bestrahlung&lt;/documentation&gt;       &lt;/annotation&gt;     &lt;/enumeration&gt;   &lt;/restriction&gt; &lt;/simpleType&gt; </pre>		

#### simpleType enum\_0111

namespace	http://xml.ir-d.de/irdsa		
type	restriction of <b>string</b>		
properties	base xs:string		
facets	Kind	Value	Annotation
	enumeration	0111001	documentation nein

	enumeration 0111002 documentation Lipofilling enumeration 0111003 documentation Eigengewebstrekonstruktion
annotation	documentation Kat_BI_Verfahrenswechsel
source	<pre> &lt;simpleType name="enum_0111"&gt;   &lt;annotation&gt;     &lt;documentation&gt;Kat_BI_Verfahrenswechsel&lt;/documentation&gt;   &lt;/annotation&gt;   &lt;restriction base="xs:string"&gt;     &lt;enumeration value="0111001"&gt;       &lt;annotation&gt;         &lt;documentation&gt;nein&lt;/documentation&gt;       &lt;/annotation&gt;     &lt;/enumeration&gt;     &lt;enumeration value="0111002"&gt;       &lt;annotation&gt;         &lt;documentation&gt;Lipofilling&lt;/documentation&gt;       &lt;/annotation&gt;     &lt;/enumeration&gt;     &lt;enumeration value="0111003"&gt;       &lt;annotation&gt;         &lt;documentation&gt;Eigengewebstrekonstruktion&lt;/documentation&gt;       &lt;/annotation&gt;     &lt;/enumeration&gt;   &lt;/restriction&gt; &lt;/simpleType&gt; </pre>

### simpleType enum\_0112

namespace	http://xml.ir-d.de/irdsa		
type	restriction of <b>string</b>		
properties	base xs:string		
facets	Kind	Value	Annotation
	enumeration	0112001	documentation subglandulär / epipektoral
	enumeration	0112002	documentation subpektoral
	enumeration	0112003	documentation subfaszial
	enumeration	0112004	documentation sub-flap
	enumeration	0112005	documentation subkutan
	enumeration	0112006	documentation dual plane
	enumeration	0112042	documentation andere
annotation	documentation Kat_BI_LageImplantat		
source	<pre> &lt;simpleType name="enum_0112"&gt;   &lt;annotation&gt;     &lt;documentation&gt;Kat_BI_LageImplantat&lt;/documentation&gt;   &lt;/annotation&gt;   &lt;restriction base="xs:string"&gt;     &lt;enumeration value="0112001"&gt;       &lt;annotation&gt; </pre>		

	<pre>       &lt;documentation&gt;subglandulär / epipektoral&lt;/documentation&gt;     &lt;/annotation&gt;   &lt;/enumeration&gt;   &lt;enumeration value="0112002"&gt;     &lt;annotation&gt;       &lt;documentation&gt;subpektoral&lt;/documentation&gt;     &lt;/annotation&gt;   &lt;/enumeration&gt;   &lt;enumeration value="0112003"&gt;     &lt;annotation&gt;       &lt;documentation&gt;subfaszial&lt;/documentation&gt;     &lt;/annotation&gt;   &lt;/enumeration&gt;   &lt;enumeration value="0112004"&gt;     &lt;annotation&gt;       &lt;documentation&gt;sub-flap&lt;/documentation&gt;     &lt;/annotation&gt;   &lt;/enumeration&gt;   &lt;enumeration value="0112005"&gt;     &lt;annotation&gt;       &lt;documentation&gt;subkutan&lt;/documentation&gt;     &lt;/annotation&gt;   &lt;/enumeration&gt;   &lt;enumeration value="0112006"&gt;     &lt;annotation&gt;       &lt;documentation&gt;dual plane&lt;/documentation&gt;     &lt;/annotation&gt;   &lt;/enumeration&gt;   &lt;enumeration value="0112042"&gt;     &lt;annotation&gt;       &lt;documentation&gt;andere&lt;/documentation&gt;     &lt;/annotation&gt;   &lt;/enumeration&gt; &lt;/restriction&gt; &lt;/simpleType&gt; </pre>
--	---

### simpleType enum\_0113

namespace	http://xml.ir-d.de/irdsa		
type	restriction of <b>string</b>		
properties	base xs:string		
facets	Kind	Value	Annotation
	enumeration	0113001	documentation Chemotherapie innerhalb der letzten drei Monate
annotation	documentation Kat_BI_VorbehandlungSystemisch		
source	<pre> &lt;simpleType name="enum_0113"&gt;   &lt;annotation&gt;     &lt;documentation&gt;Kat_BI_VorbehandlungSystemisch&lt;/documentation&gt;   &lt;/annotation&gt;   &lt;restriction base="xs:string"&gt;     &lt;enumeration value="0113001"&gt;       &lt;annotation&gt;         &lt;documentation&gt;Chemotherapie innerhalb der letzten drei         Monate&lt;/documentation&gt;       &lt;/annotation&gt; </pre>		

	<pre> &lt;/enumeration&gt; &lt;/restriction&gt; &lt;/simpleType&gt; </pre>
--	--

### simpleType enum\_0114

namespace	http://xml.ir-d.de/irdsa		
type	restriction of <b>string</b>		
properties	base xs:string		
facets	Kind	Value	Annotation
	enumeration	0114001	documentation vollständig
	enumeration	0114002	documentation nein
	enumeration	0114003	documentation teilweise
	enumeration	0114004	documentation nicht vorhanden
annotation	documentation Kat_BI_EntfernungADMNetz		
source	<pre> &lt;simpleType name="enum_0114"&gt;   &lt;annotation&gt;     &lt;documentation&gt;Kat_BI_EntfernungADMNetz&lt;/documentation&gt;   &lt;/annotation&gt;   &lt;restriction base="xs:string"&gt;     &lt;enumeration value="0114001"&gt;       &lt;annotation&gt;         &lt;documentation&gt;vollständig&lt;/documentation&gt;       &lt;/annotation&gt;     &lt;/enumeration&gt;     &lt;enumeration value="0114002"&gt;       &lt;annotation&gt;         &lt;documentation&gt;nein&lt;/documentation&gt;       &lt;/annotation&gt;     &lt;/enumeration&gt;     &lt;enumeration value="0114003"&gt;       &lt;annotation&gt;         &lt;documentation&gt;teilweise&lt;/documentation&gt;       &lt;/annotation&gt;     &lt;/enumeration&gt;     &lt;enumeration value="0114004"&gt;       &lt;annotation&gt;         &lt;documentation&gt;nicht vorhanden&lt;/documentation&gt;       &lt;/annotation&gt;     &lt;/enumeration&gt;   &lt;/restriction&gt; &lt;/simpleType&gt; </pre>		

### simpleType enum\_0116

namespace	http://xml.ir-d.de/irdsa		
type	restriction of <b>string</b>		
properties	base xs:string		
facets	Kind	Value	Annotation

	<p>enumeration 0116001 documentation Spülung, antibiotisch</p> <p>enumeration 0116002 documentation Spülung, antiseptisch</p> <p>enumeration 0116003 documentation Spülung, wirkstofffrei</p> <p>enumeration 0116004 documentation Spülung, andere</p> <p>enumeration 0116005 documentation prä-/perioperative Antibiotika</p> <p>enumeration 0116006 documentation postoperative Antibiotika</p> <p>enumeration 0116007 documentation Handschuhwechsel vor Implantation</p> <p>enumeration 0116008 documentation Implantationshilfe</p>
annotation	documentation Kat_BI_Operationsmassnahme
source	<pre> &lt;simpleType name="enum_0116"&gt;   &lt;annotation&gt;     &lt;documentation&gt;Kat_BI_Operationsmassnahme&lt;/documentation&gt;   &lt;/annotation&gt;   &lt;restriction base="xs:string"&gt;     &lt;enumeration value="0116001"&gt;       &lt;annotation&gt;         &lt;documentation&gt;Spülung, antibiotisch&lt;/documentation&gt;       &lt;/annotation&gt;     &lt;/enumeration&gt;     &lt;enumeration value="0116002"&gt;       &lt;annotation&gt;         &lt;documentation&gt;Spülung, antiseptisch&lt;/documentation&gt;       &lt;/annotation&gt;     &lt;/enumeration&gt;     &lt;enumeration value="0116003"&gt;       &lt;annotation&gt;         &lt;documentation&gt;Spülung, wirkstofffrei&lt;/documentation&gt;       &lt;/annotation&gt;     &lt;/enumeration&gt;     &lt;enumeration value="0116004"&gt;       &lt;annotation&gt;         &lt;documentation&gt;Spülung, andere&lt;/documentation&gt;       &lt;/annotation&gt;     &lt;/enumeration&gt;     &lt;enumeration value="0116005"&gt;       &lt;annotation&gt;         &lt;documentation&gt;prä-/perioperative Antibiotika&lt;/documentation&gt;       &lt;/annotation&gt;     &lt;/enumeration&gt;     &lt;enumeration value="0116006"&gt;       &lt;annotation&gt;         &lt;documentation&gt;postoperative Antibiotika&lt;/documentation&gt;       &lt;/annotation&gt;     &lt;/enumeration&gt;     &lt;enumeration value="0116007"&gt;       &lt;annotation&gt;         &lt;documentation&gt;Handschuhwechsel vor Implantation&lt;/documentation&gt;       &lt;/annotation&gt;     &lt;/enumeration&gt;     &lt;enumeration value="0116008"&gt;       &lt;annotation&gt; </pre>

```

    <documentation>Implantationshilfe</documentation>
  </annotation>
</enumeration>
</restriction>
</simpleType>

```

### simpleType enum\_0118

namespace	http://xml.ir-d.de/irdsa		
type	restriction of <b>string</b>		
properties	base xs:string		
facets	Kind	Value	Annotation
	enumeration	0118001	documentation axillär
	enumeration	0118002	documentation periareolär
	enumeration	0118003	documentation inframammär
	enumeration	0118004	documentation Mastektomienarbe
	enumeration	0118042	documentation anderer
annotation	documentation Kat_BI_Operationszugang		
source	<pre> &lt;simpleType name="enum_0118"&gt;   &lt;annotation&gt;     &lt;documentation&gt;Kat_BI_Operationszugang&lt;/documentation&gt;   &lt;/annotation&gt;   &lt;restriction base="xs:string"&gt;     &lt;enumeration value="0118001"&gt;       &lt;annotation&gt;         &lt;documentation&gt;axillär&lt;/documentation&gt;       &lt;/annotation&gt;     &lt;/enumeration&gt;     &lt;enumeration value="0118002"&gt;       &lt;annotation&gt;         &lt;documentation&gt;periareolär&lt;/documentation&gt;       &lt;/annotation&gt;     &lt;/enumeration&gt;     &lt;enumeration value="0118003"&gt;       &lt;annotation&gt;         &lt;documentation&gt;inframammär&lt;/documentation&gt;       &lt;/annotation&gt;     &lt;/enumeration&gt;     &lt;enumeration value="0118004"&gt;       &lt;annotation&gt;         &lt;documentation&gt;Mastektomienarbe&lt;/documentation&gt;       &lt;/annotation&gt;     &lt;/enumeration&gt;     &lt;enumeration value="0118042"&gt;       &lt;annotation&gt;         &lt;documentation&gt;anderer&lt;/documentation&gt;       &lt;/annotation&gt;     &lt;/enumeration&gt;   &lt;/restriction&gt; &lt;/simpleType&gt; </pre>		

### simpleType enum\_0120

namespace	http://xml.ir-d.de/irdsa		
type	restriction of <b>string</b>		
properties	base xs:string		
facets	Kind	Value	Annotation
	enumeration	0120001	documentation Expander defekt
annotation	documentation Kat_BI_BefundAustausch		
source	<pre>&lt;simpleType name="enum_0120"&gt;   &lt;annotation&gt;     &lt;documentation&gt;Kat_BI_BefundAustausch&lt;/documentation&gt;   &lt;/annotation&gt;   &lt;restriction base="xs:string"&gt;     &lt;enumeration value="0120001"&gt;       &lt;annotation&gt;         &lt;documentation&gt;Expander defekt&lt;/documentation&gt;       &lt;/annotation&gt;     &lt;/enumeration&gt;   &lt;/restriction&gt; &lt;/simpleType&gt;</pre>		

### simpleType enum\_0121

namespace	http://xml.ir-d.de/irdsa		
type	restriction of <b>string</b>		
properties	base xs:string		
facets	Kind	Value	Annotation
	enumeration	0121001	documentation Infektion
	enumeration	0121002	documentation Serom
	enumeration	0121003	documentation Hämatom
	enumeration	0121004	documentation Kapsel fibrose
	enumeration	0121005	documentation Implantatruptur
	enumeration	0121006	documentation Fehlpositionierung/Rotation
	enumeration	0121007	documentation BIA-ALCL/-SCC, Verdacht
	enumeration	0121008	documentation BIA-ALCL/-SCC, pathologisch bestätigt
	enumeration	0121009	documentation Brustschmerzen
	enumeration	0121010	documentation Doppelkapsel
	enumeration	0121011	documentation Netz-/ADM-bedingte Komplikation, Non-Integration
	enumeration	0121012	documentation Netz-/ADM-bedingte Komplikation, andere
	enumeration	0121013	documentation Hautnekrose/exponiertes Implantat
	enumeration	0121014	documentation BII/ASIA (Brustimplantat assoziierte Symptome), Verdacht

	<p>enumeration 0121015 documentation Lymphadenopathie</p> <p>enumeration 0121016 documentation Brustkrebs, neu aufgetreten/Rezidiv</p>
annotation	<p>documentation Kat_BI_BefundKomplett</p>
source	<pre> &lt;simpleType name="enum_0121"&gt;   &lt;annotation&gt;     &lt;documentation&gt;Kat_BI_BefundKomplett&lt;/documentation&gt;   &lt;/annotation&gt;   &lt;restriction base="xs:string"&gt;     &lt;enumeration value="0121001"&gt;       &lt;annotation&gt;         &lt;documentation&gt;Infektion&lt;/documentation&gt;       &lt;/annotation&gt;     &lt;/enumeration&gt;     &lt;enumeration value="0121002"&gt;       &lt;annotation&gt;         &lt;documentation&gt;Serom&lt;/documentation&gt;       &lt;/annotation&gt;     &lt;/enumeration&gt;     &lt;enumeration value="0121003"&gt;       &lt;annotation&gt;         &lt;documentation&gt;Hämatom&lt;/documentation&gt;       &lt;/annotation&gt;     &lt;/enumeration&gt;     &lt;enumeration value="0121004"&gt;       &lt;annotation&gt;         &lt;documentation&gt;Kapsel-fibrose&lt;/documentation&gt;       &lt;/annotation&gt;     &lt;/enumeration&gt;     &lt;enumeration value="0121005"&gt;       &lt;annotation&gt;         &lt;documentation&gt;Implantatruptur&lt;/documentation&gt;       &lt;/annotation&gt;     &lt;/enumeration&gt;     &lt;enumeration value="0121006"&gt;       &lt;annotation&gt;         &lt;documentation&gt;Fehlpositionierung/Rotation&lt;/documentation&gt;       &lt;/annotation&gt;     &lt;/enumeration&gt;     &lt;enumeration value="0121007"&gt;       &lt;annotation&gt;         &lt;documentation&gt;BIA-ALCL/-SCC, Verdacht&lt;/documentation&gt;       &lt;/annotation&gt;     &lt;/enumeration&gt;     &lt;enumeration value="0121008"&gt;       &lt;annotation&gt;         &lt;documentation&gt;BIA-ALCL/-SCC, pathologisch bestätigt&lt;/documentation&gt;       &lt;/annotation&gt;     &lt;/enumeration&gt;     &lt;enumeration value="0121009"&gt;       &lt;annotation&gt;         &lt;documentation&gt;Brustschmerzen&lt;/documentation&gt;       &lt;/annotation&gt;     &lt;/enumeration&gt;     &lt;enumeration value="0121010"&gt;       &lt;annotation&gt;         &lt;documentation&gt;Doppelkapsel&lt;/documentation&gt;       &lt;/annotation&gt;     &lt;/enumeration&gt;   &lt;/restriction&gt; &lt;/simpleType&gt; </pre>



	<pre> &lt;/annotation&gt; &lt;/enumeration&gt; &lt;enumeration value="0121011"&gt;   &lt;annotation&gt;     &lt;documentation&gt;Netz-/ADM-bedingte Komplikation, Non-Integration&lt;/documentation&gt;   &lt;/annotation&gt; &lt;/enumeration&gt; &lt;enumeration value="0121012"&gt;   &lt;annotation&gt;     &lt;documentation&gt;Netz-/ADM-bedingte Komplikation, andere&lt;/documentation&gt;   &lt;/annotation&gt; &lt;/enumeration&gt; &lt;enumeration value="0121013"&gt;   &lt;annotation&gt;     &lt;documentation&gt;Hautnekrose/exponiertes Implantat&lt;/documentation&gt;   &lt;/annotation&gt; &lt;/enumeration&gt; &lt;enumeration value="0121014"&gt;   &lt;annotation&gt;     &lt;documentation&gt;BII/ASIA (Brustimplantat assoziierte Symptome), Verdacht&lt;/documentation&gt;   &lt;/annotation&gt; &lt;/enumeration&gt; &lt;enumeration value="0121015"&gt;   &lt;annotation&gt;     &lt;documentation&gt;Lymphadenopathie&lt;/documentation&gt;   &lt;/annotation&gt; &lt;/enumeration&gt; &lt;enumeration value="0121016"&gt;   &lt;annotation&gt;     &lt;documentation&gt;Brustkrebs, neu aufgetreten/Rezidiv&lt;/documentation&gt;   &lt;/annotation&gt; &lt;/enumeration&gt; &lt;/restriction&gt; &lt;/simpleType&gt; </pre>
--	---

### simpleType enum\_0122

namespace	http://xml.ir-d.de/irdsa		
type	restriction of <b>string</b>		
properties	base xs:string		
facets	Kind	Value	Annotation
	enumeration	0122001	documentation ja, ärztlich nachgewiesen
	enumeration	0122002	documentation nein
	enumeration	0122042	documentation unbekannt
annotation	documentation Kat_BI_Autoimmunerkrankung		
source	<pre> &lt;simpleType name="enum_0122"&gt;   &lt;annotation&gt;     &lt;documentation&gt;Kat_BI_Autoimmunerkrankung&lt;/documentation&gt;   &lt;/annotation&gt;   &lt;restriction base="xs:string"&gt;     &lt;enumeration value="0122001"&gt; </pre>		

	<pre> &lt;annotation&gt;   &lt;documentation&gt;ja, ärztlich nachgewiesen&lt;/documentation&gt; &lt;/annotation&gt; &lt;/enumeration&gt; &lt;enumeration value="0122002"&gt;   &lt;annotation&gt;     &lt;documentation&gt;nein&lt;/documentation&gt;   &lt;/annotation&gt; &lt;/enumeration&gt; &lt;enumeration value="0122042"&gt;   &lt;annotation&gt;     &lt;documentation&gt;unbekannt&lt;/documentation&gt;   &lt;/annotation&gt; &lt;/enumeration&gt; &lt;/restriction&gt; &lt;/simpleType&gt; </pre>
--	---

### simpleType enum\_0123

namespace	http://xml.ir-d.de/irdsa		
type	restriction of <b>string</b>		
properties	base xs:string		
facets	Kind	Value	Annotation
	enumeration	0123001	documentation neu aufgetreten
	enumeration	0123002	documentation verschlechtert
	enumeration	0123003	documentation keine Veränderung
	enumeration	0123004	documentation nicht relevant, da Primäreingriff
	enumeration	0123042	documentation unbekannt
annotation	documentation Kat_BI_VerlaufAutoimmunerkrankung		
source	<pre> &lt;simpleType name="enum_0123"&gt;   &lt;annotation&gt;     &lt;documentation&gt;Kat_BI_VerlaufAutoimmunerkrankung&lt;/documentation&gt;   &lt;/annotation&gt;   &lt;restriction base="xs:string"&gt;     &lt;enumeration value="0123001"&gt;       &lt;annotation&gt;         &lt;documentation&gt;neu aufgetreten&lt;/documentation&gt;       &lt;/annotation&gt;     &lt;/enumeration&gt;     &lt;enumeration value="0123002"&gt;       &lt;annotation&gt;         &lt;documentation&gt;verschlechtert&lt;/documentation&gt;       &lt;/annotation&gt;     &lt;/enumeration&gt;     &lt;enumeration value="0123003"&gt;       &lt;annotation&gt;         &lt;documentation&gt;keine Veränderung&lt;/documentation&gt;       &lt;/annotation&gt;     &lt;/enumeration&gt;     &lt;enumeration value="0123004"&gt;       &lt;annotation&gt; </pre>		

	<pre> &lt;documentation&gt;nicht relevant, da Primäreingriff&lt;/documentation&gt; &lt;/annotation&gt; &lt;/enumeration&gt; &lt;enumeration value="0123042"&gt;   &lt;annotation&gt;     &lt;documentation&gt;unbekannt&lt;/documentation&gt;   &lt;/annotation&gt; &lt;/enumeration&gt; &lt;/restriction&gt; &lt;/simpleType&gt; </pre>
--	--

### simpleType enum\_0124

namespace	http://xml.ir-d.de/irdsa		
type	restriction of <b>string</b>		
properties	base xs:string		
facets	Kind	Value	Annotation
	enumeration	0124001	documentation Salzlösung
	enumeration	0124002	documentation Silikongel
	enumeration	0124003	documentation Kombination Silikongel und Salzlösung
	enumeration	0124042	documentation sonstige
annotation	documentation Kat_BI_Fuellung		
source	<pre> &lt;simpleType name="enum_0124"&gt;   &lt;annotation&gt;     &lt;documentation&gt;Kat_BI_Fuellung&lt;/documentation&gt;   &lt;/annotation&gt;   &lt;restriction base="xs:string"&gt;     &lt;enumeration value="0124001"&gt;       &lt;annotation&gt;         &lt;documentation&gt;Salzlösung&lt;/documentation&gt;       &lt;/annotation&gt;     &lt;/enumeration&gt;     &lt;enumeration value="0124002"&gt;       &lt;annotation&gt;         &lt;documentation&gt;Silikongel&lt;/documentation&gt;       &lt;/annotation&gt;     &lt;/enumeration&gt;     &lt;enumeration value="0124003"&gt;       &lt;annotation&gt;         &lt;documentation&gt;Kombination Silikongel und Salzlösung&lt;/documentation&gt;       &lt;/annotation&gt;     &lt;/enumeration&gt;     &lt;enumeration value="0124042"&gt;       &lt;annotation&gt;         &lt;documentation&gt;sonstige&lt;/documentation&gt;       &lt;/annotation&gt;     &lt;/enumeration&gt;   &lt;/restriction&gt; &lt;/simpleType&gt; </pre>		

### simpleType enum\_0126

namespace	http://xml.ir-d.de/irdsa		
type	restriction of <b>string</b>		
properties	base xs:string		
facets	Kind	Value	Annotation
	enumeration	0126001	documentation anatomisch (tropfenförmig)
	enumeration	0126002	documentation rund (punktsymmetrisch)
	enumeration	0126042	documentation sonstige
annotation	documentation Kat_BI_Form		
source	<pre> &lt;simpleType name="enum_0126"&gt;   &lt;annotation&gt;     &lt;documentation&gt;Kat_BI_Form&lt;/documentation&gt;   &lt;/annotation&gt;   &lt;restriction base="xs:string"&gt;     &lt;enumeration value="0126001"&gt;       &lt;annotation&gt;         &lt;documentation&gt;anatomisch (tropfenförmig)&lt;/documentation&gt;       &lt;/annotation&gt;     &lt;/enumeration&gt;     &lt;enumeration value="0126002"&gt;       &lt;annotation&gt;         &lt;documentation&gt;rund (punktsymmetrisch)&lt;/documentation&gt;       &lt;/annotation&gt;     &lt;/enumeration&gt;     &lt;enumeration value="0126042"&gt;       &lt;annotation&gt;         &lt;documentation&gt;sonstige&lt;/documentation&gt;       &lt;/annotation&gt;     &lt;/enumeration&gt;   &lt;/restriction&gt; &lt;/simpleType&gt; </pre>		

### simpleType enum\_0128

namespace	http://xml.ir-d.de/irdsa		
type	restriction of <b>string</b>		
properties	base xs:string		
facets	Kind	Value	Annotation
	enumeration	0128001	documentation glattwandig
	enumeration	0128002	documentation beschichtet
	enumeration	0128003	documentation texturiert
annotation	documentation Kat_BI_Oberflaeche		
source	<pre> &lt;simpleType name="enum_0128"&gt;   &lt;annotation&gt;     &lt;documentation&gt;Kat_BI_Oberflaeche&lt;/documentation&gt;   &lt;/annotation&gt;   &lt;restriction base="xs:string"&gt; </pre>		

```

<enumeration value="0128001">
  <annotation>
    <documentation>glattwandig</documentation>
  </annotation>
</enumeration>
<enumeration value="0128002">
  <annotation>
    <documentation>beschichtet</documentation>
  </annotation>
</enumeration>
<enumeration value="0128003">
  <annotation>
    <documentation>texturiert</documentation>
  </annotation>
</enumeration>
</restriction>
</simpleType>

```

simpleType **enum\_0130**

namespace	http://xml.ir-d.de/irdsa		
type	restriction of <b>string</b>		
properties	base xs:string		
facets	Kind	Value	Annotation
	enumeration	0130001	documentation Allergan
	enumeration	0130002	documentation Cereplas
	enumeration	0130003	documentation CUI (Cox Uphoff Implants)
	enumeration	0130004	documentation EMSI Biomedical
	enumeration	0130005	documentation Establishment labs
	enumeration	0130006	documentation Eurosilicone
	enumeration	0130007	documentation Nagor
	enumeration	0130008	documentation Groupe Sebbin
	enumeration	0130009	documentation Laboratoires Arion
	enumeration	0130010	documentation Mentor
	enumeration	0130011	documentation Pérouse Plastie SAS
	enumeration	0130012	documentation PIP M-Implants
	enumeration	0130013	documentation Polytech Health & Aesthetics
	enumeration	0130014	documentation Silimed
	enumeration	0130015	documentation Surgitek
	enumeration	0130016	documentation G&G Biotechnology
	enumeration	0130017	documentation nicht belegter Wert
	enumeration	0130018	documentation nicht belegter Wert

	<p>enumeration 0130019 documentation nicht belegter Wert</p> <p>enumeration 0130020 documentation nicht belegter Wert</p> <p>enumeration 0130021 documentation nicht belegter Wert</p> <p>enumeration 0130042 documentation sonstiger</p>
annotation	documentation Kat_BI_Hersteller
source	<pre> &lt;simpleType name="enum_0130"&gt;   &lt;annotation&gt;     &lt;documentation&gt;Kat_BI_Hersteller&lt;/documentation&gt;   &lt;/annotation&gt;   &lt;restriction base="xs:string"&gt;     &lt;enumeration value="0130001"&gt;       &lt;annotation&gt;         &lt;documentation&gt;Allergan&lt;/documentation&gt;       &lt;/annotation&gt;     &lt;/enumeration&gt;     &lt;enumeration value="0130002"&gt;       &lt;annotation&gt;         &lt;documentation&gt;Cereplas&lt;/documentation&gt;       &lt;/annotation&gt;     &lt;/enumeration&gt;     &lt;enumeration value="0130003"&gt;       &lt;annotation&gt;         &lt;documentation&gt;CUI (Cox Uphoff Implants)&lt;/documentation&gt;       &lt;/annotation&gt;     &lt;/enumeration&gt;     &lt;enumeration value="0130004"&gt;       &lt;annotation&gt;         &lt;documentation&gt;EMSI Biomedical&lt;/documentation&gt;       &lt;/annotation&gt;     &lt;/enumeration&gt;     &lt;enumeration value="0130005"&gt;       &lt;annotation&gt;         &lt;documentation&gt;Establishment labs&lt;/documentation&gt;       &lt;/annotation&gt;     &lt;/enumeration&gt;     &lt;enumeration value="0130006"&gt;       &lt;annotation&gt;         &lt;documentation&gt;Eurosilicone&lt;/documentation&gt;       &lt;/annotation&gt;     &lt;/enumeration&gt;     &lt;enumeration value="0130007"&gt;       &lt;annotation&gt;         &lt;documentation&gt;Nagor&lt;/documentation&gt;       &lt;/annotation&gt;     &lt;/enumeration&gt;     &lt;enumeration value="0130008"&gt;       &lt;annotation&gt;         &lt;documentation&gt;Groupe Sebbin&lt;/documentation&gt;       &lt;/annotation&gt;     &lt;/enumeration&gt;     &lt;enumeration value="0130009"&gt;       &lt;annotation&gt;         &lt;documentation&gt;Laboratoires Arion&lt;/documentation&gt;       &lt;/annotation&gt;     &lt;/enumeration&gt;   &lt;/restriction&gt; &lt;/simpleType&gt; </pre>

```
<enumeration value="0130010">
  <annotation>
    <documentation>Mentor</documentation>
  </annotation>
</enumeration>
<enumeration value="0130011">
  <annotation>
    <documentation>Pérouse Plastie SAS</documentation>
  </annotation>
</enumeration>
<enumeration value="0130012">
  <annotation>
    <documentation>PIP M-Implants</documentation>
  </annotation>
</enumeration>
<enumeration value="0130013">
  <annotation>
    <documentation>Polytech Health & Aesthetics</documentation>
  </annotation>
</enumeration>
<enumeration value="0130014">
  <annotation>
    <documentation>Silimed</documentation>
  </annotation>
</enumeration>
<enumeration value="0130015">
  <annotation>
    <documentation>Surgitek</documentation>
  </annotation>
</enumeration>
<enumeration value="0130016">
  <annotation>
    <documentation>G&G Biotechnology</documentation>
  </annotation>
</enumeration>
<enumeration value="0130017">
  <annotation>
    <documentation>nicht belegter Wert</documentation>
  </annotation>
</enumeration>
<enumeration value="0130018">
  <annotation>
    <documentation>nicht belegter Wert</documentation>
  </annotation>
</enumeration>
<enumeration value="0130019">
  <annotation>
    <documentation>nicht belegter Wert</documentation>
  </annotation>
</enumeration>
<enumeration value="0130020">
  <annotation>
    <documentation>nicht belegter Wert</documentation>
  </annotation>
</enumeration>
<enumeration value="0130021">
  <annotation>
    <documentation>nicht belegter Wert</documentation>
  </annotation>
</enumeration>
```

	<pre> &lt;/enumeration&gt; &lt;enumeration value="0130042"&gt;   &lt;annotation&gt;     &lt;documentation&gt;sonstiger&lt;/documentation&gt;   &lt;/annotation&gt; &lt;/enumeration&gt; &lt;/restriction&gt; &lt;/simpleType&gt; </pre>
--	---

simpleType **enum\_0131**

namespace	http://xml.ir-d.de/irdsa		
type	restriction of <b>string</b>		
properties	base xs:string		
facets	Kind	Value	Annotation
	enumeration	0131001	documentation Allergan
	enumeration	0131002	documentation Establishment labs
	enumeration	0131003	documentation Eurosilicone
	enumeration	0131004	documentation Galatea
	enumeration	0131005	documentation Integra
	enumeration	0131006	documentation Lifecell
	enumeration	0131007	documentation MBP (Medical Biomaterial Products)
	enumeration	0131008	documentation Mentor
	enumeration	0131009	documentation Novus Scientific
	enumeration	0131010	documentation pfmMedical
	enumeration	0131011	documentation nicht belegter Wert
	enumeration	0131012	documentation nicht belegter Wert
	enumeration	0131013	documentation nicht belegter Wert
	enumeration	0131014	documentation nicht belegter Wert
	enumeration	0131015	documentation nicht belegter Wert
	enumeration	0131042	documentation sonstiger
annotation	documentation Kat_BI_ZubehoerHersteller		
source	<pre> &lt;simpleType name="enum_0131"&gt;   &lt;annotation&gt;     &lt;documentation&gt;Kat_BI_ZubehoerHersteller&lt;/documentation&gt;   &lt;/annotation&gt;   &lt;restriction base="xs:string"&gt;     &lt;enumeration value="0131001"&gt;       &lt;annotation&gt;         &lt;documentation&gt;Allergan&lt;/documentation&gt;       &lt;/annotation&gt;     &lt;/enumeration&gt; </pre>		



```
<enumeration value="0131002">
  <annotation>
    <documentation>Establishment labs</documentation>
  </annotation>
</enumeration>
<enumeration value="0131003">
  <annotation>
    <documentation>Eurosilicone</documentation>
  </annotation>
</enumeration>
<enumeration value="0131004">
  <annotation>
    <documentation>Galatea</documentation>
  </annotation>
</enumeration>
<enumeration value="0131005">
  <annotation>
    <documentation>Integra</documentation>
  </annotation>
</enumeration>
<enumeration value="0131006">
  <annotation>
    <documentation>Lifecell</documentation>
  </annotation>
</enumeration>
<enumeration value="0131007">
  <annotation>
    <documentation>MBP (Medical Biomaterial Products)</documentation>
  </annotation>
</enumeration>
<enumeration value="0131008">
  <annotation>
    <documentation>Mentor</documentation>
  </annotation>
</enumeration>
<enumeration value="0131009">
  <annotation>
    <documentation>Novus Scientific</documentation>
  </annotation>
</enumeration>
<enumeration value="0131010">
  <annotation>
    <documentation>pfmMedical</documentation>
  </annotation>
</enumeration>
<enumeration value="0131011">
  <annotation>
    <documentation>nicht belegter Wert</documentation>
  </annotation>
</enumeration>
<enumeration value="0131012">
  <annotation>
    <documentation>nicht belegter Wert</documentation>
  </annotation>
</enumeration>
<enumeration value="0131013">
  <annotation>
    <documentation>nicht belegter Wert</documentation>
  </annotation>
</enumeration>
```

	<pre> &lt;/enumeration&gt; &lt;enumeration value="0131014"&gt;   &lt;annotation&gt;     &lt;documentation&gt;nicht belegter Wert&lt;/documentation&gt;   &lt;/annotation&gt; &lt;/enumeration&gt; &lt;enumeration value="0131015"&gt;   &lt;annotation&gt;     &lt;documentation&gt;nicht belegter Wert&lt;/documentation&gt;   &lt;/annotation&gt; &lt;/enumeration&gt; &lt;enumeration value="0131042"&gt;   &lt;annotation&gt;     &lt;documentation&gt;sonstiger&lt;/documentation&gt;   &lt;/annotation&gt; &lt;/enumeration&gt; &lt;/restriction&gt; &lt;/simpleType&gt; </pre>
--	---

### simpleType enum\_0190

namespace	http://xml.ir-d.de/irdsa		
type	restriction of <b>string</b>		
properties	base xs:string		
facets	Kind	Value	Annotation
	enumeration	0190001	documentation Brustimplantat
	enumeration	0190003	documentation Brustexpander
annotation	documentation Kat_BI_Artikeltyp		
source	<pre> &lt;simpleType name="enum_0190"&gt;   &lt;annotation&gt;     &lt;documentation&gt;Kat_BI_Artikeltyp&lt;/documentation&gt;   &lt;/annotation&gt;   &lt;restriction base="xs:string"&gt;     &lt;enumeration value="0190001"&gt;       &lt;annotation&gt;         &lt;documentation&gt;Brustimplantat&lt;/documentation&gt;       &lt;/annotation&gt;     &lt;/enumeration&gt;     &lt;enumeration value="0190003"&gt;       &lt;annotation&gt;         &lt;documentation&gt;Brustexpander&lt;/documentation&gt;       &lt;/annotation&gt;     &lt;/enumeration&gt;   &lt;/restriction&gt; &lt;/simpleType&gt; </pre>		

### simpleType enum\_0191

namespace	http://xml.ir-d.de/irdsa		
type	restriction of <b>string</b>		
properties	base xs:string		

facets	<table border="1"> <thead> <tr> <th>Kind</th> <th>Value</th> <th>Annotation</th> </tr> </thead> <tbody> <tr> <td>enumeration</td> <td>0191001</td> <td>documentation Netz</td> </tr> <tr> <td>enumeration</td> <td>0191002</td> <td>documentation ADM</td> </tr> </tbody> </table>	Kind	Value	Annotation	enumeration	0191001	documentation Netz	enumeration	0191002	documentation ADM
Kind	Value	Annotation								
enumeration	0191001	documentation Netz								
enumeration	0191002	documentation ADM								
annotation	documentation Kat_BI_ZubehoerTyp									
source	<pre>&lt;simpleType name="enum_0191"&gt;   &lt;annotation&gt;     &lt;documentation&gt;Kat_BI_ZubehoerTyp&lt;/documentation&gt;   &lt;/annotation&gt;   &lt;restriction base="xs:string"&gt;     &lt;enumeration value="0191001"&gt;       &lt;annotation&gt;         &lt;documentation&gt;Netz&lt;/documentation&gt;       &lt;/annotation&gt;     &lt;/enumeration&gt;     &lt;enumeration value="0191002"&gt;       &lt;annotation&gt;         &lt;documentation&gt;ADM&lt;/documentation&gt;       &lt;/annotation&gt;     &lt;/enumeration&gt;   &lt;/restriction&gt; &lt;/simpleType&gt;</pre>									

### simpleType enum\_0200

namespace	http://xml.ir-d.de/irdsa									
type	restriction of <b>string</b>									
properties	base xs:string									
facets	<table border="1"> <thead> <tr> <th>Kind</th> <th>Value</th> <th>Annotation</th> </tr> </thead> <tbody> <tr> <td>enumeration</td> <td>0200001</td> <td>documentation Erst-OP</td> </tr> <tr> <td>enumeration</td> <td>0200002</td> <td>documentation Folgeeingriff</td> </tr> </tbody> </table>	Kind	Value	Annotation	enumeration	0200001	documentation Erst-OP	enumeration	0200002	documentation Folgeeingriff
Kind	Value	Annotation								
enumeration	0200001	documentation Erst-OP								
enumeration	0200002	documentation Folgeeingriff								
annotation	documentation Kat_EP_ArtEingriff									
source	<pre>&lt;simpleType name="enum_0200"&gt;   &lt;annotation&gt;     &lt;documentation&gt;Kat_EP_ArtEingriff&lt;/documentation&gt;   &lt;/annotation&gt;   &lt;restriction base="xs:string"&gt;     &lt;enumeration value="0200001"&gt;       &lt;annotation&gt;         &lt;documentation&gt;Erst-OP&lt;/documentation&gt;       &lt;/annotation&gt;     &lt;/enumeration&gt;     &lt;enumeration value="0200002"&gt;       &lt;annotation&gt;         &lt;documentation&gt;Folgeeingriff&lt;/documentation&gt;       &lt;/annotation&gt;     &lt;/enumeration&gt;   &lt;/restriction&gt; &lt;/simpleType&gt;</pre>									

## simpleType enum\_0202

namespace	http://xml.ir-d.de/irdsa		
type	restriction of <b>string</b>		
properties	base xs:string		
facets	Kind	Value	Annotation
	enumeration	0202001	documentation Lockerung
	enumeration	0202002	documentation Infektion, Verdacht auf
	enumeration	0202003	documentation Infektion, gesichert
	enumeration	0202004	documentation Luxation, Inlay aus der Pfanne
	enumeration	0202005	documentation Luxation, Kopf aus Pfanne/Inlay
	enumeration	0202006	documentation Periprothetische Fraktur
	enumeration	0202007	documentation Verschleiß des PE-Inlays
	enumeration	0202008	documentation Implantatbruch
	enumeration	0202009	documentation Implantatfehlage/Malalignent
	enumeration	0202010	documentation Osteolysen bei festem Implantat
	enumeration	0202011	documentation Progression der Grunderkrankung
	enumeration	0202012	documentation ARMD
	enumeration	0202013	documentation Verdacht auf allergische Reaktion
	enumeration	0202021	documentation Zustand nach Prothesenentfernung
	enumeration	0202042	documentation andere Gründe
annotation	documentation Kat_EP_GrundWechselHuefte		
source	<pre> &lt;simpleType name="enum_0202"&gt;   &lt;annotation&gt;     &lt;documentation&gt;Kat_EP_GrundWechselHuefte&lt;/documentation&gt;   &lt;/annotation&gt;   &lt;restriction base="xs:string"&gt;     &lt;enumeration value="0202001"&gt;       &lt;annotation&gt;         &lt;documentation&gt;Lockerung&lt;/documentation&gt;       &lt;/annotation&gt;     &lt;/enumeration&gt;     &lt;enumeration value="0202002"&gt;       &lt;annotation&gt;         &lt;documentation&gt;Infektion, Verdacht auf&lt;/documentation&gt;       &lt;/annotation&gt;     &lt;/enumeration&gt;     &lt;enumeration value="0202003"&gt;       &lt;annotation&gt;         &lt;documentation&gt;Infektion, gesichert&lt;/documentation&gt;       &lt;/annotation&gt;     &lt;/enumeration&gt;     &lt;enumeration value="0202004"&gt;       &lt;annotation&gt;         &lt;documentation&gt;Luxation, Inlay aus der Pfanne&lt;/documentation&gt; </pre>		

```
</annotation>
</enumeration>
<enumeration value="0202005">
  <annotation>
    <documentation>Luxation, Kopf aus Pfanne/Inlay</documentation>
  </annotation>
</enumeration>
<enumeration value="0202006">
  <annotation>
    <documentation>Periprothetische Fraktur</documentation>
  </annotation>
</enumeration>
<enumeration value="0202007">
  <annotation>
    <documentation>Verschleiß des PE-Inlays</documentation>
  </annotation>
</enumeration>
<enumeration value="0202008">
  <annotation>
    <documentation>Implantatbruch</documentation>
  </annotation>
</enumeration>
<enumeration value="0202009">
  <annotation>
    <documentation>Implantatfehllage/Malalignement</documentation>
  </annotation>
</enumeration>
<enumeration value="0202010">
  <annotation>
    <documentation>Osteolysen bei festem Implantat</documentation>
  </annotation>
</enumeration>
<enumeration value="0202011">
  <annotation>
    <documentation>Progression der Grunderkrankung</documentation>
  </annotation>
</enumeration>
<enumeration value="0202012">
  <annotation>
    <documentation>ARMD</documentation>
  </annotation>
</enumeration>
<enumeration value="0202013">
  <annotation>
    <documentation>Verdacht auf allergische Reaktion</documentation>
  </annotation>
</enumeration>
<enumeration value="0202021">
  <annotation>
    <documentation>Zustand nach Prothesenentfernung</documentation>
  </annotation>
</enumeration>
<enumeration value="0202042">
  <annotation>
    <documentation>andere Gründe</documentation>
  </annotation>
</enumeration>
</restriction>
</simpleType>
```

### simpleType enum 0204

namespace	http://xml.ir-d.de/irdsa		
type	restriction of <b>string</b>		
properties	base xs:string		
facets	Kind	Value	Annotation
	enumeration	0204001	documentation Lockerung
	enumeration	0204002	documentation Infektion, Verdacht auf
	enumeration	0204003	documentation Infektion, gesichert
	enumeration	0204006	documentation Periprothetische Fraktur
	enumeration	0204007	documentation Verschleiß
	enumeration	0204008	documentation Implantatbruch
	enumeration	0204009	documentation Implantatfehlage/Malalignent
	enumeration	0204010	documentation Osteolysen bei festem Implantat
	enumeration	0204011	documentation Progression der Grunderkrankung
	enumeration	0204012	documentation ARM-D
	enumeration	0204013	documentation Verdacht auf allergische Reaktion
	enumeration	0204014	documentation Dislokation/Migration von Komponenten
	enumeration	0204015	documentation Bandinstabilität
	enumeration	0204016	documentation Bewegungseinschränkung
	enumeration	0204021	documentation Zustand nach Prothesenentfernung
	enumeration	0204042	documentation andere Gründe
annotation	documentation Kat_EP_GrundWechselKnie		
source	<pre> &lt;simpleType name="enum_0204"&gt;   &lt;annotation&gt;     &lt;documentation&gt;Kat_EP_GrundWechselKnie&lt;/documentation&gt;   &lt;/annotation&gt;   &lt;restriction base="xs:string"&gt;     &lt;enumeration value="0204001"&gt;       &lt;annotation&gt;         &lt;documentation&gt;Lockerung&lt;/documentation&gt;       &lt;/annotation&gt;     &lt;/enumeration&gt;     &lt;enumeration value="0204002"&gt;       &lt;annotation&gt;         &lt;documentation&gt;Infektion, Verdacht auf&lt;/documentation&gt;       &lt;/annotation&gt;     &lt;/enumeration&gt;     &lt;enumeration value="0204003"&gt;       &lt;annotation&gt;         &lt;documentation&gt;Infektion, gesichert&lt;/documentation&gt;       &lt;/annotation&gt;     &lt;/enumeration&gt;   &lt;/restriction&gt; &lt;/simpleType&gt; </pre>		

```
</annotation>
</enumeration>
<enumeration value="0204006">
  <annotation>
    <documentation>Periprothetische Fraktur</documentation>
  </annotation>
</enumeration>
<enumeration value="0204007">
  <annotation>
    <documentation>Verschleiß</documentation>
  </annotation>
</enumeration>
<enumeration value="0204008">
  <annotation>
    <documentation>Implantatbruch</documentation>
  </annotation>
</enumeration>
<enumeration value="0204009">
  <annotation>
    <documentation>Implantatfehllage/Malalignent</documentation>
  </annotation>
</enumeration>
<enumeration value="0204010">
  <annotation>
    <documentation>Osteolysen bei festem Implantat</documentation>
  </annotation>
</enumeration>
<enumeration value="0204011">
  <annotation>
    <documentation>Progression der Grunderkrankung</documentation>
  </annotation>
</enumeration>
<enumeration value="0204012">
  <annotation>
    <documentation>ARMD</documentation>
  </annotation>
</enumeration>
<enumeration value="0204013">
  <annotation>
    <documentation>Verdacht auf allergische Reaktion</documentation>
  </annotation>
</enumeration>
<enumeration value="0204014">
  <annotation>
    <documentation>Dislokation/Migration von Komponenten</documentation>
  </annotation>
</enumeration>
<enumeration value="0204015">
  <annotation>
    <documentation>Bandinstabilität</documentation>
  </annotation>
</enumeration>
<enumeration value="0204016">
  <annotation>
    <documentation>Bewegungseinschränkung</documentation>
  </annotation>
</enumeration>
<enumeration value="0204021">
  <annotation>
```

	<pre> &lt;documentation&gt;Zustand nach Prothesenentfernung&lt;/documentation&gt; &lt;/annotation&gt; &lt;/enumeration&gt; &lt;enumeration value="0204042"&gt;   &lt;annotation&gt;     &lt;documentation&gt;andere Gründe&lt;/documentation&gt;   &lt;/annotation&gt; &lt;/enumeration&gt; &lt;/restriction&gt; &lt;/simpleType&gt; </pre>
--	---

### simpleType enum\_0206

namespace	http://xml.ir-d.de/irdsa		
type	restriction of <b>string</b>		
properties	base xs:string		
facets	Kind	Value	Annotation
	enumeration	0206001	documentation Lockerung
	enumeration	0206002	documentation Infektion, Verdacht auf
	enumeration	0206003	documentation Infektion, gesichert
	enumeration	0206004	documentation Luxation, Inlay aus der Pfanne
	enumeration	0206005	documentation Luxation, Kopf aus Pfanne/Inlay
	enumeration	0206006	documentation Periprothetische Fraktur
	enumeration	0206007	documentation Verschleiß
	enumeration	0206008	documentation Implantatbruch
	enumeration	0206009	documentation Implantatfehlage/Malalignent
	enumeration	0206010	documentation Osteolysen bei festem Implantat
	enumeration	0206011	documentation Progression der Grunderkrankung
	enumeration	0206012	documentation ARMED
	enumeration	0206013	documentation Verdacht auf allergische Reaktion
	enumeration	0206014	documentation Dislokation/Migration von Komponenten
	enumeration	0206015	documentation Bandinstabilität
	enumeration	0206016	documentation Bewegungseinschränkung
	enumeration	0206021	documentation Zustand nach Prothesenentfernung
	enumeration	0206042	documentation andere Gründe
annotation	documentation Kat_EP_GrundWechselTFE		
source	<pre> &lt;simpleType name="enum_0206"&gt;   &lt;annotation&gt;     &lt;documentation&gt;Kat_EP_GrundWechselTFE&lt;/documentation&gt;   &lt;/annotation&gt; </pre>		



```
<restriction base="xs:string">
  <enumeration value="0206001">
    <annotation>
      <documentation>Lockerung</documentation>
    </annotation>
  </enumeration>
  <enumeration value="0206002">
    <annotation>
      <documentation>Infektion, Verdacht auf</documentation>
    </annotation>
  </enumeration>
  <enumeration value="0206003">
    <annotation>
      <documentation>Infektion, gesichert</documentation>
    </annotation>
  </enumeration>
  <enumeration value="0206004">
    <annotation>
      <documentation>Luxation, Inlay aus der Pfanne</documentation>
    </annotation>
  </enumeration>
  <enumeration value="0206005">
    <annotation>
      <documentation>Luxation, Kopf aus Pfanne/Inlay</documentation>
    </annotation>
  </enumeration>
  <enumeration value="0206006">
    <annotation>
      <documentation>Periprothetische Fraktur</documentation>
    </annotation>
  </enumeration>
  <enumeration value="0206007">
    <annotation>
      <documentation>Verschleiß</documentation>
    </annotation>
  </enumeration>
  <enumeration value="0206008">
    <annotation>
      <documentation>Implantatbruch</documentation>
    </annotation>
  </enumeration>
  <enumeration value="0206009">
    <annotation>
      <documentation>Implantatfehllage/Malalignent</documentation>
    </annotation>
  </enumeration>
  <enumeration value="0206010">
    <annotation>
      <documentation>Osteolysen bei festem Implantat</documentation>
    </annotation>
  </enumeration>
  <enumeration value="0206011">
    <annotation>
      <documentation>Progression der Grunderkrankung</documentation>
    </annotation>
  </enumeration>
  <enumeration value="0206012">
    <annotation>
      <documentation>ARMD</documentation>
    </annotation>
  </enumeration>
</restriction>
```

```

</annotation>
</enumeration>
<enumeration value="0206013">
  <annotation>
    <documentation>Verdacht auf allergische Reaktion</documentation>
  </annotation>
</enumeration>
<enumeration value="0206014">
  <annotation>
    <documentation>Dislokation/Migration von Komponenten</documentation>
  </annotation>
</enumeration>
<enumeration value="0206015">
  <annotation>
    <documentation>Bandinstabilität</documentation>
  </annotation>
</enumeration>
<enumeration value="0206016">
  <annotation>
    <documentation>Bewegungseinschränkung</documentation>
  </annotation>
</enumeration>
<enumeration value="0206021">
  <annotation>
    <documentation>Zustand nach Prothesenentfernung</documentation>
  </annotation>
</enumeration>
<enumeration value="0206042">
  <annotation>
    <documentation>andere Gründe</documentation>
  </annotation>
</enumeration>
</restriction>
</simpleType>

```

### simpleType enum 0210

namespace	http://xml.ir-d.de/irdsa		
type	restriction of <b>string</b>		
properties	base xs:string		
facets	Kind	Value	Annotation
	enumeration	0210001	documentation keine relevante Voroperation
	enumeration	0210002	documentation Osteosynthese/Osteotomie (Becken)
	enumeration	0210003	documentation Osteosynthese/Osteotomie (Femur)
	enumeration	0210004	documentation Osteosynthese/Osteotomie (beides)
	enumeration	0210005	documentation Operation bei Hüftkopfnekrose
	enumeration	0210006	documentation Arthrodese
	enumeration	0210042	documentation andere
annotation	documentation Kat_EP_VoroperationHuefte		

source	<pre> &lt;simpleType name="enum_0210"&gt;   &lt;annotation&gt;     &lt;documentation&gt;Kat_EP_VoroperationHuefte&lt;/documentation&gt;   &lt;/annotation&gt;   &lt;restriction base="xs:string"&gt;     &lt;enumeration value="0210001"&gt;       &lt;annotation&gt;         &lt;documentation&gt;keine relevante Voroperation&lt;/documentation&gt;       &lt;/annotation&gt;     &lt;/enumeration&gt;     &lt;enumeration value="0210002"&gt;       &lt;annotation&gt;         &lt;documentation&gt;Osteosynthese/Osteotomie (Becken)&lt;/documentation&gt;       &lt;/annotation&gt;     &lt;/enumeration&gt;     &lt;enumeration value="0210003"&gt;       &lt;annotation&gt;         &lt;documentation&gt;Osteosynthese/Osteotomie (Femur)&lt;/documentation&gt;       &lt;/annotation&gt;     &lt;/enumeration&gt;     &lt;enumeration value="0210004"&gt;       &lt;annotation&gt;         &lt;documentation&gt;Osteosynthese/Osteotomie (beides)&lt;/documentation&gt;       &lt;/annotation&gt;     &lt;/enumeration&gt;     &lt;enumeration value="0210005"&gt;       &lt;annotation&gt;         &lt;documentation&gt;Operation bei Hüftkopfnekrose&lt;/documentation&gt;       &lt;/annotation&gt;     &lt;/enumeration&gt;     &lt;enumeration value="0210006"&gt;       &lt;annotation&gt;         &lt;documentation&gt;Arthrodesese&lt;/documentation&gt;       &lt;/annotation&gt;     &lt;/enumeration&gt;     &lt;enumeration value="0210042"&gt;       &lt;annotation&gt;         &lt;documentation&gt;andere&lt;/documentation&gt;       &lt;/annotation&gt;     &lt;/enumeration&gt;   &lt;/restriction&gt; &lt;/simpleType&gt; </pre>
--------	---

### simpleType enum\_0211

namespace	http://xml.ir-d.de/irdsa		
type	restriction of <b>string</b>		
properties	base xs:string		
facets	Kind	Value	Annotation
	enumeration	0211001	documentation keine relevante Voroperation
	enumeration	0211002	documentation Osteosynthese/Osteotomie (Femur)
	enumeration	0211003	documentation Osteosynthese/Osteotomie (Tibia)
	enumeration	0211004	documentation Osteosynthese/Osteotomie (Patella)

	enumeration 0211005 documentation Osteosynthese/Osteotomie (mehrere) enumeration 0211006 documentation Kapsel-/Bandapparat enumeration 0211007 documentation Arthrodese enumeration 0211042 documentation andere
annotation	documentation Kat_EP_VoroperationKnie
source	<pre> &lt;simpleType name="enum_0211"&gt;   &lt;annotation&gt;     &lt;documentation&gt;Kat_EP_VoroperationKnie&lt;/documentation&gt;   &lt;/annotation&gt;   &lt;restriction base="xs:string"&gt;     &lt;enumeration value="0211001"&gt;       &lt;annotation&gt;         &lt;documentation&gt;keine relevante Voroperation&lt;/documentation&gt;       &lt;/annotation&gt;     &lt;/enumeration&gt;     &lt;enumeration value="0211002"&gt;       &lt;annotation&gt;         &lt;documentation&gt;Osteosynthese/Osteotomie (Femur)&lt;/documentation&gt;       &lt;/annotation&gt;     &lt;/enumeration&gt;     &lt;enumeration value="0211003"&gt;       &lt;annotation&gt;         &lt;documentation&gt;Osteosynthese/Osteotomie (Tibia)&lt;/documentation&gt;       &lt;/annotation&gt;     &lt;/enumeration&gt;     &lt;enumeration value="0211004"&gt;       &lt;annotation&gt;         &lt;documentation&gt;Osteosynthese/Osteotomie (Patella)&lt;/documentation&gt;       &lt;/annotation&gt;     &lt;/enumeration&gt;     &lt;enumeration value="0211005"&gt;       &lt;annotation&gt;         &lt;documentation&gt;Osteosynthese/Osteotomie (mehrere)&lt;/documentation&gt;       &lt;/annotation&gt;     &lt;/enumeration&gt;     &lt;enumeration value="0211006"&gt;       &lt;annotation&gt;         &lt;documentation&gt;Kapsel-/Bandapparat&lt;/documentation&gt;       &lt;/annotation&gt;     &lt;/enumeration&gt;     &lt;enumeration value="0211007"&gt;       &lt;annotation&gt;         &lt;documentation&gt;Arthrodese&lt;/documentation&gt;       &lt;/annotation&gt;     &lt;/enumeration&gt;     &lt;enumeration value="0211042"&gt;       &lt;annotation&gt;         &lt;documentation&gt;andere&lt;/documentation&gt;       &lt;/annotation&gt;     &lt;/enumeration&gt;   &lt;/restriction&gt; &lt;/simpleType&gt; </pre>

### simpleType enum\_0212

namespace	http://xml.ir-d.de/irdsa		
type	restriction of <b>string</b>		
properties	base xs:string		
facets	Kind	Value	Annotation
	enumeration	0212001	documentation Hüfte
	enumeration	0212002	documentation Knie
	enumeration	0212003	documentation Totaler Femurersatz inkl. Durchsteck-Prothese
annotation	documentation Kat_EP_Gelenk		
source	<pre> &lt;simpleType name="enum_0212"&gt;   &lt;annotation&gt;     &lt;documentation&gt;Kat_EP_Gelenk&lt;/documentation&gt;   &lt;/annotation&gt;   &lt;restriction base="xs:string"&gt;     &lt;enumeration value="0212001"&gt;       &lt;annotation&gt;         &lt;documentation&gt;Hüfte&lt;/documentation&gt;       &lt;/annotation&gt;     &lt;/enumeration&gt;     &lt;enumeration value="0212002"&gt;       &lt;annotation&gt;         &lt;documentation&gt;Knie&lt;/documentation&gt;       &lt;/annotation&gt;     &lt;/enumeration&gt;     &lt;enumeration value="0212003"&gt;       &lt;annotation&gt;         &lt;documentation&gt;Totaler Femurersatz inkl. Durchsteck-Prothese&lt;/documentation&gt;       &lt;/annotation&gt;     &lt;/enumeration&gt;   &lt;/restriction&gt; &lt;/simpleType&gt; </pre>		

### simpleType enum\_0220

namespace	http://xml.ir-d.de/irdsa		
type	restriction of <b>string</b>		
properties	base xs:string		
facets	Kind	Value	Annotation
	enumeration	0220001	documentation anterior
	enumeration	0220002	documentation anterolateral
	enumeration	0220003	documentation lateral
	enumeration	0220004	documentation posterior
	enumeration	0220005	documentation posterolateral
	enumeration	0220006	documentation 2-Inzisionen-Zugang
	enumeration	0220042	documentation

	sonstiges/unbekannt
annotation	documentation Kat_EP_Operationszugang
source	<pre> &lt;simpleType name="enum_0220"&gt;   &lt;annotation&gt;     &lt;documentation&gt;Kat_EP_Operationszugang&lt;/documentation&gt;   &lt;/annotation&gt;   &lt;restriction base="xs:string"&gt;     &lt;enumeration value="0220001"&gt;       &lt;annotation&gt;         &lt;documentation&gt;anterior&lt;/documentation&gt;       &lt;/annotation&gt;     &lt;/enumeration&gt;     &lt;enumeration value="0220002"&gt;       &lt;annotation&gt;         &lt;documentation&gt;anterolateral&lt;/documentation&gt;       &lt;/annotation&gt;     &lt;/enumeration&gt;     &lt;enumeration value="0220003"&gt;       &lt;annotation&gt;         &lt;documentation&gt;lateral&lt;/documentation&gt;       &lt;/annotation&gt;     &lt;/enumeration&gt;     &lt;enumeration value="0220004"&gt;       &lt;annotation&gt;         &lt;documentation&gt;posterior&lt;/documentation&gt;       &lt;/annotation&gt;     &lt;/enumeration&gt;     &lt;enumeration value="0220005"&gt;       &lt;annotation&gt;         &lt;documentation&gt;posterolateral&lt;/documentation&gt;       &lt;/annotation&gt;     &lt;/enumeration&gt;     &lt;enumeration value="0220006"&gt;       &lt;annotation&gt;         &lt;documentation&gt;2-Inzisionen-Zugang&lt;/documentation&gt;       &lt;/annotation&gt;     &lt;/enumeration&gt;     &lt;enumeration value="0220042"&gt;       &lt;annotation&gt;         &lt;documentation&gt;sonstiges/unbekannt&lt;/documentation&gt;       &lt;/annotation&gt;     &lt;/enumeration&gt;   &lt;/restriction&gt; &lt;/simpleType&gt; </pre>

### simpleType enum\_0222

namespace	http://xml.ir-d.de/irdsa		
type	restriction of <b>string</b>		
properties	base xs:string		
facets	Kind	Value	Annotation
	enumeration	0222001	documentation nein
	enumeration	0222002	documentation ja- Ausbau
	enumeration	0222003	documentation

	ja- Einbau
annotation	documentation Kat_EP_Zweizeitwechsel
source	<pre> &lt;simpleType name="enum_0222"&gt;   &lt;annotation&gt;     &lt;documentation&gt;Kat_EP_Zweizeitwechsel&lt;/documentation&gt;   &lt;/annotation&gt;   &lt;restriction base="xs:string"&gt;     &lt;enumeration value="0222001"&gt;       &lt;annotation&gt;         &lt;documentation&gt;nein&lt;/documentation&gt;       &lt;/annotation&gt;     &lt;/enumeration&gt;     &lt;enumeration value="0222002"&gt;       &lt;annotation&gt;         &lt;documentation&gt;ja- Ausbau&lt;/documentation&gt;       &lt;/annotation&gt;     &lt;/enumeration&gt;     &lt;enumeration value="0222003"&gt;       &lt;annotation&gt;         &lt;documentation&gt;ja- Einbau&lt;/documentation&gt;       &lt;/annotation&gt;     &lt;/enumeration&gt;   &lt;/restriction&gt; &lt;/simpleType&gt; </pre>

### simpleType **enum\_0230**

namespace	http://xml.ir-d.de/irdsa		
type	restriction of <b>string</b>		
properties	base	xs:string	
facets	Kind	Value	Annotation
	enumeration	0230001	documentation Smith & Nephew GmbH
	enumeration	0230002	documentation Mathys Orthopädie GmbH
	enumeration	0230003	documentation Ceramtec AG
	enumeration	0230004	documentation Biomet
	enumeration	0230005	documentation Peter Brehm GmbH
	enumeration	0230006	documentation Amplitude GmbH
	enumeration	0230007	documentation Exactech Deutschland
	enumeration	0230008	documentation Globus Medical
	enumeration	0230009	documentation Implantcast GmbH
	enumeration	0230010	documentation DePuy Orthopädie GmbH (J&J)
	enumeration	0230011	documentation IO-International Orthopaedics
	enumeration	0230012	documentation Joint Replacement Ltd. Instrumentation
	enumeration	0230013	documentation Merete
	enumeration	0230014	documentation

	enumeration	0230015	S&G Implants GmbH documentation
	enumeration	0230016	Speetec Implantate GmbH documentation
	enumeration	0230017	Stemcup Medical Products GmbH documentation
	enumeration	0230018	Symbios Deutschland GmbH documentation
	enumeration	0230019	Tantum AG documentation
	enumeration	0230020	Tomier GmbH documentation
	enumeration	0230021	MicroPort Orthopedics GmbH documentation
	enumeration	0230022	aap Implanate AG documentation
	enumeration	0230023	AQImplants documentation
	enumeration	0230024	ESKA Orthodynamics GmbH documentation
	enumeration	0230025	Atesos medical AG documentation
	enumeration	0230026	Chiropro GmbH documentation
	enumeration	0230027	Medacta documentation
	enumeration	0230028	OHST Medizintechnik AG documentation
	enumeration	0230029	Lima Deutschland GmbH documentation
	enumeration	0230030	alloPlus GmbH documentation
	enumeration	0230031	Heraeus Medical GmbH documentation
	enumeration	0230032	ImplanTec Deutschland GmbH documentation
	enumeration	0230033	Falcon Medical GmbH documentation
	enumeration	0230034	Meril GmbH documentation
	enumeration	0230035	Zimmer Germany GmbH documentation
	enumeration	0230036	Stryker GmbH & Co. KG documentation
	enumeration	0230037	Aesculap AG documentation
	enumeration	0230038	Waldemar Link GmbH & Co. KG documentation
	enumeration	0230039	Corin Germany GmbH documentation
	enumeration	0230040	ARTIQO documentation
	enumeration	0230041	EuromedImplants documentation
	enumeration	0230042	EvolutisGroup documentation
	enumeration	0230043	sonstige documentation
	enumeration	0230044	TEKNIMED SAS documentation
	enumeration	0230045	HiPer Medical AG documentation
	enumeration	0230046	Link Italia S.p.A. documentation
			Johnson & Johnson Medical GmbH



	<p>enumeration 0230047 documentation MatOrtho Limited</p> <p>enumeration 0230048 documentation Adler Ortho S.P.A.</p> <p>enumeration 0230049 documentation Lincotek Bologna SRL</p> <p>enumeration 0230050 documentation Materialise</p> <p>enumeration 0230051 documentation Maxx Orthopedics Inc.</p> <p>enumeration 0230052 documentation JRI Orthopaedics</p> <p>enumeration 0230053 documentation nicht belegter Wert</p> <p>enumeration 0230054 documentation nicht belegter Wert</p> <p>enumeration 0230055 documentation nicht belegter Wert</p> <p>enumeration 0230056 documentation nicht belegter Wert</p> <p>enumeration 0230057 documentation nicht belegter Wert</p> <p>enumeration 0230058 documentation nicht belegter Wert</p> <p>enumeration 0230059 documentation nicht belegter Wert</p>
annotation	documentation Kat_EP_Hersteller
source	<pre> &lt;simpleType name="enum_0230"&gt;   &lt;annotation&gt;     &lt;documentation&gt;Kat_EP_Hersteller&lt;/documentation&gt;   &lt;/annotation&gt;   &lt;restriction base="xs:string"&gt;     &lt;enumeration value="0230001"&gt;       &lt;annotation&gt;         &lt;documentation&gt;Smith &amp; Nephew GmbH&lt;/documentation&gt;       &lt;/annotation&gt;     &lt;/enumeration&gt;     &lt;enumeration value="0230002"&gt;       &lt;annotation&gt;         &lt;documentation&gt;Mathys Orthopädie GmbH&lt;/documentation&gt;       &lt;/annotation&gt;     &lt;/enumeration&gt;     &lt;enumeration value="0230003"&gt;       &lt;annotation&gt;         &lt;documentation&gt;Ceramtec AG&lt;/documentation&gt;       &lt;/annotation&gt;     &lt;/enumeration&gt;     &lt;enumeration value="0230004"&gt;       &lt;annotation&gt;         &lt;documentation&gt;Biomet&lt;/documentation&gt;       &lt;/annotation&gt;     &lt;/enumeration&gt;     &lt;enumeration value="0230005"&gt;       &lt;annotation&gt;         &lt;documentation&gt;Peter Brehm GmbH&lt;/documentation&gt;       &lt;/annotation&gt;     &lt;/enumeration&gt;     &lt;enumeration value="0230006"&gt;       &lt;annotation&gt;         &lt;documentation&gt;Amplitude GmbH&lt;/documentation&gt;       &lt;/annotation&gt;     &lt;/enumeration&gt;   &lt;/restriction&gt; &lt;/simpleType&gt; </pre>

```
</annotation>
</enumeration>
<enumeration value="0230007">
  <annotation>
    <documentation>Exactech Deutschland</documentation>
  </annotation>
</enumeration>
<enumeration value="0230008">
  <annotation>
    <documentation>Globus Medical</documentation>
  </annotation>
</enumeration>
<enumeration value="0230009">
  <annotation>
    <documentation>Implantcast GmbH</documentation>
  </annotation>
</enumeration>
<enumeration value="0230010">
  <annotation>
    <documentation>DePuy Orthopädie GmbH (J&J)</documentation>
  </annotation>
</enumeration>
<enumeration value="0230011">
  <annotation>
    <documentation>IO-International Orthopaedics</documentation>
  </annotation>
</enumeration>
<enumeration value="0230012">
  <annotation>
    <documentation>Joint Replacement Ltd. Instrumentation</documentation>
  </annotation>
</enumeration>
<enumeration value="0230013">
  <annotation>
    <documentation>Merete</documentation>
  </annotation>
</enumeration>
<enumeration value="0230014">
  <annotation>
    <documentation>S&G Implants GmbH</documentation>
  </annotation>
</enumeration>
<enumeration value="0230015">
  <annotation>
    <documentation>Speetec Implantate GmbH</documentation>
  </annotation>
</enumeration>
<enumeration value="0230016">
  <annotation>
    <documentation>Stemcup Medical Products GmbH</documentation>
  </annotation>
</enumeration>
<enumeration value="0230017">
  <annotation>
    <documentation>Symbios Deutschland GmbH</documentation>
  </annotation>
</enumeration>
<enumeration value="0230018">
  <annotation>
```

```
<documentation>Tantum AG</documentation>
</annotation>
</enumeration>
<enumeration value="0230019">
  <annotation>
    <documentation>Tornier GmbH</documentation>
  </annotation>
</enumeration>
<enumeration value="0230020">
  <annotation>
    <documentation>MicroPort Orthopedics GmbH</documentation>
  </annotation>
</enumeration>
<enumeration value="0230021">
  <annotation>
    <documentation>aap Implanate AG</documentation>
  </annotation>
</enumeration>
<enumeration value="0230022">
  <annotation>
    <documentation>AQImplants</documentation>
  </annotation>
</enumeration>
<enumeration value="0230023">
  <annotation>
    <documentation>ESKA Orthodynamics GmbH</documentation>
  </annotation>
</enumeration>
<enumeration value="0230024">
  <annotation>
    <documentation>Ateos medical AG</documentation>
  </annotation>
</enumeration>
<enumeration value="0230025">
  <annotation>
    <documentation>Chiropro GmbH</documentation>
  </annotation>
</enumeration>
<enumeration value="0230026">
  <annotation>
    <documentation>Medacta</documentation>
  </annotation>
</enumeration>
<enumeration value="0230027">
  <annotation>
    <documentation>OHST Medizintechnik AG</documentation>
  </annotation>
</enumeration>
<enumeration value="0230028">
  <annotation>
    <documentation>Lima Deutschland GmbH</documentation>
  </annotation>
</enumeration>
<enumeration value="0230029">
  <annotation>
    <documentation>alloPlus GmbH</documentation>
  </annotation>
</enumeration>
<enumeration value="0230030">
```

```
<annotation>
  <documentation>Heraeus Medical GmbH</documentation>
</annotation>
</enumeration>
<enumeration value="0230031">
  <annotation>
    <documentation>ImplanTec Deutschland GmbH</documentation>
  </annotation>
</enumeration>
<enumeration value="0230032">
  <annotation>
    <documentation>Falcon Medical GmbH</documentation>
  </annotation>
</enumeration>
<enumeration value="0230033">
  <annotation>
    <documentation>Meril GmbH</documentation>
  </annotation>
</enumeration>
<enumeration value="0230034">
  <annotation>
    <documentation>Zimmer Germany GmbH</documentation>
  </annotation>
</enumeration>
<enumeration value="0230035">
  <annotation>
    <documentation>Stryker GmbH & Co. KG</documentation>
  </annotation>
</enumeration>
<enumeration value="0230036">
  <annotation>
    <documentation>Aesculap AG</documentation>
  </annotation>
</enumeration>
<enumeration value="0230037">
  <annotation>
    <documentation>Waldemar Link GmbH & Co. KG</documentation>
  </annotation>
</enumeration>
<enumeration value="0230038">
  <annotation>
    <documentation>Corin Germany GmbH</documentation>
  </annotation>
</enumeration>
<enumeration value="0230039">
  <annotation>
    <documentation>ARTIQO</documentation>
  </annotation>
</enumeration>
<enumeration value="0230040">
  <annotation>
    <documentation>EuromedImplants</documentation>
  </annotation>
</enumeration>
<enumeration value="0230041">
  <annotation>
    <documentation>EvolutisGroup</documentation>
  </annotation>
</enumeration>
```

```
<enumeration value="0230042">
  <annotation>
    <documentation>sonstige</documentation>
  </annotation>
</enumeration>
<enumeration value="0230043">
  <annotation>
    <documentation>TEKNIMED SAS</documentation>
  </annotation>
</enumeration>
<enumeration value="0230044">
  <annotation>
    <documentation>HiPer Medical AG</documentation>
  </annotation>
</enumeration>
<enumeration value="0230045">
  <annotation>
    <documentation>Link Italia S.p.A.</documentation>
  </annotation>
</enumeration>
<enumeration value="0230046">
  <annotation>
    <documentation>Johnson & Johnson Medical GmbH</documentation>
  </annotation>
</enumeration>
<enumeration value="0230047">
  <annotation>
    <documentation>MatOrtho Limited</documentation>
  </annotation>
</enumeration>
<enumeration value="0230048">
  <annotation>
    <documentation>Adler Ortho S.P.A.</documentation>
  </annotation>
</enumeration>
<enumeration value="0230049">
  <annotation>
    <documentation>Lincotek Bologna SRL</documentation>
  </annotation>
</enumeration>
<enumeration value="0230050">
  <annotation>
    <documentation>Materialise</documentation>
  </annotation>
</enumeration>
<enumeration value="0230051">
  <annotation>
    <documentation>Maxx Orthopedics Inc.</documentation>
  </annotation>
</enumeration>
<enumeration value="0230052">
  <annotation>
    <documentation>JRI Orthopaedics</documentation>
  </annotation>
</enumeration>
<enumeration value="0230053">
  <annotation>
    <documentation>nicht belegter Wert</documentation>
  </annotation>
</enumeration>
```

	<pre> &lt;/enumeration&gt; &lt;enumeration value="0230054"&gt;   &lt;annotation&gt;     &lt;documentation&gt;nicht belegter Wert&lt;/documentation&gt;   &lt;/annotation&gt; &lt;/enumeration&gt; &lt;enumeration value="0230055"&gt;   &lt;annotation&gt;     &lt;documentation&gt;nicht belegter Wert&lt;/documentation&gt;   &lt;/annotation&gt; &lt;/enumeration&gt; &lt;enumeration value="0230056"&gt;   &lt;annotation&gt;     &lt;documentation&gt;nicht belegter Wert&lt;/documentation&gt;   &lt;/annotation&gt; &lt;/enumeration&gt; &lt;enumeration value="0230057"&gt;   &lt;annotation&gt;     &lt;documentation&gt;nicht belegter Wert&lt;/documentation&gt;   &lt;/annotation&gt; &lt;/enumeration&gt; &lt;enumeration value="0230058"&gt;   &lt;annotation&gt;     &lt;documentation&gt;nicht belegter Wert&lt;/documentation&gt;   &lt;/annotation&gt; &lt;/enumeration&gt; &lt;enumeration value="0230059"&gt;   &lt;annotation&gt;     &lt;documentation&gt;nicht belegter Wert&lt;/documentation&gt;   &lt;/annotation&gt; &lt;/enumeration&gt; &lt;/restriction&gt; &lt;/simpleType&gt; </pre>
--	--

### simpleType enum\_0252

namespace	http://xml.lir-d.de/irdsa		
type	restriction of <b>string</b>		
properties	base xs:string		
facets	Kind	Value	Annotation
	enumeration	0252001	documentation Pfanne
	enumeration	0252002	documentation Schaft
	enumeration	0252003	documentation beides
annotation	documentation Kat_EP_KomponenteHuefte		
source	<pre> &lt;simpleType name="enum_0252"&gt;   &lt;annotation&gt;     &lt;documentation&gt;Kat_EP_KomponenteHuefte&lt;/documentation&gt;   &lt;/annotation&gt;   &lt;restriction base="xs:string"&gt;     &lt;enumeration value="0252001"&gt;       &lt;annotation&gt;         &lt;documentation&gt;Pfanne&lt;/documentation&gt;       &lt;/annotation&gt; </pre>		

	<pre> &lt;/enumeration&gt; &lt;enumeration value="0252002"&gt;   &lt;annotation&gt;     &lt;documentation&gt;Schaft&lt;/documentation&gt;   &lt;/annotation&gt; &lt;/enumeration&gt; &lt;enumeration value="0252003"&gt;   &lt;annotation&gt;     &lt;documentation&gt;beides&lt;/documentation&gt;   &lt;/annotation&gt; &lt;/enumeration&gt; &lt;/restriction&gt; &lt;/simpleType&gt; </pre>
--	--

### simpleType enum\_0254

namespace	http://xml.ir-d.de/irdsa		
type	restriction of <b>string</b>		
properties	base xs:string		
facets	Kind	Value	Annotation
	enumeration	0254001	documentation Femur
	enumeration	0254002	documentation Tibia
	enumeration	0254003	documentation Patella
	enumeration	0254004	documentation mehrere
annotation	documentation Kat_EP_KomponenteKnie		
source	<pre> &lt;simpleType name="enum_0254"&gt;   &lt;annotation&gt;     &lt;documentation&gt;Kat_EP_KomponenteKnie&lt;/documentation&gt;   &lt;/annotation&gt;   &lt;restriction base="xs:string"&gt;     &lt;enumeration value="0254001"&gt;       &lt;annotation&gt;         &lt;documentation&gt;Femur&lt;/documentation&gt;       &lt;/annotation&gt;     &lt;/enumeration&gt;     &lt;enumeration value="0254002"&gt;       &lt;annotation&gt;         &lt;documentation&gt;Tibia&lt;/documentation&gt;       &lt;/annotation&gt;     &lt;/enumeration&gt;     &lt;enumeration value="0254003"&gt;       &lt;annotation&gt;         &lt;documentation&gt;Patella&lt;/documentation&gt;       &lt;/annotation&gt;     &lt;/enumeration&gt;     &lt;enumeration value="0254004"&gt;       &lt;annotation&gt;         &lt;documentation&gt;mehrere&lt;/documentation&gt;       &lt;/annotation&gt;     &lt;/enumeration&gt;   &lt;/restriction&gt; &lt;/simpleType&gt; </pre>		

### simpleType enum 0256

namespace	http://xml.ir-d.de/irdsa		
type	restriction of <b>string</b>		
properties	base xs:string		
facets	Kind	Value	Annotation
	enumeration	0256001	documentation Pfanne
	enumeration	0256002	documentation Schaft
	enumeration	0256003	documentation Pfanne und Schaft
	enumeration	0256004	documentation Femur
	enumeration	0256005	documentation Tibia
	enumeration	0256006	documentation Patella
	enumeration	0256007	documentation mehrere
annotation	documentation Kat_EP_KomponenteTFE		
source	<pre> &lt;simpleType name="enum_0256"&gt;   &lt;annotation&gt;     &lt;documentation&gt;Kat_EP_KomponenteTFE&lt;/documentation&gt;   &lt;/annotation&gt;   &lt;restriction base="xs:string"&gt;     &lt;enumeration value="0256001"&gt;       &lt;annotation&gt;         &lt;documentation&gt;Pfanne&lt;/documentation&gt;       &lt;/annotation&gt;     &lt;/enumeration&gt;     &lt;enumeration value="0256002"&gt;       &lt;annotation&gt;         &lt;documentation&gt;Schaft&lt;/documentation&gt;       &lt;/annotation&gt;     &lt;/enumeration&gt;     &lt;enumeration value="0256003"&gt;       &lt;annotation&gt;         &lt;documentation&gt;Pfanne und Schaft&lt;/documentation&gt;       &lt;/annotation&gt;     &lt;/enumeration&gt;     &lt;enumeration value="0256004"&gt;       &lt;annotation&gt;         &lt;documentation&gt;Femur&lt;/documentation&gt;       &lt;/annotation&gt;     &lt;/enumeration&gt;     &lt;enumeration value="0256005"&gt;       &lt;annotation&gt;         &lt;documentation&gt;Tibia&lt;/documentation&gt;       &lt;/annotation&gt;     &lt;/enumeration&gt;     &lt;enumeration value="0256006"&gt;       &lt;annotation&gt;         &lt;documentation&gt;Patella&lt;/documentation&gt;       &lt;/annotation&gt;     &lt;/enumeration&gt;   &lt;/restriction&gt; &lt;/simpleType&gt; </pre>		



	<pre> &lt;enumeration value="0256007"&gt;   &lt;annotation&gt;     &lt;documentation&gt;mehrere&lt;/documentation&gt;   &lt;/annotation&gt; &lt;/enumeration&gt; &lt;/restriction&gt; &lt;/simpleType&gt; </pre>
--	--

### simpleType enum\_0262

namespace	http://xml.ir-d.de/irdsa		
type	restriction of <b>string</b>		
properties	base xs:string		
facets	Kind	Value	Annotation
	enumeration	0262001	documentation Pfanne
	enumeration	0262002	documentation Schaft
	enumeration	0262003	documentation Kopf
	enumeration	0262004	documentation Inlay
	enumeration	0262005	documentation Adapter
	enumeration	0262006	documentation mehrere
annotation	documentation Kat_EP_ImplantatbruchHuefte		
source	<pre> &lt;simpleType name="enum_0262"&gt;   &lt;annotation&gt;     &lt;documentation&gt;Kat_EP_ImplantatbruchHuefte&lt;/documentation&gt;   &lt;/annotation&gt;   &lt;restriction base="xs:string"&gt;     &lt;enumeration value="0262001"&gt;       &lt;annotation&gt;         &lt;documentation&gt;Pfanne&lt;/documentation&gt;       &lt;/annotation&gt;     &lt;/enumeration&gt;     &lt;enumeration value="0262002"&gt;       &lt;annotation&gt;         &lt;documentation&gt;Schaft&lt;/documentation&gt;       &lt;/annotation&gt;     &lt;/enumeration&gt;     &lt;enumeration value="0262003"&gt;       &lt;annotation&gt;         &lt;documentation&gt;Kopf&lt;/documentation&gt;       &lt;/annotation&gt;     &lt;/enumeration&gt;     &lt;enumeration value="0262004"&gt;       &lt;annotation&gt;         &lt;documentation&gt;Inlay&lt;/documentation&gt;       &lt;/annotation&gt;     &lt;/enumeration&gt;     &lt;enumeration value="0262005"&gt;       &lt;annotation&gt;         &lt;documentation&gt;Adapter&lt;/documentation&gt;       &lt;/annotation&gt;     &lt;/enumeration&gt;   &lt;/restriction&gt; &lt;/simpleType&gt; </pre>		

	<pre> &lt;/enumeration&gt; &lt;enumeration value="0262006"&gt;   &lt;annotation&gt;     &lt;documentation&gt;mehrere&lt;/documentation&gt;   &lt;/annotation&gt; &lt;/enumeration&gt; &lt;/restriction&gt; &lt;/simpleType&gt; </pre>
--	---

### simpleType enum\_0264

namespace	http://xml.ir-d.de/irdsa		
type	restriction of <b>string</b>		
properties	base xs:string		
facets	Kind	Value	Annotation
	enumeration	0264001	documentation Femur
	enumeration	0264002	documentation Tibia
	enumeration	0264003	documentation Inlay
	enumeration	0264004	documentation Adapter
	enumeration	0264005	documentation Verlängerung
	enumeration	0264006	documentation Schrauben
	enumeration	0264007	documentation mehrere
	enumeration	0264042	documentation andere
annotation	documentation Kat_EP_ImplantatbruchKnie		
source	<pre> &lt;simpleType name="enum_0264"&gt;   &lt;annotation&gt;     &lt;documentation&gt;Kat_EP_ImplantatbruchKnie&lt;/documentation&gt;   &lt;/annotation&gt;   &lt;restriction base="xs:string"&gt;     &lt;enumeration value="0264001"&gt;       &lt;annotation&gt;         &lt;documentation&gt;Femur&lt;/documentation&gt;       &lt;/annotation&gt;     &lt;/enumeration&gt;     &lt;enumeration value="0264002"&gt;       &lt;annotation&gt;         &lt;documentation&gt;Tibia&lt;/documentation&gt;       &lt;/annotation&gt;     &lt;/enumeration&gt;     &lt;enumeration value="0264003"&gt;       &lt;annotation&gt;         &lt;documentation&gt;Inlay&lt;/documentation&gt;       &lt;/annotation&gt;     &lt;/enumeration&gt;     &lt;enumeration value="0264004"&gt;       &lt;annotation&gt;         &lt;documentation&gt;Adapter&lt;/documentation&gt;       &lt;/annotation&gt;     &lt;/enumeration&gt; </pre>		

	<pre> &lt;enumeration value="0264005"&gt;   &lt;annotation&gt;     &lt;documentation&gt;Verlängerung&lt;/documentation&gt;   &lt;/annotation&gt; &lt;/enumeration&gt; &lt;enumeration value="0264006"&gt;   &lt;annotation&gt;     &lt;documentation&gt;Schrauben&lt;/documentation&gt;   &lt;/annotation&gt; &lt;/enumeration&gt; &lt;enumeration value="0264007"&gt;   &lt;annotation&gt;     &lt;documentation&gt;mehrere&lt;/documentation&gt;   &lt;/annotation&gt; &lt;/enumeration&gt; &lt;enumeration value="0264042"&gt;   &lt;annotation&gt;     &lt;documentation&gt;andere&lt;/documentation&gt;   &lt;/annotation&gt; &lt;/enumeration&gt; &lt;/restriction&gt; &lt;/simpleType&gt; </pre>
--	---

### simpleType enum\_0266

namespace	http://xml.ir-d.de/irdsa		
type	restriction of <b>string</b>		
properties	base xs:string		
facets	Kind	Value	Annotation
	enumeration	0266001	documentation Pfanne
	enumeration	0266002	documentation Schaft
	enumeration	0266003	documentation Kopf
	enumeration	0266004	documentation Inlay
	enumeration	0266005	documentation Adapter
	enumeration	0266006	documentation Femur
	enumeration	0266007	documentation Tibia
	enumeration	0266008	documentation Verlängerung
	enumeration	0266009	documentation Schrauben
	enumeration	0266010	documentation mehrere
	enumeration	0266042	documentation andere
annotation	documentation Kat_EP_ImplantatbruchTFE		
source	<pre> &lt;simpleType name="enum_0266"&gt;   &lt;annotation&gt;     &lt;documentation&gt;Kat_EP_ImplantatbruchTFE&lt;/documentation&gt;   &lt;/annotation&gt; &lt;restriction base="xs:string"&gt; </pre>		

```
<enumeration value="0266001">
  <annotation>
    <documentation>Pfanne</documentation>
  </annotation>
</enumeration>
<enumeration value="0266002">
  <annotation>
    <documentation>Schaft</documentation>
  </annotation>
</enumeration>
<enumeration value="0266003">
  <annotation>
    <documentation>Kopf</documentation>
  </annotation>
</enumeration>
<enumeration value="0266004">
  <annotation>
    <documentation>Inlay</documentation>
  </annotation>
</enumeration>
<enumeration value="0266005">
  <annotation>
    <documentation>Adapter</documentation>
  </annotation>
</enumeration>
<enumeration value="0266006">
  <annotation>
    <documentation>Femur</documentation>
  </annotation>
</enumeration>
<enumeration value="0266007">
  <annotation>
    <documentation>Tibia</documentation>
  </annotation>
</enumeration>
<enumeration value="0266008">
  <annotation>
    <documentation>Verlängerung</documentation>
  </annotation>
</enumeration>
<enumeration value="0266009">
  <annotation>
    <documentation>Schrauben</documentation>
  </annotation>
</enumeration>
<enumeration value="0266010">
  <annotation>
    <documentation>mehrere</documentation>
  </annotation>
</enumeration>
<enumeration value="0266042">
  <annotation>
    <documentation>andere</documentation>
  </annotation>
</enumeration>
</restriction>
</simpleType>
```

### simpleType enum\_0270

namespace	http://xml.ir-d.de/irdsa		
type	restriction of <b>string</b>		
properties	base xs:string		
facets	Kind	Value	Annotation
	enumeration	0270001	documentation PE-Inlay
	enumeration	0270002	documentation patellare Komponente
	enumeration	0270003	documentation beides
annotation	documentation Kat EP VerschleissKnie		
source	<pre> &lt;simpleType name="enum_0270"&gt;   &lt;annotation&gt;     &lt;documentation&gt;Kat_EP_VerschleissKnie&lt;/documentation&gt;   &lt;/annotation&gt;   &lt;restriction base="xs:string"&gt;     &lt;enumeration value="0270001"&gt;       &lt;annotation&gt;         &lt;documentation&gt;PE-Inlay&lt;/documentation&gt;       &lt;/annotation&gt;     &lt;/enumeration&gt;     &lt;enumeration value="0270002"&gt;       &lt;annotation&gt;         &lt;documentation&gt;patellare Komponente&lt;/documentation&gt;       &lt;/annotation&gt;     &lt;/enumeration&gt;     &lt;enumeration value="0270003"&gt;       &lt;annotation&gt;         &lt;documentation&gt;beides&lt;/documentation&gt;       &lt;/annotation&gt;     &lt;/enumeration&gt;   &lt;/restriction&gt; &lt;/simpleType&gt; </pre>		

### simpleType enum\_0271

namespace	http://xml.ir-d.de/irdsa		
type	restriction of <b>string</b>		
properties	base xs:string		
facets	Kind	Value	Annotation
	enumeration	0271001	documentation Schraube
	enumeration	0271002	documentation Inlay
	enumeration	0271003	documentation patellare Komponente
	enumeration	0271004	documentation Kopplung
	enumeration	0271005	documentation mehrere
	enumeration	0271042	documentation andere

annotation	documentation Kat_EP_MigrationKnie
source	<pre> &lt;simpleType name="enum_0271"&gt;   &lt;annotation&gt;     &lt;documentation&gt;Kat_EP_MigrationKnie&lt;/documentation&gt;   &lt;/annotation&gt;   &lt;restriction base="xs:string"&gt;     &lt;enumeration value="0271001"&gt;       &lt;annotation&gt;         &lt;documentation&gt;Schraube&lt;/documentation&gt;       &lt;/annotation&gt;     &lt;/enumeration&gt;     &lt;enumeration value="0271002"&gt;       &lt;annotation&gt;         &lt;documentation&gt;Inlay&lt;/documentation&gt;       &lt;/annotation&gt;     &lt;/enumeration&gt;     &lt;enumeration value="0271003"&gt;       &lt;annotation&gt;         &lt;documentation&gt;patellare Komponente&lt;/documentation&gt;       &lt;/annotation&gt;     &lt;/enumeration&gt;     &lt;enumeration value="0271004"&gt;       &lt;annotation&gt;         &lt;documentation&gt;Kopplung&lt;/documentation&gt;       &lt;/annotation&gt;     &lt;/enumeration&gt;     &lt;enumeration value="0271005"&gt;       &lt;annotation&gt;         &lt;documentation&gt;mehrere&lt;/documentation&gt;       &lt;/annotation&gt;     &lt;/enumeration&gt;     &lt;enumeration value="0271042"&gt;       &lt;annotation&gt;         &lt;documentation&gt;andere&lt;/documentation&gt;       &lt;/annotation&gt;     &lt;/enumeration&gt;   &lt;/restriction&gt; &lt;/simpleType&gt; </pre>

### simpleType enum\_0290

namespace	http://xml.ir-d.de/irdsa		
type	restriction of <b>string</b>		
properties	base xs:string		
facets	Kind	Value	Annotation
	enumeration	0290001	documentation Hüft-Komponente
	enumeration	0290002	documentation Knie-Komponente
	enumeration	0290003	documentation Modulare Komponente (Hüfte/Knie)
annotation	documentation Kat_EP_Artikeltyp		
source	<pre> &lt;simpleType name="enum_0290"&gt;   &lt;annotation&gt;     &lt;documentation&gt;Kat_EP_Artikeltyp&lt;/documentation&gt; </pre>		

	<pre> &lt;/annotation&gt; &lt;restriction base="xs:string"&gt;   &lt;enumeration value="0290001"&gt;     &lt;annotation&gt;       &lt;documentation&gt;Hüft-Komponente&lt;/documentation&gt;     &lt;/annotation&gt;   &lt;/enumeration&gt;   &lt;enumeration value="0290002"&gt;     &lt;annotation&gt;       &lt;documentation&gt;Knie-Komponente&lt;/documentation&gt;     &lt;/annotation&gt;   &lt;/enumeration&gt;   &lt;enumeration value="0290003"&gt;     &lt;annotation&gt;       &lt;documentation&gt;Modulare Komponente (Hüfte/Knie)&lt;/documentation&gt;     &lt;/annotation&gt;   &lt;/enumeration&gt; &lt;/restriction&gt; &lt;/simpleType&gt; </pre>
--	--

### simpleType enum\_0291

namespace	http://xml.ir-d.de/irdsa		
type	restriction of <b>string</b>		
properties	base xs:string		
facets	Kind	Value	Annotation
	enumeration	0291001	documentation Knochen-Zement
	enumeration	0291002	documentation sonstiges Zubehör
annotation	documentation Kat_EP_ZubehoerTyp		
source	<pre> &lt;simpleType name="enum_0291"&gt;   &lt;annotation&gt;     &lt;documentation&gt;Kat_EP_ZubehoerTyp&lt;/documentation&gt;   &lt;/annotation&gt;   &lt;restriction base="xs:string"&gt;     &lt;enumeration value="0291001"&gt;       &lt;annotation&gt;         &lt;documentation&gt;Knochen-Zement&lt;/documentation&gt;       &lt;/annotation&gt;     &lt;/enumeration&gt;     &lt;enumeration value="0291002"&gt;       &lt;annotation&gt;         &lt;documentation&gt;sonstiges Zubehör&lt;/documentation&gt;       &lt;/annotation&gt;     &lt;/enumeration&gt;   &lt;/restriction&gt; &lt;/simpleType&gt; </pre>		

### simpleType enum\_0300

namespace	http://xml.ir-d.de/irdsa
type	restriction of <b>string</b>

properties	base xs:string									
facets	<table border="1"> <thead> <tr> <th>Kind</th> <th>Value</th> <th>Annotation</th> </tr> </thead> <tbody> <tr> <td>enumeration</td> <td>0300001</td> <td>documentation konventioneller Aortenklappenersatz</td> </tr> <tr> <td>enumeration</td> <td>0300002</td> <td>documentation kathetergestützte Aortenklappenimplantation (TAVI)</td> </tr> </tbody> </table>	Kind	Value	Annotation	enumeration	0300001	documentation konventioneller Aortenklappenersatz	enumeration	0300002	documentation kathetergestützte Aortenklappenimplantation (TAVI)
Kind	Value	Annotation								
enumeration	0300001	documentation konventioneller Aortenklappenersatz								
enumeration	0300002	documentation kathetergestützte Aortenklappenimplantation (TAVI)								
annotation	documentation Kat_AK_ArtEingriff									
source	<pre>&lt;simpleType name="enum_0300"&gt;   &lt;annotation&gt;     &lt;documentation&gt;Kat_AK_ArtEingriff&lt;/documentation&gt;   &lt;/annotation&gt;   &lt;restriction base="xs:string"&gt;     &lt;enumeration value="0300001"&gt;       &lt;annotation&gt;         &lt;documentation&gt;konventioneller Aortenklappenersatz&lt;/documentation&gt;       &lt;/annotation&gt;     &lt;/enumeration&gt;     &lt;enumeration value="0300002"&gt;       &lt;annotation&gt;         &lt;documentation&gt;kathetergestützte Aortenklappenimplantation (TAVI)&lt;/documentation&gt;       &lt;/annotation&gt;     &lt;/enumeration&gt;   &lt;/restriction&gt; &lt;/simpleType&gt;</pre>									

### simpleType enum\_0302

namespace	http://xml.ir-d.de/irdsa												
type	restriction of <b>string</b>												
properties	base xs:string												
facets	<table border="1"> <thead> <tr> <th>Kind</th> <th>Value</th> <th>Annotation</th> </tr> </thead> <tbody> <tr> <td>enumeration</td> <td>0302001</td> <td>documentation Stenose</td> </tr> <tr> <td>enumeration</td> <td>0302002</td> <td>documentation Insuffizienz</td> </tr> <tr> <td>enumeration</td> <td>0302003</td> <td>documentation Stenose und Insuffizienz</td> </tr> </tbody> </table>	Kind	Value	Annotation	enumeration	0302001	documentation Stenose	enumeration	0302002	documentation Insuffizienz	enumeration	0302003	documentation Stenose und Insuffizienz
Kind	Value	Annotation											
enumeration	0302001	documentation Stenose											
enumeration	0302002	documentation Insuffizienz											
enumeration	0302003	documentation Stenose und Insuffizienz											
annotation	documentation Kat_AK_GrundEingriff												
source	<pre>&lt;simpleType name="enum_0302"&gt;   &lt;annotation&gt;     &lt;documentation&gt;Kat_AK_GrundEingriff&lt;/documentation&gt;   &lt;/annotation&gt;   &lt;restriction base="xs:string"&gt;     &lt;enumeration value="0302001"&gt;       &lt;annotation&gt;         &lt;documentation&gt;Stenose&lt;/documentation&gt;       &lt;/annotation&gt;     &lt;/enumeration&gt;     &lt;enumeration value="0302002"&gt;       &lt;annotation&gt;         &lt;documentation&gt;Insuffizienz&lt;/documentation&gt;       &lt;/annotation&gt;     &lt;/enumeration&gt;   &lt;/restriction&gt; &lt;/simpleType&gt;</pre>												



	<pre> &lt;enumeration value="0302003"&gt;   &lt;annotation&gt;     &lt;documentation&gt;Stenose und Insuffizienz&lt;/documentation&gt;   &lt;/annotation&gt; &lt;/enumeration&gt; &lt;/restriction&gt; &lt;/simpleType&gt; </pre>
--	---

### simpleType enum\_0318

namespace	http://xml.ir-d.de/irdsa		
type	restriction of <b>string</b>		
properties	base xs:string		
facets	Kind	Value	Annotation
	enumeration	0318001	documentation transapikal
	enumeration	0318002	documentation transaortal
	enumeration	0318003	documentation transfemoral
	enumeration	0318004	documentation transaxillär
	enumeration	0318042	documentation anderer Zugangsweg
annotation	documentation Kat_AK_ZugangKatheter		
source	<pre> &lt;simpleType name="enum_0318"&gt;   &lt;annotation&gt;     &lt;documentation&gt;Kat_AK_ZugangKatheter&lt;/documentation&gt;   &lt;/annotation&gt;   &lt;restriction base="xs:string"&gt;     &lt;enumeration value="0318001"&gt;       &lt;annotation&gt;         &lt;documentation&gt;transapikal&lt;/documentation&gt;       &lt;/annotation&gt;     &lt;/enumeration&gt;     &lt;enumeration value="0318002"&gt;       &lt;annotation&gt;         &lt;documentation&gt;transaortal&lt;/documentation&gt;       &lt;/annotation&gt;     &lt;/enumeration&gt;     &lt;enumeration value="0318003"&gt;       &lt;annotation&gt;         &lt;documentation&gt;transfemoral&lt;/documentation&gt;       &lt;/annotation&gt;     &lt;/enumeration&gt;     &lt;enumeration value="0318004"&gt;       &lt;annotation&gt;         &lt;documentation&gt;transaxillär&lt;/documentation&gt;       &lt;/annotation&gt;     &lt;/enumeration&gt;     &lt;enumeration value="0318042"&gt;       &lt;annotation&gt;         &lt;documentation&gt;anderer Zugangsweg&lt;/documentation&gt;       &lt;/annotation&gt;     &lt;/enumeration&gt;   &lt;/restriction&gt; </pre>		

	<code>&lt;/simpleType&gt;</code>
--	----------------------------------

### simpleType enum\_0320

namespace	http://xml.ir-d.de/irdsa		
type	restriction of <b>string</b>		
properties	base xs:string		
facets	Kind	Value	Annotation
	enumeration	0320001	documentation konventionelle Sternotomie
	enumeration	0320002	documentation partielle Sternotomie
	enumeration	0320003	documentation parasternaler Zugang
	enumeration	0320042	documentation anderer Zugangsweg
annotation	documentation Kat_AK_ZugangKonventionell		
source	<pre> &lt;simpleType name="enum_0320"&gt;   &lt;annotation&gt;     &lt;documentation&gt;Kat_AK_ZugangKonventionell&lt;/documentation&gt;   &lt;/annotation&gt;   &lt;restriction base="xs:string"&gt;     &lt;enumeration value="0320001"&gt;       &lt;annotation&gt;         &lt;documentation&gt;konventionelle Sternotomie&lt;/documentation&gt;       &lt;/annotation&gt;     &lt;/enumeration&gt;     &lt;enumeration value="0320002"&gt;       &lt;annotation&gt;         &lt;documentation&gt;partielle Sternotomie&lt;/documentation&gt;       &lt;/annotation&gt;     &lt;/enumeration&gt;     &lt;enumeration value="0320003"&gt;       &lt;annotation&gt;         &lt;documentation&gt;parasternaler Zugang&lt;/documentation&gt;       &lt;/annotation&gt;     &lt;/enumeration&gt;     &lt;enumeration value="0320042"&gt;       &lt;annotation&gt;         &lt;documentation&gt;anderer Zugangsweg&lt;/documentation&gt;       &lt;/annotation&gt;     &lt;/enumeration&gt;   &lt;/restriction&gt; &lt;/simpleType&gt; </pre>		

### simpleType enum\_0322

namespace	http://xml.ir-d.de/irdsa		
type	restriction of <b>string</b>		
properties	base xs:string		
facets	Kind	Value	Annotation
	enumeration	0322001	documentation nein
	enumeration	0322002	documentation

	enumeration 0322003 ja, diätetisch behandelt documentation enumeration 0322004 ja, orale Medikation documentation enumeration 0322005 ja, mit Insulin behandelt documentation enumeration 0322099 ja, unbehandelt documentation unbekannt
annotation	documentation Kat_AK_Diabetes
source	<pre> &lt;simpleType name="enum_0322"&gt;   &lt;annotation&gt;     &lt;documentation&gt;Kat_AK_Diabetes&lt;/documentation&gt;   &lt;/annotation&gt;   &lt;restriction base="xs:string"&gt;     &lt;enumeration value="0322001"&gt;       &lt;annotation&gt;         &lt;documentation&gt;nein&lt;/documentation&gt;       &lt;/annotation&gt;     &lt;/enumeration&gt;     &lt;enumeration value="0322002"&gt;       &lt;annotation&gt;         &lt;documentation&gt;ja, diätetisch behandelt&lt;/documentation&gt;       &lt;/annotation&gt;     &lt;/enumeration&gt;     &lt;enumeration value="0322003"&gt;       &lt;annotation&gt;         &lt;documentation&gt;ja, orale Medikation&lt;/documentation&gt;       &lt;/annotation&gt;     &lt;/enumeration&gt;     &lt;enumeration value="0322004"&gt;       &lt;annotation&gt;         &lt;documentation&gt;ja, mit Insulin behandelt&lt;/documentation&gt;       &lt;/annotation&gt;     &lt;/enumeration&gt;     &lt;enumeration value="0322005"&gt;       &lt;annotation&gt;         &lt;documentation&gt;ja, unbehandelt&lt;/documentation&gt;       &lt;/annotation&gt;     &lt;/enumeration&gt;     &lt;enumeration value="0322099"&gt;       &lt;annotation&gt;         &lt;documentation&gt;unbekannt&lt;/documentation&gt;       &lt;/annotation&gt;     &lt;/enumeration&gt;   &lt;/restriction&gt; &lt;/simpleType&gt; </pre>

### simpleType enum\_0324

namespace	http://xml.ir-d.de/irdsa		
type	restriction of <b>string</b>		
properties	base xs:string		
facets	Kind enumeration	Value 0324001	Annotation documentation (I): Beschwerdefreiheit, normale körperliche Belastbarkeit

	enumeration 0324002 documentation (II): Beschwerden bei stärkerer körperlicher Belastung enumeration 0324003 documentation (III): Beschwerden bei leichter körperlicher Belastung enumeration 0324004 documentation (IV): Beschwerden in Ruhe
annotation	documentation Kat_AK_NYHA
source	<pre> &lt;simpleType name="enum_0324"&gt;   &lt;annotation&gt;     &lt;documentation&gt;Kat_AK_NYHA&lt;/documentation&gt;   &lt;/annotation&gt;   &lt;restriction base="xs:string"&gt;     &lt;enumeration value="0324001"&gt;       &lt;annotation&gt;         &lt;documentation&gt;(I): Beschwerdefreiheit, normale körperliche Belastbarkeit&lt;/documentation&gt;       &lt;/annotation&gt;     &lt;/enumeration&gt;     &lt;enumeration value="0324002"&gt;       &lt;annotation&gt;         &lt;documentation&gt;(II): Beschwerden bei stärkerer körperlicher Belastung&lt;/documentation&gt;       &lt;/annotation&gt;     &lt;/enumeration&gt;     &lt;enumeration value="0324003"&gt;       &lt;annotation&gt;         &lt;documentation&gt;(III): Beschwerden bei leichter körperlicher Belastung&lt;/documentation&gt;       &lt;/annotation&gt;     &lt;/enumeration&gt;     &lt;enumeration value="0324004"&gt;       &lt;annotation&gt;         &lt;documentation&gt;(IV): Beschwerden in Ruhe&lt;/documentation&gt;       &lt;/annotation&gt;     &lt;/enumeration&gt;   &lt;/restriction&gt; &lt;/simpleType&gt; </pre>

### simpleType enum\_0330

namespace	http://xml.ir-d.de/irdsa		
type	restriction of <b>string</b>		
properties	base xs:string		
facets	Kind	Value	Annotation
	enumeration	0330001	documentation ATS Medical
	enumeration	0330002	documentation Edwards Lifesciences
	enumeration	0330003	documentation Medtronic
	enumeration	0330004	documentation JenaValve
	enumeration	0330005	documentation Corcym
	enumeration	0330006	documentation Abbott Medical / St. Jude
	enumeration	0330007	documentation

	<p>enumeration 0330008 Symetis documentation Direct Flow Medical</p> <p>enumeration 0330009 documentation Boston Scientific</p> <p>enumeration 0330010 documentation Artivion</p> <p>enumeration 0330011 documentation Biosensors</p> <p>enumeration 0330012 documentation LivaNova</p> <p>enumeration 0330013 documentation Meril</p> <p>enumeration 0330014 documentation Sahajanand Medical Technologies</p> <p>enumeration 0330015 documentation nicht belegter Wert</p> <p>enumeration 0330016 documentation nicht belegter Wert</p> <p>enumeration 0330017 documentation nicht belegter Wert</p> <p>enumeration 0330018 documentation nicht belegter Wert</p> <p>enumeration 0330042 documentation sonstiger Hersteller</p>
annotation	documentation Kat_AK_Hersteller
source	<pre> &lt;simpleType name="enum_0330"&gt;   &lt;annotation&gt;     &lt;documentation&gt;Kat_AK_Hersteller&lt;/documentation&gt;   &lt;/annotation&gt;   &lt;restriction base="xs:string"&gt;     &lt;enumeration value="0330001"&gt;       &lt;annotation&gt;         &lt;documentation&gt;ATS Medical&lt;/documentation&gt;       &lt;/annotation&gt;     &lt;/enumeration&gt;     &lt;enumeration value="0330002"&gt;       &lt;annotation&gt;         &lt;documentation&gt;Edwards Lifesciences&lt;/documentation&gt;       &lt;/annotation&gt;     &lt;/enumeration&gt;     &lt;enumeration value="0330003"&gt;       &lt;annotation&gt;         &lt;documentation&gt;Medtronic&lt;/documentation&gt;       &lt;/annotation&gt;     &lt;/enumeration&gt;     &lt;enumeration value="0330004"&gt;       &lt;annotation&gt;         &lt;documentation&gt;JenaValve&lt;/documentation&gt;       &lt;/annotation&gt;     &lt;/enumeration&gt;     &lt;enumeration value="0330005"&gt;       &lt;annotation&gt;         &lt;documentation&gt;Corcym&lt;/documentation&gt;       &lt;/annotation&gt;     &lt;/enumeration&gt;     &lt;enumeration value="0330006"&gt;       &lt;annotation&gt;         &lt;documentation&gt;Abbott Medical / St. Jude&lt;/documentation&gt;       &lt;/annotation&gt;     &lt;/enumeration&gt;   &lt;/restriction&gt; &lt;/simpleType&gt; </pre>

```
</enumeration>
<enumeration value="0330007">
  <annotation>
    <documentation>Symetis</documentation>
  </annotation>
</enumeration>
<enumeration value="0330008">
  <annotation>
    <documentation>Direct Flow Medical</documentation>
  </annotation>
</enumeration>
<enumeration value="0330009">
  <annotation>
    <documentation>Boston Scientific</documentation>
  </annotation>
</enumeration>
<enumeration value="0330010">
  <annotation>
    <documentation>Artivion</documentation>
  </annotation>
</enumeration>
<enumeration value="0330011">
  <annotation>
    <documentation>Biosensors</documentation>
  </annotation>
</enumeration>
<enumeration value="0330012">
  <annotation>
    <documentation>LivaNova</documentation>
  </annotation>
</enumeration>
<enumeration value="0330013">
  <annotation>
    <documentation>Meril</documentation>
  </annotation>
</enumeration>
<enumeration value="0330014">
  <annotation>
    <documentation>Sahajanand Medical Technologies</documentation>
  </annotation>
</enumeration>
<enumeration value="0330015">
  <annotation>
    <documentation>nicht belegter Wert</documentation>
  </annotation>
</enumeration>
<enumeration value="0330016">
  <annotation>
    <documentation>nicht belegter Wert</documentation>
  </annotation>
</enumeration>
<enumeration value="0330017">
  <annotation>
    <documentation>nicht belegter Wert</documentation>
  </annotation>
</enumeration>
<enumeration value="0330018">
  <annotation>
    <documentation>nicht belegter Wert</documentation>
  </annotation>
</enumeration>
```

	<pre> &lt;/annotation&gt; &lt;/enumeration&gt; &lt;enumeration value="0330042"&gt;   &lt;annotation&gt;     &lt;documentation&gt;sonstiger Hersteller&lt;/documentation&gt;   &lt;/annotation&gt; &lt;/enumeration&gt; &lt;/restriction&gt; &lt;/simpleType&gt; </pre>
--	--

### simpleType enum\_0338

namespace	http://xml.ir-d.de/irdsa		
type	restriction of <b>string</b>		
properties	base xs:string		
facets	Kind	Value	Annotation
	enumeration	0338001	documentation LAD
	enumeration	0338002	documentation RCA
	enumeration	0338003	documentation RCX
	enumeration	0338004	documentation Hauptstamm
annotation	documentation Kat_AK_PCIArterien		
source	<pre> &lt;simpleType name="enum_0338"&gt;   &lt;annotation&gt;     &lt;documentation&gt;Kat_AK_PCIArterien&lt;/documentation&gt;   &lt;/annotation&gt;   &lt;restriction base="xs:string"&gt;     &lt;enumeration value="0338001"&gt;       &lt;annotation&gt;         &lt;documentation&gt;LAD&lt;/documentation&gt;       &lt;/annotation&gt;     &lt;/enumeration&gt;     &lt;enumeration value="0338002"&gt;       &lt;annotation&gt;         &lt;documentation&gt;RCA&lt;/documentation&gt;       &lt;/annotation&gt;     &lt;/enumeration&gt;     &lt;enumeration value="0338003"&gt;       &lt;annotation&gt;         &lt;documentation&gt;RCX&lt;/documentation&gt;       &lt;/annotation&gt;     &lt;/enumeration&gt;     &lt;enumeration value="0338004"&gt;       &lt;annotation&gt;         &lt;documentation&gt;Hauptstamm&lt;/documentation&gt;       &lt;/annotation&gt;     &lt;/enumeration&gt;   &lt;/restriction&gt; &lt;/simpleType&gt; </pre>		

### simpleType enum\_0339

namespace	http://xml.ir-d.de/irdsa		
type	restriction of <b>string</b>		
properties	base xs:string		
facets	Kind	Value	Annotation
	enumeration	0339001	documentation TEE
	enumeration	0339002	documentation CT
	enumeration	0339042	documentation andere
annotation	documentation Kat_AK_AnnulusMessmethode		
source	<pre> &lt;simpleType name="enum_0339"&gt;   &lt;annotation&gt;     &lt;documentation&gt;Kat_AK_AnnulusMessmethode&lt;/documentation&gt;   &lt;/annotation&gt;   &lt;restriction base="xs:string"&gt;     &lt;enumeration value="0339001"&gt;       &lt;annotation&gt;         &lt;documentation&gt;TEE&lt;/documentation&gt;       &lt;/annotation&gt;     &lt;/enumeration&gt;     &lt;enumeration value="0339002"&gt;       &lt;annotation&gt;         &lt;documentation&gt;CT&lt;/documentation&gt;       &lt;/annotation&gt;     &lt;/enumeration&gt;     &lt;enumeration value="0339042"&gt;       &lt;annotation&gt;         &lt;documentation&gt;andere&lt;/documentation&gt;       &lt;/annotation&gt;     &lt;/enumeration&gt;   &lt;/restriction&gt; &lt;/simpleType&gt; </pre>		

### simpleType enum\_0341

namespace	http://xml.ir-d.de/irdsa		
type	restriction of <b>string</b>		
properties	base xs:string		
facets	Kind	Value	Annotation
	enumeration	0341001	documentation intraprozedural verstorben
	enumeration	0341002	documentation Implantation von mehr als einer Prothese
	enumeration	0341003	documentation gravierende Gefäß- oder Zugangskomplikation (gemäß VARC-3)
	enumeration	0341004	documentation erforderlicher chirurgischer oder interventioneller Eingriff wegen einer Klappenfehlfunktion (gemäß VARC-3)
	enumeration	0341005	documentation &gt;= große strukturelle kardiale Komplikation (gemäß VARC-3)
annotation	documentation Kat_AK_FailureGrund		



source	<pre> &lt;simpleType name="enum_0341"&gt;   &lt;annotation&gt;     &lt;documentation&gt;Kat_AK_FailureGrund&lt;/documentation&gt;   &lt;/annotation&gt;   &lt;restriction base="xs:string"&gt;     &lt;enumeration value="0341001"&gt;       &lt;annotation&gt;         &lt;documentation&gt;intraprozedural verstorben&lt;/documentation&gt;       &lt;/annotation&gt;     &lt;/enumeration&gt;     &lt;enumeration value="0341002"&gt;       &lt;annotation&gt;         &lt;documentation&gt;Implantation von mehr als einer Prothese&lt;/documentation&gt;       &lt;/annotation&gt;     &lt;/enumeration&gt;     &lt;enumeration value="0341003"&gt;       &lt;annotation&gt;         &lt;documentation&gt;gravierende Gefäß- oder Zugangskomplikation (gemäß VARC-3)&lt;/documentation&gt;       &lt;/annotation&gt;     &lt;/enumeration&gt;     &lt;enumeration value="0341004"&gt;       &lt;annotation&gt;         &lt;documentation&gt;erforderlicher chirurgischer oder interventioneller Eingriff wegen einer Klappenfehlfunktion (gemäß VARC-3)&lt;/documentation&gt;       &lt;/annotation&gt;     &lt;/enumeration&gt;     &lt;enumeration value="0341005"&gt;       &lt;annotation&gt;         &lt;documentation&gt;&amp;gt;= große strukturelle kardiale Komplikation (gemäß VARC-3)&lt;/documentation&gt;       &lt;/annotation&gt;     &lt;/enumeration&gt;   &lt;/restriction&gt; &lt;/simpleType&gt; </pre>
--------	--

### simpleType enum\_0342

namespace	http://xml.ir-d.de/irdsa		
type	restriction of <b>string</b>		
properties	base xs:string		
facets	Kind	Value	Annotation
	enumeration	0342001	documentation Alter
	enumeration	0342002	documentation Frailty
	enumeration	0342003	documentation Hochrisiko
	enumeration	0342004	documentation Prognose-limitierende Zweiterkrankung
	enumeration	0342005	documentation Porzellan-Aorta
	enumeration	0342042	documentation Sonstige
annotation	documentation Kat_AK_Tavi		
source	<simpleType name="enum_0342">		

```

<annotation>
  <documentation>Kat_AK_Tavi</documentation>
</annotation>
<restriction base="xs:string">
  <enumeration value="0342001">
    <annotation>
      <documentation>Alter</documentation>
    </annotation>
  </enumeration>
  <enumeration value="0342002">
    <annotation>
      <documentation>Frailty</documentation>
    </annotation>
  </enumeration>
  <enumeration value="0342003">
    <annotation>
      <documentation>Hochrisiko</documentation>
    </annotation>
  </enumeration>
  <enumeration value="0342004">
    <annotation>
      <documentation>Prognose-limitierende Zweiterkrankung</documentation>
    </annotation>
  </enumeration>
  <enumeration value="0342005">
    <annotation>
      <documentation>Porzellan-Aorta</documentation>
    </annotation>
  </enumeration>
  <enumeration value="0342042">
    <annotation>
      <documentation>Sonstige</documentation>
    </annotation>
  </enumeration>
</restriction>
</simpleType>

```

### simpleType enum 0343

namespace	http://xml.ir-d.de/irdsa		
type	restriction of <b>string</b>		
properties	base xs:string		
facets	Kind	Value	Annotation
	enumeration	0343001	documentation Device-Fehlpositionierung
	enumeration	0343002	documentation Koronarostienverschluss
	enumeration	0343003	documentation Aortendissektion
	enumeration	0343004	documentation Aortenregurgitation &gt; = 2. Grades
	enumeration	0343005	documentation Annulus-Ruptur
	enumeration	0343006	documentation Ruptur-/Perforation einer Herzhöhle ohne Therapiebedarf
	enumeration	0343007	documentation Ruptur-/Perforation einer Herzhöhle mit Therapiebedarf
	enumeration	0343008	documentation

	<p>enumeration 0343009 Perikardtamponade documentation kardiale Dekompensation</p> <p>enumeration 0343010 documentation Himembolie</p> <p>enumeration 0343011 documentation Rhythmusstörungen</p> <p>enumeration 0343012 documentation Device-Embolisation</p> <p>enumeration 0343013 documentation vaskuläre Komplikation</p> <p>enumeration 0343014 documentation Low Cardiac Output</p> <p>enumeration 0343015 documentation schwerwiegende Blutungen (intraprozedural)</p> <p>enumeration 0343016 documentation lebensbedrohliche Blutungen (intraprozedural)</p> <p>enumeration 0343017 documentation Patient verstarb im OP/Katheterlabor</p> <p>enumeration 0343042 documentation sonstige intraprozedurale Komplikationen</p>
annotation	documentation Kat_AK_KomplikationTyp
source	<pre> &lt;simpleType name="enum_0343"&gt;   &lt;annotation&gt;     &lt;documentation&gt;Kat_AK_KomplikationTyp&lt;/documentation&gt;   &lt;/annotation&gt;   &lt;restriction base="xs:string"&gt;     &lt;enumeration value="0343001"&gt;       &lt;annotation&gt;         &lt;documentation&gt;Device-Fehlpositionierung&lt;/documentation&gt;       &lt;/annotation&gt;     &lt;/enumeration&gt;     &lt;enumeration value="0343002"&gt;       &lt;annotation&gt;         &lt;documentation&gt;Koronarostienverschluss&lt;/documentation&gt;       &lt;/annotation&gt;     &lt;/enumeration&gt;     &lt;enumeration value="0343003"&gt;       &lt;annotation&gt;         &lt;documentation&gt;Aortendissektion&lt;/documentation&gt;       &lt;/annotation&gt;     &lt;/enumeration&gt;     &lt;enumeration value="0343004"&gt;       &lt;annotation&gt;         &lt;documentation&gt;Aortenregurgitation &amp;gt; = 2. Grades&lt;/documentation&gt;       &lt;/annotation&gt;     &lt;/enumeration&gt;     &lt;enumeration value="0343005"&gt;       &lt;annotation&gt;         &lt;documentation&gt;Annulus-Ruptur&lt;/documentation&gt;       &lt;/annotation&gt;     &lt;/enumeration&gt;     &lt;enumeration value="0343006"&gt;       &lt;annotation&gt;         &lt;documentation&gt;Ruptur-/Perforation einer Herzhöhle ohne Therapiebedarf&lt;/documentation&gt;       &lt;/annotation&gt;     &lt;/enumeration&gt;     &lt;enumeration value="0343007"&gt;       &lt;annotation&gt; </pre>

```

    <documentation>Ruptur-/Perforation einer Herzhöhle mit
Therapiebedarf</documentation>
  </annotation>
</enumeration>
<enumeration value="0343008">
  <annotation>
    <documentation>Perikardtamponade</documentation>
  </annotation>
</enumeration>
<enumeration value="0343009">
  <annotation>
    <documentation>kardiale Dekompensation</documentation>
  </annotation>
</enumeration>
<enumeration value="0343010">
  <annotation>
    <documentation>Hirnembolie</documentation>
  </annotation>
</enumeration>
<enumeration value="0343011">
  <annotation>
    <documentation>Rhythmusstörungen</documentation>
  </annotation>
</enumeration>
<enumeration value="0343012">
  <annotation>
    <documentation>Device-Embolisation</documentation>
  </annotation>
</enumeration>
<enumeration value="0343013">
  <annotation>
    <documentation>vaskuläre Komplikation</documentation>
  </annotation>
</enumeration>
<enumeration value="0343014">
  <annotation>
    <documentation>Low Cardiac Output</documentation>
  </annotation>
</enumeration>
<enumeration value="0343015">
  <annotation>
    <documentation>schwerwiegende Blutungen
(intraprozedural)</documentation>
  </annotation>
</enumeration>
<enumeration value="0343016">
  <annotation>
    <documentation>lebensbedrohliche Blutungen
(intraprozedural)</documentation>
  </annotation>
</enumeration>
<enumeration value="0343017">
  <annotation>
    <documentation>Patient verstarb im OP/Katheterlabor</documentation>
  </annotation>
</enumeration>
<enumeration value="0343042">
  <annotation>
    <documentation>sonstige intraprozedurale

```

	<pre> Komplikationen&lt;/documentation&gt;   &lt;/annotation&gt; &lt;/enumeration&gt; &lt;/restriction&gt; &lt;/simpleType&gt; </pre>
--	---

### simpleType enum\_0346

namespace	http://xml.ir-d.de/irdsa		
type	restriction of <b>string</b>		
properties	base xs:string		
facets	Kind	Value	Annotation
	enumeration	0346001	documentation keine Therapie erforderlich
	enumeration	0346002	documentation medikamentös
	enumeration	0346003	documentation IABP
	enumeration	0346004	documentation VAD
	enumeration	0346005	documentation ECMO
	enumeration	0346042	documentation sonstige
annotation	documentation Kat_AK_TherapieLCO		
source	<pre> &lt;simpleType name="enum_0346"&gt;   &lt;annotation&gt;     &lt;documentation&gt;Kat_AK_TherapieLCO&lt;/documentation&gt;   &lt;/annotation&gt;   &lt;restriction base="xs:string"&gt;     &lt;enumeration value="0346001"&gt;       &lt;annotation&gt;         &lt;documentation&gt;keine Therapie erforderlich&lt;/documentation&gt;       &lt;/annotation&gt;     &lt;/enumeration&gt;     &lt;enumeration value="0346002"&gt;       &lt;annotation&gt;         &lt;documentation&gt;medikamentös&lt;/documentation&gt;       &lt;/annotation&gt;     &lt;/enumeration&gt;     &lt;enumeration value="0346003"&gt;       &lt;annotation&gt;         &lt;documentation&gt;IABP&lt;/documentation&gt;       &lt;/annotation&gt;     &lt;/enumeration&gt;     &lt;enumeration value="0346004"&gt;       &lt;annotation&gt;         &lt;documentation&gt;VAD&lt;/documentation&gt;       &lt;/annotation&gt;     &lt;/enumeration&gt;     &lt;enumeration value="0346005"&gt;       &lt;annotation&gt;         &lt;documentation&gt;ECMO&lt;/documentation&gt;       &lt;/annotation&gt;     &lt;/enumeration&gt;     &lt;enumeration value="0346042"&gt; </pre>		

	<pre> &lt;annotation&gt;   &lt;documentation&gt;sonstige&lt;/documentation&gt; &lt;/annotation&gt; &lt;/enumeration&gt; &lt;/restriction&gt; &lt;/simpleType&gt; </pre>
--	---

### simpleType enum\_0347

namespace	http://xml.ir-d.de/irdsa		
type	restriction of <b>string</b>		
properties	base xs:string		
facets	Kind	Value	Annotation
	enumeration	0347001	documentation Einzeleingriff
	enumeration	0347002	documentation Kombinationseingriff mit mehreren Prozeduren
annotation	documentation Kat_AK_Eingriffsumfang		
source	<pre> &lt;simpleType name="enum_0347"&gt;   &lt;annotation&gt;     &lt;documentation&gt;Kat_AK_Eingriffsumfang&lt;/documentation&gt;   &lt;/annotation&gt;   &lt;restriction base="xs:string"&gt;     &lt;enumeration value="0347001"&gt;       &lt;annotation&gt;         &lt;documentation&gt;Einzeleingriff&lt;/documentation&gt;       &lt;/annotation&gt;     &lt;/enumeration&gt;     &lt;enumeration value="0347002"&gt;       &lt;annotation&gt;         &lt;documentation&gt;Kombinationseingriff mit mehreren Prozeduren&lt;/documentation&gt;       &lt;/annotation&gt;     &lt;/enumeration&gt;   &lt;/restriction&gt; &lt;/simpleType&gt; </pre>		

### simpleType enum\_0348

namespace	http://xml.ir-d.de/irdsa		
type	restriction of <b>string</b>		
properties	base xs:string		
facets	Kind	Value	Annotation
	enumeration	0348001	documentation mit HLM
	enumeration	0348002	documentation ohne HLM
	enumeration	0348003	documentation Umstieg von OP ohne HLM auf OP mit HLM
annotation	documentation Kat_AK_OPVorgehen		
source	<pre> &lt;simpleType name="enum_0348"&gt;   &lt;annotation&gt; </pre>		

	<pre> &lt;documentation&gt;Kat_AK_OPVorgehen&lt;/documentation&gt; &lt;/annotation&gt; &lt;restriction base="xs:string"&gt;   &lt;enumeration value="0348001"&gt;     &lt;annotation&gt;       &lt;documentation&gt;mit HLM&lt;/documentation&gt;     &lt;/annotation&gt;   &lt;/enumeration&gt;   &lt;enumeration value="0348002"&gt;     &lt;annotation&gt;       &lt;documentation&gt;ohne HLM&lt;/documentation&gt;     &lt;/annotation&gt;   &lt;/enumeration&gt;   &lt;enumeration value="0348003"&gt;     &lt;annotation&gt;       &lt;documentation&gt;Umstieg von OP ohne HLM auf OP mit HLM&lt;/documentation&gt;     &lt;/annotation&gt;   &lt;/enumeration&gt; &lt;/restriction&gt; &lt;/simpleType&gt; </pre>
--	--

### simpleType enum\_0350

namespace	http://xml.ir-d.de/irdsa		
type	restriction of <b>string</b>		
properties	base xs:string		
facets	Kind	Value	Annotation
	enumeration	0350001	documentation IABP
	enumeration	0350002	documentation Impella
	enumeration	0350003	documentation vv ECMO
	enumeration	0350004	documentation va ECMO
	enumeration	0350042	documentation andere
annotation	documentation Kat_AK_Methode		
source	<pre> &lt;simpleType name="enum_0350"&gt;   &lt;annotation&gt;     &lt;documentation&gt;Kat_AK_Methode&lt;/documentation&gt;   &lt;/annotation&gt;   &lt;restriction base="xs:string"&gt;     &lt;enumeration value="0350001"&gt;       &lt;annotation&gt;         &lt;documentation&gt;IABP&lt;/documentation&gt;       &lt;/annotation&gt;     &lt;/enumeration&gt;     &lt;enumeration value="0350002"&gt;       &lt;annotation&gt;         &lt;documentation&gt;Impella&lt;/documentation&gt;       &lt;/annotation&gt;     &lt;/enumeration&gt;     &lt;enumeration value="0350003"&gt;       &lt;annotation&gt;         &lt;documentation&gt;vv ECMO&lt;/documentation&gt; </pre>		

	<pre> &lt;/annotation&gt; &lt;/enumeration&gt; &lt;enumeration value="0350004"&gt;   &lt;annotation&gt;     &lt;documentation&gt;va ECMO&lt;/documentation&gt;   &lt;/annotation&gt; &lt;/enumeration&gt; &lt;enumeration value="0350042"&gt;   &lt;annotation&gt;     &lt;documentation&gt;andere&lt;/documentation&gt;   &lt;/annotation&gt; &lt;/enumeration&gt; &lt;/restriction&gt; &lt;/simpleType&gt; </pre>
--	---

### simpleType enum\_0351

namespace	http://xml.lir-d.de/irdsa		
type	restriction of <b>string</b>		
properties	base xs:string		
facets	Kind	Value	Annotation
	enumeration	0351001	documentation nein
	enumeration	0351002	documentation ja, zu Sternotomie
	enumeration	0351003	documentation ja, zu transapikal
	enumeration	0351004	documentation ja, zu transaortal
	enumeration	0351005	documentation ja, zu transfemoral
	enumeration	0351006	documentation ja, zu transaxillär
	enumeration	0351007	documentation ja, zu anderem endovaskulären Zugang
	enumeration	0351042	documentation ja, zu anderem Zugang
annotation	documentation Kat_AK_Konversion		
source	<pre> &lt;simpleType name="enum_0351"&gt;   &lt;annotation&gt;     &lt;documentation&gt;Kat_AK_Konversion&lt;/documentation&gt;   &lt;/annotation&gt;   &lt;restriction base="xs:string"&gt;     &lt;enumeration value="0351001"&gt;       &lt;annotation&gt;         &lt;documentation&gt;nein&lt;/documentation&gt;       &lt;/annotation&gt;     &lt;/enumeration&gt;     &lt;enumeration value="0351002"&gt;       &lt;annotation&gt;         &lt;documentation&gt;ja, zu Sternotomie&lt;/documentation&gt;       &lt;/annotation&gt;     &lt;/enumeration&gt;     &lt;enumeration value="0351003"&gt;       &lt;annotation&gt;         &lt;documentation&gt;ja, zu transapikal&lt;/documentation&gt;       &lt;/annotation&gt;     &lt;/enumeration&gt;   &lt;/restriction&gt; &lt;/simpleType&gt; </pre>		



	<pre> &lt;/enumeration&gt; &lt;enumeration value="0351004"&gt;   &lt;annotation&gt;     &lt;documentation&gt;ja, zu transaortal&lt;/documentation&gt;   &lt;/annotation&gt; &lt;/enumeration&gt; &lt;enumeration value="0351005"&gt;   &lt;annotation&gt;     &lt;documentation&gt;ja, zu transfemoral&lt;/documentation&gt;   &lt;/annotation&gt; &lt;/enumeration&gt; &lt;enumeration value="0351006"&gt;   &lt;annotation&gt;     &lt;documentation&gt;ja, zu transaxillär&lt;/documentation&gt;   &lt;/annotation&gt; &lt;/enumeration&gt; &lt;enumeration value="0351007"&gt;   &lt;annotation&gt;     &lt;documentation&gt;ja, zu anderem endovaskulären Zugang&lt;/documentation&gt;   &lt;/annotation&gt; &lt;/enumeration&gt; &lt;enumeration value="0351042"&gt;   &lt;annotation&gt;     &lt;documentation&gt;ja, zu anderem Zugang&lt;/documentation&gt;   &lt;/annotation&gt; &lt;/enumeration&gt; &lt;/restriction&gt; &lt;/simpleType&gt; </pre>
--	---

### simpleType enum\_0352

namespace	http://xml.ir-d.de/irdsa		
type	restriction of <b>string</b>		
properties	base xs:string		
facets	Kind	Value	Annotation
	enumeration	0352001	documentation nein
	enumeration	0352002	documentation ja, Intubationsnarkose
	enumeration	0352003	documentation ja, Maskenbeatmung, incl. LAMA
	enumeration	0352042	documentation ja, unbekannt welche
annotation	documentation Kat_AK_Anaesthesie		
source	<pre> &lt;simpleType name="enum_0352"&gt;   &lt;annotation&gt;     &lt;documentation&gt;Kat_AK_Anaesthesie&lt;/documentation&gt;   &lt;/annotation&gt;   &lt;restriction base="xs:string"&gt;     &lt;enumeration value="0352001"&gt;       &lt;annotation&gt;         &lt;documentation&gt;nein&lt;/documentation&gt;       &lt;/annotation&gt;     &lt;/enumeration&gt;     &lt;enumeration value="0352002"&gt;       &lt;annotation&gt; </pre>		

	<pre>       &lt;documentation&gt;ja, Intubationsnarkose&lt;/documentation&gt;     &lt;/annotation&gt;   &lt;/enumeration&gt;   &lt;enumeration value="0352003"&gt;     &lt;annotation&gt;       &lt;documentation&gt;ja, Maskenbeatmung, incl. LAMA&lt;/documentation&gt;     &lt;/annotation&gt;   &lt;/enumeration&gt;   &lt;enumeration value="0352042"&gt;     &lt;annotation&gt;       &lt;documentation&gt;ja, unbekannt welche&lt;/documentation&gt;     &lt;/annotation&gt;   &lt;/enumeration&gt; &lt;/restriction&gt; &lt;/simpleType&gt; </pre>
--	--

### simpleType enum 0353

namespace	http://xml.ir-d.de/irdsa		
type	restriction of <b>string</b>		
properties	base xs:string		
facets	Kind	Value	Annotation
	enumeration	0353001	documentation keine
	enumeration	0353002	documentation leichtgradig
	enumeration	0353003	documentation mittelgradig
	enumeration	0353004	documentation hochgradig
	enumeration	0353099	documentation nicht bestimmbar
annotation	documentation Kat_AK_ResidualeArteninsuffizienz		
source	<pre> &lt;simpleType name="enum_0353"&gt;   &lt;annotation&gt;     &lt;documentation&gt;Kat_AK_ResidualeArteninsuffizienz&lt;/documentation&gt;   &lt;/annotation&gt;   &lt;restriction base="xs:string"&gt;     &lt;enumeration value="0353001"&gt;       &lt;annotation&gt;         &lt;documentation&gt;keine&lt;/documentation&gt;       &lt;/annotation&gt;     &lt;/enumeration&gt;     &lt;enumeration value="0353002"&gt;       &lt;annotation&gt;         &lt;documentation&gt;leichtgradig&lt;/documentation&gt;       &lt;/annotation&gt;     &lt;/enumeration&gt;     &lt;enumeration value="0353003"&gt;       &lt;annotation&gt;         &lt;documentation&gt;mittelgradig&lt;/documentation&gt;       &lt;/annotation&gt;     &lt;/enumeration&gt;     &lt;enumeration value="0353004"&gt;       &lt;annotation&gt;         &lt;documentation&gt;hochgradig&lt;/documentation&gt;       &lt;/annotation&gt;     &lt;/enumeration&gt;   &lt;/restriction&gt; &lt;/simpleType&gt; </pre>		

	<pre> &lt;/annotation&gt; &lt;/enumeration&gt; &lt;enumeration value="0353099"&gt;   &lt;annotation&gt;     &lt;documentation&gt;nicht bestimmbar&lt;/documentation&gt;   &lt;/annotation&gt; &lt;/enumeration&gt; &lt;/restriction&gt; &lt;/simpleType&gt; </pre>
--	--

### simpleType enum\_0354

namespace	http://xml.ir-d.de/irdsa		
type	restriction of <b>string</b>		
properties	base xs:string		
facets	Kind	Value	Annotation
	enumeration	0354001	documentation chirurgisch-offen
	enumeration	0354002	documentation Verschluss-System
	enumeration	0354042	documentation sonstige
annotation	documentation Kat AK Zugangswegverschluss		
source	<pre> &lt;simpleType name="enum_0354"&gt;   &lt;annotation&gt;     &lt;documentation&gt;Kat_AK_Zugangswegverschluss&lt;/documentation&gt;   &lt;/annotation&gt;   &lt;restriction base="xs:string"&gt;     &lt;enumeration value="0354001"&gt;       &lt;annotation&gt;         &lt;documentation&gt;chirurgisch-offen&lt;/documentation&gt;       &lt;/annotation&gt;     &lt;/enumeration&gt;     &lt;enumeration value="0354002"&gt;       &lt;annotation&gt;         &lt;documentation&gt;Verschluss-System&lt;/documentation&gt;       &lt;/annotation&gt;     &lt;/enumeration&gt;     &lt;enumeration value="0354042"&gt;       &lt;annotation&gt;         &lt;documentation&gt;sonstige&lt;/documentation&gt;       &lt;/annotation&gt;     &lt;/enumeration&gt;   &lt;/restriction&gt; &lt;/simpleType&gt; </pre>		

### simpleType enum\_0357

namespace	http://xml.ir-d.de/irdsa		
type	restriction of <b>string</b>		
properties	base xs:string		
facets	Kind	Value	Annotation
	enumeration	0357001	documentation

	<p>enumeration 0357002 keine KHK documentation 1-Gefäßerkrankung</p> <p>enumeration 0357003 documentation 2-Gefäßerkrankung</p> <p>enumeration 0357004 documentation 3-Gefäßerkrankung</p> <p>enumeration 0357005 documentation keine koronare Bildgebung</p>
annotation	documentation Kat_AK_BefundBildgebung
source	<pre> &lt;simpleType name="enum_0357"&gt;   &lt;annotation&gt;     &lt;documentation&gt;Kat_AK_BefundBildgebung&lt;/documentation&gt;   &lt;/annotation&gt;   &lt;restriction base="xs:string"&gt;     &lt;enumeration value="0357001"&gt;       &lt;annotation&gt;         &lt;documentation&gt;keine KHK&lt;/documentation&gt;       &lt;/annotation&gt;     &lt;/enumeration&gt;     &lt;enumeration value="0357002"&gt;       &lt;annotation&gt;         &lt;documentation&gt;1-Gefäßerkrankung&lt;/documentation&gt;       &lt;/annotation&gt;     &lt;/enumeration&gt;     &lt;enumeration value="0357003"&gt;       &lt;annotation&gt;         &lt;documentation&gt;2-Gefäßerkrankung&lt;/documentation&gt;       &lt;/annotation&gt;     &lt;/enumeration&gt;     &lt;enumeration value="0357004"&gt;       &lt;annotation&gt;         &lt;documentation&gt;3-Gefäßerkrankung&lt;/documentation&gt;       &lt;/annotation&gt;     &lt;/enumeration&gt;     &lt;enumeration value="0357005"&gt;       &lt;annotation&gt;         &lt;documentation&gt;keine koronare Bildgebung&lt;/documentation&gt;       &lt;/annotation&gt;     &lt;/enumeration&gt;   &lt;/restriction&gt; &lt;/simpleType&gt; </pre>

### simpleType enum\_0358

namespace	http://xml.ir-d.de/irdsa		
type	restriction of <b>string</b>		
properties	base xs:string		
facets	Kind	Value	Annotation
	enumeration	0358001	documentation 0
	enumeration	0358002	documentation 1
	enumeration	0358003	documentation 2
	enumeration	0358004	documentation 3

	<p>enumeration 0358005 documentation 4</p> <p>enumeration 0358006 documentation 5 oder mehr</p> <p>enumeration 0358098 documentation genaue Anzahl unbekannt (aber mind. 1)</p> <p>enumeration 0358099 documentation unbekannt</p>
annotation	documentation Kat_AK_AnzahlVorOP
source	<pre> &lt;simpleType name="enum_0358"&gt;   &lt;annotation&gt;     &lt;documentation&gt;Kat_AK_AnzahlVorOP&lt;/documentation&gt;   &lt;/annotation&gt;   &lt;restriction base="xs:string"&gt;     &lt;enumeration value="0358001"&gt;       &lt;annotation&gt;         &lt;documentation&gt;0&lt;/documentation&gt;       &lt;/annotation&gt;     &lt;/enumeration&gt;     &lt;enumeration value="0358002"&gt;       &lt;annotation&gt;         &lt;documentation&gt;1&lt;/documentation&gt;       &lt;/annotation&gt;     &lt;/enumeration&gt;     &lt;enumeration value="0358003"&gt;       &lt;annotation&gt;         &lt;documentation&gt;2&lt;/documentation&gt;       &lt;/annotation&gt;     &lt;/enumeration&gt;     &lt;enumeration value="0358004"&gt;       &lt;annotation&gt;         &lt;documentation&gt;3&lt;/documentation&gt;       &lt;/annotation&gt;     &lt;/enumeration&gt;     &lt;enumeration value="0358005"&gt;       &lt;annotation&gt;         &lt;documentation&gt;4&lt;/documentation&gt;       &lt;/annotation&gt;     &lt;/enumeration&gt;     &lt;enumeration value="0358006"&gt;       &lt;annotation&gt;         &lt;documentation&gt;5 oder mehr&lt;/documentation&gt;       &lt;/annotation&gt;     &lt;/enumeration&gt;     &lt;enumeration value="0358098"&gt;       &lt;annotation&gt;         &lt;documentation&gt;genaue Anzahl unbekannt (aber mind. 1)&lt;/documentation&gt;       &lt;/annotation&gt;     &lt;/enumeration&gt;     &lt;enumeration value="0358099"&gt;       &lt;annotation&gt;         &lt;documentation&gt;unbekannt&lt;/documentation&gt;       &lt;/annotation&gt;     &lt;/enumeration&gt;   &lt;/restriction&gt; &lt;/simpleType&gt; </pre>

### simpleType enum\_0359

namespace	http://xml.ir-d.de/irdsa		
type	restriction of <b>string</b>		
properties	base xs:string		
facets	Kind	Value	Annotation
	enumeration	0359001	documentation nein
	enumeration	0359002	documentation ja - einseitig
	enumeration	0359003	documentation ja - beidseitig
	enumeration	0359042	documentation unbekannt
annotation	documentation Kat_AK_LVOT		
source	<pre> &lt;simpleType name="enum_0359"&gt;   &lt;annotation&gt;     &lt;documentation&gt;Kat_AK_LVOT&lt;/documentation&gt;   &lt;/annotation&gt;   &lt;restriction base="xs:string"&gt;     &lt;enumeration value="0359001"&gt;       &lt;annotation&gt;         &lt;documentation&gt;nein&lt;/documentation&gt;       &lt;/annotation&gt;     &lt;/enumeration&gt;     &lt;enumeration value="0359002"&gt;       &lt;annotation&gt;         &lt;documentation&gt;ja - einseitig&lt;/documentation&gt;       &lt;/annotation&gt;     &lt;/enumeration&gt;     &lt;enumeration value="0359003"&gt;       &lt;annotation&gt;         &lt;documentation&gt;ja - beidseitig&lt;/documentation&gt;       &lt;/annotation&gt;     &lt;/enumeration&gt;     &lt;enumeration value="0359042"&gt;       &lt;annotation&gt;         &lt;documentation&gt;unbekannt&lt;/documentation&gt;       &lt;/annotation&gt;     &lt;/enumeration&gt;   &lt;/restriction&gt; &lt;/simpleType&gt; </pre>		

### simpleType enum\_0360

namespace	http://xml.ir-d.de/irdsa		
type	restriction of <b>string</b>		
properties	base xs:string		
facets	Kind	Value	Annotation
	enumeration	0360001	documentation keine
	enumeration	0360002	documentation leichtgradig
	enumeration	0360003	documentation mittelgradig
	enumeration	0360004	documentation

	<p>enumeration 0360005 hochgradig documentation massive</p> <p>enumeration 0360006 documentation torrential</p> <p>enumeration 0360099 documentation unbekannt</p>
annotation	documentation Kat_AK_TriskupidalInsuffizienz
source	<pre> &lt;simpleType name="enum_0360"&gt;   &lt;annotation&gt;     &lt;documentation&gt;Kat_AK_TriskupidalInsuffizienz&lt;/documentation&gt;   &lt;/annotation&gt;   &lt;restriction base="xs:string"&gt;     &lt;enumeration value="0360001"&gt;       &lt;annotation&gt;         &lt;documentation&gt;keine&lt;/documentation&gt;       &lt;/annotation&gt;     &lt;/enumeration&gt;     &lt;enumeration value="0360002"&gt;       &lt;annotation&gt;         &lt;documentation&gt;leichtgradig&lt;/documentation&gt;       &lt;/annotation&gt;     &lt;/enumeration&gt;     &lt;enumeration value="0360003"&gt;       &lt;annotation&gt;         &lt;documentation&gt;mittelgradig&lt;/documentation&gt;       &lt;/annotation&gt;     &lt;/enumeration&gt;     &lt;enumeration value="0360004"&gt;       &lt;annotation&gt;         &lt;documentation&gt;hochgradig&lt;/documentation&gt;       &lt;/annotation&gt;     &lt;/enumeration&gt;     &lt;enumeration value="0360005"&gt;       &lt;annotation&gt;         &lt;documentation&gt;massive&lt;/documentation&gt;       &lt;/annotation&gt;     &lt;/enumeration&gt;     &lt;enumeration value="0360006"&gt;       &lt;annotation&gt;         &lt;documentation&gt;torrential&lt;/documentation&gt;       &lt;/annotation&gt;     &lt;/enumeration&gt;     &lt;enumeration value="0360099"&gt;       &lt;annotation&gt;         &lt;documentation&gt;unbekannt&lt;/documentation&gt;       &lt;/annotation&gt;     &lt;/enumeration&gt;   &lt;/restriction&gt; &lt;/simpleType&gt; </pre>

### simpleType enum\_0361

namespace	http://xml.ir-d.de/irdsa
type	restriction of <b>string</b>
properties	base xs:string

facets	<table border="1"> <thead> <tr> <th>Kind</th> <th>Value</th> <th>Annotation</th> </tr> </thead> <tbody> <tr> <td>enumeration</td> <td>0361001</td> <td>documentation nein</td> </tr> <tr> <td>enumeration</td> <td>0361002</td> <td>documentation ja, letzte(r) innerhalb der letzten 48 Stunden</td> </tr> <tr> <td>enumeration</td> <td>0361003</td> <td>documentation ja, letzte(r) innerhalb der letzten 21 Tage</td> </tr> <tr> <td>enumeration</td> <td>0361004</td> <td>documentation ja, letzte(r) länger als 21 Tage</td> </tr> <tr> <td>enumeration</td> <td>0361098</td> <td>documentation ja, letzter Zeitpunkt unbekannt</td> </tr> <tr> <td>enumeration</td> <td>0361099</td> <td>documentation unbekannt</td> </tr> </tbody> </table>	Kind	Value	Annotation	enumeration	0361001	documentation nein	enumeration	0361002	documentation ja, letzte(r) innerhalb der letzten 48 Stunden	enumeration	0361003	documentation ja, letzte(r) innerhalb der letzten 21 Tage	enumeration	0361004	documentation ja, letzte(r) länger als 21 Tage	enumeration	0361098	documentation ja, letzter Zeitpunkt unbekannt	enumeration	0361099	documentation unbekannt
Kind	Value	Annotation																				
enumeration	0361001	documentation nein																				
enumeration	0361002	documentation ja, letzte(r) innerhalb der letzten 48 Stunden																				
enumeration	0361003	documentation ja, letzte(r) innerhalb der letzten 21 Tage																				
enumeration	0361004	documentation ja, letzte(r) länger als 21 Tage																				
enumeration	0361098	documentation ja, letzter Zeitpunkt unbekannt																				
enumeration	0361099	documentation unbekannt																				
annotation	documentation Kat_AK_SchockReanimation																					
source	<pre> &lt;simpleType name="enum_0361"&gt;   &lt;annotation&gt;     &lt;documentation&gt;Kat_AK_SchockReanimation&lt;/documentation&gt;   &lt;/annotation&gt;   &lt;restriction base="xs:string"&gt;     &lt;enumeration value="0361001"&gt;       &lt;annotation&gt;         &lt;documentation&gt;nein&lt;/documentation&gt;       &lt;/annotation&gt;     &lt;/enumeration&gt;     &lt;enumeration value="0361002"&gt;       &lt;annotation&gt;         &lt;documentation&gt;ja, letzte(r) innerhalb der letzten 48 Stunden&lt;/documentation&gt;       &lt;/annotation&gt;     &lt;/enumeration&gt;     &lt;enumeration value="0361003"&gt;       &lt;annotation&gt;         &lt;documentation&gt;ja, letzte(r) innerhalb der letzten 21 Tage&lt;/documentation&gt;       &lt;/annotation&gt;     &lt;/enumeration&gt;     &lt;enumeration value="0361004"&gt;       &lt;annotation&gt;         &lt;documentation&gt;ja, letzte(r) länger als 21 Tage&lt;/documentation&gt;       &lt;/annotation&gt;     &lt;/enumeration&gt;     &lt;enumeration value="0361098"&gt;       &lt;annotation&gt;         &lt;documentation&gt;ja, letzter Zeitpunkt unbekannt&lt;/documentation&gt;       &lt;/annotation&gt;     &lt;/enumeration&gt;     &lt;enumeration value="0361099"&gt;       &lt;annotation&gt;         &lt;documentation&gt;unbekannt&lt;/documentation&gt;       &lt;/annotation&gt;     &lt;/enumeration&gt;   &lt;/restriction&gt; &lt;/simpleType&gt; </pre>																					

simpleType **enum\_0362**

namespace	http://xml.ir-d.de/irdsa
-----------	--------------------------



type	restriction of <b>string</b>												
properties	base xs:string												
facets	<table border="1"> <thead> <tr> <th>Kind</th> <th>Value</th> <th>Annotation</th> </tr> </thead> <tbody> <tr> <td>enumeration</td> <td>0362001</td> <td>documentation Sinusrhythmus</td> </tr> <tr> <td>enumeration</td> <td>0362002</td> <td>documentation Vorhofflimmern</td> </tr> <tr> <td>enumeration</td> <td>0362042</td> <td>documentation anderer Herzrhythmus</td> </tr> </tbody> </table>	Kind	Value	Annotation	enumeration	0362001	documentation Sinusrhythmus	enumeration	0362002	documentation Vorhofflimmern	enumeration	0362042	documentation anderer Herzrhythmus
Kind	Value	Annotation											
enumeration	0362001	documentation Sinusrhythmus											
enumeration	0362002	documentation Vorhofflimmern											
enumeration	0362042	documentation anderer Herzrhythmus											
annotation	documentation Kat_AK_Herzrhythmus												
source	<pre> &lt;simpleType name="enum_0362"&gt;   &lt;annotation&gt;     &lt;documentation&gt;Kat_AK_Herzrhythmus&lt;/documentation&gt;   &lt;/annotation&gt;   &lt;restriction base="xs:string"&gt;     &lt;enumeration value="0362001"&gt;       &lt;annotation&gt;         &lt;documentation&gt;Sinusrhythmus&lt;/documentation&gt;       &lt;/annotation&gt;     &lt;/enumeration&gt;     &lt;enumeration value="0362002"&gt;       &lt;annotation&gt;         &lt;documentation&gt;Vorhofflimmern&lt;/documentation&gt;       &lt;/annotation&gt;     &lt;/enumeration&gt;     &lt;enumeration value="0362042"&gt;       &lt;annotation&gt;         &lt;documentation&gt;anderer Herzrhythmus&lt;/documentation&gt;       &lt;/annotation&gt;     &lt;/enumeration&gt;   &lt;/restriction&gt; &lt;/simpleType&gt; </pre>												

### simpleType **enum\_0363**

namespace	http://xml.ir-d.de/irdsa															
type	restriction of <b>string</b>															
properties	base xs:string															
facets	<table border="1"> <thead> <tr> <th>Kind</th> <th>Value</th> <th>Annotation</th> </tr> </thead> <tbody> <tr> <td>enumeration</td> <td>0363001</td> <td>documentation nein</td> </tr> <tr> <td>enumeration</td> <td>0363002</td> <td>documentation paroxysmal</td> </tr> <tr> <td>enumeration</td> <td>0363003</td> <td>documentation persistierend</td> </tr> <tr> <td>enumeration</td> <td>0363004</td> <td>documentation permanent</td> </tr> </tbody> </table>	Kind	Value	Annotation	enumeration	0363001	documentation nein	enumeration	0363002	documentation paroxysmal	enumeration	0363003	documentation persistierend	enumeration	0363004	documentation permanent
Kind	Value	Annotation														
enumeration	0363001	documentation nein														
enumeration	0363002	documentation paroxysmal														
enumeration	0363003	documentation persistierend														
enumeration	0363004	documentation permanent														
annotation	documentation Kat_AK_Vorhofflimmern															
source	<pre> &lt;simpleType name="enum_0363"&gt;   &lt;annotation&gt;     &lt;documentation&gt;Kat_AK_Vorhofflimmern&lt;/documentation&gt;   &lt;/annotation&gt;   &lt;restriction base="xs:string"&gt;     &lt;enumeration value="0363001"&gt; </pre>															

	<pre> &lt;annotation&gt;   &lt;documentation&gt;nein&lt;/documentation&gt; &lt;/annotation&gt; &lt;/enumeration&gt; &lt;enumeration value="0363002"&gt;   &lt;annotation&gt;     &lt;documentation&gt;paroxysmal&lt;/documentation&gt;   &lt;/annotation&gt; &lt;/enumeration&gt; &lt;enumeration value="0363003"&gt;   &lt;annotation&gt;     &lt;documentation&gt;persistierend&lt;/documentation&gt;   &lt;/annotation&gt; &lt;/enumeration&gt; &lt;enumeration value="0363004"&gt;   &lt;annotation&gt;     &lt;documentation&gt;permanent&lt;/documentation&gt;   &lt;/annotation&gt; &lt;/enumeration&gt; &lt;/restriction&gt; &lt;/simpleType&gt; </pre>
--	---

### simpleType enum 0364

namespace	http://xml.ir-d.de/irdsa		
type	restriction of <b>string</b>		
properties	base xs:string		
facets	Kind	Value	Annotation
	enumeration	0364001	documentation nein
	enumeration	0364002	documentation Schrittmacher ohne CRT-System
	enumeration	0364003	documentation Schrittmacher mit CRT-System
	enumeration	0364004	documentation Defibrillator ohne CRT-System
	enumeration	0364005	documentation Defibrillator mit CRT-System
annotation	documentation Kat_AK_SchrittmacherDefi		
source	<pre> &lt;simpleType name="enum_0364"&gt;   &lt;annotation&gt;     &lt;documentation&gt;Kat_AK_SchrittmacherDefi&lt;/documentation&gt;   &lt;/annotation&gt;   &lt;restriction base="xs:string"&gt;     &lt;enumeration value="0364001"&gt;       &lt;annotation&gt;         &lt;documentation&gt;nein&lt;/documentation&gt;       &lt;/annotation&gt;     &lt;/enumeration&gt;     &lt;enumeration value="0364002"&gt;       &lt;annotation&gt;         &lt;documentation&gt;Schrittmacher ohne CRT-System&lt;/documentation&gt;       &lt;/annotation&gt;     &lt;/enumeration&gt;     &lt;enumeration value="0364003"&gt;       &lt;annotation&gt; </pre>		

	<pre> &lt;documentation&gt;Schrittmacher mit CRT-System&lt;/documentation&gt; &lt;/annotation&gt; &lt;/enumeration&gt; &lt;enumeration value="0364004"&gt;   &lt;annotation&gt;     &lt;documentation&gt;Defibrillator ohne CRT-System&lt;/documentation&gt;   &lt;/annotation&gt; &lt;/enumeration&gt; &lt;enumeration value="0364005"&gt;   &lt;annotation&gt;     &lt;documentation&gt;Defibrillator mit CRT-System&lt;/documentation&gt;   &lt;/annotation&gt; &lt;/enumeration&gt; &lt;/restriction&gt; &lt;/simpleType&gt; </pre>
--	---

### simpleType enum 0365

namespace	http://xml.ir-d.de/irdsa		
type	restriction of <b>string</b>		
properties	base xs:string		
facets	Kind	Value	Annotation
	enumeration	0365001	documentation nein
	enumeration	0365002	documentation ja, operativ
	enumeration	0365003	documentation ja, interventionell
annotation	documentation Kat_AK_MyokardRevaskularisation		
source	<pre> &lt;simpleType name="enum_0365"&gt;   &lt;annotation&gt;     &lt;documentation&gt;Kat_AK_MyokardRevaskularisation&lt;/documentation&gt;   &lt;/annotation&gt;   &lt;restriction base="xs:string"&gt;     &lt;enumeration value="0365001"&gt;       &lt;annotation&gt;         &lt;documentation&gt;nein&lt;/documentation&gt;       &lt;/annotation&gt;     &lt;/enumeration&gt;     &lt;enumeration value="0365002"&gt;       &lt;annotation&gt;         &lt;documentation&gt;ja, operativ&lt;/documentation&gt;       &lt;/annotation&gt;     &lt;/enumeration&gt;     &lt;enumeration value="0365003"&gt;       &lt;annotation&gt;         &lt;documentation&gt;ja, interventionell&lt;/documentation&gt;       &lt;/annotation&gt;     &lt;/enumeration&gt;   &lt;/restriction&gt; &lt;/simpleType&gt; </pre>		

### simpleType enum\_0366

namespace	http://xml.ir-d.de/irdsa		
type	restriction of <b>string</b>		
properties	base xs:string		
facets	Kind	Value	Annotation
	enumeration	0366001	documentation nein
	enumeration	0366002	documentation ja, &lt;= 6 Stunden
	enumeration	0366003	documentation ja, &gt; 6 Stunden bis &lt;= 3 Monate
	enumeration	0366004	documentation ja, &gt; 3 Monate
	enumeration	0366099	documentation unbekannt
annotation	documentation Kat_AK_PCI		
source	<pre> &lt;simpleType name="enum_0366"&gt;   &lt;annotation&gt;     &lt;documentation&gt;Kat_AK_PCI&lt;/documentation&gt;   &lt;/annotation&gt;   &lt;restriction base="xs:string"&gt;     &lt;enumeration value="0366001"&gt;       &lt;annotation&gt;         &lt;documentation&gt;nein&lt;/documentation&gt;       &lt;/annotation&gt;     &lt;/enumeration&gt;     &lt;enumeration value="0366002"&gt;       &lt;annotation&gt;         &lt;documentation&gt;ja, &amp;lt;= 6 Stunden&lt;/documentation&gt;       &lt;/annotation&gt;     &lt;/enumeration&gt;     &lt;enumeration value="0366003"&gt;       &lt;annotation&gt;         &lt;documentation&gt;ja, &amp;gt; 6 Stunden bis &amp;lt;= 3 Monate&lt;/documentation&gt;       &lt;/annotation&gt;     &lt;/enumeration&gt;     &lt;enumeration value="0366004"&gt;       &lt;annotation&gt;         &lt;documentation&gt;ja, &amp;gt; 3 Monate&lt;/documentation&gt;       &lt;/annotation&gt;     &lt;/enumeration&gt;     &lt;enumeration value="0366099"&gt;       &lt;annotation&gt;         &lt;documentation&gt;unbekannt&lt;/documentation&gt;       &lt;/annotation&gt;     &lt;/enumeration&gt;   &lt;/restriction&gt; &lt;/simpleType&gt; </pre>		

### simpleType enum\_0367

namespace	http://xml.ir-d.de/irdsa		
type	restriction of <b>string</b>		
properties	base xs:string		

facets	<table border="1"> <thead> <tr> <th data-bbox="293 199 347 226">Kind</th> <th data-bbox="443 199 497 226">Value</th> <th data-bbox="555 199 660 226">Annotation</th> </tr> </thead> <tbody> <tr> <td data-bbox="293 230 411 257">enumeration</td> <td data-bbox="443 230 523 257">0367001</td> <td data-bbox="555 230 715 280">documentation keine</td> </tr> <tr> <td data-bbox="293 284 411 311">enumeration</td> <td data-bbox="443 284 523 311">0367002</td> <td data-bbox="555 284 715 333">documentation Mediastinitis</td> </tr> <tr> <td data-bbox="293 338 411 365">enumeration</td> <td data-bbox="443 338 523 365">0367003</td> <td data-bbox="555 338 715 387">documentation Sepsis</td> </tr> <tr> <td data-bbox="293 392 411 418">enumeration</td> <td data-bbox="443 392 523 418">0367004</td> <td data-bbox="555 392 847 441">documentation broncho-pulmonale Infektion</td> </tr> <tr> <td data-bbox="293 445 411 472">enumeration</td> <td data-bbox="443 445 523 472">0367005</td> <td data-bbox="555 445 847 495">documentation oto-laryngologische Infektion</td> </tr> <tr> <td data-bbox="293 499 411 526">enumeration</td> <td data-bbox="443 499 523 526">0367006</td> <td data-bbox="555 499 751 548">documentation floride Endokarditis</td> </tr> <tr> <td data-bbox="293 553 411 580">enumeration</td> <td data-bbox="443 553 523 580">0367007</td> <td data-bbox="555 553 715 602">documentation Peritonitis</td> </tr> <tr> <td data-bbox="293 607 411 633">enumeration</td> <td data-bbox="443 607 523 633">0367008</td> <td data-bbox="555 607 778 656">documentation Wundinfektion Thorax</td> </tr> <tr> <td data-bbox="293 660 411 687">enumeration</td> <td data-bbox="443 660 523 687">0367009</td> <td data-bbox="555 660 715 710">documentation Pleuraempyem</td> </tr> <tr> <td data-bbox="293 714 411 741">enumeration</td> <td data-bbox="443 714 523 741">0367010</td> <td data-bbox="555 714 783 763">documentation Venenkatheterinfektion</td> </tr> <tr> <td data-bbox="293 768 411 795">enumeration</td> <td data-bbox="443 768 523 795">0367011</td> <td data-bbox="555 768 743 817">documentation Harnwegsinfektion</td> </tr> <tr> <td data-bbox="293 822 411 848">enumeration</td> <td data-bbox="443 822 523 848">0367012</td> <td data-bbox="555 822 895 871">documentation Wundinfektion untere Extremitäten</td> </tr> <tr> <td data-bbox="293 875 411 902">enumeration</td> <td data-bbox="443 875 523 902">0367013</td> <td data-bbox="555 875 715 925">documentation HIV-Infektion</td> </tr> <tr> <td data-bbox="293 929 411 956">enumeration</td> <td data-bbox="443 929 523 956">0367014</td> <td data-bbox="555 929 743 978">documentation Hepatitis B oder C</td> </tr> <tr> <td data-bbox="293 983 411 1010">enumeration</td> <td data-bbox="443 983 523 1010">0367015</td> <td data-bbox="555 983 778 1032">documentation andere Wundinfektion</td> </tr> <tr> <td data-bbox="293 1037 411 1064">enumeration</td> <td data-bbox="443 1037 523 1064">0367042</td> <td data-bbox="555 1037 735 1086">documentation sonstige Infektion</td> </tr> </tbody> </table>	Kind	Value	Annotation	enumeration	0367001	documentation keine	enumeration	0367002	documentation Mediastinitis	enumeration	0367003	documentation Sepsis	enumeration	0367004	documentation broncho-pulmonale Infektion	enumeration	0367005	documentation oto-laryngologische Infektion	enumeration	0367006	documentation floride Endokarditis	enumeration	0367007	documentation Peritonitis	enumeration	0367008	documentation Wundinfektion Thorax	enumeration	0367009	documentation Pleuraempyem	enumeration	0367010	documentation Venenkatheterinfektion	enumeration	0367011	documentation Harnwegsinfektion	enumeration	0367012	documentation Wundinfektion untere Extremitäten	enumeration	0367013	documentation HIV-Infektion	enumeration	0367014	documentation Hepatitis B oder C	enumeration	0367015	documentation andere Wundinfektion	enumeration	0367042	documentation sonstige Infektion
Kind	Value	Annotation																																																		
enumeration	0367001	documentation keine																																																		
enumeration	0367002	documentation Mediastinitis																																																		
enumeration	0367003	documentation Sepsis																																																		
enumeration	0367004	documentation broncho-pulmonale Infektion																																																		
enumeration	0367005	documentation oto-laryngologische Infektion																																																		
enumeration	0367006	documentation floride Endokarditis																																																		
enumeration	0367007	documentation Peritonitis																																																		
enumeration	0367008	documentation Wundinfektion Thorax																																																		
enumeration	0367009	documentation Pleuraempyem																																																		
enumeration	0367010	documentation Venenkatheterinfektion																																																		
enumeration	0367011	documentation Harnwegsinfektion																																																		
enumeration	0367012	documentation Wundinfektion untere Extremitäten																																																		
enumeration	0367013	documentation HIV-Infektion																																																		
enumeration	0367014	documentation Hepatitis B oder C																																																		
enumeration	0367015	documentation andere Wundinfektion																																																		
enumeration	0367042	documentation sonstige Infektion																																																		
annotation	documentation Kat_AK_Infektion																																																			
source	<pre data-bbox="280 1196 1434 2033"> &lt;simpleType name="enum_0367"&gt;   &lt;annotation&gt;     &lt;documentation&gt;Kat_AK_Infektion&lt;/documentation&gt;   &lt;/annotation&gt;   &lt;restriction base="xs:string"&gt;     &lt;enumeration value="0367001"&gt;       &lt;annotation&gt;         &lt;documentation&gt;keine&lt;/documentation&gt;       &lt;/annotation&gt;     &lt;/enumeration&gt;     &lt;enumeration value="0367002"&gt;       &lt;annotation&gt;         &lt;documentation&gt;Mediastinitis&lt;/documentation&gt;       &lt;/annotation&gt;     &lt;/enumeration&gt;     &lt;enumeration value="0367003"&gt;       &lt;annotation&gt;         &lt;documentation&gt;Sepsis&lt;/documentation&gt;       &lt;/annotation&gt;     &lt;/enumeration&gt;     &lt;enumeration value="0367004"&gt;       &lt;annotation&gt;         &lt;documentation&gt;broncho-pulmonale Infektion&lt;/documentation&gt;       &lt;/annotation&gt;     &lt;/enumeration&gt;     &lt;enumeration value="0367005"&gt;       &lt;annotation&gt;         &lt;documentation&gt; </pre>																																																			

```
<documentation>oto-laryngologische Infektion</documentation>
</annotation>
</enumeration>
<enumeration value="0367006">
  <annotation>
    <documentation>floride Endokarditis</documentation>
  </annotation>
</enumeration>
<enumeration value="0367007">
  <annotation>
    <documentation>Peritonitis</documentation>
  </annotation>
</enumeration>
<enumeration value="0367008">
  <annotation>
    <documentation>Wundinfektion Thorax</documentation>
  </annotation>
</enumeration>
<enumeration value="0367009">
  <annotation>
    <documentation>Pleuraempyem</documentation>
  </annotation>
</enumeration>
<enumeration value="0367010">
  <annotation>
    <documentation>Venenkatheterinfektion</documentation>
  </annotation>
</enumeration>
<enumeration value="0367011">
  <annotation>
    <documentation>Harnwegsinfektion</documentation>
  </annotation>
</enumeration>
<enumeration value="0367012">
  <annotation>
    <documentation>Wundinfektion untere Extremitäten</documentation>
  </annotation>
</enumeration>
<enumeration value="0367013">
  <annotation>
    <documentation>HIV-Infektion</documentation>
  </annotation>
</enumeration>
<enumeration value="0367014">
  <annotation>
    <documentation>Hepatitis B oder C</documentation>
  </annotation>
</enumeration>
<enumeration value="0367015">
  <annotation>
    <documentation>andere Wundinfektion</documentation>
  </annotation>
</enumeration>
<enumeration value="0367042">
  <annotation>
    <documentation>sonstige Infektion</documentation>
  </annotation>
</enumeration>
</restriction>
```

	<code>&lt;/simpleType&gt;</code>
--	----------------------------------

### simpleType enum\_0368

namespace	http://xml.ir-d.de/irdsa																		
type	restriction of <b>string</b>																		
properties	base xs:string																		
facets	<table><thead><tr><th>Kind</th><th>Value</th><th>Annotation</th></tr></thead><tbody><tr><td>enumeration</td><td>0368001</td><td>documentation nein</td></tr><tr><td>enumeration</td><td>0368002</td><td>documentation ja, COPD mit Dauermedikation</td></tr><tr><td>enumeration</td><td>0368003</td><td>documentation ja, COPD ohne Dauermedikation</td></tr><tr><td>enumeration</td><td>0368004</td><td>documentation ja, andere Lungenerkrankungen</td></tr><tr><td>enumeration</td><td>0368099</td><td>documentation unbekannt</td></tr></tbody></table>	Kind	Value	Annotation	enumeration	0368001	documentation nein	enumeration	0368002	documentation ja, COPD mit Dauermedikation	enumeration	0368003	documentation ja, COPD ohne Dauermedikation	enumeration	0368004	documentation ja, andere Lungenerkrankungen	enumeration	0368099	documentation unbekannt
Kind	Value	Annotation																	
enumeration	0368001	documentation nein																	
enumeration	0368002	documentation ja, COPD mit Dauermedikation																	
enumeration	0368003	documentation ja, COPD ohne Dauermedikation																	
enumeration	0368004	documentation ja, andere Lungenerkrankungen																	
enumeration	0368099	documentation unbekannt																	
annotation	documentation Kat_AK_Lungenerkrankung																		
source	<pre>&lt;simpleType name="enum_0368"&gt;   &lt;annotation&gt;     &lt;documentation&gt;Kat_AK_Lungenerkrankung&lt;/documentation&gt;   &lt;/annotation&gt;   &lt;restriction base="xs:string"&gt;     &lt;enumeration value="0368001"&gt;       &lt;annotation&gt;         &lt;documentation&gt;nein&lt;/documentation&gt;       &lt;/annotation&gt;     &lt;/enumeration&gt;     &lt;enumeration value="0368002"&gt;       &lt;annotation&gt;         &lt;documentation&gt;ja, COPD mit Dauermedikation&lt;/documentation&gt;       &lt;/annotation&gt;     &lt;/enumeration&gt;     &lt;enumeration value="0368003"&gt;       &lt;annotation&gt;         &lt;documentation&gt;ja, COPD ohne Dauermedikation&lt;/documentation&gt;       &lt;/annotation&gt;     &lt;/enumeration&gt;     &lt;enumeration value="0368004"&gt;       &lt;annotation&gt;         &lt;documentation&gt;ja, andere Lungenerkrankungen&lt;/documentation&gt;       &lt;/annotation&gt;     &lt;/enumeration&gt;     &lt;enumeration value="0368099"&gt;       &lt;annotation&gt;         &lt;documentation&gt;unbekannt&lt;/documentation&gt;       &lt;/annotation&gt;     &lt;/enumeration&gt;   &lt;/restriction&gt; &lt;/simpleType&gt;</pre>																		

### simpleType enum\_0369

namespace	http://xml.ir-d.de/irdsa
-----------	--------------------------

type	restriction of <b>string</b>												
properties	base xs:string												
facets	<table border="1"> <thead> <tr> <th>Kind</th> <th>Value</th> <th>Annotation</th> </tr> </thead> <tbody> <tr> <td>enumeration</td> <td>0369001</td> <td>documentation nein</td> </tr> <tr> <td>enumeration</td> <td>0369002</td> <td>documentation akut</td> </tr> <tr> <td>enumeration</td> <td>0369003</td> <td>documentation chronisch</td> </tr> </tbody> </table>	Kind	Value	Annotation	enumeration	0369001	documentation nein	enumeration	0369002	documentation akut	enumeration	0369003	documentation chronisch
Kind	Value	Annotation											
enumeration	0369001	documentation nein											
enumeration	0369002	documentation akut											
enumeration	0369003	documentation chronisch											
annotation	documentation Kat_AK_Nierenersatztherapie												
source	<pre> &lt;simpleType name="enum_0369"&gt;   &lt;annotation&gt;     &lt;documentation&gt;Kat_AK_Nierenersatztherapie&lt;/documentation&gt;   &lt;/annotation&gt;   &lt;restriction base="xs:string"&gt;     &lt;enumeration value="0369001"&gt;       &lt;annotation&gt;         &lt;documentation&gt;nein&lt;/documentation&gt;       &lt;/annotation&gt;     &lt;/enumeration&gt;     &lt;enumeration value="0369002"&gt;       &lt;annotation&gt;         &lt;documentation&gt;akut&lt;/documentation&gt;       &lt;/annotation&gt;     &lt;/enumeration&gt;     &lt;enumeration value="0369003"&gt;       &lt;annotation&gt;         &lt;documentation&gt;chronisch&lt;/documentation&gt;       &lt;/annotation&gt;     &lt;/enumeration&gt;   &lt;/restriction&gt; &lt;/simpleType&gt; </pre>												

### simpleType **enum\_0370**

namespace	http://xml.ir-d.de/irdsa												
type	restriction of <b>string</b>												
properties	base xs:string												
facets	<table border="1"> <thead> <tr> <th>Kind</th> <th>Value</th> <th>Annotation</th> </tr> </thead> <tbody> <tr> <td>enumeration</td> <td>0370001</td> <td>documentation Echokardiographie</td> </tr> <tr> <td>enumeration</td> <td>0370002</td> <td>documentation Herzkatheter</td> </tr> <tr> <td>enumeration</td> <td>0370042</td> <td>documentation andere</td> </tr> </tbody> </table>	Kind	Value	Annotation	enumeration	0370001	documentation Echokardiographie	enumeration	0370002	documentation Herzkatheter	enumeration	0370042	documentation andere
Kind	Value	Annotation											
enumeration	0370001	documentation Echokardiographie											
enumeration	0370002	documentation Herzkatheter											
enumeration	0370042	documentation andere											
annotation	documentation Kat_AK_AKOEFMessmethode												
source	<pre> &lt;simpleType name="enum_0370"&gt;   &lt;annotation&gt;     &lt;documentation&gt;Kat_AK_AKOEFMessmethode&lt;/documentation&gt;   &lt;/annotation&gt;   &lt;restriction base="xs:string"&gt;     &lt;enumeration value="0370001"&gt;       &lt;annotation&gt;         &lt;documentation&gt;Echokardiographie&lt;/documentation&gt;       &lt;/annotation&gt;     &lt;/enumeration&gt;   &lt;/restriction&gt; &lt;/simpleType&gt; </pre>												



	<pre> &lt;/annotation&gt; &lt;/enumeration&gt; &lt;enumeration value="0370002"&gt;   &lt;annotation&gt;     &lt;documentation&gt;Herzkatheter&lt;/documentation&gt;   &lt;/annotation&gt; &lt;/enumeration&gt; &lt;enumeration value="0370042"&gt;   &lt;annotation&gt;     &lt;documentation&gt;andere&lt;/documentation&gt;   &lt;/annotation&gt; &lt;/enumeration&gt; &lt;/restriction&gt; &lt;/simpleType&gt; </pre>
--	--

### simpleType enum\_0371

namespace	http://xml.lir-d.de/irdsa		
type	restriction of <b>string</b>		
properties	base xs:string		
facets	Kind	Value	Annotation
	enumeration	0371001	documentation keine
	enumeration	0371002	documentation leicht
	enumeration	0371003	documentation mittel
	enumeration	0371004	documentation schwer
	enumeration	0371099	documentation unbekannt
annotation	documentation Kat_AK_Verkalkungsgrad		
source	<pre> &lt;simpleType name="enum_0371"&gt;   &lt;annotation&gt;     &lt;documentation&gt;Kat_AK_Verkalkungsgrad&lt;/documentation&gt;   &lt;/annotation&gt;   &lt;restriction base="xs:string"&gt;     &lt;enumeration value="0371001"&gt;       &lt;annotation&gt;         &lt;documentation&gt;keine&lt;/documentation&gt;       &lt;/annotation&gt;     &lt;/enumeration&gt;     &lt;enumeration value="0371002"&gt;       &lt;annotation&gt;         &lt;documentation&gt;leicht&lt;/documentation&gt;       &lt;/annotation&gt;     &lt;/enumeration&gt;     &lt;enumeration value="0371003"&gt;       &lt;annotation&gt;         &lt;documentation&gt;mittel&lt;/documentation&gt;       &lt;/annotation&gt;     &lt;/enumeration&gt;     &lt;enumeration value="0371004"&gt;       &lt;annotation&gt;         &lt;documentation&gt;schwer&lt;/documentation&gt;       &lt;/annotation&gt;     &lt;/enumeration&gt;   &lt;/restriction&gt; &lt;/simpleType&gt; </pre>		

	<pre> &lt;/enumeration&gt; &lt;enumeration value="0371099"&gt;   &lt;annotation&gt;     &lt;documentation&gt;unbekannt&lt;/documentation&gt;   &lt;/annotation&gt; &lt;/enumeration&gt; &lt;/restriction&gt; &lt;/simpleType&gt; </pre>
--	---

### simpleType enum\_0372

namespace	http://xml.ir-d.de/irdsa		
type	restriction of <b>string</b>		
properties	base xs:string		
facets	Kind	Value	Annotation
	enumeration	0372001	documentation nein
	enumeration	0372002	documentation ja, bicuspide
	enumeration	0372003	documentation ja, unicuspide
	enumeration	0372099	documentation unbekannt
annotation	documentation Kat_AK_BiUnicuspideKlappe		
source	<pre> &lt;simpleType name="enum_0372"&gt;   &lt;annotation&gt;     &lt;documentation&gt;Kat_AK_BiUnicuspideKlappe&lt;/documentation&gt;   &lt;/annotation&gt;   &lt;restriction base="xs:string"&gt;     &lt;enumeration value="0372001"&gt;       &lt;annotation&gt;         &lt;documentation&gt;nein&lt;/documentation&gt;       &lt;/annotation&gt;     &lt;/enumeration&gt;     &lt;enumeration value="0372002"&gt;       &lt;annotation&gt;         &lt;documentation&gt;ja, bicuspide&lt;/documentation&gt;       &lt;/annotation&gt;     &lt;/enumeration&gt;     &lt;enumeration value="0372003"&gt;       &lt;annotation&gt;         &lt;documentation&gt;ja, unicuspide&lt;/documentation&gt;       &lt;/annotation&gt;     &lt;/enumeration&gt;     &lt;enumeration value="0372099"&gt;       &lt;annotation&gt;         &lt;documentation&gt;unbekannt&lt;/documentation&gt;       &lt;/annotation&gt;     &lt;/enumeration&gt;   &lt;/restriction&gt; &lt;/simpleType&gt; </pre>		

### simpleType enum\_0373

namespace	http://xml.ir-d.de/irdsa		
type	restriction of <b>string</b>		
properties	base xs:string		
facets	Kind	Value	Annotation
	enumeration	0373001	documentation keine
	enumeration	0373002	documentation leichtgradig
	enumeration	0373003	documentation mittelgradig
	enumeration	0373004	documentation hochgradig
	enumeration	0373099	documentation unbekannt
annotation	documentation Kat_AK_Grad		
source	<pre> &lt;simpleType name="enum_0373"&gt;   &lt;annotation&gt;     &lt;documentation&gt;Kat_AK_Grad&lt;/documentation&gt;   &lt;/annotation&gt;   &lt;restriction base="xs:string"&gt;     &lt;enumeration value="0373001"&gt;       &lt;annotation&gt;         &lt;documentation&gt;keine&lt;/documentation&gt;       &lt;/annotation&gt;     &lt;/enumeration&gt;     &lt;enumeration value="0373002"&gt;       &lt;annotation&gt;         &lt;documentation&gt;leichtgradig&lt;/documentation&gt;       &lt;/annotation&gt;     &lt;/enumeration&gt;     &lt;enumeration value="0373003"&gt;       &lt;annotation&gt;         &lt;documentation&gt;mittelgradig&lt;/documentation&gt;       &lt;/annotation&gt;     &lt;/enumeration&gt;     &lt;enumeration value="0373004"&gt;       &lt;annotation&gt;         &lt;documentation&gt;hochgradig&lt;/documentation&gt;       &lt;/annotation&gt;     &lt;/enumeration&gt;     &lt;enumeration value="0373099"&gt;       &lt;annotation&gt;         &lt;documentation&gt;unbekannt&lt;/documentation&gt;       &lt;/annotation&gt;     &lt;/enumeration&gt;   &lt;/restriction&gt; &lt;/simpleType&gt; </pre>		

### simpleType enum\_0374

namespace	http://xml.ir-d.de/irdsa		
type	restriction of <b>string</b>		
properties	base xs:string		

facets	<table border="1"> <thead> <tr> <th>Kind</th> <th>Value</th> <th>Annotation</th> </tr> </thead> <tbody> <tr> <td>enumeration</td> <td>0374001</td> <td>documentation nein</td> </tr> <tr> <td>enumeration</td> <td>0374002</td> <td>documentation ja, &amp;lt;= 6 Stunden</td> </tr> <tr> <td>enumeration</td> <td>0374003</td> <td>documentation ja, &amp;gt; 6 Stunden bis &amp;lt;= 24 Stunden</td> </tr> <tr> <td>enumeration</td> <td>0374004</td> <td>documentation ja, &amp;gt; 1 bis 7 Tage</td> </tr> <tr> <td>enumeration</td> <td>0374005</td> <td>documentation ja, &amp;gt; 7 bis 21 Tage</td> </tr> <tr> <td>enumeration</td> <td>0374006</td> <td>documentation ja, &amp;gt; 21 Tage</td> </tr> <tr> <td>enumeration</td> <td>0374099</td> <td>documentation unbekannt</td> </tr> </tbody> </table>	Kind	Value	Annotation	enumeration	0374001	documentation nein	enumeration	0374002	documentation ja, &lt;= 6 Stunden	enumeration	0374003	documentation ja, &gt; 6 Stunden bis &lt;= 24 Stunden	enumeration	0374004	documentation ja, &gt; 1 bis 7 Tage	enumeration	0374005	documentation ja, &gt; 7 bis 21 Tage	enumeration	0374006	documentation ja, &gt; 21 Tage	enumeration	0374099	documentation unbekannt
Kind	Value	Annotation																							
enumeration	0374001	documentation nein																							
enumeration	0374002	documentation ja, &lt;= 6 Stunden																							
enumeration	0374003	documentation ja, &gt; 6 Stunden bis &lt;= 24 Stunden																							
enumeration	0374004	documentation ja, &gt; 1 bis 7 Tage																							
enumeration	0374005	documentation ja, &gt; 7 bis 21 Tage																							
enumeration	0374006	documentation ja, &gt; 21 Tage																							
enumeration	0374099	documentation unbekannt																							
annotation	documentation Kat_AK_InfarktAnamnese																								
source	<pre> &lt;simpleType name="enum_0374"&gt;   &lt;annotation&gt;     &lt;documentation&gt;Kat_AK_InfarktAnamnese&lt;/documentation&gt;   &lt;/annotation&gt;   &lt;restriction base="xs:string"&gt;     &lt;enumeration value="0374001"&gt;       &lt;annotation&gt;         &lt;documentation&gt;nein&lt;/documentation&gt;       &lt;/annotation&gt;     &lt;/enumeration&gt;     &lt;enumeration value="0374002"&gt;       &lt;annotation&gt;         &lt;documentation&gt;ja, &amp;lt;= 6 Stunden&lt;/documentation&gt;       &lt;/annotation&gt;     &lt;/enumeration&gt;     &lt;enumeration value="0374003"&gt;       &lt;annotation&gt;         &lt;documentation&gt;ja, &amp;gt; 6 Stunden bis &amp;lt;= 24 Stunden&lt;/documentation&gt;       &lt;/annotation&gt;     &lt;/enumeration&gt;     &lt;enumeration value="0374004"&gt;       &lt;annotation&gt;         &lt;documentation&gt;ja, &amp;gt; 1 bis 7 Tage&lt;/documentation&gt;       &lt;/annotation&gt;     &lt;/enumeration&gt;     &lt;enumeration value="0374005"&gt;       &lt;annotation&gt;         &lt;documentation&gt;ja, &amp;gt; 7 bis 21 Tage&lt;/documentation&gt;       &lt;/annotation&gt;     &lt;/enumeration&gt;     &lt;enumeration value="0374006"&gt;       &lt;annotation&gt;         &lt;documentation&gt;ja, &amp;gt; 21 Tage&lt;/documentation&gt;       &lt;/annotation&gt;     &lt;/enumeration&gt;     &lt;enumeration value="0374099"&gt;       &lt;annotation&gt;         &lt;documentation&gt;unbekannt&lt;/documentation&gt;       &lt;/annotation&gt;     &lt;/enumeration&gt;   &lt;/restriction&gt; &lt;/simpleType&gt; </pre>																								

### simpleType enum\_0375

namespace	http://xml.ir-d.de/irdsa		
type	restriction of <b>string</b>		
properties	base xs:string		
facets	Kind	Value	Annotation
	enumeration	0375001	documentation keine Symptome oder Angina
	enumeration	0375002	documentation Symptome, aber keine Ischämiezeichen
	enumeration	0375003	documentation stabile Angina
	enumeration	0375004	documentation instabile Angina
	enumeration	0375005	documentation Infarkt ohne ST-Hebung (Non-STEMI)
	enumeration	0375006	documentation Infarkt mit ST-Hebung (STEMI)
	enumeration	0375042	documentation unbekannt
annotation	documentation Kat_AK_KardialeSymptome		
source	<pre> &lt;simpleType name="enum_0375"&gt;   &lt;annotation&gt;     &lt;documentation&gt;Kat_AK_KardialeSymptome&lt;/documentation&gt;   &lt;/annotation&gt;   &lt;restriction base="xs:string"&gt;     &lt;enumeration value="0375001"&gt;       &lt;annotation&gt;         &lt;documentation&gt;keine Symptome oder Angina&lt;/documentation&gt;       &lt;/annotation&gt;     &lt;/enumeration&gt;     &lt;enumeration value="0375002"&gt;       &lt;annotation&gt;         &lt;documentation&gt;Symptome, aber keine Ischämiezeichen&lt;/documentation&gt;       &lt;/annotation&gt;     &lt;/enumeration&gt;     &lt;enumeration value="0375003"&gt;       &lt;annotation&gt;         &lt;documentation&gt;stabile Angina&lt;/documentation&gt;       &lt;/annotation&gt;     &lt;/enumeration&gt;     &lt;enumeration value="0375004"&gt;       &lt;annotation&gt;         &lt;documentation&gt;instabile Angina&lt;/documentation&gt;       &lt;/annotation&gt;     &lt;/enumeration&gt;     &lt;enumeration value="0375005"&gt;       &lt;annotation&gt;         &lt;documentation&gt;Infarkt ohne ST-Hebung (Non-STEMI)&lt;/documentation&gt;       &lt;/annotation&gt;     &lt;/enumeration&gt;     &lt;enumeration value="0375006"&gt;       &lt;annotation&gt;         &lt;documentation&gt;Infarkt mit ST-Hebung (STEMI)&lt;/documentation&gt;       &lt;/annotation&gt;     &lt;/enumeration&gt;     &lt;enumeration value="0375042"&gt; </pre>		

	<pre> &lt;annotation&gt;   &lt;documentation&gt;unbekannt&lt;/documentation&gt; &lt;/annotation&gt; &lt;/enumeration&gt; &lt;/restriction&gt; &lt;/simpleType&gt; </pre>
--	--

### simpleType enum\_0376

namespace	http://xml.ir-d.de/irdsa		
type	restriction of <b>string</b>		
properties	base xs:string		
facets	Kind	Value	Annotation
	enumeration	0376001	documentation nein
	enumeration	0376002	documentation ja, ZNS, zerebrovaskuläre Blutung
	enumeration	0376003	documentation ja, ZNS, zerebrovaskuläre Ischämie
	enumeration	0376042	documentation ja, ZNS, andere
annotation	documentation Kat_AK_Schlaganfall		
source	<pre> &lt;simpleType name="enum_0376"&gt;   &lt;annotation&gt;     &lt;documentation&gt;Kat_AK_Schlaganfall&lt;/documentation&gt;   &lt;/annotation&gt;   &lt;restriction base="xs:string"&gt;     &lt;enumeration value="0376001"&gt;       &lt;annotation&gt;         &lt;documentation&gt;nein&lt;/documentation&gt;       &lt;/annotation&gt;     &lt;/enumeration&gt;     &lt;enumeration value="0376002"&gt;       &lt;annotation&gt;         &lt;documentation&gt;ja, ZNS, zerebrovaskuläre Blutung&lt;/documentation&gt;       &lt;/annotation&gt;     &lt;/enumeration&gt;     &lt;enumeration value="0376003"&gt;       &lt;annotation&gt;         &lt;documentation&gt;ja, ZNS, zerebrovaskuläre Ischämie&lt;/documentation&gt;       &lt;/annotation&gt;     &lt;/enumeration&gt;     &lt;enumeration value="0376042"&gt;       &lt;annotation&gt;         &lt;documentation&gt;ja, ZNS, andere&lt;/documentation&gt;       &lt;/annotation&gt;     &lt;/enumeration&gt;   &lt;/restriction&gt; &lt;/simpleType&gt; </pre>		

### simpleType enum\_0377

namespace	http://xml.ir-d.de/irdsa
type	restriction of <b>string</b>

properties	base xs:string												
facets	<table border="1"> <thead> <tr> <th>Kind</th> <th>Value</th> <th>Annotation</th> </tr> </thead> <tbody> <tr> <td>enumeration</td> <td>0377001</td> <td>documentation ja, mild neurological dysfunction: NIHSS 0-5</td> </tr> <tr> <td>enumeration</td> <td>0377002</td> <td>documentation ja, moderate neurological dysfunction: NIHSS 6-14</td> </tr> <tr> <td>enumeration</td> <td>0377003</td> <td>documentation ja, severe neurological dysfunction: NIHSS &amp;gt;=15</td> </tr> </tbody> </table>	Kind	Value	Annotation	enumeration	0377001	documentation ja, mild neurological dysfunction: NIHSS 0-5	enumeration	0377002	documentation ja, moderate neurological dysfunction: NIHSS 6-14	enumeration	0377003	documentation ja, severe neurological dysfunction: NIHSS &gt;=15
Kind	Value	Annotation											
enumeration	0377001	documentation ja, mild neurological dysfunction: NIHSS 0-5											
enumeration	0377002	documentation ja, moderate neurological dysfunction: NIHSS 6-14											
enumeration	0377003	documentation ja, severe neurological dysfunction: NIHSS &gt;=15											
annotation	documentation Kat AK Nihss												
source	<pre> &lt;simpleType name="enum_0377"&gt;   &lt;annotation&gt;     &lt;documentation&gt;Kat_AK_Nihss&lt;/documentation&gt;   &lt;/annotation&gt;   &lt;restriction base="xs:string"&gt;     &lt;enumeration value="0377001"&gt;       &lt;annotation&gt;         &lt;documentation&gt;ja, mild neurological dysfunction: NIHSS 0-5&lt;/documentation&gt;       &lt;/annotation&gt;     &lt;/enumeration&gt;     &lt;enumeration value="0377002"&gt;       &lt;annotation&gt;         &lt;documentation&gt;ja, moderate neurological dysfunction: NIHSS 6-14&lt;/documentation&gt;       &lt;/annotation&gt;     &lt;/enumeration&gt;     &lt;enumeration value="0377003"&gt;       &lt;annotation&gt;         &lt;documentation&gt; ja, severe neurological dysfunction: NIHSS &amp;gt;=15&lt;/documentation&gt;       &lt;/annotation&gt;     &lt;/enumeration&gt;   &lt;/restriction&gt; &lt;/simpleType&gt; </pre>												

### simpleType enum\_0378

namespace	http://xml.ir-d.de/irdsa															
type	restriction of <b>string</b>															
properties	base xs:string															
facets	<table border="1"> <thead> <tr> <th>Kind</th> <th>Value</th> <th>Annotation</th> </tr> </thead> <tbody> <tr> <td>enumeration</td> <td>0378001</td> <td>documentation nein</td> </tr> <tr> <td>enumeration</td> <td>0378002</td> <td>documentation ja, &amp;lt; 48h gemäss VARC-3-Definition</td> </tr> <tr> <td>enumeration</td> <td>0378003</td> <td>documentation ja, &amp;gt;= 48h - &amp;lt;= 72h gemäß VARC-3-Definition</td> </tr> <tr> <td>enumeration</td> <td>0378004</td> <td>documentation ja, &amp;gt; 72 h gemäß VARC-3 Definition</td> </tr> </tbody> </table>	Kind	Value	Annotation	enumeration	0378001	documentation nein	enumeration	0378002	documentation ja, &lt; 48h gemäss VARC-3-Definition	enumeration	0378003	documentation ja, &gt;= 48h - &lt;= 72h gemäß VARC-3-Definition	enumeration	0378004	documentation ja, &gt; 72 h gemäß VARC-3 Definition
Kind	Value	Annotation														
enumeration	0378001	documentation nein														
enumeration	0378002	documentation ja, &lt; 48h gemäss VARC-3-Definition														
enumeration	0378003	documentation ja, &gt;= 48h - &lt;= 72h gemäß VARC-3-Definition														
enumeration	0378004	documentation ja, &gt; 72 h gemäß VARC-3 Definition														
annotation	documentation Kat_AK_Myokardinfarkt															
source	<pre> &lt;simpleType name="enum_0378"&gt;   &lt;annotation&gt;     &lt;documentation&gt;Kat_AK_Myokardinfarkt&lt;/documentation&gt;   &lt;/annotation&gt;   &lt;restriction base="xs:string"&gt; </pre>															

	<pre> &lt;enumeration value="0378001"&gt;   &lt;annotation&gt;     &lt;documentation&gt;nein&lt;/documentation&gt;   &lt;/annotation&gt; &lt;/enumeration&gt; &lt;enumeration value="0378002"&gt;   &lt;annotation&gt;     &lt;documentation&gt;ja, &amp;lt; 48h gemäss VARC-3-Definition&lt;/documentation&gt;   &lt;/annotation&gt; &lt;/enumeration&gt; &lt;enumeration value="0378003"&gt;   &lt;annotation&gt;     &lt;documentation&gt;ja, &amp;gt;= 48h - &amp;lt;= 72h gemäß VARC-3-Definition&lt;/documentation&gt;   &lt;/annotation&gt; &lt;/enumeration&gt; &lt;enumeration value="0378004"&gt;   &lt;annotation&gt;     &lt;documentation&gt;ja, &amp;gt; 72 h gemäß VARC-3 Definition&lt;/documentation&gt;   &lt;/annotation&gt; &lt;/enumeration&gt; &lt;/restriction&gt; &lt;/simpleType&gt; </pre>
--	--

#### simpleType enum\_0379

namespace	http://xml.ir-d.de/irdsa		
type	restriction of <b>string</b>		
properties	base xs:string		
facets	Kind	Value	Annotation
	enumeration	0379001	documentation Keine gefäss- oder zugangsassozierte Komplikationen
	enumeration	0379002	documentation Versagen des perkutanen Verschlusssystems
	enumeration	0379003	documentation Geringfügige Gefäßkomplikationen
	enumeration	0379004	documentation Erhebliche Gefäßkomplikationen
annotation	documentation Kat_AK_ZugangKomplikationen		
source	<pre> &lt;simpleType name="enum_0379"&gt;   &lt;annotation&gt;     &lt;documentation&gt;Kat_AK_ZugangKomplikationen&lt;/documentation&gt;   &lt;/annotation&gt;   &lt;restriction base="xs:string"&gt;     &lt;enumeration value="0379001"&gt;       &lt;annotation&gt;         &lt;documentation&gt;Keine gefäss- oder zugangsassozierte Komplikationen&lt;/documentation&gt;       &lt;/annotation&gt;     &lt;/enumeration&gt;     &lt;enumeration value="0379002"&gt;       &lt;annotation&gt;         &lt;documentation&gt;Versagen des perkutanen Verschlusssystems&lt;/documentation&gt;       &lt;/annotation&gt;     &lt;/enumeration&gt;   &lt;/restriction&gt; &lt;/simpleType&gt; </pre>		



	<pre> &lt;enumeration value="0379003"&gt;   &lt;annotation&gt;     &lt;documentation&gt;Geringfügige Gefäßkomplikationen&lt;/documentation&gt;   &lt;/annotation&gt; &lt;/enumeration&gt; &lt;enumeration value="0379004"&gt;   &lt;annotation&gt;     &lt;documentation&gt;Erhebliche Gefäßkomplikationen&lt;/documentation&gt;   &lt;/annotation&gt; &lt;/enumeration&gt; &lt;/restriction&gt; &lt;/simpleType&gt; </pre>
--	---

### simpleType enum\_0380

namespace	http://xml.ir-d.de/irdsa		
type	restriction of <b>string</b>		
properties	base xs:string		
facets	Kind	Value	Annotation
	enumeration	0380001	documentation nein
	enumeration	0380002	documentation ja, intraprozedural
	enumeration	0380003	documentation ja, postprozedural
	enumeration	0380004	documentation ja, Zeitpunkt nicht bekannt
annotation	documentation Kat_AK_Reanimation		
source	<pre> &lt;simpleType name="enum_0380"&gt;   &lt;annotation&gt;     &lt;documentation&gt;Kat_AK_Reanimation&lt;/documentation&gt;   &lt;/annotation&gt;   &lt;restriction base="xs:string"&gt;     &lt;enumeration value="0380001"&gt;       &lt;annotation&gt;         &lt;documentation&gt;nein&lt;/documentation&gt;       &lt;/annotation&gt;     &lt;/enumeration&gt;     &lt;enumeration value="0380002"&gt;       &lt;annotation&gt;         &lt;documentation&gt;ja, intraprozedural&lt;/documentation&gt;       &lt;/annotation&gt;     &lt;/enumeration&gt;     &lt;enumeration value="0380003"&gt;       &lt;annotation&gt;         &lt;documentation&gt;ja, postprozedural&lt;/documentation&gt;       &lt;/annotation&gt;     &lt;/enumeration&gt;     &lt;enumeration value="0380004"&gt;       &lt;annotation&gt;         &lt;documentation&gt;ja, Zeitpunkt nicht bekannt&lt;/documentation&gt;       &lt;/annotation&gt;     &lt;/enumeration&gt;   &lt;/restriction&gt; &lt;/simpleType&gt; </pre>		

### simpleType enum 0381

namespace	http://xml.ir-d.de/irdsa		
type	restriction of <b>string</b>		
properties	base xs:string		
facets	Kind	Value	Annotation
	enumeration	0381001	documentation nein
	enumeration	0381002	documentation Thorakotomie/Rethorakotomie
	enumeration	0381003	documentation kathetergestützte Reintervention
	enumeration	0381004	documentation lokale Reinterventionen
	enumeration	0381005	documentation andere Reintervention
annotation	documentation Kat_AK_Massnahmen		
source	<pre> &lt;simpleType name="enum_0381"&gt;   &lt;annotation&gt;     &lt;documentation&gt;Kat_AK_Massnahmen&lt;/documentation&gt;   &lt;/annotation&gt;   &lt;restriction base="xs:string"&gt;     &lt;enumeration value="0381001"&gt;       &lt;annotation&gt;         &lt;documentation&gt;nein&lt;/documentation&gt;       &lt;/annotation&gt;     &lt;/enumeration&gt;     &lt;enumeration value="0381002"&gt;       &lt;annotation&gt;         &lt;documentation&gt;Thorakotomie/Rethorakotomie&lt;/documentation&gt;       &lt;/annotation&gt;     &lt;/enumeration&gt;     &lt;enumeration value="0381003"&gt;       &lt;annotation&gt;         &lt;documentation&gt;kathetergestützte Reintervention&lt;/documentation&gt;       &lt;/annotation&gt;     &lt;/enumeration&gt;     &lt;enumeration value="0381004"&gt;       &lt;annotation&gt;         &lt;documentation&gt;lokale Reinterventionen&lt;/documentation&gt;       &lt;/annotation&gt;     &lt;/enumeration&gt;     &lt;enumeration value="0381005"&gt;       &lt;annotation&gt;         &lt;documentation&gt;andere Reintervention&lt;/documentation&gt;       &lt;/annotation&gt;     &lt;/enumeration&gt;   &lt;/restriction&gt; &lt;/simpleType&gt; </pre>		

### simpleType enum 0382

namespace	http://xml.ir-d.de/irdsa
-----------	--------------------------

type	restriction of <b>string</b>		
properties	base xs:string		
facets	Kind	Value	Annotation
	enumeration	0382001	documentation keine Rethorakotomie / kein weiterer Grund
	enumeration	0382002	documentation Blutung/Hämatom
	enumeration	0382003	documentation Low Cardiac Output
	enumeration	0382004	documentation Tamponade
	enumeration	0382005	documentation Graftprobleme, Ischämie
	enumeration	0382006	documentation Wundinfektion, Mediastinitis
	enumeration	0382007	documentation Dissektion
	enumeration	0382008	documentation Prothesendysfunktion
	enumeration	0382009	documentation instabiles Sternum
	enumeration	0382010	documentation Chylothorax
	enumeration	0382011	documentation lokale Revision im Bereich des Zugangsweges
	enumeration	0382042	documentation anderer Grund
annotation	documentation Kat_AK_Komplikation		
source	<pre> &lt;simpleType name="enum_0382"&gt;   &lt;annotation&gt;     &lt;documentation&gt;Kat_AK_Komplikation&lt;/documentation&gt;   &lt;/annotation&gt;   &lt;restriction base="xs:string"&gt;     &lt;enumeration value="0382001"&gt;       &lt;annotation&gt;         &lt;documentation&gt;keine Rethorakotomie / kein weiterer Grund&lt;/documentation&gt;       &lt;/annotation&gt;     &lt;/enumeration&gt;     &lt;enumeration value="0382002"&gt;       &lt;annotation&gt;         &lt;documentation&gt;Blutung/Hämatom&lt;/documentation&gt;       &lt;/annotation&gt;     &lt;/enumeration&gt;     &lt;enumeration value="0382003"&gt;       &lt;annotation&gt;         &lt;documentation&gt;Low Cardiac Output&lt;/documentation&gt;       &lt;/annotation&gt;     &lt;/enumeration&gt;     &lt;enumeration value="0382004"&gt;       &lt;annotation&gt;         &lt;documentation&gt;Tamponade&lt;/documentation&gt;       &lt;/annotation&gt;     &lt;/enumeration&gt;     &lt;enumeration value="0382005"&gt;       &lt;annotation&gt;         &lt;documentation&gt;Graftprobleme, Ischämie&lt;/documentation&gt;       &lt;/annotation&gt;     &lt;/enumeration&gt;   &lt;/restriction&gt; &lt;/simpleType&gt; </pre>		

	<pre> &lt;enumeration value="0382006"&gt;   &lt;annotation&gt;     &lt;documentation&gt;Wundinfektion, Mediastinitis&lt;/documentation&gt;   &lt;/annotation&gt; &lt;/enumeration&gt; &lt;enumeration value="0382007"&gt;   &lt;annotation&gt;     &lt;documentation&gt;Dissektion&lt;/documentation&gt;   &lt;/annotation&gt; &lt;/enumeration&gt; &lt;enumeration value="0382008"&gt;   &lt;annotation&gt;     &lt;documentation&gt;Prothesendysfunktion&lt;/documentation&gt;   &lt;/annotation&gt; &lt;/enumeration&gt; &lt;enumeration value="0382009"&gt;   &lt;annotation&gt;     &lt;documentation&gt;instabiles Sternum&lt;/documentation&gt;   &lt;/annotation&gt; &lt;/enumeration&gt; &lt;enumeration value="0382010"&gt;   &lt;annotation&gt;     &lt;documentation&gt;Chylothorax&lt;/documentation&gt;   &lt;/annotation&gt; &lt;/enumeration&gt; &lt;enumeration value="0382011"&gt;   &lt;annotation&gt;     &lt;documentation&gt;lokale Revision im Bereich des Zugangsweges&lt;/documentation&gt;   &lt;/annotation&gt; &lt;/enumeration&gt; &lt;enumeration value="0382042"&gt;   &lt;annotation&gt;     &lt;documentation&gt;anderer Grund&lt;/documentation&gt;   &lt;/annotation&gt; &lt;/enumeration&gt; &lt;/restriction&gt; &lt;/simpleType&gt; </pre>
--	--

### simpleType enum 0383

namespace	http://xml.ir-d.de/irdsa		
type	restriction of <b>string</b>		
properties	base xs:string		
facets	Kind	Value	Annotation
	enumeration	0383001	documentation nein
	enumeration	0383002	documentation ja, mit forcierter Atemtherapie
	enumeration	0383003	documentation ja, Reintubation oder längerfristige Beatmung
	enumeration	0383004	documentation ja, Tracheotomie
annotation	documentation Kat_AK_RespiratorischeInsuffizienz		
source	<pre> &lt;simpleType name="enum_0383"&gt;   &lt;annotation&gt; </pre>		

	<pre> &lt;documentation&gt;Kat_AK_RespiratorischeInsuffizienz&lt;/documentation&gt; &lt;/annotation&gt; &lt;restriction base="xs:string"&gt;   &lt;enumeration value="0383001"&gt;     &lt;annotation&gt;       &lt;documentation&gt;nein&lt;/documentation&gt;     &lt;/annotation&gt;   &lt;/enumeration&gt;   &lt;enumeration value="0383002"&gt;     &lt;annotation&gt;       &lt;documentation&gt;ja, mit forcierter Atemtherapie&lt;/documentation&gt;     &lt;/annotation&gt;   &lt;/enumeration&gt;   &lt;enumeration value="0383003"&gt;     &lt;annotation&gt;       &lt;documentation&gt;ja, Reintubation oder längerfristige Beatmung&lt;/documentation&gt;     &lt;/annotation&gt;   &lt;/enumeration&gt;   &lt;enumeration value="0383004"&gt;     &lt;annotation&gt;       &lt;documentation&gt;ja, Tracheotomie&lt;/documentation&gt;     &lt;/annotation&gt;   &lt;/enumeration&gt; &lt;/restriction&gt; &lt;/simpleType&gt; </pre>
--	--

#### simpleType enum\_0384

namespace	http://xml.ir-d.de/irdsa		
type	restriction of <b>string</b>		
properties	base xs:string		
facets	Kind	Value	Annotation
	enumeration	0384001	documentation keine Blutungskomplikationen
	enumeration	0384002	documentation Geringfügige Blutung (Minor Bleeding - BARC type 2 or 3a)
	enumeration	0384003	documentation Starke Blutung (Major Bleeding - BARC type 3a)
	enumeration	0384004	documentation Lebensbedrohliche Blutung (Life-threatening or disabling bleeding - BARC type 3b or 3c or type 5)
annotation	documentation Kat_AK_Blutungskomplikation		
source	<pre> &lt;simpleType name="enum_0384"&gt;   &lt;annotation&gt;     &lt;documentation&gt;Kat_AK_Blutungskomplikation&lt;/documentation&gt;   &lt;/annotation&gt;   &lt;restriction base="xs:string"&gt;     &lt;enumeration value="0384001"&gt;       &lt;annotation&gt;         &lt;documentation&gt;keine Blutungskomplikationen&lt;/documentation&gt;       &lt;/annotation&gt;     &lt;/enumeration&gt;     &lt;enumeration value="0384002"&gt;       &lt;annotation&gt;         &lt;documentation&gt;Geringfügige Blutung (Minor Bleeding - BARC type 2 or </pre>		

	<pre> 3a) &lt;/documentation&gt;     &lt;/annotation&gt;   &lt;/enumeration&gt;   &lt;enumeration value="0384003"&gt;     &lt;annotation&gt;       &lt;documentation&gt;Starke Blutung (Major Bleeding - BARC type 3a) &lt;/documentation&gt;     &lt;/annotation&gt;   &lt;/enumeration&gt;   &lt;enumeration value="0384004"&gt;     &lt;annotation&gt;       &lt;documentation&gt;Lebensbedrohliche Blutung (Life-threatening or disabling bleeding - BARC type 3b or 3c or type 5) &lt;/documentation&gt;     &lt;/annotation&gt;   &lt;/enumeration&gt; &lt;/restriction&gt; &lt;/simpleType&gt; </pre>
--	--

### simpleType enum 0385

namespace	http://xml.ir-d.de/irdsa		
type	restriction of <b>string</b>		
properties	base xs:string		
facets	Kind	Value	Annotation
	enumeration	0385001	documentation Sinusrhythmus
	enumeration	0385002	documentation Vorhofflimmern
	enumeration	0385003	documentation Patient verstorben (kein Herzrhythmus)
	enumeration	0385042	documentation anderer Rhythmus
annotation	documentation Kat_AK_HerzrhythmusEntlassung		
source	<pre> &lt;simpleType name="enum_0385"&gt;   &lt;annotation&gt;     &lt;documentation&gt;Kat_AK_HerzrhythmusEntlassung&lt;/documentation&gt;   &lt;/annotation&gt;   &lt;restriction base="xs:string"&gt;     &lt;enumeration value="0385001"&gt;       &lt;annotation&gt;         &lt;documentation&gt;Sinusrhythmus&lt;/documentation&gt;       &lt;/annotation&gt;     &lt;/enumeration&gt;     &lt;enumeration value="0385002"&gt;       &lt;annotation&gt;         &lt;documentation&gt;Vorhofflimmern&lt;/documentation&gt;       &lt;/annotation&gt;     &lt;/enumeration&gt;     &lt;enumeration value="0385003"&gt;       &lt;annotation&gt;         &lt;documentation&gt;Patient verstorben (kein Herzrhythmus)&lt;/documentation&gt;       &lt;/annotation&gt;     &lt;/enumeration&gt;     &lt;enumeration value="0385042"&gt;       &lt;annotation&gt;         &lt;documentation&gt;anderer Rhythmus&lt;/documentation&gt; </pre>		

```

    </annotation>
  </enumeration>
</restriction>
</simpleType>

```

### simpleType enum\_0388

namespace	http://xml.ir-d.de/irdsa		
type	restriction of <b>string</b>		
properties	base xs:string		
facets	Kind	Value	Annotation
	enumeration	0388001	documentation nein
	enumeration	0388002	documentation ASS
	enumeration	0388003	documentation ADP-Rezeptor-Antagonist
	enumeration	0388004	documentation Kombination ASS und ADP-Rezeptor-Antagonist
	enumeration	0388042	documentation ja, andere
	enumeration	0388099	documentation unbekannt
annotation	documentation Kat AK Plaettchenaggregationshemmer		
source	<pre> &lt;simpleType name="enum_0388"&gt;   &lt;annotation&gt;     &lt;documentation&gt;Kat_AK_Plaettchenaggregationshemmer&lt;/documentation&gt;   &lt;/annotation&gt;   &lt;restriction base="xs:string"&gt;     &lt;enumeration value="0388001"&gt;       &lt;annotation&gt;         &lt;documentation&gt;nein&lt;/documentation&gt;       &lt;/annotation&gt;     &lt;/enumeration&gt;     &lt;enumeration value="0388002"&gt;       &lt;annotation&gt;         &lt;documentation&gt;ASS&lt;/documentation&gt;       &lt;/annotation&gt;     &lt;/enumeration&gt;     &lt;enumeration value="0388003"&gt;       &lt;annotation&gt;         &lt;documentation&gt;ADP-Rezeptor-Antagonist&lt;/documentation&gt;       &lt;/annotation&gt;     &lt;/enumeration&gt;     &lt;enumeration value="0388004"&gt;       &lt;annotation&gt;         &lt;documentation&gt;Kombination ASS und ADP-Rezeptor-Antagonist&lt;/documentation&gt;       &lt;/annotation&gt;     &lt;/enumeration&gt;     &lt;enumeration value="0388042"&gt;       &lt;annotation&gt;         &lt;documentation&gt;ja, andere&lt;/documentation&gt;       &lt;/annotation&gt;     &lt;/enumeration&gt;     &lt;enumeration value="0388099"&gt; </pre>		

	<pre> &lt;annotation&gt;   &lt;documentation&gt;unbekannt&lt;/documentation&gt; &lt;/annotation&gt; &lt;/enumeration&gt; &lt;/restriction&gt; &lt;/simpleType&gt; </pre>
--	--

### simpleType enum\_0389

namespace	http://xml.ir-d.de/irdsa		
type	restriction of <b>string</b>		
properties	base xs:string		
facets	Kind	Value	Annotation
	enumeration	0389001	documentation nein
	enumeration	0389002	documentation Cumarin-Derivate
	enumeration	0389003	documentation Heparinoide
	enumeration	0389004	documentation orale Thrombinantagonisten
	enumeration	0389005	documentation Kombination Heparinoide und Cumarin-Derivate
	enumeration	0389006	documentation Direkte orale Antikoagulantien (DOAK / NOAK)
	enumeration	0389042	documentation ja, andere
	enumeration	0389099	documentation unbekannt
annotation	documentation Kat_AK_Antikoagulantien		
source	<pre> &lt;simpleType name="enum_0389"&gt;   &lt;annotation&gt;     &lt;documentation&gt;Kat_AK_Antikoagulantien&lt;/documentation&gt;   &lt;/annotation&gt;   &lt;restriction base="xs:string"&gt;     &lt;enumeration value="0389001"&gt;       &lt;annotation&gt;         &lt;documentation&gt;nein&lt;/documentation&gt;       &lt;/annotation&gt;     &lt;/enumeration&gt;     &lt;enumeration value="0389002"&gt;       &lt;annotation&gt;         &lt;documentation&gt;Cumarin-Derivate&lt;/documentation&gt;       &lt;/annotation&gt;     &lt;/enumeration&gt;     &lt;enumeration value="0389003"&gt;       &lt;annotation&gt;         &lt;documentation&gt;Heparinoide&lt;/documentation&gt;       &lt;/annotation&gt;     &lt;/enumeration&gt;     &lt;enumeration value="0389004"&gt;       &lt;annotation&gt;         &lt;documentation&gt;orale Thrombinantagonisten&lt;/documentation&gt;       &lt;/annotation&gt;     &lt;/enumeration&gt;     &lt;enumeration value="0389005"&gt;       &lt;annotation&gt; </pre>		



	<pre> &lt;documentation&gt;Kombination Heparinoide und Cumarin-Derivate&lt;/documentation&gt; &lt;/annotation&gt; &lt;/enumeration&gt; &lt;enumeration value="0389006"&gt; &lt;annotation&gt; &lt;documentation&gt;Direkte orale Antikoagulantien (DOAK / NOAK)&lt;/documentation&gt; &lt;/annotation&gt; &lt;/enumeration&gt; &lt;enumeration value="0389042"&gt; &lt;annotation&gt; &lt;documentation&gt;ja, andere&lt;/documentation&gt; &lt;/annotation&gt; &lt;/enumeration&gt; &lt;enumeration value="0389099"&gt; &lt;annotation&gt; &lt;documentation&gt;unbekannt&lt;/documentation&gt; &lt;/annotation&gt; &lt;/enumeration&gt; &lt;/restriction&gt; &lt;/simpleType&gt; </pre>
--	---

### simpleType enum\_0390

namespace	http://xml.ir-d.de/irdsa		
type	restriction of <b>string</b>		
properties	base xs:string		
facets	Kind	Value	Annotation
	enumeration	0390001	documentation biologisches Klappenmodell
	enumeration	0390002	documentation mechanisches Klappenmodell
annotation	documentation Kat_AK_Artikeltyp		
source	<pre> &lt;simpleType name="enum_0390"&gt; &lt;annotation&gt; &lt;documentation&gt;Kat_AK_Artikeltyp&lt;/documentation&gt; &lt;/annotation&gt; &lt;restriction base="xs:string"&gt; &lt;enumeration value="0390001"&gt; &lt;annotation&gt; &lt;documentation&gt;biologisches Klappenmodell&lt;/documentation&gt; &lt;/annotation&gt; &lt;/enumeration&gt; &lt;enumeration value="0390002"&gt; &lt;annotation&gt; &lt;documentation&gt;mechanisches Klappenmodell&lt;/documentation&gt; &lt;/annotation&gt; &lt;/enumeration&gt; &lt;/restriction&gt; &lt;/simpleType&gt; </pre>		

### simpleType enum\_0398

namespace	http://xml.ir-d.de/irdsa		
type	restriction of <b>string</b>		
properties	base xs:string		
facets	Kind	Value	Annotation
	enumeration	0398001	documentation kardiovaskuläre Ursache
	enumeration	0398002	documentation nicht-kardiovaskuläre Ursache
	enumeration	0398099	documentation Todesursache unbekannt
annotation	documentation Kat_AK_Todesursache		
source	<pre> &lt;simpleType name="enum_0398"&gt;   &lt;annotation&gt;     &lt;documentation&gt;Kat_AK_Todesursache&lt;/documentation&gt;   &lt;/annotation&gt;   &lt;restriction base="xs:string"&gt;     &lt;enumeration value="0398001"&gt;       &lt;annotation&gt;         &lt;documentation&gt;kardiovaskuläre Ursache&lt;/documentation&gt;       &lt;/annotation&gt;     &lt;/enumeration&gt;     &lt;enumeration value="0398002"&gt;       &lt;annotation&gt;         &lt;documentation&gt;nicht-kardiovaskuläre Ursache&lt;/documentation&gt;       &lt;/annotation&gt;     &lt;/enumeration&gt;     &lt;enumeration value="0398099"&gt;       &lt;annotation&gt;         &lt;documentation&gt;Todesursache unbekannt&lt;/documentation&gt;       &lt;/annotation&gt;     &lt;/enumeration&gt;   &lt;/restriction&gt; &lt;/simpleType&gt; </pre>		

### simpleType enum\_0399

namespace	http://xml.ir-d.de/irdsa		
type	restriction of <b>string</b>		
properties	base xs:string		
facets	Kind	Value	Annotation
	enumeration	0399001	documentation Patient lebt
	enumeration	0399002	documentation Patient im Krankenhaus verstorben
annotation	documentation Kat_AK_Vitalstatus		
source	<pre> &lt;simpleType name="enum_0399"&gt;   &lt;annotation&gt;     &lt;documentation&gt;Kat_AK_Vitalstatus&lt;/documentation&gt;   &lt;/annotation&gt;   &lt;restriction base="xs:string"&gt;     &lt;enumeration value="0399001"&gt;       &lt;annotation&gt; </pre>		

	<pre> &lt;documentation&gt;Patient lebt&lt;/documentation&gt; &lt;/annotation&gt; &lt;/enumeration&gt; &lt;enumeration value="0399002"&gt;   &lt;annotation&gt;     &lt;documentation&gt;Patient im Krankenhaus verstorben&lt;/documentation&gt;   &lt;/annotation&gt; &lt;/enumeration&gt; &lt;/restriction&gt; &lt;/simpleType&gt; </pre>
--	---

### simpleType enum\_0044

namespace	http://xml.ir-d.de/sak		
type	restriction of <b>string</b>		
properties	base xs:string		
facets	Kind	Value	Annotation
	enumeration	0044001	documentation 1= normaler, sonst gesunder Patient
	enumeration	0044002	documentation 2= Patient mit leichter Allgemeinerkrankung
	enumeration	0044003	documentation 3= Patient mit schwerer Allgemeinerkrankung
	enumeration	0044004	documentation 4= Patient mit schwerer Allgemeinerkrankung, die eine ständige Lebensbedrohung darstellt
	enumeration	0044005	documentation 5= moribunder Patient, der ohne die Operation voraussichtlich nicht überleben wird
annotation	documentation Kat_ASA		
source	<pre> &lt;simpleType name="enum_0044"&gt;   &lt;annotation&gt;     &lt;documentation&gt;Kat_ASA&lt;/documentation&gt;   &lt;/annotation&gt;   &lt;restriction base="xs:string"&gt;     &lt;enumeration value="0044001"&gt;       &lt;annotation&gt;         &lt;documentation&gt;1= normaler, sonst gesunder Patient&lt;/documentation&gt;       &lt;/annotation&gt;     &lt;/enumeration&gt;     &lt;enumeration value="0044002"&gt;       &lt;annotation&gt;         &lt;documentation&gt;2= Patient mit leichter Allgemeinerkrankung&lt;/documentation&gt;       &lt;/annotation&gt;     &lt;/enumeration&gt;     &lt;enumeration value="0044003"&gt;       &lt;annotation&gt;         &lt;documentation&gt;3= Patient mit schwerer Allgemeinerkrankung&lt;/documentation&gt;       &lt;/annotation&gt;     &lt;/enumeration&gt;     &lt;enumeration value="0044004"&gt;       &lt;annotation&gt;         &lt;documentation&gt;4= Patient mit schwerer Allgemeinerkrankung, die eine ständige Lebensbedrohung darstellt&lt;/documentation&gt;       &lt;/annotation&gt;     &lt;/enumeration&gt;   &lt;/restriction&gt; &lt;/simpleType&gt; </pre>		

	<pre> &lt;/enumeration&gt; &lt;enumeration value="0044005"&gt;   &lt;annotation&gt;     &lt;documentation&gt;5= moribunder Patient, der ohne die Operation voraussichtlich nicht überleben wird&lt;/documentation&gt;   &lt;/annotation&gt; &lt;/enumeration&gt; &lt;/restriction&gt; &lt;/simpleType&gt; </pre>
--	--

### simpleType enum\_0050

namespace	http://xml.ir-d.de/sak		
type	restriction of <b>string</b>		
properties	base xs:string		
facets	Kind	Value	Annotation
	enumeration	0050001	documentation rechts
	enumeration	0050002	documentation links
annotation	documentation Kat_RechtsLinks		
source	<pre> &lt;simpleType name="enum_0050"&gt;   &lt;annotation&gt;     &lt;documentation&gt;Kat_RechtsLinks&lt;/documentation&gt;   &lt;/annotation&gt;   &lt;restriction base="xs:string"&gt;     &lt;enumeration value="0050001"&gt;       &lt;annotation&gt;         &lt;documentation&gt;rechts&lt;/documentation&gt;       &lt;/annotation&gt;     &lt;/enumeration&gt;     &lt;enumeration value="0050002"&gt;       &lt;annotation&gt;         &lt;documentation&gt;links&lt;/documentation&gt;       &lt;/annotation&gt;     &lt;/enumeration&gt;   &lt;/restriction&gt; &lt;/simpleType&gt; </pre>		

### simpleType enum\_0060

namespace	http://xml.ir-d.de/sak		
type	restriction of <b>string</b>		
properties	base xs:string		
facets	Kind	Value	Annotation
	enumeration	0060001	documentation ja
	enumeration	0060002	documentation nein
annotation	documentation Kat_JaNein		
source	<pre> &lt;simpleType name="enum_0060"&gt;   &lt;annotation&gt; </pre>		

	<pre> &lt;documentation&gt;Kat_JaNein&lt;/documentation&gt; &lt;/annotation&gt; &lt;restriction base="xs:string"&gt;   &lt;enumeration value="0060001"&gt;     &lt;annotation&gt;       &lt;documentation&gt;ja&lt;/documentation&gt;     &lt;/annotation&gt;   &lt;/enumeration&gt;   &lt;enumeration value="0060002"&gt;     &lt;annotation&gt;       &lt;documentation&gt;nein&lt;/documentation&gt;     &lt;/annotation&gt;   &lt;/enumeration&gt; &lt;/restriction&gt; &lt;/simpleType&gt; </pre>
--	--

### simpleType enum\_0061

namespace	http://xml.ir-d.de/sak		
type	restriction of <b>string</b>		
properties	base xs:string		
facets	Kind	Value	Annotation
	enumeration	0061001	documentation ja
	enumeration	0061002	documentation nein
	enumeration	0061099	documentation unbekannt
annotation	documentation Kat_JaNeinUnbekannt		
source	<pre> &lt;simpleType name="enum_0061"&gt;   &lt;annotation&gt;     &lt;documentation&gt;Kat_JaNeinUnbekannt&lt;/documentation&gt;   &lt;/annotation&gt;   &lt;restriction base="xs:string"&gt;     &lt;enumeration value="0061001"&gt;       &lt;annotation&gt;         &lt;documentation&gt;ja&lt;/documentation&gt;       &lt;/annotation&gt;     &lt;/enumeration&gt;     &lt;enumeration value="0061002"&gt;       &lt;annotation&gt;         &lt;documentation&gt;nein&lt;/documentation&gt;       &lt;/annotation&gt;     &lt;/enumeration&gt;     &lt;enumeration value="0061099"&gt;       &lt;annotation&gt;         &lt;documentation&gt;unbekannt&lt;/documentation&gt;       &lt;/annotation&gt;     &lt;/enumeration&gt;   &lt;/restriction&gt; &lt;/simpleType&gt; </pre>		

### simpleType enum\_0062

namespace	http://xml.ir-d.de/sak		
type	restriction of <b>string</b>		
properties	base xs:string		
facets	Kind	Value	Annotation
	enumeration	0062001	documentation Stück
	enumeration	0062002	documentation g
	enumeration	0062003	documentation mg
	enumeration	0062004	documentation l
	enumeration	0062005	documentation ml
	enumeration	0062006	documentation cm <sup>3</sup>
	enumeration	0062007	documentation mm
	enumeration	0062008	documentation cm
	enumeration	0062009	documentation dm
	enumeration	0062010	documentation m
	enumeration	0062042	documentation andere
annotation	documentation Kat_Einheit		
source	<pre> &lt;simpleType name="enum_0062"&gt;   &lt;annotation&gt;     &lt;documentation&gt;Kat_Einheit&lt;/documentation&gt;   &lt;/annotation&gt;   &lt;restriction base="xs:string"&gt;     &lt;enumeration value="0062001"&gt;       &lt;annotation&gt;         &lt;documentation&gt;Stück&lt;/documentation&gt;       &lt;/annotation&gt;     &lt;/enumeration&gt;     &lt;enumeration value="0062002"&gt;       &lt;annotation&gt;         &lt;documentation&gt;g&lt;/documentation&gt;       &lt;/annotation&gt;     &lt;/enumeration&gt;     &lt;enumeration value="0062003"&gt;       &lt;annotation&gt;         &lt;documentation&gt;mg&lt;/documentation&gt;       &lt;/annotation&gt;     &lt;/enumeration&gt;     &lt;enumeration value="0062004"&gt;       &lt;annotation&gt;         &lt;documentation&gt;l&lt;/documentation&gt;       &lt;/annotation&gt;     &lt;/enumeration&gt;     &lt;enumeration value="0062005"&gt;       &lt;annotation&gt;         &lt;documentation&gt;ml&lt;/documentation&gt;       &lt;/annotation&gt;     &lt;/enumeration&gt;   &lt;/restriction&gt; &lt;/simpleType&gt; </pre>		

	<pre> &lt;enumeration value="0062006"&gt;   &lt;annotation&gt;     &lt;documentation&gt;cm<sup>3</sup>&lt;/documentation&gt;   &lt;/annotation&gt; &lt;/enumeration&gt; &lt;enumeration value="0062007"&gt;   &lt;annotation&gt;     &lt;documentation&gt;mm&lt;/documentation&gt;   &lt;/annotation&gt; &lt;/enumeration&gt; &lt;enumeration value="0062008"&gt;   &lt;annotation&gt;     &lt;documentation&gt;cm&lt;/documentation&gt;   &lt;/annotation&gt; &lt;/enumeration&gt; &lt;enumeration value="0062009"&gt;   &lt;annotation&gt;     &lt;documentation&gt;dm&lt;/documentation&gt;   &lt;/annotation&gt; &lt;/enumeration&gt; &lt;enumeration value="0062010"&gt;   &lt;annotation&gt;     &lt;documentation&gt;m&lt;/documentation&gt;   &lt;/annotation&gt; &lt;/enumeration&gt; &lt;enumeration value="0062042"&gt;   &lt;annotation&gt;     &lt;documentation&gt;andere&lt;/documentation&gt;   &lt;/annotation&gt; &lt;/enumeration&gt; &lt;/restriction&gt; &lt;/simpleType&gt; </pre>
--	--

### simpleType enum\_0065

namespace	http://xml.ir-d.de/sak		
type	restriction of <b>string</b>		
properties	base xs:string		
facets	Kind	Value	Annotation
	enumeration	0065001	documentation stationär
	enumeration	0065002	documentation teilstationär
	enumeration	0065003	documentation ambulant
annotation	documentation Kat_ArtAufenthalt		
source	<pre> &lt;simpleType name="enum_0065"&gt;   &lt;annotation&gt;     &lt;documentation&gt;Kat_ArtAufenthalt&lt;/documentation&gt;   &lt;/annotation&gt;   &lt;restriction base="xs:string"&gt;     &lt;enumeration value="0065001"&gt;       &lt;annotation&gt;         &lt;documentation&gt;stationär&lt;/documentation&gt;       &lt;/annotation&gt;     &lt;/enumeration&gt; </pre>		

	<pre> &lt;enumeration value="0065002"&gt;   &lt;annotation&gt;     &lt;documentation&gt;teilstationär&lt;/documentation&gt;   &lt;/annotation&gt; &lt;/enumeration&gt; &lt;enumeration value="0065003"&gt;   &lt;annotation&gt;     &lt;documentation&gt;ambulant&lt;/documentation&gt;   &lt;/annotation&gt; &lt;/enumeration&gt; &lt;/restriction&gt; &lt;/simpleType&gt; </pre>
--	--

### simpleType enum\_0067

namespace	http://xml.ir-d.de/sak		
type	restriction of <b>string</b>		
properties	base xs:string		
facets	Kind	Value	Annotation
	enumeration	0067001	documentation Implantat
	enumeration	0067002	documentation Explantat
annotation	documentation Kat_ArtArtikel		
source	<pre> &lt;simpleType name="enum_0067"&gt;   &lt;annotation&gt;     &lt;documentation&gt;Kat_ArtArtikel&lt;/documentation&gt;   &lt;/annotation&gt;   &lt;restriction base="xs:string"&gt;     &lt;enumeration value="0067001"&gt;       &lt;annotation&gt;         &lt;documentation&gt;Implantat&lt;/documentation&gt;       &lt;/annotation&gt;     &lt;/enumeration&gt;     &lt;enumeration value="0067002"&gt;       &lt;annotation&gt;         &lt;documentation&gt;Explantat&lt;/documentation&gt;       &lt;/annotation&gt;     &lt;/enumeration&gt;   &lt;/restriction&gt; &lt;/simpleType&gt; </pre>		

### simpleType enum\_0068

namespace	http://xml.ir-d.de/sak		
type	restriction of <b>string</b>		
properties	base xs:string		
facets	Kind	Value	Annotation
	enumeration	0068001	documentation UDI
	enumeration	0068002	documentation Referenz (REF)
	enumeration	0068003	documentation



	enumeration 0068042 Katalognummer documentation sonstiger
annotation	documentation Kat_KennzeichenTyp
source	<pre> &lt;simpleType name="enum_0068"&gt;   &lt;annotation&gt;     &lt;documentation&gt;Kat_KennzeichenTyp&lt;/documentation&gt;   &lt;/annotation&gt;   &lt;restriction base="xs:string"&gt;     &lt;enumeration value="0068001"&gt;       &lt;annotation&gt;         &lt;documentation&gt;UDI&lt;/documentation&gt;       &lt;/annotation&gt;     &lt;/enumeration&gt;     &lt;enumeration value="0068002"&gt;       &lt;annotation&gt;         &lt;documentation&gt;Referenz (REF)&lt;/documentation&gt;       &lt;/annotation&gt;     &lt;/enumeration&gt;     &lt;enumeration value="0068003"&gt;       &lt;annotation&gt;         &lt;documentation&gt;Katalognummer&lt;/documentation&gt;       &lt;/annotation&gt;     &lt;/enumeration&gt;     &lt;enumeration value="0068042"&gt;       &lt;annotation&gt;         &lt;documentation&gt;sonstiger&lt;/documentation&gt;       &lt;/annotation&gt;     &lt;/enumeration&gt;   &lt;/restriction&gt; &lt;/simpleType&gt; </pre>

### simpleType enum\_0069

namespace	http://xml.ir-d.de/sak		
type	restriction of <b>string</b>		
properties	base xs:string		
facets	Kind	Value	Annotation
	enumeration	0069001	documentation Implantat
	enumeration	0069002	documentation Explantat
annotation	documentation Kat_ArtZubehoer		
source	<pre> &lt;simpleType name="enum_0069"&gt;   &lt;annotation&gt;     &lt;documentation&gt;Kat_ArtZubehoer&lt;/documentation&gt;   &lt;/annotation&gt;   &lt;restriction base="xs:string"&gt;     &lt;enumeration value="0069001"&gt;       &lt;annotation&gt;         &lt;documentation&gt;Implantat&lt;/documentation&gt;       &lt;/annotation&gt;     &lt;/enumeration&gt;     &lt;enumeration value="0069002"&gt;       &lt;annotation&gt; </pre>		

	<pre> &lt;documentation&gt;Explantat&lt;/documentation&gt; &lt;/annotation&gt; &lt;/enumeration&gt; &lt;/restriction&gt; &lt;/simpleType&gt; </pre>
--	---

### simpleType enum\_0070

namespace	http://xml.ir-d.de/sak		
type	restriction of <b>string</b>		
properties	base xs:string		
facets	Kind	Value	Annotation
	enumeration	0070001	documentation weiblich
	enumeration	0070002	documentation männlich
	enumeration	0070003	documentation divers
	enumeration	0070042	documentation unbestimmt
annotation	documentation Kat_Geschlecht		
source	<pre> &lt;simpleType name="enum_0070"&gt;   &lt;annotation&gt;     &lt;documentation&gt;Kat_Geschlecht&lt;/documentation&gt;   &lt;/annotation&gt;   &lt;restriction base="xs:string"&gt;     &lt;enumeration value="0070001"&gt;       &lt;annotation&gt;         &lt;documentation&gt;weiblich&lt;/documentation&gt;       &lt;/annotation&gt;     &lt;/enumeration&gt;     &lt;enumeration value="0070002"&gt;       &lt;annotation&gt;         &lt;documentation&gt;männlich&lt;/documentation&gt;       &lt;/annotation&gt;     &lt;/enumeration&gt;     &lt;enumeration value="0070003"&gt;       &lt;annotation&gt;         &lt;documentation&gt;divers&lt;/documentation&gt;       &lt;/annotation&gt;     &lt;/enumeration&gt;     &lt;enumeration value="0070042"&gt;       &lt;annotation&gt;         &lt;documentation&gt;unbestimmt&lt;/documentation&gt;       &lt;/annotation&gt;     &lt;/enumeration&gt;   &lt;/restriction&gt; &lt;/simpleType&gt; </pre>		

### simpleType enum\_0071

namespace	http://xml.ir-d.de/sak
type	restriction of <b>string</b>

properties	base xs:string												
facets	<table border="1"> <thead> <tr> <th>Kind</th> <th>Value</th> <th>Annotation</th> </tr> </thead> <tbody> <tr> <td>enumeration</td> <td>0071001</td> <td>documentation Implantat</td> </tr> <tr> <td>enumeration</td> <td>0071002</td> <td>documentation Explantat</td> </tr> <tr> <td>enumeration</td> <td>0071003</td> <td>documentation Degeneriertes/defektes Produkt, das funktionslos im Körper verbleibt</td> </tr> </tbody> </table>	Kind	Value	Annotation	enumeration	0071001	documentation Implantat	enumeration	0071002	documentation Explantat	enumeration	0071003	documentation Degeneriertes/defektes Produkt, das funktionslos im Körper verbleibt
Kind	Value	Annotation											
enumeration	0071001	documentation Implantat											
enumeration	0071002	documentation Explantat											
enumeration	0071003	documentation Degeneriertes/defektes Produkt, das funktionslos im Körper verbleibt											
annotation	documentation Kat ArtikelArtFunktion												
source	<pre> &lt;simpleType name="enum_0071"&gt;   &lt;annotation&gt;     &lt;documentation&gt;Kat_ArtikelArtFunktion&lt;/documentation&gt;   &lt;/annotation&gt;   &lt;restriction base="xs:string"&gt;     &lt;enumeration value="0071001"&gt;       &lt;annotation&gt;         &lt;documentation&gt;Implantat&lt;/documentation&gt;       &lt;/annotation&gt;     &lt;/enumeration&gt;     &lt;enumeration value="0071002"&gt;       &lt;annotation&gt;         &lt;documentation&gt;Explantat&lt;/documentation&gt;       &lt;/annotation&gt;     &lt;/enumeration&gt;     &lt;enumeration value="0071003"&gt;       &lt;annotation&gt;         &lt;documentation&gt;Degeneriertes/defektes Produkt, das funktionslos im         Körper verbleibt&lt;/documentation&gt;       &lt;/annotation&gt;     &lt;/enumeration&gt;   &lt;/restriction&gt; &lt;/simpleType&gt; </pre>												

### simpleType enum\_0075

namespace	http://xml.ir-d.de/sak												
type	restriction of <b>string</b>												
properties	base xs:string												
facets	<table border="1"> <thead> <tr> <th>Kind</th> <th>Value</th> <th>Annotation</th> </tr> </thead> <tbody> <tr> <td>enumeration</td> <td>0075001</td> <td>documentation elektiv</td> </tr> <tr> <td>enumeration</td> <td>0075002</td> <td>documentation dringlich</td> </tr> <tr> <td>enumeration</td> <td>0075003</td> <td>documentation Notfall</td> </tr> </tbody> </table>	Kind	Value	Annotation	enumeration	0075001	documentation elektiv	enumeration	0075002	documentation dringlich	enumeration	0075003	documentation Notfall
Kind	Value	Annotation											
enumeration	0075001	documentation elektiv											
enumeration	0075002	documentation dringlich											
enumeration	0075003	documentation Notfall											
annotation	documentation Kat_Dringlichkeit												
source	<pre> &lt;simpleType name="enum_0075"&gt;   &lt;annotation&gt;     &lt;documentation&gt;Kat_Dringlichkeit&lt;/documentation&gt;   &lt;/annotation&gt;   &lt;restriction base="xs:string"&gt;     &lt;enumeration value="0075001"&gt;       &lt;annotation&gt;         &lt;documentation&gt;elektiv&lt;/documentation&gt;       &lt;/annotation&gt;     &lt;/enumeration&gt;   &lt;/restriction&gt; &lt;/simpleType&gt; </pre>												

	<pre> &lt;/enumeration&gt; &lt;enumeration value="0075002"&gt;   &lt;annotation&gt;     &lt;documentation&gt;dringlich&lt;/documentation&gt;   &lt;/annotation&gt; &lt;/enumeration&gt; &lt;enumeration value="0075003"&gt;   &lt;annotation&gt;     &lt;documentation&gt;Notfall&lt;/documentation&gt;   &lt;/annotation&gt; &lt;/enumeration&gt; &lt;/restriction&gt; &lt;/simpleType&gt; </pre>
--	--

### simpleType enum\_0076

namespace	http://xml.ir-d.de/sak		
type	restriction of <b>string</b>		
properties	base xs:string		
facets	Kind	Value	Annotation
	enumeration	0076001	documentation elektiv
	enumeration	0076002	documentation dringlich
	enumeration	0076003	documentation Notfall
	enumeration	0076004	documentation Notfall (Reanimation / ultima ratio)
annotation	documentation Kat_Dringlichkeit_Reanimation		
source	<pre> &lt;simpleType name="enum_0076"&gt;   &lt;annotation&gt;     &lt;documentation&gt;Kat_Dringlichkeit_Reanimation&lt;/documentation&gt;   &lt;/annotation&gt;   &lt;restriction base="xs:string"&gt;     &lt;enumeration value="0076001"&gt;       &lt;annotation&gt;         &lt;documentation&gt;elektiv&lt;/documentation&gt;       &lt;/annotation&gt;     &lt;/enumeration&gt;     &lt;enumeration value="0076002"&gt;       &lt;annotation&gt;         &lt;documentation&gt;dringlich&lt;/documentation&gt;       &lt;/annotation&gt;     &lt;/enumeration&gt;     &lt;enumeration value="0076003"&gt;       &lt;annotation&gt;         &lt;documentation&gt;Notfall&lt;/documentation&gt;       &lt;/annotation&gt;     &lt;/enumeration&gt;     &lt;enumeration value="0076004"&gt;       &lt;annotation&gt;         &lt;documentation&gt;Notfall (Reanimation / ultima ratio)&lt;/documentation&gt;       &lt;/annotation&gt;     &lt;/enumeration&gt;   &lt;/restriction&gt; &lt;/simpleType&gt; </pre>		

### simpleType enum 0080

namespace	http://xml.ir-d.de/sak		
type	restriction of <b>string</b>		
properties	base xs:string		
facets	Kind	Value	Annotation
	enumeration	0080001	documentation Endoprothese Hüfte/Knie
	enumeration	0080002	documentation Brustimplantat
	enumeration	0080003	documentation Aortenklappenprothese
annotation	documentation Kat_Implantattyp		
source	<pre> &lt;simpleType name="enum_0080"&gt;   &lt;annotation&gt;     &lt;documentation&gt;Kat_Implantattyp&lt;/documentation&gt;   &lt;/annotation&gt;   &lt;restriction base="xs:string"&gt;     &lt;enumeration value="0080001"&gt;       &lt;annotation&gt;         &lt;documentation&gt;Endoprothese Hüfte/Knie&lt;/documentation&gt;       &lt;/annotation&gt;     &lt;/enumeration&gt;     &lt;enumeration value="0080002"&gt;       &lt;annotation&gt;         &lt;documentation&gt;Brustimplantat&lt;/documentation&gt;       &lt;/annotation&gt;     &lt;/enumeration&gt;     &lt;enumeration value="0080003"&gt;       &lt;annotation&gt;         &lt;documentation&gt;Aortenklappenprothese&lt;/documentation&gt;       &lt;/annotation&gt;     &lt;/enumeration&gt;   &lt;/restriction&gt; &lt;/simpleType&gt; </pre>		

### simpleType enum 0100

namespace	http://xml.ir-d.de/sak		
type	restriction of <b>string</b>		
properties	base xs:string		
facets	Kind	Value	Annotation
	enumeration	0100001	documentation Primäreingriff
	enumeration	0100002	documentation Austausch Expander gegen dauerhaftes Brustimplantat
	enumeration	0100003	documentation Revision
	enumeration	0100004	documentation Nur Explantation
annotation	documentation Kat_Bl_ArtEingriff		
source	<pre> &lt;simpleType name="enum_0100"&gt; </pre>		

	<pre> &lt;annotation&gt;   &lt;documentation&gt;Kat_BI_ArtEingriff&lt;/documentation&gt; &lt;/annotation&gt; &lt;restriction base="xs:string"&gt;   &lt;enumeration value="0100001"&gt;     &lt;annotation&gt;       &lt;documentation&gt;Primäreingriff&lt;/documentation&gt;     &lt;/annotation&gt;   &lt;/enumeration&gt;   &lt;enumeration value="0100002"&gt;     &lt;annotation&gt;       &lt;documentation&gt;Austausch Expander gegen dauerhaftes Brustimplantat&lt;/documentation&gt;     &lt;/annotation&gt;   &lt;/enumeration&gt;   &lt;enumeration value="0100003"&gt;     &lt;annotation&gt;       &lt;documentation&gt;Revision&lt;/documentation&gt;     &lt;/annotation&gt;   &lt;/enumeration&gt;   &lt;enumeration value="0100004"&gt;     &lt;annotation&gt;       &lt;documentation&gt;Nur Explantation&lt;/documentation&gt;     &lt;/annotation&gt;   &lt;/enumeration&gt; &lt;/restriction&gt; &lt;/simpleType&gt; </pre>
--	--

### simpleType enum\_0102

namespace	http://xml.ir-d.de/sak		
type	restriction of <b>string</b>		
properties	base xs:string		
facets	Kind	Value	Annotation
	enumeration	0102001	documentation kosmetische Augmentation
	enumeration	0102002	documentation Rekonstruktion, benigne
	enumeration	0102003	documentation Rekonstruktion nach Mastektomie aufgrund eines Karzinoms
	enumeration	0102004	documentation Rekonstruktion nach risikoreduzierender Mastektomie
annotation	documentation Kat_BI_GrundPrimaereingriff		
source	<pre> &lt;simpleType name="enum_0102"&gt;   &lt;annotation&gt;     &lt;documentation&gt;Kat_BI_GrundPrimaereingriff&lt;/documentation&gt;   &lt;/annotation&gt;   &lt;restriction base="xs:string"&gt;     &lt;enumeration value="0102001"&gt;       &lt;annotation&gt;         &lt;documentation&gt;kosmetische Augmentation&lt;/documentation&gt;       &lt;/annotation&gt;     &lt;/enumeration&gt;     &lt;enumeration value="0102002"&gt;       &lt;annotation&gt;         &lt;documentation&gt;Rekonstruktion, benigne&lt;/documentation&gt;       &lt;/annotation&gt;     &lt;/enumeration&gt;   &lt;/restriction&gt; &lt;/simpleType&gt; </pre>		

	<pre> &lt;/annotation&gt; &lt;/enumeration&gt; &lt;enumeration value="0102003"&gt;   &lt;annotation&gt;     &lt;documentation&gt;Rekonstruktion nach Mastektomie aufgrund eines Karzinoms&lt;/documentation&gt;   &lt;/annotation&gt; &lt;/enumeration&gt; &lt;enumeration value="0102004"&gt;   &lt;annotation&gt;     &lt;documentation&gt;Rekonstruktion nach risikoreduzierender Mastektomie&lt;/documentation&gt;   &lt;/annotation&gt; &lt;/enumeration&gt; &lt;/restriction&gt; &lt;/simpleType&gt; </pre>
--	---

### simpleType enum\_0103

namespace	http://xml.ir-d.de/sak		
type	restriction of <b>string</b>		
properties	base xs:string		
facets	Kind	Value	Annotation
	enumeration	0103001	documentation simultane Lappendeckung
	enumeration	0103002	documentation simultane Eigenfetttransplantation
	enumeration	0103003	documentation simultane Mastopexie
	enumeration	0103005	documentation simultane Mastektomie, Ablatio / hautsparend
	enumeration	0103006	documentation simultane Mastektomie, nippelerhaltend
	enumeration	0103007	documentation Axilla-Dissektion
	enumeration	0103008	documentation Drainage
annotation	documentation Kat_BI_OperationsdetailPrimaereingriff		
source	<pre> &lt;simpleType name="enum_0103"&gt;   &lt;annotation&gt;     &lt;documentation&gt;Kat_BI_OperationsdetailPrimaereingriff&lt;/documentation&gt;   &lt;/annotation&gt;   &lt;restriction base="xs:string"&gt;     &lt;enumeration value="0103001"&gt;       &lt;annotation&gt;         &lt;documentation&gt;simultane Lappendeckung&lt;/documentation&gt;       &lt;/annotation&gt;     &lt;/enumeration&gt;     &lt;enumeration value="0103002"&gt;       &lt;annotation&gt;         &lt;documentation&gt;simultane Eigenfetttransplantation&lt;/documentation&gt;       &lt;/annotation&gt;     &lt;/enumeration&gt;     &lt;enumeration value="0103003"&gt;       &lt;annotation&gt;         &lt;documentation&gt;simultane Mastopexie&lt;/documentation&gt; </pre>		

	<pre> &lt;/annotation&gt; &lt;/enumeration&gt; &lt;enumeration value="0103005"&gt;   &lt;annotation&gt;     &lt;documentation&gt;simultane Mastektomie, Ablatio / hautsparend&lt;/documentation&gt;   &lt;/annotation&gt; &lt;/enumeration&gt; &lt;enumeration value="0103006"&gt;   &lt;annotation&gt;     &lt;documentation&gt;simultane Mastektomie, nippelerhaltend&lt;/documentation&gt;   &lt;/annotation&gt; &lt;/enumeration&gt; &lt;enumeration value="0103007"&gt;   &lt;annotation&gt;     &lt;documentation&gt;Axilla-Dissektion&lt;/documentation&gt;   &lt;/annotation&gt; &lt;/enumeration&gt; &lt;enumeration value="0103008"&gt;   &lt;annotation&gt;     &lt;documentation&gt;Drainage&lt;/documentation&gt;   &lt;/annotation&gt; &lt;/enumeration&gt; &lt;/restriction&gt; &lt;/simpleType&gt; </pre>
--	---

#### simpleType enum\_0104

namespace	http://xml.ir-d.de/sak						
type	restriction of <b>string</b>						
properties	base xs:string						
facets	<table border="1"> <thead> <tr> <th>Kind</th> <th>Value</th> <th>Annotation</th> </tr> </thead> <tbody> <tr> <td>enumeration</td> <td>0104001</td> <td>documentation Austausch Expander gegen dauerhaftes Brustimplantat</td> </tr> </tbody> </table>	Kind	Value	Annotation	enumeration	0104001	documentation Austausch Expander gegen dauerhaftes Brustimplantat
Kind	Value	Annotation					
enumeration	0104001	documentation Austausch Expander gegen dauerhaftes Brustimplantat					
annotation	documentation Kat_BI_GrundAustausch						
source	<pre> &lt;simpleType name="enum_0104"&gt;   &lt;annotation&gt;     &lt;documentation&gt;Kat_BI_GrundAustausch&lt;/documentation&gt;   &lt;/annotation&gt;   &lt;restriction base="xs:string"&gt;     &lt;enumeration value="0104001"&gt;       &lt;annotation&gt;         &lt;documentation&gt;Austausch Expander gegen dauerhaftes Brustimplantat&lt;/documentation&gt;       &lt;/annotation&gt;     &lt;/enumeration&gt;   &lt;/restriction&gt; &lt;/simpleType&gt; </pre>						

#### simpleType enum\_0105

namespace	http://xml.ir-d.de/sak
type	restriction of <b>string</b>



properties	base xs:string																								
facets	<table border="1"> <thead> <tr> <th>Kind</th> <th>Value</th> <th>Annotation</th> </tr> </thead> <tbody> <tr> <td>enumeration</td> <td>0105001</td> <td>documentation simultane Lappendeckung</td> </tr> <tr> <td>enumeration</td> <td>0105002</td> <td>documentation simultane Eigenfetttransplantation</td> </tr> <tr> <td>enumeration</td> <td>0105003</td> <td>documentation simultane Mastopexie</td> </tr> <tr> <td>enumeration</td> <td>0105008</td> <td>documentation Drainage</td> </tr> <tr> <td>enumeration</td> <td>0105009</td> <td>documentation Kapsulektomie, komplett</td> </tr> <tr> <td>enumeration</td> <td>0105010</td> <td>documentation Kapsulektomie, partiell</td> </tr> <tr> <td>enumeration</td> <td>0105011</td> <td>documentation Neopocket</td> </tr> </tbody> </table>	Kind	Value	Annotation	enumeration	0105001	documentation simultane Lappendeckung	enumeration	0105002	documentation simultane Eigenfetttransplantation	enumeration	0105003	documentation simultane Mastopexie	enumeration	0105008	documentation Drainage	enumeration	0105009	documentation Kapsulektomie, komplett	enumeration	0105010	documentation Kapsulektomie, partiell	enumeration	0105011	documentation Neopocket
Kind	Value	Annotation																							
enumeration	0105001	documentation simultane Lappendeckung																							
enumeration	0105002	documentation simultane Eigenfetttransplantation																							
enumeration	0105003	documentation simultane Mastopexie																							
enumeration	0105008	documentation Drainage																							
enumeration	0105009	documentation Kapsulektomie, komplett																							
enumeration	0105010	documentation Kapsulektomie, partiell																							
enumeration	0105011	documentation Neopocket																							
annotation	documentation Kat_BI_OperationsdetailAustausch																								
source	<pre> &lt;simpleType name="enum_0105"&gt;   &lt;annotation&gt;     &lt;documentation&gt;Kat_BI_OperationsdetailAustausch&lt;/documentation&gt;   &lt;/annotation&gt;   &lt;restriction base="xs:string"&gt;     &lt;enumeration value="0105001"&gt;       &lt;annotation&gt;         &lt;documentation&gt;simultane Lappendeckung&lt;/documentation&gt;       &lt;/annotation&gt;     &lt;/enumeration&gt;     &lt;enumeration value="0105002"&gt;       &lt;annotation&gt;         &lt;documentation&gt;simultane Eigenfetttransplantation&lt;/documentation&gt;       &lt;/annotation&gt;     &lt;/enumeration&gt;     &lt;enumeration value="0105003"&gt;       &lt;annotation&gt;         &lt;documentation&gt;simultane Mastopexie&lt;/documentation&gt;       &lt;/annotation&gt;     &lt;/enumeration&gt;     &lt;enumeration value="0105008"&gt;       &lt;annotation&gt;         &lt;documentation&gt;Drainage&lt;/documentation&gt;       &lt;/annotation&gt;     &lt;/enumeration&gt;     &lt;enumeration value="0105009"&gt;       &lt;annotation&gt;         &lt;documentation&gt;Kapsulektomie, komplett&lt;/documentation&gt;       &lt;/annotation&gt;     &lt;/enumeration&gt;     &lt;enumeration value="0105010"&gt;       &lt;annotation&gt;         &lt;documentation&gt;Kapsulektomie, partiell&lt;/documentation&gt;       &lt;/annotation&gt;     &lt;/enumeration&gt;     &lt;enumeration value="0105011"&gt;       &lt;annotation&gt;         &lt;documentation&gt;Neopocket&lt;/documentation&gt;       &lt;/annotation&gt;     &lt;/enumeration&gt;   &lt;/restriction&gt; </pre>																								

	<code>&lt;/simpleType&gt;</code>
--	----------------------------------

### simpleType enum\_0106

namespace	http://xml.ir-d.de/sak		
type	restriction of <b>string</b>		
properties	base xs:string		
facets	Kind	Value	Annotation
	enumeration	0106001	documentation Patientenwunsch
	enumeration	0106002	documentation asymptomatisch
	enumeration	0106003	documentation Komplikation
annotation	documentation Kat_BI_GrundRevisionExplantation		
source	<pre> &lt;simpleType name="enum_0106"&gt;   &lt;annotation&gt;     &lt;documentation&gt;Kat_BI_GrundRevisionExplantation&lt;/documentation&gt;   &lt;/annotation&gt;   &lt;restriction base="xs:string"&gt;     &lt;enumeration value="0106001"&gt;       &lt;annotation&gt;         &lt;documentation&gt;Patientenwunsch&lt;/documentation&gt;       &lt;/annotation&gt;     &lt;/enumeration&gt;     &lt;enumeration value="0106002"&gt;       &lt;annotation&gt;         &lt;documentation&gt;asymptomatisch&lt;/documentation&gt;       &lt;/annotation&gt;     &lt;/enumeration&gt;     &lt;enumeration value="0106003"&gt;       &lt;annotation&gt;         &lt;documentation&gt;Komplikation&lt;/documentation&gt;       &lt;/annotation&gt;     &lt;/enumeration&gt;   &lt;/restriction&gt; &lt;/simpleType&gt; </pre>		

### simpleType enum\_0107

namespace	http://xml.ir-d.de/sak		
type	restriction of <b>string</b>		
properties	base xs:string		
facets	Kind	Value	Annotation
	enumeration	0107001	documentation simultane Lappendeckung
	enumeration	0107002	documentation simultane Eigenfetttransplantation
	enumeration	0107003	documentation simultane Mastopexie
	enumeration	0107005	documentation simultane Mastektomie, Ablatio / hautsparend
	enumeration	0107006	documentation simultane Mastektomie, nippelerhaltend

	<p>enumeration 0107007 documentation Axilla-Dissektion</p> <p>enumeration 0107008 documentation Drainage</p> <p>enumeration 0107009 documentation Kapsulektomie, komplett</p> <p>enumeration 0107010 documentation Kapsulektomie, partiell</p> <p>enumeration 0107011 documentation Neopocket</p>
annotation	<p>documentation Kat_BI_OperationsdetailRevision</p>
source	<pre> &lt;simpleType name="enum_0107"&gt;   &lt;annotation&gt;     &lt;documentation&gt;Kat_BI_OperationsdetailRevision&lt;/documentation&gt;   &lt;/annotation&gt;   &lt;restriction base="xs:string"&gt;     &lt;enumeration value="0107001"&gt;       &lt;annotation&gt;         &lt;documentation&gt;simultane Lappendeckung&lt;/documentation&gt;       &lt;/annotation&gt;     &lt;/enumeration&gt;     &lt;enumeration value="0107002"&gt;       &lt;annotation&gt;         &lt;documentation&gt;simultane Eigenfetttransplantation&lt;/documentation&gt;       &lt;/annotation&gt;     &lt;/enumeration&gt;     &lt;enumeration value="0107003"&gt;       &lt;annotation&gt;         &lt;documentation&gt;simultane Mastopexie&lt;/documentation&gt;       &lt;/annotation&gt;     &lt;/enumeration&gt;     &lt;enumeration value="0107005"&gt;       &lt;annotation&gt;         &lt;documentation&gt;simultane Mastektomie, Ablatio / hautsparend&lt;/documentation&gt;       &lt;/annotation&gt;     &lt;/enumeration&gt;     &lt;enumeration value="0107006"&gt;       &lt;annotation&gt;         &lt;documentation&gt;simultane Mastektomie, nippelerhaltend&lt;/documentation&gt;       &lt;/annotation&gt;     &lt;/enumeration&gt;     &lt;enumeration value="0107007"&gt;       &lt;annotation&gt;         &lt;documentation&gt;Axilla-Dissektion&lt;/documentation&gt;       &lt;/annotation&gt;     &lt;/enumeration&gt;     &lt;enumeration value="0107008"&gt;       &lt;annotation&gt;         &lt;documentation&gt;Drainage&lt;/documentation&gt;       &lt;/annotation&gt;     &lt;/enumeration&gt;     &lt;enumeration value="0107009"&gt;       &lt;annotation&gt;         &lt;documentation&gt;Kapsulektomie, komplett&lt;/documentation&gt;       &lt;/annotation&gt;     &lt;/enumeration&gt;     &lt;enumeration value="0107010"&gt;       &lt;annotation&gt; </pre>

	<pre> &lt;documentation&gt;Kapsulektomie, partiell&lt;/documentation&gt; &lt;/annotation&gt; &lt;/enumeration&gt; &lt;enumeration value="0107011"&gt;   &lt;annotation&gt;     &lt;documentation&gt;Neopocket&lt;/documentation&gt;   &lt;/annotation&gt; &lt;/enumeration&gt; &lt;/restriction&gt; &lt;/simpleType&gt; </pre>
--	--

### simpleType enum\_0110

namespace	http://xml.ir-d.de/sak		
type	restriction of <b>string</b>		
properties	base xs:string		
facets	Kind	Value	Annotation
	enumeration	0110001	documentation Bestrahlung
annotation	documentation Kat_BI_VorbehandlungLokal		
source	<pre> &lt;simpleType name="enum_0110"&gt;   &lt;annotation&gt;     &lt;documentation&gt;Kat_BI_VorbehandlungLokal&lt;/documentation&gt;   &lt;/annotation&gt;   &lt;restriction base="xs:string"&gt;     &lt;enumeration value="0110001"&gt;       &lt;annotation&gt;         &lt;documentation&gt;Bestrahlung&lt;/documentation&gt;       &lt;/annotation&gt;     &lt;/enumeration&gt;   &lt;/restriction&gt; &lt;/simpleType&gt; </pre>		

### simpleType enum\_0111

namespace	http://xml.ir-d.de/sak		
type	restriction of <b>string</b>		
properties	base xs:string		
facets	Kind	Value	Annotation
	enumeration	0111001	documentation nein
	enumeration	0111002	documentation Lipofilling
	enumeration	0111003	documentation Eigengewebsrekonstruktion
annotation	documentation Kat_BI_Verfahrenswechsel		
source	<pre> &lt;simpleType name="enum_0111"&gt;   &lt;annotation&gt;     &lt;documentation&gt;Kat_BI_Verfahrenswechsel&lt;/documentation&gt;   &lt;/annotation&gt;   &lt;restriction base="xs:string"&gt;     &lt;enumeration value="0111001"&gt; </pre>		

	<pre> &lt;annotation&gt;   &lt;documentation&gt;nein&lt;/documentation&gt; &lt;/annotation&gt; &lt;/enumeration&gt; &lt;enumeration value="0111002"&gt;   &lt;annotation&gt;     &lt;documentation&gt;Lipofilling&lt;/documentation&gt;   &lt;/annotation&gt; &lt;/enumeration&gt; &lt;enumeration value="0111003"&gt;   &lt;annotation&gt;     &lt;documentation&gt;Eigengewebsrekonstruktion&lt;/documentation&gt;   &lt;/annotation&gt; &lt;/enumeration&gt; &lt;/restriction&gt; &lt;/simpleType&gt; </pre>
--	---

### simpleType enum\_0112

namespace	http://xml.ir-d.de/sak		
type	restriction of <b>string</b>		
properties	base xs:string		
facets	Kind	Value	Annotation
	enumeration	0112001	documentation subglandulär / epipektoral
	enumeration	0112002	documentation subpektoral
	enumeration	0112003	documentation subfaszial
	enumeration	0112004	documentation sub-flap
	enumeration	0112005	documentation subkutan
	enumeration	0112006	documentation dual plane
	enumeration	0112042	documentation andere
annotation	documentation Kat_BI_LageImplantat		
source	<pre> &lt;simpleType name="enum_0112"&gt;   &lt;annotation&gt;     &lt;documentation&gt;Kat_BI_LageImplantat&lt;/documentation&gt;   &lt;/annotation&gt;   &lt;restriction base="xs:string"&gt;     &lt;enumeration value="0112001"&gt;       &lt;annotation&gt;         &lt;documentation&gt;subglandulär / epipektoral&lt;/documentation&gt;       &lt;/annotation&gt;     &lt;/enumeration&gt;     &lt;enumeration value="0112002"&gt;       &lt;annotation&gt;         &lt;documentation&gt;subpektoral&lt;/documentation&gt;       &lt;/annotation&gt;     &lt;/enumeration&gt;     &lt;enumeration value="0112003"&gt;       &lt;annotation&gt;         &lt;documentation&gt;subfaszial&lt;/documentation&gt; </pre>		

	<pre> &lt;/annotation&gt; &lt;/enumeration&gt; &lt;enumeration value="0112004"&gt;   &lt;annotation&gt;     &lt;documentation&gt;sub-flap&lt;/documentation&gt;   &lt;/annotation&gt; &lt;/enumeration&gt; &lt;enumeration value="0112005"&gt;   &lt;annotation&gt;     &lt;documentation&gt;subkutan&lt;/documentation&gt;   &lt;/annotation&gt; &lt;/enumeration&gt; &lt;enumeration value="0112006"&gt;   &lt;annotation&gt;     &lt;documentation&gt;dual plane&lt;/documentation&gt;   &lt;/annotation&gt; &lt;/enumeration&gt; &lt;enumeration value="0112042"&gt;   &lt;annotation&gt;     &lt;documentation&gt;andere&lt;/documentation&gt;   &lt;/annotation&gt; &lt;/enumeration&gt; &lt;/restriction&gt; &lt;/simpleType&gt; </pre>
--	--

### simpleType enum\_0113

namespace	http://xml.ir-d.de/sak		
type	restriction of <b>string</b>		
properties	base xs:string		
facets	Kind	Value	Annotation
	enumeration	0113001	documentation Chemotherapie innerhalb der letzten drei Monate
annotation	documentation Kat_BI_VorbehandlungSystemisch		
source	<pre> &lt;simpleType name="enum_0113"&gt;   &lt;annotation&gt;     &lt;documentation&gt;Kat_BI_VorbehandlungSystemisch&lt;/documentation&gt;   &lt;/annotation&gt;   &lt;restriction base="xs:string"&gt;     &lt;enumeration value="0113001"&gt;       &lt;annotation&gt;         &lt;documentation&gt;Chemotherapie innerhalb der letzten drei Monate&lt;/documentation&gt;       &lt;/annotation&gt;     &lt;/enumeration&gt;   &lt;/restriction&gt; &lt;/simpleType&gt; </pre>		

### simpleType enum\_0114

namespace	http://xml.ir-d.de/sak		
type	restriction of <b>string</b>		
properties	base xs:string		

facets	<table border="1"> <thead> <tr> <th>Kind</th> <th>Value</th> <th>Annotation</th> </tr> </thead> <tbody> <tr> <td>enumeration</td> <td>0114001</td> <td>documentation vollständig</td> </tr> <tr> <td>enumeration</td> <td>0114002</td> <td>documentation nein</td> </tr> <tr> <td>enumeration</td> <td>0114003</td> <td>documentation teilweise</td> </tr> <tr> <td>enumeration</td> <td>0114004</td> <td>documentation nicht vorhanden</td> </tr> </tbody> </table>	Kind	Value	Annotation	enumeration	0114001	documentation vollständig	enumeration	0114002	documentation nein	enumeration	0114003	documentation teilweise	enumeration	0114004	documentation nicht vorhanden
Kind	Value	Annotation														
enumeration	0114001	documentation vollständig														
enumeration	0114002	documentation nein														
enumeration	0114003	documentation teilweise														
enumeration	0114004	documentation nicht vorhanden														
annotation	documentation Kat_BI_EntfernungADMNetz															
source	<pre> &lt;simpleType name="enum_0114"&gt;   &lt;annotation&gt;     &lt;documentation&gt;Kat_BI_EntfernungADMNetz&lt;/documentation&gt;   &lt;/annotation&gt;   &lt;restriction base="xs:string"&gt;     &lt;enumeration value="0114001"&gt;       &lt;annotation&gt;         &lt;documentation&gt;vollständig&lt;/documentation&gt;       &lt;/annotation&gt;     &lt;/enumeration&gt;     &lt;enumeration value="0114002"&gt;       &lt;annotation&gt;         &lt;documentation&gt;nein&lt;/documentation&gt;       &lt;/annotation&gt;     &lt;/enumeration&gt;     &lt;enumeration value="0114003"&gt;       &lt;annotation&gt;         &lt;documentation&gt;teilweise&lt;/documentation&gt;       &lt;/annotation&gt;     &lt;/enumeration&gt;     &lt;enumeration value="0114004"&gt;       &lt;annotation&gt;         &lt;documentation&gt;nicht vorhanden&lt;/documentation&gt;       &lt;/annotation&gt;     &lt;/enumeration&gt;   &lt;/restriction&gt; &lt;/simpleType&gt; </pre>															

### simpleType enum\_0116

namespace	http://xml.ir-d.de/sak																								
type	restriction of <b>string</b>																								
properties	base xs:string																								
facets	<table border="1"> <thead> <tr> <th>Kind</th> <th>Value</th> <th>Annotation</th> </tr> </thead> <tbody> <tr> <td>enumeration</td> <td>0116001</td> <td>documentation Spülung, antibiotisch</td> </tr> <tr> <td>enumeration</td> <td>0116002</td> <td>documentation Spülung, antiseptisch</td> </tr> <tr> <td>enumeration</td> <td>0116003</td> <td>documentation Spülung, wirkstofffrei</td> </tr> <tr> <td>enumeration</td> <td>0116004</td> <td>documentation Spülung, andere</td> </tr> <tr> <td>enumeration</td> <td>0116005</td> <td>documentation prä-/perioperative Antibiotika</td> </tr> <tr> <td>enumeration</td> <td>0116006</td> <td>documentation postoperative Antibiotika</td> </tr> <tr> <td>enumeration</td> <td>0116007</td> <td>documentation</td> </tr> </tbody> </table>	Kind	Value	Annotation	enumeration	0116001	documentation Spülung, antibiotisch	enumeration	0116002	documentation Spülung, antiseptisch	enumeration	0116003	documentation Spülung, wirkstofffrei	enumeration	0116004	documentation Spülung, andere	enumeration	0116005	documentation prä-/perioperative Antibiotika	enumeration	0116006	documentation postoperative Antibiotika	enumeration	0116007	documentation
Kind	Value	Annotation																							
enumeration	0116001	documentation Spülung, antibiotisch																							
enumeration	0116002	documentation Spülung, antiseptisch																							
enumeration	0116003	documentation Spülung, wirkstofffrei																							
enumeration	0116004	documentation Spülung, andere																							
enumeration	0116005	documentation prä-/perioperative Antibiotika																							
enumeration	0116006	documentation postoperative Antibiotika																							
enumeration	0116007	documentation																							

	enumeration 0116008 Handschuhwechsel vor Implantation documentation Implantationshilfe
annotation	documentation Kat_BI_Operationsmassnahme
source	<pre> &lt;simpleType name="enum_0116"&gt;   &lt;annotation&gt;     &lt;documentation&gt;Kat_BI_Operationsmassnahme&lt;/documentation&gt;   &lt;/annotation&gt;   &lt;restriction base="xs:string"&gt;     &lt;enumeration value="0116001"&gt;       &lt;annotation&gt;         &lt;documentation&gt;Spülung, antibiotisch&lt;/documentation&gt;       &lt;/annotation&gt;     &lt;/enumeration&gt;     &lt;enumeration value="0116002"&gt;       &lt;annotation&gt;         &lt;documentation&gt;Spülung, antiseptisch&lt;/documentation&gt;       &lt;/annotation&gt;     &lt;/enumeration&gt;     &lt;enumeration value="0116003"&gt;       &lt;annotation&gt;         &lt;documentation&gt;Spülung, wirkstofffrei&lt;/documentation&gt;       &lt;/annotation&gt;     &lt;/enumeration&gt;     &lt;enumeration value="0116004"&gt;       &lt;annotation&gt;         &lt;documentation&gt;Spülung, andere&lt;/documentation&gt;       &lt;/annotation&gt;     &lt;/enumeration&gt;     &lt;enumeration value="0116005"&gt;       &lt;annotation&gt;         &lt;documentation&gt;prä-/perioperative Antibiotika&lt;/documentation&gt;       &lt;/annotation&gt;     &lt;/enumeration&gt;     &lt;enumeration value="0116006"&gt;       &lt;annotation&gt;         &lt;documentation&gt;postoperative Antibiotika&lt;/documentation&gt;       &lt;/annotation&gt;     &lt;/enumeration&gt;     &lt;enumeration value="0116007"&gt;       &lt;annotation&gt;         &lt;documentation&gt;Handschuhwechsel vor Implantation&lt;/documentation&gt;       &lt;/annotation&gt;     &lt;/enumeration&gt;     &lt;enumeration value="0116008"&gt;       &lt;annotation&gt;         &lt;documentation&gt;Implantationshilfe&lt;/documentation&gt;       &lt;/annotation&gt;     &lt;/enumeration&gt;   &lt;/restriction&gt; &lt;/simpleType&gt; </pre>

### simpleType enum\_0118

namespace	http://xml.ir-d.de/sak
type	restriction of <b>string</b>



properties	base xs:string																		
facets	<table border="1"> <thead> <tr> <th>Kind</th> <th>Value</th> <th>Annotation</th> </tr> </thead> <tbody> <tr> <td>enumeration</td> <td>0118001</td> <td>documentation axillär</td> </tr> <tr> <td>enumeration</td> <td>0118002</td> <td>documentation periareolär</td> </tr> <tr> <td>enumeration</td> <td>0118003</td> <td>documentation inframammär</td> </tr> <tr> <td>enumeration</td> <td>0118004</td> <td>documentation Mastektomienarbe</td> </tr> <tr> <td>enumeration</td> <td>0118042</td> <td>documentation anderer</td> </tr> </tbody> </table>	Kind	Value	Annotation	enumeration	0118001	documentation axillär	enumeration	0118002	documentation periareolär	enumeration	0118003	documentation inframammär	enumeration	0118004	documentation Mastektomienarbe	enumeration	0118042	documentation anderer
Kind	Value	Annotation																	
enumeration	0118001	documentation axillär																	
enumeration	0118002	documentation periareolär																	
enumeration	0118003	documentation inframammär																	
enumeration	0118004	documentation Mastektomienarbe																	
enumeration	0118042	documentation anderer																	
annotation	documentation Kat_BI_Operationszugang																		
source	<pre> &lt;simpleType name="enum_0118"&gt;   &lt;annotation&gt;     &lt;documentation&gt;Kat_BI_Operationszugang&lt;/documentation&gt;   &lt;/annotation&gt;   &lt;restriction base="xs:string"&gt;     &lt;enumeration value="0118001"&gt;       &lt;annotation&gt;         &lt;documentation&gt;axillär&lt;/documentation&gt;       &lt;/annotation&gt;     &lt;/enumeration&gt;     &lt;enumeration value="0118002"&gt;       &lt;annotation&gt;         &lt;documentation&gt;periareolär&lt;/documentation&gt;       &lt;/annotation&gt;     &lt;/enumeration&gt;     &lt;enumeration value="0118003"&gt;       &lt;annotation&gt;         &lt;documentation&gt;inframammär&lt;/documentation&gt;       &lt;/annotation&gt;     &lt;/enumeration&gt;     &lt;enumeration value="0118004"&gt;       &lt;annotation&gt;         &lt;documentation&gt;Mastektomienarbe&lt;/documentation&gt;       &lt;/annotation&gt;     &lt;/enumeration&gt;     &lt;enumeration value="0118042"&gt;       &lt;annotation&gt;         &lt;documentation&gt;anderer&lt;/documentation&gt;       &lt;/annotation&gt;     &lt;/enumeration&gt;   &lt;/restriction&gt; &lt;/simpleType&gt; </pre>																		

### simpleType enum\_0120

namespace	http://xml.ir-d.de/sak						
type	restriction of <b>string</b>						
properties	base xs:string						
facets	<table border="1"> <thead> <tr> <th>Kind</th> <th>Value</th> <th>Annotation</th> </tr> </thead> <tbody> <tr> <td>enumeration</td> <td>0120001</td> <td>documentation Expander defekt</td> </tr> </tbody> </table>	Kind	Value	Annotation	enumeration	0120001	documentation Expander defekt
Kind	Value	Annotation					
enumeration	0120001	documentation Expander defekt					
annotation	documentation Kat BI BefundAustausch						

source	<pre> &lt;simpleType name="enum_0120"&gt;   &lt;annotation&gt;     &lt;documentation&gt;Kat_BI_BefundAustausch&lt;/documentation&gt;   &lt;/annotation&gt;   &lt;restriction base="xs:string"&gt;     &lt;enumeration value="0120001"&gt;       &lt;annotation&gt;         &lt;documentation&gt;Expander defekt&lt;/documentation&gt;       &lt;/annotation&gt;     &lt;/enumeration&gt;   &lt;/restriction&gt; &lt;/simpleType&gt; </pre>
--------	--

### simpleType enum\_0121

namespace	http://xml.ir-d.de/sak		
type	restriction of <b>string</b>		
properties	base xs:string		
facets	Kind	Value	Annotation
	enumeration	0121001	documentation Infektion
	enumeration	0121002	documentation Serom
	enumeration	0121003	documentation Hämatom
	enumeration	0121004	documentation Kapsel fibrose
	enumeration	0121005	documentation Implantatruptur
	enumeration	0121006	documentation Fehlpositionierung/Rotation
	enumeration	0121007	documentation BIA-ALCL/-SCC, Verdacht
	enumeration	0121008	documentation BIA-ALCL/-SCC, pathologisch bestätigt
	enumeration	0121009	documentation Brustschmerzen
	enumeration	0121010	documentation Doppelkapsel
	enumeration	0121011	documentation Netz-/ADM-bedingte Komplikation, Non-Integration
	enumeration	0121012	documentation Netz-/ADM-bedingte Komplikation, andere
	enumeration	0121013	documentation Hautnekrose/exponiertes Implantat
	enumeration	0121014	documentation BII/ASIA (Brustimplantat assoziierte Symptome), Verdacht
	enumeration	0121015	documentation Lymphadenopathie
	enumeration	0121016	documentation Brustkrebs, neu aufgetreten/Rezidiv
annotation	documentation Kat_BI_BefundKomplett		
source	<pre> &lt;simpleType name="enum_0121"&gt;   &lt;annotation&gt;     &lt;documentation&gt;Kat_BI_BefundKomplett&lt;/documentation&gt;   &lt;/annotation&gt;   &lt;restriction base="xs:string"&gt;     &lt;enumeration value="0121001"&gt; </pre>		

```

    <annotation>
      <documentation>Infektion</documentation>
    </annotation>
  </enumeration>
  <enumeration value="0121002">
    <annotation>
      <documentation>Serom</documentation>
    </annotation>
  </enumeration>
  <enumeration value="0121003">
    <annotation>
      <documentation>Hämatom</documentation>
    </annotation>
  </enumeration>
  <enumeration value="0121004">
    <annotation>
      <documentation>Kapselfibrose</documentation>
    </annotation>
  </enumeration>
  <enumeration value="0121005">
    <annotation>
      <documentation>Implantatruptur</documentation>
    </annotation>
  </enumeration>
  <enumeration value="0121006">
    <annotation>
      <documentation>Fehlpositionierung/Rotation</documentation>
    </annotation>
  </enumeration>
  <enumeration value="0121007">
    <annotation>
      <documentation>BIA-ALCL/-SCC, Verdacht</documentation>
    </annotation>
  </enumeration>
  <enumeration value="0121008">
    <annotation>
      <documentation>BIA-ALCL/-SCC, pathologisch bestätigt</documentation>
    </annotation>
  </enumeration>
  <enumeration value="0121009">
    <annotation>
      <documentation>Brustschmerzen</documentation>
    </annotation>
  </enumeration>
  <enumeration value="0121010">
    <annotation>
      <documentation>Doppelkapsel</documentation>
    </annotation>
  </enumeration>
  <enumeration value="0121011">
    <annotation>
      <documentation>Netz-/ADM-bedingte Komplikation,
Non-Integration</documentation>
    </annotation>
  </enumeration>
  <enumeration value="0121012">
    <annotation>
      <documentation>Netz-/ADM-bedingte Komplikation, andere</documentation>
    </annotation>
  </enumeration>

```

	<pre> &lt;/enumeration&gt; &lt;enumeration value="0121013"&gt;   &lt;annotation&gt;     &lt;documentation&gt;Hautnekrose/exponiertes Implantat&lt;/documentation&gt;   &lt;/annotation&gt; &lt;/enumeration&gt; &lt;enumeration value="0121014"&gt;   &lt;annotation&gt;     &lt;documentation&gt;BII/ASIA (Brustimplantat assoziierte Symptome), Verdacht&lt;/documentation&gt;   &lt;/annotation&gt; &lt;/enumeration&gt; &lt;enumeration value="0121015"&gt;   &lt;annotation&gt;     &lt;documentation&gt;Lymphadenopathie&lt;/documentation&gt;   &lt;/annotation&gt; &lt;/enumeration&gt; &lt;enumeration value="0121016"&gt;   &lt;annotation&gt;     &lt;documentation&gt;Brustkrebs, neu aufgetreten/Rezidiv&lt;/documentation&gt;   &lt;/annotation&gt; &lt;/enumeration&gt; &lt;/restriction&gt; &lt;/simpleType&gt; </pre>
--	--

### simpleType enum\_0122

namespace	http://xml.ir-d.de/sak		
type	restriction of <b>string</b>		
properties	base xs:string		
facets	Kind	Value	Annotation
	enumeration	0122001	documentation ja, ärztlich nachgewiesen
	enumeration	0122002	documentation nein
	enumeration	0122042	documentation unbekannt
annotation	documentation Kat BI Autoimmunerkrankung		
source	<pre> &lt;simpleType name="enum_0122"&gt;   &lt;annotation&gt;     &lt;documentation&gt;Kat_BI_Autoimmunerkrankung&lt;/documentation&gt;   &lt;/annotation&gt;   &lt;restriction base="xs:string"&gt;     &lt;enumeration value="0122001"&gt;       &lt;annotation&gt;         &lt;documentation&gt;ja, ärztlich nachgewiesen&lt;/documentation&gt;       &lt;/annotation&gt;     &lt;/enumeration&gt;     &lt;enumeration value="0122002"&gt;       &lt;annotation&gt;         &lt;documentation&gt;nein&lt;/documentation&gt;       &lt;/annotation&gt;     &lt;/enumeration&gt;     &lt;enumeration value="0122042"&gt;       &lt;annotation&gt;         &lt;documentation&gt;unbekannt&lt;/documentation&gt;       &lt;/annotation&gt;     &lt;/enumeration&gt;   &lt;/restriction&gt; &lt;/simpleType&gt; </pre>		

```

    </annotation>
  </enumeration>
</restriction>
</simpleType>

```

### simpleType enum\_0123

namespace	http://xml.ir-d.de/sak		
type	restriction of <b>string</b>		
properties	base xs:string		
facets	Kind	Value	Annotation
	enumeration	0123001	documentation neu aufgetreten
	enumeration	0123002	documentation verschlechtert
	enumeration	0123003	documentation keine Veränderung
	enumeration	0123004	documentation nicht relevant, da Primäreingriff
	enumeration	0123042	documentation unbekannt
annotation	documentation Kat_BI_VerlaufAutoimmunerkrankung		
source	<pre> &lt;simpleType name="enum_0123"&gt;   &lt;annotation&gt;     &lt;documentation&gt;Kat_BI_VerlaufAutoimmunerkrankung&lt;/documentation&gt;   &lt;/annotation&gt;   &lt;restriction base="xs:string"&gt;     &lt;enumeration value="0123001"&gt;       &lt;annotation&gt;         &lt;documentation&gt;neu aufgetreten&lt;/documentation&gt;       &lt;/annotation&gt;     &lt;/enumeration&gt;     &lt;enumeration value="0123002"&gt;       &lt;annotation&gt;         &lt;documentation&gt;verschlechtert&lt;/documentation&gt;       &lt;/annotation&gt;     &lt;/enumeration&gt;     &lt;enumeration value="0123003"&gt;       &lt;annotation&gt;         &lt;documentation&gt;keine Veränderung&lt;/documentation&gt;       &lt;/annotation&gt;     &lt;/enumeration&gt;     &lt;enumeration value="0123004"&gt;       &lt;annotation&gt;         &lt;documentation&gt;nicht relevant, da Primäreingriff&lt;/documentation&gt;       &lt;/annotation&gt;     &lt;/enumeration&gt;     &lt;enumeration value="0123042"&gt;       &lt;annotation&gt;         &lt;documentation&gt;unbekannt&lt;/documentation&gt;       &lt;/annotation&gt;     &lt;/enumeration&gt;   &lt;/restriction&gt; &lt;/simpleType&gt; </pre>		

### simpleType enum\_0124

namespace	http://xml.ir-d.de/sak		
type	restriction of <b>string</b>		
properties	base xs:string		
facets	Kind	Value	Annotation
	enumeration	0124001	documentation Salzlösung
	enumeration	0124002	documentation Silikongel
	enumeration	0124003	documentation Kombination Silikongel und Salzlösung
	enumeration	0124042	documentation sonstige
annotation	documentation Kat_BI_Fuellung		
source	<pre> &lt;simpleType name="enum_0124"&gt;   &lt;annotation&gt;     &lt;documentation&gt;Kat_BI_Fuellung&lt;/documentation&gt;   &lt;/annotation&gt;   &lt;restriction base="xs:string"&gt;     &lt;enumeration value="0124001"&gt;       &lt;annotation&gt;         &lt;documentation&gt;Salzlösung&lt;/documentation&gt;       &lt;/annotation&gt;     &lt;/enumeration&gt;     &lt;enumeration value="0124002"&gt;       &lt;annotation&gt;         &lt;documentation&gt;Silikongel&lt;/documentation&gt;       &lt;/annotation&gt;     &lt;/enumeration&gt;     &lt;enumeration value="0124003"&gt;       &lt;annotation&gt;         &lt;documentation&gt;Kombination Silikongel und Salzlösung&lt;/documentation&gt;       &lt;/annotation&gt;     &lt;/enumeration&gt;     &lt;enumeration value="0124042"&gt;       &lt;annotation&gt;         &lt;documentation&gt;sonstige&lt;/documentation&gt;       &lt;/annotation&gt;     &lt;/enumeration&gt;   &lt;/restriction&gt; &lt;/simpleType&gt; </pre>		

### simpleType enum\_0126

namespace	http://xml.ir-d.de/sak		
type	restriction of <b>string</b>		
properties	base xs:string		
facets	Kind	Value	Annotation
	enumeration	0126001	documentation anatomisch (tropfenförmig)
	enumeration	0126002	documentation rund (punktsymmetrisch)
	enumeration	0126042	documentation

	sonstige
annotation	documentation Kat BI_Form
source	<pre> &lt;simpleType name="enum_0126"&gt;   &lt;annotation&gt;     &lt;documentation&gt;Kat_BI_Form&lt;/documentation&gt;   &lt;/annotation&gt;   &lt;restriction base="xs:string"&gt;     &lt;enumeration value="0126001"&gt;       &lt;annotation&gt;         &lt;documentation&gt;anatomisch (tropfenförmig)&lt;/documentation&gt;       &lt;/annotation&gt;     &lt;/enumeration&gt;     &lt;enumeration value="0126002"&gt;       &lt;annotation&gt;         &lt;documentation&gt;rund (punktsymmetrisch)&lt;/documentation&gt;       &lt;/annotation&gt;     &lt;/enumeration&gt;     &lt;enumeration value="0126042"&gt;       &lt;annotation&gt;         &lt;documentation&gt;sonstige&lt;/documentation&gt;       &lt;/annotation&gt;     &lt;/enumeration&gt;   &lt;/restriction&gt; &lt;/simpleType&gt; </pre>

### simpleType enum\_0128

namespace	http://xml.ir-d.de/sak		
type	restriction of <b>string</b>		
properties	base xs:string		
facets	Kind	Value	Annotation
	enumeration	0128001	documentation glattwandig
	enumeration	0128002	documentation beschichtet
	enumeration	0128003	documentation texturiert
annotation	documentation Kat BI_Oberflaeche		
source	<pre> &lt;simpleType name="enum_0128"&gt;   &lt;annotation&gt;     &lt;documentation&gt;Kat_BI_Oberflaeche&lt;/documentation&gt;   &lt;/annotation&gt;   &lt;restriction base="xs:string"&gt;     &lt;enumeration value="0128001"&gt;       &lt;annotation&gt;         &lt;documentation&gt;glattwandig&lt;/documentation&gt;       &lt;/annotation&gt;     &lt;/enumeration&gt;     &lt;enumeration value="0128002"&gt;       &lt;annotation&gt;         &lt;documentation&gt;beschichtet&lt;/documentation&gt;       &lt;/annotation&gt;     &lt;/enumeration&gt;     &lt;enumeration value="0128003"&gt;       &lt;annotation&gt; </pre>		

```

<documentation>texturiert</documentation>
</annotation>
</enumeration>
</restriction>
</simpleType>

```

### simpleType enum\_0130

namespace	http://xml.ir-d.de/sak		
type	restriction of <b>string</b>		
properties	base xs:string		
facets	Kind	Value	Annotation
	enumeration	0130001	documentation Allergan
	enumeration	0130002	documentation Cereplas
	enumeration	0130003	documentation CUI (Cox Uphoff Implants)
	enumeration	0130004	documentation EMSI Biomedical
	enumeration	0130005	documentation Establishment labs
	enumeration	0130006	documentation Eurosilicone
	enumeration	0130007	documentation Nagor
	enumeration	0130008	documentation Groupe Sebbin
	enumeration	0130009	documentation Laboratoires Arion
	enumeration	0130010	documentation Mentor
	enumeration	0130011	documentation Pérouse Plastie SAS
	enumeration	0130012	documentation PIP M-Implants
	enumeration	0130013	documentation Polytech Health & Aesthetics
	enumeration	0130014	documentation Silimed
	enumeration	0130015	documentation Surgitek
	enumeration	0130016	documentation G&G Biotechnology
	enumeration	0130017	documentation nicht belegter Wert
	enumeration	0130018	documentation nicht belegter Wert
	enumeration	0130019	documentation nicht belegter Wert
	enumeration	0130020	documentation nicht belegter Wert
	enumeration	0130021	documentation nicht belegter Wert
	enumeration	0130042	documentation sonstiger
annotation	documentation Kat_BI_Hersteller		
source	<simpleType name="enum_0130"> <annotation>		



```
<documentation>Kat_BI_Hersteller</documentation>
</annotation>
<restriction base="xs:string">
  <enumeration value="0130001">
    <annotation>
      <documentation>Allergan</documentation>
    </annotation>
  </enumeration>
  <enumeration value="0130002">
    <annotation>
      <documentation>Cereplas</documentation>
    </annotation>
  </enumeration>
  <enumeration value="0130003">
    <annotation>
      <documentation>CUI (Cox Uphoff Implants)</documentation>
    </annotation>
  </enumeration>
  <enumeration value="0130004">
    <annotation>
      <documentation>EMSI Biomedical</documentation>
    </annotation>
  </enumeration>
  <enumeration value="0130005">
    <annotation>
      <documentation>Establishment labs</documentation>
    </annotation>
  </enumeration>
  <enumeration value="0130006">
    <annotation>
      <documentation>Eurosilicone</documentation>
    </annotation>
  </enumeration>
  <enumeration value="0130007">
    <annotation>
      <documentation>Nagor</documentation>
    </annotation>
  </enumeration>
  <enumeration value="0130008">
    <annotation>
      <documentation>Groupe Sebbin</documentation>
    </annotation>
  </enumeration>
  <enumeration value="0130009">
    <annotation>
      <documentation>Laboratoires Arion</documentation>
    </annotation>
  </enumeration>
  <enumeration value="0130010">
    <annotation>
      <documentation>Mentor</documentation>
    </annotation>
  </enumeration>
  <enumeration value="0130011">
    <annotation>
      <documentation>Pérouse Plastie SAS</documentation>
    </annotation>
  </enumeration>
  <enumeration value="0130012">
```

```
<annotation>
  <documentation>PIP M-Implants</documentation>
</annotation>
</enumeration>
<enumeration value="0130013">
  <annotation>
    <documentation>Polytech Health & Aesthetics</documentation>
  </annotation>
</enumeration>
<enumeration value="0130014">
  <annotation>
    <documentation>Silimed</documentation>
  </annotation>
</enumeration>
<enumeration value="0130015">
  <annotation>
    <documentation>Surgitek</documentation>
  </annotation>
</enumeration>
<enumeration value="0130016">
  <annotation>
    <documentation>G&G Biotechnology</documentation>
  </annotation>
</enumeration>
<enumeration value="0130017">
  <annotation>
    <documentation>nicht belegter Wert</documentation>
  </annotation>
</enumeration>
<enumeration value="0130018">
  <annotation>
    <documentation>nicht belegter Wert</documentation>
  </annotation>
</enumeration>
<enumeration value="0130019">
  <annotation>
    <documentation>nicht belegter Wert</documentation>
  </annotation>
</enumeration>
<enumeration value="0130020">
  <annotation>
    <documentation>nicht belegter Wert</documentation>
  </annotation>
</enumeration>
<enumeration value="0130021">
  <annotation>
    <documentation>nicht belegter Wert</documentation>
  </annotation>
</enumeration>
<enumeration value="0130042">
  <annotation>
    <documentation>sonstiger</documentation>
  </annotation>
</enumeration>
</restriction>
</simpleType>
```

### simpleType enum\_0131

namespace	http://xml.ir-d.de/sak		
type	restriction of <b>string</b>		
properties	base xs:string		
facets	Kind	Value	Annotation
	enumeration	0131001	documentation Allergan
	enumeration	0131002	documentation Establishment labs
	enumeration	0131003	documentation Eurosilicone
	enumeration	0131004	documentation Galatea
	enumeration	0131005	documentation Integra
	enumeration	0131006	documentation Lifecell
	enumeration	0131007	documentation MBP (Medical Biomaterial Products)
	enumeration	0131008	documentation Mentor
	enumeration	0131009	documentation Novus Scientific
	enumeration	0131010	documentation pfmMedical
	enumeration	0131011	documentation nicht belegter Wert
	enumeration	0131012	documentation nicht belegter Wert
	enumeration	0131013	documentation nicht belegter Wert
	enumeration	0131014	documentation nicht belegter Wert
	enumeration	0131015	documentation nicht belegter Wert
	enumeration	0131042	documentation sonstiger
annotation	documentation Kat_BI_ZubehoerHersteller		
source	<pre> &lt;simpleType name="enum_0131"&gt;   &lt;annotation&gt;     &lt;documentation&gt;Kat_BI_ZubehoerHersteller&lt;/documentation&gt;   &lt;/annotation&gt;   &lt;restriction base="xs:string"&gt;     &lt;enumeration value="0131001"&gt;       &lt;annotation&gt;         &lt;documentation&gt;Allergan&lt;/documentation&gt;       &lt;/annotation&gt;     &lt;/enumeration&gt;     &lt;enumeration value="0131002"&gt;       &lt;annotation&gt;         &lt;documentation&gt;Establishment labs&lt;/documentation&gt;       &lt;/annotation&gt;     &lt;/enumeration&gt;     &lt;enumeration value="0131003"&gt;       &lt;annotation&gt;         &lt;documentation&gt;Eurosilicone&lt;/documentation&gt;       &lt;/annotation&gt;     &lt;/enumeration&gt;     &lt;enumeration value="0131004"&gt; </pre>		

```
<annotation>
  <documentation>Galatea</documentation>
</annotation>
</enumeration>
<enumeration value="0131005">
  <annotation>
    <documentation>Integra</documentation>
  </annotation>
</enumeration>
<enumeration value="0131006">
  <annotation>
    <documentation>Lifecell</documentation>
  </annotation>
</enumeration>
<enumeration value="0131007">
  <annotation>
    <documentation>MBP (Medical Biomaterial Products)</documentation>
  </annotation>
</enumeration>
<enumeration value="0131008">
  <annotation>
    <documentation>Mentor</documentation>
  </annotation>
</enumeration>
<enumeration value="0131009">
  <annotation>
    <documentation>Novus Scientific</documentation>
  </annotation>
</enumeration>
<enumeration value="0131010">
  <annotation>
    <documentation>pfmMedical</documentation>
  </annotation>
</enumeration>
<enumeration value="0131011">
  <annotation>
    <documentation>nicht belegter Wert</documentation>
  </annotation>
</enumeration>
<enumeration value="0131012">
  <annotation>
    <documentation>nicht belegter Wert</documentation>
  </annotation>
</enumeration>
<enumeration value="0131013">
  <annotation>
    <documentation>nicht belegter Wert</documentation>
  </annotation>
</enumeration>
<enumeration value="0131014">
  <annotation>
    <documentation>nicht belegter Wert</documentation>
  </annotation>
</enumeration>
<enumeration value="0131015">
  <annotation>
    <documentation>nicht belegter Wert</documentation>
  </annotation>
</enumeration>
```

	<pre> &lt;enumeration value="0131042"&gt;   &lt;annotation&gt;     &lt;documentation&gt;sonstiger&lt;/documentation&gt;   &lt;/annotation&gt; &lt;/enumeration&gt; &lt;/restriction&gt; &lt;/simpleType&gt; </pre>
--	--

### simpleType enum\_0190

namespace	http://xml.ir-d.de/sak		
type	restriction of <b>string</b>		
properties	base xs:string		
facets	Kind	Value	Annotation
	enumeration	0190001	documentation Brustimplantat
	enumeration	0190003	documentation Brustexpander
annotation	documentation Kat_BI_Artikeltyp		
source	<pre> &lt;simpleType name="enum_0190"&gt;   &lt;annotation&gt;     &lt;documentation&gt;Kat_BI_Artikeltyp&lt;/documentation&gt;   &lt;/annotation&gt;   &lt;restriction base="xs:string"&gt;     &lt;enumeration value="0190001"&gt;       &lt;annotation&gt;         &lt;documentation&gt;Brustimplantat&lt;/documentation&gt;       &lt;/annotation&gt;     &lt;/enumeration&gt;     &lt;enumeration value="0190003"&gt;       &lt;annotation&gt;         &lt;documentation&gt;Brustexpander&lt;/documentation&gt;       &lt;/annotation&gt;     &lt;/enumeration&gt;   &lt;/restriction&gt; &lt;/simpleType&gt; </pre>		

### simpleType enum\_0191

namespace	http://xml.ir-d.de/sak		
type	restriction of <b>string</b>		
properties	base xs:string		
facets	Kind	Value	Annotation
	enumeration	0191001	documentation Netz
	enumeration	0191002	documentation ADM
annotation	documentation Kat_BI_ZubehoerTyp		
source	<pre> &lt;simpleType name="enum_0191"&gt;   &lt;annotation&gt;     &lt;documentation&gt;Kat_BI_ZubehoerTyp&lt;/documentation&gt;   &lt;/annotation&gt; </pre>		

	<pre> &lt;restriction base="xs:string"&gt;   &lt;enumeration value="0191001"&gt;     &lt;annotation&gt;       &lt;documentation&gt;Netz&lt;/documentation&gt;     &lt;/annotation&gt;   &lt;/enumeration&gt;   &lt;enumeration value="0191002"&gt;     &lt;annotation&gt;       &lt;documentation&gt;ADM&lt;/documentation&gt;     &lt;/annotation&gt;   &lt;/enumeration&gt; &lt;/restriction&gt; &lt;/simpleType&gt; </pre>
--	---

### simpleType enum\_0200

namespace	http://xml.ir-d.de/sak		
type	restriction of <b>string</b>		
properties	base xs:string		
facets	Kind	Value	Annotation
	enumeration	0200001	documentation Erst-OP
	enumeration	0200002	documentation Folgeeingriff
annotation	documentation Kat_EP_ArtEingriff		
source	<pre> &lt;simpleType name="enum_0200"&gt;   &lt;annotation&gt;     &lt;documentation&gt;Kat_EP_ArtEingriff&lt;/documentation&gt;   &lt;/annotation&gt;   &lt;restriction base="xs:string"&gt;     &lt;enumeration value="0200001"&gt;       &lt;annotation&gt;         &lt;documentation&gt;Erst-OP&lt;/documentation&gt;       &lt;/annotation&gt;     &lt;/enumeration&gt;     &lt;enumeration value="0200002"&gt;       &lt;annotation&gt;         &lt;documentation&gt;Folgeeingriff&lt;/documentation&gt;       &lt;/annotation&gt;     &lt;/enumeration&gt;   &lt;/restriction&gt; &lt;/simpleType&gt; </pre>		

### simpleType enum\_0202

namespace	http://xml.ir-d.de/sak		
type	restriction of <b>string</b>		
properties	base xs:string		
facets	Kind	Value	Annotation
	enumeration	0202001	documentation Lockerung
	enumeration	0202002	documentation Infektion, Verdacht auf

	<p>enumeration 0202003 documentation Infektion, gesichert</p> <p>enumeration 0202004 documentation Luxation, Inlay aus der Pfanne</p> <p>enumeration 0202005 documentation Luxation, Kopf aus Pfanne/Inlay</p> <p>enumeration 0202006 documentation Periprothetische Fraktur</p> <p>enumeration 0202007 documentation Verschleiß des PE-Inlays</p> <p>enumeration 0202008 documentation Implantatbruch</p> <p>enumeration 0202009 documentation Implantatfehlage/Malalignement</p> <p>enumeration 0202010 documentation Osteolysen bei festem Implantat</p> <p>enumeration 0202011 documentation Progression der Grunderkrankung</p> <p>enumeration 0202012 documentation ARM D</p> <p>enumeration 0202013 documentation Verdacht auf allergische Reaktion</p> <p>enumeration 0202021 documentation Zustand nach Prothesenentfernung</p> <p>enumeration 0202042 documentation andere Gründe</p>
annotation	documentation Kat_EP_GrundWechselHuefte
source	<pre> &lt;simpleType name="enum_0202"&gt;   &lt;annotation&gt;     &lt;documentation&gt;Kat_EP_GrundWechselHuefte&lt;/documentation&gt;   &lt;/annotation&gt;   &lt;restriction base="xs:string"&gt;     &lt;enumeration value="0202001"&gt;       &lt;annotation&gt;         &lt;documentation&gt;Lockerung&lt;/documentation&gt;       &lt;/annotation&gt;     &lt;/enumeration&gt;     &lt;enumeration value="0202002"&gt;       &lt;annotation&gt;         &lt;documentation&gt;Infektion, Verdacht auf&lt;/documentation&gt;       &lt;/annotation&gt;     &lt;/enumeration&gt;     &lt;enumeration value="0202003"&gt;       &lt;annotation&gt;         &lt;documentation&gt;Infektion, gesichert&lt;/documentation&gt;       &lt;/annotation&gt;     &lt;/enumeration&gt;     &lt;enumeration value="0202004"&gt;       &lt;annotation&gt;         &lt;documentation&gt;Luxation, Inlay aus der Pfanne&lt;/documentation&gt;       &lt;/annotation&gt;     &lt;/enumeration&gt;     &lt;enumeration value="0202005"&gt;       &lt;annotation&gt;         &lt;documentation&gt;Luxation, Kopf aus Pfanne/Inlay&lt;/documentation&gt;       &lt;/annotation&gt;     &lt;/enumeration&gt;     &lt;enumeration value="0202006"&gt;       &lt;annotation&gt;         &lt;documentation&gt;Periprothetische Fraktur&lt;/documentation&gt;       &lt;/annotation&gt;     &lt;/enumeration&gt;   &lt;/restriction&gt; &lt;/simpleType&gt; </pre>

```

</annotation>
</enumeration>
<enumeration value="0202007">
  <annotation>
    <documentation>Verschleiß des PE-Inlays</documentation>
  </annotation>
</enumeration>
<enumeration value="0202008">
  <annotation>
    <documentation>Implantatbruch</documentation>
  </annotation>
</enumeration>
<enumeration value="0202009">
  <annotation>
    <documentation>Implantatfehlloge/Malalignement</documentation>
  </annotation>
</enumeration>
<enumeration value="0202010">
  <annotation>
    <documentation>Osteolysen bei festem Implantat</documentation>
  </annotation>
</enumeration>
<enumeration value="0202011">
  <annotation>
    <documentation>Progression der Grunderkrankung</documentation>
  </annotation>
</enumeration>
<enumeration value="0202012">
  <annotation>
    <documentation>ARMD</documentation>
  </annotation>
</enumeration>
<enumeration value="0202013">
  <annotation>
    <documentation>Verdacht auf allergische Reaktion</documentation>
  </annotation>
</enumeration>
<enumeration value="0202021">
  <annotation>
    <documentation>Zustand nach Prothesenentfernung</documentation>
  </annotation>
</enumeration>
<enumeration value="0202042">
  <annotation>
    <documentation>andere Gründe</documentation>
  </annotation>
</enumeration>
</restriction>
</simpleType>

```

#### simpleType enum\_0204

namespace	http://xml.ir-d.de/sak
type	restriction of <b>string</b>
properties	base xs:string
facets	Kind Value Annotation



	<p>enumeration 0204001 documentation Lockerung</p> <p>enumeration 0204002 documentation Infektion, Verdacht auf</p> <p>enumeration 0204003 documentation Infektion, gesichert</p> <p>enumeration 0204006 documentation Periprothetische Fraktur</p> <p>enumeration 0204007 documentation Verschleiß</p> <p>enumeration 0204008 documentation Implantatbruch</p> <p>enumeration 0204009 documentation Implantatfehlhage/Malalignent</p> <p>enumeration 0204010 documentation Osteolysen bei festem Implantat</p> <p>enumeration 0204011 documentation Progression der Grunderkrankung</p> <p>enumeration 0204012 documentation ARM D</p> <p>enumeration 0204013 documentation Verdacht auf allergische Reaktion</p> <p>enumeration 0204014 documentation Dislokation/Migration von Komponenten</p> <p>enumeration 0204015 documentation Bandinstabilität</p> <p>enumeration 0204016 documentation Bewegungseinschränkung</p> <p>enumeration 0204021 documentation Zustand nach Prothesenentfernung</p> <p>enumeration 0204042 documentation andere Gründe</p>
annotation	documentation Kat_EP_GrundWechselKnie
source	<pre> &lt;simpleType name="enum_0204"&gt;   &lt;annotation&gt;     &lt;documentation&gt;Kat_EP_GrundWechselKnie&lt;/documentation&gt;   &lt;/annotation&gt;   &lt;restriction base="xs:string"&gt;     &lt;enumeration value="0204001"&gt;       &lt;annotation&gt;         &lt;documentation&gt;Lockerung&lt;/documentation&gt;       &lt;/annotation&gt;     &lt;/enumeration&gt;     &lt;enumeration value="0204002"&gt;       &lt;annotation&gt;         &lt;documentation&gt;Infektion, Verdacht auf&lt;/documentation&gt;       &lt;/annotation&gt;     &lt;/enumeration&gt;     &lt;enumeration value="0204003"&gt;       &lt;annotation&gt;         &lt;documentation&gt;Infektion, gesichert&lt;/documentation&gt;       &lt;/annotation&gt;     &lt;/enumeration&gt;     &lt;enumeration value="0204006"&gt;       &lt;annotation&gt;         &lt;documentation&gt;Periprothetische Fraktur&lt;/documentation&gt;       &lt;/annotation&gt;     &lt;/enumeration&gt;     &lt;enumeration value="0204007"&gt;       &lt;annotation&gt;         &lt;documentation&gt;Verschleiß&lt;/documentation&gt;       &lt;/annotation&gt;     &lt;/enumeration&gt;   &lt;/restriction&gt; &lt;/simpleType&gt; </pre>

```
</annotation>
</enumeration>
<enumeration value="0204008">
  <annotation>
    <documentation>Implantatbruch</documentation>
  </annotation>
</enumeration>
<enumeration value="0204009">
  <annotation>
    <documentation>Implantatfehllage/Malalignement</documentation>
  </annotation>
</enumeration>
<enumeration value="0204010">
  <annotation>
    <documentation>Osteolysen bei festem Implantat</documentation>
  </annotation>
</enumeration>
<enumeration value="0204011">
  <annotation>
    <documentation>Progression der Grunderkrankung</documentation>
  </annotation>
</enumeration>
<enumeration value="0204012">
  <annotation>
    <documentation>ARMD</documentation>
  </annotation>
</enumeration>
<enumeration value="0204013">
  <annotation>
    <documentation>Verdacht auf allergische Reaktion</documentation>
  </annotation>
</enumeration>
<enumeration value="0204014">
  <annotation>
    <documentation>Dislokation/Migration von Komponenten</documentation>
  </annotation>
</enumeration>
<enumeration value="0204015">
  <annotation>
    <documentation>Bandinstabilität</documentation>
  </annotation>
</enumeration>
<enumeration value="0204016">
  <annotation>
    <documentation>Bewegungseinschränkung</documentation>
  </annotation>
</enumeration>
<enumeration value="0204021">
  <annotation>
    <documentation>Zustand nach Prothesenentfernung</documentation>
  </annotation>
</enumeration>
<enumeration value="0204042">
  <annotation>
    <documentation>andere Gründe</documentation>
  </annotation>
</enumeration>
</restriction>
</simpleType>
```

### simpleType enum 0206

namespace	http://xml.ir-d.de/sak		
type	restriction of <b>string</b>		
properties	base xs:string		
facets	Kind	Value	Annotation
	enumeration	0206001	documentation Lockerung
	enumeration	0206002	documentation Infektion, Verdacht auf
	enumeration	0206003	documentation Infektion, gesichert
	enumeration	0206004	documentation Luxation, Inlay aus der Pfanne
	enumeration	0206005	documentation Luxation, Kopf aus Pfanne/Inlay
	enumeration	0206006	documentation Periprothetische Fraktur
	enumeration	0206007	documentation Verschleiß
	enumeration	0206008	documentation Implantatbruch
	enumeration	0206009	documentation Implantatfehlage/Malalignement
	enumeration	0206010	documentation Osteolysen bei festem Implantat
	enumeration	0206011	documentation Progression der Grunderkrankung
	enumeration	0206012	documentation ARM-D
	enumeration	0206013	documentation Verdacht auf allergische Reaktion
	enumeration	0206014	documentation Dislokation/Migration von Komponenten
	enumeration	0206015	documentation Bandinstabilität
	enumeration	0206016	documentation Bewegungseinschränkung
	enumeration	0206021	documentation Zustand nach Prothesenentfernung
	enumeration	0206042	documentation andere Gründe
annotation	documentation Kat_EP_GrundWechselTFE		
source	<pre> &lt;simpleType name="enum_0206"&gt;   &lt;annotation&gt;     &lt;documentation&gt;Kat_EP_GrundWechselTFE&lt;/documentation&gt;   &lt;/annotation&gt;   &lt;restriction base="xs:string"&gt;     &lt;enumeration value="0206001"&gt;       &lt;annotation&gt;         &lt;documentation&gt;Lockerung&lt;/documentation&gt;       &lt;/annotation&gt;     &lt;/enumeration&gt;     &lt;enumeration value="0206002"&gt;       &lt;annotation&gt;         &lt;documentation&gt;Infektion, Verdacht auf&lt;/documentation&gt;       &lt;/annotation&gt;     &lt;/enumeration&gt;   &lt;/restriction&gt; </pre>		

```
<enumeration value="0206003">
  <annotation>
    <documentation>Infektion, gesichert</documentation>
  </annotation>
</enumeration>
<enumeration value="0206004">
  <annotation>
    <documentation>Luxation, Inlay aus der Pfanne</documentation>
  </annotation>
</enumeration>
<enumeration value="0206005">
  <annotation>
    <documentation>Luxation, Kopf aus Pfanne/Inlay</documentation>
  </annotation>
</enumeration>
<enumeration value="0206006">
  <annotation>
    <documentation>Periprothetische Fraktur</documentation>
  </annotation>
</enumeration>
<enumeration value="0206007">
  <annotation>
    <documentation>Verschleiß</documentation>
  </annotation>
</enumeration>
<enumeration value="0206008">
  <annotation>
    <documentation>Implantatbruch</documentation>
  </annotation>
</enumeration>
<enumeration value="0206009">
  <annotation>
    <documentation>Implantatfehllage/Malalignent</documentation>
  </annotation>
</enumeration>
<enumeration value="0206010">
  <annotation>
    <documentation>Osteolysen bei festem Implantat</documentation>
  </annotation>
</enumeration>
<enumeration value="0206011">
  <annotation>
    <documentation>Progression der Grunderkrankung</documentation>
  </annotation>
</enumeration>
<enumeration value="0206012">
  <annotation>
    <documentation>ARMD</documentation>
  </annotation>
</enumeration>
<enumeration value="0206013">
  <annotation>
    <documentation>Verdacht auf allergische Reaktion</documentation>
  </annotation>
</enumeration>
<enumeration value="0206014">
  <annotation>
    <documentation>Dislokation/Migration von Komponenten</documentation>
  </annotation>
</enumeration>
```

	<pre> &lt;/enumeration&gt; &lt;enumeration value="0206015"&gt;   &lt;annotation&gt;     &lt;documentation&gt;Bandinstabilität&lt;/documentation&gt;   &lt;/annotation&gt; &lt;/enumeration&gt; &lt;enumeration value="0206016"&gt;   &lt;annotation&gt;     &lt;documentation&gt;Bewegungseinschränkung&lt;/documentation&gt;   &lt;/annotation&gt; &lt;/enumeration&gt; &lt;enumeration value="0206021"&gt;   &lt;annotation&gt;     &lt;documentation&gt;Zustand nach Prothesenentfernung&lt;/documentation&gt;   &lt;/annotation&gt; &lt;/enumeration&gt; &lt;enumeration value="0206042"&gt;   &lt;annotation&gt;     &lt;documentation&gt;andere Gründe&lt;/documentation&gt;   &lt;/annotation&gt; &lt;/enumeration&gt; &lt;/restriction&gt; &lt;/simpleType&gt; </pre>
--	---

### simpleType enum\_0210

namespace	http://xml.ir-d.de/sak		
type	restriction of <b>string</b>		
properties	base xs:string		
facets	Kind	Value	Annotation
	enumeration	0210001	documentation keine relevante Voroperation
	enumeration	0210002	documentation Osteosynthese/Osteotomie (Becken)
	enumeration	0210003	documentation Osteosynthese/Osteotomie (Femur)
	enumeration	0210004	documentation Osteosynthese/Osteotomie (beides)
	enumeration	0210005	documentation Operation bei Hüftkopfnekrose
	enumeration	0210006	documentation Arthrodese
	enumeration	0210042	documentation andere
annotation	documentation Kat_EP_VoroperationHuefte		
source	<pre> &lt;simpleType name="enum_0210"&gt;   &lt;annotation&gt;     &lt;documentation&gt;Kat_EP_VoroperationHuefte&lt;/documentation&gt;   &lt;/annotation&gt;   &lt;restriction base="xs:string"&gt;     &lt;enumeration value="0210001"&gt;       &lt;annotation&gt;         &lt;documentation&gt;keine relevante Voroperation&lt;/documentation&gt;       &lt;/annotation&gt;     &lt;/enumeration&gt;     &lt;enumeration value="0210002"&gt; </pre>		

	<pre> &lt;annotation&gt;   &lt;documentation&gt;Osteosynthese/Osteotomie (Becken)&lt;/documentation&gt; &lt;/annotation&gt; &lt;/enumeration&gt; &lt;enumeration value="0210003"&gt;   &lt;annotation&gt;     &lt;documentation&gt;Osteosynthese/Osteotomie (Femur)&lt;/documentation&gt;   &lt;/annotation&gt; &lt;/enumeration&gt; &lt;enumeration value="0210004"&gt;   &lt;annotation&gt;     &lt;documentation&gt;Osteosynthese/Osteotomie (beides)&lt;/documentation&gt;   &lt;/annotation&gt; &lt;/enumeration&gt; &lt;enumeration value="0210005"&gt;   &lt;annotation&gt;     &lt;documentation&gt;Operation bei Hüftkopfnekrose&lt;/documentation&gt;   &lt;/annotation&gt; &lt;/enumeration&gt; &lt;enumeration value="0210006"&gt;   &lt;annotation&gt;     &lt;documentation&gt;Arthrodesse&lt;/documentation&gt;   &lt;/annotation&gt; &lt;/enumeration&gt; &lt;enumeration value="0210042"&gt;   &lt;annotation&gt;     &lt;documentation&gt;andere&lt;/documentation&gt;   &lt;/annotation&gt; &lt;/enumeration&gt; &lt;/restriction&gt; &lt;/simpleType&gt; </pre>
--	---

### simpleType enum\_0211

namespace	http://xml.ir-d.de/sak		
type	restriction of <b>string</b>		
properties	base xs:string		
facets	Kind	Value	Annotation
	enumeration	0211001	documentation keine relevante Voroperation
	enumeration	0211002	documentation Osteosynthese/Osteotomie (Femur)
	enumeration	0211003	documentation Osteosynthese/Osteotomie (Tibia)
	enumeration	0211004	documentation Osteosynthese/Osteotomie (Patella)
	enumeration	0211005	documentation Osteosynthese/Osteotomie (mehrere)
	enumeration	0211006	documentation Kapsel-/Bandapparat
	enumeration	0211007	documentation Arthrodesse
	enumeration	0211042	documentation andere
annotation	documentation Kat_EP_VoroperationKnie		
source	<pre> &lt;simpleType name="enum_0211"&gt;   &lt;annotation&gt; </pre>		

```

<documentation>Kat_EP_VoroperationKnie</documentation>
</annotation>
<restriction base="xs:string">
  <enumeration value="0211001">
    <annotation>
      <documentation>keine relevante Voroperation</documentation>
    </annotation>
  </enumeration>
  <enumeration value="0211002">
    <annotation>
      <documentation>Osteosynthese/Osteotomie (Femur)</documentation>
    </annotation>
  </enumeration>
  <enumeration value="0211003">
    <annotation>
      <documentation>Osteosynthese/Osteotomie (Tibia)</documentation>
    </annotation>
  </enumeration>
  <enumeration value="0211004">
    <annotation>
      <documentation>Osteosynthese/Osteotomie (Patella)</documentation>
    </annotation>
  </enumeration>
  <enumeration value="0211005">
    <annotation>
      <documentation>Osteosynthese/Osteotomie (mehrere)</documentation>
    </annotation>
  </enumeration>
  <enumeration value="0211006">
    <annotation>
      <documentation>Kapsel-/Bandapparat</documentation>
    </annotation>
  </enumeration>
  <enumeration value="0211007">
    <annotation>
      <documentation>Arthrodesse</documentation>
    </annotation>
  </enumeration>
  <enumeration value="0211042">
    <annotation>
      <documentation>andere</documentation>
    </annotation>
  </enumeration>
</restriction>
</simpleType>

```

### simpleType enum\_0212

namespace	http://xml.ir-d.de/sak		
type	restriction of <b>string</b>		
properties	base xs:string		
facets	Kind	Value	Annotation
	enumeration	0212001	documentation Hüfte
	enumeration	0212002	documentation Knie
	enumeration	0212003	documentation

	Totaler Femurersatz inkl. Durchsteck-Prothese
annotation	documentation Kat_EP_Gelenk
source	<pre> &lt;simpleType name="enum_0212"&gt;   &lt;annotation&gt;     &lt;documentation&gt;Kat_EP_Gelenk&lt;/documentation&gt;   &lt;/annotation&gt;   &lt;restriction base="xs:string"&gt;     &lt;enumeration value="0212001"&gt;       &lt;annotation&gt;         &lt;documentation&gt;Hüfte&lt;/documentation&gt;       &lt;/annotation&gt;     &lt;/enumeration&gt;     &lt;enumeration value="0212002"&gt;       &lt;annotation&gt;         &lt;documentation&gt;Knie&lt;/documentation&gt;       &lt;/annotation&gt;     &lt;/enumeration&gt;     &lt;enumeration value="0212003"&gt;       &lt;annotation&gt;         &lt;documentation&gt;Totaler Femurersatz inkl. Durchsteck-Prothese&lt;/documentation&gt;       &lt;/annotation&gt;     &lt;/enumeration&gt;   &lt;/restriction&gt; &lt;/simpleType&gt; </pre>

### simpleType enum\_0220

namespace	http://xml.ir-d.de/sak		
type	restriction of <b>string</b>		
properties	base	xs:string	
facets	Kind	Value	Annotation
	enumeration	0220001	documentation anterior
	enumeration	0220002	documentation anterolateral
	enumeration	0220003	documentation lateral
	enumeration	0220004	documentation posterior
	enumeration	0220005	documentation posterolateral
	enumeration	0220006	documentation 2-Inzisionen-Zugang
	enumeration	0220042	documentation sonstiges/unbekannt
annotation	documentation Kat_EP_Operationszugang		
source	<pre> &lt;simpleType name="enum_0220"&gt;   &lt;annotation&gt;     &lt;documentation&gt;Kat_EP_Operationszugang&lt;/documentation&gt;   &lt;/annotation&gt;   &lt;restriction base="xs:string"&gt;     &lt;enumeration value="0220001"&gt;       &lt;annotation&gt;         &lt;documentation&gt;anterior&lt;/documentation&gt; </pre>		



	<pre> &lt;/annotation&gt; &lt;/enumeration&gt; &lt;enumeration value="0220002"&gt;   &lt;annotation&gt;     &lt;documentation&gt;anterolateral&lt;/documentation&gt;   &lt;/annotation&gt; &lt;/enumeration&gt; &lt;enumeration value="0220003"&gt;   &lt;annotation&gt;     &lt;documentation&gt;lateral&lt;/documentation&gt;   &lt;/annotation&gt; &lt;/enumeration&gt; &lt;enumeration value="0220004"&gt;   &lt;annotation&gt;     &lt;documentation&gt;posterior&lt;/documentation&gt;   &lt;/annotation&gt; &lt;/enumeration&gt; &lt;enumeration value="0220005"&gt;   &lt;annotation&gt;     &lt;documentation&gt;posterolateral&lt;/documentation&gt;   &lt;/annotation&gt; &lt;/enumeration&gt; &lt;enumeration value="0220006"&gt;   &lt;annotation&gt;     &lt;documentation&gt;2-Inzisionen-Zugang&lt;/documentation&gt;   &lt;/annotation&gt; &lt;/enumeration&gt; &lt;enumeration value="0220042"&gt;   &lt;annotation&gt;     &lt;documentation&gt;sonstiges/unbekannt&lt;/documentation&gt;   &lt;/annotation&gt; &lt;/enumeration&gt; &lt;/restriction&gt; &lt;/simpleType&gt; </pre>
--	---

**simpleType enum 0222**

namespace	http://xml.lir-d.de/sak		
type	restriction of <b>string</b>		
properties	base xs:string		
facets	Kind	Value	Annotation
	enumeration	0222001	documentation nein
	enumeration	0222002	documentation ja- Ausbau
	enumeration	0222003	documentation ja- Einbau
annotation	documentation Kat_EP_Zweizeitwechsel		
source	<pre> &lt;simpleType name="enum_0222"&gt;   &lt;annotation&gt;     &lt;documentation&gt;Kat_EP_Zweizeitwechsel&lt;/documentation&gt;   &lt;/annotation&gt;   &lt;restriction base="xs:string"&gt;     &lt;enumeration value="0222001"&gt;       &lt;annotation&gt;         &lt;documentation&gt;nein&lt;/documentation&gt; </pre>		

```

</annotation>
</enumeration>
<enumeration value="0222002">
  <annotation>
    <documentation>ja- Ausbau</documentation>
  </annotation>
</enumeration>
<enumeration value="0222003">
  <annotation>
    <documentation>ja- Einbau</documentation>
  </annotation>
</enumeration>
</restriction>
</simpleType>

```

### simpleType enum\_0230

namespace	http://xml.ir-d.de/sak		
type	restriction of <b>string</b>		
properties	base xs:string		
facets	Kind	Value	Annotation
	enumeration	0230001	documentation Smith & Nephew GmbH
	enumeration	0230002	documentation Mathys Orthopädie GmbH
	enumeration	0230003	documentation Ceramtec AG
	enumeration	0230004	documentation Biomet
	enumeration	0230005	documentation Peter Brehm GmbH
	enumeration	0230006	documentation Amplitude GmbH
	enumeration	0230007	documentation Exactech Deutschland
	enumeration	0230008	documentation Globus Medical
	enumeration	0230009	documentation Implantcast GmbH
	enumeration	0230010	documentation DePuy Orthopädie GmbH (J&J)
	enumeration	0230011	documentation IO-International Orthopaedics
	enumeration	0230012	documentation Joint Replacement Ltd. Instrumentation
	enumeration	0230013	documentation Merete
	enumeration	0230014	documentation S&G Implants GmbH
	enumeration	0230015	documentation Speetec Implantate GmbH
	enumeration	0230016	documentation Stemcup Medical Products GmbH
	enumeration	0230017	documentation Symbios Deutschland GmbH
	enumeration	0230018	documentation Tantum AG
	enumeration	0230019	documentation Tornier GmbH
	enumeration	0230020	documentation

enumeration	0230021	MicroPort Orthopedics GmbH documentation
enumeration	0230022	aap Implanate AG documentation
enumeration	0230023	AQImplants documentation
enumeration	0230024	ESKA Orthodynamics GmbH documentation
enumeration	0230025	Atesos medical AG documentation
enumeration	0230026	Chiropro GmbH documentation
enumeration	0230027	Medacta documentation
enumeration	0230028	OHST Medizintechnik AG documentation
enumeration	0230029	Lima Deutschland GmbH documentation
enumeration	0230030	alloPlus GmbH documentation
enumeration	0230031	Heraeus Medical GmbH documentation
enumeration	0230032	ImplanTec Deutschland GmbH documentation
enumeration	0230033	Falcon Medical GmbH documentation
enumeration	0230034	Meril GmbH documentation
enumeration	0230035	Zimmer Germany GmbH documentation
enumeration	0230036	Stryker GmbH & Co. KG documentation
enumeration	0230037	Aesculap AG documentation
enumeration	0230038	Waldemar Link GmbH & Co. KG documentation
enumeration	0230039	Corin Germany GmbH documentation
enumeration	0230040	ARTIQO documentation
enumeration	0230041	EuromedImplants documentation
enumeration	0230042	EvolutisGroup documentation
enumeration	0230043	sonstige documentation
enumeration	0230044	TEKNIMED SAS documentation
enumeration	0230045	HiPer Medical AG documentation
enumeration	0230046	Link Italia S.p.A. documentation
enumeration	0230047	Johnson & Johnson Medical GmbH documentation
enumeration	0230048	MatOrtho Limited documentation
enumeration	0230049	Adler Ortho S.P.A. documentation
enumeration	0230050	Lincotek Bologna SRL documentation
enumeration	0230051	Materialise documentation
enumeration	0230052	Maxx Orthopedics Inc. documentation
		JRI Orthopaedics

	<p>enumeration 0230053 documentation nicht belegter Wert</p> <p>enumeration 0230054 documentation nicht belegter Wert</p> <p>enumeration 0230055 documentation nicht belegter Wert</p> <p>enumeration 0230056 documentation nicht belegter Wert</p> <p>enumeration 0230057 documentation nicht belegter Wert</p> <p>enumeration 0230058 documentation nicht belegter Wert</p> <p>enumeration 0230059 documentation nicht belegter Wert</p>
annotation	documentation Kat_EP_Hersteller
source	<pre> &lt;simpleType name="enum_0230"&gt;   &lt;annotation&gt;     &lt;documentation&gt;Kat_EP_Hersteller&lt;/documentation&gt;   &lt;/annotation&gt;   &lt;restriction base="xs:string"&gt;     &lt;enumeration value="0230001"&gt;       &lt;annotation&gt;         &lt;documentation&gt;Smith &amp; Nephew GmbH&lt;/documentation&gt;       &lt;/annotation&gt;     &lt;/enumeration&gt;     &lt;enumeration value="0230002"&gt;       &lt;annotation&gt;         &lt;documentation&gt;Mathys Orthopädie GmbH&lt;/documentation&gt;       &lt;/annotation&gt;     &lt;/enumeration&gt;     &lt;enumeration value="0230003"&gt;       &lt;annotation&gt;         &lt;documentation&gt;Ceramtec AG&lt;/documentation&gt;       &lt;/annotation&gt;     &lt;/enumeration&gt;     &lt;enumeration value="0230004"&gt;       &lt;annotation&gt;         &lt;documentation&gt;Biomet&lt;/documentation&gt;       &lt;/annotation&gt;     &lt;/enumeration&gt;     &lt;enumeration value="0230005"&gt;       &lt;annotation&gt;         &lt;documentation&gt;Peter Brehm GmbH&lt;/documentation&gt;       &lt;/annotation&gt;     &lt;/enumeration&gt;     &lt;enumeration value="0230006"&gt;       &lt;annotation&gt;         &lt;documentation&gt;Amplitude GmbH&lt;/documentation&gt;       &lt;/annotation&gt;     &lt;/enumeration&gt;     &lt;enumeration value="0230007"&gt;       &lt;annotation&gt;         &lt;documentation&gt;Exactech Deutschland&lt;/documentation&gt;       &lt;/annotation&gt;     &lt;/enumeration&gt;     &lt;enumeration value="0230008"&gt;       &lt;annotation&gt;         &lt;documentation&gt;Globus Medical&lt;/documentation&gt;       &lt;/annotation&gt;     &lt;/enumeration&gt;   &lt;/restriction&gt; &lt;/simpleType&gt; </pre>

```
</enumeration>
<enumeration value="0230009">
  <annotation>
    <documentation>Implantcast GmbH</documentation>
  </annotation>
</enumeration>
<enumeration value="0230010">
  <annotation>
    <documentation>DePuy Orthopädie GmbH (J&J)</documentation>
  </annotation>
</enumeration>
<enumeration value="0230011">
  <annotation>
    <documentation>IO-International Orthopaedics</documentation>
  </annotation>
</enumeration>
<enumeration value="0230012">
  <annotation>
    <documentation>Joint Replacement Ltd. Instrumentation</documentation>
  </annotation>
</enumeration>
<enumeration value="0230013">
  <annotation>
    <documentation>Merete</documentation>
  </annotation>
</enumeration>
<enumeration value="0230014">
  <annotation>
    <documentation>S&G Implants GmbH</documentation>
  </annotation>
</enumeration>
<enumeration value="0230015">
  <annotation>
    <documentation>Speetec Implantate GmbH</documentation>
  </annotation>
</enumeration>
<enumeration value="0230016">
  <annotation>
    <documentation>Stemcup Medical Products GmbH</documentation>
  </annotation>
</enumeration>
<enumeration value="0230017">
  <annotation>
    <documentation>Symbios Deutschland GmbH</documentation>
  </annotation>
</enumeration>
<enumeration value="0230018">
  <annotation>
    <documentation>Tantum AG</documentation>
  </annotation>
</enumeration>
<enumeration value="0230019">
  <annotation>
    <documentation>Tornier GmbH</documentation>
  </annotation>
</enumeration>
<enumeration value="0230020">
  <annotation>
    <documentation>MicroPort Orthopedics GmbH</documentation>
  </annotation>
</enumeration>
```

```
</annotation>
</enumeration>
<enumeration value="0230021">
  <annotation>
    <documentation>aap Implanate AG</documentation>
  </annotation>
</enumeration>
<enumeration value="0230022">
  <annotation>
    <documentation>AQImplants</documentation>
  </annotation>
</enumeration>
<enumeration value="0230023">
  <annotation>
    <documentation>ESKA Orthodynamics GmbH</documentation>
  </annotation>
</enumeration>
<enumeration value="0230024">
  <annotation>
    <documentation>Atecos medical AG</documentation>
  </annotation>
</enumeration>
<enumeration value="0230025">
  <annotation>
    <documentation>Chiropro GmbH</documentation>
  </annotation>
</enumeration>
<enumeration value="0230026">
  <annotation>
    <documentation>Medacta</documentation>
  </annotation>
</enumeration>
<enumeration value="0230027">
  <annotation>
    <documentation>OHST Medizintechnik AG</documentation>
  </annotation>
</enumeration>
<enumeration value="0230028">
  <annotation>
    <documentation>Lima Deutschland GmbH</documentation>
  </annotation>
</enumeration>
<enumeration value="0230029">
  <annotation>
    <documentation>alloPlus GmbH</documentation>
  </annotation>
</enumeration>
<enumeration value="0230030">
  <annotation>
    <documentation>Heraeus Medical GmbH</documentation>
  </annotation>
</enumeration>
<enumeration value="0230031">
  <annotation>
    <documentation>ImplanTec Deutschland GmbH</documentation>
  </annotation>
</enumeration>
<enumeration value="0230032">
  <annotation>
```

```
<documentation>Falcon Medical GmbH</documentation>
</annotation>
</enumeration>
<enumeration value="0230033">
  <annotation>
    <documentation>Meril GmbH</documentation>
  </annotation>
</enumeration>
<enumeration value="0230034">
  <annotation>
    <documentation>Zimmer Germany GmbH</documentation>
  </annotation>
</enumeration>
<enumeration value="0230035">
  <annotation>
    <documentation>Stryker GmbH & Co. KG</documentation>
  </annotation>
</enumeration>
<enumeration value="0230036">
  <annotation>
    <documentation>Aesculap AG</documentation>
  </annotation>
</enumeration>
<enumeration value="0230037">
  <annotation>
    <documentation>Waldemar Link GmbH & Co. KG</documentation>
  </annotation>
</enumeration>
<enumeration value="0230038">
  <annotation>
    <documentation>Corin Germany GmbH</documentation>
  </annotation>
</enumeration>
<enumeration value="0230039">
  <annotation>
    <documentation>ARTIQO</documentation>
  </annotation>
</enumeration>
<enumeration value="0230040">
  <annotation>
    <documentation>EuromedImplants</documentation>
  </annotation>
</enumeration>
<enumeration value="0230041">
  <annotation>
    <documentation>EvolutisGroup</documentation>
  </annotation>
</enumeration>
<enumeration value="0230042">
  <annotation>
    <documentation>sonstige</documentation>
  </annotation>
</enumeration>
<enumeration value="0230043">
  <annotation>
    <documentation>TEKNIMED SAS</documentation>
  </annotation>
</enumeration>
<enumeration value="0230044">
```

```
<annotation>
  <documentation>HiPer Medical AG</documentation>
</annotation>
</enumeration>
<enumeration value="0230045">
  <annotation>
    <documentation>Link Italia S.p.A.</documentation>
  </annotation>
</enumeration>
<enumeration value="0230046">
  <annotation>
    <documentation>Johnson & Johnson Medical GmbH</documentation>
  </annotation>
</enumeration>
<enumeration value="0230047">
  <annotation>
    <documentation>MatOrtho Limited</documentation>
  </annotation>
</enumeration>
<enumeration value="0230048">
  <annotation>
    <documentation>Adler Ortho S.P.A.</documentation>
  </annotation>
</enumeration>
<enumeration value="0230049">
  <annotation>
    <documentation>Lincotek Bologna SRL</documentation>
  </annotation>
</enumeration>
<enumeration value="0230050">
  <annotation>
    <documentation>Materialise</documentation>
  </annotation>
</enumeration>
<enumeration value="0230051">
  <annotation>
    <documentation>Maxx Orthopedics Inc.</documentation>
  </annotation>
</enumeration>
<enumeration value="0230052">
  <annotation>
    <documentation>JRI Orthopaedics</documentation>
  </annotation>
</enumeration>
<enumeration value="0230053">
  <annotation>
    <documentation>nicht belegter Wert</documentation>
  </annotation>
</enumeration>
<enumeration value="0230054">
  <annotation>
    <documentation>nicht belegter Wert</documentation>
  </annotation>
</enumeration>
<enumeration value="0230055">
  <annotation>
    <documentation>nicht belegter Wert</documentation>
  </annotation>
</enumeration>
```



	<pre> &lt;enumeration value="0230056"&gt;   &lt;annotation&gt;     &lt;documentation&gt;nicht belegter Wert&lt;/documentation&gt;   &lt;/annotation&gt; &lt;/enumeration&gt; &lt;enumeration value="0230057"&gt;   &lt;annotation&gt;     &lt;documentation&gt;nicht belegter Wert&lt;/documentation&gt;   &lt;/annotation&gt; &lt;/enumeration&gt; &lt;enumeration value="0230058"&gt;   &lt;annotation&gt;     &lt;documentation&gt;nicht belegter Wert&lt;/documentation&gt;   &lt;/annotation&gt; &lt;/enumeration&gt; &lt;enumeration value="0230059"&gt;   &lt;annotation&gt;     &lt;documentation&gt;nicht belegter Wert&lt;/documentation&gt;   &lt;/annotation&gt; &lt;/enumeration&gt; &lt;/restriction&gt; &lt;/simpleType&gt; </pre>
--	---

### simpleType enum\_0252

namespace	http://xml.ir-d.de/sak		
type	restriction of <b>string</b>		
properties	base xs:string		
facets	Kind	Value	Annotation
	enumeration	0252001	documentation Pfanne
	enumeration	0252002	documentation Schaft
	enumeration	0252003	documentation beides
annotation	documentation Kat_EP_KomponenteHuefte		
source	<pre> &lt;simpleType name="enum_0252"&gt;   &lt;annotation&gt;     &lt;documentation&gt;Kat_EP_KomponenteHuefte&lt;/documentation&gt;   &lt;/annotation&gt;   &lt;restriction base="xs:string"&gt;     &lt;enumeration value="0252001"&gt;       &lt;annotation&gt;         &lt;documentation&gt;Pfanne&lt;/documentation&gt;       &lt;/annotation&gt;     &lt;/enumeration&gt;     &lt;enumeration value="0252002"&gt;       &lt;annotation&gt;         &lt;documentation&gt;Schaft&lt;/documentation&gt;       &lt;/annotation&gt;     &lt;/enumeration&gt;     &lt;enumeration value="0252003"&gt;       &lt;annotation&gt;         &lt;documentation&gt;beides&lt;/documentation&gt;       &lt;/annotation&gt;     &lt;/enumeration&gt;   &lt;/restriction&gt; &lt;/simpleType&gt; </pre>		

	<pre> &lt;/restriction&gt; &lt;/simpleType&gt; </pre>
--	---

### simpleType enum\_0254

namespace	http://xml.ir-d.de/sak		
type	restriction of <b>string</b>		
properties	base xs:string		
facets	Kind	Value	Annotation
	enumeration	0254001	documentation Femur
	enumeration	0254002	documentation Tibia
	enumeration	0254003	documentation Patella
	enumeration	0254004	documentation mehrere
annotation	documentation Kat_EP_KomponenteKnie		
source	<pre> &lt;simpleType name="enum_0254"&gt;   &lt;annotation&gt;     &lt;documentation&gt;Kat_EP_KomponenteKnie&lt;/documentation&gt;   &lt;/annotation&gt;   &lt;restriction base="xs:string"&gt;     &lt;enumeration value="0254001"&gt;       &lt;annotation&gt;         &lt;documentation&gt;Femur&lt;/documentation&gt;       &lt;/annotation&gt;     &lt;/enumeration&gt;     &lt;enumeration value="0254002"&gt;       &lt;annotation&gt;         &lt;documentation&gt;Tibia&lt;/documentation&gt;       &lt;/annotation&gt;     &lt;/enumeration&gt;     &lt;enumeration value="0254003"&gt;       &lt;annotation&gt;         &lt;documentation&gt;Patella&lt;/documentation&gt;       &lt;/annotation&gt;     &lt;/enumeration&gt;     &lt;enumeration value="0254004"&gt;       &lt;annotation&gt;         &lt;documentation&gt;mehrere&lt;/documentation&gt;       &lt;/annotation&gt;     &lt;/enumeration&gt;   &lt;/restriction&gt; &lt;/simpleType&gt; </pre>		

### simpleType enum\_0256

namespace	http://xml.ir-d.de/sak		
type	restriction of <b>string</b>		
properties	base xs:string		
facets	Kind	Value	Annotation
	enumeration	0256001	documentation

	<p>enumeration 0256002 Pfanne documentation Schaft</p> <p>enumeration 0256003 Pfanne und Schaft documentation</p> <p>enumeration 0256004 Femur documentation</p> <p>enumeration 0256005 Tibia documentation</p> <p>enumeration 0256006 Patella documentation</p> <p>enumeration 0256007 mehrere documentation</p>
annotation	documentation Kat_EP_KomponenteTFE
source	<pre> &lt;simpleType name="enum_0256"&gt;   &lt;annotation&gt;     &lt;documentation&gt;Kat_EP_KomponenteTFE&lt;/documentation&gt;   &lt;/annotation&gt;   &lt;restriction base="xs:string"&gt;     &lt;enumeration value="0256001"&gt;       &lt;annotation&gt;         &lt;documentation&gt;Pfanne&lt;/documentation&gt;       &lt;/annotation&gt;     &lt;/enumeration&gt;     &lt;enumeration value="0256002"&gt;       &lt;annotation&gt;         &lt;documentation&gt;Schaft&lt;/documentation&gt;       &lt;/annotation&gt;     &lt;/enumeration&gt;     &lt;enumeration value="0256003"&gt;       &lt;annotation&gt;         &lt;documentation&gt;Pfanne und Schaft&lt;/documentation&gt;       &lt;/annotation&gt;     &lt;/enumeration&gt;     &lt;enumeration value="0256004"&gt;       &lt;annotation&gt;         &lt;documentation&gt;Femur&lt;/documentation&gt;       &lt;/annotation&gt;     &lt;/enumeration&gt;     &lt;enumeration value="0256005"&gt;       &lt;annotation&gt;         &lt;documentation&gt;Tibia&lt;/documentation&gt;       &lt;/annotation&gt;     &lt;/enumeration&gt;     &lt;enumeration value="0256006"&gt;       &lt;annotation&gt;         &lt;documentation&gt;Patella&lt;/documentation&gt;       &lt;/annotation&gt;     &lt;/enumeration&gt;     &lt;enumeration value="0256007"&gt;       &lt;annotation&gt;         &lt;documentation&gt;mehrere&lt;/documentation&gt;       &lt;/annotation&gt;     &lt;/enumeration&gt;   &lt;/restriction&gt; &lt;/simpleType&gt; </pre>

## simpleType enum\_0262

namespace	http://xml.ir-d.de/sak		
type	restriction of <b>string</b>		
properties	base xs:string		
facets	Kind	Value	Annotation
	enumeration	0262001	documentation Pfanne
	enumeration	0262002	documentation Schaft
	enumeration	0262003	documentation Kopf
	enumeration	0262004	documentation Inlay
	enumeration	0262005	documentation Adapter
	enumeration	0262006	documentation mehrere
annotation	documentation Kat_EP_ImplantatbruchHuefte		
source	<pre> &lt;simpleType name="enum_0262"&gt;   &lt;annotation&gt;     &lt;documentation&gt;Kat_EP_ImplantatbruchHuefte&lt;/documentation&gt;   &lt;/annotation&gt;   &lt;restriction base="xs:string"&gt;     &lt;enumeration value="0262001"&gt;       &lt;annotation&gt;         &lt;documentation&gt;Pfanne&lt;/documentation&gt;       &lt;/annotation&gt;     &lt;/enumeration&gt;     &lt;enumeration value="0262002"&gt;       &lt;annotation&gt;         &lt;documentation&gt;Schaft&lt;/documentation&gt;       &lt;/annotation&gt;     &lt;/enumeration&gt;     &lt;enumeration value="0262003"&gt;       &lt;annotation&gt;         &lt;documentation&gt;Kopf&lt;/documentation&gt;       &lt;/annotation&gt;     &lt;/enumeration&gt;     &lt;enumeration value="0262004"&gt;       &lt;annotation&gt;         &lt;documentation&gt;Inlay&lt;/documentation&gt;       &lt;/annotation&gt;     &lt;/enumeration&gt;     &lt;enumeration value="0262005"&gt;       &lt;annotation&gt;         &lt;documentation&gt;Adapter&lt;/documentation&gt;       &lt;/annotation&gt;     &lt;/enumeration&gt;     &lt;enumeration value="0262006"&gt;       &lt;annotation&gt;         &lt;documentation&gt;mehrere&lt;/documentation&gt;       &lt;/annotation&gt;     &lt;/enumeration&gt;   &lt;/restriction&gt; &lt;/simpleType&gt; </pre>		

### simpleType enum\_0264

namespace	http://xml.ir-d.de/sak		
type	restriction of <b>string</b>		
properties	base xs:string		
facets	Kind	Value	Annotation
	enumeration	0264001	documentation Femur
	enumeration	0264002	documentation Tibia
	enumeration	0264003	documentation Inlay
	enumeration	0264004	documentation Adapter
	enumeration	0264005	documentation Verlängerung
	enumeration	0264006	documentation Schrauben
	enumeration	0264007	documentation mehrere
	enumeration	0264042	documentation andere
annotation	documentation Kat_EP_ImplantatbruchKnie		
source	<pre> &lt;simpleType name="enum_0264"&gt;   &lt;annotation&gt;     &lt;documentation&gt;Kat_EP_ImplantatbruchKnie&lt;/documentation&gt;   &lt;/annotation&gt;   &lt;restriction base="xs:string"&gt;     &lt;enumeration value="0264001"&gt;       &lt;annotation&gt;         &lt;documentation&gt;Femur&lt;/documentation&gt;       &lt;/annotation&gt;     &lt;/enumeration&gt;     &lt;enumeration value="0264002"&gt;       &lt;annotation&gt;         &lt;documentation&gt;Tibia&lt;/documentation&gt;       &lt;/annotation&gt;     &lt;/enumeration&gt;     &lt;enumeration value="0264003"&gt;       &lt;annotation&gt;         &lt;documentation&gt;Inlay&lt;/documentation&gt;       &lt;/annotation&gt;     &lt;/enumeration&gt;     &lt;enumeration value="0264004"&gt;       &lt;annotation&gt;         &lt;documentation&gt;Adapter&lt;/documentation&gt;       &lt;/annotation&gt;     &lt;/enumeration&gt;     &lt;enumeration value="0264005"&gt;       &lt;annotation&gt;         &lt;documentation&gt;Verlängerung&lt;/documentation&gt;       &lt;/annotation&gt;     &lt;/enumeration&gt;     &lt;enumeration value="0264006"&gt;       &lt;annotation&gt;         &lt;documentation&gt;Schrauben&lt;/documentation&gt;       &lt;/annotation&gt;     &lt;/enumeration&gt;   &lt;/restriction&gt; &lt;/simpleType&gt; </pre>		

	<pre> &lt;/enumeration&gt; &lt;enumeration value="0264007"&gt;   &lt;annotation&gt;     &lt;documentation&gt;mehrere&lt;/documentation&gt;   &lt;/annotation&gt; &lt;/enumeration&gt; &lt;enumeration value="0264042"&gt;   &lt;annotation&gt;     &lt;documentation&gt;andere&lt;/documentation&gt;   &lt;/annotation&gt; &lt;/enumeration&gt; &lt;/restriction&gt; &lt;/simpleType&gt; </pre>
--	---

### simpleType enum\_0266

namespace	http://xml.ir-d.de/sak		
type	restriction of <b>string</b>		
properties	base xs:string		
facets	Kind	Value	Annotation
	enumeration	0266001	documentation Pfanne
	enumeration	0266002	documentation Schaft
	enumeration	0266003	documentation Kopf
	enumeration	0266004	documentation Inlay
	enumeration	0266005	documentation Adapter
	enumeration	0266006	documentation Femur
	enumeration	0266007	documentation Tibia
	enumeration	0266008	documentation Verlängerung
	enumeration	0266009	documentation Schrauben
	enumeration	0266010	documentation mehrere
	enumeration	0266042	documentation andere
annotation	documentation Kat_EP_ImplantatbruchTFE		
source	<pre> &lt;simpleType name="enum_0266"&gt;   &lt;annotation&gt;     &lt;documentation&gt;Kat_EP_ImplantatbruchTFE&lt;/documentation&gt;   &lt;/annotation&gt;   &lt;restriction base="xs:string"&gt;     &lt;enumeration value="0266001"&gt;       &lt;annotation&gt;         &lt;documentation&gt;Pfanne&lt;/documentation&gt;       &lt;/annotation&gt;     &lt;/enumeration&gt;     &lt;enumeration value="0266002"&gt;       &lt;annotation&gt;         &lt;documentation&gt;Schaft&lt;/documentation&gt;       &lt;/annotation&gt;     &lt;/enumeration&gt;   &lt;/restriction&gt; </pre>		

```

</enumeration>
<enumeration value="0266003">
  <annotation>
    <documentation>Kopf</documentation>
  </annotation>
</enumeration>
<enumeration value="0266004">
  <annotation>
    <documentation>Inlay</documentation>
  </annotation>
</enumeration>
<enumeration value="0266005">
  <annotation>
    <documentation>Adapter</documentation>
  </annotation>
</enumeration>
<enumeration value="0266006">
  <annotation>
    <documentation>Femur</documentation>
  </annotation>
</enumeration>
<enumeration value="0266007">
  <annotation>
    <documentation>Tibia</documentation>
  </annotation>
</enumeration>
<enumeration value="0266008">
  <annotation>
    <documentation>Verlängerung</documentation>
  </annotation>
</enumeration>
<enumeration value="0266009">
  <annotation>
    <documentation>Schrauben</documentation>
  </annotation>
</enumeration>
<enumeration value="0266010">
  <annotation>
    <documentation>mehrere</documentation>
  </annotation>
</enumeration>
<enumeration value="0266042">
  <annotation>
    <documentation>andere</documentation>
  </annotation>
</enumeration>
</restriction>
</simpleType>

```

### simpleType enum\_0270

namespace	http://xml.ir-d.de/sak		
type	restriction of <b>string</b>		
properties	base xs:string		
facets	Kind enumeration	Value 0270001	Annotation documentation PE-Inlay

	enumeration 0270002 documentation patellare Komponente enumeration 0270003 documentation beides
annotation	documentation Kat_EP_VerschleissKnie
source	<pre> &lt;simpleType name="enum_0270"&gt;   &lt;annotation&gt;     &lt;documentation&gt;Kat_EP_VerschleissKnie&lt;/documentation&gt;   &lt;/annotation&gt;   &lt;restriction base="xs:string"&gt;     &lt;enumeration value="0270001"&gt;       &lt;annotation&gt;         &lt;documentation&gt;PE-Inlay&lt;/documentation&gt;       &lt;/annotation&gt;     &lt;/enumeration&gt;     &lt;enumeration value="0270002"&gt;       &lt;annotation&gt;         &lt;documentation&gt;patellare Komponente&lt;/documentation&gt;       &lt;/annotation&gt;     &lt;/enumeration&gt;     &lt;enumeration value="0270003"&gt;       &lt;annotation&gt;         &lt;documentation&gt;beides&lt;/documentation&gt;       &lt;/annotation&gt;     &lt;/enumeration&gt;   &lt;/restriction&gt; &lt;/simpleType&gt; </pre>

### simpleType enum 0271

namespace	http://xml.ir-d.de/sak		
type	restriction of <b>string</b>		
properties	base xs:string		
facets	Kind	Value	Annotation
	enumeration	0271001	documentation Schraube
	enumeration	0271002	documentation Inlay
	enumeration	0271003	documentation patellare Komponente
	enumeration	0271004	documentation Kopplung
	enumeration	0271005	documentation mehrere
	enumeration	0271042	documentation andere
annotation	documentation Kat_EP_MigrationKnie		
source	<pre> &lt;simpleType name="enum_0271"&gt;   &lt;annotation&gt;     &lt;documentation&gt;Kat_EP_MigrationKnie&lt;/documentation&gt;   &lt;/annotation&gt;   &lt;restriction base="xs:string"&gt;     &lt;enumeration value="0271001"&gt;       &lt;annotation&gt;         &lt;documentation&gt;Schraube&lt;/documentation&gt;       &lt;/annotation&gt;     &lt;/enumeration&gt;   &lt;/restriction&gt; &lt;/simpleType&gt; </pre>		



	<pre> &lt;/annotation&gt; &lt;/enumeration&gt; &lt;enumeration value="0271002"&gt;   &lt;annotation&gt;     &lt;documentation&gt;Inlay&lt;/documentation&gt;   &lt;/annotation&gt; &lt;/enumeration&gt; &lt;enumeration value="0271003"&gt;   &lt;annotation&gt;     &lt;documentation&gt;patellare Komponente&lt;/documentation&gt;   &lt;/annotation&gt; &lt;/enumeration&gt; &lt;enumeration value="0271004"&gt;   &lt;annotation&gt;     &lt;documentation&gt;Kopplung&lt;/documentation&gt;   &lt;/annotation&gt; &lt;/enumeration&gt; &lt;enumeration value="0271005"&gt;   &lt;annotation&gt;     &lt;documentation&gt;mehrere&lt;/documentation&gt;   &lt;/annotation&gt; &lt;/enumeration&gt; &lt;enumeration value="0271042"&gt;   &lt;annotation&gt;     &lt;documentation&gt;andere&lt;/documentation&gt;   &lt;/annotation&gt; &lt;/enumeration&gt; &lt;/restriction&gt; &lt;/simpleType&gt; </pre>
--	--

### simpleType enum\_0290

namespace	http://xml.ir-d.de/sak		
type	restriction of <b>string</b>		
properties	base xs:string		
facets	Kind	Value	Annotation
	enumeration	0290001	documentation Hüft-Komponente
	enumeration	0290002	documentation Knie-Komponente
	enumeration	0290003	documentation Modulare Komponente (Hüfte/Knie)
annotation	documentation Kat_EP_Artikeltyp		
source	<pre> &lt;simpleType name="enum_0290"&gt;   &lt;annotation&gt;     &lt;documentation&gt;Kat_EP_Artikeltyp&lt;/documentation&gt;   &lt;/annotation&gt;   &lt;restriction base="xs:string"&gt;     &lt;enumeration value="0290001"&gt;       &lt;annotation&gt;         &lt;documentation&gt;Hüft-Komponente&lt;/documentation&gt;       &lt;/annotation&gt;     &lt;/enumeration&gt;     &lt;enumeration value="0290002"&gt;       &lt;annotation&gt;         &lt;documentation&gt;Knie-Komponente&lt;/documentation&gt;       &lt;/annotation&gt;     &lt;/enumeration&gt;   &lt;/restriction&gt; &lt;/simpleType&gt; </pre>		

	<pre> &lt;/annotation&gt; &lt;/enumeration&gt; &lt;enumeration value="0290003"&gt;   &lt;annotation&gt;     &lt;documentation&gt;Modulare Komponente (Hüfte/Knie)&lt;/documentation&gt;   &lt;/annotation&gt; &lt;/enumeration&gt; &lt;/restriction&gt; &lt;/simpleType&gt; </pre>
--	--

### simpleType enum\_0291

namespace	http://xml.ir-d.de/sak		
type	restriction of <b>string</b>		
properties	base xs:string		
facets	Kind	Value	Annotation
	enumeration	0291001	documentation Knochen-Zement
	enumeration	0291002	documentation sonstiges Zubehör
annotation	documentation Kat_EP_ZubehoerTyp		
source	<pre> &lt;simpleType name="enum_0291"&gt;   &lt;annotation&gt;     &lt;documentation&gt;Kat_EP_ZubehoerTyp&lt;/documentation&gt;   &lt;/annotation&gt;   &lt;restriction base="xs:string"&gt;     &lt;enumeration value="0291001"&gt;       &lt;annotation&gt;         &lt;documentation&gt;Knochen-Zement&lt;/documentation&gt;       &lt;/annotation&gt;     &lt;/enumeration&gt;     &lt;enumeration value="0291002"&gt;       &lt;annotation&gt;         &lt;documentation&gt;sonstiges Zubehör&lt;/documentation&gt;       &lt;/annotation&gt;     &lt;/enumeration&gt;   &lt;/restriction&gt; &lt;/simpleType&gt; </pre>		

### simpleType enum\_0300

namespace	http://xml.ir-d.de/sak		
type	restriction of <b>string</b>		
properties	base xs:string		
facets	Kind	Value	Annotation
	enumeration	0300001	documentation konventioneller Aortenklappenersatz
	enumeration	0300002	documentation kathetergestützte Aortenklappenimplantation (TAVI)
annotation	documentation Kat_AK_ArtEingriff		
source	<pre> &lt;simpleType name="enum_0300"&gt;   &lt;annotation&gt; </pre>		

	<pre> &lt;documentation&gt;Kat_AK_ArtEingriff&lt;/documentation&gt; &lt;/annotation&gt; &lt;restriction base="xs:string"&gt;   &lt;enumeration value="0300001"&gt;     &lt;annotation&gt;       &lt;documentation&gt;konventioneller Aortenklappenersatz&lt;/documentation&gt;     &lt;/annotation&gt;   &lt;/enumeration&gt;   &lt;enumeration value="0300002"&gt;     &lt;annotation&gt;       &lt;documentation&gt;kathetergestützte Aortenklappenimplantation (TAVI)&lt;/documentation&gt;     &lt;/annotation&gt;   &lt;/enumeration&gt; &lt;/restriction&gt; &lt;/simpleType&gt; </pre>
--	---

### simpleType enum 0302

namespace	http://xml.ir-d.de/sak		
type	restriction of <b>string</b>		
properties	base xs:string		
facets	Kind	Value	Annotation
	enumeration	0302001	documentation Stenose
	enumeration	0302002	documentation Insuffizienz
	enumeration	0302003	documentation Stenose und Insuffizienz
annotation	documentation Kat_AK_GrundEingriff		
source	<pre> &lt;simpleType name="enum_0302"&gt;   &lt;annotation&gt;     &lt;documentation&gt;Kat_AK_GrundEingriff&lt;/documentation&gt;   &lt;/annotation&gt;   &lt;restriction base="xs:string"&gt;     &lt;enumeration value="0302001"&gt;       &lt;annotation&gt;         &lt;documentation&gt;Stenose&lt;/documentation&gt;       &lt;/annotation&gt;     &lt;/enumeration&gt;     &lt;enumeration value="0302002"&gt;       &lt;annotation&gt;         &lt;documentation&gt;Insuffizienz&lt;/documentation&gt;       &lt;/annotation&gt;     &lt;/enumeration&gt;     &lt;enumeration value="0302003"&gt;       &lt;annotation&gt;         &lt;documentation&gt;Stenose und Insuffizienz&lt;/documentation&gt;       &lt;/annotation&gt;     &lt;/enumeration&gt;   &lt;/restriction&gt; &lt;/simpleType&gt; </pre>		

### simpleType enum\_0318

namespace	http://xml.ir-d.de/sak		
type	restriction of <b>string</b>		
properties	base xs:string		
facets	Kind	Value	Annotation
	enumeration	0318001	documentation transapikal
	enumeration	0318002	documentation transaortal
	enumeration	0318003	documentation transfemoral
	enumeration	0318004	documentation transaxillär
	enumeration	0318042	documentation anderer Zugangsweg
annotation	documentation Kat_AK_ZugangKatheter		
source	<pre> &lt;simpleType name="enum_0318"&gt;   &lt;annotation&gt;     &lt;documentation&gt;Kat_AK_ZugangKatheter&lt;/documentation&gt;   &lt;/annotation&gt;   &lt;restriction base="xs:string"&gt;     &lt;enumeration value="0318001"&gt;       &lt;annotation&gt;         &lt;documentation&gt;transapikal&lt;/documentation&gt;       &lt;/annotation&gt;     &lt;/enumeration&gt;     &lt;enumeration value="0318002"&gt;       &lt;annotation&gt;         &lt;documentation&gt;transaortal&lt;/documentation&gt;       &lt;/annotation&gt;     &lt;/enumeration&gt;     &lt;enumeration value="0318003"&gt;       &lt;annotation&gt;         &lt;documentation&gt;transfemoral&lt;/documentation&gt;       &lt;/annotation&gt;     &lt;/enumeration&gt;     &lt;enumeration value="0318004"&gt;       &lt;annotation&gt;         &lt;documentation&gt;transaxillär&lt;/documentation&gt;       &lt;/annotation&gt;     &lt;/enumeration&gt;     &lt;enumeration value="0318042"&gt;       &lt;annotation&gt;         &lt;documentation&gt;anderer Zugangsweg&lt;/documentation&gt;       &lt;/annotation&gt;     &lt;/enumeration&gt;   &lt;/restriction&gt; &lt;/simpleType&gt; </pre>		

### simpleType enum\_0320

namespace	http://xml.ir-d.de/sak		
type	restriction of <b>string</b>		
properties	base xs:string		

facets	<table border="1"> <thead> <tr> <th>Kind</th> <th>Value</th> <th>Annotation</th> </tr> </thead> <tbody> <tr> <td>enumeration</td> <td>0320001</td> <td>documentation konventionelle Sternotomie</td> </tr> <tr> <td>enumeration</td> <td>0320002</td> <td>documentation partielle Sternotomie</td> </tr> <tr> <td>enumeration</td> <td>0320003</td> <td>documentation parasternaler Zugang</td> </tr> <tr> <td>enumeration</td> <td>0320042</td> <td>documentation anderer Zugangsweg</td> </tr> </tbody> </table>	Kind	Value	Annotation	enumeration	0320001	documentation konventionelle Sternotomie	enumeration	0320002	documentation partielle Sternotomie	enumeration	0320003	documentation parasternaler Zugang	enumeration	0320042	documentation anderer Zugangsweg
Kind	Value	Annotation														
enumeration	0320001	documentation konventionelle Sternotomie														
enumeration	0320002	documentation partielle Sternotomie														
enumeration	0320003	documentation parasternaler Zugang														
enumeration	0320042	documentation anderer Zugangsweg														
annotation	documentation Kat_AK_ZugangKonventionell															
source	<pre> &lt;simpleType name="enum_0320"&gt;   &lt;annotation&gt;     &lt;documentation&gt;Kat_AK_ZugangKonventionell&lt;/documentation&gt;   &lt;/annotation&gt;   &lt;restriction base="xs:string"&gt;     &lt;enumeration value="0320001"&gt;       &lt;annotation&gt;         &lt;documentation&gt;konventionelle Sternotomie&lt;/documentation&gt;       &lt;/annotation&gt;     &lt;/enumeration&gt;     &lt;enumeration value="0320002"&gt;       &lt;annotation&gt;         &lt;documentation&gt;partielle Sternotomie&lt;/documentation&gt;       &lt;/annotation&gt;     &lt;/enumeration&gt;     &lt;enumeration value="0320003"&gt;       &lt;annotation&gt;         &lt;documentation&gt;parasternaler Zugang&lt;/documentation&gt;       &lt;/annotation&gt;     &lt;/enumeration&gt;     &lt;enumeration value="0320042"&gt;       &lt;annotation&gt;         &lt;documentation&gt;anderer Zugangsweg&lt;/documentation&gt;       &lt;/annotation&gt;     &lt;/enumeration&gt;   &lt;/restriction&gt; &lt;/simpleType&gt; </pre>															

### simpleType enum\_0322

namespace	http://xml.ir-d.de/sak																					
type	restriction of <b>string</b>																					
properties	base xs:string																					
facets	<table border="1"> <thead> <tr> <th>Kind</th> <th>Value</th> <th>Annotation</th> </tr> </thead> <tbody> <tr> <td>enumeration</td> <td>0322001</td> <td>documentation nein</td> </tr> <tr> <td>enumeration</td> <td>0322002</td> <td>documentation ja, diätetisch behandelt</td> </tr> <tr> <td>enumeration</td> <td>0322003</td> <td>documentation ja, orale Medikation</td> </tr> <tr> <td>enumeration</td> <td>0322004</td> <td>documentation ja, mit Insulin behandelt</td> </tr> <tr> <td>enumeration</td> <td>0322005</td> <td>documentation ja, unbehandelt</td> </tr> <tr> <td>enumeration</td> <td>0322099</td> <td>documentation unbekannt</td> </tr> </tbody> </table>	Kind	Value	Annotation	enumeration	0322001	documentation nein	enumeration	0322002	documentation ja, diätetisch behandelt	enumeration	0322003	documentation ja, orale Medikation	enumeration	0322004	documentation ja, mit Insulin behandelt	enumeration	0322005	documentation ja, unbehandelt	enumeration	0322099	documentation unbekannt
Kind	Value	Annotation																				
enumeration	0322001	documentation nein																				
enumeration	0322002	documentation ja, diätetisch behandelt																				
enumeration	0322003	documentation ja, orale Medikation																				
enumeration	0322004	documentation ja, mit Insulin behandelt																				
enumeration	0322005	documentation ja, unbehandelt																				
enumeration	0322099	documentation unbekannt																				

annotation	documentation Kat_AK_Diabetes
source	<pre> &lt;simpleType name="enum_0322"&gt;   &lt;annotation&gt;     &lt;documentation&gt;Kat_AK_Diabetes&lt;/documentation&gt;   &lt;/annotation&gt;   &lt;restriction base="xs:string"&gt;     &lt;enumeration value="0322001"&gt;       &lt;annotation&gt;         &lt;documentation&gt;nein&lt;/documentation&gt;       &lt;/annotation&gt;     &lt;/enumeration&gt;     &lt;enumeration value="0322002"&gt;       &lt;annotation&gt;         &lt;documentation&gt;ja, diätetisch behandelt&lt;/documentation&gt;       &lt;/annotation&gt;     &lt;/enumeration&gt;     &lt;enumeration value="0322003"&gt;       &lt;annotation&gt;         &lt;documentation&gt;ja, orale Medikation&lt;/documentation&gt;       &lt;/annotation&gt;     &lt;/enumeration&gt;     &lt;enumeration value="0322004"&gt;       &lt;annotation&gt;         &lt;documentation&gt;ja, mit Insulin behandelt&lt;/documentation&gt;       &lt;/annotation&gt;     &lt;/enumeration&gt;     &lt;enumeration value="0322005"&gt;       &lt;annotation&gt;         &lt;documentation&gt;ja, unbehandelt&lt;/documentation&gt;       &lt;/annotation&gt;     &lt;/enumeration&gt;     &lt;enumeration value="0322099"&gt;       &lt;annotation&gt;         &lt;documentation&gt;unbekannt&lt;/documentation&gt;       &lt;/annotation&gt;     &lt;/enumeration&gt;   &lt;/restriction&gt; &lt;/simpleType&gt; </pre>

### simpleType enum\_0324

namespace	http://xml.ir-d.de/sak		
type	restriction of <b>string</b>		
properties	base xs:string		
facets	Kind	Value	Annotation
	enumeration	0324001	documentation (I): Beschwerdefreiheit, normale körperliche Belastbarkeit
	enumeration	0324002	documentation (II): Beschwerden bei stärkerer körperlicher Belastung
	enumeration	0324003	documentation (III): Beschwerden bei leichter körperlicher Belastung
	enumeration	0324004	documentation (IV): Beschwerden in Ruhe
annotation	documentation Kat_AK_NYHA		

source	<pre> &lt;simpleType name="enum_0324"&gt;   &lt;annotation&gt;     &lt;documentation&gt;Kat_AK_NYHA&lt;/documentation&gt;   &lt;/annotation&gt;   &lt;restriction base="xs:string"&gt;     &lt;enumeration value="0324001"&gt;       &lt;annotation&gt;         &lt;documentation&gt;(I): Beschwerdefreiheit, normale körperliche Belastbarkeit&lt;/documentation&gt;       &lt;/annotation&gt;     &lt;/enumeration&gt;     &lt;enumeration value="0324002"&gt;       &lt;annotation&gt;         &lt;documentation&gt;(II): Beschwerden bei stärkerer körperlicher Belastung&lt;/documentation&gt;       &lt;/annotation&gt;     &lt;/enumeration&gt;     &lt;enumeration value="0324003"&gt;       &lt;annotation&gt;         &lt;documentation&gt;(III): Beschwerden bei leichter körperlicher Belastung&lt;/documentation&gt;       &lt;/annotation&gt;     &lt;/enumeration&gt;     &lt;enumeration value="0324004"&gt;       &lt;annotation&gt;         &lt;documentation&gt;(IV): Beschwerden in Ruhe&lt;/documentation&gt;       &lt;/annotation&gt;     &lt;/enumeration&gt;   &lt;/restriction&gt; &lt;/simpleType&gt; </pre>
--------	---

### simpleType **enum\_0330**

namespace	http://xml.ir-d.de/sak		
type	restriction of <b>string</b>		
properties	base xs:string		
facets	Kind	Value	Annotation
	enumeration	0330001	documentation ATS Medical
	enumeration	0330002	documentation Edwards Lifesciences
	enumeration	0330003	documentation Medtronic
	enumeration	0330004	documentation JenaValve
	enumeration	0330005	documentation Corcym
	enumeration	0330006	documentation Abbott Medical / St. Jude
	enumeration	0330007	documentation Symetis
	enumeration	0330008	documentation Direct Flow Medical
	enumeration	0330009	documentation Boston Scientific
	enumeration	0330010	documentation Artivion
	enumeration	0330011	documentation

	<p>enumeration 0330012 Biosensors documentation LivaNova</p> <p>enumeration 0330013 documentation Meril</p> <p>enumeration 0330014 documentation Sahajanand Medical Technologies</p> <p>enumeration 0330015 documentation nicht belegter Wert</p> <p>enumeration 0330016 documentation nicht belegter Wert</p> <p>enumeration 0330017 documentation nicht belegter Wert</p> <p>enumeration 0330018 documentation nicht belegter Wert</p> <p>enumeration 0330042 documentation sonstiger Hersteller</p>
annotation	documentation Kat AK Hersteller
source	<pre> &lt;simpleType name="enum_0330"&gt;   &lt;annotation&gt;     &lt;documentation&gt;Kat_AK_Hersteller&lt;/documentation&gt;   &lt;/annotation&gt;   &lt;restriction base="xs:string"&gt;     &lt;enumeration value="0330001"&gt;       &lt;annotation&gt;         &lt;documentation&gt;ATS Medical&lt;/documentation&gt;       &lt;/annotation&gt;     &lt;/enumeration&gt;     &lt;enumeration value="0330002"&gt;       &lt;annotation&gt;         &lt;documentation&gt;Edwards Lifesciences&lt;/documentation&gt;       &lt;/annotation&gt;     &lt;/enumeration&gt;     &lt;enumeration value="0330003"&gt;       &lt;annotation&gt;         &lt;documentation&gt;Medtronic&lt;/documentation&gt;       &lt;/annotation&gt;     &lt;/enumeration&gt;     &lt;enumeration value="0330004"&gt;       &lt;annotation&gt;         &lt;documentation&gt;JenaValve&lt;/documentation&gt;       &lt;/annotation&gt;     &lt;/enumeration&gt;     &lt;enumeration value="0330005"&gt;       &lt;annotation&gt;         &lt;documentation&gt;Corcym&lt;/documentation&gt;       &lt;/annotation&gt;     &lt;/enumeration&gt;     &lt;enumeration value="0330006"&gt;       &lt;annotation&gt;         &lt;documentation&gt;Abbott Medical / St. Jude&lt;/documentation&gt;       &lt;/annotation&gt;     &lt;/enumeration&gt;     &lt;enumeration value="0330007"&gt;       &lt;annotation&gt;         &lt;documentation&gt;Symetis&lt;/documentation&gt;       &lt;/annotation&gt;     &lt;/enumeration&gt;     &lt;enumeration value="0330008"&gt; </pre>



```
<annotation>
  <documentation>Direct Flow Medical</documentation>
</annotation>
</enumeration>
<enumeration value="0330009">
  <annotation>
    <documentation>Boston Scientific</documentation>
  </annotation>
</enumeration>
<enumeration value="0330010">
  <annotation>
    <documentation>Artivion</documentation>
  </annotation>
</enumeration>
<enumeration value="0330011">
  <annotation>
    <documentation>Biosensors</documentation>
  </annotation>
</enumeration>
<enumeration value="0330012">
  <annotation>
    <documentation>LivaNova</documentation>
  </annotation>
</enumeration>
<enumeration value="0330013">
  <annotation>
    <documentation>Meril</documentation>
  </annotation>
</enumeration>
<enumeration value="0330014">
  <annotation>
    <documentation>Sahajanand Medical Technologies</documentation>
  </annotation>
</enumeration>
<enumeration value="0330015">
  <annotation>
    <documentation>nicht belegter Wert</documentation>
  </annotation>
</enumeration>
<enumeration value="0330016">
  <annotation>
    <documentation>nicht belegter Wert</documentation>
  </annotation>
</enumeration>
<enumeration value="0330017">
  <annotation>
    <documentation>nicht belegter Wert</documentation>
  </annotation>
</enumeration>
<enumeration value="0330018">
  <annotation>
    <documentation>nicht belegter Wert</documentation>
  </annotation>
</enumeration>
<enumeration value="0330042">
  <annotation>
    <documentation>sonstiger Hersteller</documentation>
  </annotation>
</enumeration>
```

	<pre> &lt;/restriction&gt; &lt;/simpleType&gt; </pre>
--	---

### simpleType enum\_0338

namespace	http://xml.ir-d.de/sak		
type	restriction of <b>string</b>		
properties	base xs:string		
facets	Kind	Value	Annotation
	enumeration	0338001	documentation LAD
	enumeration	0338002	documentation RCA
	enumeration	0338003	documentation RCX
	enumeration	0338004	documentation Hauptstamm
annotation	documentation Kat_AK_PCIArterien		
source	<pre> &lt;simpleType name="enum_0338"&gt;   &lt;annotation&gt;     &lt;documentation&gt;Kat_AK_PCIArterien&lt;/documentation&gt;   &lt;/annotation&gt;   &lt;restriction base="xs:string"&gt;     &lt;enumeration value="0338001"&gt;       &lt;annotation&gt;         &lt;documentation&gt;LAD&lt;/documentation&gt;       &lt;/annotation&gt;     &lt;/enumeration&gt;     &lt;enumeration value="0338002"&gt;       &lt;annotation&gt;         &lt;documentation&gt;RCA&lt;/documentation&gt;       &lt;/annotation&gt;     &lt;/enumeration&gt;     &lt;enumeration value="0338003"&gt;       &lt;annotation&gt;         &lt;documentation&gt;RCX&lt;/documentation&gt;       &lt;/annotation&gt;     &lt;/enumeration&gt;     &lt;enumeration value="0338004"&gt;       &lt;annotation&gt;         &lt;documentation&gt;Hauptstamm&lt;/documentation&gt;       &lt;/annotation&gt;     &lt;/enumeration&gt;   &lt;/restriction&gt; &lt;/simpleType&gt; </pre>		

### simpleType enum\_0339

namespace	http://xml.ir-d.de/sak		
type	restriction of <b>string</b>		
properties	base xs:string		
facets	Kind	Value	Annotation
	enumeration	0339001	documentation

	enumeration 0339002 TEE documentation CT enumeration 0339042 documentation andere
annotation	documentation Kat_AK_AnnulusMessmethode
source	<pre> &lt;simpleType name="enum_0339"&gt;   &lt;annotation&gt;     &lt;documentation&gt;Kat_AK_AnnulusMessmethode&lt;/documentation&gt;   &lt;/annotation&gt;   &lt;restriction base="xs:string"&gt;     &lt;enumeration value="0339001"&gt;       &lt;annotation&gt;         &lt;documentation&gt;TEE&lt;/documentation&gt;       &lt;/annotation&gt;     &lt;/enumeration&gt;     &lt;enumeration value="0339002"&gt;       &lt;annotation&gt;         &lt;documentation&gt;CT&lt;/documentation&gt;       &lt;/annotation&gt;     &lt;/enumeration&gt;     &lt;enumeration value="0339042"&gt;       &lt;annotation&gt;         &lt;documentation&gt;andere&lt;/documentation&gt;       &lt;/annotation&gt;     &lt;/enumeration&gt;   &lt;/restriction&gt; &lt;/simpleType&gt; </pre>

### simpleType enum 0341

namespace	http://xml.ir-d.de/sak		
type	restriction of <b>string</b>		
properties	base xs:string		
facets	Kind	Value	Annotation
	enumeration	0341001	documentation intraprozedural verstorben
	enumeration	0341002	documentation Implantation von mehr als einer Prothese
	enumeration	0341003	documentation gravierende Gefäß- oder Zugangskomplikation (gemäß VARC-3)
	enumeration	0341004	documentation erforderlicher chirurgischer oder interventioneller Eingriff wegen einer Klappenfehlfunktion (gemäß VARC-3)
	enumeration	0341005	documentation &gt;= große strukturelle kardiale Komplikation (gemäß VARC-3)
annotation	documentation Kat_AK_FailureGrund		
source	<pre> &lt;simpleType name="enum_0341"&gt;   &lt;annotation&gt;     &lt;documentation&gt;Kat_AK_FailureGrund&lt;/documentation&gt;   &lt;/annotation&gt;   &lt;restriction base="xs:string"&gt;     &lt;enumeration value="0341001"&gt;       &lt;annotation&gt;         &lt;documentation&gt;intraprozedural verstorben&lt;/documentation&gt;       &lt;/annotation&gt;     &lt;/enumeration&gt; </pre>		

	<pre> &lt;/annotation&gt; &lt;/enumeration&gt; &lt;enumeration value="0341002"&gt;   &lt;annotation&gt;     &lt;documentation&gt;Implantation von mehr als einer Prothese&lt;/documentation&gt;   &lt;/annotation&gt; &lt;/enumeration&gt; &lt;enumeration value="0341003"&gt;   &lt;annotation&gt;     &lt;documentation&gt;gravierende Gefäß- oder Zugangskomplikation (gemäß VARC-3)&lt;/documentation&gt;   &lt;/annotation&gt; &lt;/enumeration&gt; &lt;enumeration value="0341004"&gt;   &lt;annotation&gt;     &lt;documentation&gt;erforderlicher chirurgischer oder interventioneller Eingriff wegen einer Klappenfehlfunktion (gemäß VARC-3)&lt;/documentation&gt;   &lt;/annotation&gt; &lt;/enumeration&gt; &lt;enumeration value="0341005"&gt;   &lt;annotation&gt;     &lt;documentation&gt;&amp;gt;= große strukturelle kardiale Komplikation (gemäß VARC-3)&lt;/documentation&gt;   &lt;/annotation&gt; &lt;/enumeration&gt; &lt;/restriction&gt; &lt;/simpleType&gt; </pre>
--	--

simpleType **enum\_0342**

namespace	http://xml.ir-d.de/sak		
type	restriction of <b>string</b>		
properties	base xs:string		
facets	Kind	Value	Annotation
	enumeration	0342001	documentation Alter
	enumeration	0342002	documentation Frailty
	enumeration	0342003	documentation Hochrisiko
	enumeration	0342004	documentation Prognose-limitierende Zweiterkrankung
	enumeration	0342005	documentation Porzellan-Aorta
	enumeration	0342042	documentation Sonstige
annotation	documentation Kat_AK_Tavi		
source	<pre> &lt;simpleType name="enum_0342"&gt;   &lt;annotation&gt;     &lt;documentation&gt;Kat_AK_Tavi&lt;/documentation&gt;   &lt;/annotation&gt;   &lt;restriction base="xs:string"&gt;     &lt;enumeration value="0342001"&gt;       &lt;annotation&gt;         &lt;documentation&gt;Alter&lt;/documentation&gt;       &lt;/annotation&gt; </pre>		

```

</enumeration>
<enumeration value="0342002">
  <annotation>
    <documentation>Frailty</documentation>
  </annotation>
</enumeration>
<enumeration value="0342003">
  <annotation>
    <documentation>Hochrisiko</documentation>
  </annotation>
</enumeration>
<enumeration value="0342004">
  <annotation>
    <documentation>Prognose-limitierende Zweiterkrankung</documentation>
  </annotation>
</enumeration>
<enumeration value="0342005">
  <annotation>
    <documentation>Porzellan-Aorta</documentation>
  </annotation>
</enumeration>
<enumeration value="0342042">
  <annotation>
    <documentation>Sonstige</documentation>
  </annotation>
</enumeration>
</restriction>
</simpleType>

```

### simpleType enum\_0343

namespace	http://xml.ir-d.de/sak		
type	restriction of <b>string</b>		
properties	base xs:string		
facets	Kind	Value	Annotation
	enumeration	0343001	documentation Device-Fehlpositionierung
	enumeration	0343002	documentation Koronarostienverschluss
	enumeration	0343003	documentation Aortendissektion
	enumeration	0343004	documentation Aortenregurgitation &gt; = 2. Grades
	enumeration	0343005	documentation Annulus-Ruptur
	enumeration	0343006	documentation Ruptur-/Perforation einer Herzhöhle ohne Therapiebedarf
	enumeration	0343007	documentation Ruptur-/Perforation einer Herzhöhle mit Therapiebedarf
	enumeration	0343008	documentation Perikardtamponade
	enumeration	0343009	documentation kardiale Dekompensation
	enumeration	0343010	documentation Himembolie
	enumeration	0343011	documentation Rhythmusstörungen
	enumeration	0343012	documentation Device-Embolisation

	<p>enumeration 0343013 documentation vaskuläre Komplikation</p> <p>enumeration 0343014 documentation Low Cardiac Output</p> <p>enumeration 0343015 documentation schwerwiegende Blutungen (intraprozedural)</p> <p>enumeration 0343016 documentation lebensbedrohliche Blutungen (intraprozedural)</p> <p>enumeration 0343017 documentation Patient verstarb im OP/Katheterlabor</p> <p>enumeration 0343042 documentation sonstige intraprozedurale Komplikationen</p>
annotation	documentation Kat_AK_KomplikationTyp
source	<pre> &lt;simpleType name="enum_0343"&gt;   &lt;annotation&gt;     &lt;documentation&gt;Kat_AK_KomplikationTyp&lt;/documentation&gt;   &lt;/annotation&gt;   &lt;restriction base="xs:string"&gt;     &lt;enumeration value="0343001"&gt;       &lt;annotation&gt;         &lt;documentation&gt;Device-Fehlpositionierung&lt;/documentation&gt;       &lt;/annotation&gt;     &lt;/enumeration&gt;     &lt;enumeration value="0343002"&gt;       &lt;annotation&gt;         &lt;documentation&gt;Koronarostienverschluss&lt;/documentation&gt;       &lt;/annotation&gt;     &lt;/enumeration&gt;     &lt;enumeration value="0343003"&gt;       &lt;annotation&gt;         &lt;documentation&gt;Aortendissektion&lt;/documentation&gt;       &lt;/annotation&gt;     &lt;/enumeration&gt;     &lt;enumeration value="0343004"&gt;       &lt;annotation&gt;         &lt;documentation&gt;Aortenregurgitation &amp;gt; = 2. Grades&lt;/documentation&gt;       &lt;/annotation&gt;     &lt;/enumeration&gt;     &lt;enumeration value="0343005"&gt;       &lt;annotation&gt;         &lt;documentation&gt;Annulus-Ruptur&lt;/documentation&gt;       &lt;/annotation&gt;     &lt;/enumeration&gt;     &lt;enumeration value="0343006"&gt;       &lt;annotation&gt;         &lt;documentation&gt;Ruptur-/Perforation einer Herzhöhle ohne Therapiebedarf&lt;/documentation&gt;       &lt;/annotation&gt;     &lt;/enumeration&gt;     &lt;enumeration value="0343007"&gt;       &lt;annotation&gt;         &lt;documentation&gt;Ruptur-/Perforation einer Herzhöhle mit Therapiebedarf&lt;/documentation&gt;       &lt;/annotation&gt;     &lt;/enumeration&gt;     &lt;enumeration value="0343008"&gt;       &lt;annotation&gt;         &lt;documentation&gt;Perikardtamponade&lt;/documentation&gt;       &lt;/annotation&gt;     &lt;/enumeration&gt;   &lt;/restriction&gt; &lt;/simpleType&gt; </pre>

```

</enumeration>
<enumeration value="0343009">
  <annotation>
    <documentation>kardiale Dekompensation</documentation>
  </annotation>
</enumeration>
<enumeration value="0343010">
  <annotation>
    <documentation>Hirnembolie</documentation>
  </annotation>
</enumeration>
<enumeration value="0343011">
  <annotation>
    <documentation>Rhythmusstörungen</documentation>
  </annotation>
</enumeration>
<enumeration value="0343012">
  <annotation>
    <documentation>Device-Embolisation</documentation>
  </annotation>
</enumeration>
<enumeration value="0343013">
  <annotation>
    <documentation>vaskuläre Komplikation</documentation>
  </annotation>
</enumeration>
<enumeration value="0343014">
  <annotation>
    <documentation>Low Cardiac Output</documentation>
  </annotation>
</enumeration>
<enumeration value="0343015">
  <annotation>
    <documentation>schwerwiegende Blutungen
(intraprozedural)</documentation>
  </annotation>
</enumeration>
<enumeration value="0343016">
  <annotation>
    <documentation>lebensbedrohliche Blutungen
(intraprozedural)</documentation>
  </annotation>
</enumeration>
<enumeration value="0343017">
  <annotation>
    <documentation>Patient verstarb im OP/Katheterlabor</documentation>
  </annotation>
</enumeration>
<enumeration value="0343042">
  <annotation>
    <documentation>sonstige intraprozedurale
Komplikationen</documentation>
  </annotation>
</enumeration>
</restriction>
</simpleType>

```

### simpleType enum\_0346

namespace	http://xml.ir-d.de/sak		
type	restriction of <b>string</b>		
properties	base xs:string		
facets	Kind	Value	Annotation
	enumeration	0346001	documentation keine Therapie erforderlich
	enumeration	0346002	documentation medikamentös
	enumeration	0346003	documentation IABP
	enumeration	0346004	documentation VAD
	enumeration	0346005	documentation ECMO
	enumeration	0346042	documentation sonstige
annotation	documentation Kat_AK_TherapieLCO		
source	<pre> &lt;simpleType name="enum_0346"&gt;   &lt;annotation&gt;     &lt;documentation&gt;Kat_AK_TherapieLCO&lt;/documentation&gt;   &lt;/annotation&gt;   &lt;restriction base="xs:string"&gt;     &lt;enumeration value="0346001"&gt;       &lt;annotation&gt;         &lt;documentation&gt;keine Therapie erforderlich&lt;/documentation&gt;       &lt;/annotation&gt;     &lt;/enumeration&gt;     &lt;enumeration value="0346002"&gt;       &lt;annotation&gt;         &lt;documentation&gt;medikamentös&lt;/documentation&gt;       &lt;/annotation&gt;     &lt;/enumeration&gt;     &lt;enumeration value="0346003"&gt;       &lt;annotation&gt;         &lt;documentation&gt;IABP&lt;/documentation&gt;       &lt;/annotation&gt;     &lt;/enumeration&gt;     &lt;enumeration value="0346004"&gt;       &lt;annotation&gt;         &lt;documentation&gt;VAD&lt;/documentation&gt;       &lt;/annotation&gt;     &lt;/enumeration&gt;     &lt;enumeration value="0346005"&gt;       &lt;annotation&gt;         &lt;documentation&gt;ECMO&lt;/documentation&gt;       &lt;/annotation&gt;     &lt;/enumeration&gt;     &lt;enumeration value="0346042"&gt;       &lt;annotation&gt;         &lt;documentation&gt;sonstige&lt;/documentation&gt;       &lt;/annotation&gt;     &lt;/enumeration&gt;   &lt;/restriction&gt; &lt;/simpleType&gt; </pre>		



### simpleType enum\_0347

namespace	http://xml.ir-d.de/sak		
type	restriction of <b>string</b>		
properties	base xs:string		
facets	Kind	Value	Annotation
	enumeration	0347001	documentation Einzeleingriff
	enumeration	0347002	documentation Kombinationseingriff mit mehreren Prozeduren
annotation	documentation Kat_AK_Eingriffsumfang		
source	<pre> &lt;simpleType name="enum_0347"&gt;   &lt;annotation&gt;     &lt;documentation&gt;Kat_AK_Eingriffsumfang&lt;/documentation&gt;   &lt;/annotation&gt;   &lt;restriction base="xs:string"&gt;     &lt;enumeration value="0347001"&gt;       &lt;annotation&gt;         &lt;documentation&gt;Einzeleingriff&lt;/documentation&gt;       &lt;/annotation&gt;     &lt;/enumeration&gt;     &lt;enumeration value="0347002"&gt;       &lt;annotation&gt;         &lt;documentation&gt;Kombinationseingriff mit mehreren Prozeduren&lt;/documentation&gt;       &lt;/annotation&gt;     &lt;/enumeration&gt;   &lt;/restriction&gt; &lt;/simpleType&gt; </pre>		

### simpleType enum\_0348

namespace	http://xml.ir-d.de/sak		
type	restriction of <b>string</b>		
properties	base xs:string		
facets	Kind	Value	Annotation
	enumeration	0348001	documentation mit HLM
	enumeration	0348002	documentation ohne HLM
	enumeration	0348003	documentation Umstieg von OP ohne HLM auf OP mit HLM
annotation	documentation Kat_AK_OPVorgehen		
source	<pre> &lt;simpleType name="enum_0348"&gt;   &lt;annotation&gt;     &lt;documentation&gt;Kat_AK_OPVorgehen&lt;/documentation&gt;   &lt;/annotation&gt;   &lt;restriction base="xs:string"&gt;     &lt;enumeration value="0348001"&gt;       &lt;annotation&gt;         &lt;documentation&gt;mit HLM&lt;/documentation&gt;       &lt;/annotation&gt;     &lt;/enumeration&gt; </pre>		

	<pre> &lt;enumeration value="0348002"&gt;   &lt;annotation&gt;     &lt;documentation&gt;ohne HLM&lt;/documentation&gt;   &lt;/annotation&gt; &lt;/enumeration&gt; &lt;enumeration value="0348003"&gt;   &lt;annotation&gt;     &lt;documentation&gt;Umstieg von OP ohne HLM auf OP mit HLM&lt;/documentation&gt;   &lt;/annotation&gt; &lt;/enumeration&gt; &lt;/restriction&gt; &lt;/simpleType&gt; </pre>
--	---

### simpleType enum\_0350

namespace	http://xml.ir-d.de/sak		
type	restriction of <b>string</b>		
properties	base xs:string		
facets	Kind	Value	Annotation
	enumeration	0350001	documentation IABP
	enumeration	0350002	documentation Impella
	enumeration	0350003	documentation vv ECMO
	enumeration	0350004	documentation va ECMO
	enumeration	0350042	documentation andere
annotation	documentation Kat_AK_Methode		
source	<pre> &lt;simpleType name="enum_0350"&gt;   &lt;annotation&gt;     &lt;documentation&gt;Kat_AK_Methode&lt;/documentation&gt;   &lt;/annotation&gt;   &lt;restriction base="xs:string"&gt;     &lt;enumeration value="0350001"&gt;       &lt;annotation&gt;         &lt;documentation&gt;IABP&lt;/documentation&gt;       &lt;/annotation&gt;     &lt;/enumeration&gt;     &lt;enumeration value="0350002"&gt;       &lt;annotation&gt;         &lt;documentation&gt;Impella&lt;/documentation&gt;       &lt;/annotation&gt;     &lt;/enumeration&gt;     &lt;enumeration value="0350003"&gt;       &lt;annotation&gt;         &lt;documentation&gt;vv ECMO&lt;/documentation&gt;       &lt;/annotation&gt;     &lt;/enumeration&gt;     &lt;enumeration value="0350004"&gt;       &lt;annotation&gt;         &lt;documentation&gt;va ECMO&lt;/documentation&gt;       &lt;/annotation&gt;     &lt;/enumeration&gt;     &lt;enumeration value="0350042"&gt; </pre>		

	<pre> &lt;annotation&gt;   &lt;documentation&gt;andere&lt;/documentation&gt; &lt;/annotation&gt; &lt;/enumeration&gt; &lt;/restriction&gt; &lt;/simpleType&gt; </pre>
--	---

### simpleType enum\_0351

namespace	http://xml.ir-d.de/sak		
type	restriction of <b>string</b>		
properties	base xs:string		
facets	Kind	Value	Annotation
	enumeration	0351001	documentation nein
	enumeration	0351002	documentation ja, zu Sternotomie
	enumeration	0351003	documentation ja, zu transapikal
	enumeration	0351004	documentation ja, zu transaortal
	enumeration	0351005	documentation ja, zu transfemoral
	enumeration	0351006	documentation ja, zu transaxillär
	enumeration	0351007	documentation ja, zu anderem endovaskulären Zugang
	enumeration	0351042	documentation ja, zu anderem Zugang
annotation	documentation Kat_AK_Konversion		
source	<pre> &lt;simpleType name="enum_0351"&gt;   &lt;annotation&gt;     &lt;documentation&gt;Kat_AK_Konversion&lt;/documentation&gt;   &lt;/annotation&gt;   &lt;restriction base="xs:string"&gt;     &lt;enumeration value="0351001"&gt;       &lt;annotation&gt;         &lt;documentation&gt;nein&lt;/documentation&gt;       &lt;/annotation&gt;     &lt;/enumeration&gt;     &lt;enumeration value="0351002"&gt;       &lt;annotation&gt;         &lt;documentation&gt;ja, zu Sternotomie&lt;/documentation&gt;       &lt;/annotation&gt;     &lt;/enumeration&gt;     &lt;enumeration value="0351003"&gt;       &lt;annotation&gt;         &lt;documentation&gt;ja, zu transapikal&lt;/documentation&gt;       &lt;/annotation&gt;     &lt;/enumeration&gt;     &lt;enumeration value="0351004"&gt;       &lt;annotation&gt;         &lt;documentation&gt;ja, zu transaortal&lt;/documentation&gt;       &lt;/annotation&gt;     &lt;/enumeration&gt;     &lt;enumeration value="0351005"&gt;       &lt;annotation&gt; </pre>		

	<pre> &lt;documentation&gt;ja, zu transfemoral&lt;/documentation&gt; &lt;/annotation&gt; &lt;/enumeration&gt; &lt;enumeration value="0351006"&gt;   &lt;annotation&gt;     &lt;documentation&gt;ja, zu transaxillär&lt;/documentation&gt;   &lt;/annotation&gt; &lt;/enumeration&gt; &lt;enumeration value="0351007"&gt;   &lt;annotation&gt;     &lt;documentation&gt;ja, zu anderem endovaskulären Zugang&lt;/documentation&gt;   &lt;/annotation&gt; &lt;/enumeration&gt; &lt;enumeration value="0351042"&gt;   &lt;annotation&gt;     &lt;documentation&gt;ja, zu anderem Zugang&lt;/documentation&gt;   &lt;/annotation&gt; &lt;/enumeration&gt; &lt;/restriction&gt; &lt;/simpleType&gt; </pre>
--	---

### simpleType enum\_0352

namespace	http://xml.ir-d.de/sak		
type	restriction of <b>string</b>		
properties	base xs:string		
facets	Kind	Value	Annotation
	enumeration	0352001	documentation nein
	enumeration	0352002	documentation ja, Intubationsnarkose
	enumeration	0352003	documentation ja, Maskenbeatmung, incl. LAMA
	enumeration	0352042	documentation ja, unbekannt welche
annotation	documentation Kat_AK_Anaesthesie		
source	<pre> &lt;simpleType name="enum_0352"&gt;   &lt;annotation&gt;     &lt;documentation&gt;Kat_AK_Anaesthesie&lt;/documentation&gt;   &lt;/annotation&gt;   &lt;restriction base="xs:string"&gt;     &lt;enumeration value="0352001"&gt;       &lt;annotation&gt;         &lt;documentation&gt;nein&lt;/documentation&gt;       &lt;/annotation&gt;     &lt;/enumeration&gt;     &lt;enumeration value="0352002"&gt;       &lt;annotation&gt;         &lt;documentation&gt;ja, Intubationsnarkose&lt;/documentation&gt;       &lt;/annotation&gt;     &lt;/enumeration&gt;     &lt;enumeration value="0352003"&gt;       &lt;annotation&gt;         &lt;documentation&gt;ja, Maskenbeatmung, incl. LAMA&lt;/documentation&gt;       &lt;/annotation&gt;     &lt;/enumeration&gt;   &lt;/restriction&gt; &lt;/simpleType&gt; </pre>		

	<pre> &lt;enumeration value="0352042"&gt;   &lt;annotation&gt;     &lt;documentation&gt;ja, unbekannt welche&lt;/documentation&gt;   &lt;/annotation&gt; &lt;/enumeration&gt; &lt;/restriction&gt; &lt;/simpleType&gt; </pre>
--	---

### simpleType enum\_0353

namespace	http://xml.ir-d.de/sak		
type	restriction of <b>string</b>		
properties	base xs:string		
facets	Kind	Value	Annotation
	enumeration	0353001	documentation keine
	enumeration	0353002	documentation leichtgradig
	enumeration	0353003	documentation mittelgradig
	enumeration	0353004	documentation hochgradig
	enumeration	0353099	documentation nicht bestimmbar
annotation	documentation Kat_AK_ResidualeArteninsuffizienz		
source	<pre> &lt;simpleType name="enum_0353"&gt;   &lt;annotation&gt;     &lt;documentation&gt;Kat_AK_ResidualeArteninsuffizienz&lt;/documentation&gt;   &lt;/annotation&gt;   &lt;restriction base="xs:string"&gt;     &lt;enumeration value="0353001"&gt;       &lt;annotation&gt;         &lt;documentation&gt;keine&lt;/documentation&gt;       &lt;/annotation&gt;     &lt;/enumeration&gt;     &lt;enumeration value="0353002"&gt;       &lt;annotation&gt;         &lt;documentation&gt;leichtgradig&lt;/documentation&gt;       &lt;/annotation&gt;     &lt;/enumeration&gt;     &lt;enumeration value="0353003"&gt;       &lt;annotation&gt;         &lt;documentation&gt;mittelgradig&lt;/documentation&gt;       &lt;/annotation&gt;     &lt;/enumeration&gt;     &lt;enumeration value="0353004"&gt;       &lt;annotation&gt;         &lt;documentation&gt;hochgradig&lt;/documentation&gt;       &lt;/annotation&gt;     &lt;/enumeration&gt;     &lt;enumeration value="0353099"&gt;       &lt;annotation&gt;         &lt;documentation&gt;nicht bestimmbar&lt;/documentation&gt;       &lt;/annotation&gt;     &lt;/enumeration&gt;   &lt;/restriction&gt; </pre>		

	<code>&lt;/simpleType&gt;</code>
--	----------------------------------

### simpleType enum\_0354

namespace	http://xml.ir-d.de/sak		
type	restriction of <b>string</b>		
properties	base xs:string		
facets	Kind	Value	Annotation
	enumeration	0354001	documentation chirurgisch-offen
	enumeration	0354002	documentation Verschluss-System
	enumeration	0354042	documentation sonstige
annotation	documentation Kat_AK_Zugangswegverschluss		
source	<pre> &lt;simpleType name="enum_0354"&gt;   &lt;annotation&gt;     &lt;documentation&gt;Kat_AK_Zugangswegverschluss&lt;/documentation&gt;   &lt;/annotation&gt;   &lt;restriction base="xs:string"&gt;     &lt;enumeration value="0354001"&gt;       &lt;annotation&gt;         &lt;documentation&gt;chirurgisch-offen&lt;/documentation&gt;       &lt;/annotation&gt;     &lt;/enumeration&gt;     &lt;enumeration value="0354002"&gt;       &lt;annotation&gt;         &lt;documentation&gt;Verschluss-System&lt;/documentation&gt;       &lt;/annotation&gt;     &lt;/enumeration&gt;     &lt;enumeration value="0354042"&gt;       &lt;annotation&gt;         &lt;documentation&gt;sonstige&lt;/documentation&gt;       &lt;/annotation&gt;     &lt;/enumeration&gt;   &lt;/restriction&gt; &lt;/simpleType&gt; </pre>		

### simpleType enum\_0357

namespace	http://xml.ir-d.de/sak		
type	restriction of <b>string</b>		
properties	base xs:string		
facets	Kind	Value	Annotation
	enumeration	0357001	documentation keine KHK
	enumeration	0357002	documentation 1-Gefäßerkrankung
	enumeration	0357003	documentation 2-Gefäßerkrankung
	enumeration	0357004	documentation 3-Gefäßerkrankung
	enumeration	0357005	documentation keine koronare Bildgebung

annotation	documentation Kat_AK_BefundBildgebung
source	<pre> &lt;simpleType name="enum_0357"&gt;   &lt;annotation&gt;     &lt;documentation&gt;Kat_AK_BefundBildgebung&lt;/documentation&gt;   &lt;/annotation&gt;   &lt;restriction base="xs:string"&gt;     &lt;enumeration value="0357001"&gt;       &lt;annotation&gt;         &lt;documentation&gt;keine KHK&lt;/documentation&gt;       &lt;/annotation&gt;     &lt;/enumeration&gt;     &lt;enumeration value="0357002"&gt;       &lt;annotation&gt;         &lt;documentation&gt;1-Gefäßerkrankung&lt;/documentation&gt;       &lt;/annotation&gt;     &lt;/enumeration&gt;     &lt;enumeration value="0357003"&gt;       &lt;annotation&gt;         &lt;documentation&gt;2-Gefäßerkrankung&lt;/documentation&gt;       &lt;/annotation&gt;     &lt;/enumeration&gt;     &lt;enumeration value="0357004"&gt;       &lt;annotation&gt;         &lt;documentation&gt;3-Gefäßerkrankung&lt;/documentation&gt;       &lt;/annotation&gt;     &lt;/enumeration&gt;     &lt;enumeration value="0357005"&gt;       &lt;annotation&gt;         &lt;documentation&gt;keine koronare Bildgebung&lt;/documentation&gt;       &lt;/annotation&gt;     &lt;/enumeration&gt;   &lt;/restriction&gt; &lt;/simpleType&gt; </pre>

### simpleType enum\_0358

namespace	http://xml.ir-d.de/sak		
type	restriction of <b>string</b>		
properties	base xs:string		
facets	Kind	Value	Annotation
	enumeration	0358001	documentation 0
	enumeration	0358002	documentation 1
	enumeration	0358003	documentation 2
	enumeration	0358004	documentation 3
	enumeration	0358005	documentation 4
	enumeration	0358006	documentation 5 oder mehr
	enumeration	0358098	documentation genaue Anzahl unbekannt (aber mind. 1)
	enumeration	0358099	documentation unbekannt

annotation	documentation Kat_AK_AnzahlVorOP
source	<pre> &lt;simpleType name="enum_0358"&gt;   &lt;annotation&gt;     &lt;documentation&gt;Kat_AK_AnzahlVorOP&lt;/documentation&gt;   &lt;/annotation&gt;   &lt;restriction base="xs:string"&gt;     &lt;enumeration value="0358001"&gt;       &lt;annotation&gt;         &lt;documentation&gt;0&lt;/documentation&gt;       &lt;/annotation&gt;     &lt;/enumeration&gt;     &lt;enumeration value="0358002"&gt;       &lt;annotation&gt;         &lt;documentation&gt;1&lt;/documentation&gt;       &lt;/annotation&gt;     &lt;/enumeration&gt;     &lt;enumeration value="0358003"&gt;       &lt;annotation&gt;         &lt;documentation&gt;2&lt;/documentation&gt;       &lt;/annotation&gt;     &lt;/enumeration&gt;     &lt;enumeration value="0358004"&gt;       &lt;annotation&gt;         &lt;documentation&gt;3&lt;/documentation&gt;       &lt;/annotation&gt;     &lt;/enumeration&gt;     &lt;enumeration value="0358005"&gt;       &lt;annotation&gt;         &lt;documentation&gt;4&lt;/documentation&gt;       &lt;/annotation&gt;     &lt;/enumeration&gt;     &lt;enumeration value="0358006"&gt;       &lt;annotation&gt;         &lt;documentation&gt;5 oder mehr&lt;/documentation&gt;       &lt;/annotation&gt;     &lt;/enumeration&gt;     &lt;enumeration value="0358098"&gt;       &lt;annotation&gt;         &lt;documentation&gt;genaue Anzahl unbekannt (aber mind. 1)&lt;/documentation&gt;       &lt;/annotation&gt;     &lt;/enumeration&gt;     &lt;enumeration value="0358099"&gt;       &lt;annotation&gt;         &lt;documentation&gt;unbekannt&lt;/documentation&gt;       &lt;/annotation&gt;     &lt;/enumeration&gt;   &lt;/restriction&gt; &lt;/simpleType&gt; </pre>

### simpleType enum\_0359

namespace	http://xml.ir-d.de/sak
type	restriction of <b>string</b>
properties	base xs:string
facets	Kind Value Annotation



	enumeration 0359001 documentation nein enumeration 0359002 documentation ja - einseitig enumeration 0359003 documentation ja - beidseitig enumeration 0359042 documentation unbekannt
annotation	documentation Kat_AK_LVOT
source	<pre> &lt;simpleType name="enum_0359"&gt;   &lt;annotation&gt;     &lt;documentation&gt;Kat_AK_LVOT&lt;/documentation&gt;   &lt;/annotation&gt;   &lt;restriction base="xs:string"&gt;     &lt;enumeration value="0359001"&gt;       &lt;annotation&gt;         &lt;documentation&gt;nein&lt;/documentation&gt;       &lt;/annotation&gt;     &lt;/enumeration&gt;     &lt;enumeration value="0359002"&gt;       &lt;annotation&gt;         &lt;documentation&gt;ja - einseitig&lt;/documentation&gt;       &lt;/annotation&gt;     &lt;/enumeration&gt;     &lt;enumeration value="0359003"&gt;       &lt;annotation&gt;         &lt;documentation&gt;ja - beidseitig&lt;/documentation&gt;       &lt;/annotation&gt;     &lt;/enumeration&gt;     &lt;enumeration value="0359042"&gt;       &lt;annotation&gt;         &lt;documentation&gt;unbekannt&lt;/documentation&gt;       &lt;/annotation&gt;     &lt;/enumeration&gt;   &lt;/restriction&gt; &lt;/simpleType&gt; </pre>

### simpleType enum\_0360

namespace	http://xml.ir-d.de/sak		
type	restriction of <b>string</b>		
properties	base xs:string		
facets	Kind	Value	Annotation
	enumeration	0360001	documentation keine
	enumeration	0360002	documentation leichtgradig
	enumeration	0360003	documentation mittelgradig
	enumeration	0360004	documentation hochgradig
	enumeration	0360005	documentation massive
	enumeration	0360006	documentation torrential
	enumeration	0360099	documentation unbekannt

annotation	documentation Kat_AK_TriskupidalInsuffizienz
source	<pre> &lt;simpleType name="enum_0360"&gt;   &lt;annotation&gt;     &lt;documentation&gt;Kat_AK_TriskupidalInsuffizienz&lt;/documentation&gt;   &lt;/annotation&gt;   &lt;restriction base="xs:string"&gt;     &lt;enumeration value="0360001"&gt;       &lt;annotation&gt;         &lt;documentation&gt;keine&lt;/documentation&gt;       &lt;/annotation&gt;     &lt;/enumeration&gt;     &lt;enumeration value="0360002"&gt;       &lt;annotation&gt;         &lt;documentation&gt;leichtgradig&lt;/documentation&gt;       &lt;/annotation&gt;     &lt;/enumeration&gt;     &lt;enumeration value="0360003"&gt;       &lt;annotation&gt;         &lt;documentation&gt;mittelgradig&lt;/documentation&gt;       &lt;/annotation&gt;     &lt;/enumeration&gt;     &lt;enumeration value="0360004"&gt;       &lt;annotation&gt;         &lt;documentation&gt;hochgradig&lt;/documentation&gt;       &lt;/annotation&gt;     &lt;/enumeration&gt;     &lt;enumeration value="0360005"&gt;       &lt;annotation&gt;         &lt;documentation&gt;massive&lt;/documentation&gt;       &lt;/annotation&gt;     &lt;/enumeration&gt;     &lt;enumeration value="0360006"&gt;       &lt;annotation&gt;         &lt;documentation&gt;torrential&lt;/documentation&gt;       &lt;/annotation&gt;     &lt;/enumeration&gt;     &lt;enumeration value="0360099"&gt;       &lt;annotation&gt;         &lt;documentation&gt;unbekannt&lt;/documentation&gt;       &lt;/annotation&gt;     &lt;/enumeration&gt;   &lt;/restriction&gt; &lt;/simpleType&gt; </pre>

### simpleType enum 0361

namespace	http://xml.ir-d.de/sak		
type	restriction of <b>string</b>		
properties	base xs:string		
facets	Kind	Value	Annotation
	enumeration	0361001	documentation nein
	enumeration	0361002	documentation ja, letzte(r) innerhalb der letzten 48 Stunden
	enumeration	0361003	documentation ja, letzte(r) innerhalb der letzten 21 Tage

	enumeration 0361004 documentation ja, letzte(r) länger als 21 Tage enumeration 0361098 documentation ja, letzter Zeitpunkt unbekannt enumeration 0361099 documentation unbekannt
annotation	documentation Kat_AK_SchockReanimation
source	<pre> &lt;simpleType name="enum_0361"&gt;   &lt;annotation&gt;     &lt;documentation&gt;Kat_AK_SchockReanimation&lt;/documentation&gt;   &lt;/annotation&gt;   &lt;restriction base="xs:string"&gt;     &lt;enumeration value="0361001"&gt;       &lt;annotation&gt;         &lt;documentation&gt;nein&lt;/documentation&gt;       &lt;/annotation&gt;     &lt;/enumeration&gt;     &lt;enumeration value="0361002"&gt;       &lt;annotation&gt;         &lt;documentation&gt;ja, letzte(r) innerhalb der letzten 48 Stunden&lt;/documentation&gt;       &lt;/annotation&gt;     &lt;/enumeration&gt;     &lt;enumeration value="0361003"&gt;       &lt;annotation&gt;         &lt;documentation&gt;ja, letzte(r) innerhalb der letzten 21 Tage&lt;/documentation&gt;       &lt;/annotation&gt;     &lt;/enumeration&gt;     &lt;enumeration value="0361004"&gt;       &lt;annotation&gt;         &lt;documentation&gt;ja, letzte(r) länger als 21 Tage&lt;/documentation&gt;       &lt;/annotation&gt;     &lt;/enumeration&gt;     &lt;enumeration value="0361098"&gt;       &lt;annotation&gt;         &lt;documentation&gt;ja, letzter Zeitpunkt unbekannt&lt;/documentation&gt;       &lt;/annotation&gt;     &lt;/enumeration&gt;     &lt;enumeration value="0361099"&gt;       &lt;annotation&gt;         &lt;documentation&gt;unbekannt&lt;/documentation&gt;       &lt;/annotation&gt;     &lt;/enumeration&gt;   &lt;/restriction&gt; &lt;/simpleType&gt; </pre>

### simpleType **enum\_0362**

namespace	http://xml.ir-d.de/sak		
type	restriction of <b>string</b>		
properties	base xs:string		
facets	Kind	Value	Annotation
	enumeration	0362001	documentation Sinusrhythmus
	enumeration	0362002	documentation

	enumeration 0362042 Vorhofflimmern documentation anderer Herzrhythmus
annotation	documentation Kat_AK_Herzrhythmus
source	<pre> &lt;simpleType name="enum_0362"&gt;   &lt;annotation&gt;     &lt;documentation&gt;Kat_AK_Herzrhythmus&lt;/documentation&gt;   &lt;/annotation&gt;   &lt;restriction base="xs:string"&gt;     &lt;enumeration value="0362001"&gt;       &lt;annotation&gt;         &lt;documentation&gt;Sinusrhythmus&lt;/documentation&gt;       &lt;/annotation&gt;     &lt;/enumeration&gt;     &lt;enumeration value="0362002"&gt;       &lt;annotation&gt;         &lt;documentation&gt;Vorhofflimmern&lt;/documentation&gt;       &lt;/annotation&gt;     &lt;/enumeration&gt;     &lt;enumeration value="0362042"&gt;       &lt;annotation&gt;         &lt;documentation&gt;anderer Herzrhythmus&lt;/documentation&gt;       &lt;/annotation&gt;     &lt;/enumeration&gt;   &lt;/restriction&gt; &lt;/simpleType&gt; </pre>

### simpleType enum\_0363

namespace	http://xml.ir-d.de/sak		
type	restriction of <b>string</b>		
properties	base xs:string		
facets	Kind	Value	Annotation
	enumeration	0363001	documentation nein
	enumeration	0363002	documentation paroxysmal
	enumeration	0363003	documentation persistierend
	enumeration	0363004	documentation permanent
annotation	documentation Kat_AK_Vorhofflimmern		
source	<pre> &lt;simpleType name="enum_0363"&gt;   &lt;annotation&gt;     &lt;documentation&gt;Kat_AK_Vorhofflimmern&lt;/documentation&gt;   &lt;/annotation&gt;   &lt;restriction base="xs:string"&gt;     &lt;enumeration value="0363001"&gt;       &lt;annotation&gt;         &lt;documentation&gt;nein&lt;/documentation&gt;       &lt;/annotation&gt;     &lt;/enumeration&gt;     &lt;enumeration value="0363002"&gt;       &lt;annotation&gt;         &lt;documentation&gt;paroxysmal&lt;/documentation&gt; </pre>		

	<pre> &lt;/annotation&gt; &lt;/enumeration&gt; &lt;enumeration value="0363003"&gt;   &lt;annotation&gt;     &lt;documentation&gt;persistierend&lt;/documentation&gt;   &lt;/annotation&gt; &lt;/enumeration&gt; &lt;enumeration value="0363004"&gt;   &lt;annotation&gt;     &lt;documentation&gt;permanent&lt;/documentation&gt;   &lt;/annotation&gt; &lt;/enumeration&gt; &lt;/restriction&gt; &lt;/simpleType&gt; </pre>
--	--

### simpleType enum\_0364

namespace	http://xml.lir-d.de/sak		
type	restriction of <b>string</b>		
properties	base xs:string		
facets	Kind	Value	Annotation
	enumeration	0364001	documentation nein
	enumeration	0364002	documentation Schrittmacher ohne CRT-System
	enumeration	0364003	documentation Schrittmacher mit CRT-System
	enumeration	0364004	documentation Defibrillator ohne CRT-System
	enumeration	0364005	documentation Defibrillator mit CRT-System
annotation	documentation Kat_AK_SchrittmacherDefi		
source	<pre> &lt;simpleType name="enum_0364"&gt;   &lt;annotation&gt;     &lt;documentation&gt;Kat_AK_SchrittmacherDefi&lt;/documentation&gt;   &lt;/annotation&gt;   &lt;restriction base="xs:string"&gt;     &lt;enumeration value="0364001"&gt;       &lt;annotation&gt;         &lt;documentation&gt;nein&lt;/documentation&gt;       &lt;/annotation&gt;     &lt;/enumeration&gt;     &lt;enumeration value="0364002"&gt;       &lt;annotation&gt;         &lt;documentation&gt;Schrittmacher ohne CRT-System&lt;/documentation&gt;       &lt;/annotation&gt;     &lt;/enumeration&gt;     &lt;enumeration value="0364003"&gt;       &lt;annotation&gt;         &lt;documentation&gt;Schrittmacher mit CRT-System&lt;/documentation&gt;       &lt;/annotation&gt;     &lt;/enumeration&gt;     &lt;enumeration value="0364004"&gt;       &lt;annotation&gt;         &lt;documentation&gt;Defibrillator ohne CRT-System&lt;/documentation&gt;       &lt;/annotation&gt;     &lt;/enumeration&gt;   &lt;/restriction&gt; &lt;/simpleType&gt; </pre>		

	<pre> &lt;/enumeration&gt; &lt;enumeration value="0364005"&gt;   &lt;annotation&gt;     &lt;documentation&gt;Defibrillator mit CRT-System&lt;/documentation&gt;   &lt;/annotation&gt; &lt;/enumeration&gt; &lt;/restriction&gt; &lt;/simpleType&gt; </pre>
--	--

### simpleType enum\_0365

namespace	http://xml.ir-d.de/sak		
type	restriction of <b>string</b>		
properties	base xs:string		
facets	Kind	Value	Annotation
	enumeration	0365001	documentation nein
	enumeration	0365002	documentation ja, operativ
	enumeration	0365003	documentation ja, interventionell
annotation	documentation Kat_AK_MyokardRevaskularisation		
source	<pre> &lt;simpleType name="enum_0365"&gt;   &lt;annotation&gt;     &lt;documentation&gt;Kat_AK_MyokardRevaskularisation&lt;/documentation&gt;   &lt;/annotation&gt;   &lt;restriction base="xs:string"&gt;     &lt;enumeration value="0365001"&gt;       &lt;annotation&gt;         &lt;documentation&gt;nein&lt;/documentation&gt;       &lt;/annotation&gt;     &lt;/enumeration&gt;     &lt;enumeration value="0365002"&gt;       &lt;annotation&gt;         &lt;documentation&gt;ja, operativ&lt;/documentation&gt;       &lt;/annotation&gt;     &lt;/enumeration&gt;     &lt;enumeration value="0365003"&gt;       &lt;annotation&gt;         &lt;documentation&gt;ja, interventionell&lt;/documentation&gt;       &lt;/annotation&gt;     &lt;/enumeration&gt;   &lt;/restriction&gt; &lt;/simpleType&gt; </pre>		

### simpleType enum\_0366

namespace	http://xml.ir-d.de/sak		
type	restriction of <b>string</b>		
properties	base xs:string		
facets	Kind	Value	Annotation
	enumeration	0366001	documentation nein

	enumeration 0366002 documentation ja, &lt;= 6 Stunden enumeration 0366003 documentation ja, &gt; 6 Stunden bis &lt;= 3 Monate enumeration 0366004 documentation ja, &gt; 3 Monate enumeration 0366099 documentation unbekannt
annotation	documentation Kat_AK_PCI
source	<pre> &lt;simpleType name="enum_0366"&gt;   &lt;annotation&gt;     &lt;documentation&gt;Kat_AK_PCI&lt;/documentation&gt;   &lt;/annotation&gt;   &lt;restriction base="xs:string"&gt;     &lt;enumeration value="0366001"&gt;       &lt;annotation&gt;         &lt;documentation&gt;nein&lt;/documentation&gt;       &lt;/annotation&gt;     &lt;/enumeration&gt;     &lt;enumeration value="0366002"&gt;       &lt;annotation&gt;         &lt;documentation&gt;ja, &amp;lt;= 6 Stunden&lt;/documentation&gt;       &lt;/annotation&gt;     &lt;/enumeration&gt;     &lt;enumeration value="0366003"&gt;       &lt;annotation&gt;         &lt;documentation&gt;ja, &amp;gt; 6 Stunden bis &amp;lt;= 3 Monate&lt;/documentation&gt;       &lt;/annotation&gt;     &lt;/enumeration&gt;     &lt;enumeration value="0366004"&gt;       &lt;annotation&gt;         &lt;documentation&gt;ja, &amp;gt; 3 Monate&lt;/documentation&gt;       &lt;/annotation&gt;     &lt;/enumeration&gt;     &lt;enumeration value="0366099"&gt;       &lt;annotation&gt;         &lt;documentation&gt;unbekannt&lt;/documentation&gt;       &lt;/annotation&gt;     &lt;/enumeration&gt;   &lt;/restriction&gt; &lt;/simpleType&gt; </pre>

### simpleType enum\_0367

namespace	http://xml.ir-d.de/sak		
type	restriction of <b>string</b>		
properties	base	xs:string	
facets	Kind	Value	Annotation
	enumeration	0367001	documentation keine
	enumeration	0367002	documentation Mediastinitis
	enumeration	0367003	documentation Sepsis
	enumeration	0367004	documentation broncho-pulmonale Infektion
	enumeration	0367005	documentation

	<p>enumeration 0367006 oto-laryngologische Infektion documentation floride Endokarditis</p> <p>enumeration 0367007 documentation Peritonitis</p> <p>enumeration 0367008 documentation Wundinfektion Thorax</p> <p>enumeration 0367009 documentation Pleuraempyem</p> <p>enumeration 0367010 documentation Venenkatheterinfektion</p> <p>enumeration 0367011 documentation Harnwegsinfektion</p> <p>enumeration 0367012 documentation Wundinfektion untere Extremitäten</p> <p>enumeration 0367013 documentation HIV-Infektion</p> <p>enumeration 0367014 documentation Hepatitis B oder C</p> <p>enumeration 0367015 documentation andere Wundinfektion</p> <p>enumeration 0367042 documentation sonstige Infektion</p>
annotation	documentation Kat_AK_Infektion
source	<pre> &lt;simpleType name="enum_0367"&gt;   &lt;annotation&gt;     &lt;documentation&gt;Kat_AK_Infektion&lt;/documentation&gt;   &lt;/annotation&gt;   &lt;restriction base="xs:string"&gt;     &lt;enumeration value="0367001"&gt;       &lt;annotation&gt;         &lt;documentation&gt;keine&lt;/documentation&gt;       &lt;/annotation&gt;     &lt;/enumeration&gt;     &lt;enumeration value="0367002"&gt;       &lt;annotation&gt;         &lt;documentation&gt;Mediastinitis&lt;/documentation&gt;       &lt;/annotation&gt;     &lt;/enumeration&gt;     &lt;enumeration value="0367003"&gt;       &lt;annotation&gt;         &lt;documentation&gt;Sepsis&lt;/documentation&gt;       &lt;/annotation&gt;     &lt;/enumeration&gt;     &lt;enumeration value="0367004"&gt;       &lt;annotation&gt;         &lt;documentation&gt;broncho-pulmonale Infektion&lt;/documentation&gt;       &lt;/annotation&gt;     &lt;/enumeration&gt;     &lt;enumeration value="0367005"&gt;       &lt;annotation&gt;         &lt;documentation&gt;oto-laryngologische Infektion&lt;/documentation&gt;       &lt;/annotation&gt;     &lt;/enumeration&gt;     &lt;enumeration value="0367006"&gt;       &lt;annotation&gt;         &lt;documentation&gt;floride Endokarditis&lt;/documentation&gt;       &lt;/annotation&gt;     &lt;/enumeration&gt;     &lt;enumeration value="0367007"&gt; </pre>



```

    <annotation>
      <documentation>Peritonitis</documentation>
    </annotation>
  </enumeration>
  <enumeration value="0367008">
    <annotation>
      <documentation>Wundinfektion Thorax</documentation>
    </annotation>
  </enumeration>
  <enumeration value="0367009">
    <annotation>
      <documentation>Pleuraempyem</documentation>
    </annotation>
  </enumeration>
  <enumeration value="0367010">
    <annotation>
      <documentation>Venenkatheterinfektion</documentation>
    </annotation>
  </enumeration>
  <enumeration value="0367011">
    <annotation>
      <documentation>Harnwegsinfektion</documentation>
    </annotation>
  </enumeration>
  <enumeration value="0367012">
    <annotation>
      <documentation>Wundinfektion untere Extremitäten</documentation>
    </annotation>
  </enumeration>
  <enumeration value="0367013">
    <annotation>
      <documentation>HIV-Infektion</documentation>
    </annotation>
  </enumeration>
  <enumeration value="0367014">
    <annotation>
      <documentation>Hepatitis B oder C</documentation>
    </annotation>
  </enumeration>
  <enumeration value="0367015">
    <annotation>
      <documentation>andere Wundinfektion</documentation>
    </annotation>
  </enumeration>
  <enumeration value="0367042">
    <annotation>
      <documentation>sonstige Infektion</documentation>
    </annotation>
  </enumeration>
</restriction>
</simpleType>

```

#### simpleType enum\_0368

namespace	http://xml.ir-d.de/sak
type	restriction of <b>string</b>

properties	base xs:string																		
facets	<table border="1"> <thead> <tr> <th>Kind</th> <th>Value</th> <th>Annotation</th> </tr> </thead> <tbody> <tr> <td>enumeration</td> <td>0368001</td> <td>documentation nein</td> </tr> <tr> <td>enumeration</td> <td>0368002</td> <td>documentation ja, COPD mit Dauermedikation</td> </tr> <tr> <td>enumeration</td> <td>0368003</td> <td>documentation ja, COPD ohne Dauermedikation</td> </tr> <tr> <td>enumeration</td> <td>0368004</td> <td>documentation ja, andere Lungenerkrankungen</td> </tr> <tr> <td>enumeration</td> <td>0368099</td> <td>documentation unbekannt</td> </tr> </tbody> </table>	Kind	Value	Annotation	enumeration	0368001	documentation nein	enumeration	0368002	documentation ja, COPD mit Dauermedikation	enumeration	0368003	documentation ja, COPD ohne Dauermedikation	enumeration	0368004	documentation ja, andere Lungenerkrankungen	enumeration	0368099	documentation unbekannt
Kind	Value	Annotation																	
enumeration	0368001	documentation nein																	
enumeration	0368002	documentation ja, COPD mit Dauermedikation																	
enumeration	0368003	documentation ja, COPD ohne Dauermedikation																	
enumeration	0368004	documentation ja, andere Lungenerkrankungen																	
enumeration	0368099	documentation unbekannt																	
annotation	documentation Kat_AK_Lungenerkrankung																		
source	<pre> &lt;simpleType name="enum_0368"&gt;   &lt;annotation&gt;     &lt;documentation&gt;Kat_AK_Lungenerkrankung&lt;/documentation&gt;   &lt;/annotation&gt;   &lt;restriction base="xs:string"&gt;     &lt;enumeration value="0368001"&gt;       &lt;annotation&gt;         &lt;documentation&gt;nein&lt;/documentation&gt;       &lt;/annotation&gt;     &lt;/enumeration&gt;     &lt;enumeration value="0368002"&gt;       &lt;annotation&gt;         &lt;documentation&gt;ja, COPD mit Dauermedikation&lt;/documentation&gt;       &lt;/annotation&gt;     &lt;/enumeration&gt;     &lt;enumeration value="0368003"&gt;       &lt;annotation&gt;         &lt;documentation&gt;ja, COPD ohne Dauermedikation&lt;/documentation&gt;       &lt;/annotation&gt;     &lt;/enumeration&gt;     &lt;enumeration value="0368004"&gt;       &lt;annotation&gt;         &lt;documentation&gt;ja, andere Lungenerkrankungen&lt;/documentation&gt;       &lt;/annotation&gt;     &lt;/enumeration&gt;     &lt;enumeration value="0368099"&gt;       &lt;annotation&gt;         &lt;documentation&gt;unbekannt&lt;/documentation&gt;       &lt;/annotation&gt;     &lt;/enumeration&gt;   &lt;/restriction&gt; &lt;/simpleType&gt; </pre>																		

### simpleType enum\_0369

namespace	http://xml.ir-d.de/sak									
type	restriction of <b>string</b>									
properties	base xs:string									
facets	<table border="1"> <thead> <tr> <th>Kind</th> <th>Value</th> <th>Annotation</th> </tr> </thead> <tbody> <tr> <td>enumeration</td> <td>0369001</td> <td>documentation nein</td> </tr> <tr> <td>enumeration</td> <td>0369002</td> <td>documentation akut</td> </tr> </tbody> </table>	Kind	Value	Annotation	enumeration	0369001	documentation nein	enumeration	0369002	documentation akut
Kind	Value	Annotation								
enumeration	0369001	documentation nein								
enumeration	0369002	documentation akut								

	enumeration 0369003 documentation chronisch
annotation	documentation Kat_AK_Nierenersatztherapie
source	<pre> &lt;simpleType name="enum_0369"&gt;   &lt;annotation&gt;     &lt;documentation&gt;Kat_AK_Nierenersatztherapie&lt;/documentation&gt;   &lt;/annotation&gt;   &lt;restriction base="xs:string"&gt;     &lt;enumeration value="0369001"&gt;       &lt;annotation&gt;         &lt;documentation&gt;nein&lt;/documentation&gt;       &lt;/annotation&gt;     &lt;/enumeration&gt;     &lt;enumeration value="0369002"&gt;       &lt;annotation&gt;         &lt;documentation&gt;akut&lt;/documentation&gt;       &lt;/annotation&gt;     &lt;/enumeration&gt;     &lt;enumeration value="0369003"&gt;       &lt;annotation&gt;         &lt;documentation&gt;chronisch&lt;/documentation&gt;       &lt;/annotation&gt;     &lt;/enumeration&gt;   &lt;/restriction&gt; &lt;/simpleType&gt; </pre>

### simpleType enum\_0370

namespace	http://xml.ir-d.de/sak		
type	restriction of <b>string</b>		
properties	base xs:string		
facets	Kind	Value	Annotation
	enumeration	0370001	documentation Echokardiographie
	enumeration	0370002	documentation Herzkatheter
	enumeration	0370042	documentation andere
annotation	documentation Kat_AK_AKOEFMessmethode		
source	<pre> &lt;simpleType name="enum_0370"&gt;   &lt;annotation&gt;     &lt;documentation&gt;Kat_AK_AKOEFMessmethode&lt;/documentation&gt;   &lt;/annotation&gt;   &lt;restriction base="xs:string"&gt;     &lt;enumeration value="0370001"&gt;       &lt;annotation&gt;         &lt;documentation&gt;Echokardiographie&lt;/documentation&gt;       &lt;/annotation&gt;     &lt;/enumeration&gt;     &lt;enumeration value="0370002"&gt;       &lt;annotation&gt;         &lt;documentation&gt;Herzkatheter&lt;/documentation&gt;       &lt;/annotation&gt;     &lt;/enumeration&gt;     &lt;enumeration value="0370042"&gt; </pre>		

	<pre> &lt;annotation&gt;   &lt;documentation&gt;andere&lt;/documentation&gt; &lt;/annotation&gt; &lt;/enumeration&gt; &lt;/restriction&gt; &lt;/simpleType&gt; </pre>
--	---

### simpleType enum\_0371

namespace	http://xml.ir-d.de/sak		
type	restriction of <b>string</b>		
properties	base xs:string		
facets	Kind	Value	Annotation
	enumeration	0371001	documentation keine
	enumeration	0371002	documentation leicht
	enumeration	0371003	documentation mittel
	enumeration	0371004	documentation schwer
	enumeration	0371099	documentation unbekannt
annotation	documentation Kat_AK_Verkalkungsgrad		
source	<pre> &lt;simpleType name="enum_0371"&gt;   &lt;annotation&gt;     &lt;documentation&gt;Kat_AK_Verkalkungsgrad&lt;/documentation&gt;   &lt;/annotation&gt;   &lt;restriction base="xs:string"&gt;     &lt;enumeration value="0371001"&gt;       &lt;annotation&gt;         &lt;documentation&gt;keine&lt;/documentation&gt;       &lt;/annotation&gt;     &lt;/enumeration&gt;     &lt;enumeration value="0371002"&gt;       &lt;annotation&gt;         &lt;documentation&gt;leicht&lt;/documentation&gt;       &lt;/annotation&gt;     &lt;/enumeration&gt;     &lt;enumeration value="0371003"&gt;       &lt;annotation&gt;         &lt;documentation&gt;mittel&lt;/documentation&gt;       &lt;/annotation&gt;     &lt;/enumeration&gt;     &lt;enumeration value="0371004"&gt;       &lt;annotation&gt;         &lt;documentation&gt;schwer&lt;/documentation&gt;       &lt;/annotation&gt;     &lt;/enumeration&gt;     &lt;enumeration value="0371099"&gt;       &lt;annotation&gt;         &lt;documentation&gt;unbekannt&lt;/documentation&gt;       &lt;/annotation&gt;     &lt;/enumeration&gt;   &lt;/restriction&gt; &lt;/simpleType&gt; </pre>		

### simpleType enum 0372

namespace	http://xml.ir-d.de/sak		
type	restriction of <b>string</b>		
properties	base xs:string		
facets	Kind	Value	Annotation
	enumeration	0372001	documentation nein
	enumeration	0372002	documentation ja, bicuspide
	enumeration	0372003	documentation ja, unicuspide
	enumeration	0372099	documentation unbekannt
annotation	documentation Kat AK BiUnicuspideKlappe		
source	<pre> &lt;simpleType name="enum_0372"&gt;   &lt;annotation&gt;     &lt;documentation&gt;Kat_AK_BiUnicuspideKlappe&lt;/documentation&gt;   &lt;/annotation&gt;   &lt;restriction base="xs:string"&gt;     &lt;enumeration value="0372001"&gt;       &lt;annotation&gt;         &lt;documentation&gt;nein&lt;/documentation&gt;       &lt;/annotation&gt;     &lt;/enumeration&gt;     &lt;enumeration value="0372002"&gt;       &lt;annotation&gt;         &lt;documentation&gt;ja, bicuspide&lt;/documentation&gt;       &lt;/annotation&gt;     &lt;/enumeration&gt;     &lt;enumeration value="0372003"&gt;       &lt;annotation&gt;         &lt;documentation&gt;ja, unicuspide&lt;/documentation&gt;       &lt;/annotation&gt;     &lt;/enumeration&gt;     &lt;enumeration value="0372099"&gt;       &lt;annotation&gt;         &lt;documentation&gt;unbekannt&lt;/documentation&gt;       &lt;/annotation&gt;     &lt;/enumeration&gt;   &lt;/restriction&gt; &lt;/simpleType&gt; </pre>		

### simpleType enum 0373

namespace	http://xml.ir-d.de/sak		
type	restriction of <b>string</b>		
properties	base xs:string		
facets	Kind	Value	Annotation
	enumeration	0373001	documentation keine
	enumeration	0373002	documentation leichtgradig

	enumeration 0373003 documentation mittelgradig enumeration 0373004 documentation hochgradig enumeration 0373099 documentation unbekannt
annotation	documentation Kat_AK_Grad
source	<pre> &lt;simpleType name="enum_0373"&gt;   &lt;annotation&gt;     &lt;documentation&gt;Kat_AK_Grad&lt;/documentation&gt;   &lt;/annotation&gt;   &lt;restriction base="xs:string"&gt;     &lt;enumeration value="0373001"&gt;       &lt;annotation&gt;         &lt;documentation&gt;keine&lt;/documentation&gt;       &lt;/annotation&gt;     &lt;/enumeration&gt;     &lt;enumeration value="0373002"&gt;       &lt;annotation&gt;         &lt;documentation&gt;leichtgradig&lt;/documentation&gt;       &lt;/annotation&gt;     &lt;/enumeration&gt;     &lt;enumeration value="0373003"&gt;       &lt;annotation&gt;         &lt;documentation&gt;mittelgradig&lt;/documentation&gt;       &lt;/annotation&gt;     &lt;/enumeration&gt;     &lt;enumeration value="0373004"&gt;       &lt;annotation&gt;         &lt;documentation&gt;hochgradig&lt;/documentation&gt;       &lt;/annotation&gt;     &lt;/enumeration&gt;     &lt;enumeration value="0373099"&gt;       &lt;annotation&gt;         &lt;documentation&gt;unbekannt&lt;/documentation&gt;       &lt;/annotation&gt;     &lt;/enumeration&gt;   &lt;/restriction&gt; &lt;/simpleType&gt; </pre>

### simpleType enum\_0374

namespace	http://xml.lir-d.de/sak		
type	restriction of <b>string</b>		
properties	base xs:string		
facets	Kind	Value	Annotation
	enumeration	0374001	documentation nein
	enumeration	0374002	documentation ja, &lt;= 6 Stunden
	enumeration	0374003	documentation ja, &gt; 6 Stunden bis &lt;= 24 Stunden
	enumeration	0374004	documentation ja, &gt; 1 bis 7 Tage
	enumeration	0374005	documentation ja, &gt; 7 bis 21 Tage
	enumeration	0374006	documentation

	enumeration 0374099 ja, > 21 Tage documentation unbekannt
annotation	documentation Kat_AK_InfarktAnamnese
source	<pre> &lt;simpleType name="enum_0374"&gt;   &lt;annotation&gt;     &lt;documentation&gt;Kat_AK_InfarktAnamnese&lt;/documentation&gt;   &lt;/annotation&gt;   &lt;restriction base="xs:string"&gt;     &lt;enumeration value="0374001"&gt;       &lt;annotation&gt;         &lt;documentation&gt;nein&lt;/documentation&gt;       &lt;/annotation&gt;     &lt;/enumeration&gt;     &lt;enumeration value="0374002"&gt;       &lt;annotation&gt;         &lt;documentation&gt;ja, &amp;lt;= 6 Stunden&lt;/documentation&gt;       &lt;/annotation&gt;     &lt;/enumeration&gt;     &lt;enumeration value="0374003"&gt;       &lt;annotation&gt;         &lt;documentation&gt;ja, &amp;gt; 6 Stunden bis &amp;lt;= 24 Stunden&lt;/documentation&gt;       &lt;/annotation&gt;     &lt;/enumeration&gt;     &lt;enumeration value="0374004"&gt;       &lt;annotation&gt;         &lt;documentation&gt;ja, &amp;gt; 1 bis 7 Tage&lt;/documentation&gt;       &lt;/annotation&gt;     &lt;/enumeration&gt;     &lt;enumeration value="0374005"&gt;       &lt;annotation&gt;         &lt;documentation&gt;ja, &amp;gt; 7 bis 21 Tage&lt;/documentation&gt;       &lt;/annotation&gt;     &lt;/enumeration&gt;     &lt;enumeration value="0374006"&gt;       &lt;annotation&gt;         &lt;documentation&gt;ja, &amp;gt; 21 Tage&lt;/documentation&gt;       &lt;/annotation&gt;     &lt;/enumeration&gt;     &lt;enumeration value="0374099"&gt;       &lt;annotation&gt;         &lt;documentation&gt;unbekannt&lt;/documentation&gt;       &lt;/annotation&gt;     &lt;/enumeration&gt;   &lt;/restriction&gt; &lt;/simpleType&gt; </pre>

### simpleType enum\_0375

namespace	http://xml.ir-d.de/sak		
type	restriction of <b>string</b>		
properties	base xs:string		
facets	Kind	Value	Annotation
	enumeration	0375001	documentation keine Symptome oder Angina
	enumeration	0375002	documentation

	<p>enumeration 0375003 Symptome, aber keine Ischämiezeichen documentation stabile Angina</p> <p>enumeration 0375004 documentation instabile Angina</p> <p>enumeration 0375005 documentation Infarkt ohne ST-Hebung (Non-STEMI)</p> <p>enumeration 0375006 documentation Infarkt mit ST-Hebung (STEMI)</p> <p>enumeration 0375042 documentation unbekannt</p>
annotation	documentation Kat_AK_KardialeSymptome
source	<pre> &lt;simpleType name="enum_0375"&gt;   &lt;annotation&gt;     &lt;documentation&gt;Kat_AK_KardialeSymptome&lt;/documentation&gt;   &lt;/annotation&gt;   &lt;restriction base="xs:string"&gt;     &lt;enumeration value="0375001"&gt;       &lt;annotation&gt;         &lt;documentation&gt;keine Symptome oder Angina&lt;/documentation&gt;       &lt;/annotation&gt;     &lt;/enumeration&gt;     &lt;enumeration value="0375002"&gt;       &lt;annotation&gt;         &lt;documentation&gt;Symptome, aber keine Ischämiezeichen&lt;/documentation&gt;       &lt;/annotation&gt;     &lt;/enumeration&gt;     &lt;enumeration value="0375003"&gt;       &lt;annotation&gt;         &lt;documentation&gt;stabile Angina&lt;/documentation&gt;       &lt;/annotation&gt;     &lt;/enumeration&gt;     &lt;enumeration value="0375004"&gt;       &lt;annotation&gt;         &lt;documentation&gt;instabile Angina&lt;/documentation&gt;       &lt;/annotation&gt;     &lt;/enumeration&gt;     &lt;enumeration value="0375005"&gt;       &lt;annotation&gt;         &lt;documentation&gt;Infarkt ohne ST-Hebung (Non-STEMI)&lt;/documentation&gt;       &lt;/annotation&gt;     &lt;/enumeration&gt;     &lt;enumeration value="0375006"&gt;       &lt;annotation&gt;         &lt;documentation&gt;Infarkt mit ST-Hebung (STEMI)&lt;/documentation&gt;       &lt;/annotation&gt;     &lt;/enumeration&gt;     &lt;enumeration value="0375042"&gt;       &lt;annotation&gt;         &lt;documentation&gt;unbekannt&lt;/documentation&gt;       &lt;/annotation&gt;     &lt;/enumeration&gt;   &lt;/restriction&gt; &lt;/simpleType&gt; </pre>



### simpleType enum\_0376

namespace	http://xml.ir-d.de/sak		
type	restriction of <b>string</b>		
properties	base xs:string		
facets	Kind	Value	Annotation
	enumeration	0376001	documentation nein
	enumeration	0376002	documentation ja, ZNS, zerebrovaskuläre Blutung
	enumeration	0376003	documentation ja, ZNS, zerebrovaskuläre Ischämie
	enumeration	0376042	documentation ja, ZNS, andere
annotation	documentation Kat_AK_Schlaganfall		
source	<pre> &lt;simpleType name="enum_0376"&gt;   &lt;annotation&gt;     &lt;documentation&gt;Kat_AK_Schlaganfall&lt;/documentation&gt;   &lt;/annotation&gt;   &lt;restriction base="xs:string"&gt;     &lt;enumeration value="0376001"&gt;       &lt;annotation&gt;         &lt;documentation&gt;nein&lt;/documentation&gt;       &lt;/annotation&gt;     &lt;/enumeration&gt;     &lt;enumeration value="0376002"&gt;       &lt;annotation&gt;         &lt;documentation&gt;ja, ZNS, zerebrovaskuläre Blutung&lt;/documentation&gt;       &lt;/annotation&gt;     &lt;/enumeration&gt;     &lt;enumeration value="0376003"&gt;       &lt;annotation&gt;         &lt;documentation&gt;ja, ZNS, zerebrovaskuläre Ischämie&lt;/documentation&gt;       &lt;/annotation&gt;     &lt;/enumeration&gt;     &lt;enumeration value="0376042"&gt;       &lt;annotation&gt;         &lt;documentation&gt;ja, ZNS, andere&lt;/documentation&gt;       &lt;/annotation&gt;     &lt;/enumeration&gt;   &lt;/restriction&gt; &lt;/simpleType&gt; </pre>		

### simpleType enum\_0377

namespace	http://xml.ir-d.de/sak		
type	restriction of <b>string</b>		
properties	base xs:string		
facets	Kind	Value	Annotation
	enumeration	0377001	documentation ja, mild neurological dysfunction: NIHSS 0-5
	enumeration	0377002	documentation ja, moderate neurological dysfunction: NIHSS 6-14
	enumeration	0377003	documentation ja, severe neurological dysfunction: NIHSS &gt;=15

annotation	documentation Kat_AK_Nihss
source	<pre> &lt;simpleType name="enum_0377"&gt;   &lt;annotation&gt;     &lt;documentation&gt;Kat_AK_Nihss&lt;/documentation&gt;   &lt;/annotation&gt;   &lt;restriction base="xs:string"&gt;     &lt;enumeration value="0377001"&gt;       &lt;annotation&gt;         &lt;documentation&gt;ja, mild neurological dysfunction: NIHSS 0-5&lt;/documentation&gt;       &lt;/annotation&gt;     &lt;/enumeration&gt;     &lt;enumeration value="0377002"&gt;       &lt;annotation&gt;         &lt;documentation&gt;ja, moderate neurological dysfunction: NIHSS 6-14&lt;/documentation&gt;       &lt;/annotation&gt;     &lt;/enumeration&gt;     &lt;enumeration value="0377003"&gt;       &lt;annotation&gt;         &lt;documentation&gt; ja, severe neurological dysfunction: NIHSS &amp;gt;=15&lt;/documentation&gt;       &lt;/annotation&gt;     &lt;/enumeration&gt;   &lt;/restriction&gt; &lt;/simpleType&gt; </pre>

### simpleType enum\_0378

namespace	http://xml.ir-d.de/sak		
type	restriction of <b>string</b>		
properties	base xs:string		
facets	Kind	Value	Annotation
	enumeration	0378001	documentation nein
	enumeration	0378002	documentation ja, &lt; 48h gemäss VARC-3-Definition
	enumeration	0378003	documentation ja, &gt;= 48h - &lt;= 72h gemäß VARC-3-Definition
	enumeration	0378004	documentation ja, &gt; 72 h gemäß VARC-3 Definition
annotation	documentation Kat_AK_Myokardinfarkt		
source	<pre> &lt;simpleType name="enum_0378"&gt;   &lt;annotation&gt;     &lt;documentation&gt;Kat_AK_Myokardinfarkt&lt;/documentation&gt;   &lt;/annotation&gt;   &lt;restriction base="xs:string"&gt;     &lt;enumeration value="0378001"&gt;       &lt;annotation&gt;         &lt;documentation&gt;nein&lt;/documentation&gt;       &lt;/annotation&gt;     &lt;/enumeration&gt;     &lt;enumeration value="0378002"&gt;       &lt;annotation&gt;         &lt;documentation&gt;ja, &amp;lt; 48h gemäss VARC-3-Definition&lt;/documentation&gt; </pre>		

	<pre> &lt;/annotation&gt; &lt;/enumeration&gt; &lt;enumeration value="0378003"&gt;   &lt;annotation&gt;     &lt;documentation&gt;ja, &gt;= 48h - &lt;= 72h gemäß VARC-3-Definition&lt;/documentation&gt;   &lt;/annotation&gt; &lt;/enumeration&gt; &lt;enumeration value="0378004"&gt;   &lt;annotation&gt;     &lt;documentation&gt;ja, &gt; 72 h gemäß VARC-3 Definition&lt;/documentation&gt;   &lt;/annotation&gt; &lt;/enumeration&gt; &lt;/restriction&gt; &lt;/simpleType&gt; </pre>
--	--

### simpleType enum 0379

namespace	http://xml.ir-d.de/sak		
type	restriction of <b>string</b>		
properties	base xs:string		
facets	Kind	Value	Annotation
	enumeration	0379001	documentation Keine gefäss- oder zugangsassoziierte Komplikationen
	enumeration	0379002	documentation Versagen des perkutanen Verschlusssystems
	enumeration	0379003	documentation Geringfügige Gefäßkomplikationen
	enumeration	0379004	documentation Erhebliche Gefäßkomplikationen
annotation	documentation Kat_AK_ZugangKomplikationen		
source	<pre> &lt;simpleType name="enum_0379"&gt;   &lt;annotation&gt;     &lt;documentation&gt;Kat_AK_ZugangKomplikationen&lt;/documentation&gt;   &lt;/annotation&gt;   &lt;restriction base="xs:string"&gt;     &lt;enumeration value="0379001"&gt;       &lt;annotation&gt;         &lt;documentation&gt;Keine gefäss- oder zugangsassoziierte Komplikationen&lt;/documentation&gt;       &lt;/annotation&gt;     &lt;/enumeration&gt;     &lt;enumeration value="0379002"&gt;       &lt;annotation&gt;         &lt;documentation&gt;Versagen des perkutanen Verschlusssystems&lt;/documentation&gt;       &lt;/annotation&gt;     &lt;/enumeration&gt;     &lt;enumeration value="0379003"&gt;       &lt;annotation&gt;         &lt;documentation&gt;Geringfügige Gefäßkomplikationen&lt;/documentation&gt;       &lt;/annotation&gt;     &lt;/enumeration&gt;     &lt;enumeration value="0379004"&gt;       &lt;annotation&gt;         &lt;documentation&gt;Erhebliche Gefäßkomplikationen&lt;/documentation&gt; </pre>		

	<pre> &lt;/annotation&gt; &lt;/enumeration&gt; &lt;/restriction&gt; &lt;/simpleType&gt; </pre>
--	--

### simpleType enum\_0380

namespace	http://xml.ir-d.de/sak															
type	restriction of <b>string</b>															
properties	base xs:string															
facets	<table border="1"> <thead> <tr> <th>Kind</th> <th>Value</th> <th>Annotation</th> </tr> </thead> <tbody> <tr> <td>enumeration</td> <td>0380001</td> <td>documentation nein</td> </tr> <tr> <td>enumeration</td> <td>0380002</td> <td>documentation ja, intraprozedural</td> </tr> <tr> <td>enumeration</td> <td>0380003</td> <td>documentation ja, postprozedural</td> </tr> <tr> <td>enumeration</td> <td>0380004</td> <td>documentation ja, Zeitpunkt nicht bekannt</td> </tr> </tbody> </table>	Kind	Value	Annotation	enumeration	0380001	documentation nein	enumeration	0380002	documentation ja, intraprozedural	enumeration	0380003	documentation ja, postprozedural	enumeration	0380004	documentation ja, Zeitpunkt nicht bekannt
Kind	Value	Annotation														
enumeration	0380001	documentation nein														
enumeration	0380002	documentation ja, intraprozedural														
enumeration	0380003	documentation ja, postprozedural														
enumeration	0380004	documentation ja, Zeitpunkt nicht bekannt														
annotation	documentation Kat_AK_Reanimation															
source	<pre> &lt;simpleType name="enum_0380"&gt;   &lt;annotation&gt;     &lt;documentation&gt;Kat_AK_Reanimation&lt;/documentation&gt;   &lt;/annotation&gt;   &lt;restriction base="xs:string"&gt;     &lt;enumeration value="0380001"&gt;       &lt;annotation&gt;         &lt;documentation&gt;nein&lt;/documentation&gt;       &lt;/annotation&gt;     &lt;/enumeration&gt;     &lt;enumeration value="0380002"&gt;       &lt;annotation&gt;         &lt;documentation&gt;ja, intraprozedural&lt;/documentation&gt;       &lt;/annotation&gt;     &lt;/enumeration&gt;     &lt;enumeration value="0380003"&gt;       &lt;annotation&gt;         &lt;documentation&gt;ja, postprozedural&lt;/documentation&gt;       &lt;/annotation&gt;     &lt;/enumeration&gt;     &lt;enumeration value="0380004"&gt;       &lt;annotation&gt;         &lt;documentation&gt;ja, Zeitpunkt nicht bekannt&lt;/documentation&gt;       &lt;/annotation&gt;     &lt;/enumeration&gt;   &lt;/restriction&gt; &lt;/simpleType&gt; </pre>															

### simpleType enum\_0381

namespace	http://xml.ir-d.de/sak
type	restriction of <b>string</b>
properties	base xs:string

facets	<table border="1"> <thead> <tr> <th>Kind</th> <th>Value</th> <th>Annotation</th> </tr> </thead> <tbody> <tr> <td>enumeration</td> <td>0381001</td> <td>documentation nein</td> </tr> <tr> <td>enumeration</td> <td>0381002</td> <td>documentation Thorakotomie/Rethorakotomie</td> </tr> <tr> <td>enumeration</td> <td>0381003</td> <td>documentation kathetergestützte Reintervention</td> </tr> <tr> <td>enumeration</td> <td>0381004</td> <td>documentation lokale Reinterventionen</td> </tr> <tr> <td>enumeration</td> <td>0381005</td> <td>documentation andere Reintervention</td> </tr> </tbody> </table>	Kind	Value	Annotation	enumeration	0381001	documentation nein	enumeration	0381002	documentation Thorakotomie/Rethorakotomie	enumeration	0381003	documentation kathetergestützte Reintervention	enumeration	0381004	documentation lokale Reinterventionen	enumeration	0381005	documentation andere Reintervention
Kind	Value	Annotation																	
enumeration	0381001	documentation nein																	
enumeration	0381002	documentation Thorakotomie/Rethorakotomie																	
enumeration	0381003	documentation kathetergestützte Reintervention																	
enumeration	0381004	documentation lokale Reinterventionen																	
enumeration	0381005	documentation andere Reintervention																	
annotation	documentation Kat AK Massnahmen																		
source	<pre> &lt;simpleType name="enum_0381"&gt;   &lt;annotation&gt;     &lt;documentation&gt;Kat_AK_Massnahmen&lt;/documentation&gt;   &lt;/annotation&gt;   &lt;restriction base="xs:string"&gt;     &lt;enumeration value="0381001"&gt;       &lt;annotation&gt;         &lt;documentation&gt;nein&lt;/documentation&gt;       &lt;/annotation&gt;     &lt;/enumeration&gt;     &lt;enumeration value="0381002"&gt;       &lt;annotation&gt;         &lt;documentation&gt;Thorakotomie/Rethorakotomie&lt;/documentation&gt;       &lt;/annotation&gt;     &lt;/enumeration&gt;     &lt;enumeration value="0381003"&gt;       &lt;annotation&gt;         &lt;documentation&gt;kathetergestützte Reintervention&lt;/documentation&gt;       &lt;/annotation&gt;     &lt;/enumeration&gt;     &lt;enumeration value="0381004"&gt;       &lt;annotation&gt;         &lt;documentation&gt;lokale Reinterventionen&lt;/documentation&gt;       &lt;/annotation&gt;     &lt;/enumeration&gt;     &lt;enumeration value="0381005"&gt;       &lt;annotation&gt;         &lt;documentation&gt;andere Reintervention&lt;/documentation&gt;       &lt;/annotation&gt;     &lt;/enumeration&gt;   &lt;/restriction&gt; &lt;/simpleType&gt; </pre>																		

### simpleType enum\_0382

namespace	http://xml.ir-d.de/sak												
type	restriction of <b>string</b>												
properties	base xs:string												
facets	<table border="1"> <thead> <tr> <th>Kind</th> <th>Value</th> <th>Annotation</th> </tr> </thead> <tbody> <tr> <td>enumeration</td> <td>0382001</td> <td>documentation keine Rethorakotomie / kein weiterer Grund</td> </tr> <tr> <td>enumeration</td> <td>0382002</td> <td>documentation Blutung/Hämatom</td> </tr> <tr> <td>enumeration</td> <td>0382003</td> <td>documentation Low Cardiac Output</td> </tr> </tbody> </table>	Kind	Value	Annotation	enumeration	0382001	documentation keine Rethorakotomie / kein weiterer Grund	enumeration	0382002	documentation Blutung/Hämatom	enumeration	0382003	documentation Low Cardiac Output
Kind	Value	Annotation											
enumeration	0382001	documentation keine Rethorakotomie / kein weiterer Grund											
enumeration	0382002	documentation Blutung/Hämatom											
enumeration	0382003	documentation Low Cardiac Output											

	<p>enumeration 0382004 documentation Tamponade</p> <p>enumeration 0382005 documentation Graftprobleme, Ischämie</p> <p>enumeration 0382006 documentation Wundinfektion, Mediastinitis</p> <p>enumeration 0382007 documentation Dissektion</p> <p>enumeration 0382008 documentation Prothesendysfunktion</p> <p>enumeration 0382009 documentation instabiles Sternum</p> <p>enumeration 0382010 documentation Chylothorax</p> <p>enumeration 0382011 documentation lokale Revision im Bereich des Zugangsweges</p> <p>enumeration 0382042 documentation anderer Grund</p>
annotation	documentation Kat_AK_Komplikation
source	<pre> &lt;simpleType name="enum_0382"&gt;   &lt;annotation&gt;     &lt;documentation&gt;Kat_AK_Komplikation&lt;/documentation&gt;   &lt;/annotation&gt;   &lt;restriction base="xs:string"&gt;     &lt;enumeration value="0382001"&gt;       &lt;annotation&gt;         &lt;documentation&gt;keine Rethorakotomie / kein weiterer Grund&lt;/documentation&gt;       &lt;/annotation&gt;     &lt;/enumeration&gt;     &lt;enumeration value="0382002"&gt;       &lt;annotation&gt;         &lt;documentation&gt;Blutung/Hämatom&lt;/documentation&gt;       &lt;/annotation&gt;     &lt;/enumeration&gt;     &lt;enumeration value="0382003"&gt;       &lt;annotation&gt;         &lt;documentation&gt;Low Cardiac Output&lt;/documentation&gt;       &lt;/annotation&gt;     &lt;/enumeration&gt;     &lt;enumeration value="0382004"&gt;       &lt;annotation&gt;         &lt;documentation&gt;Tamponade&lt;/documentation&gt;       &lt;/annotation&gt;     &lt;/enumeration&gt;     &lt;enumeration value="0382005"&gt;       &lt;annotation&gt;         &lt;documentation&gt;Graftprobleme, Ischämie&lt;/documentation&gt;       &lt;/annotation&gt;     &lt;/enumeration&gt;     &lt;enumeration value="0382006"&gt;       &lt;annotation&gt;         &lt;documentation&gt;Wundinfektion, Mediastinitis&lt;/documentation&gt;       &lt;/annotation&gt;     &lt;/enumeration&gt;     &lt;enumeration value="0382007"&gt;       &lt;annotation&gt;         &lt;documentation&gt;Dissektion&lt;/documentation&gt;       &lt;/annotation&gt;     &lt;/enumeration&gt;   &lt;/restriction&gt; &lt;/simpleType&gt; </pre>

	<pre> &lt;/enumeration&gt; &lt;enumeration value="0382008"&gt;   &lt;annotation&gt;     &lt;documentation&gt;Prothesendysfunktion&lt;/documentation&gt;   &lt;/annotation&gt; &lt;/enumeration&gt; &lt;enumeration value="0382009"&gt;   &lt;annotation&gt;     &lt;documentation&gt;instabiles Sternum&lt;/documentation&gt;   &lt;/annotation&gt; &lt;/enumeration&gt; &lt;enumeration value="0382010"&gt;   &lt;annotation&gt;     &lt;documentation&gt;Chylothorax&lt;/documentation&gt;   &lt;/annotation&gt; &lt;/enumeration&gt; &lt;enumeration value="0382011"&gt;   &lt;annotation&gt;     &lt;documentation&gt;lokale Revision im Bereich des Zugangsweges&lt;/documentation&gt;   &lt;/annotation&gt; &lt;/enumeration&gt; &lt;enumeration value="0382042"&gt;   &lt;annotation&gt;     &lt;documentation&gt;anderer Grund&lt;/documentation&gt;   &lt;/annotation&gt; &lt;/enumeration&gt; &lt;/restriction&gt; &lt;/simpleType&gt; </pre>
--	---

### simpleType enum\_0383

namespace	http://xml.ir-d.de/sak		
type	restriction of <b>string</b>		
properties	base xs:string		
facets	Kind	Value	Annotation
	enumeration	0383001	documentation nein
	enumeration	0383002	documentation ja, mit forcierter Atemtherapie
	enumeration	0383003	documentation ja, Reintubation oder längerfristige Beatmung
	enumeration	0383004	documentation ja, Tracheotomie
annotation	documentation Kat_AK_RespiratorischeInsuffizienz		
source	<pre> &lt;simpleType name="enum_0383"&gt;   &lt;annotation&gt;     &lt;documentation&gt;Kat_AK_RespiratorischeInsuffizienz&lt;/documentation&gt;   &lt;/annotation&gt;   &lt;restriction base="xs:string"&gt;     &lt;enumeration value="0383001"&gt;       &lt;annotation&gt;         &lt;documentation&gt;nein&lt;/documentation&gt;       &lt;/annotation&gt;     &lt;/enumeration&gt;     &lt;enumeration value="0383002"&gt; </pre>		

	<pre> &lt;annotation&gt;   &lt;documentation&gt;ja, mit forcierter Atemtherapie&lt;/documentation&gt; &lt;/annotation&gt; &lt;/enumeration&gt; &lt;enumeration value="0383003"&gt;   &lt;annotation&gt;     &lt;documentation&gt;ja, Reintubation oder längerfristige Beatmung&lt;/documentation&gt;   &lt;/annotation&gt; &lt;/enumeration&gt; &lt;enumeration value="0383004"&gt;   &lt;annotation&gt;     &lt;documentation&gt;ja, Tracheotomie&lt;/documentation&gt;   &lt;/annotation&gt; &lt;/enumeration&gt; &lt;/restriction&gt; &lt;/simpleType&gt; </pre>
--	---

### simpleType enum 0384

namespace	http://xml.ir-d.de/sak		
type	restriction of <b>string</b>		
properties	base xs:string		
facets	Kind	Value	Annotation
	enumeration	0384001	documentation keine Blutungskomplikationen
	enumeration	0384002	documentation Geringfügige Blutung (Minor Bleeding - BARC type 2 or 3a)
	enumeration	0384003	documentation Starke Blutung (Major Bleeding - BARC type 3a)
	enumeration	0384004	documentation Lebensbedrohliche Blutung (Life-threatening or disabling bleeding - BARC type 3b or 3c or type 5)
annotation	documentation Kat_AK_Blutungskomplikation		
source	<pre> &lt;simpleType name="enum_0384"&gt;   &lt;annotation&gt;     &lt;documentation&gt;Kat_AK_Blutungskomplikation&lt;/documentation&gt;   &lt;/annotation&gt;   &lt;restriction base="xs:string"&gt;     &lt;enumeration value="0384001"&gt;       &lt;annotation&gt;         &lt;documentation&gt;keine Blutungskomplikationen&lt;/documentation&gt;       &lt;/annotation&gt;     &lt;/enumeration&gt;     &lt;enumeration value="0384002"&gt;       &lt;annotation&gt;         &lt;documentation&gt;Geringfügige Blutung (Minor Bleeding - BARC type 2 or 3a)&lt;/documentation&gt;       &lt;/annotation&gt;     &lt;/enumeration&gt;     &lt;enumeration value="0384003"&gt;       &lt;annotation&gt;         &lt;documentation&gt;Starke Blutung (Major Bleeding - BARC type 3a)&lt;/documentation&gt;       &lt;/annotation&gt;     &lt;/enumeration&gt;   &lt;/restriction&gt; &lt;/simpleType&gt; </pre>		



	<pre> &lt;enumeration value="0384004"&gt;   &lt;annotation&gt;     &lt;documentation&gt;Lebensbedrohliche Blutung (Life-threatening or disabling bleeding - BARC type 3b or 3c or type 5)&lt;/documentation&gt;   &lt;/annotation&gt; &lt;/enumeration&gt; &lt;/restriction&gt; &lt;/simpleType&gt; </pre>
--	--

simpleType **enum\_0385**

namespace	http://xml.ir-d.de/sak		
type	restriction of <b>string</b>		
properties	base xs:string		
facets	Kind	Value	Annotation
	enumeration	0385001	documentation Sinusrhythmus
	enumeration	0385002	documentation Vorhofflimmern
	enumeration	0385003	documentation Patient verstorben (kein Herzrhythmus)
	enumeration	0385042	documentation anderer Rhythmus
annotation	documentation Kat_AK_HerzrhythmusEntlassung		
source	<pre> &lt;simpleType name="enum_0385"&gt;   &lt;annotation&gt;     &lt;documentation&gt;Kat_AK_HerzrhythmusEntlassung&lt;/documentation&gt;   &lt;/annotation&gt;   &lt;restriction base="xs:string"&gt;     &lt;enumeration value="0385001"&gt;       &lt;annotation&gt;         &lt;documentation&gt;Sinusrhythmus&lt;/documentation&gt;       &lt;/annotation&gt;     &lt;/enumeration&gt;     &lt;enumeration value="0385002"&gt;       &lt;annotation&gt;         &lt;documentation&gt;Vorhofflimmern&lt;/documentation&gt;       &lt;/annotation&gt;     &lt;/enumeration&gt;     &lt;enumeration value="0385003"&gt;       &lt;annotation&gt;         &lt;documentation&gt;Patient verstorben (kein Herzrhythmus)&lt;/documentation&gt;       &lt;/annotation&gt;     &lt;/enumeration&gt;     &lt;enumeration value="0385042"&gt;       &lt;annotation&gt;         &lt;documentation&gt;anderer Rhythmus&lt;/documentation&gt;       &lt;/annotation&gt;     &lt;/enumeration&gt;   &lt;/restriction&gt; &lt;/simpleType&gt; </pre>		

### simpleType enum\_0388

namespace	http://xml.ir-d.de/sak		
type	restriction of <b>string</b>		
properties	base xs:string		
facets	Kind	Value	Annotation
	enumeration	0388001	documentation nein
	enumeration	0388002	documentation ASS
	enumeration	0388003	documentation ADP-Rezeptor-Antagonist
	enumeration	0388004	documentation Kombination ASS und ADP-Rezeptor-Antagonist
	enumeration	0388042	documentation ja, andere
	enumeration	0388099	documentation unbekannt
annotation	documentation Kat_AK_Plaettchenaggregationshemmer		
source	<pre> &lt;simpleType name="enum_0388"&gt;   &lt;annotation&gt;     &lt;documentation&gt;Kat_AK_Plaettchenaggregationshemmer&lt;/documentation&gt;   &lt;/annotation&gt;   &lt;restriction base="xs:string"&gt;     &lt;enumeration value="0388001"&gt;       &lt;annotation&gt;         &lt;documentation&gt;nein&lt;/documentation&gt;       &lt;/annotation&gt;     &lt;/enumeration&gt;     &lt;enumeration value="0388002"&gt;       &lt;annotation&gt;         &lt;documentation&gt;ASS&lt;/documentation&gt;       &lt;/annotation&gt;     &lt;/enumeration&gt;     &lt;enumeration value="0388003"&gt;       &lt;annotation&gt;         &lt;documentation&gt;ADP-Rezeptor-Antagonist&lt;/documentation&gt;       &lt;/annotation&gt;     &lt;/enumeration&gt;     &lt;enumeration value="0388004"&gt;       &lt;annotation&gt;         &lt;documentation&gt;Kombination ASS und ADP-Rezeptor-Antagonist&lt;/documentation&gt;       &lt;/annotation&gt;     &lt;/enumeration&gt;     &lt;enumeration value="0388042"&gt;       &lt;annotation&gt;         &lt;documentation&gt;ja, andere&lt;/documentation&gt;       &lt;/annotation&gt;     &lt;/enumeration&gt;     &lt;enumeration value="0388099"&gt;       &lt;annotation&gt;         &lt;documentation&gt;unbekannt&lt;/documentation&gt;       &lt;/annotation&gt;     &lt;/enumeration&gt;   &lt;/restriction&gt; &lt;/simpleType&gt; </pre>		

### simpleType enum\_0389

namespace	http://xml.ir-d.de/sak		
type	restriction of <b>string</b>		
properties	base xs:string		
facets	Kind	Value	Annotation
	enumeration	0389001	documentation nein
	enumeration	0389002	documentation Cumarin-Derivate
	enumeration	0389003	documentation Heparinoide
	enumeration	0389004	documentation orale Thrombinantagonisten
	enumeration	0389005	documentation Kombination Heparinoide und Cumarin-Derivate
	enumeration	0389006	documentation Direkte orale Antikoagulantien (DOAK / NOAK)
	enumeration	0389042	documentation ja, andere
	enumeration	0389099	documentation unbekannt
annotation	documentation Kat_AK_Antikoagulantien		
source	<pre> &lt;simpleType name="enum_0389"&gt;   &lt;annotation&gt;     &lt;documentation&gt;Kat_AK_Antikoagulantien&lt;/documentation&gt;   &lt;/annotation&gt;   &lt;restriction base="xs:string"&gt;     &lt;enumeration value="0389001"&gt;       &lt;annotation&gt;         &lt;documentation&gt;nein&lt;/documentation&gt;       &lt;/annotation&gt;     &lt;/enumeration&gt;     &lt;enumeration value="0389002"&gt;       &lt;annotation&gt;         &lt;documentation&gt;Cumarin-Derivate&lt;/documentation&gt;       &lt;/annotation&gt;     &lt;/enumeration&gt;     &lt;enumeration value="0389003"&gt;       &lt;annotation&gt;         &lt;documentation&gt;Heparinoide&lt;/documentation&gt;       &lt;/annotation&gt;     &lt;/enumeration&gt;     &lt;enumeration value="0389004"&gt;       &lt;annotation&gt;         &lt;documentation&gt;orale Thrombinantagonisten&lt;/documentation&gt;       &lt;/annotation&gt;     &lt;/enumeration&gt;     &lt;enumeration value="0389005"&gt;       &lt;annotation&gt;         &lt;documentation&gt;Kombination Heparinoide und Cumarin-Derivate&lt;/documentation&gt;       &lt;/annotation&gt;     &lt;/enumeration&gt;     &lt;enumeration value="0389006"&gt;       &lt;annotation&gt;         &lt;documentation&gt;Direkte orale Antikoagulantien (DOAK / </pre>		

	<pre> NOAK) &lt;/documentation&gt;   &lt;/annotation&gt; &lt;/enumeration&gt; &lt;enumeration value="0389042"&gt;   &lt;annotation&gt;     &lt;documentation&gt;ja, andere&lt;/documentation&gt;   &lt;/annotation&gt; &lt;/enumeration&gt; &lt;enumeration value="0389099"&gt;   &lt;annotation&gt;     &lt;documentation&gt;unbekannt&lt;/documentation&gt;   &lt;/annotation&gt; &lt;/enumeration&gt; &lt;/restriction&gt; &lt;/simpleType&gt; </pre>
--	--

### simpleType enum\_0390

namespace	http://xml.ir-d.de/sak		
type	restriction of <b>string</b>		
properties	base xs:string		
facets	Kind	Value	Annotation
	enumeration	0390001	documentation biologisches Klappenmodell
	enumeration	0390002	documentation mechanisches Klappenmodell
annotation	documentation Kat_AK_Artikeltyp		
source	<pre> &lt;simpleType name="enum_0390"&gt;   &lt;annotation&gt;     &lt;documentation&gt;Kat_AK_Artikeltyp&lt;/documentation&gt;   &lt;/annotation&gt;   &lt;restriction base="xs:string"&gt;     &lt;enumeration value="0390001"&gt;       &lt;annotation&gt;         &lt;documentation&gt;biologisches Klappenmodell&lt;/documentation&gt;       &lt;/annotation&gt;     &lt;/enumeration&gt;     &lt;enumeration value="0390002"&gt;       &lt;annotation&gt;         &lt;documentation&gt;mechanisches Klappenmodell&lt;/documentation&gt;       &lt;/annotation&gt;     &lt;/enumeration&gt;   &lt;/restriction&gt; &lt;/simpleType&gt; </pre>		

### simpleType enum\_0398

namespace	http://xml.ir-d.de/sak		
type	restriction of <b>string</b>		
properties	base xs:string		
facets	Kind	Value	Annotation
	enumeration	0398001	documentation kardiovaskuläre Ursache

	enumeration 0398002 documentation nicht-kardiovaskuläre Ursache enumeration 0398099 documentation Todesursache unbekannt
annotation	documentation Kat_AK_Todesursache
source	<pre> &lt;simpleType name="enum_0398"&gt;   &lt;annotation&gt;     &lt;documentation&gt;Kat_AK_Todesursache&lt;/documentation&gt;   &lt;/annotation&gt;   &lt;restriction base="xs:string"&gt;     &lt;enumeration value="0398001"&gt;       &lt;annotation&gt;         &lt;documentation&gt;kardiovaskuläre Ursache&lt;/documentation&gt;       &lt;/annotation&gt;     &lt;/enumeration&gt;     &lt;enumeration value="0398002"&gt;       &lt;annotation&gt;         &lt;documentation&gt;nicht-kardiovaskuläre Ursache&lt;/documentation&gt;       &lt;/annotation&gt;     &lt;/enumeration&gt;     &lt;enumeration value="0398099"&gt;       &lt;annotation&gt;         &lt;documentation&gt;Todesursache unbekannt&lt;/documentation&gt;       &lt;/annotation&gt;     &lt;/enumeration&gt;   &lt;/restriction&gt; &lt;/simpleType&gt; </pre>

### simpleType enum 0399

namespace	http://xml.ir-d.de/sak		
type	restriction of <b>string</b>		
properties	base xs:string		
facets	Kind	Value	Annotation
	enumeration	0399001	documentation Patient lebt
	enumeration	0399002	documentation Patient im Krankenhaus verstorben
annotation	documentation Kat_AK_Vitalstatus		
source	<pre> &lt;simpleType name="enum_0399"&gt;   &lt;annotation&gt;     &lt;documentation&gt;Kat_AK_Vitalstatus&lt;/documentation&gt;   &lt;/annotation&gt;   &lt;restriction base="xs:string"&gt;     &lt;enumeration value="0399001"&gt;       &lt;annotation&gt;         &lt;documentation&gt;Patient lebt&lt;/documentation&gt;       &lt;/annotation&gt;     &lt;/enumeration&gt;     &lt;enumeration value="0399002"&gt;       &lt;annotation&gt;         &lt;documentation&gt;Patient im Krankenhaus verstorben&lt;/documentation&gt;       &lt;/annotation&gt;     &lt;/enumeration&gt;   &lt;/restriction&gt; </pre>		

	<code>&lt;/simpleType&gt;</code>
--	----------------------------------

### simpleType enum\_0044

namespace	http://xml.ir-d.de/irdsaa																		
type	restriction of <b>string</b>																		
properties	base xs:string																		
facets	<table><thead><tr><th>Kind</th><th>Value</th><th>Annotation</th></tr></thead><tbody><tr><td>enumeration</td><td>0044001</td><td>documentation 1= normaler, sonst gesunder Patient</td></tr><tr><td>enumeration</td><td>0044002</td><td>documentation 2= Patient mit leichter Allgemeinerkrankung</td></tr><tr><td>enumeration</td><td>0044003</td><td>documentation 3= Patient mit schwerer Allgemeinerkrankung</td></tr><tr><td>enumeration</td><td>0044004</td><td>documentation 4= Patient mit schwerer Allgemeinerkrankung, die eine ständige Lebensbedrohung darstellt</td></tr><tr><td>enumeration</td><td>0044005</td><td>documentation 5= moribunder Patient, der ohne die Operation voraussichtlich nicht überleben wird</td></tr></tbody></table>	Kind	Value	Annotation	enumeration	0044001	documentation 1= normaler, sonst gesunder Patient	enumeration	0044002	documentation 2= Patient mit leichter Allgemeinerkrankung	enumeration	0044003	documentation 3= Patient mit schwerer Allgemeinerkrankung	enumeration	0044004	documentation 4= Patient mit schwerer Allgemeinerkrankung, die eine ständige Lebensbedrohung darstellt	enumeration	0044005	documentation 5= moribunder Patient, der ohne die Operation voraussichtlich nicht überleben wird
Kind	Value	Annotation																	
enumeration	0044001	documentation 1= normaler, sonst gesunder Patient																	
enumeration	0044002	documentation 2= Patient mit leichter Allgemeinerkrankung																	
enumeration	0044003	documentation 3= Patient mit schwerer Allgemeinerkrankung																	
enumeration	0044004	documentation 4= Patient mit schwerer Allgemeinerkrankung, die eine ständige Lebensbedrohung darstellt																	
enumeration	0044005	documentation 5= moribunder Patient, der ohne die Operation voraussichtlich nicht überleben wird																	
annotation	documentation Kat_ASA																		
source	<pre>&lt;simpleType name="enum_0044"&gt;   &lt;annotation&gt;     &lt;documentation&gt;Kat_ASA&lt;/documentation&gt;   &lt;/annotation&gt;   &lt;restriction base="xs:string"&gt;     &lt;enumeration value="0044001"&gt;       &lt;annotation&gt;         &lt;documentation&gt;1= normaler, sonst gesunder Patient&lt;/documentation&gt;       &lt;/annotation&gt;     &lt;/enumeration&gt;     &lt;enumeration value="0044002"&gt;       &lt;annotation&gt;         &lt;documentation&gt;2= Patient mit leichter Allgemeinerkrankung&lt;/documentation&gt;       &lt;/annotation&gt;     &lt;/enumeration&gt;     &lt;enumeration value="0044003"&gt;       &lt;annotation&gt;         &lt;documentation&gt;3= Patient mit schwerer Allgemeinerkrankung&lt;/documentation&gt;       &lt;/annotation&gt;     &lt;/enumeration&gt;     &lt;enumeration value="0044004"&gt;       &lt;annotation&gt;         &lt;documentation&gt;4= Patient mit schwerer Allgemeinerkrankung, die eine ständige Lebensbedrohung darstellt&lt;/documentation&gt;       &lt;/annotation&gt;     &lt;/enumeration&gt;     &lt;enumeration value="0044005"&gt;       &lt;annotation&gt;         &lt;documentation&gt;5= moribunder Patient, der ohne die Operation voraussichtlich nicht überleben wird&lt;/documentation&gt;       &lt;/annotation&gt;     &lt;/enumeration&gt;   &lt;/restriction&gt; &lt;/simpleType&gt;</pre>																		

### simpleType enum\_0050

namespace	http://xml.ir-d.de/irdsaa		
type	restriction of <b>string</b>		
properties	base xs:string		
facets	Kind	Value	Annotation
	enumeration	0050001	documentation rechts
	enumeration	0050002	documentation links
annotation	documentation Kat_RechtsLinks		
source	<pre> &lt;simpleType name="enum_0050"&gt;   &lt;annotation&gt;     &lt;documentation&gt;Kat_RechtsLinks&lt;/documentation&gt;   &lt;/annotation&gt;   &lt;restriction base="xs:string"&gt;     &lt;enumeration value="0050001"&gt;       &lt;annotation&gt;         &lt;documentation&gt;rechts&lt;/documentation&gt;       &lt;/annotation&gt;     &lt;/enumeration&gt;     &lt;enumeration value="0050002"&gt;       &lt;annotation&gt;         &lt;documentation&gt;links&lt;/documentation&gt;       &lt;/annotation&gt;     &lt;/enumeration&gt;   &lt;/restriction&gt; &lt;/simpleType&gt; </pre>		

### simpleType enum\_0060

namespace	http://xml.ir-d.de/irdsaa		
type	restriction of <b>string</b>		
properties	base xs:string		
facets	Kind	Value	Annotation
	enumeration	0060001	documentation ja
	enumeration	0060002	documentation nein
annotation	documentation Kat_JaNein		
source	<pre> &lt;simpleType name="enum_0060"&gt;   &lt;annotation&gt;     &lt;documentation&gt;Kat_JaNein&lt;/documentation&gt;   &lt;/annotation&gt;   &lt;restriction base="xs:string"&gt;     &lt;enumeration value="0060001"&gt;       &lt;annotation&gt;         &lt;documentation&gt;ja&lt;/documentation&gt;       &lt;/annotation&gt;     &lt;/enumeration&gt;     &lt;enumeration value="0060002"&gt; </pre>		

	<pre> &lt;annotation&gt;   &lt;documentation&gt;nein&lt;/documentation&gt; &lt;/annotation&gt; &lt;/enumeration&gt; &lt;/restriction&gt; &lt;/simpleType&gt; </pre>
--	---

### simpleType enum\_0061

namespace	http://xml.ir-d.de/irdsaa		
type	restriction of <b>string</b>		
properties	base xs:string		
facets	Kind	Value	Annotation
	enumeration	0061001	documentation ja
	enumeration	0061002	documentation nein
	enumeration	0061099	documentation unbekannt
annotation	documentation Kat_JaNeinUnbekannt		
source	<pre> &lt;simpleType name="enum_0061"&gt;   &lt;annotation&gt;     &lt;documentation&gt;Kat_JaNeinUnbekannt&lt;/documentation&gt;   &lt;/annotation&gt;   &lt;restriction base="xs:string"&gt;     &lt;enumeration value="0061001"&gt;       &lt;annotation&gt;         &lt;documentation&gt;ja&lt;/documentation&gt;       &lt;/annotation&gt;     &lt;/enumeration&gt;     &lt;enumeration value="0061002"&gt;       &lt;annotation&gt;         &lt;documentation&gt;nein&lt;/documentation&gt;       &lt;/annotation&gt;     &lt;/enumeration&gt;     &lt;enumeration value="0061099"&gt;       &lt;annotation&gt;         &lt;documentation&gt;unbekannt&lt;/documentation&gt;       &lt;/annotation&gt;     &lt;/enumeration&gt;   &lt;/restriction&gt; &lt;/simpleType&gt; </pre>		

### simpleType enum\_0062

namespace	http://xml.ir-d.de/irdsaa		
type	restriction of <b>string</b>		
properties	base xs:string		
facets	Kind	Value	Annotation
	enumeration	0062001	documentation Stück
	enumeration	0062002	documentation g
	enumeration	0062003	documentation



	<p>enumeration 0062004 mg documentation l</p> <p>enumeration 0062005 documentation ml</p> <p>enumeration 0062006 documentation cm<sup>3</sup></p> <p>enumeration 0062007 documentation mm</p> <p>enumeration 0062008 documentation cm</p> <p>enumeration 0062009 documentation dm</p> <p>enumeration 0062010 documentation m</p> <p>enumeration 0062042 documentation andere</p>
annotation	documentation Kat Einheit
source	<pre> &lt;simpleType name="enum_0062"&gt;   &lt;annotation&gt;     &lt;documentation&gt;Kat_Einheit&lt;/documentation&gt;   &lt;/annotation&gt;   &lt;restriction base="xs:string"&gt;     &lt;enumeration value="0062001"&gt;       &lt;annotation&gt;         &lt;documentation&gt;Stück&lt;/documentation&gt;       &lt;/annotation&gt;     &lt;/enumeration&gt;     &lt;enumeration value="0062002"&gt;       &lt;annotation&gt;         &lt;documentation&gt;g&lt;/documentation&gt;       &lt;/annotation&gt;     &lt;/enumeration&gt;     &lt;enumeration value="0062003"&gt;       &lt;annotation&gt;         &lt;documentation&gt;mg&lt;/documentation&gt;       &lt;/annotation&gt;     &lt;/enumeration&gt;     &lt;enumeration value="0062004"&gt;       &lt;annotation&gt;         &lt;documentation&gt;l&lt;/documentation&gt;       &lt;/annotation&gt;     &lt;/enumeration&gt;     &lt;enumeration value="0062005"&gt;       &lt;annotation&gt;         &lt;documentation&gt;ml&lt;/documentation&gt;       &lt;/annotation&gt;     &lt;/enumeration&gt;     &lt;enumeration value="0062006"&gt;       &lt;annotation&gt;         &lt;documentation&gt;cm<sup>3</sup>&lt;/documentation&gt;       &lt;/annotation&gt;     &lt;/enumeration&gt;     &lt;enumeration value="0062007"&gt;       &lt;annotation&gt;         &lt;documentation&gt;mm&lt;/documentation&gt;       &lt;/annotation&gt;     &lt;/enumeration&gt;     &lt;enumeration value="0062008"&gt; </pre>

	<pre> &lt;annotation&gt;   &lt;documentation&gt;cm&lt;/documentation&gt; &lt;/annotation&gt; &lt;/enumeration&gt; &lt;enumeration value="0062009"&gt;   &lt;annotation&gt;     &lt;documentation&gt;dm&lt;/documentation&gt;   &lt;/annotation&gt; &lt;/enumeration&gt; &lt;enumeration value="0062010"&gt;   &lt;annotation&gt;     &lt;documentation&gt;m&lt;/documentation&gt;   &lt;/annotation&gt; &lt;/enumeration&gt; &lt;enumeration value="0062042"&gt;   &lt;annotation&gt;     &lt;documentation&gt;andere&lt;/documentation&gt;   &lt;/annotation&gt; &lt;/enumeration&gt; &lt;/restriction&gt; &lt;/simpleType&gt; </pre>
--	--

### simpleType enum\_0065

namespace	http://xml.ir-d.de/irdsaa		
type	restriction of <b>string</b>		
properties	base xs:string		
facets	Kind	Value	Annotation
	enumeration	0065001	documentation stationär
	enumeration	0065002	documentation teilstationär
	enumeration	0065003	documentation ambulant
annotation	documentation Kat_ArtAufenthalt		
source	<pre> &lt;simpleType name="enum_0065"&gt;   &lt;annotation&gt;     &lt;documentation&gt;Kat_ArtAufenthalt&lt;/documentation&gt;   &lt;/annotation&gt;   &lt;restriction base="xs:string"&gt;     &lt;enumeration value="0065001"&gt;       &lt;annotation&gt;         &lt;documentation&gt;stationär&lt;/documentation&gt;       &lt;/annotation&gt;     &lt;/enumeration&gt;     &lt;enumeration value="0065002"&gt;       &lt;annotation&gt;         &lt;documentation&gt;teilstationär&lt;/documentation&gt;       &lt;/annotation&gt;     &lt;/enumeration&gt;     &lt;enumeration value="0065003"&gt;       &lt;annotation&gt;         &lt;documentation&gt;ambulant&lt;/documentation&gt;       &lt;/annotation&gt;     &lt;/enumeration&gt;   &lt;/restriction&gt; </pre>		

	<code>&lt;/simpleType&gt;</code>
--	----------------------------------

### simpleType enum\_0067

namespace	http://xml.ir-d.de/irdsaa		
type	restriction of <b>string</b>		
properties	base xs:string		
facets	Kind	Value	Annotation
	enumeration	0067001	documentation Implantat
	enumeration	0067002	documentation Explantat
annotation	documentation Kat_ArtArtikel		
source	<pre> &lt;simpleType name="enum_0067"&gt;   &lt;annotation&gt;     &lt;documentation&gt;Kat_ArtArtikel&lt;/documentation&gt;   &lt;/annotation&gt;   &lt;restriction base="xs:string"&gt;     &lt;enumeration value="0067001"&gt;       &lt;annotation&gt;         &lt;documentation&gt;Implantat&lt;/documentation&gt;       &lt;/annotation&gt;     &lt;/enumeration&gt;     &lt;enumeration value="0067002"&gt;       &lt;annotation&gt;         &lt;documentation&gt;Explantat&lt;/documentation&gt;       &lt;/annotation&gt;     &lt;/enumeration&gt;   &lt;/restriction&gt; &lt;/simpleType&gt; </pre>		

### simpleType enum\_0068

namespace	http://xml.ir-d.de/irdsaa		
type	restriction of <b>string</b>		
properties	base xs:string		
facets	Kind	Value	Annotation
	enumeration	0068001	documentation UDI
	enumeration	0068002	documentation Referenz (REF)
	enumeration	0068003	documentation Katalognummer
	enumeration	0068042	documentation sonstiger
annotation	documentation Kat_KennzeichenTyp		
source	<pre> &lt;simpleType name="enum_0068"&gt;   &lt;annotation&gt;     &lt;documentation&gt;Kat_KennzeichenTyp&lt;/documentation&gt;   &lt;/annotation&gt;   &lt;restriction base="xs:string"&gt;     &lt;enumeration value="0068001"&gt; </pre>		

	<pre> &lt;annotation&gt;   &lt;documentation&gt;UDI&lt;/documentation&gt; &lt;/annotation&gt; &lt;/enumeration&gt; &lt;enumeration value="0068002"&gt;   &lt;annotation&gt;     &lt;documentation&gt;Referenz (REF)&lt;/documentation&gt;   &lt;/annotation&gt; &lt;/enumeration&gt; &lt;enumeration value="0068003"&gt;   &lt;annotation&gt;     &lt;documentation&gt;Katalognummer&lt;/documentation&gt;   &lt;/annotation&gt; &lt;/enumeration&gt; &lt;enumeration value="0068042"&gt;   &lt;annotation&gt;     &lt;documentation&gt;sonstiger&lt;/documentation&gt;   &lt;/annotation&gt; &lt;/enumeration&gt; &lt;/restriction&gt; &lt;/simpleType&gt; </pre>
--	--

#### simpleType enum\_0069

namespace	http://xml.ir-d.de/irdsaa		
type	restriction of <b>string</b>		
properties	base xs:string		
facets	Kind	Value	Annotation
	enumeration	0069001	documentation Implantat
	enumeration	0069002	documentation Explantat
annotation	documentation Kat_ArtZubehoer		
source	<pre> &lt;simpleType name="enum_0069"&gt;   &lt;annotation&gt;     &lt;documentation&gt;Kat_ArtZubehoer&lt;/documentation&gt;   &lt;/annotation&gt;   &lt;restriction base="xs:string"&gt;     &lt;enumeration value="0069001"&gt;       &lt;annotation&gt;         &lt;documentation&gt;Implantat&lt;/documentation&gt;       &lt;/annotation&gt;     &lt;/enumeration&gt;     &lt;enumeration value="0069002"&gt;       &lt;annotation&gt;         &lt;documentation&gt;Explantat&lt;/documentation&gt;       &lt;/annotation&gt;     &lt;/enumeration&gt;   &lt;/restriction&gt; &lt;/simpleType&gt; </pre>		

#### simpleType enum\_0070

namespace	http://xml.ir-d.de/irdsaa
-----------	---------------------------

type	restriction of <b>string</b>															
properties	base xs:string															
facets	<table border="1"> <thead> <tr> <th>Kind</th> <th>Value</th> <th>Annotation</th> </tr> </thead> <tbody> <tr> <td>enumeration</td> <td>0070001</td> <td>documentation weiblich</td> </tr> <tr> <td>enumeration</td> <td>0070002</td> <td>documentation männlich</td> </tr> <tr> <td>enumeration</td> <td>0070003</td> <td>documentation divers</td> </tr> <tr> <td>enumeration</td> <td>0070042</td> <td>documentation unbestimmt</td> </tr> </tbody> </table>	Kind	Value	Annotation	enumeration	0070001	documentation weiblich	enumeration	0070002	documentation männlich	enumeration	0070003	documentation divers	enumeration	0070042	documentation unbestimmt
Kind	Value	Annotation														
enumeration	0070001	documentation weiblich														
enumeration	0070002	documentation männlich														
enumeration	0070003	documentation divers														
enumeration	0070042	documentation unbestimmt														
annotation	documentation Kat_Geschlecht															
source	<pre> &lt;simpleType name="enum_0070"&gt;   &lt;annotation&gt;     &lt;documentation&gt;Kat_Geschlecht&lt;/documentation&gt;   &lt;/annotation&gt;   &lt;restriction base="xs:string"&gt;     &lt;enumeration value="0070001"&gt;       &lt;annotation&gt;         &lt;documentation&gt;weiblich&lt;/documentation&gt;       &lt;/annotation&gt;     &lt;/enumeration&gt;     &lt;enumeration value="0070002"&gt;       &lt;annotation&gt;         &lt;documentation&gt;männlich&lt;/documentation&gt;       &lt;/annotation&gt;     &lt;/enumeration&gt;     &lt;enumeration value="0070003"&gt;       &lt;annotation&gt;         &lt;documentation&gt;divers&lt;/documentation&gt;       &lt;/annotation&gt;     &lt;/enumeration&gt;     &lt;enumeration value="0070042"&gt;       &lt;annotation&gt;         &lt;documentation&gt;unbestimmt&lt;/documentation&gt;       &lt;/annotation&gt;     &lt;/enumeration&gt;   &lt;/restriction&gt; &lt;/simpleType&gt; </pre>															

### simpleType enum 0071

namespace	http://xml.ir-d.de/irdsaa												
type	restriction of <b>string</b>												
properties	base xs:string												
facets	<table border="1"> <thead> <tr> <th>Kind</th> <th>Value</th> <th>Annotation</th> </tr> </thead> <tbody> <tr> <td>enumeration</td> <td>0071001</td> <td>documentation Implantat</td> </tr> <tr> <td>enumeration</td> <td>0071002</td> <td>documentation Explantat</td> </tr> <tr> <td>enumeration</td> <td>0071003</td> <td>documentation Degeneriertes/defektes Produkt, das funktionslos im Körper verbleibt</td> </tr> </tbody> </table>	Kind	Value	Annotation	enumeration	0071001	documentation Implantat	enumeration	0071002	documentation Explantat	enumeration	0071003	documentation Degeneriertes/defektes Produkt, das funktionslos im Körper verbleibt
Kind	Value	Annotation											
enumeration	0071001	documentation Implantat											
enumeration	0071002	documentation Explantat											
enumeration	0071003	documentation Degeneriertes/defektes Produkt, das funktionslos im Körper verbleibt											
annotation	documentation Kat_ArtikelArtFunktion												
source	<pre> &lt;simpleType name="enum_0071"&gt; </pre>												

	<pre> &lt;annotation&gt;   &lt;documentation&gt;Kat_ArtikelArtFunktion&lt;/documentation&gt; &lt;/annotation&gt; &lt;restriction base="xs:string"&gt;   &lt;enumeration value="0071001"&gt;     &lt;annotation&gt;       &lt;documentation&gt;Implantat&lt;/documentation&gt;     &lt;/annotation&gt;   &lt;/enumeration&gt;   &lt;enumeration value="0071002"&gt;     &lt;annotation&gt;       &lt;documentation&gt;Explantat&lt;/documentation&gt;     &lt;/annotation&gt;   &lt;/enumeration&gt;   &lt;enumeration value="0071003"&gt;     &lt;annotation&gt;       &lt;documentation&gt;Degeneriertes/defektes Produkt, das funktionslos im Körper verbleibt&lt;/documentation&gt;     &lt;/annotation&gt;   &lt;/enumeration&gt; &lt;/restriction&gt; &lt;/simpleType&gt; </pre>
--	---

#### simpleType enum\_0075

namespace	http://xml.ir-d.de/irdsaa		
type	restriction of <b>string</b>		
properties	base xs:string		
facets	Kind	Value	Annotation
	enumeration	0075001	documentation elektiv
	enumeration	0075002	documentation dringlich
	enumeration	0075003	documentation Notfall
annotation	documentation Kat_Dringlichkeit		
source	<pre> &lt;simpleType name="enum_0075"&gt;   &lt;annotation&gt;     &lt;documentation&gt;Kat_Dringlichkeit&lt;/documentation&gt;   &lt;/annotation&gt;   &lt;restriction base="xs:string"&gt;     &lt;enumeration value="0075001"&gt;       &lt;annotation&gt;         &lt;documentation&gt;elektiv&lt;/documentation&gt;       &lt;/annotation&gt;     &lt;/enumeration&gt;     &lt;enumeration value="0075002"&gt;       &lt;annotation&gt;         &lt;documentation&gt;dringlich&lt;/documentation&gt;       &lt;/annotation&gt;     &lt;/enumeration&gt;     &lt;enumeration value="0075003"&gt;       &lt;annotation&gt;         &lt;documentation&gt;Notfall&lt;/documentation&gt;       &lt;/annotation&gt;     &lt;/enumeration&gt;   &lt;/restriction&gt; &lt;/simpleType&gt; </pre>		

	<pre> &lt;/restriction&gt; &lt;/simpleType&gt; </pre>
--	---

### simpleType enum\_0076

namespace	http://xml.ir-d.de/irdsaa		
type	restriction of <b>string</b>		
properties	base xs:string		
facets	Kind	Value	Annotation
	enumeration	0076001	documentation elektiv
	enumeration	0076002	documentation dringlich
	enumeration	0076003	documentation Notfall
	enumeration	0076004	documentation Notfall (Reanimation / ultima ratio)
annotation	documentation Kat_Dringlichkeit_Reanimation		
source	<pre> &lt;simpleType name="enum_0076"&gt;   &lt;annotation&gt;     &lt;documentation&gt;Kat_Dringlichkeit_Reanimation&lt;/documentation&gt;   &lt;/annotation&gt;   &lt;restriction base="xs:string"&gt;     &lt;enumeration value="0076001"&gt;       &lt;annotation&gt;         &lt;documentation&gt;elektiv&lt;/documentation&gt;       &lt;/annotation&gt;     &lt;/enumeration&gt;     &lt;enumeration value="0076002"&gt;       &lt;annotation&gt;         &lt;documentation&gt;dringlich&lt;/documentation&gt;       &lt;/annotation&gt;     &lt;/enumeration&gt;     &lt;enumeration value="0076003"&gt;       &lt;annotation&gt;         &lt;documentation&gt;Notfall&lt;/documentation&gt;       &lt;/annotation&gt;     &lt;/enumeration&gt;     &lt;enumeration value="0076004"&gt;       &lt;annotation&gt;         &lt;documentation&gt;Notfall (Reanimation / ultima ratio)&lt;/documentation&gt;       &lt;/annotation&gt;     &lt;/enumeration&gt;   &lt;/restriction&gt; &lt;/simpleType&gt; </pre>		

### simpleType enum\_0080

namespace	http://xml.ir-d.de/irdsaa		
type	restriction of <b>string</b>		
properties	base xs:string		
facets	Kind	Value	Annotation
	enumeration	0080001	documentation

	enumeration 0080002 Endoprothese Hüfte/Knie documentation Brustimplantat
	enumeration 0080003 documentation Aortenklappenprothese
annotation	documentation Kat_Implantattyp
source	<pre> &lt;simpleType name="enum_0080"&gt;   &lt;annotation&gt;     &lt;documentation&gt;Kat_Implantattyp&lt;/documentation&gt;   &lt;/annotation&gt;   &lt;restriction base="xs:string"&gt;     &lt;enumeration value="0080001"&gt;       &lt;annotation&gt;         &lt;documentation&gt;Endoprothese Hüfte/Knie&lt;/documentation&gt;       &lt;/annotation&gt;     &lt;/enumeration&gt;     &lt;enumeration value="0080002"&gt;       &lt;annotation&gt;         &lt;documentation&gt;Brustimplantat&lt;/documentation&gt;       &lt;/annotation&gt;     &lt;/enumeration&gt;     &lt;enumeration value="0080003"&gt;       &lt;annotation&gt;         &lt;documentation&gt;Aortenklappenprothese&lt;/documentation&gt;       &lt;/annotation&gt;     &lt;/enumeration&gt;   &lt;/restriction&gt; &lt;/simpleType&gt; </pre>

### simpleType enum\_0100

namespace	http://xml.ir-d.de/irdsaa		
type	restriction of <b>string</b>		
properties	base xs:string		
facets	Kind	Value	Annotation
	enumeration	0100001	documentation Primäreingriff
	enumeration	0100002	documentation Austausch Expander gegen dauerhaftes Brustimplantat
	enumeration	0100003	documentation Revision
	enumeration	0100004	documentation Nur Explantation
annotation	documentation Kat_BI_ArtEingriff		
source	<pre> &lt;simpleType name="enum_0100"&gt;   &lt;annotation&gt;     &lt;documentation&gt;Kat_BI_ArtEingriff&lt;/documentation&gt;   &lt;/annotation&gt;   &lt;restriction base="xs:string"&gt;     &lt;enumeration value="0100001"&gt;       &lt;annotation&gt;         &lt;documentation&gt;Primäreingriff&lt;/documentation&gt;       &lt;/annotation&gt;     &lt;/enumeration&gt;     &lt;enumeration value="0100002"&gt; </pre>		



	<pre> &lt;annotation&gt;   &lt;documentation&gt;Austausch Expander gegen dauerhaftes Brustimplantat&lt;/documentation&gt; &lt;/annotation&gt; &lt;/enumeration&gt; &lt;enumeration value="0100003"&gt;   &lt;annotation&gt;     &lt;documentation&gt;Revision&lt;/documentation&gt;   &lt;/annotation&gt; &lt;/enumeration&gt; &lt;enumeration value="0100004"&gt;   &lt;annotation&gt;     &lt;documentation&gt;Nur Explantation&lt;/documentation&gt;   &lt;/annotation&gt; &lt;/enumeration&gt; &lt;/restriction&gt; &lt;/simpleType&gt; </pre>
--	--

### simpleType enum\_0102

namespace	http://xml.ir-d.de/irdsaa		
type	restriction of <b>string</b>		
properties	base xs:string		
facets	Kind	Value	Annotation
	enumeration	0102001	documentation kosmetische Augmentation
	enumeration	0102002	documentation Rekonstruktion, benigne
	enumeration	0102003	documentation Rekonstruktion nach Mastektomie aufgrund eines Karzinoms
	enumeration	0102004	documentation Rekonstruktion nach risikoreduzierender Mastektomie
annotation	documentation Kat_BI_GrundPrimaereingriff		
source	<pre> &lt;simpleType name="enum_0102"&gt;   &lt;annotation&gt;     &lt;documentation&gt;Kat_BI_GrundPrimaereingriff&lt;/documentation&gt;   &lt;/annotation&gt;   &lt;restriction base="xs:string"&gt;     &lt;enumeration value="0102001"&gt;       &lt;annotation&gt;         &lt;documentation&gt;kosmetische Augmentation&lt;/documentation&gt;       &lt;/annotation&gt;     &lt;/enumeration&gt;     &lt;enumeration value="0102002"&gt;       &lt;annotation&gt;         &lt;documentation&gt;Rekonstruktion, benigne&lt;/documentation&gt;       &lt;/annotation&gt;     &lt;/enumeration&gt;     &lt;enumeration value="0102003"&gt;       &lt;annotation&gt;         &lt;documentation&gt;Rekonstruktion nach Mastektomie aufgrund eines Karzinoms&lt;/documentation&gt;       &lt;/annotation&gt;     &lt;/enumeration&gt;     &lt;enumeration value="0102004"&gt;       &lt;annotation&gt; </pre>		

	<pre> &lt;documentation&gt;Rekonstruktion nach risikoreduzierender Mastektomie&lt;/documentation&gt; &lt;/annotation&gt; &lt;/enumeration&gt; &lt;/restriction&gt; &lt;/simpleType&gt; </pre>
--	---

simpleType **enum\_0103**

namespace	http://xml.ir-d.de/irdsaa		
type	restriction of <b>string</b>		
properties	base xs:string		
facets	Kind	Value	Annotation
	enumeration	0103001	documentation simultane Lappendeckung
	enumeration	0103002	documentation simultane Eigenfetttransplantation
	enumeration	0103003	documentation simultane Mastopexie
	enumeration	0103005	documentation simultane Mastektomie, Ablatio / hautsparend
	enumeration	0103006	documentation simultane Mastektomie, nippelerhaltend
	enumeration	0103007	documentation Axilla-Dissektion
	enumeration	0103008	documentation Drainage
annotation	documentation Kat_BI_OperationsdetailPrimaereingriff		
source	<pre> &lt;simpleType name="enum_0103"&gt;   &lt;annotation&gt;     &lt;documentation&gt;Kat_BI_OperationsdetailPrimaereingriff&lt;/documentation&gt;   &lt;/annotation&gt;   &lt;restriction base="xs:string"&gt;     &lt;enumeration value="0103001"&gt;       &lt;annotation&gt;         &lt;documentation&gt;simultane Lappendeckung&lt;/documentation&gt;       &lt;/annotation&gt;     &lt;/enumeration&gt;     &lt;enumeration value="0103002"&gt;       &lt;annotation&gt;         &lt;documentation&gt;simultane Eigenfetttransplantation&lt;/documentation&gt;       &lt;/annotation&gt;     &lt;/enumeration&gt;     &lt;enumeration value="0103003"&gt;       &lt;annotation&gt;         &lt;documentation&gt;simultane Mastopexie&lt;/documentation&gt;       &lt;/annotation&gt;     &lt;/enumeration&gt;     &lt;enumeration value="0103005"&gt;       &lt;annotation&gt;         &lt;documentation&gt;simultane Mastektomie, Ablatio / hautsparend&lt;/documentation&gt;       &lt;/annotation&gt;     &lt;/enumeration&gt;     &lt;enumeration value="0103006"&gt;       &lt;annotation&gt; </pre>		

	<pre> &lt;documentation&gt;simultane Mastektomie, nippelerhaltend&lt;/documentation&gt; &lt;/annotation&gt; &lt;/enumeration&gt; &lt;enumeration value="0103007"&gt;   &lt;annotation&gt;     &lt;documentation&gt;Axilla-Dissektion&lt;/documentation&gt;   &lt;/annotation&gt; &lt;/enumeration&gt; &lt;enumeration value="0103008"&gt;   &lt;annotation&gt;     &lt;documentation&gt;Drainage&lt;/documentation&gt;   &lt;/annotation&gt; &lt;/enumeration&gt; &lt;/restriction&gt; &lt;/simpleType&gt; </pre>
--	---

### simpleType enum 0104

namespace	http://xml.ir-d.de/irdsaa						
type	restriction of <b>string</b>						
properties	base xs:string						
facets	<table border="1"> <thead> <tr> <th>Kind</th> <th>Value</th> <th>Annotation</th> </tr> </thead> <tbody> <tr> <td>enumeration</td> <td>0104001</td> <td>documentation Austausch Expander gegen dauerhaftes Brustimplantat</td> </tr> </tbody> </table>	Kind	Value	Annotation	enumeration	0104001	documentation Austausch Expander gegen dauerhaftes Brustimplantat
Kind	Value	Annotation					
enumeration	0104001	documentation Austausch Expander gegen dauerhaftes Brustimplantat					
annotation	documentation Kat_BI_GrundAustausch						
source	<pre> &lt;simpleType name="enum_0104"&gt;   &lt;annotation&gt;     &lt;documentation&gt;Kat_BI_GrundAustausch&lt;/documentation&gt;   &lt;/annotation&gt;   &lt;restriction base="xs:string"&gt;     &lt;enumeration value="0104001"&gt;       &lt;annotation&gt;         &lt;documentation&gt;Austausch Expander gegen dauerhaftes         Brustimplantat&lt;/documentation&gt;       &lt;/annotation&gt;     &lt;/enumeration&gt;   &lt;/restriction&gt; &lt;/simpleType&gt; </pre>						

### simpleType enum 0105

namespace	http://xml.ir-d.de/irdsaa																		
type	restriction of <b>string</b>																		
properties	base xs:string																		
facets	<table border="1"> <thead> <tr> <th>Kind</th> <th>Value</th> <th>Annotation</th> </tr> </thead> <tbody> <tr> <td>enumeration</td> <td>0105001</td> <td>documentation simultane Lappendeckung</td> </tr> <tr> <td>enumeration</td> <td>0105002</td> <td>documentation simultane Eigenfetttransplantation</td> </tr> <tr> <td>enumeration</td> <td>0105003</td> <td>documentation simultane Mastopexie</td> </tr> <tr> <td>enumeration</td> <td>0105008</td> <td>documentation Drainage</td> </tr> <tr> <td>enumeration</td> <td>0105009</td> <td>documentation</td> </tr> </tbody> </table>	Kind	Value	Annotation	enumeration	0105001	documentation simultane Lappendeckung	enumeration	0105002	documentation simultane Eigenfetttransplantation	enumeration	0105003	documentation simultane Mastopexie	enumeration	0105008	documentation Drainage	enumeration	0105009	documentation
Kind	Value	Annotation																	
enumeration	0105001	documentation simultane Lappendeckung																	
enumeration	0105002	documentation simultane Eigenfetttransplantation																	
enumeration	0105003	documentation simultane Mastopexie																	
enumeration	0105008	documentation Drainage																	
enumeration	0105009	documentation																	

	enumeration 0105010 Kapsulektomie, komplett documentation enumeration 0105011 Kapsulektomie, partiell documentation Neopocket
annotation	documentation Kat_BI_OperationsdetailAustausch
source	<pre> &lt;simpleType name="enum_0105"&gt;   &lt;annotation&gt;     &lt;documentation&gt;Kat_BI_OperationsdetailAustausch&lt;/documentation&gt;   &lt;/annotation&gt;   &lt;restriction base="xs:string"&gt;     &lt;enumeration value="0105001"&gt;       &lt;annotation&gt;         &lt;documentation&gt;simultane Lappendeckung&lt;/documentation&gt;       &lt;/annotation&gt;     &lt;/enumeration&gt;     &lt;enumeration value="0105002"&gt;       &lt;annotation&gt;         &lt;documentation&gt;simultane Eigenfetttransplantation&lt;/documentation&gt;       &lt;/annotation&gt;     &lt;/enumeration&gt;     &lt;enumeration value="0105003"&gt;       &lt;annotation&gt;         &lt;documentation&gt;simultane Mastopexie&lt;/documentation&gt;       &lt;/annotation&gt;     &lt;/enumeration&gt;     &lt;enumeration value="0105008"&gt;       &lt;annotation&gt;         &lt;documentation&gt;Drainage&lt;/documentation&gt;       &lt;/annotation&gt;     &lt;/enumeration&gt;     &lt;enumeration value="0105009"&gt;       &lt;annotation&gt;         &lt;documentation&gt;Kapsulektomie, komplett&lt;/documentation&gt;       &lt;/annotation&gt;     &lt;/enumeration&gt;     &lt;enumeration value="0105010"&gt;       &lt;annotation&gt;         &lt;documentation&gt;Kapsulektomie, partiell&lt;/documentation&gt;       &lt;/annotation&gt;     &lt;/enumeration&gt;     &lt;enumeration value="0105011"&gt;       &lt;annotation&gt;         &lt;documentation&gt;Neopocket&lt;/documentation&gt;       &lt;/annotation&gt;     &lt;/enumeration&gt;   &lt;/restriction&gt; &lt;/simpleType&gt; </pre>

### simpleType enum\_0106

namespace	http://xml.ir-d.de/irdsaa		
type	restriction of <b>string</b>		
properties	base	xs:string	
facets	Kind	Value	Annotation
	enumeration	0106001	documentation

	enumeration 0106002 Patientenwunsch documentation asymptomatisch enumeration 0106003 documentation Komplikation
annotation	documentation Kat_BI_GrundRevisionExplantation
source	<pre> &lt;simpleType name="enum_0106"&gt;   &lt;annotation&gt;     &lt;documentation&gt;Kat_BI_GrundRevisionExplantation&lt;/documentation&gt;   &lt;/annotation&gt;   &lt;restriction base="xs:string"&gt;     &lt;enumeration value="0106001"&gt;       &lt;annotation&gt;         &lt;documentation&gt;Patientenwunsch&lt;/documentation&gt;       &lt;/annotation&gt;     &lt;/enumeration&gt;     &lt;enumeration value="0106002"&gt;       &lt;annotation&gt;         &lt;documentation&gt;asymptomatisch&lt;/documentation&gt;       &lt;/annotation&gt;     &lt;/enumeration&gt;     &lt;enumeration value="0106003"&gt;       &lt;annotation&gt;         &lt;documentation&gt;Komplikation&lt;/documentation&gt;       &lt;/annotation&gt;     &lt;/enumeration&gt;   &lt;/restriction&gt; &lt;/simpleType&gt; </pre>

### simpleType enum\_0107

namespace	http://xml.ir-d.de/irdsaa		
type	restriction of <b>string</b>		
properties	base xs:string		
facets	Kind	Value	Annotation
	enumeration	0107001	documentation simultane Lappendeckung
	enumeration	0107002	documentation simultane Eigenfetttransplantation
	enumeration	0107003	documentation simultane Mastopexie
	enumeration	0107005	documentation simultane Mastektomie, Ablatio / hautsparend
	enumeration	0107006	documentation simultane Mastektomie, nippelerhaltend
	enumeration	0107007	documentation Axilla-Dissektion
	enumeration	0107008	documentation Drainage
	enumeration	0107009	documentation Kapsulektomie, komplett
	enumeration	0107010	documentation Kapsulektomie, partiell
	enumeration	0107011	documentation Neopocket
annotation	documentation Kat_BI_OperationsdetailRevision		

source

```
<simpleType name="enum_0107">
  <annotation>
    <documentation>Kat_BI_OperationsdetailRevision</documentation>
  </annotation>
  <restriction base="xs:string">
    <enumeration value="0107001">
      <annotation>
        <documentation>simultane Lappendeckung</documentation>
      </annotation>
    </enumeration>
    <enumeration value="0107002">
      <annotation>
        <documentation>simultane Eigenfetttransplantation</documentation>
      </annotation>
    </enumeration>
    <enumeration value="0107003">
      <annotation>
        <documentation>simultane Mastopexie</documentation>
      </annotation>
    </enumeration>
    <enumeration value="0107005">
      <annotation>
        <documentation>simultane Mastektomie, Ablatio /
hautsparend</documentation>
      </annotation>
    </enumeration>
    <enumeration value="0107006">
      <annotation>
        <documentation>simultane Mastektomie, nippelerhaltend</documentation>
      </annotation>
    </enumeration>
    <enumeration value="0107007">
      <annotation>
        <documentation>Axilla-Dissektion</documentation>
      </annotation>
    </enumeration>
    <enumeration value="0107008">
      <annotation>
        <documentation>Drainage</documentation>
      </annotation>
    </enumeration>
    <enumeration value="0107009">
      <annotation>
        <documentation>Kapsulektomie, komplett</documentation>
      </annotation>
    </enumeration>
    <enumeration value="0107010">
      <annotation>
        <documentation>Kapsulektomie, partiell</documentation>
      </annotation>
    </enumeration>
    <enumeration value="0107011">
      <annotation>
        <documentation>Neopocket</documentation>
      </annotation>
    </enumeration>
  </restriction>
</simpleType>
```

### simpleType enum 0110

namespace	http://xml.ir-d.de/irdsaa		
type	restriction of <b>string</b>		
properties	base xs:string		
facets	Kind	Value	Annotation
	enumeration	0110001	documentation Bestrahlung
annotation	documentation Kat_BI_VorbehandlungLokal		
source	<pre> &lt;simpleType name="enum_0110"&gt;   &lt;annotation&gt;     &lt;documentation&gt;Kat_BI_VorbehandlungLokal&lt;/documentation&gt;   &lt;/annotation&gt;   &lt;restriction base="xs:string"&gt;     &lt;enumeration value="0110001"&gt;       &lt;annotation&gt;         &lt;documentation&gt;Bestrahlung&lt;/documentation&gt;       &lt;/annotation&gt;     &lt;/enumeration&gt;   &lt;/restriction&gt; &lt;/simpleType&gt; </pre>		

### simpleType enum 0111

namespace	http://xml.ir-d.de/irdsaa		
type	restriction of <b>string</b>		
properties	base xs:string		
facets	Kind	Value	Annotation
	enumeration	0111001	documentation nein
	enumeration	0111002	documentation Lipofilling
	enumeration	0111003	documentation Eigengewebsrekonstruktion
annotation	documentation Kat_BI_Verfahrenswechsel		
source	<pre> &lt;simpleType name="enum_0111"&gt;   &lt;annotation&gt;     &lt;documentation&gt;Kat_BI_Verfahrenswechsel&lt;/documentation&gt;   &lt;/annotation&gt;   &lt;restriction base="xs:string"&gt;     &lt;enumeration value="0111001"&gt;       &lt;annotation&gt;         &lt;documentation&gt;nein&lt;/documentation&gt;       &lt;/annotation&gt;     &lt;/enumeration&gt;     &lt;enumeration value="0111002"&gt;       &lt;annotation&gt;         &lt;documentation&gt;Lipofilling&lt;/documentation&gt;       &lt;/annotation&gt;     &lt;/enumeration&gt;     &lt;enumeration value="0111003"&gt; </pre>		

	<pre> &lt;annotation&gt;   &lt;documentation&gt;Eigengewebstruktion&lt;/documentation&gt; &lt;/annotation&gt; &lt;/enumeration&gt; &lt;/restriction&gt; &lt;/simpleType&gt; </pre>
--	--

### simpleType enum\_0112

namespace	http://xml.ir-d.de/irdsaa		
type	restriction of <b>string</b>		
properties	base xs:string		
facets	Kind	Value	Annotation
	enumeration	0112001	documentation subglandulär / epipektoral
	enumeration	0112002	documentation subpektoral
	enumeration	0112003	documentation subfaszial
	enumeration	0112004	documentation sub-flap
	enumeration	0112005	documentation subkutan
	enumeration	0112006	documentation dual plane
	enumeration	0112042	documentation andere
annotation	documentation Kat_BI_LageImplantat		
source	<pre> &lt;simpleType name="enum_0112"&gt;   &lt;annotation&gt;     &lt;documentation&gt;Kat_BI_LageImplantat&lt;/documentation&gt;   &lt;/annotation&gt;   &lt;restriction base="xs:string"&gt;     &lt;enumeration value="0112001"&gt;       &lt;annotation&gt;         &lt;documentation&gt;subglandulär / epipektoral&lt;/documentation&gt;       &lt;/annotation&gt;     &lt;/enumeration&gt;     &lt;enumeration value="0112002"&gt;       &lt;annotation&gt;         &lt;documentation&gt;subpektoral&lt;/documentation&gt;       &lt;/annotation&gt;     &lt;/enumeration&gt;     &lt;enumeration value="0112003"&gt;       &lt;annotation&gt;         &lt;documentation&gt;subfaszial&lt;/documentation&gt;       &lt;/annotation&gt;     &lt;/enumeration&gt;     &lt;enumeration value="0112004"&gt;       &lt;annotation&gt;         &lt;documentation&gt;sub-flap&lt;/documentation&gt;       &lt;/annotation&gt;     &lt;/enumeration&gt;     &lt;enumeration value="0112005"&gt;       &lt;annotation&gt;         &lt;documentation&gt;subkutan&lt;/documentation&gt; </pre>		



	<pre> &lt;/annotation&gt; &lt;/enumeration&gt; &lt;enumeration value="0112006"&gt;   &lt;annotation&gt;     &lt;documentation&gt;dual plane&lt;/documentation&gt;   &lt;/annotation&gt; &lt;/enumeration&gt; &lt;enumeration value="0112042"&gt;   &lt;annotation&gt;     &lt;documentation&gt;andere&lt;/documentation&gt;   &lt;/annotation&gt; &lt;/enumeration&gt; &lt;/restriction&gt; &lt;/simpleType&gt; </pre>
--	--

### simpleType enum\_0113

namespace	http://xml.lir-d.de/irdsaa						
type	restriction of <b>string</b>						
properties	base xs:string						
facets	<table border="1"> <thead> <tr> <th>Kind</th> <th>Value</th> <th>Annotation</th> </tr> </thead> <tbody> <tr> <td>enumeration</td> <td>0113001</td> <td>documentation Chemotherapie innerhalb der letzten drei Monate</td> </tr> </tbody> </table>	Kind	Value	Annotation	enumeration	0113001	documentation Chemotherapie innerhalb der letzten drei Monate
Kind	Value	Annotation					
enumeration	0113001	documentation Chemotherapie innerhalb der letzten drei Monate					
annotation	documentation Kat_BI_VorbehandlungSystemisch						
source	<pre> &lt;simpleType name="enum_0113"&gt;   &lt;annotation&gt;     &lt;documentation&gt;Kat_BI_VorbehandlungSystemisch&lt;/documentation&gt;   &lt;/annotation&gt;   &lt;restriction base="xs:string"&gt;     &lt;enumeration value="0113001"&gt;       &lt;annotation&gt;         &lt;documentation&gt;Chemotherapie innerhalb der letzten drei Monate&lt;/documentation&gt;       &lt;/annotation&gt;     &lt;/enumeration&gt;   &lt;/restriction&gt; &lt;/simpleType&gt; </pre>						

### simpleType enum\_0114

namespace	http://xml.lir-d.de/irdsaa															
type	restriction of <b>string</b>															
properties	base xs:string															
facets	<table border="1"> <thead> <tr> <th>Kind</th> <th>Value</th> <th>Annotation</th> </tr> </thead> <tbody> <tr> <td>enumeration</td> <td>0114001</td> <td>documentation vollständig</td> </tr> <tr> <td>enumeration</td> <td>0114002</td> <td>documentation nein</td> </tr> <tr> <td>enumeration</td> <td>0114003</td> <td>documentation teilweise</td> </tr> <tr> <td>enumeration</td> <td>0114004</td> <td>documentation nicht vorhanden</td> </tr> </tbody> </table>	Kind	Value	Annotation	enumeration	0114001	documentation vollständig	enumeration	0114002	documentation nein	enumeration	0114003	documentation teilweise	enumeration	0114004	documentation nicht vorhanden
Kind	Value	Annotation														
enumeration	0114001	documentation vollständig														
enumeration	0114002	documentation nein														
enumeration	0114003	documentation teilweise														
enumeration	0114004	documentation nicht vorhanden														
annotation	documentation Kat_BI_EntfernungADMNetz															

source	<pre> &lt;simpleType name="enum_0114"&gt;   &lt;annotation&gt;     &lt;documentation&gt;Kat_BI_EntfernungADMNetz&lt;/documentation&gt;   &lt;/annotation&gt;   &lt;restriction base="xs:string"&gt;     &lt;enumeration value="0114001"&gt;       &lt;annotation&gt;         &lt;documentation&gt;vollständig&lt;/documentation&gt;       &lt;/annotation&gt;     &lt;/enumeration&gt;     &lt;enumeration value="0114002"&gt;       &lt;annotation&gt;         &lt;documentation&gt;nein&lt;/documentation&gt;       &lt;/annotation&gt;     &lt;/enumeration&gt;     &lt;enumeration value="0114003"&gt;       &lt;annotation&gt;         &lt;documentation&gt;teilweise&lt;/documentation&gt;       &lt;/annotation&gt;     &lt;/enumeration&gt;     &lt;enumeration value="0114004"&gt;       &lt;annotation&gt;         &lt;documentation&gt;nicht vorhanden&lt;/documentation&gt;       &lt;/annotation&gt;     &lt;/enumeration&gt;   &lt;/restriction&gt; &lt;/simpleType&gt; </pre>
--------	--

### simpleType enum\_0116

namespace	http://xml.ir-d.de/irdsaa		
type	restriction of <b>string</b>		
properties	base xs:string		
facets	Kind	Value	Annotation
	enumeration	0116001	documentation Spülung, antibiotisch
	enumeration	0116002	documentation Spülung, antiseptisch
	enumeration	0116003	documentation Spülung, wirkstofffrei
	enumeration	0116004	documentation Spülung, andere
	enumeration	0116005	documentation prä-/perioperative Antibiotika
	enumeration	0116006	documentation postoperative Antibiotika
	enumeration	0116007	documentation Handschuhwechsel vor Implantation
	enumeration	0116008	documentation Implantationshilfe
annotation	documentation Kat_BI_Operationsmassnahme		
source	<pre> &lt;simpleType name="enum_0116"&gt;   &lt;annotation&gt;     &lt;documentation&gt;Kat_BI_Operationsmassnahme&lt;/documentation&gt;   &lt;/annotation&gt;   &lt;restriction base="xs:string"&gt; </pre>		

```

<enumeration value="0116001">
  <annotation>
    <documentation>Spülung, antibiotisch</documentation>
  </annotation>
</enumeration>
<enumeration value="0116002">
  <annotation>
    <documentation>Spülung, antiseptisch</documentation>
  </annotation>
</enumeration>
<enumeration value="0116003">
  <annotation>
    <documentation>Spülung, wirkstofffrei</documentation>
  </annotation>
</enumeration>
<enumeration value="0116004">
  <annotation>
    <documentation>Spülung, andere</documentation>
  </annotation>
</enumeration>
<enumeration value="0116005">
  <annotation>
    <documentation>prä-/perioperative Antibiotika</documentation>
  </annotation>
</enumeration>
<enumeration value="0116006">
  <annotation>
    <documentation>postoperative Antibiotika</documentation>
  </annotation>
</enumeration>
<enumeration value="0116007">
  <annotation>
    <documentation>Handschuhwechsel vor Implantation</documentation>
  </annotation>
</enumeration>
<enumeration value="0116008">
  <annotation>
    <documentation>Implantationshilfe</documentation>
  </annotation>
</enumeration>
</restriction>
</simpleType>

```

### simpleType enum\_0118

namespace	http://xml.ir-d.de/irdsaa		
type	restriction of <b>string</b>		
properties	base xs:string		
facets	Kind	Value	Annotation
	enumeration	0118001	documentation axillär
	enumeration	0118002	documentation periareolär
	enumeration	0118003	documentation inframammär
	enumeration	0118004	documentation Mastektomienarbe

	enumeration 0118042 documentation anderer
annotation	documentation Kat_BI_Operationszugang
source	<pre> &lt;simpleType name="enum_0118"&gt;   &lt;annotation&gt;     &lt;documentation&gt;Kat_BI_Operationszugang&lt;/documentation&gt;   &lt;/annotation&gt;   &lt;restriction base="xs:string"&gt;     &lt;enumeration value="0118001"&gt;       &lt;annotation&gt;         &lt;documentation&gt;axillär&lt;/documentation&gt;       &lt;/annotation&gt;     &lt;/enumeration&gt;     &lt;enumeration value="0118002"&gt;       &lt;annotation&gt;         &lt;documentation&gt;periareolär&lt;/documentation&gt;       &lt;/annotation&gt;     &lt;/enumeration&gt;     &lt;enumeration value="0118003"&gt;       &lt;annotation&gt;         &lt;documentation&gt;inframammär&lt;/documentation&gt;       &lt;/annotation&gt;     &lt;/enumeration&gt;     &lt;enumeration value="0118004"&gt;       &lt;annotation&gt;         &lt;documentation&gt;Mastektomienarbe&lt;/documentation&gt;       &lt;/annotation&gt;     &lt;/enumeration&gt;     &lt;enumeration value="0118042"&gt;       &lt;annotation&gt;         &lt;documentation&gt;anderer&lt;/documentation&gt;       &lt;/annotation&gt;     &lt;/enumeration&gt;   &lt;/restriction&gt; &lt;/simpleType&gt; </pre>

### simpleType enum\_0120

namespace	http://xml.ir-d.de/irdsaa		
type	restriction of <b>string</b>		
properties	base xs:string		
facets	Kind enumeration	Value 0120001	Annotation documentation Expander defekt
annotation	documentation Kat_BI_BefundAustausch		
source	<pre> &lt;simpleType name="enum_0120"&gt;   &lt;annotation&gt;     &lt;documentation&gt;Kat_BI_BefundAustausch&lt;/documentation&gt;   &lt;/annotation&gt;   &lt;restriction base="xs:string"&gt;     &lt;enumeration value="0120001"&gt;       &lt;annotation&gt;         &lt;documentation&gt;Expander defekt&lt;/documentation&gt;       &lt;/annotation&gt;     &lt;/enumeration&gt;   &lt;/restriction&gt; &lt;/simpleType&gt; </pre>		

```

</enumeration>
</restriction>
</simpleType>

```

### simpleType enum\_0121

namespace	http://xml.ir-d.de/irdsaa		
type	restriction of <b>string</b>		
properties	base xs:string		
facets	Kind	Value	Annotation
	enumeration	0121001	documentation Infektion
	enumeration	0121002	documentation Serom
	enumeration	0121003	documentation Hämatom
	enumeration	0121004	documentation Kapselbibrose
	enumeration	0121005	documentation Implantatruptur
	enumeration	0121006	documentation Fehlpositionierung/Rotation
	enumeration	0121007	documentation BIA-ALCL/-SCC, Verdacht
	enumeration	0121008	documentation BIA-ALCL/-SCC, pathologisch bestätigt
	enumeration	0121009	documentation Brustschmerzen
	enumeration	0121010	documentation Doppelkapsel
	enumeration	0121011	documentation Netz-/ADM-bedingte Komplikation, Non-Integration
	enumeration	0121012	documentation Netz-/ADM-bedingte Komplikation, andere
	enumeration	0121013	documentation Hautnekrose/exponiertes Implantat
	enumeration	0121014	documentation BII/ASIA (Brustimplantat assoziierte Symptome), Verdacht
	enumeration	0121015	documentation Lymphadenopathie
	enumeration	0121016	documentation Brustkrebs, neu aufgetreten/Rezidiv
annotation	documentation Kat_BI_BefundKomplett		
source	<pre> &lt;simpleType name="enum_0121"&gt;   &lt;annotation&gt;     &lt;documentation&gt;Kat_BI_BefundKomplett&lt;/documentation&gt;   &lt;/annotation&gt;   &lt;restriction base="xs:string"&gt;     &lt;enumeration value="0121001"&gt;       &lt;annotation&gt;         &lt;documentation&gt;Infektion&lt;/documentation&gt;       &lt;/annotation&gt;     &lt;/enumeration&gt;     &lt;enumeration value="0121002"&gt;       &lt;annotation&gt;         &lt;documentation&gt;Serom&lt;/documentation&gt;       &lt;/annotation&gt;     &lt;/enumeration&gt;   &lt;/restriction&gt; </pre>		

```
<enumeration value="0121003">
  <annotation>
    <documentation>Hämatom</documentation>
  </annotation>
</enumeration>
<enumeration value="0121004">
  <annotation>
    <documentation>Kapselfibrose</documentation>
  </annotation>
</enumeration>
<enumeration value="0121005">
  <annotation>
    <documentation>Implantatruptur</documentation>
  </annotation>
</enumeration>
<enumeration value="0121006">
  <annotation>
    <documentation>Fehlpositionierung/Rotation</documentation>
  </annotation>
</enumeration>
<enumeration value="0121007">
  <annotation>
    <documentation>BIA-ALCL/-SCC, Verdacht</documentation>
  </annotation>
</enumeration>
<enumeration value="0121008">
  <annotation>
    <documentation>BIA-ALCL/-SCC, pathologisch bestätigt</documentation>
  </annotation>
</enumeration>
<enumeration value="0121009">
  <annotation>
    <documentation>Brustschmerzen</documentation>
  </annotation>
</enumeration>
<enumeration value="0121010">
  <annotation>
    <documentation>Doppelkapsel</documentation>
  </annotation>
</enumeration>
<enumeration value="0121011">
  <annotation>
    <documentation>Netz-/ADM-bedingte Komplikation,
Non-Integration</documentation>
  </annotation>
</enumeration>
<enumeration value="0121012">
  <annotation>
    <documentation>Netz-/ADM-bedingte Komplikation, andere</documentation>
  </annotation>
</enumeration>
<enumeration value="0121013">
  <annotation>
    <documentation>Hautnekrose/exponiertes Implantat</documentation>
  </annotation>
</enumeration>
<enumeration value="0121014">
  <annotation>
    <documentation>BII/ASIA (Brustimplantat assoziierte Symptome),
```

	<pre> Verdacht&lt;/documentation&gt;   &lt;/annotation&gt; &lt;/enumeration&gt; &lt;enumeration value="0121015"&gt;   &lt;annotation&gt;     &lt;documentation&gt;Lymphadenopathie&lt;/documentation&gt;   &lt;/annotation&gt; &lt;/enumeration&gt; &lt;enumeration value="0121016"&gt;   &lt;annotation&gt;     &lt;documentation&gt;Brustkrebs, neu aufgetreten/Rezidiv&lt;/documentation&gt;   &lt;/annotation&gt; &lt;/enumeration&gt; &lt;/restriction&gt; &lt;/simpleType&gt; </pre>
--	--

### simpleType enum\_0122

namespace	http://xml.ir-d.de/irdsaa		
type	restriction of <b>string</b>		
properties	base xs:string		
facets	Kind	Value	Annotation
	enumeration	0122001	documentation ja, ärztlich nachgewiesen
	enumeration	0122002	documentation nein
	enumeration	0122042	documentation unbekannt
annotation	documentation Kat_BI_Autoimmunerkrankung		
source	<pre> &lt;simpleType name="enum_0122"&gt;   &lt;annotation&gt;     &lt;documentation&gt;Kat_BI_Autoimmunerkrankung&lt;/documentation&gt;   &lt;/annotation&gt;   &lt;restriction base="xs:string"&gt;     &lt;enumeration value="0122001"&gt;       &lt;annotation&gt;         &lt;documentation&gt;ja, ärztlich nachgewiesen&lt;/documentation&gt;       &lt;/annotation&gt;     &lt;/enumeration&gt;     &lt;enumeration value="0122002"&gt;       &lt;annotation&gt;         &lt;documentation&gt;nein&lt;/documentation&gt;       &lt;/annotation&gt;     &lt;/enumeration&gt;     &lt;enumeration value="0122042"&gt;       &lt;annotation&gt;         &lt;documentation&gt;unbekannt&lt;/documentation&gt;       &lt;/annotation&gt;     &lt;/enumeration&gt;   &lt;/restriction&gt; &lt;/simpleType&gt; </pre>		

### simpleType enum\_0123

namespace	http://xml.ir-d.de/irdsaa		
type	restriction of <b>string</b>		
properties	base xs:string		
facets	Kind	Value	Annotation
	enumeration	0123001	documentation neu aufgetreten
	enumeration	0123002	documentation verschlechtert
	enumeration	0123003	documentation keine Veränderung
	enumeration	0123004	documentation nicht relevant, da Primäreingriff
	enumeration	0123042	documentation unbekannt
annotation	documentation Kat_BI_VerlaufAutoimmunerkrankung		
source	<pre> &lt;simpleType name="enum_0123"&gt;   &lt;annotation&gt;     &lt;documentation&gt;Kat_BI_VerlaufAutoimmunerkrankung&lt;/documentation&gt;   &lt;/annotation&gt;   &lt;restriction base="xs:string"&gt;     &lt;enumeration value="0123001"&gt;       &lt;annotation&gt;         &lt;documentation&gt;neu aufgetreten&lt;/documentation&gt;       &lt;/annotation&gt;     &lt;/enumeration&gt;     &lt;enumeration value="0123002"&gt;       &lt;annotation&gt;         &lt;documentation&gt;verschlechtert&lt;/documentation&gt;       &lt;/annotation&gt;     &lt;/enumeration&gt;     &lt;enumeration value="0123003"&gt;       &lt;annotation&gt;         &lt;documentation&gt;keine Veränderung&lt;/documentation&gt;       &lt;/annotation&gt;     &lt;/enumeration&gt;     &lt;enumeration value="0123004"&gt;       &lt;annotation&gt;         &lt;documentation&gt;nicht relevant, da Primäreingriff&lt;/documentation&gt;       &lt;/annotation&gt;     &lt;/enumeration&gt;     &lt;enumeration value="0123042"&gt;       &lt;annotation&gt;         &lt;documentation&gt;unbekannt&lt;/documentation&gt;       &lt;/annotation&gt;     &lt;/enumeration&gt;   &lt;/restriction&gt; &lt;/simpleType&gt; </pre>		

### simpleType enum\_0124

namespace	http://xml.ir-d.de/irdsaa		
type	restriction of <b>string</b>		
properties	base xs:string		



facets	<table border="1"> <thead> <tr> <th>Kind</th> <th>Value</th> <th>Annotation</th> </tr> </thead> <tbody> <tr> <td>enumeration</td> <td>0124001</td> <td>documentation Salzlösung</td> </tr> <tr> <td>enumeration</td> <td>0124002</td> <td>documentation Silikongel</td> </tr> <tr> <td>enumeration</td> <td>0124003</td> <td>documentation Kombination Silikongel und Salzlösung</td> </tr> <tr> <td>enumeration</td> <td>0124042</td> <td>documentation sonstige</td> </tr> </tbody> </table>	Kind	Value	Annotation	enumeration	0124001	documentation Salzlösung	enumeration	0124002	documentation Silikongel	enumeration	0124003	documentation Kombination Silikongel und Salzlösung	enumeration	0124042	documentation sonstige
Kind	Value	Annotation														
enumeration	0124001	documentation Salzlösung														
enumeration	0124002	documentation Silikongel														
enumeration	0124003	documentation Kombination Silikongel und Salzlösung														
enumeration	0124042	documentation sonstige														
annotation	documentation Kat_BI_Fuellung															
source	<pre> &lt;simpleType name="enum_0124"&gt;   &lt;annotation&gt;     &lt;documentation&gt;Kat_BI_Fuellung&lt;/documentation&gt;   &lt;/annotation&gt;   &lt;restriction base="xs:string"&gt;     &lt;enumeration value="0124001"&gt;       &lt;annotation&gt;         &lt;documentation&gt;Salzlösung&lt;/documentation&gt;       &lt;/annotation&gt;     &lt;/enumeration&gt;     &lt;enumeration value="0124002"&gt;       &lt;annotation&gt;         &lt;documentation&gt;Silikongel&lt;/documentation&gt;       &lt;/annotation&gt;     &lt;/enumeration&gt;     &lt;enumeration value="0124003"&gt;       &lt;annotation&gt;         &lt;documentation&gt;Kombination Silikongel und Salzlösung&lt;/documentation&gt;       &lt;/annotation&gt;     &lt;/enumeration&gt;     &lt;enumeration value="0124042"&gt;       &lt;annotation&gt;         &lt;documentation&gt;sonstige&lt;/documentation&gt;       &lt;/annotation&gt;     &lt;/enumeration&gt;   &lt;/restriction&gt; &lt;/simpleType&gt; </pre>															

### simpleType enum\_0126

namespace	http://xml.ir-d.de/irdsaa												
type	restriction of <b>string</b>												
properties	base xs:string												
facets	<table border="1"> <thead> <tr> <th>Kind</th> <th>Value</th> <th>Annotation</th> </tr> </thead> <tbody> <tr> <td>enumeration</td> <td>0126001</td> <td>documentation anatomisch (tropfenförmig)</td> </tr> <tr> <td>enumeration</td> <td>0126002</td> <td>documentation rund (punktsymmetrisch)</td> </tr> <tr> <td>enumeration</td> <td>0126042</td> <td>documentation sonstige</td> </tr> </tbody> </table>	Kind	Value	Annotation	enumeration	0126001	documentation anatomisch (tropfenförmig)	enumeration	0126002	documentation rund (punktsymmetrisch)	enumeration	0126042	documentation sonstige
Kind	Value	Annotation											
enumeration	0126001	documentation anatomisch (tropfenförmig)											
enumeration	0126002	documentation rund (punktsymmetrisch)											
enumeration	0126042	documentation sonstige											
annotation	documentation Kat_BI_Form												
source	<pre> &lt;simpleType name="enum_0126"&gt;   &lt;annotation&gt;     &lt;documentation&gt;Kat_BI_Form&lt;/documentation&gt;   &lt;/annotation&gt; </pre>												

	<pre> &lt;restriction base="xs:string"&gt;   &lt;enumeration value="0126001"&gt;     &lt;annotation&gt;       &lt;documentation&gt;anatomisch (tropfenförmig)&lt;/documentation&gt;     &lt;/annotation&gt;   &lt;/enumeration&gt;   &lt;enumeration value="0126002"&gt;     &lt;annotation&gt;       &lt;documentation&gt;rund (punktsymmetrisch)&lt;/documentation&gt;     &lt;/annotation&gt;   &lt;/enumeration&gt;   &lt;enumeration value="0126042"&gt;     &lt;annotation&gt;       &lt;documentation&gt;sonstige&lt;/documentation&gt;     &lt;/annotation&gt;   &lt;/enumeration&gt; &lt;/restriction&gt; &lt;/simpleType&gt; </pre>
--	---

### simpleType enum\_0128

namespace	http://xml.ir-d.de/irdsaa		
type	restriction of <b>string</b>		
properties	base xs:string		
facets	Kind	Value	Annotation
	enumeration	0128001	documentation glattwandig
	enumeration	0128002	documentation beschichtet
	enumeration	0128003	documentation texturiert
annotation	documentation Kat BI Oberflaeche		
source	<pre> &lt;simpleType name="enum_0128"&gt;   &lt;annotation&gt;     &lt;documentation&gt;Kat_BI_Oberflaeche&lt;/documentation&gt;   &lt;/annotation&gt;   &lt;restriction base="xs:string"&gt;     &lt;enumeration value="0128001"&gt;       &lt;annotation&gt;         &lt;documentation&gt;glattwandig&lt;/documentation&gt;       &lt;/annotation&gt;     &lt;/enumeration&gt;     &lt;enumeration value="0128002"&gt;       &lt;annotation&gt;         &lt;documentation&gt;beschichtet&lt;/documentation&gt;       &lt;/annotation&gt;     &lt;/enumeration&gt;     &lt;enumeration value="0128003"&gt;       &lt;annotation&gt;         &lt;documentation&gt;texturiert&lt;/documentation&gt;       &lt;/annotation&gt;     &lt;/enumeration&gt;   &lt;/restriction&gt; &lt;/simpleType&gt; </pre>		

### simpleType enum\_0130

namespace	http://xml.ir-d.de/irdsaa		
type	restriction of <b>string</b>		
properties	base xs:string		
facets	Kind	Value	Annotation
	enumeration	0130001	documentation Allergan
	enumeration	0130002	documentation Cereplas
	enumeration	0130003	documentation CUI (Cox Uphoff Implants)
	enumeration	0130004	documentation EMSI Biomedical
	enumeration	0130005	documentation Establishment labs
	enumeration	0130006	documentation Eurosilicone
	enumeration	0130007	documentation Nagor
	enumeration	0130008	documentation Groupe Sebbin
	enumeration	0130009	documentation Laboratoires Arion
	enumeration	0130010	documentation Mentor
	enumeration	0130011	documentation Pérouse Plastie SAS
	enumeration	0130012	documentation PIP M-Implants
	enumeration	0130013	documentation Polytech Health & Aesthetics
	enumeration	0130014	documentation Silimed
	enumeration	0130015	documentation Surgitek
	enumeration	0130016	documentation G&G Biotechnology
	enumeration	0130017	documentation nicht belegter Wert
	enumeration	0130018	documentation nicht belegter Wert
	enumeration	0130019	documentation nicht belegter Wert
	enumeration	0130020	documentation nicht belegter Wert
	enumeration	0130021	documentation nicht belegter Wert
	enumeration	0130042	documentation sonstiger
annotation	documentation Kat_BI_Hersteller		
source	<pre> &lt;simpleType name="enum_0130"&gt;   &lt;annotation&gt;     &lt;documentation&gt;Kat_BI_Hersteller&lt;/documentation&gt;   &lt;/annotation&gt;   &lt;restriction base="xs:string"&gt;     &lt;enumeration value="0130001"&gt;       &lt;annotation&gt;         &lt;documentation&gt;Allergan&lt;/documentation&gt;       &lt;/annotation&gt; </pre>		

```
</enumeration>
<enumeration value="0130002">
  <annotation>
    <documentation>Cereplas</documentation>
  </annotation>
</enumeration>
<enumeration value="0130003">
  <annotation>
    <documentation>CUI (Cox Uphoff Implants)</documentation>
  </annotation>
</enumeration>
<enumeration value="0130004">
  <annotation>
    <documentation>EMSI Biomedical</documentation>
  </annotation>
</enumeration>
<enumeration value="0130005">
  <annotation>
    <documentation>Establishment labs</documentation>
  </annotation>
</enumeration>
<enumeration value="0130006">
  <annotation>
    <documentation>Eurosilicone</documentation>
  </annotation>
</enumeration>
<enumeration value="0130007">
  <annotation>
    <documentation>Nagor</documentation>
  </annotation>
</enumeration>
<enumeration value="0130008">
  <annotation>
    <documentation>Groupe Sebbin</documentation>
  </annotation>
</enumeration>
<enumeration value="0130009">
  <annotation>
    <documentation>Laboratoires Arion</documentation>
  </annotation>
</enumeration>
<enumeration value="0130010">
  <annotation>
    <documentation>Mentor</documentation>
  </annotation>
</enumeration>
<enumeration value="0130011">
  <annotation>
    <documentation>Pérouse Plastie SAS</documentation>
  </annotation>
</enumeration>
<enumeration value="0130012">
  <annotation>
    <documentation>PIP M-Implants</documentation>
  </annotation>
</enumeration>
<enumeration value="0130013">
  <annotation>
    <documentation>Polytech Health & Aesthetics</documentation>
  </annotation>
</enumeration>
```

```

</annotation>
</enumeration>
<enumeration value="0130014">
  <annotation>
    <documentation>Silimed</documentation>
  </annotation>
</enumeration>
<enumeration value="0130015">
  <annotation>
    <documentation>Surgitek</documentation>
  </annotation>
</enumeration>
<enumeration value="0130016">
  <annotation>
    <documentation>G&amp;G Biotechnology</documentation>
  </annotation>
</enumeration>
<enumeration value="0130017">
  <annotation>
    <documentation>nicht belegter Wert</documentation>
  </annotation>
</enumeration>
<enumeration value="0130018">
  <annotation>
    <documentation>nicht belegter Wert</documentation>
  </annotation>
</enumeration>
<enumeration value="0130019">
  <annotation>
    <documentation>nicht belegter Wert</documentation>
  </annotation>
</enumeration>
<enumeration value="0130020">
  <annotation>
    <documentation>nicht belegter Wert</documentation>
  </annotation>
</enumeration>
<enumeration value="0130021">
  <annotation>
    <documentation>nicht belegter Wert</documentation>
  </annotation>
</enumeration>
<enumeration value="0130042">
  <annotation>
    <documentation>sonstiger</documentation>
  </annotation>
</enumeration>
</restriction>
</simpleType>

```

### simpleType enum\_0131

namespace	http://xml.ir-d.de/irdsaa
type	restriction of <b>string</b>
properties	base xs:string
facets	Kind Value Annotation

	<p>enumeration 0131001 documentation Allergan</p> <p>enumeration 0131002 documentation Establishment labs</p> <p>enumeration 0131003 documentation Eurosilicone</p> <p>enumeration 0131004 documentation Galatea</p> <p>enumeration 0131005 documentation Integra</p> <p>enumeration 0131006 documentation Lifecell</p> <p>enumeration 0131007 documentation MBP (Medical Biomaterial Products)</p> <p>enumeration 0131008 documentation Mentor</p> <p>enumeration 0131009 documentation Novus Scientific</p> <p>enumeration 0131010 documentation pfmMedical</p> <p>enumeration 0131011 documentation nicht belegter Wert</p> <p>enumeration 0131012 documentation nicht belegter Wert</p> <p>enumeration 0131013 documentation nicht belegter Wert</p> <p>enumeration 0131014 documentation nicht belegter Wert</p> <p>enumeration 0131015 documentation nicht belegter Wert</p> <p>enumeration 0131042 documentation sonstiger</p>
annotation	documentation Kat_BI_ZubehoerHersteller
source	<pre> &lt;simpleType name="enum_0131"&gt;   &lt;annotation&gt;     &lt;documentation&gt;Kat_BI_ZubehoerHersteller&lt;/documentation&gt;   &lt;/annotation&gt;   &lt;restriction base="xs:string"&gt;     &lt;enumeration value="0131001"&gt;       &lt;annotation&gt;         &lt;documentation&gt;Allergan&lt;/documentation&gt;       &lt;/annotation&gt;     &lt;/enumeration&gt;     &lt;enumeration value="0131002"&gt;       &lt;annotation&gt;         &lt;documentation&gt;Establishment labs&lt;/documentation&gt;       &lt;/annotation&gt;     &lt;/enumeration&gt;     &lt;enumeration value="0131003"&gt;       &lt;annotation&gt;         &lt;documentation&gt;Eurosilicone&lt;/documentation&gt;       &lt;/annotation&gt;     &lt;/enumeration&gt;     &lt;enumeration value="0131004"&gt;       &lt;annotation&gt;         &lt;documentation&gt;Galatea&lt;/documentation&gt;       &lt;/annotation&gt;     &lt;/enumeration&gt;     &lt;enumeration value="0131005"&gt;       &lt;annotation&gt;         &lt;documentation&gt;Integra&lt;/documentation&gt; </pre>

```
</annotation>
</enumeration>
<enumeration value="0131006">
  <annotation>
    <documentation>Lifecell</documentation>
  </annotation>
</enumeration>
<enumeration value="0131007">
  <annotation>
    <documentation>MBP (Medical Biomaterial Products)</documentation>
  </annotation>
</enumeration>
<enumeration value="0131008">
  <annotation>
    <documentation>Mentor</documentation>
  </annotation>
</enumeration>
<enumeration value="0131009">
  <annotation>
    <documentation>Novus Scientific</documentation>
  </annotation>
</enumeration>
<enumeration value="0131010">
  <annotation>
    <documentation>pfmMedical</documentation>
  </annotation>
</enumeration>
<enumeration value="0131011">
  <annotation>
    <documentation>nicht belegter Wert</documentation>
  </annotation>
</enumeration>
<enumeration value="0131012">
  <annotation>
    <documentation>nicht belegter Wert</documentation>
  </annotation>
</enumeration>
<enumeration value="0131013">
  <annotation>
    <documentation>nicht belegter Wert</documentation>
  </annotation>
</enumeration>
<enumeration value="0131014">
  <annotation>
    <documentation>nicht belegter Wert</documentation>
  </annotation>
</enumeration>
<enumeration value="0131015">
  <annotation>
    <documentation>nicht belegter Wert</documentation>
  </annotation>
</enumeration>
<enumeration value="0131042">
  <annotation>
    <documentation>sonstiger</documentation>
  </annotation>
</enumeration>
</restriction>
</simpleType>
```

### simpleType enum\_0190

namespace	http://xml.ir-d.de/irdsaa		
type	restriction of <b>string</b>		
properties	base xs:string		
facets	Kind	Value	Annotation
	enumeration	0190001	documentation Brustimplantat
	enumeration	0190003	documentation Brustexpander
annotation	documentation Kat_BI_Artikeltyp		
source	<pre> &lt;simpleType name="enum_0190"&gt;   &lt;annotation&gt;     &lt;documentation&gt;Kat_BI_Artikeltyp&lt;/documentation&gt;   &lt;/annotation&gt;   &lt;restriction base="xs:string"&gt;     &lt;enumeration value="0190001"&gt;       &lt;annotation&gt;         &lt;documentation&gt;Brustimplantat&lt;/documentation&gt;       &lt;/annotation&gt;     &lt;/enumeration&gt;     &lt;enumeration value="0190003"&gt;       &lt;annotation&gt;         &lt;documentation&gt;Brustexpander&lt;/documentation&gt;       &lt;/annotation&gt;     &lt;/enumeration&gt;   &lt;/restriction&gt; &lt;/simpleType&gt; </pre>		

### simpleType enum\_0191

namespace	http://xml.ir-d.de/irdsaa		
type	restriction of <b>string</b>		
properties	base xs:string		
facets	Kind	Value	Annotation
	enumeration	0191001	documentation Netz
	enumeration	0191002	documentation ADM
annotation	documentation Kat_BI_ZubehoerTyp		
source	<pre> &lt;simpleType name="enum_0191"&gt;   &lt;annotation&gt;     &lt;documentation&gt;Kat_BI_ZubehoerTyp&lt;/documentation&gt;   &lt;/annotation&gt;   &lt;restriction base="xs:string"&gt;     &lt;enumeration value="0191001"&gt;       &lt;annotation&gt;         &lt;documentation&gt;Netz&lt;/documentation&gt;       &lt;/annotation&gt;     &lt;/enumeration&gt;     &lt;enumeration value="0191002"&gt; </pre>		



	<pre> &lt;annotation&gt;   &lt;documentation&gt;ADM&lt;/documentation&gt; &lt;/annotation&gt; &lt;/enumeration&gt; &lt;/restriction&gt; &lt;/simpleType&gt; </pre>
--	--

### simpleType enum\_0200

namespace	http://xml.ir-d.de/irdsaa		
type	restriction of <b>string</b>		
properties	base xs:string		
facets	Kind	Value	Annotation
	enumeration	0200001	documentation Erst-OP
	enumeration	0200002	documentation Folgeeingriff
annotation	documentation Kat_EP_ArtEingriff		
source	<pre> &lt;simpleType name="enum_0200"&gt;   &lt;annotation&gt;     &lt;documentation&gt;Kat_EP_ArtEingriff&lt;/documentation&gt;   &lt;/annotation&gt;   &lt;restriction base="xs:string"&gt;     &lt;enumeration value="0200001"&gt;       &lt;annotation&gt;         &lt;documentation&gt;Erst-OP&lt;/documentation&gt;       &lt;/annotation&gt;     &lt;/enumeration&gt;     &lt;enumeration value="0200002"&gt;       &lt;annotation&gt;         &lt;documentation&gt;Folgeeingriff&lt;/documentation&gt;       &lt;/annotation&gt;     &lt;/enumeration&gt;   &lt;/restriction&gt; &lt;/simpleType&gt; </pre>		

### simpleType enum\_0202

namespace	http://xml.ir-d.de/irdsaa		
type	restriction of <b>string</b>		
properties	base xs:string		
facets	Kind	Value	Annotation
	enumeration	0202001	documentation Lockerung
	enumeration	0202002	documentation Infektion, Verdacht auf
	enumeration	0202003	documentation Infektion, gesichert
	enumeration	0202004	documentation Luxation, Inlay aus der Pfanne
	enumeration	0202005	documentation Luxation, Kopf aus Pfanne/Inlay
	enumeration	0202006	documentation Periprothetische Fraktur

	<p>enumeration 0202007 documentation Verschleiß des PE-Inlays</p> <p>enumeration 0202008 documentation Implantatbruch</p> <p>enumeration 0202009 documentation Implantatfehlage/Malalignement</p> <p>enumeration 0202010 documentation Osteolysen bei festem Implantat</p> <p>enumeration 0202011 documentation Progression der Grunderkrankung</p> <p>enumeration 0202012 documentation ARM-D</p> <p>enumeration 0202013 documentation Verdacht auf allergische Reaktion</p> <p>enumeration 0202021 documentation Zustand nach Prothesenentfernung</p> <p>enumeration 0202042 documentation andere Gründe</p>
annotation	documentation Kat_EP_GrundWechselHuefte
source	<pre> &lt;simpleType name="enum_0202"&gt;   &lt;annotation&gt;     &lt;documentation&gt;Kat_EP_GrundWechselHuefte&lt;/documentation&gt;   &lt;/annotation&gt;   &lt;restriction base="xs:string"&gt;     &lt;enumeration value="0202001"&gt;       &lt;annotation&gt;         &lt;documentation&gt;Lockerung&lt;/documentation&gt;       &lt;/annotation&gt;     &lt;/enumeration&gt;     &lt;enumeration value="0202002"&gt;       &lt;annotation&gt;         &lt;documentation&gt;Infektion, Verdacht auf&lt;/documentation&gt;       &lt;/annotation&gt;     &lt;/enumeration&gt;     &lt;enumeration value="0202003"&gt;       &lt;annotation&gt;         &lt;documentation&gt;Infektion, gesichert&lt;/documentation&gt;       &lt;/annotation&gt;     &lt;/enumeration&gt;     &lt;enumeration value="0202004"&gt;       &lt;annotation&gt;         &lt;documentation&gt;Luxation, Inlay aus der Pfanne&lt;/documentation&gt;       &lt;/annotation&gt;     &lt;/enumeration&gt;     &lt;enumeration value="0202005"&gt;       &lt;annotation&gt;         &lt;documentation&gt;Luxation, Kopf aus Pfanne/Inlay&lt;/documentation&gt;       &lt;/annotation&gt;     &lt;/enumeration&gt;     &lt;enumeration value="0202006"&gt;       &lt;annotation&gt;         &lt;documentation&gt;Periprothetische Fraktur&lt;/documentation&gt;       &lt;/annotation&gt;     &lt;/enumeration&gt;     &lt;enumeration value="0202007"&gt;       &lt;annotation&gt;         &lt;documentation&gt;Verschleiß des PE-Inlays&lt;/documentation&gt;       &lt;/annotation&gt;     &lt;/enumeration&gt;   &lt;/restriction&gt; &lt;/simpleType&gt; </pre>

```

<enumeration value="0202008">
  <annotation>
    <documentation>Implantatbruch</documentation>
  </annotation>
</enumeration>
<enumeration value="0202009">
  <annotation>
    <documentation>Implantatfehllage/Malalignent</documentation>
  </annotation>
</enumeration>
<enumeration value="0202010">
  <annotation>
    <documentation>Osteolysen bei festem Implantat</documentation>
  </annotation>
</enumeration>
<enumeration value="0202011">
  <annotation>
    <documentation>Progression der Grunderkrankung</documentation>
  </annotation>
</enumeration>
<enumeration value="0202012">
  <annotation>
    <documentation>ARMD</documentation>
  </annotation>
</enumeration>
<enumeration value="0202013">
  <annotation>
    <documentation>Verdacht auf allergische Reaktion</documentation>
  </annotation>
</enumeration>
<enumeration value="0202021">
  <annotation>
    <documentation>Zustand nach Prothesenentfernung</documentation>
  </annotation>
</enumeration>
<enumeration value="0202042">
  <annotation>
    <documentation>andere Gründe</documentation>
  </annotation>
</enumeration>
</restriction>
</simpleType>

```

#### simpleType enum\_0204

namespace	http://xml.ir-d.de/irdsaa		
type	restriction of <b>string</b>		
properties	base xs:string		
facets	Kind	Value	Annotation
	enumeration	0204001	documentation Lockerung
	enumeration	0204002	documentation Infektion, Verdacht auf
	enumeration	0204003	documentation Infektion, gesichert
	enumeration	0204006	documentation Periprothetische Fraktur

	<p>enumeration 0204007 documentation Verschleiß</p> <p>enumeration 0204008 documentation Implantatbruch</p> <p>enumeration 0204009 documentation Implantatfehlage/Malalignement</p> <p>enumeration 0204010 documentation Osteolysen bei festem Implantat</p> <p>enumeration 0204011 documentation Progression der Grunderkrankung</p> <p>enumeration 0204012 documentation ARM D</p> <p>enumeration 0204013 documentation Verdacht auf allergische Reaktion</p> <p>enumeration 0204014 documentation Dislokation/Migration von Komponenten</p> <p>enumeration 0204015 documentation Bandinstabilität</p> <p>enumeration 0204016 documentation Bewegungseinschränkung</p> <p>enumeration 0204021 documentation Zustand nach Prothesenentfernung</p> <p>enumeration 0204042 documentation andere Gründe</p>
annotation	documentation Kat_EP_GrundWechselKnie
source	<pre> &lt;simpleType name="enum_0204"&gt;   &lt;annotation&gt;     &lt;documentation&gt;Kat_EP_GrundWechselKnie&lt;/documentation&gt;   &lt;/annotation&gt;   &lt;restriction base="xs:string"&gt;     &lt;enumeration value="0204001"&gt;       &lt;annotation&gt;         &lt;documentation&gt;Lockerung&lt;/documentation&gt;       &lt;/annotation&gt;     &lt;/enumeration&gt;     &lt;enumeration value="0204002"&gt;       &lt;annotation&gt;         &lt;documentation&gt;Infektion, Verdacht auf&lt;/documentation&gt;       &lt;/annotation&gt;     &lt;/enumeration&gt;     &lt;enumeration value="0204003"&gt;       &lt;annotation&gt;         &lt;documentation&gt;Infektion, gesichert&lt;/documentation&gt;       &lt;/annotation&gt;     &lt;/enumeration&gt;     &lt;enumeration value="0204006"&gt;       &lt;annotation&gt;         &lt;documentation&gt;Periprothetische Fraktur&lt;/documentation&gt;       &lt;/annotation&gt;     &lt;/enumeration&gt;     &lt;enumeration value="0204007"&gt;       &lt;annotation&gt;         &lt;documentation&gt;Verschleiß&lt;/documentation&gt;       &lt;/annotation&gt;     &lt;/enumeration&gt;     &lt;enumeration value="0204008"&gt;       &lt;annotation&gt;         &lt;documentation&gt;Implantatbruch&lt;/documentation&gt;       &lt;/annotation&gt;     &lt;/enumeration&gt;   &lt;/restriction&gt; &lt;/simpleType&gt; </pre>

```

<enumeration value="0204009">
  <annotation>
    <documentation>Implantatfehllage/Malalignent</documentation>
  </annotation>
</enumeration>
<enumeration value="0204010">
  <annotation>
    <documentation>Osteolysen bei festem Implantat</documentation>
  </annotation>
</enumeration>
<enumeration value="0204011">
  <annotation>
    <documentation>Progression der Grunderkrankung</documentation>
  </annotation>
</enumeration>
<enumeration value="0204012">
  <annotation>
    <documentation>ARMD</documentation>
  </annotation>
</enumeration>
<enumeration value="0204013">
  <annotation>
    <documentation>Verdacht auf allergische Reaktion</documentation>
  </annotation>
</enumeration>
<enumeration value="0204014">
  <annotation>
    <documentation>Dislokation/Migration von Komponenten</documentation>
  </annotation>
</enumeration>
<enumeration value="0204015">
  <annotation>
    <documentation>Bandinstabilität</documentation>
  </annotation>
</enumeration>
<enumeration value="0204016">
  <annotation>
    <documentation>Bewegungseinschränkung</documentation>
  </annotation>
</enumeration>
<enumeration value="0204021">
  <annotation>
    <documentation>Zustand nach Prothesenentfernung</documentation>
  </annotation>
</enumeration>
<enumeration value="0204042">
  <annotation>
    <documentation>andere Gründe</documentation>
  </annotation>
</enumeration>
</restriction>
</simpleType>

```

#### simpleType enum\_0206

namespace	http://xml.ir-d.de/irdsaa
type	restriction of <b>string</b>

properties	base	xs:string	
facets	Kind	Value	Annotation
	enumeration	0206001	documentation Lockerung
	enumeration	0206002	documentation Infektion, Verdacht auf
	enumeration	0206003	documentation Infektion, gesichert
	enumeration	0206004	documentation Luxation, Inlay aus der Pfanne
	enumeration	0206005	documentation Luxation, Kopf aus Pfanne/Inlay
	enumeration	0206006	documentation Periprothetische Fraktur
	enumeration	0206007	documentation Verschleiß
	enumeration	0206008	documentation Implantatbruch
	enumeration	0206009	documentation Implantatfehlage/Malalignent
	enumeration	0206010	documentation Osteolysen bei festem Implantat
	enumeration	0206011	documentation Progression der Grunderkrankung
	enumeration	0206012	documentation ARM-D
	enumeration	0206013	documentation Verdacht auf allergische Reaktion
	enumeration	0206014	documentation Dislokation/Migration von Komponenten
	enumeration	0206015	documentation Bandinstabilität
	enumeration	0206016	documentation Bewegungseinschränkung
	enumeration	0206021	documentation Zustand nach Prothesenentfernung
	enumeration	0206042	documentation andere Gründe
annotation	documentation		Kat_EP_GrundWechselTFE
source	<pre> &lt;simpleType name="enum_0206"&gt;   &lt;annotation&gt;     &lt;documentation&gt;Kat_EP_GrundWechselTFE&lt;/documentation&gt;   &lt;/annotation&gt;   &lt;restriction base="xs:string"&gt;     &lt;enumeration value="0206001"&gt;       &lt;annotation&gt;         &lt;documentation&gt;Lockerung&lt;/documentation&gt;       &lt;/annotation&gt;     &lt;/enumeration&gt;     &lt;enumeration value="0206002"&gt;       &lt;annotation&gt;         &lt;documentation&gt;Infektion, Verdacht auf&lt;/documentation&gt;       &lt;/annotation&gt;     &lt;/enumeration&gt;     &lt;enumeration value="0206003"&gt;       &lt;annotation&gt;         &lt;documentation&gt;Infektion, gesichert&lt;/documentation&gt;       &lt;/annotation&gt;     &lt;/enumeration&gt;     &lt;enumeration value="0206004"&gt;       &lt;annotation&gt; </pre>		

```
<documentation>Luxation, Inlay aus der Pfanne</documentation>
</annotation>
</enumeration>
<enumeration value="0206005">
  <annotation>
    <documentation>Luxation, Kopf aus Pfanne/Inlay</documentation>
  </annotation>
</enumeration>
<enumeration value="0206006">
  <annotation>
    <documentation>Periprothetische Fraktur</documentation>
  </annotation>
</enumeration>
<enumeration value="0206007">
  <annotation>
    <documentation>Verschleiß</documentation>
  </annotation>
</enumeration>
<enumeration value="0206008">
  <annotation>
    <documentation>Implantatbruch</documentation>
  </annotation>
</enumeration>
<enumeration value="0206009">
  <annotation>
    <documentation>Implantatfehlage/Malalignent</documentation>
  </annotation>
</enumeration>
<enumeration value="0206010">
  <annotation>
    <documentation>Osteolysen bei festem Implantat</documentation>
  </annotation>
</enumeration>
<enumeration value="0206011">
  <annotation>
    <documentation>Progression der Grunderkrankung</documentation>
  </annotation>
</enumeration>
<enumeration value="0206012">
  <annotation>
    <documentation>ARMD</documentation>
  </annotation>
</enumeration>
<enumeration value="0206013">
  <annotation>
    <documentation>Verdacht auf allergische Reaktion</documentation>
  </annotation>
</enumeration>
<enumeration value="0206014">
  <annotation>
    <documentation>Dislokation/Migration von Komponenten</documentation>
  </annotation>
</enumeration>
<enumeration value="0206015">
  <annotation>
    <documentation>Bandinstabilität</documentation>
  </annotation>
</enumeration>
<enumeration value="0206016">
```

	<pre> &lt;annotation&gt;   &lt;documentation&gt;Bewegungseinschränkung&lt;/documentation&gt; &lt;/annotation&gt; &lt;/enumeration&gt; &lt;enumeration value="0206021"&gt;   &lt;annotation&gt;     &lt;documentation&gt;Zustand nach Prothesenentfernung&lt;/documentation&gt;   &lt;/annotation&gt; &lt;/enumeration&gt; &lt;enumeration value="0206042"&gt;   &lt;annotation&gt;     &lt;documentation&gt;andere Gründe&lt;/documentation&gt;   &lt;/annotation&gt; &lt;/enumeration&gt; &lt;/restriction&gt; &lt;/simpleType&gt; </pre>
--	--

### simpleType enum\_0210

namespace	http://xml.ir-d.de/irdsaa		
type	restriction of <b>string</b>		
properties	base xs:string		
facets	Kind	Value	Annotation
	enumeration	0210001	documentation keine relevante Voroperation
	enumeration	0210002	documentation Osteosynthese/Osteotomie (Becken)
	enumeration	0210003	documentation Osteosynthese/Osteotomie (Femur)
	enumeration	0210004	documentation Osteosynthese/Osteotomie (beides)
	enumeration	0210005	documentation Operation bei Hüftkopfnekrose
	enumeration	0210006	documentation Arthrodese
	enumeration	0210042	documentation andere
annotation	documentation Kat_EP_VoroperationHuefte		
source	<pre> &lt;simpleType name="enum_0210"&gt;   &lt;annotation&gt;     &lt;documentation&gt;Kat_EP_VoroperationHuefte&lt;/documentation&gt;   &lt;/annotation&gt;   &lt;restriction base="xs:string"&gt;     &lt;enumeration value="0210001"&gt;       &lt;annotation&gt;         &lt;documentation&gt;keine relevante Voroperation&lt;/documentation&gt;       &lt;/annotation&gt;     &lt;/enumeration&gt;     &lt;enumeration value="0210002"&gt;       &lt;annotation&gt;         &lt;documentation&gt;Osteosynthese/Osteotomie (Becken)&lt;/documentation&gt;       &lt;/annotation&gt;     &lt;/enumeration&gt;     &lt;enumeration value="0210003"&gt;       &lt;annotation&gt;         &lt;documentation&gt;Osteosynthese/Osteotomie (Femur)&lt;/documentation&gt;       &lt;/annotation&gt;     &lt;/enumeration&gt;   &lt;/restriction&gt; &lt;/simpleType&gt; </pre>		



	<pre> &lt;/annotation&gt; &lt;/enumeration&gt; &lt;enumeration value="0210004"&gt;   &lt;annotation&gt;     &lt;documentation&gt;Osteosynthese/Osteotomie (beides)&lt;/documentation&gt;   &lt;/annotation&gt; &lt;/enumeration&gt; &lt;enumeration value="0210005"&gt;   &lt;annotation&gt;     &lt;documentation&gt;Operation bei Hüftkopfnnekrose&lt;/documentation&gt;   &lt;/annotation&gt; &lt;/enumeration&gt; &lt;enumeration value="0210006"&gt;   &lt;annotation&gt;     &lt;documentation&gt;Arthrodese&lt;/documentation&gt;   &lt;/annotation&gt; &lt;/enumeration&gt; &lt;enumeration value="0210042"&gt;   &lt;annotation&gt;     &lt;documentation&gt;andere&lt;/documentation&gt;   &lt;/annotation&gt; &lt;/enumeration&gt; &lt;/restriction&gt; &lt;/simpleType&gt; </pre>
--	---

### simpleType enum\_0211

namespace	http://xml.ir-d.de/irdsaa		
type	restriction of <b>string</b>		
properties	base xs:string		
facets	Kind	Value	Annotation
	enumeration	0211001	documentation keine relevante Voroperation
	enumeration	0211002	documentation Osteosynthese/Osteotomie (Femur)
	enumeration	0211003	documentation Osteosynthese/Osteotomie (Tibia)
	enumeration	0211004	documentation Osteosynthese/Osteotomie (Patella)
	enumeration	0211005	documentation Osteosynthese/Osteotomie (mehrere)
	enumeration	0211006	documentation Kapsel-/Bandapparat
	enumeration	0211007	documentation Arthrodese
	enumeration	0211042	documentation andere
annotation	documentation Kat_EP_VoroperationKnie		
source	<pre> &lt;simpleType name="enum_0211"&gt;   &lt;annotation&gt;     &lt;documentation&gt;Kat_EP_VoroperationKnie&lt;/documentation&gt;   &lt;/annotation&gt;   &lt;restriction base="xs:string"&gt;     &lt;enumeration value="0211001"&gt;       &lt;annotation&gt;         &lt;documentation&gt;keine relevante Voroperation&lt;/documentation&gt;       &lt;/annotation&gt; </pre>		

```

</enumeration>
<enumeration value="0211002">
  <annotation>
    <documentation>Osteosynthese/Osteotomie (Femur)</documentation>
  </annotation>
</enumeration>
<enumeration value="0211003">
  <annotation>
    <documentation>Osteosynthese/Osteotomie (Tibia)</documentation>
  </annotation>
</enumeration>
<enumeration value="0211004">
  <annotation>
    <documentation>Osteosynthese/Osteotomie (Patella)</documentation>
  </annotation>
</enumeration>
<enumeration value="0211005">
  <annotation>
    <documentation>Osteosynthese/Osteotomie (mehrere)</documentation>
  </annotation>
</enumeration>
<enumeration value="0211006">
  <annotation>
    <documentation>Kapsel-/Bandapparat</documentation>
  </annotation>
</enumeration>
<enumeration value="0211007">
  <annotation>
    <documentation>Arthrodesse</documentation>
  </annotation>
</enumeration>
<enumeration value="0211042">
  <annotation>
    <documentation>andere</documentation>
  </annotation>
</enumeration>
</restriction>
</simpleType>

```

simpleType **enum\_0212**

namespace	http://xml.ir-d.de/irdsaa		
type	restriction of <b>string</b>		
properties	base xs:string		
facets	Kind	Value	Annotation
	enumeration	0212001	documentation Hüfte
	enumeration	0212002	documentation Knie
	enumeration	0212003	documentation Totaler Femurersatz inkl. Durchsteck-Prothese
annotation	documentation Kat_EP_Gelenk		
source	<simpleType name="enum_0212">   <annotation>     <documentation>Kat_EP_Gelenk</documentation>   </annotation>		

	<pre> &lt;restriction base="xs:string"&gt;   &lt;enumeration value="0212001"&gt;     &lt;annotation&gt;       &lt;documentation&gt;Hüfte&lt;/documentation&gt;     &lt;/annotation&gt;   &lt;/enumeration&gt;   &lt;enumeration value="0212002"&gt;     &lt;annotation&gt;       &lt;documentation&gt;Knie&lt;/documentation&gt;     &lt;/annotation&gt;   &lt;/enumeration&gt;   &lt;enumeration value="0212003"&gt;     &lt;annotation&gt;       &lt;documentation&gt;Totaler Femurersatz inkl. Durchsteck-Prothese&lt;/documentation&gt;     &lt;/annotation&gt;   &lt;/enumeration&gt; &lt;/restriction&gt; &lt;/simpleType&gt; </pre>
--	--

### simpleType enum 0220

namespace	http://xml.ir-d.de/irdsaa		
type	restriction of <b>string</b>		
properties	base xs:string		
facets	Kind	Value	Annotation
	enumeration	0220001	documentation anterior
	enumeration	0220002	documentation anterolateral
	enumeration	0220003	documentation lateral
	enumeration	0220004	documentation posterior
	enumeration	0220005	documentation posterolateral
	enumeration	0220006	documentation 2-Inzisionen-Zugang
	enumeration	0220042	documentation sonstiges/unbekannt
annotation	documentation Kat_EP_Operationszugang		
source	<pre> &lt;simpleType name="enum_0220"&gt;   &lt;annotation&gt;     &lt;documentation&gt;Kat_EP_Operationszugang&lt;/documentation&gt;   &lt;/annotation&gt;   &lt;restriction base="xs:string"&gt;     &lt;enumeration value="0220001"&gt;       &lt;annotation&gt;         &lt;documentation&gt;anterior&lt;/documentation&gt;       &lt;/annotation&gt;     &lt;/enumeration&gt;     &lt;enumeration value="0220002"&gt;       &lt;annotation&gt;         &lt;documentation&gt;anterolateral&lt;/documentation&gt;       &lt;/annotation&gt;     &lt;/enumeration&gt; </pre>		

	<pre> &lt;enumeration value="0220003"&gt;   &lt;annotation&gt;     &lt;documentation&gt;lateral&lt;/documentation&gt;   &lt;/annotation&gt; &lt;/enumeration&gt; &lt;enumeration value="0220004"&gt;   &lt;annotation&gt;     &lt;documentation&gt;posterior&lt;/documentation&gt;   &lt;/annotation&gt; &lt;/enumeration&gt; &lt;enumeration value="0220005"&gt;   &lt;annotation&gt;     &lt;documentation&gt;posterolateral&lt;/documentation&gt;   &lt;/annotation&gt; &lt;/enumeration&gt; &lt;enumeration value="0220006"&gt;   &lt;annotation&gt;     &lt;documentation&gt;2-Inzisionen-Zugang&lt;/documentation&gt;   &lt;/annotation&gt; &lt;/enumeration&gt; &lt;enumeration value="0220042"&gt;   &lt;annotation&gt;     &lt;documentation&gt;sonstiges/unbekannt&lt;/documentation&gt;   &lt;/annotation&gt; &lt;/enumeration&gt; &lt;/restriction&gt; &lt;/simpleType&gt; </pre>
--	---

### simpleType enum\_0222

namespace	http://xml.ir-d.de/irdsaa		
type	restriction of <b>string</b>		
properties	base xs:string		
facets	Kind	Value	Annotation
	enumeration	0222001	documentation nein
	enumeration	0222002	documentation ja- Ausbau
	enumeration	0222003	documentation ja- Einbau
annotation	documentation Kat_EP_Zweizeitwechsel		
source	<pre> &lt;simpleType name="enum_0222"&gt;   &lt;annotation&gt;     &lt;documentation&gt;Kat_EP_Zweizeitwechsel&lt;/documentation&gt;   &lt;/annotation&gt;   &lt;restriction base="xs:string"&gt;     &lt;enumeration value="0222001"&gt;       &lt;annotation&gt;         &lt;documentation&gt;nein&lt;/documentation&gt;       &lt;/annotation&gt;     &lt;/enumeration&gt;     &lt;enumeration value="0222002"&gt;       &lt;annotation&gt;         &lt;documentation&gt;ja- Ausbau&lt;/documentation&gt;       &lt;/annotation&gt;     &lt;/enumeration&gt;   &lt;/restriction&gt; &lt;/simpleType&gt; </pre>		

```

<enumeration value="0222003">
  <annotation>
    <documentation>ja- Einbau</documentation>
  </annotation>
</enumeration>
</restriction>
</simpleType>

```

### simpleType enum\_0230

namespace	http://xml.ir-d.de/irdsaa		
type	restriction of <b>string</b>		
properties	base xs:string		
facets	Kind	Value	Annotation
	enumeration	0230001	documentation Smith & Nephew GmbH
	enumeration	0230002	documentation Mathys Orthopädie GmbH
	enumeration	0230003	documentation Ceramtec AG
	enumeration	0230004	documentation Biomet
	enumeration	0230005	documentation Peter Brehm GmbH
	enumeration	0230006	documentation Amplitude GmbH
	enumeration	0230007	documentation Exactech Deutschland
	enumeration	0230008	documentation Globus Medical
	enumeration	0230009	documentation Implantcast GmbH
	enumeration	0230010	documentation DePuy Orthopädie GmbH (J&J)
	enumeration	0230011	documentation IO-International Orthopaedics
	enumeration	0230012	documentation Joint Replacement Ltd. Instrumentation
	enumeration	0230013	documentation Merete
	enumeration	0230014	documentation S&G Implants GmbH
	enumeration	0230015	documentation Speetec Implantate GmbH
	enumeration	0230016	documentation Stemcup Medical Products GmbH
	enumeration	0230017	documentation Symbios Deutschland GmbH
	enumeration	0230018	documentation Tantum AG
	enumeration	0230019	documentation Tornier GmbH
	enumeration	0230020	documentation MicroPort Orthopedics GmbH
	enumeration	0230021	documentation aap Implanate AG
	enumeration	0230022	documentation AQImplants
	enumeration	0230023	documentation ESKA Orthodynamics GmbH
	enumeration	0230024	documentation

	enumeration	0230025	Atecos medical AG documentation
	enumeration	0230026	Chiropro GmbH documentation
	enumeration	0230027	Medacta documentation
	enumeration	0230028	OHST Medizintechnik AG documentation
	enumeration	0230029	Lima Deutschland GmbH documentation
	enumeration	0230030	alloPlus GmbH documentation
	enumeration	0230031	Heraeus Medical GmbH documentation
	enumeration	0230032	ImplanTec Deutschland GmbH documentation
	enumeration	0230033	Falcon Medical GmbH documentation
	enumeration	0230034	Meril GmbH documentation
	enumeration	0230035	Zimmer Germany GmbH documentation
	enumeration	0230036	Stryker GmbH & Co. KG documentation
	enumeration	0230037	Aesculap AG documentation
	enumeration	0230038	Waldemar Link GmbH & Co. KG documentation
	enumeration	0230039	Corin Germany GmbH documentation
	enumeration	0230040	ARTIQO documentation
	enumeration	0230041	EuromedImplants documentation
	enumeration	0230042	EvolutisGroup documentation
	enumeration	0230043	sonstige documentation
	enumeration	0230044	TEKNIMED SAS documentation
	enumeration	0230045	HiPer Medical AG documentation
	enumeration	0230046	Link Italia S.p.A. documentation
	enumeration	0230047	Johnson & Johnson Medical GmbH documentation
	enumeration	0230048	MatOrtho Limited documentation
	enumeration	0230049	Adler Ortho S.P.A. documentation
	enumeration	0230050	Lincotek Bologna SRL documentation
	enumeration	0230051	Materialise documentation
	enumeration	0230052	Maxx Orthopedics Inc. documentation
	enumeration	0230053	JRI Orthopaedics documentation
	enumeration	0230054	nicht belegter Wert documentation
	enumeration	0230055	nicht belegter Wert documentation
	enumeration	0230056	nicht belegter Wert documentation

	<p>enumeration 0230057 documentation nicht belegter Wert</p> <p>enumeration 0230058 documentation nicht belegter Wert</p> <p>enumeration 0230059 documentation nicht belegter Wert</p>
annotation	documentation Kat_EP_Hersteller
source	<pre> &lt;simpleType name="enum_0230"&gt;   &lt;annotation&gt;     &lt;documentation&gt;Kat_EP_Hersteller&lt;/documentation&gt;   &lt;/annotation&gt;   &lt;restriction base="xs:string"&gt;     &lt;enumeration value="0230001"&gt;       &lt;annotation&gt;         &lt;documentation&gt;Smith &amp; Nephew GmbH&lt;/documentation&gt;       &lt;/annotation&gt;     &lt;/enumeration&gt;     &lt;enumeration value="0230002"&gt;       &lt;annotation&gt;         &lt;documentation&gt;Mathys Orthopädie GmbH&lt;/documentation&gt;       &lt;/annotation&gt;     &lt;/enumeration&gt;     &lt;enumeration value="0230003"&gt;       &lt;annotation&gt;         &lt;documentation&gt;Ceramtec AG&lt;/documentation&gt;       &lt;/annotation&gt;     &lt;/enumeration&gt;     &lt;enumeration value="0230004"&gt;       &lt;annotation&gt;         &lt;documentation&gt;Biomet&lt;/documentation&gt;       &lt;/annotation&gt;     &lt;/enumeration&gt;     &lt;enumeration value="0230005"&gt;       &lt;annotation&gt;         &lt;documentation&gt;Peter Brehm GmbH&lt;/documentation&gt;       &lt;/annotation&gt;     &lt;/enumeration&gt;     &lt;enumeration value="0230006"&gt;       &lt;annotation&gt;         &lt;documentation&gt;Amplitude GmbH&lt;/documentation&gt;       &lt;/annotation&gt;     &lt;/enumeration&gt;     &lt;enumeration value="0230007"&gt;       &lt;annotation&gt;         &lt;documentation&gt;Exactech Deutschland&lt;/documentation&gt;       &lt;/annotation&gt;     &lt;/enumeration&gt;     &lt;enumeration value="0230008"&gt;       &lt;annotation&gt;         &lt;documentation&gt;Globus Medical&lt;/documentation&gt;       &lt;/annotation&gt;     &lt;/enumeration&gt;     &lt;enumeration value="0230009"&gt;       &lt;annotation&gt;         &lt;documentation&gt;Implantcast GmbH&lt;/documentation&gt;       &lt;/annotation&gt;     &lt;/enumeration&gt;     &lt;enumeration value="0230010"&gt; </pre>

```
<annotation>
  <documentation>DePuy Orthopädie GmbH (J&J)</documentation>
</annotation>
</enumeration>
<enumeration value="0230011">
  <annotation>
    <documentation>IO-International Orthopaedics</documentation>
  </annotation>
</enumeration>
<enumeration value="0230012">
  <annotation>
    <documentation>Joint Replacement Ltd. Instrumentation</documentation>
  </annotation>
</enumeration>
<enumeration value="0230013">
  <annotation>
    <documentation>Merete</documentation>
  </annotation>
</enumeration>
<enumeration value="0230014">
  <annotation>
    <documentation>S&G Implants GmbH</documentation>
  </annotation>
</enumeration>
<enumeration value="0230015">
  <annotation>
    <documentation>Speetec Implantate GmbH</documentation>
  </annotation>
</enumeration>
<enumeration value="0230016">
  <annotation>
    <documentation>Stemcup Medical Products GmbH</documentation>
  </annotation>
</enumeration>
<enumeration value="0230017">
  <annotation>
    <documentation>Symbios Deutschland GmbH</documentation>
  </annotation>
</enumeration>
<enumeration value="0230018">
  <annotation>
    <documentation>Tantum AG</documentation>
  </annotation>
</enumeration>
<enumeration value="0230019">
  <annotation>
    <documentation>Tornier GmbH</documentation>
  </annotation>
</enumeration>
<enumeration value="0230020">
  <annotation>
    <documentation>MicroPort Orthopedics GmbH</documentation>
  </annotation>
</enumeration>
<enumeration value="0230021">
  <annotation>
    <documentation>aap Implanate AG</documentation>
  </annotation>
</enumeration>
```



```
<enumeration value="0230022">
  <annotation>
    <documentation>AQImplants</documentation>
  </annotation>
</enumeration>
<enumeration value="0230023">
  <annotation>
    <documentation>ESKA Orthodynamics GmbH</documentation>
  </annotation>
</enumeration>
<enumeration value="0230024">
  <annotation>
    <documentation>Ateos medical AG</documentation>
  </annotation>
</enumeration>
<enumeration value="0230025">
  <annotation>
    <documentation>Chiropro GmbH</documentation>
  </annotation>
</enumeration>
<enumeration value="0230026">
  <annotation>
    <documentation>Medacta</documentation>
  </annotation>
</enumeration>
<enumeration value="0230027">
  <annotation>
    <documentation>OHST Medizintechnik AG</documentation>
  </annotation>
</enumeration>
<enumeration value="0230028">
  <annotation>
    <documentation>Lima Deutschland GmbH</documentation>
  </annotation>
</enumeration>
<enumeration value="0230029">
  <annotation>
    <documentation>alloPlus GmbH</documentation>
  </annotation>
</enumeration>
<enumeration value="0230030">
  <annotation>
    <documentation>Heraeus Medical GmbH</documentation>
  </annotation>
</enumeration>
<enumeration value="0230031">
  <annotation>
    <documentation>ImplanTec Deutschland GmbH</documentation>
  </annotation>
</enumeration>
<enumeration value="0230032">
  <annotation>
    <documentation>Falcon Medical GmbH</documentation>
  </annotation>
</enumeration>
<enumeration value="0230033">
  <annotation>
    <documentation>Meril GmbH</documentation>
  </annotation>
</enumeration>
```

```
</enumeration>
<enumeration value="0230034">
  <annotation>
    <documentation>Zimmer Germany GmbH</documentation>
  </annotation>
</enumeration>
<enumeration value="0230035">
  <annotation>
    <documentation>Stryker GmbH & Co. KG</documentation>
  </annotation>
</enumeration>
<enumeration value="0230036">
  <annotation>
    <documentation>Aesculap AG</documentation>
  </annotation>
</enumeration>
<enumeration value="0230037">
  <annotation>
    <documentation>Waldemar Link GmbH & Co. KG</documentation>
  </annotation>
</enumeration>
<enumeration value="0230038">
  <annotation>
    <documentation>Corin Germany GmbH</documentation>
  </annotation>
</enumeration>
<enumeration value="0230039">
  <annotation>
    <documentation>ARTIQO</documentation>
  </annotation>
</enumeration>
<enumeration value="0230040">
  <annotation>
    <documentation>EuromedImplants</documentation>
  </annotation>
</enumeration>
<enumeration value="0230041">
  <annotation>
    <documentation>EvolutisGroup</documentation>
  </annotation>
</enumeration>
<enumeration value="0230042">
  <annotation>
    <documentation>sonstige</documentation>
  </annotation>
</enumeration>
<enumeration value="0230043">
  <annotation>
    <documentation>TEKNIMED SAS</documentation>
  </annotation>
</enumeration>
<enumeration value="0230044">
  <annotation>
    <documentation>HiPer Medical AG</documentation>
  </annotation>
</enumeration>
<enumeration value="0230045">
  <annotation>
    <documentation>Link Italia S.p.A.</documentation>
  </annotation>
</enumeration>
```

```
</annotation>
</enumeration>
<enumeration value="0230046">
  <annotation>
    <documentation>Johnson & Johnson Medical GmbH</documentation>
  </annotation>
</enumeration>
<enumeration value="0230047">
  <annotation>
    <documentation>MatOrtho Limited</documentation>
  </annotation>
</enumeration>
<enumeration value="0230048">
  <annotation>
    <documentation>Adler Ortho S.P.A.</documentation>
  </annotation>
</enumeration>
<enumeration value="0230049">
  <annotation>
    <documentation>Lincotek Bologna SRL</documentation>
  </annotation>
</enumeration>
<enumeration value="0230050">
  <annotation>
    <documentation>Materialise</documentation>
  </annotation>
</enumeration>
<enumeration value="0230051">
  <annotation>
    <documentation>Maxx Orthopedics Inc.</documentation>
  </annotation>
</enumeration>
<enumeration value="0230052">
  <annotation>
    <documentation>JRI Orthopaedics</documentation>
  </annotation>
</enumeration>
<enumeration value="0230053">
  <annotation>
    <documentation>nicht belegter Wert</documentation>
  </annotation>
</enumeration>
<enumeration value="0230054">
  <annotation>
    <documentation>nicht belegter Wert</documentation>
  </annotation>
</enumeration>
<enumeration value="0230055">
  <annotation>
    <documentation>nicht belegter Wert</documentation>
  </annotation>
</enumeration>
<enumeration value="0230056">
  <annotation>
    <documentation>nicht belegter Wert</documentation>
  </annotation>
</enumeration>
<enumeration value="0230057">
  <annotation>
```

	<pre>       &lt;documentation&gt;nicht belegter Wert&lt;/documentation&gt;     &lt;/annotation&gt;   &lt;/enumeration&gt; &lt;enumeration value="0230058"&gt;   &lt;annotation&gt;     &lt;documentation&gt;nicht belegter Wert&lt;/documentation&gt;   &lt;/annotation&gt; &lt;/enumeration&gt; &lt;enumeration value="0230059"&gt;   &lt;annotation&gt;     &lt;documentation&gt;nicht belegter Wert&lt;/documentation&gt;   &lt;/annotation&gt; &lt;/enumeration&gt; &lt;/restriction&gt; &lt;/simpleType&gt; </pre>
--	---

### simpleType enum 0252

namespace	http://xml.ir-d.de/irdsaa		
type	restriction of <b>string</b>		
properties	base xs:string		
facets	Kind	Value	Annotation
	enumeration	0252001	documentation Pfanne
	enumeration	0252002	documentation Schaft
	enumeration	0252003	documentation beides
annotation	documentation Kat_EP_KomponenteHuefte		
source	<pre> &lt;simpleType name="enum_0252"&gt;   &lt;annotation&gt;     &lt;documentation&gt;Kat_EP_KomponenteHuefte&lt;/documentation&gt;   &lt;/annotation&gt;   &lt;restriction base="xs:string"&gt;     &lt;enumeration value="0252001"&gt;       &lt;annotation&gt;         &lt;documentation&gt;Pfanne&lt;/documentation&gt;       &lt;/annotation&gt;     &lt;/enumeration&gt;     &lt;enumeration value="0252002"&gt;       &lt;annotation&gt;         &lt;documentation&gt;Schaft&lt;/documentation&gt;       &lt;/annotation&gt;     &lt;/enumeration&gt;     &lt;enumeration value="0252003"&gt;       &lt;annotation&gt;         &lt;documentation&gt;beides&lt;/documentation&gt;       &lt;/annotation&gt;     &lt;/enumeration&gt;   &lt;/restriction&gt; &lt;/simpleType&gt; </pre>		

### simpleType enum\_0254

namespace	http://xml.ir-d.de/irdsaa		
type	restriction of <b>string</b>		
properties	base xs:string		
facets	Kind	Value	Annotation
	enumeration	0254001	documentation Femur
	enumeration	0254002	documentation Tibia
	enumeration	0254003	documentation Patella
	enumeration	0254004	documentation mehrere
annotation	documentation Kat_EP_KomponenteKnie		
source	<pre> &lt;simpleType name="enum_0254"&gt;   &lt;annotation&gt;     &lt;documentation&gt;Kat_EP_KomponenteKnie&lt;/documentation&gt;   &lt;/annotation&gt;   &lt;restriction base="xs:string"&gt;     &lt;enumeration value="0254001"&gt;       &lt;annotation&gt;         &lt;documentation&gt;Femur&lt;/documentation&gt;       &lt;/annotation&gt;     &lt;/enumeration&gt;     &lt;enumeration value="0254002"&gt;       &lt;annotation&gt;         &lt;documentation&gt;Tibia&lt;/documentation&gt;       &lt;/annotation&gt;     &lt;/enumeration&gt;     &lt;enumeration value="0254003"&gt;       &lt;annotation&gt;         &lt;documentation&gt;Patella&lt;/documentation&gt;       &lt;/annotation&gt;     &lt;/enumeration&gt;     &lt;enumeration value="0254004"&gt;       &lt;annotation&gt;         &lt;documentation&gt;mehrere&lt;/documentation&gt;       &lt;/annotation&gt;     &lt;/enumeration&gt;   &lt;/restriction&gt; &lt;/simpleType&gt; </pre>		

### simpleType enum\_0256

namespace	http://xml.ir-d.de/irdsaa		
type	restriction of <b>string</b>		
properties	base xs:string		
facets	Kind	Value	Annotation
	enumeration	0256001	documentation Pfanne
	enumeration	0256002	documentation Schaft
	enumeration	0256003	documentation Pfanne und Schaft
	enumeration	0256004	documentation

	<p>enumeration 0256005 Femur documentation Tibia</p> <p>enumeration 0256006 documentation Patella</p> <p>enumeration 0256007 documentation mehrere</p>
annotation	documentation Kat_EP_KomponenteTFE
source	<pre> &lt;simpleType name="enum_0256"&gt;   &lt;annotation&gt;     &lt;documentation&gt;Kat_EP_KomponenteTFE&lt;/documentation&gt;   &lt;/annotation&gt;   &lt;restriction base="xs:string"&gt;     &lt;enumeration value="0256001"&gt;       &lt;annotation&gt;         &lt;documentation&gt;Pfanne&lt;/documentation&gt;       &lt;/annotation&gt;     &lt;/enumeration&gt;     &lt;enumeration value="0256002"&gt;       &lt;annotation&gt;         &lt;documentation&gt;Schaft&lt;/documentation&gt;       &lt;/annotation&gt;     &lt;/enumeration&gt;     &lt;enumeration value="0256003"&gt;       &lt;annotation&gt;         &lt;documentation&gt;Pfanne und Schaft&lt;/documentation&gt;       &lt;/annotation&gt;     &lt;/enumeration&gt;     &lt;enumeration value="0256004"&gt;       &lt;annotation&gt;         &lt;documentation&gt;Femur&lt;/documentation&gt;       &lt;/annotation&gt;     &lt;/enumeration&gt;     &lt;enumeration value="0256005"&gt;       &lt;annotation&gt;         &lt;documentation&gt;Tibia&lt;/documentation&gt;       &lt;/annotation&gt;     &lt;/enumeration&gt;     &lt;enumeration value="0256006"&gt;       &lt;annotation&gt;         &lt;documentation&gt;Patella&lt;/documentation&gt;       &lt;/annotation&gt;     &lt;/enumeration&gt;     &lt;enumeration value="0256007"&gt;       &lt;annotation&gt;         &lt;documentation&gt;mehrere&lt;/documentation&gt;       &lt;/annotation&gt;     &lt;/enumeration&gt;   &lt;/restriction&gt; &lt;/simpleType&gt; </pre>

### simpleType enum\_0262

namespace	http://xml.ir-d.de/irdsaa
type	restriction of <b>string</b>
properties	base xs:string

facets	<table border="1"> <thead> <tr> <th>Kind</th> <th>Value</th> <th>Annotation</th> </tr> </thead> <tbody> <tr> <td>enumeration</td> <td>0262001</td> <td>documentation Pfanne</td> </tr> <tr> <td>enumeration</td> <td>0262002</td> <td>documentation Schaft</td> </tr> <tr> <td>enumeration</td> <td>0262003</td> <td>documentation Kopf</td> </tr> <tr> <td>enumeration</td> <td>0262004</td> <td>documentation Inlay</td> </tr> <tr> <td>enumeration</td> <td>0262005</td> <td>documentation Adapter</td> </tr> <tr> <td>enumeration</td> <td>0262006</td> <td>documentation mehrere</td> </tr> </tbody> </table>	Kind	Value	Annotation	enumeration	0262001	documentation Pfanne	enumeration	0262002	documentation Schaft	enumeration	0262003	documentation Kopf	enumeration	0262004	documentation Inlay	enumeration	0262005	documentation Adapter	enumeration	0262006	documentation mehrere
Kind	Value	Annotation																				
enumeration	0262001	documentation Pfanne																				
enumeration	0262002	documentation Schaft																				
enumeration	0262003	documentation Kopf																				
enumeration	0262004	documentation Inlay																				
enumeration	0262005	documentation Adapter																				
enumeration	0262006	documentation mehrere																				
annotation	documentation Kat_EP_ImplantatbruchHuefte																					
source	<pre> &lt;simpleType name="enum_0262"&gt;   &lt;annotation&gt;     &lt;documentation&gt;Kat_EP_ImplantatbruchHuefte&lt;/documentation&gt;   &lt;/annotation&gt;   &lt;restriction base="xs:string"&gt;     &lt;enumeration value="0262001"&gt;       &lt;annotation&gt;         &lt;documentation&gt;Pfanne&lt;/documentation&gt;       &lt;/annotation&gt;     &lt;/enumeration&gt;     &lt;enumeration value="0262002"&gt;       &lt;annotation&gt;         &lt;documentation&gt;Schaft&lt;/documentation&gt;       &lt;/annotation&gt;     &lt;/enumeration&gt;     &lt;enumeration value="0262003"&gt;       &lt;annotation&gt;         &lt;documentation&gt;Kopf&lt;/documentation&gt;       &lt;/annotation&gt;     &lt;/enumeration&gt;     &lt;enumeration value="0262004"&gt;       &lt;annotation&gt;         &lt;documentation&gt;Inlay&lt;/documentation&gt;       &lt;/annotation&gt;     &lt;/enumeration&gt;     &lt;enumeration value="0262005"&gt;       &lt;annotation&gt;         &lt;documentation&gt;Adapter&lt;/documentation&gt;       &lt;/annotation&gt;     &lt;/enumeration&gt;     &lt;enumeration value="0262006"&gt;       &lt;annotation&gt;         &lt;documentation&gt;mehrere&lt;/documentation&gt;       &lt;/annotation&gt;     &lt;/enumeration&gt;   &lt;/restriction&gt; &lt;/simpleType&gt; </pre>																					

### simpleType enum\_0264

namespace	http://xml.ir-d.de/irdsaa
type	restriction of <b>string</b>

properties	base xs:string																											
facets	<table border="1"> <thead> <tr> <th>Kind</th> <th>Value</th> <th>Annotation</th> </tr> </thead> <tbody> <tr> <td>enumeration</td> <td>0264001</td> <td>documentation Femur</td> </tr> <tr> <td>enumeration</td> <td>0264002</td> <td>documentation Tibia</td> </tr> <tr> <td>enumeration</td> <td>0264003</td> <td>documentation Inlay</td> </tr> <tr> <td>enumeration</td> <td>0264004</td> <td>documentation Adapter</td> </tr> <tr> <td>enumeration</td> <td>0264005</td> <td>documentation Verlängerung</td> </tr> <tr> <td>enumeration</td> <td>0264006</td> <td>documentation Schrauben</td> </tr> <tr> <td>enumeration</td> <td>0264007</td> <td>documentation mehrere</td> </tr> <tr> <td>enumeration</td> <td>0264042</td> <td>documentation andere</td> </tr> </tbody> </table>	Kind	Value	Annotation	enumeration	0264001	documentation Femur	enumeration	0264002	documentation Tibia	enumeration	0264003	documentation Inlay	enumeration	0264004	documentation Adapter	enumeration	0264005	documentation Verlängerung	enumeration	0264006	documentation Schrauben	enumeration	0264007	documentation mehrere	enumeration	0264042	documentation andere
Kind	Value	Annotation																										
enumeration	0264001	documentation Femur																										
enumeration	0264002	documentation Tibia																										
enumeration	0264003	documentation Inlay																										
enumeration	0264004	documentation Adapter																										
enumeration	0264005	documentation Verlängerung																										
enumeration	0264006	documentation Schrauben																										
enumeration	0264007	documentation mehrere																										
enumeration	0264042	documentation andere																										
annotation	documentation Kat_EP_ImplantatbruchKnie																											
source	<pre> &lt;simpleType name="enum_0264"&gt;   &lt;annotation&gt;     &lt;documentation&gt;Kat_EP_ImplantatbruchKnie&lt;/documentation&gt;   &lt;/annotation&gt;   &lt;restriction base="xs:string"&gt;     &lt;enumeration value="0264001"&gt;       &lt;annotation&gt;         &lt;documentation&gt;Femur&lt;/documentation&gt;       &lt;/annotation&gt;     &lt;/enumeration&gt;     &lt;enumeration value="0264002"&gt;       &lt;annotation&gt;         &lt;documentation&gt;Tibia&lt;/documentation&gt;       &lt;/annotation&gt;     &lt;/enumeration&gt;     &lt;enumeration value="0264003"&gt;       &lt;annotation&gt;         &lt;documentation&gt;Inlay&lt;/documentation&gt;       &lt;/annotation&gt;     &lt;/enumeration&gt;     &lt;enumeration value="0264004"&gt;       &lt;annotation&gt;         &lt;documentation&gt;Adapter&lt;/documentation&gt;       &lt;/annotation&gt;     &lt;/enumeration&gt;     &lt;enumeration value="0264005"&gt;       &lt;annotation&gt;         &lt;documentation&gt;Verlängerung&lt;/documentation&gt;       &lt;/annotation&gt;     &lt;/enumeration&gt;     &lt;enumeration value="0264006"&gt;       &lt;annotation&gt;         &lt;documentation&gt;Schrauben&lt;/documentation&gt;       &lt;/annotation&gt;     &lt;/enumeration&gt;     &lt;enumeration value="0264007"&gt;       &lt;annotation&gt;         &lt;documentation&gt;mehrere&lt;/documentation&gt;       &lt;/annotation&gt;     &lt;/enumeration&gt;   &lt;/restriction&gt; &lt;/simpleType&gt; </pre>																											



	<pre> &lt;enumeration value="0264042"&gt;   &lt;annotation&gt;     &lt;documentation&gt;andere&lt;/documentation&gt;   &lt;/annotation&gt; &lt;/enumeration&gt; &lt;/restriction&gt; &lt;/simpleType&gt; </pre>
--	---

### simpleType enum\_0266

namespace	http://xml.ir-d.de/irdsaa		
type	restriction of <b>string</b>		
properties	base xs:string		
facets	Kind	Value	Annotation
	enumeration	0266001	documentation Pfanne
	enumeration	0266002	documentation Schaft
	enumeration	0266003	documentation Kopf
	enumeration	0266004	documentation Inlay
	enumeration	0266005	documentation Adapter
	enumeration	0266006	documentation Femur
	enumeration	0266007	documentation Tibia
	enumeration	0266008	documentation Verlängerung
	enumeration	0266009	documentation Schrauben
	enumeration	0266010	documentation mehrere
	enumeration	0266042	documentation andere
annotation	documentation Kat_EP_ImplantatbruchTFE		
source	<pre> &lt;simpleType name="enum_0266"&gt;   &lt;annotation&gt;     &lt;documentation&gt;Kat_EP_ImplantatbruchTFE&lt;/documentation&gt;   &lt;/annotation&gt;   &lt;restriction base="xs:string"&gt;     &lt;enumeration value="0266001"&gt;       &lt;annotation&gt;         &lt;documentation&gt;Pfanne&lt;/documentation&gt;       &lt;/annotation&gt;     &lt;/enumeration&gt;     &lt;enumeration value="0266002"&gt;       &lt;annotation&gt;         &lt;documentation&gt;Schaft&lt;/documentation&gt;       &lt;/annotation&gt;     &lt;/enumeration&gt;     &lt;enumeration value="0266003"&gt;       &lt;annotation&gt;         &lt;documentation&gt;Kopf&lt;/documentation&gt;       &lt;/annotation&gt;     &lt;/enumeration&gt;   &lt;/restriction&gt; &lt;/simpleType&gt; </pre>		

```

<enumeration value="0266004">
  <annotation>
    <documentation>Inlay</documentation>
  </annotation>
</enumeration>
<enumeration value="0266005">
  <annotation>
    <documentation>Adapter</documentation>
  </annotation>
</enumeration>
<enumeration value="0266006">
  <annotation>
    <documentation>Femur</documentation>
  </annotation>
</enumeration>
<enumeration value="0266007">
  <annotation>
    <documentation>Tibia</documentation>
  </annotation>
</enumeration>
<enumeration value="0266008">
  <annotation>
    <documentation>Verlängerung</documentation>
  </annotation>
</enumeration>
<enumeration value="0266009">
  <annotation>
    <documentation>Schrauben</documentation>
  </annotation>
</enumeration>
<enumeration value="0266010">
  <annotation>
    <documentation>mehrere</documentation>
  </annotation>
</enumeration>
<enumeration value="0266042">
  <annotation>
    <documentation>andere</documentation>
  </annotation>
</enumeration>
</restriction>
</simpleType>

```

### simpleType enum\_0270

namespace	http://xml.ir-d.de/irdsaa		
type	restriction of <b>string</b>		
properties	base xs:string		
facets	Kind	Value	Annotation
	enumeration	0270001	documentation PE-Inlay
	enumeration	0270002	documentation patellare Komponente
	enumeration	0270003	documentation beides
annotation	documentation Kat_EP_VerschleissKnie		

source	<pre> &lt;simpleType name="enum_0270"&gt;   &lt;annotation&gt;     &lt;documentation&gt;Kat_EP_VerschleissKnie&lt;/documentation&gt;   &lt;/annotation&gt;   &lt;restriction base="xs:string"&gt;     &lt;enumeration value="0270001"&gt;       &lt;annotation&gt;         &lt;documentation&gt;PE-Inlay&lt;/documentation&gt;       &lt;/annotation&gt;     &lt;/enumeration&gt;     &lt;enumeration value="0270002"&gt;       &lt;annotation&gt;         &lt;documentation&gt;patellare Komponente&lt;/documentation&gt;       &lt;/annotation&gt;     &lt;/enumeration&gt;     &lt;enumeration value="0270003"&gt;       &lt;annotation&gt;         &lt;documentation&gt;beides&lt;/documentation&gt;       &lt;/annotation&gt;     &lt;/enumeration&gt;   &lt;/restriction&gt; &lt;/simpleType&gt; </pre>
--------	---

### simpleType enum\_0271

namespace	http://xml.ir-d.de/irdsaa		
type	restriction of <b>string</b>		
properties	base xs:string		
facets	Kind	Value	Annotation
	enumeration	0271001	documentation Schraube
	enumeration	0271002	documentation Inlay
	enumeration	0271003	documentation patellare Komponente
	enumeration	0271004	documentation Kopplung
	enumeration	0271005	documentation mehrere
	enumeration	0271042	documentation andere
annotation	documentation Kat_EP_MigrationKnie		
source	<pre> &lt;simpleType name="enum_0271"&gt;   &lt;annotation&gt;     &lt;documentation&gt;Kat_EP_MigrationKnie&lt;/documentation&gt;   &lt;/annotation&gt;   &lt;restriction base="xs:string"&gt;     &lt;enumeration value="0271001"&gt;       &lt;annotation&gt;         &lt;documentation&gt;Schraube&lt;/documentation&gt;       &lt;/annotation&gt;     &lt;/enumeration&gt;     &lt;enumeration value="0271002"&gt;       &lt;annotation&gt;         &lt;documentation&gt;Inlay&lt;/documentation&gt;       &lt;/annotation&gt;     &lt;/enumeration&gt;   &lt;/restriction&gt; &lt;/simpleType&gt; </pre>		

	<pre> &lt;/enumeration&gt; &lt;enumeration value="0271003"&gt;   &lt;annotation&gt;     &lt;documentation&gt;patellare Komponente&lt;/documentation&gt;   &lt;/annotation&gt; &lt;/enumeration&gt; &lt;enumeration value="0271004"&gt;   &lt;annotation&gt;     &lt;documentation&gt;Kopplung&lt;/documentation&gt;   &lt;/annotation&gt; &lt;/enumeration&gt; &lt;enumeration value="0271005"&gt;   &lt;annotation&gt;     &lt;documentation&gt;mehrere&lt;/documentation&gt;   &lt;/annotation&gt; &lt;/enumeration&gt; &lt;enumeration value="0271042"&gt;   &lt;annotation&gt;     &lt;documentation&gt;andere&lt;/documentation&gt;   &lt;/annotation&gt; &lt;/enumeration&gt; &lt;/restriction&gt; &lt;/simpleType&gt; </pre>
--	---

### simpleType enum\_0290

namespace	http://xml.ir-d.de/irdsaa		
type	restriction of <b>string</b>		
properties	base xs:string		
facets	Kind	Value	Annotation
	enumeration	0290001	documentation Hüft-Komponente
	enumeration	0290002	documentation Knie-Komponente
	enumeration	0290003	documentation Modulare Komponente (Hüfte/Knie)
annotation	documentation Kat EP Artikeltyp		
source	<pre> &lt;simpleType name="enum_0290"&gt;   &lt;annotation&gt;     &lt;documentation&gt;Kat_EP_Artikeltyp&lt;/documentation&gt;   &lt;/annotation&gt;   &lt;restriction base="xs:string"&gt;     &lt;enumeration value="0290001"&gt;       &lt;annotation&gt;         &lt;documentation&gt;Hüft-Komponente&lt;/documentation&gt;       &lt;/annotation&gt;     &lt;/enumeration&gt;     &lt;enumeration value="0290002"&gt;       &lt;annotation&gt;         &lt;documentation&gt;Knie-Komponente&lt;/documentation&gt;       &lt;/annotation&gt;     &lt;/enumeration&gt;     &lt;enumeration value="0290003"&gt;       &lt;annotation&gt;         &lt;documentation&gt;Modulare Komponente (Hüfte/Knie)&lt;/documentation&gt;       &lt;/annotation&gt;     &lt;/enumeration&gt;   &lt;/restriction&gt; &lt;/simpleType&gt; </pre>		

	<pre> &lt;/enumeration&gt; &lt;/restriction&gt; &lt;/simpleType&gt; </pre>
--	--

### simpleType enum\_0291

namespace	http://xml.ir-d.de/irdsaa		
type	restriction of <b>string</b>		
properties	base xs:string		
facets	Kind	Value	Annotation
	enumeration	0291001	documentation Knochen-Zement
	enumeration	0291002	documentation sonstiges Zubehör
annotation	documentation Kat_EP_ZubehoerTyp		
source	<pre> &lt;simpleType name="enum_0291"&gt;   &lt;annotation&gt;     &lt;documentation&gt;Kat_EP_ZubehoerTyp&lt;/documentation&gt;   &lt;/annotation&gt;   &lt;restriction base="xs:string"&gt;     &lt;enumeration value="0291001"&gt;       &lt;annotation&gt;         &lt;documentation&gt;Knochen-Zement&lt;/documentation&gt;       &lt;/annotation&gt;     &lt;/enumeration&gt;     &lt;enumeration value="0291002"&gt;       &lt;annotation&gt;         &lt;documentation&gt;sonstiges Zubehör&lt;/documentation&gt;       &lt;/annotation&gt;     &lt;/enumeration&gt;   &lt;/restriction&gt; &lt;/simpleType&gt; </pre>		

### simpleType enum\_0300

namespace	http://xml.ir-d.de/irdsaa		
type	restriction of <b>string</b>		
properties	base xs:string		
facets	Kind	Value	Annotation
	enumeration	0300001	documentation konventioneller Aortenklappenersatz
	enumeration	0300002	documentation kathetergestützte Aortenklappenimplantation (TAVI)
annotation	documentation Kat_AK_ArtEingriff		
source	<pre> &lt;simpleType name="enum_0300"&gt;   &lt;annotation&gt;     &lt;documentation&gt;Kat_AK_ArtEingriff&lt;/documentation&gt;   &lt;/annotation&gt;   &lt;restriction base="xs:string"&gt;     &lt;enumeration value="0300001"&gt;       &lt;annotation&gt;         &lt;documentation&gt;konventioneller Aortenklappenersatz&lt;/documentation&gt;       &lt;/annotation&gt;     &lt;/enumeration&gt;   &lt;/restriction&gt; &lt;/simpleType&gt; </pre>		

	<pre> &lt;/annotation&gt; &lt;/enumeration&gt; &lt;enumeration value="0300002"&gt;   &lt;annotation&gt;     &lt;documentation&gt;kathetergestützte Aortenklappenimplantation (TAVI)&lt;/documentation&gt;   &lt;/annotation&gt; &lt;/enumeration&gt; &lt;/restriction&gt; &lt;/simpleType&gt; </pre>
--	--

### simpleType enum\_0302

namespace	http://xml.ir-d.de/irdsaa		
type	restriction of <b>string</b>		
properties	base xs:string		
facets	Kind	Value	Annotation
	enumeration	0302001	documentation Stenose
	enumeration	0302002	documentation Insuffizienz
	enumeration	0302003	documentation Stenose und Insuffizienz
annotation	documentation Kat_AK_GrundEingriff		
source	<pre> &lt;simpleType name="enum_0302"&gt;   &lt;annotation&gt;     &lt;documentation&gt;Kat_AK_GrundEingriff&lt;/documentation&gt;   &lt;/annotation&gt;   &lt;restriction base="xs:string"&gt;     &lt;enumeration value="0302001"&gt;       &lt;annotation&gt;         &lt;documentation&gt;Stenose&lt;/documentation&gt;       &lt;/annotation&gt;     &lt;/enumeration&gt;     &lt;enumeration value="0302002"&gt;       &lt;annotation&gt;         &lt;documentation&gt;Insuffizienz&lt;/documentation&gt;       &lt;/annotation&gt;     &lt;/enumeration&gt;     &lt;enumeration value="0302003"&gt;       &lt;annotation&gt;         &lt;documentation&gt;Stenose und Insuffizienz&lt;/documentation&gt;       &lt;/annotation&gt;     &lt;/enumeration&gt;   &lt;/restriction&gt; &lt;/simpleType&gt; </pre>		

### simpleType enum\_0318

namespace	http://xml.ir-d.de/irdsaa		
type	restriction of <b>string</b>		
properties	base xs:string		

facets	<table border="1"> <thead> <tr> <th>Kind</th> <th>Value</th> <th>Annotation</th> </tr> </thead> <tbody> <tr> <td>enumeration</td> <td>0318001</td> <td>documentation transapikal</td> </tr> <tr> <td>enumeration</td> <td>0318002</td> <td>documentation transaortal</td> </tr> <tr> <td>enumeration</td> <td>0318003</td> <td>documentation transfemorale</td> </tr> <tr> <td>enumeration</td> <td>0318004</td> <td>documentation transaxillär</td> </tr> <tr> <td>enumeration</td> <td>0318042</td> <td>documentation anderer Zugangsweg</td> </tr> </tbody> </table>	Kind	Value	Annotation	enumeration	0318001	documentation transapikal	enumeration	0318002	documentation transaortal	enumeration	0318003	documentation transfemorale	enumeration	0318004	documentation transaxillär	enumeration	0318042	documentation anderer Zugangsweg
Kind	Value	Annotation																	
enumeration	0318001	documentation transapikal																	
enumeration	0318002	documentation transaortal																	
enumeration	0318003	documentation transfemorale																	
enumeration	0318004	documentation transaxillär																	
enumeration	0318042	documentation anderer Zugangsweg																	
annotation	documentation Kat_AK_ZugangKatheter																		
source	<pre> &lt;simpleType name="enum_0318"&gt;   &lt;annotation&gt;     &lt;documentation&gt;Kat_AK_ZugangKatheter&lt;/documentation&gt;   &lt;/annotation&gt;   &lt;restriction base="xs:string"&gt;     &lt;enumeration value="0318001"&gt;       &lt;annotation&gt;         &lt;documentation&gt;transapikal&lt;/documentation&gt;       &lt;/annotation&gt;     &lt;/enumeration&gt;     &lt;enumeration value="0318002"&gt;       &lt;annotation&gt;         &lt;documentation&gt;transaortal&lt;/documentation&gt;       &lt;/annotation&gt;     &lt;/enumeration&gt;     &lt;enumeration value="0318003"&gt;       &lt;annotation&gt;         &lt;documentation&gt;transfemorale&lt;/documentation&gt;       &lt;/annotation&gt;     &lt;/enumeration&gt;     &lt;enumeration value="0318004"&gt;       &lt;annotation&gt;         &lt;documentation&gt;transaxillär&lt;/documentation&gt;       &lt;/annotation&gt;     &lt;/enumeration&gt;     &lt;enumeration value="0318042"&gt;       &lt;annotation&gt;         &lt;documentation&gt;anderer Zugangsweg&lt;/documentation&gt;       &lt;/annotation&gt;     &lt;/enumeration&gt;   &lt;/restriction&gt; &lt;/simpleType&gt; </pre>																		

### simpleType enum\_0320

namespace	http://xml.ir-d.de/irdsaa												
type	restriction of <b>string</b>												
properties	base xs:string												
facets	<table border="1"> <thead> <tr> <th>Kind</th> <th>Value</th> <th>Annotation</th> </tr> </thead> <tbody> <tr> <td>enumeration</td> <td>0320001</td> <td>documentation konventionelle Sternotomie</td> </tr> <tr> <td>enumeration</td> <td>0320002</td> <td>documentation partielle Sternotomie</td> </tr> <tr> <td>enumeration</td> <td>0320003</td> <td>documentation parasternaler Zugang</td> </tr> </tbody> </table>	Kind	Value	Annotation	enumeration	0320001	documentation konventionelle Sternotomie	enumeration	0320002	documentation partielle Sternotomie	enumeration	0320003	documentation parasternaler Zugang
Kind	Value	Annotation											
enumeration	0320001	documentation konventionelle Sternotomie											
enumeration	0320002	documentation partielle Sternotomie											
enumeration	0320003	documentation parasternaler Zugang											

	enumeration 0320042 documentation anderer Zugangsweg
annotation	documentation Kat_AK_ZugangKonventionell
source	<pre> &lt;simpleType name="enum_0320"&gt;   &lt;annotation&gt;     &lt;documentation&gt;Kat_AK_ZugangKonventionell&lt;/documentation&gt;   &lt;/annotation&gt;   &lt;restriction base="xs:string"&gt;     &lt;enumeration value="0320001"&gt;       &lt;annotation&gt;         &lt;documentation&gt;konventionelle Sternotomie&lt;/documentation&gt;       &lt;/annotation&gt;     &lt;/enumeration&gt;     &lt;enumeration value="0320002"&gt;       &lt;annotation&gt;         &lt;documentation&gt;partielle Sternotomie&lt;/documentation&gt;       &lt;/annotation&gt;     &lt;/enumeration&gt;     &lt;enumeration value="0320003"&gt;       &lt;annotation&gt;         &lt;documentation&gt;parasternaler Zugang&lt;/documentation&gt;       &lt;/annotation&gt;     &lt;/enumeration&gt;     &lt;enumeration value="0320042"&gt;       &lt;annotation&gt;         &lt;documentation&gt;anderer Zugangsweg&lt;/documentation&gt;       &lt;/annotation&gt;     &lt;/enumeration&gt;   &lt;/restriction&gt; &lt;/simpleType&gt; </pre>

### simpleType enum\_0322

namespace	http://xml.ir-d.de/irdsaa		
type	restriction of <b>string</b>		
properties	base xs:string		
facets	Kind	Value	Annotation
	enumeration	0322001	documentation nein
	enumeration	0322002	documentation ja, diätetisch behandelt
	enumeration	0322003	documentation ja, orale Medikation
	enumeration	0322004	documentation ja, mit Insulin behandelt
	enumeration	0322005	documentation ja, unbehandelt
	enumeration	0322099	documentation unbekannt
annotation	documentation Kat_AK_Diabetes		
source	<pre> &lt;simpleType name="enum_0322"&gt;   &lt;annotation&gt;     &lt;documentation&gt;Kat_AK_Diabetes&lt;/documentation&gt;   &lt;/annotation&gt;   &lt;restriction base="xs:string"&gt; </pre>		



	<pre> &lt;enumeration value="0322001"&gt;   &lt;annotation&gt;     &lt;documentation&gt;nein&lt;/documentation&gt;   &lt;/annotation&gt; &lt;/enumeration&gt; &lt;enumeration value="0322002"&gt;   &lt;annotation&gt;     &lt;documentation&gt;ja, diätetisch behandelt&lt;/documentation&gt;   &lt;/annotation&gt; &lt;/enumeration&gt; &lt;enumeration value="0322003"&gt;   &lt;annotation&gt;     &lt;documentation&gt;ja, orale Medikation&lt;/documentation&gt;   &lt;/annotation&gt; &lt;/enumeration&gt; &lt;enumeration value="0322004"&gt;   &lt;annotation&gt;     &lt;documentation&gt;ja, mit Insulin behandelt&lt;/documentation&gt;   &lt;/annotation&gt; &lt;/enumeration&gt; &lt;enumeration value="0322005"&gt;   &lt;annotation&gt;     &lt;documentation&gt;ja, unbehandelt&lt;/documentation&gt;   &lt;/annotation&gt; &lt;/enumeration&gt; &lt;enumeration value="0322099"&gt;   &lt;annotation&gt;     &lt;documentation&gt;unbekannt&lt;/documentation&gt;   &lt;/annotation&gt; &lt;/enumeration&gt; &lt;/restriction&gt; &lt;/simpleType&gt; </pre>
--	--

### simpleType enum\_0324

namespace	http://xml.ir-d.de/irdsaa		
type	restriction of <b>string</b>		
properties	base xs:string		
facets	Kind	Value	Annotation
	enumeration	0324001	documentation (I): Beschwerdefreiheit, normale körperliche Belastbarkeit
	enumeration	0324002	documentation (II): Beschwerden bei stärkerer körperlicher Belastung
	enumeration	0324003	documentation (III): Beschwerden bei leichter körperlicher Belastung
	enumeration	0324004	documentation (IV): Beschwerden in Ruhe
annotation	documentation Kat_AK_NYHA		
source	<pre> &lt;simpleType name="enum_0324"&gt;   &lt;annotation&gt;     &lt;documentation&gt;Kat_AK_NYHA&lt;/documentation&gt;   &lt;/annotation&gt;   &lt;restriction base="xs:string"&gt;     &lt;enumeration value="0324001"&gt;       &lt;annotation&gt;         &lt;documentation&gt;(I): Beschwerdefreiheit, normale körperliche </pre>		

```

Belastbarkeit</documentation>
  </annotation>
</enumeration>
<enumeration value="0324002">
  <annotation>
    <documentation>(II): Beschwerden bei stärkerer körperlicher
Belastung</documentation>
  </annotation>
</enumeration>
<enumeration value="0324003">
  <annotation>
    <documentation>(III): Beschwerden bei leichter körperlicher
Belastung</documentation>
  </annotation>
</enumeration>
<enumeration value="0324004">
  <annotation>
    <documentation>(IV): Beschwerden in Ruhe</documentation>
  </annotation>
</enumeration>
</restriction>
</simpleType>

```

simpleType enum 0330

namespace	http://xml.ir-d.de/irdsaa		
type	restriction of <b>string</b>		
properties	base xs:string		
facets	Kind	Value	Annotation
	enumeration	0330001	documentation ATS Medical
	enumeration	0330002	documentation Edwards Lifesciences
	enumeration	0330003	documentation Medtronic
	enumeration	0330004	documentation JenaValve
	enumeration	0330005	documentation Corcym
	enumeration	0330006	documentation Abbott Medical / St. Jude
	enumeration	0330007	documentation Symetis
	enumeration	0330008	documentation Direct Flow Medical
	enumeration	0330009	documentation Boston Scientific
	enumeration	0330010	documentation Artivion
	enumeration	0330011	documentation Biosensors
	enumeration	0330012	documentation LivaNova
	enumeration	0330013	documentation Meril
	enumeration	0330014	documentation Sahajanand Medical Technologies
	enumeration	0330015	documentation nicht belegter Wert

	<p>enumeration 0330016 documentation nicht belegter Wert</p> <p>enumeration 0330017 documentation nicht belegter Wert</p> <p>enumeration 0330018 documentation nicht belegter Wert</p> <p>enumeration 0330042 documentation sonstiger Hersteller</p>
annotation	documentation Kat_AK_Hersteller
source	<pre> &lt;simpleType name="enum_0330"&gt;   &lt;annotation&gt;     &lt;documentation&gt;Kat_AK_Hersteller&lt;/documentation&gt;   &lt;/annotation&gt;   &lt;restriction base="xs:string"&gt;     &lt;enumeration value="0330001"&gt;       &lt;annotation&gt;         &lt;documentation&gt;ATS Medical&lt;/documentation&gt;       &lt;/annotation&gt;     &lt;/enumeration&gt;     &lt;enumeration value="0330002"&gt;       &lt;annotation&gt;         &lt;documentation&gt;Edwards Lifesciences&lt;/documentation&gt;       &lt;/annotation&gt;     &lt;/enumeration&gt;     &lt;enumeration value="0330003"&gt;       &lt;annotation&gt;         &lt;documentation&gt;Medtronic&lt;/documentation&gt;       &lt;/annotation&gt;     &lt;/enumeration&gt;     &lt;enumeration value="0330004"&gt;       &lt;annotation&gt;         &lt;documentation&gt;JenaValve&lt;/documentation&gt;       &lt;/annotation&gt;     &lt;/enumeration&gt;     &lt;enumeration value="0330005"&gt;       &lt;annotation&gt;         &lt;documentation&gt;Corcym&lt;/documentation&gt;       &lt;/annotation&gt;     &lt;/enumeration&gt;     &lt;enumeration value="0330006"&gt;       &lt;annotation&gt;         &lt;documentation&gt;Abbott Medical / St. Jude&lt;/documentation&gt;       &lt;/annotation&gt;     &lt;/enumeration&gt;     &lt;enumeration value="0330007"&gt;       &lt;annotation&gt;         &lt;documentation&gt;Symetis&lt;/documentation&gt;       &lt;/annotation&gt;     &lt;/enumeration&gt;     &lt;enumeration value="0330008"&gt;       &lt;annotation&gt;         &lt;documentation&gt;Direct Flow Medical&lt;/documentation&gt;       &lt;/annotation&gt;     &lt;/enumeration&gt;     &lt;enumeration value="0330009"&gt;       &lt;annotation&gt;         &lt;documentation&gt;Boston Scientific&lt;/documentation&gt;       &lt;/annotation&gt;     &lt;/enumeration&gt;   &lt;/restriction&gt; &lt;/simpleType&gt; </pre>

```

<enumeration value="0330010">
  <annotation>
    <documentation>Artivion</documentation>
  </annotation>
</enumeration>
<enumeration value="0330011">
  <annotation>
    <documentation>Biosensors</documentation>
  </annotation>
</enumeration>
<enumeration value="0330012">
  <annotation>
    <documentation>LivaNova</documentation>
  </annotation>
</enumeration>
<enumeration value="0330013">
  <annotation>
    <documentation>Meril</documentation>
  </annotation>
</enumeration>
<enumeration value="0330014">
  <annotation>
    <documentation>Sahajanand Medical Technologies</documentation>
  </annotation>
</enumeration>
<enumeration value="0330015">
  <annotation>
    <documentation>nicht belegter Wert</documentation>
  </annotation>
</enumeration>
<enumeration value="0330016">
  <annotation>
    <documentation>nicht belegter Wert</documentation>
  </annotation>
</enumeration>
<enumeration value="0330017">
  <annotation>
    <documentation>nicht belegter Wert</documentation>
  </annotation>
</enumeration>
<enumeration value="0330018">
  <annotation>
    <documentation>nicht belegter Wert</documentation>
  </annotation>
</enumeration>
<enumeration value="0330042">
  <annotation>
    <documentation>sonstiger Hersteller</documentation>
  </annotation>
</enumeration>
</restriction>
</simpleType>

```

#### simpleType enum\_0338

namespace	http://xml.ir-d.de/irdsaa
type	restriction of <b>string</b>

properties	base xs:string															
facets	<table border="1"> <thead> <tr> <th>Kind</th> <th>Value</th> <th>Annotation</th> </tr> </thead> <tbody> <tr> <td>enumeration</td> <td>0338001</td> <td>documentation LAD</td> </tr> <tr> <td>enumeration</td> <td>0338002</td> <td>documentation RCA</td> </tr> <tr> <td>enumeration</td> <td>0338003</td> <td>documentation RCX</td> </tr> <tr> <td>enumeration</td> <td>0338004</td> <td>documentation Hauptstamm</td> </tr> </tbody> </table>	Kind	Value	Annotation	enumeration	0338001	documentation LAD	enumeration	0338002	documentation RCA	enumeration	0338003	documentation RCX	enumeration	0338004	documentation Hauptstamm
Kind	Value	Annotation														
enumeration	0338001	documentation LAD														
enumeration	0338002	documentation RCA														
enumeration	0338003	documentation RCX														
enumeration	0338004	documentation Hauptstamm														
annotation	documentation Kat_AK_PCIArterien															
source	<pre>&lt;simpleType name="enum_0338"&gt;   &lt;annotation&gt;     &lt;documentation&gt;Kat_AK_PCIArterien&lt;/documentation&gt;   &lt;/annotation&gt;   &lt;restriction base="xs:string"&gt;     &lt;enumeration value="0338001"&gt;       &lt;annotation&gt;         &lt;documentation&gt;LAD&lt;/documentation&gt;       &lt;/annotation&gt;     &lt;/enumeration&gt;     &lt;enumeration value="0338002"&gt;       &lt;annotation&gt;         &lt;documentation&gt;RCA&lt;/documentation&gt;       &lt;/annotation&gt;     &lt;/enumeration&gt;     &lt;enumeration value="0338003"&gt;       &lt;annotation&gt;         &lt;documentation&gt;RCX&lt;/documentation&gt;       &lt;/annotation&gt;     &lt;/enumeration&gt;     &lt;enumeration value="0338004"&gt;       &lt;annotation&gt;         &lt;documentation&gt;Hauptstamm&lt;/documentation&gt;       &lt;/annotation&gt;     &lt;/enumeration&gt;   &lt;/restriction&gt; &lt;/simpleType&gt;</pre>															

### simpleType enum\_0339

namespace	http://xml.ir-d.de/irdsaa												
type	restriction of <b>string</b>												
properties	base xs:string												
facets	<table border="1"> <thead> <tr> <th>Kind</th> <th>Value</th> <th>Annotation</th> </tr> </thead> <tbody> <tr> <td>enumeration</td> <td>0339001</td> <td>documentation TEE</td> </tr> <tr> <td>enumeration</td> <td>0339002</td> <td>documentation CT</td> </tr> <tr> <td>enumeration</td> <td>0339042</td> <td>documentation andere</td> </tr> </tbody> </table>	Kind	Value	Annotation	enumeration	0339001	documentation TEE	enumeration	0339002	documentation CT	enumeration	0339042	documentation andere
Kind	Value	Annotation											
enumeration	0339001	documentation TEE											
enumeration	0339002	documentation CT											
enumeration	0339042	documentation andere											
annotation	documentation Kat_AK_AnnulusMessmethode												
source	<pre>&lt;simpleType name="enum_0339"&gt;   &lt;annotation&gt;     &lt;documentation&gt;Kat_AK_AnnulusMessmethode&lt;/documentation&gt;</pre>												

	<pre> &lt;/annotation&gt; &lt;restriction base="xs:string"&gt;   &lt;enumeration value="0339001"&gt;     &lt;annotation&gt;       &lt;documentation&gt;TEE&lt;/documentation&gt;     &lt;/annotation&gt;   &lt;/enumeration&gt;   &lt;enumeration value="0339002"&gt;     &lt;annotation&gt;       &lt;documentation&gt;CT&lt;/documentation&gt;     &lt;/annotation&gt;   &lt;/enumeration&gt;   &lt;enumeration value="0339042"&gt;     &lt;annotation&gt;       &lt;documentation&gt;andere&lt;/documentation&gt;     &lt;/annotation&gt;   &lt;/enumeration&gt; &lt;/restriction&gt; &lt;/simpleType&gt; </pre>
--	---

### simpleType enum 0341

namespace	http://xml.ir-d.de/irdsaa		
type	restriction of <b>string</b>		
properties	base xs:string		
facets	Kind	Value	Annotation
	enumeration	0341001	documentation intraprozedural verstorben
	enumeration	0341002	documentation Implantation von mehr als einer Prothese
	enumeration	0341003	documentation gravierende Gefäß- oder Zugangskomplikation (gemäß VARC-3)
	enumeration	0341004	documentation erforderlicher chirurgischer oder interventioneller Eingriff wegen einer Klappenfehlfunktion (gemäß VARC-3)
	enumeration	0341005	documentation &gt;= große strukturelle kardiale Komplikation (gemäß VARC-3)
annotation	documentation Kat_AK_FailureGrund		
source	<pre> &lt;simpleType name="enum_0341"&gt;   &lt;annotation&gt;     &lt;documentation&gt;Kat_AK_FailureGrund&lt;/documentation&gt;   &lt;/annotation&gt;   &lt;restriction base="xs:string"&gt;     &lt;enumeration value="0341001"&gt;       &lt;annotation&gt;         &lt;documentation&gt;intraprozedural verstorben&lt;/documentation&gt;       &lt;/annotation&gt;     &lt;/enumeration&gt;     &lt;enumeration value="0341002"&gt;       &lt;annotation&gt;         &lt;documentation&gt;Implantation von mehr als einer Prothese&lt;/documentation&gt;       &lt;/annotation&gt;     &lt;/enumeration&gt;     &lt;enumeration value="0341003"&gt;       &lt;annotation&gt;         &lt;documentation&gt;gravierende Gefäß- oder Zugangskomplikation (gemäß </pre>		

	<pre> VARC-3)&lt;/documentation&gt;   &lt;/annotation&gt; &lt;/enumeration&gt; &lt;enumeration value="0341004"&gt;   &lt;annotation&gt;     &lt;documentation&gt;erforderlicher chirurgischer oder interventioneller Eingriff wegen einer Klappenfehlfunktion (gemäß VARC-3)&lt;/documentation&gt;   &lt;/annotation&gt; &lt;/enumeration&gt; &lt;enumeration value="0341005"&gt;   &lt;annotation&gt;     &lt;documentation&gt;&amp;gt;= große strukturelle kardiale Komplikation (gemäß VARC-3)&lt;/documentation&gt;   &lt;/annotation&gt; &lt;/enumeration&gt; &lt;/restriction&gt; &lt;/simpleType&gt; </pre>
--	--

### simpleType enum 0342

namespace	http://xml.ir-d.de/irdsaa		
type	restriction of <b>string</b>		
properties	base xs:string		
facets	Kind	Value	Annotation
	enumeration	0342001	documentation Alter
	enumeration	0342002	documentation Frailty
	enumeration	0342003	documentation Hochrisiko
	enumeration	0342004	documentation Prognose-limitierende Zweiterkrankung
	enumeration	0342005	documentation Porzellan-Aorta
	enumeration	0342042	documentation Sonstige
annotation	documentation Kat_AK_Tavi		
source	<pre> &lt;simpleType name="enum_0342"&gt;   &lt;annotation&gt;     &lt;documentation&gt;Kat_AK_Tavi&lt;/documentation&gt;   &lt;/annotation&gt;   &lt;restriction base="xs:string"&gt;     &lt;enumeration value="0342001"&gt;       &lt;annotation&gt;         &lt;documentation&gt;Alter&lt;/documentation&gt;       &lt;/annotation&gt;     &lt;/enumeration&gt;     &lt;enumeration value="0342002"&gt;       &lt;annotation&gt;         &lt;documentation&gt;Frailty&lt;/documentation&gt;       &lt;/annotation&gt;     &lt;/enumeration&gt;     &lt;enumeration value="0342003"&gt;       &lt;annotation&gt;         &lt;documentation&gt;Hochrisiko&lt;/documentation&gt;       &lt;/annotation&gt; </pre>		

```

</enumeration>
<enumeration value="0342004">
  <annotation>
    <documentation>Prognose-limitierende Zweiterkrankung</documentation>
  </annotation>
</enumeration>
<enumeration value="0342005">
  <annotation>
    <documentation>Porzellan-Aorta</documentation>
  </annotation>
</enumeration>
<enumeration value="0342042">
  <annotation>
    <documentation>Sonstige</documentation>
  </annotation>
</enumeration>
</restriction>
</simpleType>

```

### simpleType enum\_0343

namespace	http://xml.ir-d.de/irdsaa		
type	restriction of <b>string</b>		
properties	base xs:string		
facets	Kind	Value	Annotation
	enumeration	0343001	documentation Device-Fehlpositionierung
	enumeration	0343002	documentation Koronarostienverschluss
	enumeration	0343003	documentation Aortendissektion
	enumeration	0343004	documentation Aortenregurgitation &gt; = 2. Grades
	enumeration	0343005	documentation Annulus-Ruptur
	enumeration	0343006	documentation Ruptur-/Perforation einer Herzhöhle ohne Therapiebedarf
	enumeration	0343007	documentation Ruptur-/Perforation einer Herzhöhle mit Therapiebedarf
	enumeration	0343008	documentation Perikardtamponade
	enumeration	0343009	documentation kardiale Dekompensation
	enumeration	0343010	documentation Hir Embolie
	enumeration	0343011	documentation Rhythmusstörungen
	enumeration	0343012	documentation Device-Embolisation
	enumeration	0343013	documentation vaskuläre Komplikation
	enumeration	0343014	documentation Low Cardiac Output
	enumeration	0343015	documentation schwerwiegende Blutungen (intraprozedural)
	enumeration	0343016	documentation lebensbedrohliche Blutungen (intraprozedural)
	enumeration	0343017	documentation Patient verstarb im OP/Katheterlabor
	enumeration	0343042	documentation



	sonstige intraprozedurale Komplikationen
annotation	documentation Kat_AK_KomplikationTyp
source	<pre> &lt;simpleType name="enum_0343"&gt;   &lt;annotation&gt;     &lt;documentation&gt;Kat_AK_KomplikationTyp&lt;/documentation&gt;   &lt;/annotation&gt;   &lt;restriction base="xs:string"&gt;     &lt;enumeration value="0343001"&gt;       &lt;annotation&gt;         &lt;documentation&gt;Device-Fehlpositionierung&lt;/documentation&gt;       &lt;/annotation&gt;     &lt;/enumeration&gt;     &lt;enumeration value="0343002"&gt;       &lt;annotation&gt;         &lt;documentation&gt;Koronarostienverschluss&lt;/documentation&gt;       &lt;/annotation&gt;     &lt;/enumeration&gt;     &lt;enumeration value="0343003"&gt;       &lt;annotation&gt;         &lt;documentation&gt;Aortendissektion&lt;/documentation&gt;       &lt;/annotation&gt;     &lt;/enumeration&gt;     &lt;enumeration value="0343004"&gt;       &lt;annotation&gt;         &lt;documentation&gt;Aortenregurgitation &amp;gt; = 2. Grades&lt;/documentation&gt;       &lt;/annotation&gt;     &lt;/enumeration&gt;     &lt;enumeration value="0343005"&gt;       &lt;annotation&gt;         &lt;documentation&gt;Annulus-Ruptur&lt;/documentation&gt;       &lt;/annotation&gt;     &lt;/enumeration&gt;     &lt;enumeration value="0343006"&gt;       &lt;annotation&gt;         &lt;documentation&gt;Ruptur-/Perforation einer Herzhöhle ohne Therapiebedarf&lt;/documentation&gt;       &lt;/annotation&gt;     &lt;/enumeration&gt;     &lt;enumeration value="0343007"&gt;       &lt;annotation&gt;         &lt;documentation&gt;Ruptur-/Perforation einer Herzhöhle mit Therapiebedarf&lt;/documentation&gt;       &lt;/annotation&gt;     &lt;/enumeration&gt;     &lt;enumeration value="0343008"&gt;       &lt;annotation&gt;         &lt;documentation&gt;Perikardtamponade&lt;/documentation&gt;       &lt;/annotation&gt;     &lt;/enumeration&gt;     &lt;enumeration value="0343009"&gt;       &lt;annotation&gt;         &lt;documentation&gt;kardiale Dekompensation&lt;/documentation&gt;       &lt;/annotation&gt;     &lt;/enumeration&gt;     &lt;enumeration value="0343010"&gt;       &lt;annotation&gt;         &lt;documentation&gt;Hirnembolie&lt;/documentation&gt;       &lt;/annotation&gt;     &lt;/enumeration&gt;   &lt;/restriction&gt; &lt;/simpleType&gt; </pre>

```

</enumeration>
<enumeration value="0343011">
  <annotation>
    <documentation>Rhythmusstörungen</documentation>
  </annotation>
</enumeration>
<enumeration value="0343012">
  <annotation>
    <documentation>Device-Embolisation</documentation>
  </annotation>
</enumeration>
<enumeration value="0343013">
  <annotation>
    <documentation>vaskuläre Komplikation</documentation>
  </annotation>
</enumeration>
<enumeration value="0343014">
  <annotation>
    <documentation>Low Cardiac Output</documentation>
  </annotation>
</enumeration>
<enumeration value="0343015">
  <annotation>
    <documentation>schwerwiegende Blutungen
(intraprozedural)</documentation>
  </annotation>
</enumeration>
<enumeration value="0343016">
  <annotation>
    <documentation>lebensbedrohliche Blutungen
(intraprozedural)</documentation>
  </annotation>
</enumeration>
<enumeration value="0343017">
  <annotation>
    <documentation>Patient verstarb im OP/Katheterlabor</documentation>
  </annotation>
</enumeration>
<enumeration value="0343042">
  <annotation>
    <documentation>sonstige intraprozedurale
Komplikationen</documentation>
  </annotation>
</enumeration>
</restriction>
</simpleType>

```

### simpleType enum\_0346

namespace	http://xml.ir-d.de/irdsaa		
type	restriction of <b>string</b>		
properties	base xs:string		
facets	Kind	Value	Annotation
	enumeration	0346001	documentation keine Therapie erforderlich
	enumeration	0346002	documentation medikamentös

	enumeration 0346003 documentation IABP enumeration 0346004 documentation VAD enumeration 0346005 documentation ECMO enumeration 0346042 documentation sonstige
annotation	documentation Kat_AK_TherapieLCO
source	<pre> &lt;simpleType name="enum_0346"&gt;   &lt;annotation&gt;     &lt;documentation&gt;Kat_AK_TherapieLCO&lt;/documentation&gt;   &lt;/annotation&gt;   &lt;restriction base="xs:string"&gt;     &lt;enumeration value="0346001"&gt;       &lt;annotation&gt;         &lt;documentation&gt;keine Therapie erforderlich&lt;/documentation&gt;       &lt;/annotation&gt;     &lt;/enumeration&gt;     &lt;enumeration value="0346002"&gt;       &lt;annotation&gt;         &lt;documentation&gt;medikamentös&lt;/documentation&gt;       &lt;/annotation&gt;     &lt;/enumeration&gt;     &lt;enumeration value="0346003"&gt;       &lt;annotation&gt;         &lt;documentation&gt;IABP&lt;/documentation&gt;       &lt;/annotation&gt;     &lt;/enumeration&gt;     &lt;enumeration value="0346004"&gt;       &lt;annotation&gt;         &lt;documentation&gt;VAD&lt;/documentation&gt;       &lt;/annotation&gt;     &lt;/enumeration&gt;     &lt;enumeration value="0346005"&gt;       &lt;annotation&gt;         &lt;documentation&gt;ECMO&lt;/documentation&gt;       &lt;/annotation&gt;     &lt;/enumeration&gt;     &lt;enumeration value="0346042"&gt;       &lt;annotation&gt;         &lt;documentation&gt;sonstige&lt;/documentation&gt;       &lt;/annotation&gt;     &lt;/enumeration&gt;   &lt;/restriction&gt; &lt;/simpleType&gt; </pre>

### simpleType enum\_0347

namespace	http://xml.ir-d.de/irdsaa		
type	restriction of <b>string</b>		
properties	base xs:string		
facets	Kind	Value	Annotation
	enumeration	0347001	documentation Einzeleingriff
	enumeration	0347002	documentation

	Kombinationseingriff mit mehreren Prozeduren
annotation	documentation Kat_AK_Eingriffsumfang
source	<pre> &lt;simpleType name="enum_0347"&gt;   &lt;annotation&gt;     &lt;documentation&gt;Kat_AK_Eingriffsumfang&lt;/documentation&gt;   &lt;/annotation&gt;   &lt;restriction base="xs:string"&gt;     &lt;enumeration value="0347001"&gt;       &lt;annotation&gt;         &lt;documentation&gt;Einzeleingriff&lt;/documentation&gt;       &lt;/annotation&gt;     &lt;/enumeration&gt;     &lt;enumeration value="0347002"&gt;       &lt;annotation&gt;         &lt;documentation&gt;Kombinationseingriff mit mehreren Prozeduren&lt;/documentation&gt;       &lt;/annotation&gt;     &lt;/enumeration&gt;   &lt;/restriction&gt; &lt;/simpleType&gt; </pre>

### simpleType enum\_0348

namespace	http://xml.ir-d.de/irdsaa		
type	restriction of <b>string</b>		
properties	base xs:string		
facets	Kind	Value	Annotation
	enumeration	0348001	documentation mit HLM
	enumeration	0348002	documentation ohne HLM
	enumeration	0348003	documentation Umstieg von OP ohne HLM auf OP mit HLM
annotation	documentation Kat_AK_OPVorgehen		
source	<pre> &lt;simpleType name="enum_0348"&gt;   &lt;annotation&gt;     &lt;documentation&gt;Kat_AK_OPVorgehen&lt;/documentation&gt;   &lt;/annotation&gt;   &lt;restriction base="xs:string"&gt;     &lt;enumeration value="0348001"&gt;       &lt;annotation&gt;         &lt;documentation&gt;mit HLM&lt;/documentation&gt;       &lt;/annotation&gt;     &lt;/enumeration&gt;     &lt;enumeration value="0348002"&gt;       &lt;annotation&gt;         &lt;documentation&gt;ohne HLM&lt;/documentation&gt;       &lt;/annotation&gt;     &lt;/enumeration&gt;     &lt;enumeration value="0348003"&gt;       &lt;annotation&gt;         &lt;documentation&gt;Umstieg von OP ohne HLM auf OP mit HLM&lt;/documentation&gt;       &lt;/annotation&gt;     &lt;/enumeration&gt;   &lt;/restriction&gt; </pre>		

	<code>&lt;/simpleType&gt;</code>
--	----------------------------------

### simpleType enum\_0350

namespace	http://xml.ir-d.de/irdsaa																		
type	restriction of <b>string</b>																		
properties	base xs:string																		
facets	<table><thead><tr><th>Kind</th><th>Value</th><th>Annotation</th></tr></thead><tbody><tr><td>enumeration</td><td>0350001</td><td>documentation IABP</td></tr><tr><td>enumeration</td><td>0350002</td><td>documentation Impella</td></tr><tr><td>enumeration</td><td>0350003</td><td>documentation vv ECMO</td></tr><tr><td>enumeration</td><td>0350004</td><td>documentation va ECMO</td></tr><tr><td>enumeration</td><td>0350042</td><td>documentation andere</td></tr></tbody></table>	Kind	Value	Annotation	enumeration	0350001	documentation IABP	enumeration	0350002	documentation Impella	enumeration	0350003	documentation vv ECMO	enumeration	0350004	documentation va ECMO	enumeration	0350042	documentation andere
Kind	Value	Annotation																	
enumeration	0350001	documentation IABP																	
enumeration	0350002	documentation Impella																	
enumeration	0350003	documentation vv ECMO																	
enumeration	0350004	documentation va ECMO																	
enumeration	0350042	documentation andere																	
annotation	documentation Kat_AK_Methode																		
source	<pre>&lt;simpleType name="enum_0350"&gt;   &lt;annotation&gt;     &lt;documentation&gt;Kat_AK_Methode&lt;/documentation&gt;   &lt;/annotation&gt;   &lt;restriction base="xs:string"&gt;     &lt;enumeration value="0350001"&gt;       &lt;annotation&gt;         &lt;documentation&gt;IABP&lt;/documentation&gt;       &lt;/annotation&gt;     &lt;/enumeration&gt;     &lt;enumeration value="0350002"&gt;       &lt;annotation&gt;         &lt;documentation&gt;Impella&lt;/documentation&gt;       &lt;/annotation&gt;     &lt;/enumeration&gt;     &lt;enumeration value="0350003"&gt;       &lt;annotation&gt;         &lt;documentation&gt;vv ECMO&lt;/documentation&gt;       &lt;/annotation&gt;     &lt;/enumeration&gt;     &lt;enumeration value="0350004"&gt;       &lt;annotation&gt;         &lt;documentation&gt;va ECMO&lt;/documentation&gt;       &lt;/annotation&gt;     &lt;/enumeration&gt;     &lt;enumeration value="0350042"&gt;       &lt;annotation&gt;         &lt;documentation&gt;andere&lt;/documentation&gt;       &lt;/annotation&gt;     &lt;/enumeration&gt;   &lt;/restriction&gt; &lt;/simpleType&gt;</pre>																		

### simpleType enum\_0351

namespace	http://xml.ir-d.de/irdsaa
-----------	---------------------------

type	restriction of <b>string</b>																											
properties	base xs:string																											
facets	<table border="1"> <thead> <tr> <th>Kind</th> <th>Value</th> <th>Annotation</th> </tr> </thead> <tbody> <tr> <td>enumeration</td> <td>0351001</td> <td>documentation nein</td> </tr> <tr> <td>enumeration</td> <td>0351002</td> <td>documentation ja, zu Sternotomie</td> </tr> <tr> <td>enumeration</td> <td>0351003</td> <td>documentation ja, zu transapikal</td> </tr> <tr> <td>enumeration</td> <td>0351004</td> <td>documentation ja, zu transaortal</td> </tr> <tr> <td>enumeration</td> <td>0351005</td> <td>documentation ja, zu transfemoral</td> </tr> <tr> <td>enumeration</td> <td>0351006</td> <td>documentation ja, zu transaxillär</td> </tr> <tr> <td>enumeration</td> <td>0351007</td> <td>documentation ja, zu anderem endovaskulären Zugang</td> </tr> <tr> <td>enumeration</td> <td>0351042</td> <td>documentation ja, zu anderem Zugang</td> </tr> </tbody> </table>	Kind	Value	Annotation	enumeration	0351001	documentation nein	enumeration	0351002	documentation ja, zu Sternotomie	enumeration	0351003	documentation ja, zu transapikal	enumeration	0351004	documentation ja, zu transaortal	enumeration	0351005	documentation ja, zu transfemoral	enumeration	0351006	documentation ja, zu transaxillär	enumeration	0351007	documentation ja, zu anderem endovaskulären Zugang	enumeration	0351042	documentation ja, zu anderem Zugang
Kind	Value	Annotation																										
enumeration	0351001	documentation nein																										
enumeration	0351002	documentation ja, zu Sternotomie																										
enumeration	0351003	documentation ja, zu transapikal																										
enumeration	0351004	documentation ja, zu transaortal																										
enumeration	0351005	documentation ja, zu transfemoral																										
enumeration	0351006	documentation ja, zu transaxillär																										
enumeration	0351007	documentation ja, zu anderem endovaskulären Zugang																										
enumeration	0351042	documentation ja, zu anderem Zugang																										
annotation	documentation Kat_AK_Konversion																											
source	<pre> &lt;simpleType name="enum_0351"&gt;   &lt;annotation&gt;     &lt;documentation&gt;Kat_AK_Konversion&lt;/documentation&gt;   &lt;/annotation&gt;   &lt;restriction base="xs:string"&gt;     &lt;enumeration value="0351001"&gt;       &lt;annotation&gt;         &lt;documentation&gt;nein&lt;/documentation&gt;       &lt;/annotation&gt;     &lt;/enumeration&gt;     &lt;enumeration value="0351002"&gt;       &lt;annotation&gt;         &lt;documentation&gt;ja, zu Sternotomie&lt;/documentation&gt;       &lt;/annotation&gt;     &lt;/enumeration&gt;     &lt;enumeration value="0351003"&gt;       &lt;annotation&gt;         &lt;documentation&gt;ja, zu transapikal&lt;/documentation&gt;       &lt;/annotation&gt;     &lt;/enumeration&gt;     &lt;enumeration value="0351004"&gt;       &lt;annotation&gt;         &lt;documentation&gt;ja, zu transaortal&lt;/documentation&gt;       &lt;/annotation&gt;     &lt;/enumeration&gt;     &lt;enumeration value="0351005"&gt;       &lt;annotation&gt;         &lt;documentation&gt;ja, zu transfemoral&lt;/documentation&gt;       &lt;/annotation&gt;     &lt;/enumeration&gt;     &lt;enumeration value="0351006"&gt;       &lt;annotation&gt;         &lt;documentation&gt;ja, zu transaxillär&lt;/documentation&gt;       &lt;/annotation&gt;     &lt;/enumeration&gt;     &lt;enumeration value="0351007"&gt;       &lt;annotation&gt;         &lt;documentation&gt;ja, zu anderem endovaskulären Zugang&lt;/documentation&gt;       &lt;/annotation&gt;     &lt;/enumeration&gt;   &lt;/restriction&gt; &lt;/simpleType&gt; </pre>																											

	<pre> &lt;/annotation&gt; &lt;/enumeration&gt; &lt;enumeration value="0351042"&gt;   &lt;annotation&gt;     &lt;documentation&gt;ja, zu anderem Zugang&lt;/documentation&gt;   &lt;/annotation&gt; &lt;/enumeration&gt; &lt;/restriction&gt; &lt;/simpleType&gt; </pre>
--	---

### simpleType enum\_0352

namespace	http://xml.ir-d.de/irdsaa		
type	restriction of <b>string</b>		
properties	base xs:string		
facets	Kind	Value	Annotation
	enumeration	0352001	documentation nein
	enumeration	0352002	documentation ja, Intubationsnarkose
	enumeration	0352003	documentation ja, Maskenbeatmung, incl. LAMA
	enumeration	0352042	documentation ja, unbekannt welche
annotation	documentation Kat_AK_Anaesthesie		
source	<pre> &lt;simpleType name="enum_0352"&gt;   &lt;annotation&gt;     &lt;documentation&gt;Kat_AK_Anaesthesie&lt;/documentation&gt;   &lt;/annotation&gt;   &lt;restriction base="xs:string"&gt;     &lt;enumeration value="0352001"&gt;       &lt;annotation&gt;         &lt;documentation&gt;nein&lt;/documentation&gt;       &lt;/annotation&gt;     &lt;/enumeration&gt;     &lt;enumeration value="0352002"&gt;       &lt;annotation&gt;         &lt;documentation&gt;ja, Intubationsnarkose&lt;/documentation&gt;       &lt;/annotation&gt;     &lt;/enumeration&gt;     &lt;enumeration value="0352003"&gt;       &lt;annotation&gt;         &lt;documentation&gt;ja, Maskenbeatmung, incl. LAMA&lt;/documentation&gt;       &lt;/annotation&gt;     &lt;/enumeration&gt;     &lt;enumeration value="0352042"&gt;       &lt;annotation&gt;         &lt;documentation&gt;ja, unbekannt welche&lt;/documentation&gt;       &lt;/annotation&gt;     &lt;/enumeration&gt;   &lt;/restriction&gt; &lt;/simpleType&gt; </pre>		

### simpleType enum\_0353

namespace	http://xml.ir-d.de/irdsaa		
type	restriction of <b>string</b>		
properties	base xs:string		
facets	Kind	Value	Annotation
	enumeration	0353001	documentation keine
	enumeration	0353002	documentation leichtgradig
	enumeration	0353003	documentation mittelgradig
	enumeration	0353004	documentation hochgradig
	enumeration	0353099	documentation nicht bestimmbar
annotation	documentation Kat_AK_ResidualeArteninsuffizienz		
source	<pre> &lt;simpleType name="enum_0353"&gt;   &lt;annotation&gt;     &lt;documentation&gt;Kat_AK_ResidualeArteninsuffizienz&lt;/documentation&gt;   &lt;/annotation&gt;   &lt;restriction base="xs:string"&gt;     &lt;enumeration value="0353001"&gt;       &lt;annotation&gt;         &lt;documentation&gt;keine&lt;/documentation&gt;       &lt;/annotation&gt;     &lt;/enumeration&gt;     &lt;enumeration value="0353002"&gt;       &lt;annotation&gt;         &lt;documentation&gt;leichtgradig&lt;/documentation&gt;       &lt;/annotation&gt;     &lt;/enumeration&gt;     &lt;enumeration value="0353003"&gt;       &lt;annotation&gt;         &lt;documentation&gt;mittelgradig&lt;/documentation&gt;       &lt;/annotation&gt;     &lt;/enumeration&gt;     &lt;enumeration value="0353004"&gt;       &lt;annotation&gt;         &lt;documentation&gt;hochgradig&lt;/documentation&gt;       &lt;/annotation&gt;     &lt;/enumeration&gt;     &lt;enumeration value="0353099"&gt;       &lt;annotation&gt;         &lt;documentation&gt;nicht bestimmbar&lt;/documentation&gt;       &lt;/annotation&gt;     &lt;/enumeration&gt;   &lt;/restriction&gt; &lt;/simpleType&gt; </pre>		

### simpleType enum\_0354

namespace	http://xml.ir-d.de/irdsaa		
type	restriction of <b>string</b>		
properties	base xs:string		



facets	<table border="1"> <thead> <tr> <th>Kind</th> <th>Value</th> <th>Annotation</th> </tr> </thead> <tbody> <tr> <td>enumeration</td> <td>0354001</td> <td>documentation chirurgisch-offen</td> </tr> <tr> <td>enumeration</td> <td>0354002</td> <td>documentation Verschluss-System</td> </tr> <tr> <td>enumeration</td> <td>0354042</td> <td>documentation sonstige</td> </tr> </tbody> </table>	Kind	Value	Annotation	enumeration	0354001	documentation chirurgisch-offen	enumeration	0354002	documentation Verschluss-System	enumeration	0354042	documentation sonstige
Kind	Value	Annotation											
enumeration	0354001	documentation chirurgisch-offen											
enumeration	0354002	documentation Verschluss-System											
enumeration	0354042	documentation sonstige											
annotation	documentation Kat_AK_Zugangswegverschluss												
source	<pre> &lt;simpleType name="enum_0354"&gt;   &lt;annotation&gt;     &lt;documentation&gt;Kat_AK_Zugangswegverschluss&lt;/documentation&gt;   &lt;/annotation&gt;   &lt;restriction base="xs:string"&gt;     &lt;enumeration value="0354001"&gt;       &lt;annotation&gt;         &lt;documentation&gt;chirurgisch-offen&lt;/documentation&gt;       &lt;/annotation&gt;     &lt;/enumeration&gt;     &lt;enumeration value="0354002"&gt;       &lt;annotation&gt;         &lt;documentation&gt;Verschluss-System&lt;/documentation&gt;       &lt;/annotation&gt;     &lt;/enumeration&gt;     &lt;enumeration value="0354042"&gt;       &lt;annotation&gt;         &lt;documentation&gt;sonstige&lt;/documentation&gt;       &lt;/annotation&gt;     &lt;/enumeration&gt;   &lt;/restriction&gt; &lt;/simpleType&gt; </pre>												

### simpleType enum\_0357

namespace	http://xml.ir-d.de/irdsaa																		
type	restriction of <b>string</b>																		
properties	base xs:string																		
facets	<table border="1"> <thead> <tr> <th>Kind</th> <th>Value</th> <th>Annotation</th> </tr> </thead> <tbody> <tr> <td>enumeration</td> <td>0357001</td> <td>documentation keine KHK</td> </tr> <tr> <td>enumeration</td> <td>0357002</td> <td>documentation 1-Gefäßerkrankung</td> </tr> <tr> <td>enumeration</td> <td>0357003</td> <td>documentation 2-Gefäßerkrankung</td> </tr> <tr> <td>enumeration</td> <td>0357004</td> <td>documentation 3-Gefäßerkrankung</td> </tr> <tr> <td>enumeration</td> <td>0357005</td> <td>documentation keine koronare Bildgebung</td> </tr> </tbody> </table>	Kind	Value	Annotation	enumeration	0357001	documentation keine KHK	enumeration	0357002	documentation 1-Gefäßerkrankung	enumeration	0357003	documentation 2-Gefäßerkrankung	enumeration	0357004	documentation 3-Gefäßerkrankung	enumeration	0357005	documentation keine koronare Bildgebung
Kind	Value	Annotation																	
enumeration	0357001	documentation keine KHK																	
enumeration	0357002	documentation 1-Gefäßerkrankung																	
enumeration	0357003	documentation 2-Gefäßerkrankung																	
enumeration	0357004	documentation 3-Gefäßerkrankung																	
enumeration	0357005	documentation keine koronare Bildgebung																	
annotation	documentation Kat_AK_BefundBildgebung																		
source	<pre> &lt;simpleType name="enum_0357"&gt;   &lt;annotation&gt;     &lt;documentation&gt;Kat_AK_BefundBildgebung&lt;/documentation&gt;   &lt;/annotation&gt;   &lt;restriction base="xs:string"&gt;     &lt;enumeration value="0357001"&gt;       &lt;annotation&gt;         &lt;documentation&gt;keine KHK&lt;/documentation&gt;       &lt;/annotation&gt;     &lt;/enumeration&gt;   &lt;/restriction&gt; &lt;/simpleType&gt; </pre>																		

	<pre> &lt;/annotation&gt; &lt;/enumeration&gt; &lt;enumeration value="0357002"&gt;   &lt;annotation&gt;     &lt;documentation&gt;1-Gefäßerkrankung&lt;/documentation&gt;   &lt;/annotation&gt; &lt;/enumeration&gt; &lt;enumeration value="0357003"&gt;   &lt;annotation&gt;     &lt;documentation&gt;2-Gefäßerkrankung&lt;/documentation&gt;   &lt;/annotation&gt; &lt;/enumeration&gt; &lt;enumeration value="0357004"&gt;   &lt;annotation&gt;     &lt;documentation&gt;3-Gefäßerkrankung&lt;/documentation&gt;   &lt;/annotation&gt; &lt;/enumeration&gt; &lt;enumeration value="0357005"&gt;   &lt;annotation&gt;     &lt;documentation&gt;keine koronare Bildgebung&lt;/documentation&gt;   &lt;/annotation&gt; &lt;/enumeration&gt; &lt;/restriction&gt; &lt;/simpleType&gt; </pre>
--	--

### simpleType enum\_0358

namespace	http://xml.ir-d.de/irdsaa		
type	restriction of <b>string</b>		
properties	base xs:string		
facets	Kind	Value	Annotation
	enumeration	0358001	documentation 0
	enumeration	0358002	documentation 1
	enumeration	0358003	documentation 2
	enumeration	0358004	documentation 3
	enumeration	0358005	documentation 4
	enumeration	0358006	documentation 5 oder mehr
	enumeration	0358098	documentation genaue Anzahl unbekannt (aber mind. 1)
	enumeration	0358099	documentation unbekannt
annotation	documentation Kat_AK_AnzahlVorOP		
source	<pre> &lt;simpleType name="enum_0358"&gt;   &lt;annotation&gt;     &lt;documentation&gt;Kat_AK_AnzahlVorOP&lt;/documentation&gt;   &lt;/annotation&gt;   &lt;restriction base="xs:string"&gt;     &lt;enumeration value="0358001"&gt;       &lt;annotation&gt;         &lt;documentation&gt;0&lt;/documentation&gt;       &lt;/annotation&gt; </pre>		

```

</enumeration>
<enumeration value="0358002">
  <annotation>
    <documentation>1</documentation>
  </annotation>
</enumeration>
<enumeration value="0358003">
  <annotation>
    <documentation>2</documentation>
  </annotation>
</enumeration>
<enumeration value="0358004">
  <annotation>
    <documentation>3</documentation>
  </annotation>
</enumeration>
<enumeration value="0358005">
  <annotation>
    <documentation>4</documentation>
  </annotation>
</enumeration>
<enumeration value="0358006">
  <annotation>
    <documentation>5 oder mehr</documentation>
  </annotation>
</enumeration>
<enumeration value="0358098">
  <annotation>
    <documentation>genaue Anzahl unbekannt (aber mind. 1)</documentation>
  </annotation>
</enumeration>
<enumeration value="0358099">
  <annotation>
    <documentation>unbekannt</documentation>
  </annotation>
</enumeration>
</restriction>
</simpleType>

```

simpleType **enum\_0359**

namespace	http://xml.ir-d.de/irdsaa		
type	restriction of <b>string</b>		
properties	base xs:string		
facets	Kind	Value	Annotation
	enumeration	0359001	documentation nein
	enumeration	0359002	documentation ja - einseitig
	enumeration	0359003	documentation ja - beidseitig
	enumeration	0359042	documentation unbekannt
annotation	documentation Kat_AK_LVOT		
source	<simpleType name="enum_0359"> <annotation>		

	<pre> &lt;documentation&gt;Kat_AK_LVOT&lt;/documentation&gt; &lt;/annotation&gt; &lt;restriction base="xs:string"&gt;   &lt;enumeration value="0359001"&gt;     &lt;annotation&gt;       &lt;documentation&gt;nein&lt;/documentation&gt;     &lt;/annotation&gt;   &lt;/enumeration&gt;   &lt;enumeration value="0359002"&gt;     &lt;annotation&gt;       &lt;documentation&gt;ja - einseitig&lt;/documentation&gt;     &lt;/annotation&gt;   &lt;/enumeration&gt;   &lt;enumeration value="0359003"&gt;     &lt;annotation&gt;       &lt;documentation&gt;ja - beidseitig&lt;/documentation&gt;     &lt;/annotation&gt;   &lt;/enumeration&gt;   &lt;enumeration value="0359042"&gt;     &lt;annotation&gt;       &lt;documentation&gt;unbekannt&lt;/documentation&gt;     &lt;/annotation&gt;   &lt;/enumeration&gt; &lt;/restriction&gt; &lt;/simpleType&gt; </pre>
--	---

### simpleType enum\_0360

namespace	http://xml.ir-d.de/irdsaa		
type	restriction of <b>string</b>		
properties	base xs:string		
facets	Kind	Value	Annotation
	enumeration	0360001	documentation keine
	enumeration	0360002	documentation leichtgradig
	enumeration	0360003	documentation mittelgradig
	enumeration	0360004	documentation hochgradig
	enumeration	0360005	documentation massive
	enumeration	0360006	documentation torrential
	enumeration	0360099	documentation unbekannt
annotation	documentation Kat_AK_TriskupidalInsuffizienz		
source	<pre> &lt;simpleType name="enum_0360"&gt;   &lt;annotation&gt;     &lt;documentation&gt;Kat_AK_TriskupidalInsuffizienz&lt;/documentation&gt;   &lt;/annotation&gt;   &lt;restriction base="xs:string"&gt;     &lt;enumeration value="0360001"&gt;       &lt;annotation&gt;         &lt;documentation&gt;keine&lt;/documentation&gt;       &lt;/annotation&gt; </pre>		

```

</enumeration>
<enumeration value="0360002">
  <annotation>
    <documentation>leichtgradig</documentation>
  </annotation>
</enumeration>
<enumeration value="0360003">
  <annotation>
    <documentation>mittelgradig</documentation>
  </annotation>
</enumeration>
<enumeration value="0360004">
  <annotation>
    <documentation>hochgradig</documentation>
  </annotation>
</enumeration>
<enumeration value="0360005">
  <annotation>
    <documentation>massive</documentation>
  </annotation>
</enumeration>
<enumeration value="0360006">
  <annotation>
    <documentation>torrential</documentation>
  </annotation>
</enumeration>
<enumeration value="0360099">
  <annotation>
    <documentation>unbekannt</documentation>
  </annotation>
</enumeration>
</restriction>
</simpleType>

```

### simpleType enum\_0361

namespace	http://xml.ir-d.de/irdsaa		
type	restriction of <b>string</b>		
properties	base xs:string		
facets	Kind	Value	Annotation
	enumeration	0361001	documentation nein
	enumeration	0361002	documentation ja, letzte(r) innerhalb der letzten 48 Stunden
	enumeration	0361003	documentation ja, letzte(r) innerhalb der letzten 21 Tage
	enumeration	0361004	documentation ja, letzte(r) länger als 21 Tage
	enumeration	0361098	documentation ja, letzter Zeitpunkt unbekannt
	enumeration	0361099	documentation unbekannt
annotation	documentation Kat_AK_SchockReanimation		
source	<pre> &lt;simpleType name="enum_0361"&gt;   &lt;annotation&gt;     &lt;documentation&gt;Kat AK SchockReanimation&lt;/documentation&gt; </pre>		

```

</annotation>
<restriction base="xs:string">
  <enumeration value="0361001">
    <annotation>
      <documentation>nein</documentation>
    </annotation>
  </enumeration>
  <enumeration value="0361002">
    <annotation>
      <documentation>ja, letzte(r) innerhalb der letzten 48
Stunden</documentation>
    </annotation>
  </enumeration>
  <enumeration value="0361003">
    <annotation>
      <documentation>ja, letzte(r) innerhalb der letzten 21
Tage</documentation>
    </annotation>
  </enumeration>
  <enumeration value="0361004">
    <annotation>
      <documentation>ja, letzte(r) länger als 21 Tage</documentation>
    </annotation>
  </enumeration>
  <enumeration value="0361098">
    <annotation>
      <documentation>ja, letzter Zeitpunkt unbekannt</documentation>
    </annotation>
  </enumeration>
  <enumeration value="0361099">
    <annotation>
      <documentation>unbekannt</documentation>
    </annotation>
  </enumeration>
</restriction>
</simpleType>

```

**simpleType enum\_0362**

namespace	http://xml.ir-d.de/irdsaa		
type	restriction of <b>string</b>		
properties	base xs:string		
facets	Kind	Value	Annotation
	enumeration	0362001	documentation Sinusrhythmus
	enumeration	0362002	documentation Vorhofflimmern
	enumeration	0362042	documentation anderer Herzrhythmus
annotation	documentation Kat_AK_Herzrhythmus		
source	<simpleType name="enum_0362"> <annotation> <documentation>Kat_AK_Herzrhythmus</documentation> </annotation> <restriction base="xs:string"> <enumeration value="0362001">		

	<pre> &lt;annotation&gt;   &lt;documentation&gt;Sinusrhythmus&lt;/documentation&gt; &lt;/annotation&gt; &lt;/enumeration&gt; &lt;enumeration value="0362002"&gt;   &lt;annotation&gt;     &lt;documentation&gt;Vorhofflimmern&lt;/documentation&gt;   &lt;/annotation&gt; &lt;/enumeration&gt; &lt;enumeration value="0362042"&gt;   &lt;annotation&gt;     &lt;documentation&gt;anderer Herzrhythmus&lt;/documentation&gt;   &lt;/annotation&gt; &lt;/enumeration&gt; &lt;/restriction&gt; &lt;/simpleType&gt; </pre>
--	--

### simpleType enum\_0363

namespace	http://xml.ir-d.de/irdsaa		
type	restriction of <b>string</b>		
properties	base xs:string		
facets	Kind	Value	Annotation
	enumeration	0363001	documentation nein
	enumeration	0363002	documentation paroxysmal
	enumeration	0363003	documentation persistierend
	enumeration	0363004	documentation permanent
annotation	documentation Kat_AK_Vorhofflimmern		
source	<pre> &lt;simpleType name="enum_0363"&gt;   &lt;annotation&gt;     &lt;documentation&gt;Kat_AK_Vorhofflimmern&lt;/documentation&gt;   &lt;/annotation&gt;   &lt;restriction base="xs:string"&gt;     &lt;enumeration value="0363001"&gt;       &lt;annotation&gt;         &lt;documentation&gt;nein&lt;/documentation&gt;       &lt;/annotation&gt;     &lt;/enumeration&gt;     &lt;enumeration value="0363002"&gt;       &lt;annotation&gt;         &lt;documentation&gt;paroxysmal&lt;/documentation&gt;       &lt;/annotation&gt;     &lt;/enumeration&gt;     &lt;enumeration value="0363003"&gt;       &lt;annotation&gt;         &lt;documentation&gt;persistierend&lt;/documentation&gt;       &lt;/annotation&gt;     &lt;/enumeration&gt;     &lt;enumeration value="0363004"&gt;       &lt;annotation&gt;         &lt;documentation&gt;permanent&lt;/documentation&gt;       &lt;/annotation&gt;     &lt;/enumeration&gt;   &lt;/restriction&gt; &lt;/simpleType&gt; </pre>		

```

</enumeration>
</restriction>
</simpleType>

```

### simpleType enum\_0364

namespace	http://xml.ir-d.de/irdsaa		
type	restriction of <b>string</b>		
properties	base xs:string		
facets	Kind	Value	Annotation
	enumeration	0364001	documentation nein
	enumeration	0364002	documentation Schrittmacher ohne CRT-System
	enumeration	0364003	documentation Schrittmacher mit CRT-System
	enumeration	0364004	documentation Defibrillator ohne CRT-System
	enumeration	0364005	documentation Defibrillator mit CRT-System
annotation	documentation Kat_AK_SchrittmacherDefi		
source	<pre> &lt;simpleType name="enum_0364"&gt;   &lt;annotation&gt;     &lt;documentation&gt;Kat_AK_SchrittmacherDefi&lt;/documentation&gt;   &lt;/annotation&gt;   &lt;restriction base="xs:string"&gt;     &lt;enumeration value="0364001"&gt;       &lt;annotation&gt;         &lt;documentation&gt;nein&lt;/documentation&gt;       &lt;/annotation&gt;     &lt;/enumeration&gt;     &lt;enumeration value="0364002"&gt;       &lt;annotation&gt;         &lt;documentation&gt;Schrittmacher ohne CRT-System&lt;/documentation&gt;       &lt;/annotation&gt;     &lt;/enumeration&gt;     &lt;enumeration value="0364003"&gt;       &lt;annotation&gt;         &lt;documentation&gt;Schrittmacher mit CRT-System&lt;/documentation&gt;       &lt;/annotation&gt;     &lt;/enumeration&gt;     &lt;enumeration value="0364004"&gt;       &lt;annotation&gt;         &lt;documentation&gt;Defibrillator ohne CRT-System&lt;/documentation&gt;       &lt;/annotation&gt;     &lt;/enumeration&gt;     &lt;enumeration value="0364005"&gt;       &lt;annotation&gt;         &lt;documentation&gt;Defibrillator mit CRT-System&lt;/documentation&gt;       &lt;/annotation&gt;     &lt;/enumeration&gt;   &lt;/restriction&gt; &lt;/simpleType&gt; </pre>		



### simpleType enum\_0365

namespace	http://xml.ir-d.de/irdsaa		
type	restriction of <b>string</b>		
properties	base xs:string		
facets	Kind	Value	Annotation
	enumeration	0365001	documentation nein
	enumeration	0365002	documentation ja, operativ
	enumeration	0365003	documentation ja, interventionell
annotation	documentation Kat_AK_MyokardRevaskularisation		
source	<pre> &lt;simpleType name="enum_0365"&gt;   &lt;annotation&gt;     &lt;documentation&gt;Kat_AK_MyokardRevaskularisation&lt;/documentation&gt;   &lt;/annotation&gt;   &lt;restriction base="xs:string"&gt;     &lt;enumeration value="0365001"&gt;       &lt;annotation&gt;         &lt;documentation&gt;nein&lt;/documentation&gt;       &lt;/annotation&gt;     &lt;/enumeration&gt;     &lt;enumeration value="0365002"&gt;       &lt;annotation&gt;         &lt;documentation&gt;ja, operativ&lt;/documentation&gt;       &lt;/annotation&gt;     &lt;/enumeration&gt;     &lt;enumeration value="0365003"&gt;       &lt;annotation&gt;         &lt;documentation&gt;ja, interventionell&lt;/documentation&gt;       &lt;/annotation&gt;     &lt;/enumeration&gt;   &lt;/restriction&gt; &lt;/simpleType&gt; </pre>		

### simpleType enum\_0366

namespace	http://xml.ir-d.de/irdsaa		
type	restriction of <b>string</b>		
properties	base xs:string		
facets	Kind	Value	Annotation
	enumeration	0366001	documentation nein
	enumeration	0366002	documentation ja, &lt;= 6 Stunden
	enumeration	0366003	documentation ja, &gt; 6 Stunden bis &lt;= 3 Monate
	enumeration	0366004	documentation ja, &gt; 3 Monate
	enumeration	0366099	documentation unbekannt
annotation	documentation Kat_AK_PCI		
source	<pre> &lt;simpleType name="enum_0366"&gt;   &lt;annotation&gt; </pre>		

```

<documentation>Kat_AK_PCI</documentation>
</annotation>
<restriction base="xs:string">
  <enumeration value="0366001">
    <annotation>
      <documentation>nein</documentation>
    </annotation>
  </enumeration>
  <enumeration value="0366002">
    <annotation>
      <documentation>ja, &lt;= 6 Stunden</documentation>
    </annotation>
  </enumeration>
  <enumeration value="0366003">
    <annotation>
      <documentation>ja, &gt; 6 Stunden bis &lt;= 3 Monate</documentation>
    </annotation>
  </enumeration>
  <enumeration value="0366004">
    <annotation>
      <documentation>ja, &gt; 3 Monate</documentation>
    </annotation>
  </enumeration>
  <enumeration value="0366099">
    <annotation>
      <documentation>unbekannt</documentation>
    </annotation>
  </enumeration>
</restriction>
</simpleType>

```

### simpleType enum\_0367

namespace	http://xml.ir-d.de/irdsaa		
type	restriction of <b>string</b>		
properties	base xs:string		
facets	Kind	Value	Annotation
	enumeration	0367001	documentation keine
	enumeration	0367002	documentation Mediastinitis
	enumeration	0367003	documentation Sepsis
	enumeration	0367004	documentation broncho-pulmonale Infektion
	enumeration	0367005	documentation oto-laryngologische Infektion
	enumeration	0367006	documentation floride Endokarditis
	enumeration	0367007	documentation Peritonitis
	enumeration	0367008	documentation Wundinfektion Thorax
	enumeration	0367009	documentation Pleuraempyem
	enumeration	0367010	documentation Venenkatheterinfektion
	enumeration	0367011	documentation

	<p>enumeration 0367012 Harnwegsinfektion documentation Wundinfektion untere Extremitäten</p> <p>enumeration 0367013 documentation HIV-Infektion</p> <p>enumeration 0367014 documentation Hepatitis B oder C</p> <p>enumeration 0367015 documentation andere Wundinfektion</p> <p>enumeration 0367042 documentation sonstige Infektion</p>
annotation	documentation Kat AK Infektion
source	<pre> &lt;simpleType name="enum_0367"&gt;   &lt;annotation&gt;     &lt;documentation&gt;Kat_AK_Infektion&lt;/documentation&gt;   &lt;/annotation&gt;   &lt;restriction base="xs:string"&gt;     &lt;enumeration value="0367001"&gt;       &lt;annotation&gt;         &lt;documentation&gt;keine&lt;/documentation&gt;       &lt;/annotation&gt;     &lt;/enumeration&gt;     &lt;enumeration value="0367002"&gt;       &lt;annotation&gt;         &lt;documentation&gt;Mediastinitis&lt;/documentation&gt;       &lt;/annotation&gt;     &lt;/enumeration&gt;     &lt;enumeration value="0367003"&gt;       &lt;annotation&gt;         &lt;documentation&gt;Sepsis&lt;/documentation&gt;       &lt;/annotation&gt;     &lt;/enumeration&gt;     &lt;enumeration value="0367004"&gt;       &lt;annotation&gt;         &lt;documentation&gt;broncho-pulmonale Infektion&lt;/documentation&gt;       &lt;/annotation&gt;     &lt;/enumeration&gt;     &lt;enumeration value="0367005"&gt;       &lt;annotation&gt;         &lt;documentation&gt;oto-laryngologische Infektion&lt;/documentation&gt;       &lt;/annotation&gt;     &lt;/enumeration&gt;     &lt;enumeration value="0367006"&gt;       &lt;annotation&gt;         &lt;documentation&gt;floride Endokarditis&lt;/documentation&gt;       &lt;/annotation&gt;     &lt;/enumeration&gt;     &lt;enumeration value="0367007"&gt;       &lt;annotation&gt;         &lt;documentation&gt;Peritonitis&lt;/documentation&gt;       &lt;/annotation&gt;     &lt;/enumeration&gt;     &lt;enumeration value="0367008"&gt;       &lt;annotation&gt;         &lt;documentation&gt;Wundinfektion Thorax&lt;/documentation&gt;       &lt;/annotation&gt;     &lt;/enumeration&gt;     &lt;enumeration value="0367009"&gt;       &lt;annotation&gt; </pre>

```

    <documentation>Pleuraempyem</documentation>
  </annotation>
</enumeration>
<enumeration value="0367010">
  <annotation>
    <documentation>Venenkatheterinfektion</documentation>
  </annotation>
</enumeration>
<enumeration value="0367011">
  <annotation>
    <documentation>Harnwegsinfektion</documentation>
  </annotation>
</enumeration>
<enumeration value="0367012">
  <annotation>
    <documentation>Wundinfektion untere Extremitäten</documentation>
  </annotation>
</enumeration>
<enumeration value="0367013">
  <annotation>
    <documentation>HIV-Infektion</documentation>
  </annotation>
</enumeration>
<enumeration value="0367014">
  <annotation>
    <documentation>Hepatitis B oder C</documentation>
  </annotation>
</enumeration>
<enumeration value="0367015">
  <annotation>
    <documentation>andere Wundinfektion</documentation>
  </annotation>
</enumeration>
<enumeration value="0367042">
  <annotation>
    <documentation>sonstige Infektion</documentation>
  </annotation>
</enumeration>
</restriction>
</simpleType>

```

### simpleType enum\_0368

namespace	http://xml.ir-d.de/irdsaa		
type	restriction of <b>string</b>		
properties	base xs:string		
facets	Kind	Value	Annotation
	enumeration	0368001	documentation nein
	enumeration	0368002	documentation ja, COPD mit Dauermedikation
	enumeration	0368003	documentation ja, COPD ohne Dauermedikation
	enumeration	0368004	documentation ja, andere Lungenerkrankungen
	enumeration	0368099	documentation unbekannt

annotation	documentation Kat_AK_Lungenerkrankung
source	<pre> &lt;simpleType name="enum_0368"&gt;   &lt;annotation&gt;     &lt;documentation&gt;Kat_AK_Lungenerkrankung&lt;/documentation&gt;   &lt;/annotation&gt;   &lt;restriction base="xs:string"&gt;     &lt;enumeration value="0368001"&gt;       &lt;annotation&gt;         &lt;documentation&gt;nein&lt;/documentation&gt;       &lt;/annotation&gt;     &lt;/enumeration&gt;     &lt;enumeration value="0368002"&gt;       &lt;annotation&gt;         &lt;documentation&gt;ja, COPD mit Dauermedikation&lt;/documentation&gt;       &lt;/annotation&gt;     &lt;/enumeration&gt;     &lt;enumeration value="0368003"&gt;       &lt;annotation&gt;         &lt;documentation&gt;ja, COPD ohne Dauermedikation&lt;/documentation&gt;       &lt;/annotation&gt;     &lt;/enumeration&gt;     &lt;enumeration value="0368004"&gt;       &lt;annotation&gt;         &lt;documentation&gt;ja, andere Lungenerkrankungen&lt;/documentation&gt;       &lt;/annotation&gt;     &lt;/enumeration&gt;     &lt;enumeration value="0368099"&gt;       &lt;annotation&gt;         &lt;documentation&gt;unbekannt&lt;/documentation&gt;       &lt;/annotation&gt;     &lt;/enumeration&gt;   &lt;/restriction&gt; &lt;/simpleType&gt; </pre>

### simpleType enum\_0369

namespace	http://xml.ir-d.de/irdsaa		
type	restriction of <b>string</b>		
properties	base xs:string		
facets	Kind	Value	Annotation
	enumeration	0369001	documentation nein
	enumeration	0369002	documentation akut
	enumeration	0369003	documentation chronisch
annotation	documentation Kat_AK_Nierenersatztherapie		
source	<pre> &lt;simpleType name="enum_0369"&gt;   &lt;annotation&gt;     &lt;documentation&gt;Kat_AK_Nierenersatztherapie&lt;/documentation&gt;   &lt;/annotation&gt;   &lt;restriction base="xs:string"&gt;     &lt;enumeration value="0369001"&gt;       &lt;annotation&gt;         &lt;documentation&gt;nein&lt;/documentation&gt;       &lt;/annotation&gt;     &lt;/enumeration&gt;   &lt;/restriction&gt; &lt;/simpleType&gt; </pre>		

	<pre> &lt;/annotation&gt; &lt;/enumeration&gt; &lt;enumeration value="0369002"&gt;   &lt;annotation&gt;     &lt;documentation&gt;akut&lt;/documentation&gt;   &lt;/annotation&gt; &lt;/enumeration&gt; &lt;enumeration value="0369003"&gt;   &lt;annotation&gt;     &lt;documentation&gt;chronisch&lt;/documentation&gt;   &lt;/annotation&gt; &lt;/enumeration&gt; &lt;/restriction&gt; &lt;/simpleType&gt; </pre>
--	---

### simpleType enum\_0370

namespace	http://xml.ir-d.de/irdsaa		
type	restriction of <b>string</b>		
properties	base xs:string		
facets	Kind	Value	Annotation
	enumeration	0370001	documentation Echokardiographie
	enumeration	0370002	documentation Herzkatheter
	enumeration	0370042	documentation andere
annotation	documentation Kat_AK_AKOEFMessmethode		
source	<pre> &lt;simpleType name="enum_0370"&gt;   &lt;annotation&gt;     &lt;documentation&gt;Kat_AK_AKOEFMessmethode&lt;/documentation&gt;   &lt;/annotation&gt;   &lt;restriction base="xs:string"&gt;     &lt;enumeration value="0370001"&gt;       &lt;annotation&gt;         &lt;documentation&gt;Echokardiographie&lt;/documentation&gt;       &lt;/annotation&gt;     &lt;/enumeration&gt;     &lt;enumeration value="0370002"&gt;       &lt;annotation&gt;         &lt;documentation&gt;Herzkatheter&lt;/documentation&gt;       &lt;/annotation&gt;     &lt;/enumeration&gt;     &lt;enumeration value="0370042"&gt;       &lt;annotation&gt;         &lt;documentation&gt;andere&lt;/documentation&gt;       &lt;/annotation&gt;     &lt;/enumeration&gt;   &lt;/restriction&gt; &lt;/simpleType&gt; </pre>		

### simpleType enum\_0371

namespace	http://xml.ir-d.de/irdsaa
-----------	---------------------------

type	restriction of <b>string</b>		
properties	base xs:string		
facets	Kind	Value	Annotation
	enumeration	0371001	documentation keine
	enumeration	0371002	documentation leicht
	enumeration	0371003	documentation mittel
	enumeration	0371004	documentation schwer
	enumeration	0371099	documentation unbekannt
annotation	documentation Kat_AK_Verkalkungsgrad		
source	<pre> &lt;simpleType name="enum_0371"&gt;   &lt;annotation&gt;     &lt;documentation&gt;Kat_AK_Verkalkungsgrad&lt;/documentation&gt;   &lt;/annotation&gt;   &lt;restriction base="xs:string"&gt;     &lt;enumeration value="0371001"&gt;       &lt;annotation&gt;         &lt;documentation&gt;keine&lt;/documentation&gt;       &lt;/annotation&gt;     &lt;/enumeration&gt;     &lt;enumeration value="0371002"&gt;       &lt;annotation&gt;         &lt;documentation&gt;leicht&lt;/documentation&gt;       &lt;/annotation&gt;     &lt;/enumeration&gt;     &lt;enumeration value="0371003"&gt;       &lt;annotation&gt;         &lt;documentation&gt;mittel&lt;/documentation&gt;       &lt;/annotation&gt;     &lt;/enumeration&gt;     &lt;enumeration value="0371004"&gt;       &lt;annotation&gt;         &lt;documentation&gt;schwer&lt;/documentation&gt;       &lt;/annotation&gt;     &lt;/enumeration&gt;     &lt;enumeration value="0371099"&gt;       &lt;annotation&gt;         &lt;documentation&gt;unbekannt&lt;/documentation&gt;       &lt;/annotation&gt;     &lt;/enumeration&gt;   &lt;/restriction&gt; &lt;/simpleType&gt; </pre>		

### simpleType **enum\_0372**

namespace	http://xml.ir-d.de/irdsaa		
type	restriction of <b>string</b>		
properties	base xs:string		
facets	Kind	Value	Annotation
	enumeration	0372001	documentation nein

	enumeration 0372002 documentation ja, bicuspide enumeration 0372003 documentation ja, unicuspide enumeration 0372099 documentation unbekannt
annotation	documentation Kat_AK_BiUnicuspideKlappe
source	<pre> &lt;simpleType name="enum_0372"&gt;   &lt;annotation&gt;     &lt;documentation&gt;Kat_AK_BiUnicuspideKlappe&lt;/documentation&gt;   &lt;/annotation&gt;   &lt;restriction base="xs:string"&gt;     &lt;enumeration value="0372001"&gt;       &lt;annotation&gt;         &lt;documentation&gt;nein&lt;/documentation&gt;       &lt;/annotation&gt;     &lt;/enumeration&gt;     &lt;enumeration value="0372002"&gt;       &lt;annotation&gt;         &lt;documentation&gt;ja, bicuspide&lt;/documentation&gt;       &lt;/annotation&gt;     &lt;/enumeration&gt;     &lt;enumeration value="0372003"&gt;       &lt;annotation&gt;         &lt;documentation&gt;ja, unicuspide&lt;/documentation&gt;       &lt;/annotation&gt;     &lt;/enumeration&gt;     &lt;enumeration value="0372099"&gt;       &lt;annotation&gt;         &lt;documentation&gt;unbekannt&lt;/documentation&gt;       &lt;/annotation&gt;     &lt;/enumeration&gt;   &lt;/restriction&gt; &lt;/simpleType&gt; </pre>

### simpleType enum\_0373

namespace	http://xml.ir-d.de/irdsaa		
type	restriction of <b>string</b>		
properties	base xs:string		
facets	Kind	Value	Annotation
	enumeration	0373001	documentation keine
	enumeration	0373002	documentation leichtgradig
	enumeration	0373003	documentation mittelgradig
	enumeration	0373004	documentation hochgradig
	enumeration	0373099	documentation unbekannt
annotation	documentation Kat_AK_Grad		
source	<pre> &lt;simpleType name="enum_0373"&gt;   &lt;annotation&gt;     &lt;documentation&gt;Kat_AK_Grad&lt;/documentation&gt; </pre>		



	<pre> &lt;/annotation&gt; &lt;restriction base="xs:string"&gt;   &lt;enumeration value="0373001"&gt;     &lt;annotation&gt;       &lt;documentation&gt;keine&lt;/documentation&gt;     &lt;/annotation&gt;   &lt;/enumeration&gt;   &lt;enumeration value="0373002"&gt;     &lt;annotation&gt;       &lt;documentation&gt;leichtgradig&lt;/documentation&gt;     &lt;/annotation&gt;   &lt;/enumeration&gt;   &lt;enumeration value="0373003"&gt;     &lt;annotation&gt;       &lt;documentation&gt;mittelgradig&lt;/documentation&gt;     &lt;/annotation&gt;   &lt;/enumeration&gt;   &lt;enumeration value="0373004"&gt;     &lt;annotation&gt;       &lt;documentation&gt;hochgradig&lt;/documentation&gt;     &lt;/annotation&gt;   &lt;/enumeration&gt;   &lt;enumeration value="0373099"&gt;     &lt;annotation&gt;       &lt;documentation&gt;unbekannt&lt;/documentation&gt;     &lt;/annotation&gt;   &lt;/enumeration&gt; &lt;/restriction&gt; &lt;/simpleType&gt; </pre>
--	--

#### simpleType enum\_0374

namespace	http://xml.ir-d.de/irdsaa		
type	restriction of <b>string</b>		
properties	base xs:string		
facets	Kind	Value	Annotation
	enumeration	0374001	documentation nein
	enumeration	0374002	documentation ja, &lt;= 6 Stunden
	enumeration	0374003	documentation ja, &gt; 6 Stunden bis &lt;= 24 Stunden
	enumeration	0374004	documentation ja, &gt; 1 bis 7 Tage
	enumeration	0374005	documentation ja, &gt; 7 bis 21 Tage
	enumeration	0374006	documentation ja, &gt; 21 Tage
	enumeration	0374099	documentation unbekannt
annotation	documentation Kat_AK_InfarktAnamnese		
source	<pre> &lt;simpleType name="enum_0374"&gt;   &lt;annotation&gt;     &lt;documentation&gt;Kat_AK_InfarktAnamnese&lt;/documentation&gt;   &lt;/annotation&gt;   &lt;restriction base="xs:string"&gt; </pre>		

```

<enumeration value="0374001">
  <annotation>
    <documentation>nein</documentation>
  </annotation>
</enumeration>
<enumeration value="0374002">
  <annotation>
    <documentation>ja, &lt;= 6 Stunden</documentation>
  </annotation>
</enumeration>
<enumeration value="0374003">
  <annotation>
    <documentation>ja, &gt; 6 Stunden bis &lt;= 24 Stunden</documentation>
  </annotation>
</enumeration>
<enumeration value="0374004">
  <annotation>
    <documentation>ja, &gt; 1 bis 7 Tage</documentation>
  </annotation>
</enumeration>
<enumeration value="0374005">
  <annotation>
    <documentation>ja, &gt; 7 bis 21 Tage</documentation>
  </annotation>
</enumeration>
<enumeration value="0374006">
  <annotation>
    <documentation>ja, &gt; 21 Tage</documentation>
  </annotation>
</enumeration>
<enumeration value="0374099">
  <annotation>
    <documentation>unbekannt</documentation>
  </annotation>
</enumeration>
</restriction>
</simpleType>

```

### simpleType enum 0375

namespace	http://xml.ir-d.de/irdsaa		
type	restriction of <b>string</b>		
properties	base xs:string		
facets	Kind	Value	Annotation
	enumeration	0375001	documentation keine Symptome oder Angina
	enumeration	0375002	documentation Symptome, aber keine Ischämiezeichen
	enumeration	0375003	documentation stabile Angina
	enumeration	0375004	documentation instabile Angina
	enumeration	0375005	documentation Infarkt ohne ST-Hebung (Non-STEMI)
	enumeration	0375006	documentation Infarkt mit ST-Hebung (STEMI)
	enumeration	0375042	documentation unbekannt

annotation	documentation Kat_AK_KardialeSymptome
source	<pre> &lt;simpleType name="enum_0375"&gt;   &lt;annotation&gt;     &lt;documentation&gt;Kat_AK_KardialeSymptome&lt;/documentation&gt;   &lt;/annotation&gt;   &lt;restriction base="xs:string"&gt;     &lt;enumeration value="0375001"&gt;       &lt;annotation&gt;         &lt;documentation&gt;keine Symptome oder Angina&lt;/documentation&gt;       &lt;/annotation&gt;     &lt;/enumeration&gt;     &lt;enumeration value="0375002"&gt;       &lt;annotation&gt;         &lt;documentation&gt;Symptome, aber keine Ischämiezeichen&lt;/documentation&gt;       &lt;/annotation&gt;     &lt;/enumeration&gt;     &lt;enumeration value="0375003"&gt;       &lt;annotation&gt;         &lt;documentation&gt;stabile Angina&lt;/documentation&gt;       &lt;/annotation&gt;     &lt;/enumeration&gt;     &lt;enumeration value="0375004"&gt;       &lt;annotation&gt;         &lt;documentation&gt;instabile Angina&lt;/documentation&gt;       &lt;/annotation&gt;     &lt;/enumeration&gt;     &lt;enumeration value="0375005"&gt;       &lt;annotation&gt;         &lt;documentation&gt;Infarkt ohne ST-Hebung (Non-STEMI)&lt;/documentation&gt;       &lt;/annotation&gt;     &lt;/enumeration&gt;     &lt;enumeration value="0375006"&gt;       &lt;annotation&gt;         &lt;documentation&gt;Infarkt mit ST-Hebung (STEMI)&lt;/documentation&gt;       &lt;/annotation&gt;     &lt;/enumeration&gt;     &lt;enumeration value="0375042"&gt;       &lt;annotation&gt;         &lt;documentation&gt;unbekannt&lt;/documentation&gt;       &lt;/annotation&gt;     &lt;/enumeration&gt;   &lt;/restriction&gt; &lt;/simpleType&gt; </pre>

### simpleType enum 0376

namespace	http://xml.ir-d.de/irdsaa		
type	restriction of <b>string</b>		
properties	base xs:string		
facets	Kind	Value	Annotation
	enumeration	0376001	documentation nein
	enumeration	0376002	documentation ja, ZNS, zerebrovaskuläre Blutung
	enumeration	0376003	documentation ja, ZNS, zerebrovaskuläre Ischämie

	enumeration 0376042 documentation ja, ZNS, andere
annotation	documentation Kat_AK_Schlaganfall
source	<pre> &lt;simpleType name="enum_0376"&gt;   &lt;annotation&gt;     &lt;documentation&gt;Kat_AK_Schlaganfall&lt;/documentation&gt;   &lt;/annotation&gt;   &lt;restriction base="xs:string"&gt;     &lt;enumeration value="0376001"&gt;       &lt;annotation&gt;         &lt;documentation&gt;nein&lt;/documentation&gt;       &lt;/annotation&gt;     &lt;/enumeration&gt;     &lt;enumeration value="0376002"&gt;       &lt;annotation&gt;         &lt;documentation&gt;ja, ZNS, zerebrovaskuläre Blutung&lt;/documentation&gt;       &lt;/annotation&gt;     &lt;/enumeration&gt;     &lt;enumeration value="0376003"&gt;       &lt;annotation&gt;         &lt;documentation&gt;ja, ZNS, zerebrovaskuläre Ischämie&lt;/documentation&gt;       &lt;/annotation&gt;     &lt;/enumeration&gt;     &lt;enumeration value="0376042"&gt;       &lt;annotation&gt;         &lt;documentation&gt;ja, ZNS, andere&lt;/documentation&gt;       &lt;/annotation&gt;     &lt;/enumeration&gt;   &lt;/restriction&gt; &lt;/simpleType&gt; </pre>

### simpleType enum\_0377

namespace	http://xml.ir-d.de/irdsaa		
type	restriction of <b>string</b>		
properties	base xs:string		
facets	Kind	Value	Annotation
	enumeration	0377001	documentation ja, mild neurological dysfunction: NIHSS 0-5
	enumeration	0377002	documentation ja, moderate neurological dysfunction: NIHSS 6-14
	enumeration	0377003	documentation ja, severe neurological dysfunction: NIHSS >=15
annotation	documentation Kat_AK_Nihss		
source	<pre> &lt;simpleType name="enum_0377"&gt;   &lt;annotation&gt;     &lt;documentation&gt;Kat_AK_Nihss&lt;/documentation&gt;   &lt;/annotation&gt;   &lt;restriction base="xs:string"&gt;     &lt;enumeration value="0377001"&gt;       &lt;annotation&gt;         &lt;documentation&gt;ja, mild neurological dysfunction: NIHSS 0-5&lt;/documentation&gt;       &lt;/annotation&gt;     &lt;/enumeration&gt; </pre>		

	<pre> &lt;enumeration value="0377002"&gt;   &lt;annotation&gt;     &lt;documentation&gt;ja, moderate neurological dysfunction: NIHSS 6-14&lt;/documentation&gt;   &lt;/annotation&gt; &lt;/enumeration&gt; &lt;enumeration value="0377003"&gt;   &lt;annotation&gt;     &lt;documentation&gt; ja, severe neurological dysfunction: NIHSS &amp;gt;=15&lt;/documentation&gt;   &lt;/annotation&gt; &lt;/enumeration&gt; &lt;/restriction&gt; &lt;/simpleType&gt; </pre>
--	---

### simpleType enum\_0378

namespace	http://xml.lir-d.de/irdsaa		
type	restriction of <b>string</b>		
properties	base xs:string		
facets	Kind	Value	Annotation
	enumeration	0378001	documentation nein
	enumeration	0378002	documentation ja, &lt; 48h gemäss VARC-3-Definition
	enumeration	0378003	documentation ja, &gt;= 48h - &lt;= 72h gemäß VARC-3-Definition
	enumeration	0378004	documentation ja, &gt; 72 h gemäß VARC-3 Definition
annotation	documentation Kat_AK_Myokardinfarkt		
source	<pre> &lt;simpleType name="enum_0378"&gt;   &lt;annotation&gt;     &lt;documentation&gt;Kat_AK_Myokardinfarkt&lt;/documentation&gt;   &lt;/annotation&gt;   &lt;restriction base="xs:string"&gt;     &lt;enumeration value="0378001"&gt;       &lt;annotation&gt;         &lt;documentation&gt;nein&lt;/documentation&gt;       &lt;/annotation&gt;     &lt;/enumeration&gt;     &lt;enumeration value="0378002"&gt;       &lt;annotation&gt;         &lt;documentation&gt;ja, &amp;lt; 48h gemäss VARC-3-Definition&lt;/documentation&gt;       &lt;/annotation&gt;     &lt;/enumeration&gt;     &lt;enumeration value="0378003"&gt;       &lt;annotation&gt;         &lt;documentation&gt;ja, &amp;gt;= 48h - &amp;lt;= 72h gemäß VARC-3-Definition&lt;/documentation&gt;       &lt;/annotation&gt;     &lt;/enumeration&gt;     &lt;enumeration value="0378004"&gt;       &lt;annotation&gt;         &lt;documentation&gt;ja, &amp;gt; 72 h gemäß VARC-3 Definition&lt;/documentation&gt;       &lt;/annotation&gt;     &lt;/enumeration&gt;   &lt;/restriction&gt; &lt;/simpleType&gt; </pre>		

	<pre> &lt;/restriction&gt; &lt;/simpleType&gt; </pre>
--	---

### simpleType enum\_0379

namespace	http://xml.ir-d.de/irdsaa		
type	restriction of <b>string</b>		
properties	base xs:string		
facets	Kind	Value	Annotation
	enumeration	0379001	documentation Keine gefäss- oder zugangsassoziierte Komplikationen
	enumeration	0379002	documentation Versagen des perkutanen Verschlusssystems
	enumeration	0379003	documentation Geringfügige Gefäßkomplikationen
	enumeration	0379004	documentation Erhebliche Gefäßkomplikationen
annotation	documentation Kat_AK_ZugangKomplikationen		
source	<pre> &lt;simpleType name="enum_0379"&gt;   &lt;annotation&gt;     &lt;documentation&gt;Kat_AK_ZugangKomplikationen&lt;/documentation&gt;   &lt;/annotation&gt;   &lt;restriction base="xs:string"&gt;     &lt;enumeration value="0379001"&gt;       &lt;annotation&gt;         &lt;documentation&gt;Keine gefäss- oder zugangsassoziierte Komplikationen&lt;/documentation&gt;       &lt;/annotation&gt;     &lt;/enumeration&gt;     &lt;enumeration value="0379002"&gt;       &lt;annotation&gt;         &lt;documentation&gt;Versagen des perkutanen Verschlusssystems&lt;/documentation&gt;       &lt;/annotation&gt;     &lt;/enumeration&gt;     &lt;enumeration value="0379003"&gt;       &lt;annotation&gt;         &lt;documentation&gt;Geringfügige Gefäßkomplikationen&lt;/documentation&gt;       &lt;/annotation&gt;     &lt;/enumeration&gt;     &lt;enumeration value="0379004"&gt;       &lt;annotation&gt;         &lt;documentation&gt;Erhebliche Gefäßkomplikationen&lt;/documentation&gt;       &lt;/annotation&gt;     &lt;/enumeration&gt;   &lt;/restriction&gt; &lt;/simpleType&gt; </pre>		

### simpleType enum\_0380

namespace	http://xml.ir-d.de/irdsaa		
type	restriction of <b>string</b>		
properties	base xs:string		

facets	<table border="1"> <thead> <tr> <th>Kind</th> <th>Value</th> <th>Annotation</th> </tr> </thead> <tbody> <tr> <td>enumeration</td> <td>0380001</td> <td>documentation nein</td> </tr> <tr> <td>enumeration</td> <td>0380002</td> <td>documentation ja, intraprozedural</td> </tr> <tr> <td>enumeration</td> <td>0380003</td> <td>documentation ja, postprozedural</td> </tr> <tr> <td>enumeration</td> <td>0380004</td> <td>documentation ja, Zeitpunkt nicht bekannt</td> </tr> </tbody> </table>	Kind	Value	Annotation	enumeration	0380001	documentation nein	enumeration	0380002	documentation ja, intraprozedural	enumeration	0380003	documentation ja, postprozedural	enumeration	0380004	documentation ja, Zeitpunkt nicht bekannt
Kind	Value	Annotation														
enumeration	0380001	documentation nein														
enumeration	0380002	documentation ja, intraprozedural														
enumeration	0380003	documentation ja, postprozedural														
enumeration	0380004	documentation ja, Zeitpunkt nicht bekannt														
annotation	documentation Kat_AK_Reanimation															
source	<pre> &lt;simpleType name="enum_0380"&gt;   &lt;annotation&gt;     &lt;documentation&gt;Kat_AK_Reanimation&lt;/documentation&gt;   &lt;/annotation&gt;   &lt;restriction base="xs:string"&gt;     &lt;enumeration value="0380001"&gt;       &lt;annotation&gt;         &lt;documentation&gt;nein&lt;/documentation&gt;       &lt;/annotation&gt;     &lt;/enumeration&gt;     &lt;enumeration value="0380002"&gt;       &lt;annotation&gt;         &lt;documentation&gt;ja, intraprozedural&lt;/documentation&gt;       &lt;/annotation&gt;     &lt;/enumeration&gt;     &lt;enumeration value="0380003"&gt;       &lt;annotation&gt;         &lt;documentation&gt;ja, postprozedural&lt;/documentation&gt;       &lt;/annotation&gt;     &lt;/enumeration&gt;     &lt;enumeration value="0380004"&gt;       &lt;annotation&gt;         &lt;documentation&gt;ja, Zeitpunkt nicht bekannt&lt;/documentation&gt;       &lt;/annotation&gt;     &lt;/enumeration&gt;   &lt;/restriction&gt; &lt;/simpleType&gt; </pre>															

### simpleType enum\_0381

namespace	http://xml.ir-d.de/irdsaa																		
type	restriction of <b>string</b>																		
properties	base xs:string																		
facets	<table border="1"> <thead> <tr> <th>Kind</th> <th>Value</th> <th>Annotation</th> </tr> </thead> <tbody> <tr> <td>enumeration</td> <td>0381001</td> <td>documentation nein</td> </tr> <tr> <td>enumeration</td> <td>0381002</td> <td>documentation Thorakotomie/Rethorakotomie</td> </tr> <tr> <td>enumeration</td> <td>0381003</td> <td>documentation kathetergestützte Reintervention</td> </tr> <tr> <td>enumeration</td> <td>0381004</td> <td>documentation lokale Reinterventionen</td> </tr> <tr> <td>enumeration</td> <td>0381005</td> <td>documentation andere Reintervention</td> </tr> </tbody> </table>	Kind	Value	Annotation	enumeration	0381001	documentation nein	enumeration	0381002	documentation Thorakotomie/Rethorakotomie	enumeration	0381003	documentation kathetergestützte Reintervention	enumeration	0381004	documentation lokale Reinterventionen	enumeration	0381005	documentation andere Reintervention
Kind	Value	Annotation																	
enumeration	0381001	documentation nein																	
enumeration	0381002	documentation Thorakotomie/Rethorakotomie																	
enumeration	0381003	documentation kathetergestützte Reintervention																	
enumeration	0381004	documentation lokale Reinterventionen																	
enumeration	0381005	documentation andere Reintervention																	
annotation	documentation Kat_AK_Massnahmen																		

source	<pre> &lt;simpleType name="enum_0381"&gt;   &lt;annotation&gt;     &lt;documentation&gt;Kat_AK_Massnahmen&lt;/documentation&gt;   &lt;/annotation&gt;   &lt;restriction base="xs:string"&gt;     &lt;enumeration value="0381001"&gt;       &lt;annotation&gt;         &lt;documentation&gt;nein&lt;/documentation&gt;       &lt;/annotation&gt;     &lt;/enumeration&gt;     &lt;enumeration value="0381002"&gt;       &lt;annotation&gt;         &lt;documentation&gt;Thorakotomie/Rethorakotomie&lt;/documentation&gt;       &lt;/annotation&gt;     &lt;/enumeration&gt;     &lt;enumeration value="0381003"&gt;       &lt;annotation&gt;         &lt;documentation&gt;kathetergestützte Reintervention&lt;/documentation&gt;       &lt;/annotation&gt;     &lt;/enumeration&gt;     &lt;enumeration value="0381004"&gt;       &lt;annotation&gt;         &lt;documentation&gt;lokale Reinterventionen&lt;/documentation&gt;       &lt;/annotation&gt;     &lt;/enumeration&gt;     &lt;enumeration value="0381005"&gt;       &lt;annotation&gt;         &lt;documentation&gt;andere Reintervention&lt;/documentation&gt;       &lt;/annotation&gt;     &lt;/enumeration&gt;   &lt;/restriction&gt; &lt;/simpleType&gt; </pre>
--------	---

### simpleType enum\_0382

namespace	http://xml.ir-d.de/irdsaa		
type	restriction of <b>string</b>		
properties	base	xs:string	
facets	Kind	Value	Annotation
	enumeration	0382001	documentation keine Rethorakotomie / kein weiterer Grund
	enumeration	0382002	documentation Blutung/Hämatom
	enumeration	0382003	documentation Low Cardiac Output
	enumeration	0382004	documentation Tamponade
	enumeration	0382005	documentation Graftprobleme, Ischämie
	enumeration	0382006	documentation Wundinfektion, Mediastinitis
	enumeration	0382007	documentation Dissektion
	enumeration	0382008	documentation Prothesendysfunktion
	enumeration	0382009	documentation instabiles Sternum
	enumeration	0382010	documentation



	<p>enumeration 0382011 Chylothorax documentation lokale Revision im Bereich des Zugangsweges</p> <p>enumeration 0382042 documentation anderer Grund</p>
annotation	documentation Kat_AK_Komplikation
source	<pre> &lt;simpleType name="enum_0382"&gt;   &lt;annotation&gt;     &lt;documentation&gt;Kat_AK_Komplikation&lt;/documentation&gt;   &lt;/annotation&gt;   &lt;restriction base="xs:string"&gt;     &lt;enumeration value="0382001"&gt;       &lt;annotation&gt;         &lt;documentation&gt;keine Rethorakotomie / kein weiterer Grund&lt;/documentation&gt;       &lt;/annotation&gt;     &lt;/enumeration&gt;     &lt;enumeration value="0382002"&gt;       &lt;annotation&gt;         &lt;documentation&gt;Blutung/Hämatom&lt;/documentation&gt;       &lt;/annotation&gt;     &lt;/enumeration&gt;     &lt;enumeration value="0382003"&gt;       &lt;annotation&gt;         &lt;documentation&gt;Low Cardiac Output&lt;/documentation&gt;       &lt;/annotation&gt;     &lt;/enumeration&gt;     &lt;enumeration value="0382004"&gt;       &lt;annotation&gt;         &lt;documentation&gt;Tamponade&lt;/documentation&gt;       &lt;/annotation&gt;     &lt;/enumeration&gt;     &lt;enumeration value="0382005"&gt;       &lt;annotation&gt;         &lt;documentation&gt;Graftprobleme, Ischämie&lt;/documentation&gt;       &lt;/annotation&gt;     &lt;/enumeration&gt;     &lt;enumeration value="0382006"&gt;       &lt;annotation&gt;         &lt;documentation&gt;Wundinfektion, Mediastinitis&lt;/documentation&gt;       &lt;/annotation&gt;     &lt;/enumeration&gt;     &lt;enumeration value="0382007"&gt;       &lt;annotation&gt;         &lt;documentation&gt;Dissektion&lt;/documentation&gt;       &lt;/annotation&gt;     &lt;/enumeration&gt;     &lt;enumeration value="0382008"&gt;       &lt;annotation&gt;         &lt;documentation&gt;Prothesendysfunktion&lt;/documentation&gt;       &lt;/annotation&gt;     &lt;/enumeration&gt;     &lt;enumeration value="0382009"&gt;       &lt;annotation&gt;         &lt;documentation&gt;instabiles Sternum&lt;/documentation&gt;       &lt;/annotation&gt;     &lt;/enumeration&gt;     &lt;enumeration value="0382010"&gt; </pre>

	<pre> &lt;annotation&gt;   &lt;documentation&gt;Chylothorax&lt;/documentation&gt; &lt;/annotation&gt; &lt;/enumeration&gt; &lt;enumeration value="0382011"&gt;   &lt;annotation&gt;     &lt;documentation&gt;lokale Revision im Bereich des Zugangsweges&lt;/documentation&gt;   &lt;/annotation&gt; &lt;/enumeration&gt; &lt;enumeration value="0382042"&gt;   &lt;annotation&gt;     &lt;documentation&gt;anderer Grund&lt;/documentation&gt;   &lt;/annotation&gt; &lt;/enumeration&gt; &lt;/restriction&gt; &lt;/simpleType&gt; </pre>
--	--

### simpleType enum 0383

namespace	http://xml.ir-d.de/irdsaa		
type	restriction of <b>string</b>		
properties	base xs:string		
facets	Kind	Value	Annotation
	enumeration	0383001	documentation nein
	enumeration	0383002	documentation ja, mit forcierter Atemtherapie
	enumeration	0383003	documentation ja, Reintubation oder längerfristige Beatmung
	enumeration	0383004	documentation ja, Tracheotomie
annotation	documentation Kat_AK_RespiratorischeInsuffizienz		
source	<pre> &lt;simpleType name="enum_0383"&gt;   &lt;annotation&gt;     &lt;documentation&gt;Kat_AK_RespiratorischeInsuffizienz&lt;/documentation&gt;   &lt;/annotation&gt;   &lt;restriction base="xs:string"&gt;     &lt;enumeration value="0383001"&gt;       &lt;annotation&gt;         &lt;documentation&gt;nein&lt;/documentation&gt;       &lt;/annotation&gt;     &lt;/enumeration&gt;     &lt;enumeration value="0383002"&gt;       &lt;annotation&gt;         &lt;documentation&gt;ja, mit forcierter Atemtherapie&lt;/documentation&gt;       &lt;/annotation&gt;     &lt;/enumeration&gt;     &lt;enumeration value="0383003"&gt;       &lt;annotation&gt;         &lt;documentation&gt;ja, Reintubation oder längerfristige Beatmung&lt;/documentation&gt;       &lt;/annotation&gt;     &lt;/enumeration&gt;     &lt;enumeration value="0383004"&gt;       &lt;annotation&gt; </pre>		

	<pre> &lt;documentation&gt;ja, Tracheotomie&lt;/documentation&gt; &lt;/annotation&gt; &lt;/enumeration&gt; &lt;/restriction&gt; &lt;/simpleType&gt; </pre>
--	--

### simpleType enum\_0384

namespace	http://xml.ir-d.de/irdsaa		
type	restriction of <b>string</b>		
properties	base xs:string		
facets	Kind	Value	Annotation
	enumeration	0384001	documentation keine Blutungskomplikationen
	enumeration	0384002	documentation Geringfügige Blutung (Minor Bleeding - BARC type 2 or 3a)
	enumeration	0384003	documentation Starke Blutung (Major Bleeding - BARC type 3a)
	enumeration	0384004	documentation Lebensbedrohliche Blutung (Life-threatening or disabling bleeding - BARC type 3b or 3c or type 5)
annotation	documentation Kat_AK_Blutungskomplikation		
source	<pre> &lt;simpleType name="enum_0384"&gt;   &lt;annotation&gt;     &lt;documentation&gt;Kat_AK_Blutungskomplikation&lt;/documentation&gt;   &lt;/annotation&gt;   &lt;restriction base="xs:string"&gt;     &lt;enumeration value="0384001"&gt;       &lt;annotation&gt;         &lt;documentation&gt;keine Blutungskomplikationen&lt;/documentation&gt;       &lt;/annotation&gt;     &lt;/enumeration&gt;     &lt;enumeration value="0384002"&gt;       &lt;annotation&gt;         &lt;documentation&gt;Geringfügige Blutung (Minor Bleeding - BARC type 2 or 3a)&lt;/documentation&gt;       &lt;/annotation&gt;     &lt;/enumeration&gt;     &lt;enumeration value="0384003"&gt;       &lt;annotation&gt;         &lt;documentation&gt;Starke Blutung (Major Bleeding - BARC type 3a)&lt;/documentation&gt;       &lt;/annotation&gt;     &lt;/enumeration&gt;     &lt;enumeration value="0384004"&gt;       &lt;annotation&gt;         &lt;documentation&gt;Lebensbedrohliche Blutung (Life-threatening or disabling bleeding - BARC type 3b or 3c or type 5)&lt;/documentation&gt;       &lt;/annotation&gt;     &lt;/enumeration&gt;   &lt;/restriction&gt; &lt;/simpleType&gt; </pre>		

### simpleType enum\_0385

namespace	http://xml.ir-d.de/irdsaa		
type	restriction of <b>string</b>		
properties	base xs:string		
facets	Kind	Value	Annotation
	enumeration	0385001	documentation Sinusrhythmus
	enumeration	0385002	documentation Vorhofflimmern
	enumeration	0385003	documentation Patient verstorben (kein Herzrhythmus)
	enumeration	0385042	documentation anderer Rhythmus
annotation	documentation Kat_AK_HerzrhythmusEntlassung		
source	<pre> &lt;simpleType name="enum_0385"&gt;   &lt;annotation&gt;     &lt;documentation&gt;Kat_AK_HerzrhythmusEntlassung&lt;/documentation&gt;   &lt;/annotation&gt;   &lt;restriction base="xs:string"&gt;     &lt;enumeration value="0385001"&gt;       &lt;annotation&gt;         &lt;documentation&gt;Sinusrhythmus&lt;/documentation&gt;       &lt;/annotation&gt;     &lt;/enumeration&gt;     &lt;enumeration value="0385002"&gt;       &lt;annotation&gt;         &lt;documentation&gt;Vorhofflimmern&lt;/documentation&gt;       &lt;/annotation&gt;     &lt;/enumeration&gt;     &lt;enumeration value="0385003"&gt;       &lt;annotation&gt;         &lt;documentation&gt;Patient verstorben (kein Herzrhythmus)&lt;/documentation&gt;       &lt;/annotation&gt;     &lt;/enumeration&gt;     &lt;enumeration value="0385042"&gt;       &lt;annotation&gt;         &lt;documentation&gt;anderer Rhythmus&lt;/documentation&gt;       &lt;/annotation&gt;     &lt;/enumeration&gt;   &lt;/restriction&gt; &lt;/simpleType&gt; </pre>		

### simpleType enum\_0388

namespace	http://xml.ir-d.de/irdsaa		
type	restriction of <b>string</b>		
properties	base xs:string		
facets	Kind	Value	Annotation
	enumeration	0388001	documentation nein
	enumeration	0388002	documentation ASS
	enumeration	0388003	documentation ADP-Rezeptor-Antagonist
	enumeration	0388004	documentation

	enumeration 0388042 Kombination ASS und ADP-Rezeptor-Antagonist documentation ja, andere enumeration 0388099 documentation unbekannt
annotation	documentation Kat_AK_Plaettchenaggregationshemmer
source	<pre> &lt;simpleType name="enum_0388"&gt;   &lt;annotation&gt;     &lt;documentation&gt;Kat_AK_Plaettchenaggregationshemmer&lt;/documentation&gt;   &lt;/annotation&gt;   &lt;restriction base="xs:string"&gt;     &lt;enumeration value="0388001"&gt;       &lt;annotation&gt;         &lt;documentation&gt;nein&lt;/documentation&gt;       &lt;/annotation&gt;     &lt;/enumeration&gt;     &lt;enumeration value="0388002"&gt;       &lt;annotation&gt;         &lt;documentation&gt;ASS&lt;/documentation&gt;       &lt;/annotation&gt;     &lt;/enumeration&gt;     &lt;enumeration value="0388003"&gt;       &lt;annotation&gt;         &lt;documentation&gt;ADP-Rezeptor-Antagonist&lt;/documentation&gt;       &lt;/annotation&gt;     &lt;/enumeration&gt;     &lt;enumeration value="0388004"&gt;       &lt;annotation&gt;         &lt;documentation&gt;Kombination ASS und         ADP-Rezeptor-Antagonist&lt;/documentation&gt;       &lt;/annotation&gt;     &lt;/enumeration&gt;     &lt;enumeration value="0388042"&gt;       &lt;annotation&gt;         &lt;documentation&gt;ja, andere&lt;/documentation&gt;       &lt;/annotation&gt;     &lt;/enumeration&gt;     &lt;enumeration value="0388099"&gt;       &lt;annotation&gt;         &lt;documentation&gt;unbekannt&lt;/documentation&gt;       &lt;/annotation&gt;     &lt;/enumeration&gt;   &lt;/restriction&gt; &lt;/simpleType&gt; </pre>

### simpleType enum\_0389

namespace	http://xml.ir-d.de/irdsaa		
type	restriction of <b>string</b>		
properties	base	xs:string	
facets	Kind	Value	Annotation
	enumeration	0389001	documentation nein
	enumeration	0389002	documentation Cumarin-Derivate
	enumeration	0389003	documentation

	<p>enumeration 0389004 Heparinoide documentation orale Thrombinantagonisten</p> <p>enumeration 0389005 documentation Kombination Heparinoide und Cumarin-Derivate</p> <p>enumeration 0389006 documentation Direkte orale Antikoagulantien (DOAK / NOAK)</p> <p>enumeration 0389042 documentation ja, andere</p> <p>enumeration 0389099 documentation unbekannt</p>
annotation	documentation Kat AK Antikoagulantien
source	<pre> &lt;simpleType name="enum_0389"&gt;   &lt;annotation&gt;     &lt;documentation&gt;Kat_AK_Antikoagulantien&lt;/documentation&gt;   &lt;/annotation&gt;   &lt;restriction base="xs:string"&gt;     &lt;enumeration value="0389001"&gt;       &lt;annotation&gt;         &lt;documentation&gt;nein&lt;/documentation&gt;       &lt;/annotation&gt;     &lt;/enumeration&gt;     &lt;enumeration value="0389002"&gt;       &lt;annotation&gt;         &lt;documentation&gt;Cumarin-Derivate&lt;/documentation&gt;       &lt;/annotation&gt;     &lt;/enumeration&gt;     &lt;enumeration value="0389003"&gt;       &lt;annotation&gt;         &lt;documentation&gt;Heparinoide&lt;/documentation&gt;       &lt;/annotation&gt;     &lt;/enumeration&gt;     &lt;enumeration value="0389004"&gt;       &lt;annotation&gt;         &lt;documentation&gt;orale Thrombinantagonisten&lt;/documentation&gt;       &lt;/annotation&gt;     &lt;/enumeration&gt;     &lt;enumeration value="0389005"&gt;       &lt;annotation&gt;         &lt;documentation&gt;Kombination Heparinoide und Cumarin-Derivate&lt;/documentation&gt;       &lt;/annotation&gt;     &lt;/enumeration&gt;     &lt;enumeration value="0389006"&gt;       &lt;annotation&gt;         &lt;documentation&gt;Direkte orale Antikoagulantien (DOAK / NOAK)&lt;/documentation&gt;       &lt;/annotation&gt;     &lt;/enumeration&gt;     &lt;enumeration value="0389042"&gt;       &lt;annotation&gt;         &lt;documentation&gt;ja, andere&lt;/documentation&gt;       &lt;/annotation&gt;     &lt;/enumeration&gt;     &lt;enumeration value="0389099"&gt;       &lt;annotation&gt;         &lt;documentation&gt;unbekannt&lt;/documentation&gt;       &lt;/annotation&gt;     &lt;/enumeration&gt;   &lt;/restriction&gt; &lt;/simpleType&gt; </pre>

	<pre> &lt;/restriction&gt; &lt;/simpleType&gt; </pre>
--	---

### simpleType enum\_0390

namespace	http://xml.ir-d.de/irdsaa		
type	restriction of <b>string</b>		
properties	base xs:string		
facets	Kind	Value	Annotation
	enumeration	0390001	documentation biologisches Klappenmodell
	enumeration	0390002	documentation mechanisches Klappenmodell
annotation	documentation Kat_AK_Artikeltyp		
source	<pre> &lt;simpleType name="enum_0390"&gt;   &lt;annotation&gt;     &lt;documentation&gt;Kat_AK_Artikeltyp&lt;/documentation&gt;   &lt;/annotation&gt;   &lt;restriction base="xs:string"&gt;     &lt;enumeration value="0390001"&gt;       &lt;annotation&gt;         &lt;documentation&gt;biologisches Klappenmodell&lt;/documentation&gt;       &lt;/annotation&gt;     &lt;/enumeration&gt;     &lt;enumeration value="0390002"&gt;       &lt;annotation&gt;         &lt;documentation&gt;mechanisches Klappenmodell&lt;/documentation&gt;       &lt;/annotation&gt;     &lt;/enumeration&gt;   &lt;/restriction&gt; &lt;/simpleType&gt; </pre>		

### simpleType enum\_0398

namespace	http://xml.ir-d.de/irdsaa		
type	restriction of <b>string</b>		
properties	base xs:string		
facets	Kind	Value	Annotation
	enumeration	0398001	documentation kardiovaskuläre Ursache
	enumeration	0398002	documentation nicht-kardiovaskuläre Ursache
	enumeration	0398099	documentation Todesursache unbekannt
annotation	documentation Kat_AK_Todesursache		
source	<pre> &lt;simpleType name="enum_0398"&gt;   &lt;annotation&gt;     &lt;documentation&gt;Kat_AK_Todesursache&lt;/documentation&gt;   &lt;/annotation&gt;   &lt;restriction base="xs:string"&gt;     &lt;enumeration value="0398001"&gt;       &lt;annotation&gt; </pre>		

	<pre> &lt;documentation&gt;kardiovaskuläre Ursache&lt;/documentation&gt; &lt;/annotation&gt; &lt;/enumeration&gt; &lt;enumeration value="0398002"&gt;   &lt;annotation&gt;     &lt;documentation&gt;nicht-kardiovaskuläre Ursache&lt;/documentation&gt;   &lt;/annotation&gt; &lt;/enumeration&gt; &lt;enumeration value="0398099"&gt;   &lt;annotation&gt;     &lt;documentation&gt;Todesursache unbekannt&lt;/documentation&gt;   &lt;/annotation&gt; &lt;/enumeration&gt; &lt;/restriction&gt; &lt;/simpleType&gt; </pre>
--	--

### simpleType enum\_0399

namespace	http://xml.ir-d.de/irdsaa		
type	restriction of <b>string</b>		
properties	base xs:string		
facets	Kind	Value	Annotation
	enumeration	0399001	documentation Patient lebt
	enumeration	0399002	documentation Patient im Krankenhaus verstorben
annotation	documentation Kat_AK_Vitalstatus		
source	<pre> &lt;simpleType name="enum_0399"&gt;   &lt;annotation&gt;     &lt;documentation&gt;Kat_AK_Vitalstatus&lt;/documentation&gt;   &lt;/annotation&gt;   &lt;restriction base="xs:string"&gt;     &lt;enumeration value="0399001"&gt;       &lt;annotation&gt;         &lt;documentation&gt;Patient lebt&lt;/documentation&gt;       &lt;/annotation&gt;     &lt;/enumeration&gt;     &lt;enumeration value="0399002"&gt;       &lt;annotation&gt;         &lt;documentation&gt;Patient im Krankenhaus verstorben&lt;/documentation&gt;       &lt;/annotation&gt;     &lt;/enumeration&gt;   &lt;/restriction&gt; &lt;/simpleType&gt; </pre>		

### simpleType enum\_0044

namespace	http://xml.ir-d.de/emg		
type	restriction of <b>string</b>		
properties	base xs:string		
used by	element	<a href="#">OperationBasis/OPE_AsaSchlüssel</a>	
facets	Kind	Value	Annotation



	<p>enumeration 0044001 documentation 1= normaler, sonst gesunder Patient</p> <p>enumeration 0044002 documentation 2= Patient mit leichter Allgemeinerkrankung</p> <p>enumeration 0044003 documentation 3= Patient mit schwerer Allgemeinerkrankung</p> <p>enumeration 0044004 documentation 4= Patient mit schwerer Allgemeinerkrankung, die eine ständige Lebensbedrohung darstellt</p> <p>enumeration 0044005 documentation 5= moribunder Patient, der ohne die Operation voraussichtlich nicht überleben wird</p>
annotation	documentation Kat ASA
source	<pre> &lt;simpleType name="enum_0044"&gt;   &lt;annotation&gt;     &lt;documentation&gt;Kat_ASA&lt;/documentation&gt;   &lt;/annotation&gt;   &lt;restriction base="xs:string"&gt;     &lt;enumeration value="0044001"&gt;       &lt;annotation&gt;         &lt;documentation&gt;1= normaler, sonst gesunder Patient&lt;/documentation&gt;       &lt;/annotation&gt;     &lt;/enumeration&gt;     &lt;enumeration value="0044002"&gt;       &lt;annotation&gt;         &lt;documentation&gt;2= Patient mit leichter Allgemeinerkrankung&lt;/documentation&gt;       &lt;/annotation&gt;     &lt;/enumeration&gt;     &lt;enumeration value="0044003"&gt;       &lt;annotation&gt;         &lt;documentation&gt;3= Patient mit schwerer Allgemeinerkrankung&lt;/documentation&gt;       &lt;/annotation&gt;     &lt;/enumeration&gt;     &lt;enumeration value="0044004"&gt;       &lt;annotation&gt;         &lt;documentation&gt;4= Patient mit schwerer Allgemeinerkrankung, die eine ständige Lebensbedrohung darstellt&lt;/documentation&gt;       &lt;/annotation&gt;     &lt;/enumeration&gt;     &lt;enumeration value="0044005"&gt;       &lt;annotation&gt;         &lt;documentation&gt;5= moribunder Patient, der ohne die Operation voraussichtlich nicht überleben wird&lt;/documentation&gt;       &lt;/annotation&gt;     &lt;/enumeration&gt;   &lt;/restriction&gt; &lt;/simpleType&gt; </pre>

### simpleType enum\_0050

namespace	http://xml.ir-d.de/emg
type	restriction of <b>string</b>
properties	base xs:string
used by	element <a href="#">OperationBasis/OPE SeitenLokalisationSchluessel</a>

facets	Kind enumeration	Value 0050001	Annotation documentation rechts
	enumeration	0050002	documentation links
annotation	documentation Kat_RechtsLinks		
source	<pre> &lt;simpleType name="enum_0050"&gt;   &lt;annotation&gt;     &lt;documentation&gt;Kat_RechtsLinks&lt;/documentation&gt;   &lt;/annotation&gt;   &lt;restriction base="xs:string"&gt;     &lt;enumeration value="0050001"&gt;       &lt;annotation&gt;         &lt;documentation&gt;rechts&lt;/documentation&gt;       &lt;/annotation&gt;     &lt;/enumeration&gt;     &lt;enumeration value="0050002"&gt;       &lt;annotation&gt;         &lt;documentation&gt;links&lt;/documentation&gt;       &lt;/annotation&gt;     &lt;/enumeration&gt;   &lt;/restriction&gt; &lt;/simpleType&gt; </pre>		

### simpleType enum\_0060

namespace	http://xml.ir-d.de/emg
type	restriction of <b>string</b>
properties	base xs:string
used by	<p>elements</p> <ul style="list-style-type: none"> <li><a href="#">ArtikelidentifikationBasis/ARI_SonderstatusJNSchluessel</a></li> <li><a href="#">OperationAortenklappeBasis/OAK_AortaThorakalSchluessel</a></li> <li><a href="#">OperationAortenklappeBasis/OAK_BeatmungSchluessel</a></li> <li><a href="#">OperationAortenklappeBasis/OAK_ExplantationSchluessel</a></li> <li><a href="#">OperationAortenklappeBasis/OAK_InotropeSchluessel</a></li> <li><a href="#">OperationAortenklappeBasis/OAK_IntraOpUnterstuetzungSchluessel</a></li> <li><a href="#">OperationAortenklappeBasis/OAK_IsoliertSchluessel</a></li> <li><a href="#">OperationAortenklappeBasis/OAK_KomplikationenSchluessel</a></li> <li><a href="#">OperationAortenklappeBasis/OAK_KreislaufunterstuetzungSchluessel</a></li> <li><a href="#">OperationAortenklappeBasis/OAK_NeuroprotektionSchluessel</a></li> <li><a href="#">OperationAortenklappeBasis/OAK_PciWegenKhkSchluessel</a></li> <li><a href="#">OperationAortenklappeBasis/OAK_PciWegenKomplikationSchluessel</a></li> <li><a href="#">OperationAortenklappeBasis/OAK_PraeOpUnterstu etzungSchluessel</a></li> <li><a href="#">OperationAortenklappeBasis/OAK_PtcaNachSchluessel</a></li> <li><a href="#">OperationAortenklappeBasis/OAK_PtcaVorSchluessel</a></li> <li><a href="#">OperationAortenklappeBasis/OAK_RapidPacingIntraSchluessel</a></li> <li><a href="#">OperationAortenklappeBasis/OAK_RapidPacingNachSchluessel</a></li> <li><a href="#">OperationAortenklappeBasis/OAK_RapidPacingVorSchluessel</a></li> <li><a href="#">OperationAortenklappeBasis/OAK_SuccessSchluessel</a></li> <li><a href="#">OperationAortenklappeBasis/OAK_TroponinSchluessel</a></li> <li><a href="#">OperationAortenklappeBasis/OAK_ValvelnValveSchluessel</a></li> <li><a href="#">OperationAortenklappeBasis/OAK_ZusaetzlichePciSchluessel</a></li> <li><a href="#">OperationEndoprotheseBasis/OEP_FrakturJNSchluessel</a></li> <li><a href="#">PostoperationAortenklappeBasis/POA_AvBlockSchluessel</a></li> <li><a href="#">PostoperationAortenklappeBasis/POA_EndokarditisSchluessel</a></li> <li><a href="#">PostoperationAortenklappeBasis/POA_IntraOpVerstorb enSchluessel</a></li> <li><a href="#">PostoperationAortenklappeBasis/POA_Nierener satzSchluessel</a></li> <li><a href="#">PostoperationAortenklappeBasis/POA_SepsisSchluessel</a></li> <li><a href="#">PostoperationAortenklappeBasis/POA_VorhofflimmernSchluessel</a></li> </ul>

facets	<table> <thead> <tr> <th>Kind</th> <th>Value</th> <th>Annotation</th> </tr> </thead> <tbody> <tr> <td>enumeration</td> <td>0060001</td> <td>documentation ja</td> </tr> <tr> <td>enumeration</td> <td>0060002</td> <td>documentation nein</td> </tr> </tbody> </table>	Kind	Value	Annotation	enumeration	0060001	documentation ja	enumeration	0060002	documentation nein
Kind	Value	Annotation								
enumeration	0060001	documentation ja								
enumeration	0060002	documentation nein								
annotation	documentation Kat_JaNein									
source	<pre> &lt;simpleType name="enum_0060"&gt;   &lt;annotation&gt;     &lt;documentation&gt;Kat_JaNein&lt;/documentation&gt;   &lt;/annotation&gt;   &lt;restriction base="xs:string"&gt;     &lt;enumeration value="0060001"&gt;       &lt;annotation&gt;         &lt;documentation&gt;ja&lt;/documentation&gt;       &lt;/annotation&gt;     &lt;/enumeration&gt;     &lt;enumeration value="0060002"&gt;       &lt;annotation&gt;         &lt;documentation&gt;nein&lt;/documentation&gt;       &lt;/annotation&gt;     &lt;/enumeration&gt;   &lt;/restriction&gt; &lt;/simpleType&gt; </pre>									

### simpleType **enum\_0061**

namespace	http://xml.ir-d.de/emg												
type	restriction of <b>string</b>												
properties	base xs:string												
used by	<p>elements</p> <ul style="list-style-type: none"> <li><a href="#">OperationAortenklappeBasis/OAK ZugangVerkalkungSchluessel</a></li> <li><a href="#">PatientenaufnahmeAortenklappeBasis/PAA AortenaneurysmaSchluessel</a></li> <li><a href="#">PatientenaufnahmeAortenklappeBasis/PAA ArteriaCarotisSchluessel</a></li> <li><a href="#">PatientenaufnahmeAortenklappeBasis/PAA AvkSchluessel</a></li> <li><a href="#">PatientenaufnahmeAortenklappeBasis/PAA HypertonusSchluessel</a></li> <li><a href="#">PatientenaufnahmeAortenklappeBasis/PAA PAVKSchluessel</a></li> <li><a href="#">PatientenaufnahmeAortenklappeBasis/PAA SonstigeAvkSchluessel</a></li> <li><a href="#">PatientenaufnahmeAortenklappeBasis/PAA ValvuloplastieSchluessel</a></li> </ul>												
facets	<table> <thead> <tr> <th>Kind</th> <th>Value</th> <th>Annotation</th> </tr> </thead> <tbody> <tr> <td>enumeration</td> <td>0061001</td> <td>documentation ja</td> </tr> <tr> <td>enumeration</td> <td>0061002</td> <td>documentation nein</td> </tr> <tr> <td>enumeration</td> <td>0061099</td> <td>documentation unbekannt</td> </tr> </tbody> </table>	Kind	Value	Annotation	enumeration	0061001	documentation ja	enumeration	0061002	documentation nein	enumeration	0061099	documentation unbekannt
Kind	Value	Annotation											
enumeration	0061001	documentation ja											
enumeration	0061002	documentation nein											
enumeration	0061099	documentation unbekannt											
annotation	documentation Kat_JaNeinUnbekannt												
source	<pre> &lt;simpleType name="enum_0061"&gt;   &lt;annotation&gt;     &lt;documentation&gt;Kat_JaNeinUnbekannt&lt;/documentation&gt;   &lt;/annotation&gt;   &lt;restriction base="xs:string"&gt;     &lt;enumeration value="0061001"&gt;       &lt;annotation&gt;         &lt;documentation&gt;ja&lt;/documentation&gt;       &lt;/annotation&gt;     &lt;/enumeration&gt;     &lt;enumeration value="0061002"&gt; </pre>												

	<pre> &lt;annotation&gt;   &lt;documentation&gt;nein&lt;/documentation&gt; &lt;/annotation&gt; &lt;/enumeration&gt; &lt;enumeration value="0061099"&gt;   &lt;annotation&gt;     &lt;documentation&gt;unbekannt&lt;/documentation&gt;   &lt;/annotation&gt; &lt;/enumeration&gt; &lt;/restriction&gt; &lt;/simpleType&gt; </pre>
--	--

### simpleType enum\_0062

namespace	http://xml.ir-d.de/emg		
type	restriction of <b>string</b>		
properties	base xs:string		
used by	element <a href="#">ZubehoerEndoprotheseBasis/ZEP_EinheitSchluessel</a>		
facets	Kind	Value	Annotation
	enumeration	0062001	documentation Stück
	enumeration	0062002	documentation g
	enumeration	0062003	documentation mg
	enumeration	0062004	documentation l
	enumeration	0062005	documentation ml
	enumeration	0062006	documentation cm <sup>3</sup>
	enumeration	0062007	documentation mm
	enumeration	0062008	documentation cm
	enumeration	0062009	documentation dm
	enumeration	0062010	documentation m
	enumeration	0062042	documentation andere
annotation	documentation Kat_Einheit		
source	<pre> &lt;simpleType name="enum_0062"&gt;   &lt;annotation&gt;     &lt;documentation&gt;Kat_Einheit&lt;/documentation&gt;   &lt;/annotation&gt;   &lt;restriction base="xs:string"&gt;     &lt;enumeration value="0062001"&gt;       &lt;annotation&gt;         &lt;documentation&gt;Stück&lt;/documentation&gt;       &lt;/annotation&gt;     &lt;/enumeration&gt;     &lt;enumeration value="0062002"&gt;       &lt;annotation&gt;         &lt;documentation&gt;g&lt;/documentation&gt;       &lt;/annotation&gt;     &lt;/enumeration&gt;   &lt;/restriction&gt; &lt;/simpleType&gt; </pre>		

```

<enumeration value="0062003">
  <annotation>
    <documentation>mg</documentation>
  </annotation>
</enumeration>
<enumeration value="0062004">
  <annotation>
    <documentation>l</documentation>
  </annotation>
</enumeration>
<enumeration value="0062005">
  <annotation>
    <documentation>m1</documentation>
  </annotation>
</enumeration>
<enumeration value="0062006">
  <annotation>
    <documentation>cm3</documentation>
  </annotation>
</enumeration>
<enumeration value="0062007">
  <annotation>
    <documentation>mm</documentation>
  </annotation>
</enumeration>
<enumeration value="0062008">
  <annotation>
    <documentation>cm</documentation>
  </annotation>
</enumeration>
<enumeration value="0062009">
  <annotation>
    <documentation>dm</documentation>
  </annotation>
</enumeration>
<enumeration value="0062010">
  <annotation>
    <documentation>m</documentation>
  </annotation>
</enumeration>
<enumeration value="0062042">
  <annotation>
    <documentation>andere</documentation>
  </annotation>
</enumeration>
</restriction>
</simpleType>

```

### simpleType enum\_0065

namespace	http://xml.ir-d.de/emg		
type	restriction of <b>string</b>		
properties	base xs:string		
used by	element <a href="#">FallBasis/FAL ArtAufenthaltSchluessel</a>		
facets	Kind	Value	Annotation
	enumeration	0065001	documentation

	enumeration 0065002 stationär documentation teilstationär enumeration 0065003 documentation ambulant
annotation	documentation Kat_ArtAufenthalt
source	<pre> &lt;simpleType name="enum_0065"&gt;   &lt;annotation&gt;     &lt;documentation&gt;Kat_ArtAufenthalt&lt;/documentation&gt;   &lt;/annotation&gt;   &lt;restriction base="xs:string"&gt;     &lt;enumeration value="0065001"&gt;       &lt;annotation&gt;         &lt;documentation&gt;stationär&lt;/documentation&gt;       &lt;/annotation&gt;     &lt;/enumeration&gt;     &lt;enumeration value="0065002"&gt;       &lt;annotation&gt;         &lt;documentation&gt;teilstationär&lt;/documentation&gt;       &lt;/annotation&gt;     &lt;/enumeration&gt;     &lt;enumeration value="0065003"&gt;       &lt;annotation&gt;         &lt;documentation&gt;ambulant&lt;/documentation&gt;       &lt;/annotation&gt;     &lt;/enumeration&gt;   &lt;/restriction&gt; &lt;/simpleType&gt; </pre>

### simpleType enum 0067

namespace	http://xml.ir-d.de/emg		
type	restriction of <b>string</b>		
properties	base xs:string		
used by	element <a href="#">ArtikelidentifikationBasis/ARI ArtikelArtSchluessel</a>		
facets	Kind	Value	Annotation
	enumeration	0067001	documentation Implantat
	enumeration	0067002	documentation Explantat
annotation	documentation Kat_ArtArtikel		
source	<pre> &lt;simpleType name="enum_0067"&gt;   &lt;annotation&gt;     &lt;documentation&gt;Kat_ArtArtikel&lt;/documentation&gt;   &lt;/annotation&gt;   &lt;restriction base="xs:string"&gt;     &lt;enumeration value="0067001"&gt;       &lt;annotation&gt;         &lt;documentation&gt;Implantat&lt;/documentation&gt;       &lt;/annotation&gt;     &lt;/enumeration&gt;     &lt;enumeration value="0067002"&gt;       &lt;annotation&gt;         &lt;documentation&gt;Explantat&lt;/documentation&gt;       &lt;/annotation&gt;     &lt;/enumeration&gt;   &lt;/restriction&gt; &lt;/simpleType&gt; </pre>		

	<pre> &lt;/annotation&gt; &lt;/enumeration&gt; &lt;/restriction&gt; &lt;/simpleType&gt; </pre>
--	--

### simpleType enum\_0068

namespace	http://xml.ir-d.de/emg															
type	restriction of <b>string</b>															
properties	base xs:string															
used by	element <a href="#">ArtikelidentifikationBasis/ARI KennzeichenTypSchluessel</a>															
facets	<table border="1"> <thead> <tr> <th>Kind</th> <th>Value</th> <th>Annotation</th> </tr> </thead> <tbody> <tr> <td>enumeration</td> <td>0068001</td> <td>documentation UDI</td> </tr> <tr> <td>enumeration</td> <td>0068002</td> <td>documentation Referenz (REF)</td> </tr> <tr> <td>enumeration</td> <td>0068003</td> <td>documentation Katalognummer</td> </tr> <tr> <td>enumeration</td> <td>0068042</td> <td>documentation sonstiger</td> </tr> </tbody> </table>	Kind	Value	Annotation	enumeration	0068001	documentation UDI	enumeration	0068002	documentation Referenz (REF)	enumeration	0068003	documentation Katalognummer	enumeration	0068042	documentation sonstiger
Kind	Value	Annotation														
enumeration	0068001	documentation UDI														
enumeration	0068002	documentation Referenz (REF)														
enumeration	0068003	documentation Katalognummer														
enumeration	0068042	documentation sonstiger														
annotation	documentation Kat KennzeichenTyp															
source	<pre> &lt;simpleType name="enum_0068"&gt;   &lt;annotation&gt;     &lt;documentation&gt;Kat_KennzeichenTyp&lt;/documentation&gt;   &lt;/annotation&gt;   &lt;restriction base="xs:string"&gt;     &lt;enumeration value="0068001"&gt;       &lt;annotation&gt;         &lt;documentation&gt;UDI&lt;/documentation&gt;       &lt;/annotation&gt;     &lt;/enumeration&gt;     &lt;enumeration value="0068002"&gt;       &lt;annotation&gt;         &lt;documentation&gt;Referenz (REF)&lt;/documentation&gt;       &lt;/annotation&gt;     &lt;/enumeration&gt;     &lt;enumeration value="0068003"&gt;       &lt;annotation&gt;         &lt;documentation&gt;Katalognummer&lt;/documentation&gt;       &lt;/annotation&gt;     &lt;/enumeration&gt;     &lt;enumeration value="0068042"&gt;       &lt;annotation&gt;         &lt;documentation&gt;sonstiger&lt;/documentation&gt;       &lt;/annotation&gt;     &lt;/enumeration&gt;   &lt;/restriction&gt; &lt;/simpleType&gt; </pre>															

### simpleType enum\_0069

namespace	http://xml.ir-d.de/emg
type	restriction of <b>string</b>

properties	base xs:string									
used by	element <a href="#">ZubehoerBasis/ZUB ZubehoerArtSchluessel</a>									
facets	<table border="1"> <thead> <tr> <th>Kind</th> <th>Value</th> <th>Annotation</th> </tr> </thead> <tbody> <tr> <td>enumeration</td> <td>0069001</td> <td>documentation Implantat</td> </tr> <tr> <td>enumeration</td> <td>0069002</td> <td>documentation Explantat</td> </tr> </tbody> </table>	Kind	Value	Annotation	enumeration	0069001	documentation Implantat	enumeration	0069002	documentation Explantat
Kind	Value	Annotation								
enumeration	0069001	documentation Implantat								
enumeration	0069002	documentation Explantat								
annotation	documentation Kat_ArtZubehoer									
source	<pre>&lt;simpleType name="enum_0069"&gt;   &lt;annotation&gt;     &lt;documentation&gt;Kat_ArtZubehoer&lt;/documentation&gt;   &lt;/annotation&gt;   &lt;restriction base="xs:string"&gt;     &lt;enumeration value="0069001"&gt;       &lt;annotation&gt;         &lt;documentation&gt;Implantat&lt;/documentation&gt;       &lt;/annotation&gt;     &lt;/enumeration&gt;     &lt;enumeration value="0069002"&gt;       &lt;annotation&gt;         &lt;documentation&gt;Explantat&lt;/documentation&gt;       &lt;/annotation&gt;     &lt;/enumeration&gt;   &lt;/restriction&gt; &lt;/simpleType&gt;</pre>									

### simpleType enum\_0070

namespace	http://xml.ir-d.de/emg															
type	restriction of <b>string</b>															
properties	base xs:string															
used by	element <a href="#">PatientenaufnahmeBasis/PAT GeschlechtSchluessel</a>															
facets	<table border="1"> <thead> <tr> <th>Kind</th> <th>Value</th> <th>Annotation</th> </tr> </thead> <tbody> <tr> <td>enumeration</td> <td>0070001</td> <td>documentation weiblich</td> </tr> <tr> <td>enumeration</td> <td>0070002</td> <td>documentation männlich</td> </tr> <tr> <td>enumeration</td> <td>0070003</td> <td>documentation divers</td> </tr> <tr> <td>enumeration</td> <td>0070042</td> <td>documentation unbestimmt</td> </tr> </tbody> </table>	Kind	Value	Annotation	enumeration	0070001	documentation weiblich	enumeration	0070002	documentation männlich	enumeration	0070003	documentation divers	enumeration	0070042	documentation unbestimmt
Kind	Value	Annotation														
enumeration	0070001	documentation weiblich														
enumeration	0070002	documentation männlich														
enumeration	0070003	documentation divers														
enumeration	0070042	documentation unbestimmt														
annotation	documentation Kat_Geschlecht															
source	<pre>&lt;simpleType name="enum_0070"&gt;   &lt;annotation&gt;     &lt;documentation&gt;Kat_Geschlecht&lt;/documentation&gt;   &lt;/annotation&gt;   &lt;restriction base="xs:string"&gt;     &lt;enumeration value="0070001"&gt;       &lt;annotation&gt;         &lt;documentation&gt;weiblich&lt;/documentation&gt;       &lt;/annotation&gt;     &lt;/enumeration&gt;     &lt;enumeration value="0070002"&gt;</pre>															



	<pre> &lt;annotation&gt;   &lt;documentation&gt;männlich&lt;/documentation&gt; &lt;/annotation&gt; &lt;/enumeration&gt; &lt;enumeration value="0070003"&gt;   &lt;annotation&gt;     &lt;documentation&gt;divers&lt;/documentation&gt;   &lt;/annotation&gt; &lt;/enumeration&gt; &lt;enumeration value="0070042"&gt;   &lt;annotation&gt;     &lt;documentation&gt;unbestimmt&lt;/documentation&gt;   &lt;/annotation&gt; &lt;/enumeration&gt; &lt;/restriction&gt; &lt;/simpleType&gt; </pre>
--	---

### simpleType enum\_0071

namespace	http://xml.ir-d.de/emg		
type	restriction of <b>string</b>		
properties	base xs:string		
used by	element <a href="#">ArtikelidentifikationBasis/ARI ArtikelArtFunktionSchluessel</a>		
facets	Kind	Value	Annotation
	enumeration	0071001	documentation Implantat
	enumeration	0071002	documentation Explantat
	enumeration	0071003	documentation Degeneriertes/defektes Produkt, das funktionslos im Körper verbleibt
annotation	documentation Kat_ArtikelArtFunktion		
source	<pre> &lt;simpleType name="enum_0071"&gt;   &lt;annotation&gt;     &lt;documentation&gt;Kat_ArtikelArtFunktion&lt;/documentation&gt;   &lt;/annotation&gt;   &lt;restriction base="xs:string"&gt;     &lt;enumeration value="0071001"&gt;       &lt;annotation&gt;         &lt;documentation&gt;Implantat&lt;/documentation&gt;       &lt;/annotation&gt;     &lt;/enumeration&gt;     &lt;enumeration value="0071002"&gt;       &lt;annotation&gt;         &lt;documentation&gt;Explantat&lt;/documentation&gt;       &lt;/annotation&gt;     &lt;/enumeration&gt;     &lt;enumeration value="0071003"&gt;       &lt;annotation&gt;         &lt;documentation&gt;Degeneriertes/defektes Produkt, das funktionslos im         Körper verbleibt&lt;/documentation&gt;       &lt;/annotation&gt;     &lt;/enumeration&gt;   &lt;/restriction&gt; &lt;/simpleType&gt; </pre>		

### simpleType enum\_0075

namespace	http://xml.ir-d.de/emg		
type	restriction of <b>string</b>		
properties	base xs:string		
used by	element <a href="#">OperationEndoprotheseBasis/OEP DringlichkeitSchluessel</a>		
facets	Kind	Value	Annotation
	enumeration	0075001	documentation elektiv
	enumeration	0075002	documentation dringlich
	enumeration	0075003	documentation Notfall
annotation	documentation Kat_Dringlichkeit		
source	<pre> &lt;simpleType name="enum_0075"&gt;   &lt;annotation&gt;     &lt;documentation&gt;Kat_Dringlichkeit&lt;/documentation&gt;   &lt;/annotation&gt;   &lt;restriction base="xs:string"&gt;     &lt;enumeration value="0075001"&gt;       &lt;annotation&gt;         &lt;documentation&gt;elektiv&lt;/documentation&gt;       &lt;/annotation&gt;     &lt;/enumeration&gt;     &lt;enumeration value="0075002"&gt;       &lt;annotation&gt;         &lt;documentation&gt;dringlich&lt;/documentation&gt;       &lt;/annotation&gt;     &lt;/enumeration&gt;     &lt;enumeration value="0075003"&gt;       &lt;annotation&gt;         &lt;documentation&gt;Notfall&lt;/documentation&gt;       &lt;/annotation&gt;     &lt;/enumeration&gt;   &lt;/restriction&gt; &lt;/simpleType&gt; </pre>		

### simpleType enum\_0076

namespace	http://xml.ir-d.de/emg		
type	restriction of <b>string</b>		
properties	base xs:string		
used by	element <a href="#">OperationAortenklappeBasis/OAK DringlichkeitSchluessel</a>		
facets	Kind	Value	Annotation
	enumeration	0076001	documentation elektiv
	enumeration	0076002	documentation dringlich
	enumeration	0076003	documentation Notfall
	enumeration	0076004	documentation Notfall (Reanimation / ultima ratio)
annotation	documentation		

	Kat_Dringlichkeit_Reanimation
source	<pre> &lt;simpleType name="enum_0076"&gt;   &lt;annotation&gt;     &lt;documentation&gt;Kat_Dringlichkeit_Reanimation&lt;/documentation&gt;   &lt;/annotation&gt;   &lt;restriction base="xs:string"&gt;     &lt;enumeration value="0076001"&gt;       &lt;annotation&gt;         &lt;documentation&gt;elektiv&lt;/documentation&gt;       &lt;/annotation&gt;     &lt;/enumeration&gt;     &lt;enumeration value="0076002"&gt;       &lt;annotation&gt;         &lt;documentation&gt;dringlich&lt;/documentation&gt;       &lt;/annotation&gt;     &lt;/enumeration&gt;     &lt;enumeration value="0076003"&gt;       &lt;annotation&gt;         &lt;documentation&gt;Notfall&lt;/documentation&gt;       &lt;/annotation&gt;     &lt;/enumeration&gt;     &lt;enumeration value="0076004"&gt;       &lt;annotation&gt;         &lt;documentation&gt;Notfall (Reanimation / ultima ratio)&lt;/documentation&gt;       &lt;/annotation&gt;     &lt;/enumeration&gt;   &lt;/restriction&gt; &lt;/simpleType&gt; </pre>

### simpleType enum\_0080

namespace	http://xml.ir-d.de/emg		
type	restriction of <b>string</b>		
properties	base xs:string		
used by	element	<a href="#">OperationBasis/OPE ImplantattypSchluessel</a>	
facets	Kind	Value	Annotation
	enumeration	0080001	documentation Endoprothese Hüfte/Knie
	enumeration	0080002	documentation Brustimplantat
	enumeration	0080003	documentation Aortenklappenprothese
annotation	documentation Kat_Implantattyp		
source	<pre> &lt;simpleType name="enum_0080"&gt;   &lt;annotation&gt;     &lt;documentation&gt;Kat_Implantattyp&lt;/documentation&gt;   &lt;/annotation&gt;   &lt;restriction base="xs:string"&gt;     &lt;enumeration value="0080001"&gt;       &lt;annotation&gt;         &lt;documentation&gt;Endoprothese Hüfte/Knie&lt;/documentation&gt;       &lt;/annotation&gt;     &lt;/enumeration&gt;     &lt;enumeration value="0080002"&gt;       &lt;annotation&gt; </pre>		

	<pre> &lt;documentation&gt;Brustimplantat&lt;/documentation&gt; &lt;/annotation&gt; &lt;/enumeration&gt; &lt;enumeration value="0080003"&gt;   &lt;annotation&gt;     &lt;documentation&gt;Aortenklappenprothese&lt;/documentation&gt;   &lt;/annotation&gt; &lt;/enumeration&gt; &lt;/restriction&gt; &lt;/simpleType&gt; </pre>
--	---

### simpleType enum\_0100

namespace	http://xml.ir-d.de/emg		
type	restriction of <b>string</b>		
properties	base xs:string		
used by	element <a href="#">OperationBrustimplantatBasis/OBI ArtEingriffSchluessel</a>		
facets	Kind	Value	Annotation
	enumeration	0100001	documentation Primäreingriff
	enumeration	0100002	documentation Austausch Expander gegen dauerhaftes Brustimplantat
	enumeration	0100003	documentation Revision
	enumeration	0100004	documentation Nur Explantation
annotation	documentation Kat BI_ArtEingriff		
source	<pre> &lt;simpleType name="enum_0100"&gt;   &lt;annotation&gt;     &lt;documentation&gt;Kat_BI_ArtEingriff&lt;/documentation&gt;   &lt;/annotation&gt;   &lt;restriction base="xs:string"&gt;     &lt;enumeration value="0100001"&gt;       &lt;annotation&gt;         &lt;documentation&gt;Primäreingriff&lt;/documentation&gt;       &lt;/annotation&gt;     &lt;/enumeration&gt;     &lt;enumeration value="0100002"&gt;       &lt;annotation&gt;         &lt;documentation&gt;Austausch Expander gegen dauerhaftes Brustimplantat&lt;/documentation&gt;       &lt;/annotation&gt;     &lt;/enumeration&gt;     &lt;enumeration value="0100003"&gt;       &lt;annotation&gt;         &lt;documentation&gt;Revision&lt;/documentation&gt;       &lt;/annotation&gt;     &lt;/enumeration&gt;     &lt;enumeration value="0100004"&gt;       &lt;annotation&gt;         &lt;documentation&gt;Nur Explantation&lt;/documentation&gt;       &lt;/annotation&gt;     &lt;/enumeration&gt;   &lt;/restriction&gt; &lt;/simpleType&gt; </pre>		

### simpleType enum 0102

namespace	http://xml.ir-d.de/emg		
type	restriction of <b>string</b>		
properties	base xs:string		
used by	element <a href="#">OperationBrustimplantatBasis/OBI GrundPrimaerEingriffSchluessel</a>		
facets	Kind	Value	Annotation
	enumeration	0102001	documentation kosmetische Augmentation
	enumeration	0102002	documentation Rekonstruktion, benigne
	enumeration	0102003	documentation Rekonstruktion nach Mastektomie aufgrund eines Karzinoms
	enumeration	0102004	documentation Rekonstruktion nach risikoreduzierender Mastektomie
annotation	documentation Kat_BI_GrundPrimaereingriff		
source	<pre> &lt;simpleType name="enum_0102"&gt;   &lt;annotation&gt;     &lt;documentation&gt;Kat_BI_GrundPrimaereingriff&lt;/documentation&gt;   &lt;/annotation&gt;   &lt;restriction base="xs:string"&gt;     &lt;enumeration value="0102001"&gt;       &lt;annotation&gt;         &lt;documentation&gt;kosmetische Augmentation&lt;/documentation&gt;       &lt;/annotation&gt;     &lt;/enumeration&gt;     &lt;enumeration value="0102002"&gt;       &lt;annotation&gt;         &lt;documentation&gt;Rekonstruktion, benigne&lt;/documentation&gt;       &lt;/annotation&gt;     &lt;/enumeration&gt;     &lt;enumeration value="0102003"&gt;       &lt;annotation&gt;         &lt;documentation&gt;Rekonstruktion nach Mastektomie aufgrund eines Karzinoms&lt;/documentation&gt;       &lt;/annotation&gt;     &lt;/enumeration&gt;     &lt;enumeration value="0102004"&gt;       &lt;annotation&gt;         &lt;documentation&gt;Rekonstruktion nach risikoreduzierender Mastektomie&lt;/documentation&gt;       &lt;/annotation&gt;     &lt;/enumeration&gt;   &lt;/restriction&gt; &lt;/simpleType&gt; </pre>		

### simpleType enum 0103

namespace	http://xml.ir-d.de/emg		
type	restriction of <b>string</b>		
properties	base xs:string		

used by	element <a href="#">OperationsdetailBrustimplantatBasis/ODB OperationsdetailPrimaerEingriffSchluessel</a>																								
facets	<table border="1"> <thead> <tr> <th>Kind</th> <th>Value</th> <th>Annotation</th> </tr> </thead> <tbody> <tr> <td>enumeration</td> <td>0103001</td> <td>documentation simultane Lappendeckung</td> </tr> <tr> <td>enumeration</td> <td>0103002</td> <td>documentation simultane Eigenfetttransplantation</td> </tr> <tr> <td>enumeration</td> <td>0103003</td> <td>documentation simultane Mastopexie</td> </tr> <tr> <td>enumeration</td> <td>0103005</td> <td>documentation simultane Mastektomie, Ablatio / hautsparend</td> </tr> <tr> <td>enumeration</td> <td>0103006</td> <td>documentation simultane Mastektomie, nippelerhaltend</td> </tr> <tr> <td>enumeration</td> <td>0103007</td> <td>documentation Axilla-Dissektion</td> </tr> <tr> <td>enumeration</td> <td>0103008</td> <td>documentation Drainage</td> </tr> </tbody> </table>	Kind	Value	Annotation	enumeration	0103001	documentation simultane Lappendeckung	enumeration	0103002	documentation simultane Eigenfetttransplantation	enumeration	0103003	documentation simultane Mastopexie	enumeration	0103005	documentation simultane Mastektomie, Ablatio / hautsparend	enumeration	0103006	documentation simultane Mastektomie, nippelerhaltend	enumeration	0103007	documentation Axilla-Dissektion	enumeration	0103008	documentation Drainage
Kind	Value	Annotation																							
enumeration	0103001	documentation simultane Lappendeckung																							
enumeration	0103002	documentation simultane Eigenfetttransplantation																							
enumeration	0103003	documentation simultane Mastopexie																							
enumeration	0103005	documentation simultane Mastektomie, Ablatio / hautsparend																							
enumeration	0103006	documentation simultane Mastektomie, nippelerhaltend																							
enumeration	0103007	documentation Axilla-Dissektion																							
enumeration	0103008	documentation Drainage																							
annotation	documentation Kat_BI_OperationsdetailPrimaereingriff																								
source	<pre> &lt;simpleType name="enum_0103"&gt;   &lt;annotation&gt;     &lt;documentation&gt;Kat_BI_OperationsdetailPrimaereingriff&lt;/documentation&gt;   &lt;/annotation&gt;   &lt;restriction base="xs:string"&gt;     &lt;enumeration value="0103001"&gt;       &lt;annotation&gt;         &lt;documentation&gt;simultane Lappendeckung&lt;/documentation&gt;       &lt;/annotation&gt;     &lt;/enumeration&gt;     &lt;enumeration value="0103002"&gt;       &lt;annotation&gt;         &lt;documentation&gt;simultane Eigenfetttransplantation&lt;/documentation&gt;       &lt;/annotation&gt;     &lt;/enumeration&gt;     &lt;enumeration value="0103003"&gt;       &lt;annotation&gt;         &lt;documentation&gt;simultane Mastopexie&lt;/documentation&gt;       &lt;/annotation&gt;     &lt;/enumeration&gt;     &lt;enumeration value="0103005"&gt;       &lt;annotation&gt;         &lt;documentation&gt;simultane Mastektomie, Ablatio / hautsparend&lt;/documentation&gt;       &lt;/annotation&gt;     &lt;/enumeration&gt;     &lt;enumeration value="0103006"&gt;       &lt;annotation&gt;         &lt;documentation&gt;simultane Mastektomie, nippelerhaltend&lt;/documentation&gt;       &lt;/annotation&gt;     &lt;/enumeration&gt;     &lt;enumeration value="0103007"&gt;       &lt;annotation&gt;         &lt;documentation&gt;Axilla-Dissektion&lt;/documentation&gt;       &lt;/annotation&gt;     &lt;/enumeration&gt;     &lt;enumeration value="0103008"&gt;       &lt;annotation&gt;         &lt;documentation&gt;Drainage&lt;/documentation&gt;       &lt;/annotation&gt;     &lt;/enumeration&gt;   &lt;/restriction&gt; </pre>																								

	<code>&lt;/simpleType&gt;</code>
--	----------------------------------

### simpleType enum\_0104

namespace	http://xml.ir-d.de/emg		
type	restriction of <b>string</b>		
properties	base xs:string		
used by	element <a href="#">OperationBrustimplantatBasis/OBI GrundAustauschSchluessel</a>		
facets	Kind	Value	Annotation
	enumeration	0104001	documentation Austausch Expander gegen dauerhaftes Brustimplantat
annotation	documentation Kat_BI_GrundAustausch		
source	<pre> &lt;simpleType name="enum_0104"&gt;   &lt;annotation&gt;     &lt;documentation&gt;Kat_BI_GrundAustausch&lt;/documentation&gt;   &lt;/annotation&gt;   &lt;restriction base="xs:string"&gt;     &lt;enumeration value="0104001"&gt;       &lt;annotation&gt;         &lt;documentation&gt;Austausch Expander gegen dauerhaftes Brustimplantat&lt;/documentation&gt;       &lt;/annotation&gt;     &lt;/enumeration&gt;   &lt;/restriction&gt; &lt;/simpleType&gt; </pre>		

### simpleType enum\_0105

namespace	http://xml.ir-d.de/emg		
type	restriction of <b>string</b>		
properties	base xs:string		
used by	element <a href="#">OperationsdetailBrustimplantatBasis/ODB OperationsdetailAustauschSchluessel</a>		
facets	Kind	Value	Annotation
	enumeration	0105001	documentation simultane Lappendeckung
	enumeration	0105002	documentation simultane Eigenfetttransplantation
	enumeration	0105003	documentation simultane Mastopexie
	enumeration	0105008	documentation Drainage
	enumeration	0105009	documentation Kapsulektomie, komplett
	enumeration	0105010	documentation Kapsulektomie, partiell
	enumeration	0105011	documentation Neopocket
annotation	documentation Kat_BI_OperationsdetailAustausch		
source	<pre> &lt;simpleType name="enum_0105"&gt;   &lt;annotation&gt;     &lt;documentation&gt;Kat_BI_OperationsdetailAustausch&lt;/documentation&gt;   &lt;/annotation&gt; </pre>		

	<pre> &lt;restriction base="xs:string"&gt;   &lt;enumeration value="0105001"&gt;     &lt;annotation&gt;       &lt;documentation&gt;simultane Lappendeckung&lt;/documentation&gt;     &lt;/annotation&gt;   &lt;/enumeration&gt;   &lt;enumeration value="0105002"&gt;     &lt;annotation&gt;       &lt;documentation&gt;simultane Eigenfetttransplantation&lt;/documentation&gt;     &lt;/annotation&gt;   &lt;/enumeration&gt;   &lt;enumeration value="0105003"&gt;     &lt;annotation&gt;       &lt;documentation&gt;simultane Mastopexie&lt;/documentation&gt;     &lt;/annotation&gt;   &lt;/enumeration&gt;   &lt;enumeration value="0105008"&gt;     &lt;annotation&gt;       &lt;documentation&gt;Drainage&lt;/documentation&gt;     &lt;/annotation&gt;   &lt;/enumeration&gt;   &lt;enumeration value="0105009"&gt;     &lt;annotation&gt;       &lt;documentation&gt;Kapsulektomie, komplett&lt;/documentation&gt;     &lt;/annotation&gt;   &lt;/enumeration&gt;   &lt;enumeration value="0105010"&gt;     &lt;annotation&gt;       &lt;documentation&gt;Kapsulektomie, partiell&lt;/documentation&gt;     &lt;/annotation&gt;   &lt;/enumeration&gt;   &lt;enumeration value="0105011"&gt;     &lt;annotation&gt;       &lt;documentation&gt;Neopocket&lt;/documentation&gt;     &lt;/annotation&gt;   &lt;/enumeration&gt; &lt;/restriction&gt; &lt;/simpleType&gt; </pre>
--	--

### simpleType enum\_0106

namespace	http://xml.ir-d.de/emg		
type	restriction of <b>string</b>		
properties	base xs:string		
used by	element <a href="#">OperationBrustimplantatBasis/OBI GrundRevisionExplantationSchluessel</a>		
facets	Kind	Value	Annotation
	enumeration	0106001	documentation Patientenwunsch
	enumeration	0106002	documentation asymptomatisch
	enumeration	0106003	documentation Komplikation
annotation	documentation Kat_BI_GrundRevisionExplantation		
source	<pre> &lt;simpleType name="enum_0106"&gt;   &lt;annotation&gt; </pre>		



	<pre> &lt;documentation&gt;Kat_BI_GrundRevisionExplantation&lt;/documentation&gt; &lt;/annotation&gt; &lt;restriction base="xs:string"&gt;   &lt;enumeration value="0106001"&gt;     &lt;annotation&gt;       &lt;documentation&gt;Patientenwunsch&lt;/documentation&gt;     &lt;/annotation&gt;   &lt;/enumeration&gt;   &lt;enumeration value="0106002"&gt;     &lt;annotation&gt;       &lt;documentation&gt;asymptomatisch&lt;/documentation&gt;     &lt;/annotation&gt;   &lt;/enumeration&gt;   &lt;enumeration value="0106003"&gt;     &lt;annotation&gt;       &lt;documentation&gt;Komplikation&lt;/documentation&gt;     &lt;/annotation&gt;   &lt;/enumeration&gt; &lt;/restriction&gt; &lt;/simpleType&gt; </pre>
--	---

### simpleType enum\_0107

namespace	http://xml.ir-d.de/emg		
type	restriction of <b>string</b>		
properties	base xs:string		
used by	element <a href="#">OperationsdetailBrustimplantatBasis/ODB OperationsdetailRevisionSchluessel</a>		
facets	Kind	Value	Annotation
	enumeration	0107001	documentation simultane Lappendeckung
	enumeration	0107002	documentation simultane Eigenfetttransplantation
	enumeration	0107003	documentation simultane Mastopexie
	enumeration	0107005	documentation simultane Mastektomie, Ablatio / hautsparend
	enumeration	0107006	documentation simultane Mastektomie, nippelerhaltend
	enumeration	0107007	documentation Axilla-Dissektion
	enumeration	0107008	documentation Drainage
	enumeration	0107009	documentation Kapsulektomie, komplett
	enumeration	0107010	documentation Kapsulektomie, partiell
	enumeration	0107011	documentation Neopocket
annotation	documentation Kat_BI_OperationsdetailRevision		
source	<pre> &lt;simpleType name="enum_0107"&gt;   &lt;annotation&gt;     &lt;documentation&gt;Kat_BI_OperationsdetailRevision&lt;/documentation&gt;   &lt;/annotation&gt;   &lt;restriction base="xs:string"&gt;     &lt;enumeration value="0107001"&gt;       &lt;annotation&gt; </pre>		

```

    <documentation>simultane Lappendeckung</documentation>
  </annotation>
</enumeration>
<enumeration value="0107002">
  <annotation>
    <documentation>simultane Eigenfetttransplantation</documentation>
  </annotation>
</enumeration>
<enumeration value="0107003">
  <annotation>
    <documentation>simultane Mastopexie</documentation>
  </annotation>
</enumeration>
<enumeration value="0107005">
  <annotation>
    <documentation>simultane Mastektomie, Ablatio /
hautsparend</documentation>
  </annotation>
</enumeration>
<enumeration value="0107006">
  <annotation>
    <documentation>simultane Mastektomie, nippelerhaltend</documentation>
  </annotation>
</enumeration>
<enumeration value="0107007">
  <annotation>
    <documentation>Axilla-Dissektion</documentation>
  </annotation>
</enumeration>
<enumeration value="0107008">
  <annotation>
    <documentation>Drainage</documentation>
  </annotation>
</enumeration>
<enumeration value="0107009">
  <annotation>
    <documentation>Kapsulektomie, komplett</documentation>
  </annotation>
</enumeration>
<enumeration value="0107010">
  <annotation>
    <documentation>Kapsulektomie, partiell</documentation>
  </annotation>
</enumeration>
<enumeration value="0107011">
  <annotation>
    <documentation>Neopocket</documentation>
  </annotation>
</enumeration>
</restriction>
</simpleType>

```

#### simpleType enum\_0110

namespace	http://xml.ir-d.de/emg
type	restriction of <b>string</b>

properties	base xs:string						
used by	element <a href="#">VorbereitungBrustimplantatBasis/VBI BehandlungLokalSchluessel</a>						
facets	<table border="1"> <thead> <tr> <th>Kind</th> <th>Value</th> <th>Annotation</th> </tr> </thead> <tbody> <tr> <td>enumeration</td> <td>0110001</td> <td>documentation Bestrahlung</td> </tr> </tbody> </table>	Kind	Value	Annotation	enumeration	0110001	documentation Bestrahlung
Kind	Value	Annotation					
enumeration	0110001	documentation Bestrahlung					
annotation	documentation Kat_BI_VorbereitungLokal						
source	<pre>&lt;simpleType name="enum_0110"&gt;   &lt;annotation&gt;     &lt;documentation&gt;Kat_BI_VorbereitungLokal&lt;/documentation&gt;   &lt;/annotation&gt;   &lt;restriction base="xs:string"&gt;     &lt;enumeration value="0110001"&gt;       &lt;annotation&gt;         &lt;documentation&gt;Bestrahlung&lt;/documentation&gt;       &lt;/annotation&gt;     &lt;/enumeration&gt;   &lt;/restriction&gt; &lt;/simpleType&gt;</pre>						

### simpleType enum\_0111

namespace	http://xml.ir-d.de/emg												
type	restriction of <b>string</b>												
properties	base xs:string												
used by	element <a href="#">OperationBrustimplantatBasis/OBI VerfahrenswechselSchluessel</a>												
facets	<table border="1"> <thead> <tr> <th>Kind</th> <th>Value</th> <th>Annotation</th> </tr> </thead> <tbody> <tr> <td>enumeration</td> <td>0111001</td> <td>documentation nein</td> </tr> <tr> <td>enumeration</td> <td>0111002</td> <td>documentation Lipofilling</td> </tr> <tr> <td>enumeration</td> <td>0111003</td> <td>documentation Eigengewebsrekonstruktion</td> </tr> </tbody> </table>	Kind	Value	Annotation	enumeration	0111001	documentation nein	enumeration	0111002	documentation Lipofilling	enumeration	0111003	documentation Eigengewebsrekonstruktion
Kind	Value	Annotation											
enumeration	0111001	documentation nein											
enumeration	0111002	documentation Lipofilling											
enumeration	0111003	documentation Eigengewebsrekonstruktion											
annotation	documentation Kat_BI_Verfahrenswechsel												
source	<pre>&lt;simpleType name="enum_0111"&gt;   &lt;annotation&gt;     &lt;documentation&gt;Kat_BI_Verfahrenswechsel&lt;/documentation&gt;   &lt;/annotation&gt;   &lt;restriction base="xs:string"&gt;     &lt;enumeration value="0111001"&gt;       &lt;annotation&gt;         &lt;documentation&gt;nein&lt;/documentation&gt;       &lt;/annotation&gt;     &lt;/enumeration&gt;     &lt;enumeration value="0111002"&gt;       &lt;annotation&gt;         &lt;documentation&gt;Lipofilling&lt;/documentation&gt;       &lt;/annotation&gt;     &lt;/enumeration&gt;     &lt;enumeration value="0111003"&gt;       &lt;annotation&gt;         &lt;documentation&gt;Eigengewebsrekonstruktion&lt;/documentation&gt;       &lt;/annotation&gt;     &lt;/enumeration&gt;   &lt;/restriction&gt; &lt;/simpleType&gt;</pre>												

	<pre> &lt;/restriction&gt; &lt;/simpleType&gt; </pre>
--	---

### simpleType enum\_0112

namespace	http://xml.ir-d.de/emg		
type	restriction of <b>string</b>		
properties	base xs:string		
used by	element <a href="#">OperationBrustimplantatBasis/OBI LageSchluessel</a>		
facets	Kind	Value	Annotation
	enumeration	0112001	documentation subglandulär / epipektoral
	enumeration	0112002	documentation subpektoral
	enumeration	0112003	documentation subfaszial
	enumeration	0112004	documentation sub-flap
	enumeration	0112005	documentation subkutan
	enumeration	0112006	documentation dual plane
	enumeration	0112042	documentation andere
annotation	documentation Kat_BI_LageImplantat		
source	<pre> &lt;simpleType name="enum_0112"&gt;   &lt;annotation&gt;     &lt;documentation&gt;Kat_BI_LageImplantat&lt;/documentation&gt;   &lt;/annotation&gt;   &lt;restriction base="xs:string"&gt;     &lt;enumeration value="0112001"&gt;       &lt;annotation&gt;         &lt;documentation&gt;subglandulär / epipektoral&lt;/documentation&gt;       &lt;/annotation&gt;     &lt;/enumeration&gt;     &lt;enumeration value="0112002"&gt;       &lt;annotation&gt;         &lt;documentation&gt;subpektoral&lt;/documentation&gt;       &lt;/annotation&gt;     &lt;/enumeration&gt;     &lt;enumeration value="0112003"&gt;       &lt;annotation&gt;         &lt;documentation&gt;subfaszial&lt;/documentation&gt;       &lt;/annotation&gt;     &lt;/enumeration&gt;     &lt;enumeration value="0112004"&gt;       &lt;annotation&gt;         &lt;documentation&gt;sub-flap&lt;/documentation&gt;       &lt;/annotation&gt;     &lt;/enumeration&gt;     &lt;enumeration value="0112005"&gt;       &lt;annotation&gt;         &lt;documentation&gt;subkutan&lt;/documentation&gt;       &lt;/annotation&gt;     &lt;/enumeration&gt;     &lt;enumeration value="0112006"&gt; </pre>		

	<pre> &lt;annotation&gt;   &lt;documentation&gt;dual plane&lt;/documentation&gt; &lt;/annotation&gt; &lt;/enumeration&gt; &lt;enumeration value="0112042"&gt;   &lt;annotation&gt;     &lt;documentation&gt;andere&lt;/documentation&gt;   &lt;/annotation&gt; &lt;/enumeration&gt; &lt;/restriction&gt; &lt;/simpleType&gt; </pre>
--	---

### simpleType enum\_0113

namespace	http://xml.ir-d.de/emg		
type	restriction of <b>string</b>		
properties	base xs:string		
used by	element <a href="#">VorbereitungBrustimplantatBasis/VBI BehandlungSystemischSchlüssel</a>		
facets	Kind	Value	Annotation
	enumeration	0113001	documentation Chemotherapie innerhalb der letzten drei Monate
annotation	documentation Kat_BI_VorbereitungSystemisch		
source	<pre> &lt;simpleType name="enum_0113"&gt;   &lt;annotation&gt;     &lt;documentation&gt;Kat_BI_VorbereitungSystemisch&lt;/documentation&gt;   &lt;/annotation&gt;   &lt;restriction base="xs:string"&gt;     &lt;enumeration value="0113001"&gt;       &lt;annotation&gt;         &lt;documentation&gt;Chemotherapie innerhalb der letzten drei Monate&lt;/documentation&gt;       &lt;/annotation&gt;     &lt;/enumeration&gt;   &lt;/restriction&gt; &lt;/simpleType&gt; </pre>		

### simpleType enum\_0114

namespace	http://xml.ir-d.de/emg		
type	restriction of <b>string</b>		
properties	base xs:string		
used by	element <a href="#">OperationBrustimplantatBasis/OBI EntfernungAdmNetzSchlüssel</a>		
facets	Kind	Value	Annotation
	enumeration	0114001	documentation vollständig
	enumeration	0114002	documentation nein
	enumeration	0114003	documentation teilweise
	enumeration	0114004	documentation nicht vorhanden
annotation	documentation		

	Kat_BI_EntfernungADMNetz
source	<pre> &lt;simpleType name="enum_0114"&gt;   &lt;annotation&gt;     &lt;documentation&gt;Kat_BI_EntfernungADMNetz&lt;/documentation&gt;   &lt;/annotation&gt;   &lt;restriction base="xs:string"&gt;     &lt;enumeration value="0114001"&gt;       &lt;annotation&gt;         &lt;documentation&gt;vollständig&lt;/documentation&gt;       &lt;/annotation&gt;     &lt;/enumeration&gt;     &lt;enumeration value="0114002"&gt;       &lt;annotation&gt;         &lt;documentation&gt;nein&lt;/documentation&gt;       &lt;/annotation&gt;     &lt;/enumeration&gt;     &lt;enumeration value="0114003"&gt;       &lt;annotation&gt;         &lt;documentation&gt;teilweise&lt;/documentation&gt;       &lt;/annotation&gt;     &lt;/enumeration&gt;     &lt;enumeration value="0114004"&gt;       &lt;annotation&gt;         &lt;documentation&gt;nicht vorhanden&lt;/documentation&gt;       &lt;/annotation&gt;     &lt;/enumeration&gt;   &lt;/restriction&gt; &lt;/simpleType&gt; </pre>

### simpleType enum\_0116

namespace	http://xml.ir-d.de/emg		
type	restriction of <b>string</b>		
properties	base xs:string		
used by	element	<a href="#">MassnahmeBrustimplantatBasis/MAB MassnahmeSchluessel</a>	
facets	Kind	Value	Annotation
	enumeration	0116001	documentation Spülung, antibiotisch
	enumeration	0116002	documentation Spülung, antiseptisch
	enumeration	0116003	documentation Spülung, wirkstofffrei
	enumeration	0116004	documentation Spülung, andere
	enumeration	0116005	documentation prä-/perioperative Antibiotika
	enumeration	0116006	documentation postoperative Antibiotika
	enumeration	0116007	documentation Handschuhwechsel vor Implantation
	enumeration	0116008	documentation Implantationshilfe
annotation	documentation Kat_BI_Operationsmassnahme		
source	<pre> &lt;simpleType name="enum_0116"&gt;   &lt;annotation&gt;     &lt;documentation&gt;Kat BI Operationsmassnahme&lt;/documentation&gt; </pre>		

```

</annotation>
<restriction base="xs:string">
  <enumeration value="0116001">
    <annotation>
      <documentation>Spülung, antibiotisch</documentation>
    </annotation>
  </enumeration>
  <enumeration value="0116002">
    <annotation>
      <documentation>Spülung, antiseptisch</documentation>
    </annotation>
  </enumeration>
  <enumeration value="0116003">
    <annotation>
      <documentation>Spülung, wirkstofffrei</documentation>
    </annotation>
  </enumeration>
  <enumeration value="0116004">
    <annotation>
      <documentation>Spülung, andere</documentation>
    </annotation>
  </enumeration>
  <enumeration value="0116005">
    <annotation>
      <documentation>prä-/perioperative Antibiotika</documentation>
    </annotation>
  </enumeration>
  <enumeration value="0116006">
    <annotation>
      <documentation>postoperative Antibiotika</documentation>
    </annotation>
  </enumeration>
  <enumeration value="0116007">
    <annotation>
      <documentation>Handschuhwechsel vor Implantation</documentation>
    </annotation>
  </enumeration>
  <enumeration value="0116008">
    <annotation>
      <documentation>Implantationshilfe</documentation>
    </annotation>
  </enumeration>
</restriction>
</simpleType>

```

### simpleType enum\_0118

namespace	http://xml.ir-d.de/emg		
type	restriction of <b>string</b>		
properties	base xs:string		
used by	element	<a href="#">OperationBrustimplantatBasis/OBI ZugangSchluessel</a>	
facets	Kind	Value	Annotation
	enumeration	0118001	documentation axillär
	enumeration	0118002	documentation periareolär

	enumeration 0118003 documentation inframammär enumeration 0118004 documentation Mastektomienarbe enumeration 0118042 documentation anderer
annotation	documentation Kat_BI_Operationszugang
source	<pre> &lt;simpleType name="enum_0118"&gt;   &lt;annotation&gt;     &lt;documentation&gt;Kat_BI_Operationszugang&lt;/documentation&gt;   &lt;/annotation&gt;   &lt;restriction base="xs:string"&gt;     &lt;enumeration value="0118001"&gt;       &lt;annotation&gt;         &lt;documentation&gt;axillär&lt;/documentation&gt;       &lt;/annotation&gt;     &lt;/enumeration&gt;     &lt;enumeration value="0118002"&gt;       &lt;annotation&gt;         &lt;documentation&gt;periareolär&lt;/documentation&gt;       &lt;/annotation&gt;     &lt;/enumeration&gt;     &lt;enumeration value="0118003"&gt;       &lt;annotation&gt;         &lt;documentation&gt;inframammär&lt;/documentation&gt;       &lt;/annotation&gt;     &lt;/enumeration&gt;     &lt;enumeration value="0118004"&gt;       &lt;annotation&gt;         &lt;documentation&gt;Mastektomienarbe&lt;/documentation&gt;       &lt;/annotation&gt;     &lt;/enumeration&gt;     &lt;enumeration value="0118042"&gt;       &lt;annotation&gt;         &lt;documentation&gt;anderer&lt;/documentation&gt;       &lt;/annotation&gt;     &lt;/enumeration&gt;   &lt;/restriction&gt; &lt;/simpleType&gt; </pre>

### simpleType **enum\_0120**

namespace	http://xml.lir-d.de/emg		
type	restriction of <b>string</b>		
properties	base xs:string		
used by	element <a href="#">BefundBrustimplantatBasis/BEB BefundAustauschSchluessel</a>		
facets	Kind	Value	Annotation
	enumeration	0120001	documentation Expander defekt
annotation	documentation Kat_BI_BefundAustausch		
source	<pre> &lt;simpleType name="enum_0120"&gt;   &lt;annotation&gt;     &lt;documentation&gt;Kat_BI_BefundAustausch&lt;/documentation&gt;   &lt;/annotation&gt; </pre>		



	<pre> &lt;restriction base="xs:string"&gt;   &lt;enumeration value="0120001"&gt;     &lt;annotation&gt;       &lt;documentation&gt;Expander defekt&lt;/documentation&gt;     &lt;/annotation&gt;   &lt;/enumeration&gt; &lt;/restriction&gt; &lt;/simpleType&gt; </pre>
--	---

### simpleType enum\_0121

namespace	http://xml.ir-d.de/emg		
type	restriction of <b>string</b>		
properties	base xs:string		
used by	element <a href="#">BefundBrustimplantatBasis/BEB BefundSchluessel</a>		
facets	Kind	Value	Annotation
	enumeration	0121001	documentation Infektion
	enumeration	0121002	documentation Serom
	enumeration	0121003	documentation Hämatom
	enumeration	0121004	documentation Kapselfibrose
	enumeration	0121005	documentation Implantatruptur
	enumeration	0121006	documentation Fehlpositionierung/Rotation
	enumeration	0121007	documentation BIA-ALCL/-SCC, Verdacht
	enumeration	0121008	documentation BIA-ALCL/-SCC, pathologisch bestätigt
	enumeration	0121009	documentation Brustschmerzen
	enumeration	0121010	documentation Doppelkapsel
	enumeration	0121011	documentation Netz-/ADM-bedingte Komplikation, Non-Integration
	enumeration	0121012	documentation Netz-/ADM-bedingte Komplikation, andere
	enumeration	0121013	documentation Hautnekrose/exponiertes Implantat
	enumeration	0121014	documentation BII/ASIA (Brustimplantat assoziierte Symptome), Verdacht
	enumeration	0121015	documentation Lymphadenopathie
	enumeration	0121016	documentation Brustkrebs, neu aufgetreten/Rezidiv
annotation	documentation Kat_BI_BefundKomplett		
source	<pre> &lt;simpleType name="enum_0121"&gt;   &lt;annotation&gt;     &lt;documentation&gt;Kat_BI_BefundKomplett&lt;/documentation&gt;   &lt;/annotation&gt;   &lt;restriction base="xs:string"&gt;     &lt;enumeration value="0121001"&gt;       &lt;annotation&gt;         &lt;documentation&gt;Infektion&lt;/documentation&gt;       &lt;/annotation&gt;     &lt;/enumeration&gt;   &lt;/restriction&gt; &lt;/simpleType&gt; </pre>		

```

</enumeration>
<enumeration value="0121002">
  <annotation>
    <documentation>Serom</documentation>
  </annotation>
</enumeration>
<enumeration value="0121003">
  <annotation>
    <documentation>Hämatom</documentation>
  </annotation>
</enumeration>
<enumeration value="0121004">
  <annotation>
    <documentation>Kapselfibrose</documentation>
  </annotation>
</enumeration>
<enumeration value="0121005">
  <annotation>
    <documentation>Implantatruptur</documentation>
  </annotation>
</enumeration>
<enumeration value="0121006">
  <annotation>
    <documentation>Fehlpositionierung/Rotation</documentation>
  </annotation>
</enumeration>
<enumeration value="0121007">
  <annotation>
    <documentation>BIA-ALCL/-SCC, Verdacht</documentation>
  </annotation>
</enumeration>
<enumeration value="0121008">
  <annotation>
    <documentation>BIA-ALCL/-SCC, pathologisch bestätigt</documentation>
  </annotation>
</enumeration>
<enumeration value="0121009">
  <annotation>
    <documentation>Brustschmerzen</documentation>
  </annotation>
</enumeration>
<enumeration value="0121010">
  <annotation>
    <documentation>Doppelkapsel</documentation>
  </annotation>
</enumeration>
<enumeration value="0121011">
  <annotation>
    <documentation>Netz-/ADM-bedingte Komplikation,
Non-Integration</documentation>
  </annotation>
</enumeration>
<enumeration value="0121012">
  <annotation>
    <documentation>Netz-/ADM-bedingte Komplikation, andere</documentation>
  </annotation>
</enumeration>
<enumeration value="0121013">
  <annotation>

```

	<pre>       &lt;documentation&gt;Hautnekrose/exponiertes Implantat&lt;/documentation&gt;     &lt;/annotation&gt;   &lt;/enumeration&gt;   &lt;enumeration value="0121014"&gt;     &lt;annotation&gt;       &lt;documentation&gt;BII/ASIA (Brustimplantat assoziierte Symptome), Verdacht&lt;/documentation&gt;     &lt;/annotation&gt;   &lt;/enumeration&gt;   &lt;enumeration value="0121015"&gt;     &lt;annotation&gt;       &lt;documentation&gt;Lymphadenopathie&lt;/documentation&gt;     &lt;/annotation&gt;   &lt;/enumeration&gt;   &lt;enumeration value="0121016"&gt;     &lt;annotation&gt;       &lt;documentation&gt;Brustkrebs, neu aufgetreten/Rezidiv&lt;/documentation&gt;     &lt;/annotation&gt;   &lt;/enumeration&gt; &lt;/restriction&gt; &lt;/simpleType&gt; </pre>
--	--

### simpleType enum\_0122

namespace	http://xml.ir-d.de/emg		
type	restriction of <b>string</b>		
properties	base xs:string		
used by	element	<a href="#">PatientenaufnahmeBrustimplantatBasis/PAB AutoimmunerkrankungSchluessel</a>	
facets	Kind	Value	Annotation
	enumeration	0122001	documentation ja, ärztlich nachgewiesen
	enumeration	0122002	documentation nein
	enumeration	0122042	documentation unbekannt
annotation	documentation Kat_BI_Autoimmunerkrankung		
source	<pre> &lt;simpleType name="enum_0122"&gt;   &lt;annotation&gt;     &lt;documentation&gt;Kat_BI_Autoimmunerkrankung&lt;/documentation&gt;   &lt;/annotation&gt;   &lt;restriction base="xs:string"&gt;     &lt;enumeration value="0122001"&gt;       &lt;annotation&gt;         &lt;documentation&gt;ja, ärztlich nachgewiesen&lt;/documentation&gt;       &lt;/annotation&gt;     &lt;/enumeration&gt;     &lt;enumeration value="0122002"&gt;       &lt;annotation&gt;         &lt;documentation&gt;nein&lt;/documentation&gt;       &lt;/annotation&gt;     &lt;/enumeration&gt;     &lt;enumeration value="0122042"&gt;       &lt;annotation&gt;         &lt;documentation&gt;unbekannt&lt;/documentation&gt;       &lt;/annotation&gt;     &lt;/enumeration&gt;   &lt;/restriction&gt; &lt;/simpleType&gt; </pre>		

```

</enumeration>
</restriction>
</simpleType>

```

### simpleType enum\_0123

namespace	http://xml.ir-d.de/emg		
type	restriction of <b>string</b>		
properties	base xs:string		
used by	element	<a href="#">PatientenaufnahmeBrustimplantatBasis/PAB VerlaufAutoimmunerkrankungSchluessel</a>	
facets	Kind	Value	Annotation
	enumeration	0123001	documentation neu aufgetreten
	enumeration	0123002	documentation verschlechtert
	enumeration	0123003	documentation keine Veränderung
	enumeration	0123004	documentation nicht relevant, da Primäreingriff
	enumeration	0123042	documentation unbekannt
annotation	documentation Kat_BI_VerlaufAutoimmunerkrankung		
source	<pre> &lt;simpleType name="enum_0123"&gt;   &lt;annotation&gt;     &lt;documentation&gt;Kat_BI_VerlaufAutoimmunerkrankung&lt;/documentation&gt;   &lt;/annotation&gt;   &lt;restriction base="xs:string"&gt;     &lt;enumeration value="0123001"&gt;       &lt;annotation&gt;         &lt;documentation&gt;neu aufgetreten&lt;/documentation&gt;       &lt;/annotation&gt;     &lt;/enumeration&gt;     &lt;enumeration value="0123002"&gt;       &lt;annotation&gt;         &lt;documentation&gt;verschlechtert&lt;/documentation&gt;       &lt;/annotation&gt;     &lt;/enumeration&gt;     &lt;enumeration value="0123003"&gt;       &lt;annotation&gt;         &lt;documentation&gt;keine Veränderung&lt;/documentation&gt;       &lt;/annotation&gt;     &lt;/enumeration&gt;     &lt;enumeration value="0123004"&gt;       &lt;annotation&gt;         &lt;documentation&gt;nicht relevant, da Primäreingriff&lt;/documentation&gt;       &lt;/annotation&gt;     &lt;/enumeration&gt;     &lt;enumeration value="0123042"&gt;       &lt;annotation&gt;         &lt;documentation&gt;unbekannt&lt;/documentation&gt;       &lt;/annotation&gt;     &lt;/enumeration&gt;   &lt;/restriction&gt; &lt;/simpleType&gt; </pre>		

### simpleType enum\_0124

namespace	http://xml.ir-d.de/emg		
type	restriction of <b>string</b>		
properties	base xs:string		
used by	element <a href="#">ArtikelBrustimplantatBasis/ABI_FuellungSchluessel</a>		
facets	Kind	Value	Annotation
	enumeration	0124001	documentation Salzlösung
	enumeration	0124002	documentation Silikongel
	enumeration	0124003	documentation Kombination Silikongel und Salzlösung
	enumeration	0124042	documentation sonstige
annotation	documentation Kat_BI_Fuellung		
source	<pre> &lt;simpleType name="enum_0124"&gt;   &lt;annotation&gt;     &lt;documentation&gt;Kat_BI_Fuellung&lt;/documentation&gt;   &lt;/annotation&gt;   &lt;restriction base="xs:string"&gt;     &lt;enumeration value="0124001"&gt;       &lt;annotation&gt;         &lt;documentation&gt;Salzlösung&lt;/documentation&gt;       &lt;/annotation&gt;     &lt;/enumeration&gt;     &lt;enumeration value="0124002"&gt;       &lt;annotation&gt;         &lt;documentation&gt;Silikongel&lt;/documentation&gt;       &lt;/annotation&gt;     &lt;/enumeration&gt;     &lt;enumeration value="0124003"&gt;       &lt;annotation&gt;         &lt;documentation&gt;Kombination Silikongel und Salzlösung&lt;/documentation&gt;       &lt;/annotation&gt;     &lt;/enumeration&gt;     &lt;enumeration value="0124042"&gt;       &lt;annotation&gt;         &lt;documentation&gt;sonstige&lt;/documentation&gt;       &lt;/annotation&gt;     &lt;/enumeration&gt;   &lt;/restriction&gt; &lt;/simpleType&gt; </pre>		

### simpleType enum\_0126

namespace	http://xml.ir-d.de/emg		
type	restriction of <b>string</b>		
properties	base xs:string		
used by	element <a href="#">ArtikelBrustimplantatBasis/ABI_FormSchluessel</a>		
facets	Kind	Value	Annotation
	enumeration	0126001	documentation anatomisch (tropfenförmig)

	enumeration 0126002 documentation rund (punktsymmetrisch) enumeration 0126042 documentation sonstige
annotation	documentation Kat_BI_Form
source	<pre> &lt;simpleType name="enum_0126"&gt;   &lt;annotation&gt;     &lt;documentation&gt;Kat_BI_Form&lt;/documentation&gt;   &lt;/annotation&gt;   &lt;restriction base="xs:string"&gt;     &lt;enumeration value="0126001"&gt;       &lt;annotation&gt;         &lt;documentation&gt;anatomisch (tropfenförmig)&lt;/documentation&gt;       &lt;/annotation&gt;     &lt;/enumeration&gt;     &lt;enumeration value="0126002"&gt;       &lt;annotation&gt;         &lt;documentation&gt;rund (punktsymmetrisch)&lt;/documentation&gt;       &lt;/annotation&gt;     &lt;/enumeration&gt;     &lt;enumeration value="0126042"&gt;       &lt;annotation&gt;         &lt;documentation&gt;sonstige&lt;/documentation&gt;       &lt;/annotation&gt;     &lt;/enumeration&gt;   &lt;/restriction&gt; &lt;/simpleType&gt; </pre>

### simpleType enum\_0128

namespace	http://xml.lir-d.de/emg		
type	restriction of <b>string</b>		
properties	base xs:string		
used by	element <a href="#">ArtikelBrustimplantatBasis/ABI OberflaecheSchluessel</a>		
facets	Kind	Value	Annotation
	enumeration	0128001	documentation glattwandig
	enumeration	0128002	documentation beschichtet
	enumeration	0128003	documentation texturiert
annotation	documentation Kat_BI_Oberflaeche		
source	<pre> &lt;simpleType name="enum_0128"&gt;   &lt;annotation&gt;     &lt;documentation&gt;Kat_BI_Oberflaeche&lt;/documentation&gt;   &lt;/annotation&gt;   &lt;restriction base="xs:string"&gt;     &lt;enumeration value="0128001"&gt;       &lt;annotation&gt;         &lt;documentation&gt;glattwandig&lt;/documentation&gt;       &lt;/annotation&gt;     &lt;/enumeration&gt;     &lt;enumeration value="0128002"&gt;       &lt;annotation&gt; </pre>		

	<pre> &lt;documentation&gt;beschichtet&lt;/documentation&gt; &lt;/annotation&gt; &lt;/enumeration&gt; &lt;enumeration value="0128003"&gt;   &lt;annotation&gt;     &lt;documentation&gt;texturiert&lt;/documentation&gt;   &lt;/annotation&gt; &lt;/enumeration&gt; &lt;/restriction&gt; &lt;/simpleType&gt; </pre>
--	---

### simpleType enum\_0130

namespace	http://xml.ir-d.de/emg		
type	restriction of <b>string</b>		
properties	base xs:string		
used by	element <a href="#">ArtikelBrustimplantatBasis/ABI_HerstellerSchluessel</a>		
facets	Kind	Value	Annotation
	enumeration	0130001	documentation Allergan
	enumeration	0130002	documentation Cereplas
	enumeration	0130003	documentation CUI (Cox Uphoff Implants)
	enumeration	0130004	documentation EMSI Biomedical
	enumeration	0130005	documentation Establishment labs
	enumeration	0130006	documentation Eurosilicone
	enumeration	0130007	documentation Nagor
	enumeration	0130008	documentation Groupe Sebbin
	enumeration	0130009	documentation Laboratoires Arion
	enumeration	0130010	documentation Mentor
	enumeration	0130011	documentation Pérouse Plastie SAS
	enumeration	0130012	documentation PIP M-Implants
	enumeration	0130013	documentation Polytech Health & Aesthetics
	enumeration	0130014	documentation Silimed
	enumeration	0130015	documentation Surgitek
	enumeration	0130016	documentation G&G Biotechnology
	enumeration	0130017	documentation nicht belegter Wert
	enumeration	0130018	documentation nicht belegter Wert
	enumeration	0130019	documentation nicht belegter Wert
	enumeration	0130020	documentation nicht belegter Wert
	enumeration	0130021	documentation nicht belegter Wert

	enumeration 0130042 documentation sonstiger
annotation	documentation Kat_BI_Hersteller
source	<pre> &lt;simpleType name="enum_0130"&gt;   &lt;annotation&gt;     &lt;documentation&gt;Kat_BI_Hersteller&lt;/documentation&gt;   &lt;/annotation&gt;   &lt;restriction base="xs:string"&gt;     &lt;enumeration value="0130001"&gt;       &lt;annotation&gt;         &lt;documentation&gt;Allergan&lt;/documentation&gt;       &lt;/annotation&gt;     &lt;/enumeration&gt;     &lt;enumeration value="0130002"&gt;       &lt;annotation&gt;         &lt;documentation&gt;Cereplas&lt;/documentation&gt;       &lt;/annotation&gt;     &lt;/enumeration&gt;     &lt;enumeration value="0130003"&gt;       &lt;annotation&gt;         &lt;documentation&gt;CUI (Cox Uphoff Implants)&lt;/documentation&gt;       &lt;/annotation&gt;     &lt;/enumeration&gt;     &lt;enumeration value="0130004"&gt;       &lt;annotation&gt;         &lt;documentation&gt;EMSI Biomedical&lt;/documentation&gt;       &lt;/annotation&gt;     &lt;/enumeration&gt;     &lt;enumeration value="0130005"&gt;       &lt;annotation&gt;         &lt;documentation&gt;Establishment labs&lt;/documentation&gt;       &lt;/annotation&gt;     &lt;/enumeration&gt;     &lt;enumeration value="0130006"&gt;       &lt;annotation&gt;         &lt;documentation&gt;Eurosilicone&lt;/documentation&gt;       &lt;/annotation&gt;     &lt;/enumeration&gt;     &lt;enumeration value="0130007"&gt;       &lt;annotation&gt;         &lt;documentation&gt;Nagor&lt;/documentation&gt;       &lt;/annotation&gt;     &lt;/enumeration&gt;     &lt;enumeration value="0130008"&gt;       &lt;annotation&gt;         &lt;documentation&gt;Groupe Sebbin&lt;/documentation&gt;       &lt;/annotation&gt;     &lt;/enumeration&gt;     &lt;enumeration value="0130009"&gt;       &lt;annotation&gt;         &lt;documentation&gt;Laboratoires Arion&lt;/documentation&gt;       &lt;/annotation&gt;     &lt;/enumeration&gt;     &lt;enumeration value="0130010"&gt;       &lt;annotation&gt;         &lt;documentation&gt;Mentor&lt;/documentation&gt;       &lt;/annotation&gt;     &lt;/enumeration&gt;   &lt;/restriction&gt; &lt;/simpleType&gt; </pre>



```
<enumeration value="0130011">
  <annotation>
    <documentation>Pérouse Plastie SAS</documentation>
  </annotation>
</enumeration>
<enumeration value="0130012">
  <annotation>
    <documentation>PIP M-Implants</documentation>
  </annotation>
</enumeration>
<enumeration value="0130013">
  <annotation>
    <documentation>Polytech Health & Aesthetics</documentation>
  </annotation>
</enumeration>
<enumeration value="0130014">
  <annotation>
    <documentation>Silimed</documentation>
  </annotation>
</enumeration>
<enumeration value="0130015">
  <annotation>
    <documentation>Surgitek</documentation>
  </annotation>
</enumeration>
<enumeration value="0130016">
  <annotation>
    <documentation>G&G Biotechnology</documentation>
  </annotation>
</enumeration>
<enumeration value="0130017">
  <annotation>
    <documentation>nicht belegter Wert</documentation>
  </annotation>
</enumeration>
<enumeration value="0130018">
  <annotation>
    <documentation>nicht belegter Wert</documentation>
  </annotation>
</enumeration>
<enumeration value="0130019">
  <annotation>
    <documentation>nicht belegter Wert</documentation>
  </annotation>
</enumeration>
<enumeration value="0130020">
  <annotation>
    <documentation>nicht belegter Wert</documentation>
  </annotation>
</enumeration>
<enumeration value="0130021">
  <annotation>
    <documentation>nicht belegter Wert</documentation>
  </annotation>
</enumeration>
<enumeration value="0130042">
  <annotation>
    <documentation>sonstiger</documentation>
  </annotation>
</enumeration>
```

```

</enumeration>
</restriction>
</simpleType>

```

### simpleType enum\_0131

namespace	http://xml.ir-d.de/emg		
type	restriction of <b>string</b>		
properties	base xs:string		
used by	element	<a href="#">ZubehoerBrustimplantatBasis/ZBI_HerstellerSchluessel</a>	
facets	Kind	Value	Annotation
	enumeration	0131001	documentation Allergan
	enumeration	0131002	documentation Establishment labs
	enumeration	0131003	documentation Eurosilicone
	enumeration	0131004	documentation Galatea
	enumeration	0131005	documentation Integra
	enumeration	0131006	documentation Lifecell
	enumeration	0131007	documentation MBP (Medical Biomaterial Products)
	enumeration	0131008	documentation Mentor
	enumeration	0131009	documentation Novus Scientific
	enumeration	0131010	documentation pfmMedical
	enumeration	0131011	documentation nicht belegter Wert
	enumeration	0131012	documentation nicht belegter Wert
	enumeration	0131013	documentation nicht belegter Wert
	enumeration	0131014	documentation nicht belegter Wert
	enumeration	0131015	documentation nicht belegter Wert
	enumeration	0131042	documentation sonstiger
annotation	documentation	Kat_BI_ZubehoerHersteller	
source	<pre> &lt;simpleType name="enum_0131"&gt;   &lt;annotation&gt;     &lt;documentation&gt;Kat_BI_ZubehoerHersteller&lt;/documentation&gt;   &lt;/annotation&gt;   &lt;restriction base="xs:string"&gt;     &lt;enumeration value="0131001"&gt;       &lt;annotation&gt;         &lt;documentation&gt;Allergan&lt;/documentation&gt;       &lt;/annotation&gt;     &lt;/enumeration&gt;     &lt;enumeration value="0131002"&gt;       &lt;annotation&gt;         &lt;documentation&gt;Establishment labs&lt;/documentation&gt;       &lt;/annotation&gt;     &lt;/enumeration&gt;   &lt;/restriction&gt; &lt;/simpleType&gt; </pre>		

```
</enumeration>
<enumeration value="0131003">
  <annotation>
    <documentation>Eurosilicone</documentation>
  </annotation>
</enumeration>
<enumeration value="0131004">
  <annotation>
    <documentation>Galatea</documentation>
  </annotation>
</enumeration>
<enumeration value="0131005">
  <annotation>
    <documentation>Integra</documentation>
  </annotation>
</enumeration>
<enumeration value="0131006">
  <annotation>
    <documentation>Lifecell</documentation>
  </annotation>
</enumeration>
<enumeration value="0131007">
  <annotation>
    <documentation>MBP (Medical Biomaterial Products)</documentation>
  </annotation>
</enumeration>
<enumeration value="0131008">
  <annotation>
    <documentation>Mentor</documentation>
  </annotation>
</enumeration>
<enumeration value="0131009">
  <annotation>
    <documentation>Novus Scientific</documentation>
  </annotation>
</enumeration>
<enumeration value="0131010">
  <annotation>
    <documentation>pfmMedical</documentation>
  </annotation>
</enumeration>
<enumeration value="0131011">
  <annotation>
    <documentation>nicht belegter Wert</documentation>
  </annotation>
</enumeration>
<enumeration value="0131012">
  <annotation>
    <documentation>nicht belegter Wert</documentation>
  </annotation>
</enumeration>
<enumeration value="0131013">
  <annotation>
    <documentation>nicht belegter Wert</documentation>
  </annotation>
</enumeration>
<enumeration value="0131014">
  <annotation>
    <documentation>nicht belegter Wert</documentation>
  </annotation>
</enumeration>
```

	<pre> &lt;/annotation&gt; &lt;/enumeration&gt; &lt;enumeration value="0131015"&gt;   &lt;annotation&gt;     &lt;documentation&gt;nicht belegter Wert&lt;/documentation&gt;   &lt;/annotation&gt; &lt;/enumeration&gt; &lt;enumeration value="0131042"&gt;   &lt;annotation&gt;     &lt;documentation&gt;sonstiger&lt;/documentation&gt;   &lt;/annotation&gt; &lt;/enumeration&gt; &lt;/restriction&gt; &lt;/simpleType&gt; </pre>
--	--

### simpleType enum\_0190

namespace	http://xml.ir-d.de/emg									
type	restriction of <b>string</b>									
properties	base xs:string									
used by	element <a href="#">ArtikelBrustimplantatBasis/ABI ArtikelTypSchluessel</a>									
facets	<table border="1"> <thead> <tr> <th>Kind</th> <th>Value</th> <th>Annotation</th> </tr> </thead> <tbody> <tr> <td>enumeration</td> <td>0190001</td> <td>documentation Brustimplantat</td> </tr> <tr> <td>enumeration</td> <td>0190003</td> <td>documentation Brustexpander</td> </tr> </tbody> </table>	Kind	Value	Annotation	enumeration	0190001	documentation Brustimplantat	enumeration	0190003	documentation Brustexpander
Kind	Value	Annotation								
enumeration	0190001	documentation Brustimplantat								
enumeration	0190003	documentation Brustexpander								
annotation	documentation Kat_BI_Artikeltyp									
source	<pre> &lt;simpleType name="enum_0190"&gt;   &lt;annotation&gt;     &lt;documentation&gt;Kat_BI_Artikeltyp&lt;/documentation&gt;   &lt;/annotation&gt;   &lt;restriction base="xs:string"&gt;     &lt;enumeration value="0190001"&gt;       &lt;annotation&gt;         &lt;documentation&gt;Brustimplantat&lt;/documentation&gt;       &lt;/annotation&gt;     &lt;/enumeration&gt;     &lt;enumeration value="0190003"&gt;       &lt;annotation&gt;         &lt;documentation&gt;Brustexpander&lt;/documentation&gt;       &lt;/annotation&gt;     &lt;/enumeration&gt;   &lt;/restriction&gt; &lt;/simpleType&gt; </pre>									

### simpleType enum\_0191

namespace	http://xml.ir-d.de/emg
type	restriction of <b>string</b>
properties	base xs:string
used by	element <a href="#">ZubehoerBrustimplantatBasis/ZBI Zu behoe erTypSchluessel</a>

facets	<table border="1"> <thead> <tr> <th>Kind</th> <th>Value</th> <th>Annotation</th> </tr> </thead> <tbody> <tr> <td>enumeration</td> <td>0191001</td> <td>documentation Netz</td> </tr> <tr> <td>enumeration</td> <td>0191002</td> <td>documentation ADM</td> </tr> </tbody> </table>	Kind	Value	Annotation	enumeration	0191001	documentation Netz	enumeration	0191002	documentation ADM
Kind	Value	Annotation								
enumeration	0191001	documentation Netz								
enumeration	0191002	documentation ADM								
annotation	documentation Kat_BI_ZubehoerTyp									
source	<pre>&lt;simpleType name="enum_0191"&gt;   &lt;annotation&gt;     &lt;documentation&gt;Kat_BI_ZubehoerTyp&lt;/documentation&gt;   &lt;/annotation&gt;   &lt;restriction base="xs:string"&gt;     &lt;enumeration value="0191001"&gt;       &lt;annotation&gt;         &lt;documentation&gt;Netz&lt;/documentation&gt;       &lt;/annotation&gt;     &lt;/enumeration&gt;     &lt;enumeration value="0191002"&gt;       &lt;annotation&gt;         &lt;documentation&gt;ADM&lt;/documentation&gt;       &lt;/annotation&gt;     &lt;/enumeration&gt;   &lt;/restriction&gt; &lt;/simpleType&gt;</pre>									

### simpleType enum\_0200

namespace	http://xml.ir-d.de/emg									
type	restriction of <b>string</b>									
properties	base xs:string									
used by	element <a href="#">OperationEndoprotheseBasis/OEP ArtEingriffSchlüssel</a>									
facets	<table border="1"> <thead> <tr> <th>Kind</th> <th>Value</th> <th>Annotation</th> </tr> </thead> <tbody> <tr> <td>enumeration</td> <td>0200001</td> <td>documentation Erst-OP</td> </tr> <tr> <td>enumeration</td> <td>0200002</td> <td>documentation Folgeeingriff</td> </tr> </tbody> </table>	Kind	Value	Annotation	enumeration	0200001	documentation Erst-OP	enumeration	0200002	documentation Folgeeingriff
Kind	Value	Annotation								
enumeration	0200001	documentation Erst-OP								
enumeration	0200002	documentation Folgeeingriff								
annotation	documentation Kat_EP_ArtEingriff									
source	<pre>&lt;simpleType name="enum_0200"&gt;   &lt;annotation&gt;     &lt;documentation&gt;Kat_EP_ArtEingriff&lt;/documentation&gt;   &lt;/annotation&gt;   &lt;restriction base="xs:string"&gt;     &lt;enumeration value="0200001"&gt;       &lt;annotation&gt;         &lt;documentation&gt;Erst-OP&lt;/documentation&gt;       &lt;/annotation&gt;     &lt;/enumeration&gt;     &lt;enumeration value="0200002"&gt;       &lt;annotation&gt;         &lt;documentation&gt;Folgeeingriff&lt;/documentation&gt;       &lt;/annotation&gt;     &lt;/enumeration&gt;   &lt;/restriction&gt; &lt;/simpleType&gt;</pre>									

## simpleType enum\_0202

namespace	http://xml.ir-d.de/emg		
type	restriction of <b>string</b>		
properties	base xs:string		
used by	element <a href="#">OperationEndoprotheseBasis/OEP GrundWechselHuefteSchluessel</a>		
facets	Kind	Value	Annotation
	enumeration	0202001	documentation Lockerung
	enumeration	0202002	documentation Infektion, Verdacht auf
	enumeration	0202003	documentation Infektion, gesichert
	enumeration	0202004	documentation Luxation, Inlay aus der Pfanne
	enumeration	0202005	documentation Luxation, Kopf aus Pfanne/Inlay
	enumeration	0202006	documentation Periprothetische Fraktur
	enumeration	0202007	documentation Verschleiß des PE-Inlays
	enumeration	0202008	documentation Implantatbruch
	enumeration	0202009	documentation Implantatfehlage/Malalignement
	enumeration	0202010	documentation Osteolysen bei festem Implantat
	enumeration	0202011	documentation Progression der Grunderkrankung
	enumeration	0202012	documentation ARM-D
	enumeration	0202013	documentation Verdacht auf allergische Reaktion
	enumeration	0202021	documentation Zustand nach Prothesenentfernung
	enumeration	0202042	documentation andere Gründe
annotation	documentation Kat_EP_GrundWechselHuefte		
source	<pre> &lt;simpleType name="enum_0202"&gt;   &lt;annotation&gt;     &lt;documentation&gt;Kat_EP_GrundWechselHuefte&lt;/documentation&gt;   &lt;/annotation&gt;   &lt;restriction base="xs:string"&gt;     &lt;enumeration value="0202001"&gt;       &lt;annotation&gt;         &lt;documentation&gt;Lockerung&lt;/documentation&gt;       &lt;/annotation&gt;     &lt;/enumeration&gt;     &lt;enumeration value="0202002"&gt;       &lt;annotation&gt;         &lt;documentation&gt;Infektion, Verdacht auf&lt;/documentation&gt;       &lt;/annotation&gt;     &lt;/enumeration&gt;     &lt;enumeration value="0202003"&gt;       &lt;annotation&gt;         &lt;documentation&gt;Infektion, gesichert&lt;/documentation&gt;       &lt;/annotation&gt;     &lt;/enumeration&gt;   &lt;/restriction&gt; &lt;/simpleType&gt; </pre>		

```
<enumeration value="0202004">
  <annotation>
    <documentation>Luxation, Inlay aus der Pfanne</documentation>
  </annotation>
</enumeration>
<enumeration value="0202005">
  <annotation>
    <documentation>Luxation, Kopf aus Pfanne/Inlay</documentation>
  </annotation>
</enumeration>
<enumeration value="0202006">
  <annotation>
    <documentation>Periprothetische Fraktur</documentation>
  </annotation>
</enumeration>
<enumeration value="0202007">
  <annotation>
    <documentation>Verschleiß des PE-Inlays</documentation>
  </annotation>
</enumeration>
<enumeration value="0202008">
  <annotation>
    <documentation>Implantatbruch</documentation>
  </annotation>
</enumeration>
<enumeration value="0202009">
  <annotation>
    <documentation>Implantatfehlage/Malalignent</documentation>
  </annotation>
</enumeration>
<enumeration value="0202010">
  <annotation>
    <documentation>Osteolysen bei festem Implantat</documentation>
  </annotation>
</enumeration>
<enumeration value="0202011">
  <annotation>
    <documentation>Progression der Grunderkrankung</documentation>
  </annotation>
</enumeration>
<enumeration value="0202012">
  <annotation>
    <documentation>ARMD</documentation>
  </annotation>
</enumeration>
<enumeration value="0202013">
  <annotation>
    <documentation>Verdacht auf allergische Reaktion</documentation>
  </annotation>
</enumeration>
<enumeration value="0202021">
  <annotation>
    <documentation>Zustand nach Prothesenentfernung</documentation>
  </annotation>
</enumeration>
<enumeration value="0202042">
  <annotation>
    <documentation>andere Gründe</documentation>
  </annotation>
</enumeration>
```

```

</enumeration>
</restriction>
</simpleType>

```

### simpleType enum\_0204

namespace	http://xml.ir-d.de/emg		
type	restriction of <b>string</b>		
properties	base xs:string		
used by	element	<a href="#">OperationEndoprotheseBasis/OEP GrundWechselKnieSchlüssel</a>	
facets	Kind	Value	Annotation
	enumeration	0204001	documentation Lockerung
	enumeration	0204002	documentation Infektion, Verdacht auf
	enumeration	0204003	documentation Infektion, gesichert
	enumeration	0204006	documentation Periprothetische Fraktur
	enumeration	0204007	documentation Verschleiß
	enumeration	0204008	documentation Implantatbruch
	enumeration	0204009	documentation Implantatfehlage/Malalignent
	enumeration	0204010	documentation Osteolysen bei festem Implantat
	enumeration	0204011	documentation Progression der Grunderkrankung
	enumeration	0204012	documentation ARMD
	enumeration	0204013	documentation Verdacht auf allergische Reaktion
	enumeration	0204014	documentation Dislokation/Migration von Komponenten
	enumeration	0204015	documentation Bandinstabilität
	enumeration	0204016	documentation Bewegungseinschränkung
	enumeration	0204021	documentation Zustand nach Prothesenentfernung
	enumeration	0204042	documentation andere Gründe
annotation	documentation	Kat_EP_GrundWechselKnie	
source	<pre> &lt;simpleType name="enum_0204"&gt;   &lt;annotation&gt;     &lt;documentation&gt;Kat_EP_GrundWechselKnie&lt;/documentation&gt;   &lt;/annotation&gt;   &lt;restriction base="xs:string"&gt;     &lt;enumeration value="0204001"&gt;       &lt;annotation&gt;         &lt;documentation&gt;Lockerung&lt;/documentation&gt;       &lt;/annotation&gt;     &lt;/enumeration&gt;     &lt;enumeration value="0204002"&gt;       &lt;annotation&gt;         &lt;documentation&gt;Infektion, Verdacht auf&lt;/documentation&gt;       &lt;/annotation&gt;     &lt;/enumeration&gt;   &lt;/restriction&gt; &lt;/simpleType&gt; </pre>		



```
</enumeration>
<enumeration value="0204003">
  <annotation>
    <documentation>Infektion, gesichert</documentation>
  </annotation>
</enumeration>
<enumeration value="0204006">
  <annotation>
    <documentation>Periprothetische Fraktur</documentation>
  </annotation>
</enumeration>
<enumeration value="0204007">
  <annotation>
    <documentation>Verschleiß</documentation>
  </annotation>
</enumeration>
<enumeration value="0204008">
  <annotation>
    <documentation>Implantatbruch</documentation>
  </annotation>
</enumeration>
<enumeration value="0204009">
  <annotation>
    <documentation>Implantatfehlage/Malalignement</documentation>
  </annotation>
</enumeration>
<enumeration value="0204010">
  <annotation>
    <documentation>Osteolysen bei festem Implantat</documentation>
  </annotation>
</enumeration>
<enumeration value="0204011">
  <annotation>
    <documentation>Progression der Grunderkrankung</documentation>
  </annotation>
</enumeration>
<enumeration value="0204012">
  <annotation>
    <documentation>ARMD</documentation>
  </annotation>
</enumeration>
<enumeration value="0204013">
  <annotation>
    <documentation>Verdacht auf allergische Reaktion</documentation>
  </annotation>
</enumeration>
<enumeration value="0204014">
  <annotation>
    <documentation>Dislokation/Migration von Komponenten</documentation>
  </annotation>
</enumeration>
<enumeration value="0204015">
  <annotation>
    <documentation>Bandinstabilität</documentation>
  </annotation>
</enumeration>
<enumeration value="0204016">
  <annotation>
    <documentation>Bewegungseinschränkung</documentation>
  </annotation>
</enumeration>
```

```

</annotation>
</enumeration>
<enumeration value="0204021">
  <annotation>
    <documentation>Zustand nach Prothesenentfernung</documentation>
  </annotation>
</enumeration>
<enumeration value="0204042">
  <annotation>
    <documentation>andere Gründe</documentation>
  </annotation>
</enumeration>
</restriction>
</simpleType>

```

### simpleType enum\_0206

namespace	http://xml.ir-d.de/emg		
type	restriction of <b>string</b>		
properties	base xs:string		
used by	element <a href="#">OperationEndprotheseBasis/OEP_GrundWechselTfeSchluessel</a>		
facets	Kind	Value	Annotation
	enumeration	0206001	documentation Lockerung
	enumeration	0206002	documentation Infektion, Verdacht auf
	enumeration	0206003	documentation Infektion, gesichert
	enumeration	0206004	documentation Luxation, Inlay aus der Pfanne
	enumeration	0206005	documentation Luxation, Kopf aus Pfanne/Inlay
	enumeration	0206006	documentation Periprothetische Fraktur
	enumeration	0206007	documentation Verschleiß
	enumeration	0206008	documentation Implantatbruch
	enumeration	0206009	documentation Implantatfehlage/Malalignent
	enumeration	0206010	documentation Osteolysen bei festem Implantat
	enumeration	0206011	documentation Progression der Grunderkrankung
	enumeration	0206012	documentation ARMD
	enumeration	0206013	documentation Verdacht auf allergische Reaktion
	enumeration	0206014	documentation Dislokation/Migration von Komponenten
	enumeration	0206015	documentation Bandinstabilität
	enumeration	0206016	documentation Bewegungseinschränkung
	enumeration	0206021	documentation Zustand nach Prothesenentfernung
	enumeration	0206042	documentation andere Gründe

annotation	documentation Kat_EP_GrundWechselTFE
source	<pre> &lt;simpleType name="enum_0206"&gt;   &lt;annotation&gt;     &lt;documentation&gt;Kat_EP_GrundWechselTFE&lt;/documentation&gt;   &lt;/annotation&gt;   &lt;restriction base="xs:string"&gt;     &lt;enumeration value="0206001"&gt;       &lt;annotation&gt;         &lt;documentation&gt;Lockerung&lt;/documentation&gt;       &lt;/annotation&gt;     &lt;/enumeration&gt;     &lt;enumeration value="0206002"&gt;       &lt;annotation&gt;         &lt;documentation&gt;Infektion, Verdacht auf&lt;/documentation&gt;       &lt;/annotation&gt;     &lt;/enumeration&gt;     &lt;enumeration value="0206003"&gt;       &lt;annotation&gt;         &lt;documentation&gt;Infektion, gesichert&lt;/documentation&gt;       &lt;/annotation&gt;     &lt;/enumeration&gt;     &lt;enumeration value="0206004"&gt;       &lt;annotation&gt;         &lt;documentation&gt;Luxation, Inlay aus der Pfanne&lt;/documentation&gt;       &lt;/annotation&gt;     &lt;/enumeration&gt;     &lt;enumeration value="0206005"&gt;       &lt;annotation&gt;         &lt;documentation&gt;Luxation, Kopf aus Pfanne/Inlay&lt;/documentation&gt;       &lt;/annotation&gt;     &lt;/enumeration&gt;     &lt;enumeration value="0206006"&gt;       &lt;annotation&gt;         &lt;documentation&gt;Periprothetische Fraktur&lt;/documentation&gt;       &lt;/annotation&gt;     &lt;/enumeration&gt;     &lt;enumeration value="0206007"&gt;       &lt;annotation&gt;         &lt;documentation&gt;Verschleiß&lt;/documentation&gt;       &lt;/annotation&gt;     &lt;/enumeration&gt;     &lt;enumeration value="0206008"&gt;       &lt;annotation&gt;         &lt;documentation&gt;Implantatbruch&lt;/documentation&gt;       &lt;/annotation&gt;     &lt;/enumeration&gt;     &lt;enumeration value="0206009"&gt;       &lt;annotation&gt;         &lt;documentation&gt;Implantatfehllage/Malalignent&lt;/documentation&gt;       &lt;/annotation&gt;     &lt;/enumeration&gt;     &lt;enumeration value="0206010"&gt;       &lt;annotation&gt;         &lt;documentation&gt;Osteolysen bei festem Implantat&lt;/documentation&gt;       &lt;/annotation&gt;     &lt;/enumeration&gt;     &lt;enumeration value="0206011"&gt;       &lt;annotation&gt; </pre>

```

    <documentation>Progression der Grunderkrankung</documentation>
  </annotation>
</enumeration>
<enumeration value="0206012">
  <annotation>
    <documentation>ARMD</documentation>
  </annotation>
</enumeration>
<enumeration value="0206013">
  <annotation>
    <documentation>Verdacht auf allergische Reaktion</documentation>
  </annotation>
</enumeration>
<enumeration value="0206014">
  <annotation>
    <documentation>Dislokation/Migration von Komponenten</documentation>
  </annotation>
</enumeration>
<enumeration value="0206015">
  <annotation>
    <documentation>Bandinstabilität</documentation>
  </annotation>
</enumeration>
<enumeration value="0206016">
  <annotation>
    <documentation>Bewegungseinschränkung</documentation>
  </annotation>
</enumeration>
<enumeration value="0206021">
  <annotation>
    <documentation>Zustand nach Prothesenentfernung</documentation>
  </annotation>
</enumeration>
<enumeration value="0206042">
  <annotation>
    <documentation>andere Gründe</documentation>
  </annotation>
</enumeration>
</restriction>
</simpleType>

```

### simpleType enum\_0210

namespace	http://xml.ir-d.de/emg		
type	restriction of <b>string</b>		
properties	base xs:string		
used by	element <a href="#">VorbereitungEndoprotheseBasis/VEP_VorOpHuefteSchluessel</a>		
facets	Kind	Value	Annotation
	enumeration	0210001	documentation keine relevante Voroperation
	enumeration	0210002	documentation Osteosynthese/Osteotomie (Becken)
	enumeration	0210003	documentation Osteosynthese/Osteotomie (Femur)
	enumeration	0210004	documentation Osteosynthese/Osteotomie (beides)
	enumeration	0210005	documentation

	<p>enumeration 0210006    Operation bei Hüftkopfnekrose documentation Arthrodese</p> <p>enumeration 0210042    documentation andere</p>
annotation	documentation Kat_EP_VoroperationHuefte
source	<pre> &lt;simpleType name="enum_0210"&gt;   &lt;annotation&gt;     &lt;documentation&gt;Kat_EP_VoroperationHuefte&lt;/documentation&gt;   &lt;/annotation&gt;   &lt;restriction base="xs:string"&gt;     &lt;enumeration value="0210001"&gt;       &lt;annotation&gt;         &lt;documentation&gt;keine relevante Voroperation&lt;/documentation&gt;       &lt;/annotation&gt;     &lt;/enumeration&gt;     &lt;enumeration value="0210002"&gt;       &lt;annotation&gt;         &lt;documentation&gt;Osteosynthese/Osteotomie (Becken)&lt;/documentation&gt;       &lt;/annotation&gt;     &lt;/enumeration&gt;     &lt;enumeration value="0210003"&gt;       &lt;annotation&gt;         &lt;documentation&gt;Osteosynthese/Osteotomie (Femur)&lt;/documentation&gt;       &lt;/annotation&gt;     &lt;/enumeration&gt;     &lt;enumeration value="0210004"&gt;       &lt;annotation&gt;         &lt;documentation&gt;Osteosynthese/Osteotomie (beides)&lt;/documentation&gt;       &lt;/annotation&gt;     &lt;/enumeration&gt;     &lt;enumeration value="0210005"&gt;       &lt;annotation&gt;         &lt;documentation&gt;Operation bei Hüftkopfnekrose&lt;/documentation&gt;       &lt;/annotation&gt;     &lt;/enumeration&gt;     &lt;enumeration value="0210006"&gt;       &lt;annotation&gt;         &lt;documentation&gt;Arthrodese&lt;/documentation&gt;       &lt;/annotation&gt;     &lt;/enumeration&gt;     &lt;enumeration value="0210042"&gt;       &lt;annotation&gt;         &lt;documentation&gt;andere&lt;/documentation&gt;       &lt;/annotation&gt;     &lt;/enumeration&gt;   &lt;/restriction&gt; &lt;/simpleType&gt; </pre>

### simpleType enum\_0211

namespace	http://xml.ir-d.de/emg
type	restriction of <b>string</b>
properties	base xs:string
used by	element <a href="#">VorbereitungEndoprotheseBasis/VEP_VorOpKnieSchlüssel</a>

facets	<table border="1"> <thead> <tr> <th data-bbox="292 203 432 226">Kind</th> <th data-bbox="432 203 544 226">Value</th> <th data-bbox="544 203 1434 226">Annotation</th> </tr> </thead> <tbody> <tr> <td data-bbox="292 226 432 248">enumeration</td> <td data-bbox="432 226 544 248">0211001</td> <td data-bbox="544 226 1434 248">documentation keine relevante Voroperation</td> </tr> <tr> <td data-bbox="292 248 432 271">enumeration</td> <td data-bbox="432 248 544 271">0211002</td> <td data-bbox="544 248 1434 271">documentation Osteosynthese/Osteotomie (Femur)</td> </tr> <tr> <td data-bbox="292 271 432 293">enumeration</td> <td data-bbox="432 271 544 293">0211003</td> <td data-bbox="544 271 1434 293">documentation Osteosynthese/Osteotomie (Tibia)</td> </tr> <tr> <td data-bbox="292 293 432 315">enumeration</td> <td data-bbox="432 293 544 315">0211004</td> <td data-bbox="544 293 1434 315">documentation Osteosynthese/Osteotomie (Patella)</td> </tr> <tr> <td data-bbox="292 315 432 338">enumeration</td> <td data-bbox="432 315 544 338">0211005</td> <td data-bbox="544 315 1434 338">documentation Osteosynthese/Osteotomie (mehrere)</td> </tr> <tr> <td data-bbox="292 338 432 360">enumeration</td> <td data-bbox="432 338 544 360">0211006</td> <td data-bbox="544 338 1434 360">documentation Kapsel-/Bandapparat</td> </tr> <tr> <td data-bbox="292 360 432 383">enumeration</td> <td data-bbox="432 360 544 383">0211007</td> <td data-bbox="544 360 1434 383">documentation Arthrodese</td> </tr> <tr> <td data-bbox="292 383 432 405">enumeration</td> <td data-bbox="432 383 544 405">0211042</td> <td data-bbox="544 383 1434 405">documentation andere</td> </tr> </tbody> </table>	Kind	Value	Annotation	enumeration	0211001	documentation keine relevante Voroperation	enumeration	0211002	documentation Osteosynthese/Osteotomie (Femur)	enumeration	0211003	documentation Osteosynthese/Osteotomie (Tibia)	enumeration	0211004	documentation Osteosynthese/Osteotomie (Patella)	enumeration	0211005	documentation Osteosynthese/Osteotomie (mehrere)	enumeration	0211006	documentation Kapsel-/Bandapparat	enumeration	0211007	documentation Arthrodese	enumeration	0211042	documentation andere
Kind	Value	Annotation																										
enumeration	0211001	documentation keine relevante Voroperation																										
enumeration	0211002	documentation Osteosynthese/Osteotomie (Femur)																										
enumeration	0211003	documentation Osteosynthese/Osteotomie (Tibia)																										
enumeration	0211004	documentation Osteosynthese/Osteotomie (Patella)																										
enumeration	0211005	documentation Osteosynthese/Osteotomie (mehrere)																										
enumeration	0211006	documentation Kapsel-/Bandapparat																										
enumeration	0211007	documentation Arthrodese																										
enumeration	0211042	documentation andere																										
annotation	documentation Kat_EP_VoroperationKnie																											
source	<pre data-bbox="280 745 1362 2016"> &lt;simpleType name="enum_0211"&gt;   &lt;annotation&gt;     &lt;documentation&gt;Kat_EP_VoroperationKnie&lt;/documentation&gt;   &lt;/annotation&gt;   &lt;restriction base="xs:string"&gt;     &lt;enumeration value="0211001"&gt;       &lt;annotation&gt;         &lt;documentation&gt;keine relevante Voroperation&lt;/documentation&gt;       &lt;/annotation&gt;     &lt;/enumeration&gt;     &lt;enumeration value="0211002"&gt;       &lt;annotation&gt;         &lt;documentation&gt;Osteosynthese/Osteotomie (Femur)&lt;/documentation&gt;       &lt;/annotation&gt;     &lt;/enumeration&gt;     &lt;enumeration value="0211003"&gt;       &lt;annotation&gt;         &lt;documentation&gt;Osteosynthese/Osteotomie (Tibia)&lt;/documentation&gt;       &lt;/annotation&gt;     &lt;/enumeration&gt;     &lt;enumeration value="0211004"&gt;       &lt;annotation&gt;         &lt;documentation&gt;Osteosynthese/Osteotomie (Patella)&lt;/documentation&gt;       &lt;/annotation&gt;     &lt;/enumeration&gt;     &lt;enumeration value="0211005"&gt;       &lt;annotation&gt;         &lt;documentation&gt;Osteosynthese/Osteotomie (mehrere)&lt;/documentation&gt;       &lt;/annotation&gt;     &lt;/enumeration&gt;     &lt;enumeration value="0211006"&gt;       &lt;annotation&gt;         &lt;documentation&gt;Kapsel-/Bandapparat&lt;/documentation&gt;       &lt;/annotation&gt;     &lt;/enumeration&gt;     &lt;enumeration value="0211007"&gt;       &lt;annotation&gt;         &lt;documentation&gt;Arthrodese&lt;/documentation&gt;       &lt;/annotation&gt;     &lt;/enumeration&gt;     &lt;enumeration value="0211042"&gt; </pre>																											

	<pre> &lt;annotation&gt;   &lt;documentation&gt;andere&lt;/documentation&gt; &lt;/annotation&gt; &lt;/enumeration&gt; &lt;/restriction&gt; &lt;/simpleType&gt; </pre>
--	---

### simpleType enum\_0212

namespace	http://xml.ir-d.de/emg		
type	restriction of <b>string</b>		
properties	base xs:string		
used by	element	<a href="#">OperationEndoprotheseBasis/OEP GelenkSchluessel</a>	
facets	Kind	Value	Annotation
	enumeration	0212001	documentation Hüfte
	enumeration	0212002	documentation Knie
	enumeration	0212003	documentation Totaler Femurersatz inkl. Durchsteck-Prothese
annotation	documentation Kat_EP_Gelenk		
source	<pre> &lt;simpleType name="enum_0212"&gt;   &lt;annotation&gt;     &lt;documentation&gt;Kat_EP_Gelenk&lt;/documentation&gt;   &lt;/annotation&gt;   &lt;restriction base="xs:string"&gt;     &lt;enumeration value="0212001"&gt;       &lt;annotation&gt;         &lt;documentation&gt;Hüfte&lt;/documentation&gt;       &lt;/annotation&gt;     &lt;/enumeration&gt;     &lt;enumeration value="0212002"&gt;       &lt;annotation&gt;         &lt;documentation&gt;Knie&lt;/documentation&gt;       &lt;/annotation&gt;     &lt;/enumeration&gt;     &lt;enumeration value="0212003"&gt;       &lt;annotation&gt;         &lt;documentation&gt;Totaler Femurersatz inkl. Durchsteck-Prothese&lt;/documentation&gt;       &lt;/annotation&gt;     &lt;/enumeration&gt;   &lt;/restriction&gt; &lt;/simpleType&gt; </pre>		

### simpleType enum\_0220

namespace	http://xml.ir-d.de/emg		
type	restriction of <b>string</b>		
properties	base xs:string		
used by	element	<a href="#">OperationEndoprotheseBasis/OEP ZugangHuefteSchluessel</a>	

facets	<table border="1"> <thead> <tr> <th data-bbox="293 199 440 226">Kind</th> <th data-bbox="440 199 555 226">Value</th> <th data-bbox="555 199 1434 226">Annotation</th> </tr> </thead> <tbody> <tr> <td data-bbox="293 226 440 277">enumeration</td> <td data-bbox="440 226 555 277">0220001</td> <td data-bbox="555 226 1434 277">documentation anterior</td> </tr> <tr> <td data-bbox="293 277 440 329">enumeration</td> <td data-bbox="440 277 555 329">0220002</td> <td data-bbox="555 277 1434 329">documentation anterolateral</td> </tr> <tr> <td data-bbox="293 329 440 380">enumeration</td> <td data-bbox="440 329 555 380">0220003</td> <td data-bbox="555 329 1434 380">documentation lateral</td> </tr> <tr> <td data-bbox="293 380 440 432">enumeration</td> <td data-bbox="440 380 555 432">0220004</td> <td data-bbox="555 380 1434 432">documentation posterior</td> </tr> <tr> <td data-bbox="293 432 440 483">enumeration</td> <td data-bbox="440 432 555 483">0220005</td> <td data-bbox="555 432 1434 483">documentation posterolateral</td> </tr> <tr> <td data-bbox="293 483 440 535">enumeration</td> <td data-bbox="440 483 555 535">0220006</td> <td data-bbox="555 483 1434 535">documentation 2-Inzisionen-Zugang</td> </tr> <tr> <td data-bbox="293 535 440 618">enumeration</td> <td data-bbox="440 535 555 618">0220042</td> <td data-bbox="555 535 1434 618">documentation sonstiges/unbekannt</td> </tr> </tbody> </table>	Kind	Value	Annotation	enumeration	0220001	documentation anterior	enumeration	0220002	documentation anterolateral	enumeration	0220003	documentation lateral	enumeration	0220004	documentation posterior	enumeration	0220005	documentation posterolateral	enumeration	0220006	documentation 2-Inzisionen-Zugang	enumeration	0220042	documentation sonstiges/unbekannt
Kind	Value	Annotation																							
enumeration	0220001	documentation anterior																							
enumeration	0220002	documentation anterolateral																							
enumeration	0220003	documentation lateral																							
enumeration	0220004	documentation posterior																							
enumeration	0220005	documentation posterolateral																							
enumeration	0220006	documentation 2-Inzisionen-Zugang																							
enumeration	0220042	documentation sonstiges/unbekannt																							
annotation	documentation Kat_EP_Operationszugang																								
source	<pre data-bbox="280 689 1139 1995"> &lt;simpleType name="enum_0220"&gt;   &lt;annotation&gt;     &lt;documentation&gt;Kat_EP_Operationszugang&lt;/documentation&gt;   &lt;/annotation&gt;   &lt;restriction base="xs:string"&gt;     &lt;enumeration value="0220001"&gt;       &lt;annotation&gt;         &lt;documentation&gt;anterior&lt;/documentation&gt;       &lt;/annotation&gt;     &lt;/enumeration&gt;     &lt;enumeration value="0220002"&gt;       &lt;annotation&gt;         &lt;documentation&gt;anterolateral&lt;/documentation&gt;       &lt;/annotation&gt;     &lt;/enumeration&gt;     &lt;enumeration value="0220003"&gt;       &lt;annotation&gt;         &lt;documentation&gt;lateral&lt;/documentation&gt;       &lt;/annotation&gt;     &lt;/enumeration&gt;     &lt;enumeration value="0220004"&gt;       &lt;annotation&gt;         &lt;documentation&gt;posterior&lt;/documentation&gt;       &lt;/annotation&gt;     &lt;/enumeration&gt;     &lt;enumeration value="0220005"&gt;       &lt;annotation&gt;         &lt;documentation&gt;posterolateral&lt;/documentation&gt;       &lt;/annotation&gt;     &lt;/enumeration&gt;     &lt;enumeration value="0220006"&gt;       &lt;annotation&gt;         &lt;documentation&gt;2-Inzisionen-Zugang&lt;/documentation&gt;       &lt;/annotation&gt;     &lt;/enumeration&gt;     &lt;enumeration value="0220042"&gt;       &lt;annotation&gt;         &lt;documentation&gt;sonstiges/unbekannt&lt;/documentation&gt;       &lt;/annotation&gt;     &lt;/enumeration&gt;   &lt;/restriction&gt; &lt;/simpleType&gt; </pre>																								



### simpleType enum\_0222

namespace	http://xml.ir-d.de/emg		
type	restriction of <b>string</b>		
properties	base xs:string		
used by	element <a href="#">OperationEndoprotheseBasis/OEP_ZweizeitwechselSchluessel</a>		
facets	Kind	Value	Annotation
	enumeration	0222001	documentation nein
	enumeration	0222002	documentation ja- Ausbau
	enumeration	0222003	documentation ja- Einbau
annotation	documentation Kat_EP_Zweizeitwechsel		
source	<pre> &lt;simpleType name="enum_0222"&gt;   &lt;annotation&gt;     &lt;documentation&gt;Kat_EP_Zweizeitwechsel&lt;/documentation&gt;   &lt;/annotation&gt;   &lt;restriction base="xs:string"&gt;     &lt;enumeration value="0222001"&gt;       &lt;annotation&gt;         &lt;documentation&gt;nein&lt;/documentation&gt;       &lt;/annotation&gt;     &lt;/enumeration&gt;     &lt;enumeration value="0222002"&gt;       &lt;annotation&gt;         &lt;documentation&gt;ja- Ausbau&lt;/documentation&gt;       &lt;/annotation&gt;     &lt;/enumeration&gt;     &lt;enumeration value="0222003"&gt;       &lt;annotation&gt;         &lt;documentation&gt;ja- Einbau&lt;/documentation&gt;       &lt;/annotation&gt;     &lt;/enumeration&gt;   &lt;/restriction&gt; &lt;/simpleType&gt; </pre>		

### simpleType enum\_0230

namespace	http://xml.ir-d.de/emg		
type	restriction of <b>string</b>		
properties	base xs:string		
used by	elements <a href="#">ArtikelEndoprotheseBasis/AEP_HerstellerSchluessel</a> <a href="#">ZubehoerEndoprotheseBasis/ZEP_HerstellerSchluessel</a>		
facets	Kind	Value	Annotation
	enumeration	0230001	documentation Smith & Nephew GmbH
	enumeration	0230002	documentation Mathys Orthopädie GmbH
	enumeration	0230003	documentation Ceramtec AG
	enumeration	0230004	documentation Biomet
	enumeration	0230005	documentation

	enumeration	0230006	Peter Brehm GmbH documentation
	enumeration	0230007	Amplitude GmbH documentation
	enumeration	0230008	Exactech Deutschland documentation
	enumeration	0230009	Globus Medical documentation
	enumeration	0230010	Implantcast GmbH documentation
	enumeration	0230011	DePuy Orthopädie GmbH (J&J) documentation
	enumeration	0230012	IO-International Orthopaedics documentation
	enumeration	0230013	Joint Replacement Ltd. Instrumentation documentation
	enumeration	0230014	Merete documentation
	enumeration	0230015	S&G Implants GmbH documentation
	enumeration	0230016	Speetec Implantate GmbH documentation
	enumeration	0230017	Stemcup Medical Products GmbH documentation
	enumeration	0230018	Symbios Deutschland GmbH documentation
	enumeration	0230019	Tantum AG documentation
	enumeration	0230020	Tomier GmbH documentation
	enumeration	0230021	MicroPort Orthopedics GmbH documentation
	enumeration	0230022	aap Implanate AG documentation
	enumeration	0230023	AQImplants documentation
	enumeration	0230024	ESKA Orthodynamics GmbH documentation
	enumeration	0230025	Atesos medical AG documentation
	enumeration	0230026	Chiropro GmbH documentation
	enumeration	0230027	Medacta documentation
	enumeration	0230028	OHST Medizintechnik AG documentation
	enumeration	0230029	Lima Deutschland GmbH documentation
	enumeration	0230030	alloPlus GmbH documentation
	enumeration	0230031	Heraeus Medical GmbH documentation
	enumeration	0230032	ImplanTec Deutschland GmbH documentation
	enumeration	0230033	Falcon Medical GmbH documentation
	enumeration	0230034	Meril GmbH documentation
	enumeration	0230035	Zimmer Germany GmbH documentation
	enumeration	0230036	Stryker GmbH & Co. KG documentation
	enumeration	0230037	Aesculap AG documentation
			Waldemar Link GmbH & Co. KG

	<p>enumeration 0230038 documentation Corin Germany GmbH</p> <p>enumeration 0230039 documentation ARTIQO</p> <p>enumeration 0230040 documentation EuromedImplants</p> <p>enumeration 0230041 documentation EvolutisGroup</p> <p>enumeration 0230042 documentation sonstige</p> <p>enumeration 0230043 documentation TEKNIMED SAS</p> <p>enumeration 0230044 documentation HiPer Medical AG</p> <p>enumeration 0230045 documentation Link Italia S.p.A.</p> <p>enumeration 0230046 documentation Johnson &amp; Johnson Medical GmbH</p> <p>enumeration 0230047 documentation MatOrtho Limited</p> <p>enumeration 0230048 documentation Adler Ortho S.P.A.</p> <p>enumeration 0230049 documentation Lincotek Bologna SRL</p> <p>enumeration 0230050 documentation Materialise</p> <p>enumeration 0230051 documentation Maxx Orthopedics Inc.</p> <p>enumeration 0230052 documentation JRI Orthopaedics</p> <p>enumeration 0230053 documentation nicht belegter Wert</p> <p>enumeration 0230054 documentation nicht belegter Wert</p> <p>enumeration 0230055 documentation nicht belegter Wert</p> <p>enumeration 0230056 documentation nicht belegter Wert</p> <p>enumeration 0230057 documentation nicht belegter Wert</p> <p>enumeration 0230058 documentation nicht belegter Wert</p> <p>enumeration 0230059 documentation nicht belegter Wert</p>
annotation	documentation Kat_EP_Hersteller
source	<pre> &lt;simpleType name="enum_0230"&gt;   &lt;annotation&gt;     &lt;documentation&gt;Kat_EP_Hersteller&lt;/documentation&gt;   &lt;/annotation&gt;   &lt;restriction base="xs:string"&gt;     &lt;enumeration value="0230001"&gt;       &lt;annotation&gt;         &lt;documentation&gt;Smith &amp; Nephew GmbH&lt;/documentation&gt;       &lt;/annotation&gt;     &lt;/enumeration&gt;     &lt;enumeration value="0230002"&gt;       &lt;annotation&gt;         &lt;documentation&gt;Mathys Orthopädie GmbH&lt;/documentation&gt;       &lt;/annotation&gt;     &lt;/enumeration&gt;     &lt;enumeration value="0230003"&gt;       &lt;annotation&gt; </pre>

```
<documentation>Ceramtec AG</documentation>
</annotation>
</enumeration>
<enumeration value="0230004">
  <annotation>
    <documentation>Biomet</documentation>
  </annotation>
</enumeration>
<enumeration value="0230005">
  <annotation>
    <documentation>Peter Brehm GmbH</documentation>
  </annotation>
</enumeration>
<enumeration value="0230006">
  <annotation>
    <documentation>Amplitude GmbH</documentation>
  </annotation>
</enumeration>
<enumeration value="0230007">
  <annotation>
    <documentation>Exactech Deutschland</documentation>
  </annotation>
</enumeration>
<enumeration value="0230008">
  <annotation>
    <documentation>Globus Medical</documentation>
  </annotation>
</enumeration>
<enumeration value="0230009">
  <annotation>
    <documentation>Implantcast GmbH</documentation>
  </annotation>
</enumeration>
<enumeration value="0230010">
  <annotation>
    <documentation>DePuy Orthopädie GmbH (J&J)</documentation>
  </annotation>
</enumeration>
<enumeration value="0230011">
  <annotation>
    <documentation>IO-International Orthopaedics</documentation>
  </annotation>
</enumeration>
<enumeration value="0230012">
  <annotation>
    <documentation>Joint Replacement Ltd. Instrumentation</documentation>
  </annotation>
</enumeration>
<enumeration value="0230013">
  <annotation>
    <documentation>Merete</documentation>
  </annotation>
</enumeration>
<enumeration value="0230014">
  <annotation>
    <documentation>S&G Implants GmbH</documentation>
  </annotation>
</enumeration>
<enumeration value="0230015">
```

```
<annotation>
  <documentation>Speetec Implantate GmbH</documentation>
</annotation>
</enumeration>
<enumeration value="0230016">
  <annotation>
    <documentation>Stemcup Medical Products GmbH</documentation>
  </annotation>
</enumeration>
<enumeration value="0230017">
  <annotation>
    <documentation>Symbios Deutschland GmbH</documentation>
  </annotation>
</enumeration>
<enumeration value="0230018">
  <annotation>
    <documentation>Tantum AG</documentation>
  </annotation>
</enumeration>
<enumeration value="0230019">
  <annotation>
    <documentation>Tornier GmbH</documentation>
  </annotation>
</enumeration>
<enumeration value="0230020">
  <annotation>
    <documentation>MicroPort Orthopedics GmbH</documentation>
  </annotation>
</enumeration>
<enumeration value="0230021">
  <annotation>
    <documentation>aap Implanate AG</documentation>
  </annotation>
</enumeration>
<enumeration value="0230022">
  <annotation>
    <documentation>AQImplants</documentation>
  </annotation>
</enumeration>
<enumeration value="0230023">
  <annotation>
    <documentation>ESKA Orthodynamics GmbH</documentation>
  </annotation>
</enumeration>
<enumeration value="0230024">
  <annotation>
    <documentation>Ateos medical AG</documentation>
  </annotation>
</enumeration>
<enumeration value="0230025">
  <annotation>
    <documentation>Chiropro GmbH</documentation>
  </annotation>
</enumeration>
<enumeration value="0230026">
  <annotation>
    <documentation>Medacta</documentation>
  </annotation>
</enumeration>
```

```
<enumeration value="0230027">
  <annotation>
    <documentation>OHST Medizintechnik AG</documentation>
  </annotation>
</enumeration>
<enumeration value="0230028">
  <annotation>
    <documentation>Lima Deutschland GmbH</documentation>
  </annotation>
</enumeration>
<enumeration value="0230029">
  <annotation>
    <documentation>alloPlus GmbH</documentation>
  </annotation>
</enumeration>
<enumeration value="0230030">
  <annotation>
    <documentation>Heraeus Medical GmbH</documentation>
  </annotation>
</enumeration>
<enumeration value="0230031">
  <annotation>
    <documentation>ImplanTec Deutschland GmbH</documentation>
  </annotation>
</enumeration>
<enumeration value="0230032">
  <annotation>
    <documentation>Falcon Medical GmbH</documentation>
  </annotation>
</enumeration>
<enumeration value="0230033">
  <annotation>
    <documentation>Meril GmbH</documentation>
  </annotation>
</enumeration>
<enumeration value="0230034">
  <annotation>
    <documentation>Zimmer Germany GmbH</documentation>
  </annotation>
</enumeration>
<enumeration value="0230035">
  <annotation>
    <documentation>Stryker GmbH & Co. KG</documentation>
  </annotation>
</enumeration>
<enumeration value="0230036">
  <annotation>
    <documentation>Aesculap AG</documentation>
  </annotation>
</enumeration>
<enumeration value="0230037">
  <annotation>
    <documentation>Waldemar Link GmbH & Co. KG</documentation>
  </annotation>
</enumeration>
<enumeration value="0230038">
  <annotation>
    <documentation>Corin Germany GmbH</documentation>
  </annotation>
</enumeration>
```

```
</enumeration>
<enumeration value="0230039">
  <annotation>
    <documentation>ARTIQO</documentation>
  </annotation>
</enumeration>
<enumeration value="0230040">
  <annotation>
    <documentation>EuromedImplants</documentation>
  </annotation>
</enumeration>
<enumeration value="0230041">
  <annotation>
    <documentation>EvolutisGroup</documentation>
  </annotation>
</enumeration>
<enumeration value="0230042">
  <annotation>
    <documentation>sonstige</documentation>
  </annotation>
</enumeration>
<enumeration value="0230043">
  <annotation>
    <documentation>TEKNIMED SAS</documentation>
  </annotation>
</enumeration>
<enumeration value="0230044">
  <annotation>
    <documentation>HiPer Medical AG</documentation>
  </annotation>
</enumeration>
<enumeration value="0230045">
  <annotation>
    <documentation>Link Italia S.p.A.</documentation>
  </annotation>
</enumeration>
<enumeration value="0230046">
  <annotation>
    <documentation>Johnson & Johnson Medical GmbH</documentation>
  </annotation>
</enumeration>
<enumeration value="0230047">
  <annotation>
    <documentation>MatOrtho Limited</documentation>
  </annotation>
</enumeration>
<enumeration value="0230048">
  <annotation>
    <documentation>Adler Ortho S.P.A.</documentation>
  </annotation>
</enumeration>
<enumeration value="0230049">
  <annotation>
    <documentation>Lincotek Bologna SRL</documentation>
  </annotation>
</enumeration>
<enumeration value="0230050">
  <annotation>
    <documentation>Materialise</documentation>
  </annotation>
</enumeration>
```

```

</annotation>
</enumeration>
<enumeration value="0230051">
  <annotation>
    <documentation>Maxx Orthopedics Inc.</documentation>
  </annotation>
</enumeration>
<enumeration value="0230052">
  <annotation>
    <documentation>JRI Orthopaedics</documentation>
  </annotation>
</enumeration>
<enumeration value="0230053">
  <annotation>
    <documentation>nicht belegter Wert</documentation>
  </annotation>
</enumeration>
<enumeration value="0230054">
  <annotation>
    <documentation>nicht belegter Wert</documentation>
  </annotation>
</enumeration>
<enumeration value="0230055">
  <annotation>
    <documentation>nicht belegter Wert</documentation>
  </annotation>
</enumeration>
<enumeration value="0230056">
  <annotation>
    <documentation>nicht belegter Wert</documentation>
  </annotation>
</enumeration>
<enumeration value="0230057">
  <annotation>
    <documentation>nicht belegter Wert</documentation>
  </annotation>
</enumeration>
<enumeration value="0230058">
  <annotation>
    <documentation>nicht belegter Wert</documentation>
  </annotation>
</enumeration>
<enumeration value="0230059">
  <annotation>
    <documentation>nicht belegter Wert</documentation>
  </annotation>
</enumeration>
</restriction>
</simpleType>

```

#### simpleType enum\_0252

namespace	http://xml.ir-d.de/emg
type	restriction of <b>string</b>
properties	base xs:string
used by	element <a href="#">OperationEndoprotheseBasis/OEP KomponenteHuefteSchluessel</a>



facets	<table border="1"> <thead> <tr> <th>Kind</th> <th>Value</th> <th>Annotation</th> </tr> </thead> <tbody> <tr> <td>enumeration</td> <td>0252001</td> <td>documentation Pfanne</td> </tr> <tr> <td>enumeration</td> <td>0252002</td> <td>documentation Schaft</td> </tr> <tr> <td>enumeration</td> <td>0252003</td> <td>documentation beides</td> </tr> </tbody> </table>	Kind	Value	Annotation	enumeration	0252001	documentation Pfanne	enumeration	0252002	documentation Schaft	enumeration	0252003	documentation beides
Kind	Value	Annotation											
enumeration	0252001	documentation Pfanne											
enumeration	0252002	documentation Schaft											
enumeration	0252003	documentation beides											
annotation	documentation Kat_EP_KomponenteHuefte												
source	<pre> &lt;simpleType name="enum_0252"&gt;   &lt;annotation&gt;     &lt;documentation&gt;Kat_EP_KomponenteHuefte&lt;/documentation&gt;   &lt;/annotation&gt;   &lt;restriction base="xs:string"&gt;     &lt;enumeration value="0252001"&gt;       &lt;annotation&gt;         &lt;documentation&gt;Pfanne&lt;/documentation&gt;       &lt;/annotation&gt;     &lt;/enumeration&gt;     &lt;enumeration value="0252002"&gt;       &lt;annotation&gt;         &lt;documentation&gt;Schaft&lt;/documentation&gt;       &lt;/annotation&gt;     &lt;/enumeration&gt;     &lt;enumeration value="0252003"&gt;       &lt;annotation&gt;         &lt;documentation&gt;beides&lt;/documentation&gt;       &lt;/annotation&gt;     &lt;/enumeration&gt;   &lt;/restriction&gt; &lt;/simpleType&gt; </pre>												

### simpleType enum\_0254

namespace	http://xml.ir-d.de/emg															
type	restriction of <b>string</b>															
properties	base xs:string															
used by	element <a href="#">OperationEndoprotheseBasis/OEP KomponenteKnieSchluessel</a>															
facets	<table border="1"> <thead> <tr> <th>Kind</th> <th>Value</th> <th>Annotation</th> </tr> </thead> <tbody> <tr> <td>enumeration</td> <td>0254001</td> <td>documentation Femur</td> </tr> <tr> <td>enumeration</td> <td>0254002</td> <td>documentation Tibia</td> </tr> <tr> <td>enumeration</td> <td>0254003</td> <td>documentation Patella</td> </tr> <tr> <td>enumeration</td> <td>0254004</td> <td>documentation mehrere</td> </tr> </tbody> </table>	Kind	Value	Annotation	enumeration	0254001	documentation Femur	enumeration	0254002	documentation Tibia	enumeration	0254003	documentation Patella	enumeration	0254004	documentation mehrere
Kind	Value	Annotation														
enumeration	0254001	documentation Femur														
enumeration	0254002	documentation Tibia														
enumeration	0254003	documentation Patella														
enumeration	0254004	documentation mehrere														
annotation	documentation Kat_EP_KomponenteKnie															
source	<pre> &lt;simpleType name="enum_0254"&gt;   &lt;annotation&gt;     &lt;documentation&gt;Kat_EP_KomponenteKnie&lt;/documentation&gt;   &lt;/annotation&gt;   &lt;restriction base="xs:string"&gt;     &lt;enumeration value="0254001"&gt;       &lt;annotation&gt;         &lt;documentation&gt;Femur&lt;/documentation&gt;       &lt;/annotation&gt;     &lt;/enumeration&gt;   &lt;/restriction&gt; &lt;/simpleType&gt; </pre>															

	<pre> &lt;/annotation&gt; &lt;/enumeration&gt; &lt;enumeration value="0254002"&gt;   &lt;annotation&gt;     &lt;documentation&gt;Tibia&lt;/documentation&gt;   &lt;/annotation&gt; &lt;/enumeration&gt; &lt;enumeration value="0254003"&gt;   &lt;annotation&gt;     &lt;documentation&gt;Patella&lt;/documentation&gt;   &lt;/annotation&gt; &lt;/enumeration&gt; &lt;enumeration value="0254004"&gt;   &lt;annotation&gt;     &lt;documentation&gt;mehrere&lt;/documentation&gt;   &lt;/annotation&gt; &lt;/enumeration&gt; &lt;/restriction&gt; &lt;/simpleType&gt; </pre>
--	---

### simpleType enum 0256

namespace	http://xml.ir-d.de/emg		
type	restriction of <b>string</b>		
properties	base xs:string		
used by	element <a href="#">OperationEndoprotheseBasis/OEP KomponenteTFeSchlüssel</a>		
facets	Kind	Value	Annotation
	enumeration	0256001	documentation Pfanne
	enumeration	0256002	documentation Schaft
	enumeration	0256003	documentation Pfanne und Schaft
	enumeration	0256004	documentation Femur
	enumeration	0256005	documentation Tibia
	enumeration	0256006	documentation Patella
	enumeration	0256007	documentation mehrere
annotation	documentation Kat_EP_KomponenteTFE		
source	<pre> &lt;simpleType name="enum_0256"&gt;   &lt;annotation&gt;     &lt;documentation&gt;Kat_EP_KomponenteTFE&lt;/documentation&gt;   &lt;/annotation&gt;   &lt;restriction base="xs:string"&gt;     &lt;enumeration value="0256001"&gt;       &lt;annotation&gt;         &lt;documentation&gt;Pfanne&lt;/documentation&gt;       &lt;/annotation&gt;     &lt;/enumeration&gt;     &lt;enumeration value="0256002"&gt;       &lt;annotation&gt;         &lt;documentation&gt;Schaft&lt;/documentation&gt;       &lt;/annotation&gt;     &lt;/enumeration&gt;   &lt;/restriction&gt; &lt;/simpleType&gt; </pre>		

	<pre> &lt;/enumeration&gt; &lt;enumeration value="0256003"&gt;   &lt;annotation&gt;     &lt;documentation&gt;Pfanne und Schaft&lt;/documentation&gt;   &lt;/annotation&gt; &lt;/enumeration&gt; &lt;enumeration value="0256004"&gt;   &lt;annotation&gt;     &lt;documentation&gt;Femur&lt;/documentation&gt;   &lt;/annotation&gt; &lt;/enumeration&gt; &lt;enumeration value="0256005"&gt;   &lt;annotation&gt;     &lt;documentation&gt;Tibia&lt;/documentation&gt;   &lt;/annotation&gt; &lt;/enumeration&gt; &lt;enumeration value="0256006"&gt;   &lt;annotation&gt;     &lt;documentation&gt;Patella&lt;/documentation&gt;   &lt;/annotation&gt; &lt;/enumeration&gt; &lt;enumeration value="0256007"&gt;   &lt;annotation&gt;     &lt;documentation&gt;mehrere&lt;/documentation&gt;   &lt;/annotation&gt; &lt;/enumeration&gt; &lt;/restriction&gt; &lt;/simpleType&gt; </pre>
--	---

### simpleType enum\_0262

namespace	http://xml.ir-d.de/emg		
type	restriction of <b>string</b>		
properties	base xs:string		
used by	element <a href="#">OperationEndoprotheseBasis/OEP ImplantatbruchHuefteSchluessel</a>		
facets	Kind	Value	Annotation
	enumeration	0262001	documentation Pfanne
	enumeration	0262002	documentation Schaft
	enumeration	0262003	documentation Kopf
	enumeration	0262004	documentation Inlay
	enumeration	0262005	documentation Adapter
	enumeration	0262006	documentation mehrere
annotation	documentation Kat_EP_ImplantatbruchHuefte		
source	<pre> &lt;simpleType name="enum_0262"&gt;   &lt;annotation&gt;     &lt;documentation&gt;Kat_EP_ImplantatbruchHuefte&lt;/documentation&gt;   &lt;/annotation&gt;   &lt;restriction base="xs:string"&gt;     &lt;enumeration value="0262001"&gt;       &lt;annotation&gt; </pre>		

```

    <documentation>Pfanne</documentation>
  </annotation>
</enumeration>
<enumeration value="0262002">
  <annotation>
    <documentation>Schaft</documentation>
  </annotation>
</enumeration>
<enumeration value="0262003">
  <annotation>
    <documentation>Kopf</documentation>
  </annotation>
</enumeration>
<enumeration value="0262004">
  <annotation>
    <documentation>Inlay</documentation>
  </annotation>
</enumeration>
<enumeration value="0262005">
  <annotation>
    <documentation>Adapter</documentation>
  </annotation>
</enumeration>
<enumeration value="0262006">
  <annotation>
    <documentation>mehrere</documentation>
  </annotation>
</enumeration>
</restriction>
</simpleType>

```

simpleType enum\_0264

namespace	http://xml.ir-d.de/emg		
type	restriction of <b>string</b>		
properties	base xs:string		
used by	element <a href="#">OperationEndoprotheseBasis/OEP ImplantatbruchKnieSchluessel</a>		
facets	Kind	Value	Annotation
	enumeration	0264001	documentation Femur
	enumeration	0264002	documentation Tibia
	enumeration	0264003	documentation Inlay
	enumeration	0264004	documentation Adapter
	enumeration	0264005	documentation Verlängerung
	enumeration	0264006	documentation Schrauben
	enumeration	0264007	documentation mehrere
	enumeration	0264042	documentation andere
annotation	documentation Kat_EP_ImplantatbruchKnie		
source	<simpleType name="enum_0264">		

```

<annotation>
  <documentation>Kat_EP_ImplantatbruchKnie</documentation>
</annotation>
<restriction base="xs:string">
  <enumeration value="0264001">
    <annotation>
      <documentation>Femur</documentation>
    </annotation>
  </enumeration>
  <enumeration value="0264002">
    <annotation>
      <documentation>Tibia</documentation>
    </annotation>
  </enumeration>
  <enumeration value="0264003">
    <annotation>
      <documentation>Inlay</documentation>
    </annotation>
  </enumeration>
  <enumeration value="0264004">
    <annotation>
      <documentation>Adapter</documentation>
    </annotation>
  </enumeration>
  <enumeration value="0264005">
    <annotation>
      <documentation>Verlängerung</documentation>
    </annotation>
  </enumeration>
  <enumeration value="0264006">
    <annotation>
      <documentation>Schrauben</documentation>
    </annotation>
  </enumeration>
  <enumeration value="0264007">
    <annotation>
      <documentation>mehrere</documentation>
    </annotation>
  </enumeration>
  <enumeration value="0264042">
    <annotation>
      <documentation>andere</documentation>
    </annotation>
  </enumeration>
</restriction>
</simpleType>

```

### simpleType enum\_0266

namespace	http://xml.ir-d.de/emg		
type	restriction of <b>string</b>		
properties	base xs:string		
used by	element	<a href="#">OperationEndoprotheseBasis/OEP_ImplantatbruchTfeSchlüssel</a>	
facets	Kind	Value	Annotation
	enumeration	0266001	documentation Pfanne

	<p>enumeration 0266002 documentation Schaft</p> <p>enumeration 0266003 documentation Kopf</p> <p>enumeration 0266004 documentation Inlay</p> <p>enumeration 0266005 documentation Adapter</p> <p>enumeration 0266006 documentation Femur</p> <p>enumeration 0266007 documentation Tibia</p> <p>enumeration 0266008 documentation Verlängerung</p> <p>enumeration 0266009 documentation Schrauben</p> <p>enumeration 0266010 documentation mehrere</p> <p>enumeration 0266042 documentation andere</p>
annotation	documentation Kat_EP_ImplantatbruchTFE
source	<pre> &lt;simpleType name="enum_0266"&gt;   &lt;annotation&gt;     &lt;documentation&gt;Kat_EP_ImplantatbruchTFE&lt;/documentation&gt;   &lt;/annotation&gt;   &lt;restriction base="xs:string"&gt;     &lt;enumeration value="0266001"&gt;       &lt;annotation&gt;         &lt;documentation&gt;Pfanne&lt;/documentation&gt;       &lt;/annotation&gt;     &lt;/enumeration&gt;     &lt;enumeration value="0266002"&gt;       &lt;annotation&gt;         &lt;documentation&gt;Schaft&lt;/documentation&gt;       &lt;/annotation&gt;     &lt;/enumeration&gt;     &lt;enumeration value="0266003"&gt;       &lt;annotation&gt;         &lt;documentation&gt;Kopf&lt;/documentation&gt;       &lt;/annotation&gt;     &lt;/enumeration&gt;     &lt;enumeration value="0266004"&gt;       &lt;annotation&gt;         &lt;documentation&gt;Inlay&lt;/documentation&gt;       &lt;/annotation&gt;     &lt;/enumeration&gt;     &lt;enumeration value="0266005"&gt;       &lt;annotation&gt;         &lt;documentation&gt;Adapter&lt;/documentation&gt;       &lt;/annotation&gt;     &lt;/enumeration&gt;     &lt;enumeration value="0266006"&gt;       &lt;annotation&gt;         &lt;documentation&gt;Femur&lt;/documentation&gt;       &lt;/annotation&gt;     &lt;/enumeration&gt;     &lt;enumeration value="0266007"&gt;       &lt;annotation&gt;         &lt;documentation&gt;Tibia&lt;/documentation&gt;       &lt;/annotation&gt;     &lt;/enumeration&gt;   &lt;/restriction&gt; &lt;/simpleType&gt; </pre>

```

</enumeration>
<enumeration value="0266008">
  <annotation>
    <documentation>Verlängerung</documentation>
  </annotation>
</enumeration>
<enumeration value="0266009">
  <annotation>
    <documentation>Schrauben</documentation>
  </annotation>
</enumeration>
<enumeration value="0266010">
  <annotation>
    <documentation>mehrere</documentation>
  </annotation>
</enumeration>
<enumeration value="0266042">
  <annotation>
    <documentation>andere</documentation>
  </annotation>
</enumeration>
</restriction>
</simpleType>

```

simpleType **enum\_0270**

namespace	http://xml.ir-d.de/emg		
type	restriction of <b>string</b>		
properties	base xs:string		
used by	element <a href="#">OperationEndoprotheseBasis/OEP_VerschleissKnieSchluessel</a>		
facets	Kind	Value	Annotation
	enumeration	0270001	documentation PE-Inlay
	enumeration	0270002	documentation patellare Komponente
	enumeration	0270003	documentation beides
annotation	documentation Kat_EP_VerschleissKnie		
source	<pre> &lt;simpleType name="enum_0270"&gt;   &lt;annotation&gt;     &lt;documentation&gt;Kat_EP_VerschleissKnie&lt;/documentation&gt;   &lt;/annotation&gt;   &lt;restriction base="xs:string"&gt;     &lt;enumeration value="0270001"&gt;       &lt;annotation&gt;         &lt;documentation&gt;PE-Inlay&lt;/documentation&gt;       &lt;/annotation&gt;     &lt;/enumeration&gt;     &lt;enumeration value="0270002"&gt;       &lt;annotation&gt;         &lt;documentation&gt;patellare Komponente&lt;/documentation&gt;       &lt;/annotation&gt;     &lt;/enumeration&gt;     &lt;enumeration value="0270003"&gt;       &lt;annotation&gt; </pre>		

	<pre> &lt;documentation&gt;beides&lt;/documentation&gt; &lt;/annotation&gt; &lt;/enumeration&gt; &lt;/restriction&gt; &lt;/simpleType&gt; </pre>
--	--

### simpleType enum\_0271

namespace	http://xml.ir-d.de/emg		
type	restriction of <b>string</b>		
properties	base xs:string		
used by	element <a href="#">OperationEndprotheseBasis/OEP MigrationKnieSchluesel</a>		
facets	Kind	Value	Annotation
	enumeration	0271001	documentation Schraube
	enumeration	0271002	documentation Inlay
	enumeration	0271003	documentation patellare Komponente
	enumeration	0271004	documentation Kopplung
	enumeration	0271005	documentation mehrere
	enumeration	0271042	documentation andere
annotation	documentation Kat_EP_MigrationKnie		
source	<pre> &lt;simpleType name="enum_0271"&gt;   &lt;annotation&gt;     &lt;documentation&gt;Kat_EP_MigrationKnie&lt;/documentation&gt;   &lt;/annotation&gt;   &lt;restriction base="xs:string"&gt;     &lt;enumeration value="0271001"&gt;       &lt;annotation&gt;         &lt;documentation&gt;Schraube&lt;/documentation&gt;       &lt;/annotation&gt;     &lt;/enumeration&gt;     &lt;enumeration value="0271002"&gt;       &lt;annotation&gt;         &lt;documentation&gt;Inlay&lt;/documentation&gt;       &lt;/annotation&gt;     &lt;/enumeration&gt;     &lt;enumeration value="0271003"&gt;       &lt;annotation&gt;         &lt;documentation&gt;patellare Komponente&lt;/documentation&gt;       &lt;/annotation&gt;     &lt;/enumeration&gt;     &lt;enumeration value="0271004"&gt;       &lt;annotation&gt;         &lt;documentation&gt;Kopplung&lt;/documentation&gt;       &lt;/annotation&gt;     &lt;/enumeration&gt;     &lt;enumeration value="0271005"&gt;       &lt;annotation&gt;         &lt;documentation&gt;mehrere&lt;/documentation&gt;       &lt;/annotation&gt;     &lt;/enumeration&gt;   &lt;/restriction&gt; &lt;/simpleType&gt; </pre>		



	<pre> &lt;enumeration value="0271042"&gt;   &lt;annotation&gt;     &lt;documentation&gt;andere&lt;/documentation&gt;   &lt;/annotation&gt; &lt;/enumeration&gt; &lt;/restriction&gt; &lt;/simpleType&gt; </pre>
--	---

### simpleType enum\_0290

namespace	http://xml.ir-d.de/emg		
type	restriction of <b>string</b>		
properties	base xs:string		
used by	element <a href="#">ArtikelEndoprotheseBasis/AEP ArtikelTypSchluessel</a>		
facets	Kind	Value	Annotation
	enumeration	0290001	documentation Hüft-Komponente
	enumeration	0290002	documentation Knie-Komponente
	enumeration	0290003	documentation Modulare Komponente (Hüfte/Knie)
annotation	documentation Kat_EP_Artikeltyp		
source	<pre> &lt;simpleType name="enum_0290"&gt;   &lt;annotation&gt;     &lt;documentation&gt;Kat_EP_Artikeltyp&lt;/documentation&gt;   &lt;/annotation&gt;   &lt;restriction base="xs:string"&gt;     &lt;enumeration value="0290001"&gt;       &lt;annotation&gt;         &lt;documentation&gt;Hüft-Komponente&lt;/documentation&gt;       &lt;/annotation&gt;     &lt;/enumeration&gt;     &lt;enumeration value="0290002"&gt;       &lt;annotation&gt;         &lt;documentation&gt;Knie-Komponente&lt;/documentation&gt;       &lt;/annotation&gt;     &lt;/enumeration&gt;     &lt;enumeration value="0290003"&gt;       &lt;annotation&gt;         &lt;documentation&gt;Modulare Komponente (Hüfte/Knie)&lt;/documentation&gt;       &lt;/annotation&gt;     &lt;/enumeration&gt;   &lt;/restriction&gt; &lt;/simpleType&gt; </pre>		

### simpleType enum\_0291

namespace	http://xml.ir-d.de/emg		
type	restriction of <b>string</b>		
properties	base xs:string		
used by	element <a href="#">ZubehoerEndoprotheseBasis/ZEP ZubehoerTypSchluessel</a>		

facets	<table border="1"> <thead> <tr> <th>Kind</th> <th>Value</th> <th>Annotation</th> </tr> </thead> <tbody> <tr> <td>enumeration</td> <td>0291001</td> <td>documentation Knochen-Zement</td> </tr> <tr> <td>enumeration</td> <td>0291002</td> <td>documentation sonstiges Zubehör</td> </tr> </tbody> </table>	Kind	Value	Annotation	enumeration	0291001	documentation Knochen-Zement	enumeration	0291002	documentation sonstiges Zubehör
Kind	Value	Annotation								
enumeration	0291001	documentation Knochen-Zement								
enumeration	0291002	documentation sonstiges Zubehör								
annotation	documentation Kat_EP_ZubehoerTyp									
source	<pre>&lt;simpleType name="enum_0291"&gt;   &lt;annotation&gt;     &lt;documentation&gt;Kat_EP_ZubehoerTyp&lt;/documentation&gt;   &lt;/annotation&gt;   &lt;restriction base="xs:string"&gt;     &lt;enumeration value="0291001"&gt;       &lt;annotation&gt;         &lt;documentation&gt;Knochen-Zement&lt;/documentation&gt;       &lt;/annotation&gt;     &lt;/enumeration&gt;     &lt;enumeration value="0291002"&gt;       &lt;annotation&gt;         &lt;documentation&gt;sonstiges Zubehör&lt;/documentation&gt;       &lt;/annotation&gt;     &lt;/enumeration&gt;   &lt;/restriction&gt; &lt;/simpleType&gt;</pre>									

### simpleType enum\_0300

namespace	http://xml.ir-d.de/emg									
type	restriction of <b>string</b>									
properties	base xs:string									
used by	element <a href="#">OperationAortenklappeBasis/OAK ArtEingriffSchluessel</a>									
facets	<table border="1"> <thead> <tr> <th>Kind</th> <th>Value</th> <th>Annotation</th> </tr> </thead> <tbody> <tr> <td>enumeration</td> <td>0300001</td> <td>documentation konventioneller Aortenklappenersatz</td> </tr> <tr> <td>enumeration</td> <td>0300002</td> <td>documentation kathetergestützte Aortenklappenimplantation (TAVI)</td> </tr> </tbody> </table>	Kind	Value	Annotation	enumeration	0300001	documentation konventioneller Aortenklappenersatz	enumeration	0300002	documentation kathetergestützte Aortenklappenimplantation (TAVI)
Kind	Value	Annotation								
enumeration	0300001	documentation konventioneller Aortenklappenersatz								
enumeration	0300002	documentation kathetergestützte Aortenklappenimplantation (TAVI)								
annotation	documentation Kat_AK_ArtEingriff									
source	<pre>&lt;simpleType name="enum_0300"&gt;   &lt;annotation&gt;     &lt;documentation&gt;Kat_AK_ArtEingriff&lt;/documentation&gt;   &lt;/annotation&gt;   &lt;restriction base="xs:string"&gt;     &lt;enumeration value="0300001"&gt;       &lt;annotation&gt;         &lt;documentation&gt;konventioneller Aortenklappenersatz&lt;/documentation&gt;       &lt;/annotation&gt;     &lt;/enumeration&gt;     &lt;enumeration value="0300002"&gt;       &lt;annotation&gt;         &lt;documentation&gt;kathetergestützte Aortenklappenimplantation (TAVI)&lt;/documentation&gt;       &lt;/annotation&gt;     &lt;/enumeration&gt;   &lt;/restriction&gt; &lt;/simpleType&gt;</pre>									

### simpleType enum\_0302

namespace	http://xml.ir-d.de/emg		
type	restriction of <b>string</b>		
properties	base xs:string		
used by	element <a href="#">OperationAortenklappeBasis/OAK GrundEingriffSchluessel</a>		
facets	Kind	Value	Annotation
	enumeration	0302001	documentation Stenose
	enumeration	0302002	documentation Insuffizienz
	enumeration	0302003	documentation Stenose und Insuffizienz
annotation	documentation Kat_AK_GrundEingriff		
source	<pre> &lt;simpleType name="enum_0302"&gt;   &lt;annotation&gt;     &lt;documentation&gt;Kat_AK_GrundEingriff&lt;/documentation&gt;   &lt;/annotation&gt;   &lt;restriction base="xs:string"&gt;     &lt;enumeration value="0302001"&gt;       &lt;annotation&gt;         &lt;documentation&gt;Stenose&lt;/documentation&gt;       &lt;/annotation&gt;     &lt;/enumeration&gt;     &lt;enumeration value="0302002"&gt;       &lt;annotation&gt;         &lt;documentation&gt;Insuffizienz&lt;/documentation&gt;       &lt;/annotation&gt;     &lt;/enumeration&gt;     &lt;enumeration value="0302003"&gt;       &lt;annotation&gt;         &lt;documentation&gt;Stenose und Insuffizienz&lt;/documentation&gt;       &lt;/annotation&gt;     &lt;/enumeration&gt;   &lt;/restriction&gt; &lt;/simpleType&gt; </pre>		

### simpleType enum\_0318

namespace	http://xml.ir-d.de/emg		
type	restriction of <b>string</b>		
properties	base xs:string		
used by	element <a href="#">OperationAortenklappeBasis/OAK ZugangKatheterSchluessel</a>		
facets	Kind	Value	Annotation
	enumeration	0318001	documentation transapikal
	enumeration	0318002	documentation transaortal
	enumeration	0318003	documentation transfemoral
	enumeration	0318004	documentation transaxillär

	enumeration 0318042 documentation anderer Zugangsweg
annotation	documentation Kat_AK_ZugangKatheter
source	<pre> &lt;simpleType name="enum_0318"&gt;   &lt;annotation&gt;     &lt;documentation&gt;Kat_AK_ZugangKatheter&lt;/documentation&gt;   &lt;/annotation&gt;   &lt;restriction base="xs:string"&gt;     &lt;enumeration value="0318001"&gt;       &lt;annotation&gt;         &lt;documentation&gt;transapikal&lt;/documentation&gt;       &lt;/annotation&gt;     &lt;/enumeration&gt;     &lt;enumeration value="0318002"&gt;       &lt;annotation&gt;         &lt;documentation&gt;transaortal&lt;/documentation&gt;       &lt;/annotation&gt;     &lt;/enumeration&gt;     &lt;enumeration value="0318003"&gt;       &lt;annotation&gt;         &lt;documentation&gt;transfemoral&lt;/documentation&gt;       &lt;/annotation&gt;     &lt;/enumeration&gt;     &lt;enumeration value="0318004"&gt;       &lt;annotation&gt;         &lt;documentation&gt;transaxillär&lt;/documentation&gt;       &lt;/annotation&gt;     &lt;/enumeration&gt;     &lt;enumeration value="0318042"&gt;       &lt;annotation&gt;         &lt;documentation&gt;anderer Zugangsweg&lt;/documentation&gt;       &lt;/annotation&gt;     &lt;/enumeration&gt;   &lt;/restriction&gt; &lt;/simpleType&gt; </pre>

### simpleType enum 0320

namespace	http://xml.ir-d.de/emg		
type	restriction of <b>string</b>		
properties	base xs:string		
used by	element <a href="#">OperationAortenklappeBasis/OAK ZugangKonventionellSchluessel</a>		
facets	Kind	Value	Annotation
	enumeration	0320001	documentation konventionelle Sternotomie
	enumeration	0320002	documentation partielle Sternotomie
	enumeration	0320003	documentation parastemaler Zugang
	enumeration	0320042	documentation anderer Zugangsweg
annotation	documentation Kat_AK_ZugangKonventionell		
source	<pre> &lt;simpleType name="enum_0320"&gt;   &lt;annotation&gt; </pre>		

	<pre> &lt;documentation&gt;Kat_AK_ZugangKonventionell&lt;/documentation&gt; &lt;/annotation&gt; &lt;restriction base="xs:string"&gt;   &lt;enumeration value="032001"&gt;     &lt;annotation&gt;       &lt;documentation&gt;konventionelle Sternotomie&lt;/documentation&gt;     &lt;/annotation&gt;   &lt;/enumeration&gt;   &lt;enumeration value="032002"&gt;     &lt;annotation&gt;       &lt;documentation&gt;partielle Sternotomie&lt;/documentation&gt;     &lt;/annotation&gt;   &lt;/enumeration&gt;   &lt;enumeration value="032003"&gt;     &lt;annotation&gt;       &lt;documentation&gt;parasternaler Zugang&lt;/documentation&gt;     &lt;/annotation&gt;   &lt;/enumeration&gt;   &lt;enumeration value="032004"&gt;     &lt;annotation&gt;       &lt;documentation&gt;anderer Zugangsweg&lt;/documentation&gt;     &lt;/annotation&gt;   &lt;/enumeration&gt; &lt;/restriction&gt; &lt;/simpleType&gt; </pre>
--	---

### simpleType enum\_0322

namespace	http://xml.ir-d.de/emg		
type	restriction of <b>string</b>		
properties	base xs:string		
used by	element	<a href="#">PatientenaufnahmeKardiologieBasis/PKA_DiabetesSchluessel</a>	
facets	Kind	Value	Annotation
	enumeration	0322001	documentation nein
	enumeration	0322002	documentation ja, diätetisch behandelt
	enumeration	0322003	documentation ja, orale Medikation
	enumeration	0322004	documentation ja, mit Insulin behandelt
	enumeration	0322005	documentation ja, unbehandelt
	enumeration	0322099	documentation unbekannt
annotation	documentation Kat_AK_Diabetes		
source	<pre> &lt;simpleType name="enum_0322"&gt;   &lt;annotation&gt;     &lt;documentation&gt;Kat_AK_Diabetes&lt;/documentation&gt;   &lt;/annotation&gt;   &lt;restriction base="xs:string"&gt;     &lt;enumeration value="0322001"&gt;       &lt;annotation&gt;         &lt;documentation&gt;nein&lt;/documentation&gt;       &lt;/annotation&gt;     &lt;/enumeration&gt; </pre>		

	<pre> &lt;enumeration value="0322002"&gt;   &lt;annotation&gt;     &lt;documentation&gt;ja, diätetisch behandelt&lt;/documentation&gt;   &lt;/annotation&gt; &lt;/enumeration&gt; &lt;enumeration value="0322003"&gt;   &lt;annotation&gt;     &lt;documentation&gt;ja, orale Medikation&lt;/documentation&gt;   &lt;/annotation&gt; &lt;/enumeration&gt; &lt;enumeration value="0322004"&gt;   &lt;annotation&gt;     &lt;documentation&gt;ja, mit Insulin behandelt&lt;/documentation&gt;   &lt;/annotation&gt; &lt;/enumeration&gt; &lt;enumeration value="0322005"&gt;   &lt;annotation&gt;     &lt;documentation&gt;ja, unbehandelt&lt;/documentation&gt;   &lt;/annotation&gt; &lt;/enumeration&gt; &lt;enumeration value="0322099"&gt;   &lt;annotation&gt;     &lt;documentation&gt;unbekannt&lt;/documentation&gt;   &lt;/annotation&gt; &lt;/enumeration&gt; &lt;/restriction&gt; &lt;/simpleType&gt; </pre>
--	--

#### simpleType enum\_0324

namespace	http://xml.ir-d.de/emg		
type	restriction of <b>string</b>		
properties	base xs:string		
used by	element	<a href="#">PatientenaufnahmeKardiologieBasis/PKA_NyhaSchluessel</a>	
facets	Kind	Value	Annotation
	enumeration	0324001	documentation (I): Beschwerdefreiheit, normale körperliche Belastbarkeit
	enumeration	0324002	documentation (II): Beschwerden bei stärkerer körperlicher Belastung
	enumeration	0324003	documentation (III): Beschwerden bei leichter körperlicher Belastung
	enumeration	0324004	documentation (IV): Beschwerden in Ruhe
annotation	documentation	Kat_AK_NYHA	
source	<pre> &lt;simpleType name="enum_0324"&gt;   &lt;annotation&gt;     &lt;documentation&gt;Kat_AK_NYHA&lt;/documentation&gt;   &lt;/annotation&gt;   &lt;restriction base="xs:string"&gt;     &lt;enumeration value="0324001"&gt;       &lt;annotation&gt;         &lt;documentation&gt;(I): Beschwerdefreiheit, normale körperliche Belastbarkeit&lt;/documentation&gt;       &lt;/annotation&gt;     &lt;/enumeration&gt; </pre>		

```

<enumeration value="0324002">
  <annotation>
    <documentation>(II): Beschwerden bei starkerer korperlicher
Belastung</documentation>
  </annotation>
</enumeration>
<enumeration value="0324003">
  <annotation>
    <documentation>(III): Beschwerden bei leichter korperlicher
Belastung</documentation>
  </annotation>
</enumeration>
<enumeration value="0324004">
  <annotation>
    <documentation>(IV): Beschwerden in Ruhe</documentation>
  </annotation>
</enumeration>
</restriction>
</simpleType>

```

simpleType **enum\_0330**

namespace	http://xml.ir-d.de/emg		
type	restriction of <b>string</b>		
properties	base xs:string		
used by	element <a href="#">ArtikelAortenklappeBasis/AAK_HerstellerSchluessel</a>		
facets	Kind	Value	Annotation
	enumeration	0330001	documentation ATS Medical
	enumeration	0330002	documentation Edwards Lifesciences
	enumeration	0330003	documentation Medtronic
	enumeration	0330004	documentation JenaValve
	enumeration	0330005	documentation Corcym
	enumeration	0330006	documentation Abbott Medical / St. Jude
	enumeration	0330007	documentation Symetis
	enumeration	0330008	documentation Direct Flow Medical
	enumeration	0330009	documentation Boston Scientific
	enumeration	0330010	documentation Artivion
	enumeration	0330011	documentation Biosensors
	enumeration	0330012	documentation LivaNova
	enumeration	0330013	documentation Meril
	enumeration	0330014	documentation Sahajanand Medical Technologies
	enumeration	0330015	documentation nicht belegter Wert
	enumeration	0330016	documentation nicht belegter Wert

	<p>enumeration 0330017 documentation nicht belegter Wert</p> <p>enumeration 0330018 documentation nicht belegter Wert</p> <p>enumeration 0330042 documentation sonstiger Hersteller</p>
annotation	documentation Kat_AK_Hersteller
source	<pre> &lt;simpleType name="enum_0330"&gt;   &lt;annotation&gt;     &lt;documentation&gt;Kat_AK_Hersteller&lt;/documentation&gt;   &lt;/annotation&gt;   &lt;restriction base="xs:string"&gt;     &lt;enumeration value="0330001"&gt;       &lt;annotation&gt;         &lt;documentation&gt;ATS Medical&lt;/documentation&gt;       &lt;/annotation&gt;     &lt;/enumeration&gt;     &lt;enumeration value="0330002"&gt;       &lt;annotation&gt;         &lt;documentation&gt;Edwards Lifesciences&lt;/documentation&gt;       &lt;/annotation&gt;     &lt;/enumeration&gt;     &lt;enumeration value="0330003"&gt;       &lt;annotation&gt;         &lt;documentation&gt;Medtronic&lt;/documentation&gt;       &lt;/annotation&gt;     &lt;/enumeration&gt;     &lt;enumeration value="0330004"&gt;       &lt;annotation&gt;         &lt;documentation&gt;JenaValve&lt;/documentation&gt;       &lt;/annotation&gt;     &lt;/enumeration&gt;     &lt;enumeration value="0330005"&gt;       &lt;annotation&gt;         &lt;documentation&gt;Corcym&lt;/documentation&gt;       &lt;/annotation&gt;     &lt;/enumeration&gt;     &lt;enumeration value="0330006"&gt;       &lt;annotation&gt;         &lt;documentation&gt;Abbott Medical / St. Jude&lt;/documentation&gt;       &lt;/annotation&gt;     &lt;/enumeration&gt;     &lt;enumeration value="0330007"&gt;       &lt;annotation&gt;         &lt;documentation&gt;Symetis&lt;/documentation&gt;       &lt;/annotation&gt;     &lt;/enumeration&gt;     &lt;enumeration value="0330008"&gt;       &lt;annotation&gt;         &lt;documentation&gt;Direct Flow Medical&lt;/documentation&gt;       &lt;/annotation&gt;     &lt;/enumeration&gt;     &lt;enumeration value="0330009"&gt;       &lt;annotation&gt;         &lt;documentation&gt;Boston Scientific&lt;/documentation&gt;       &lt;/annotation&gt;     &lt;/enumeration&gt;     &lt;enumeration value="0330010"&gt; </pre>



```

    <annotation>
      <documentation>Artivion</documentation>
    </annotation>
  </enumeration>
  <enumeration value="0330011">
    <annotation>
      <documentation>Biosensors</documentation>
    </annotation>
  </enumeration>
  <enumeration value="0330012">
    <annotation>
      <documentation>LivaNova</documentation>
    </annotation>
  </enumeration>
  <enumeration value="0330013">
    <annotation>
      <documentation>Meril</documentation>
    </annotation>
  </enumeration>
  <enumeration value="0330014">
    <annotation>
      <documentation>Sahajanand Medical Technologies</documentation>
    </annotation>
  </enumeration>
  <enumeration value="0330015">
    <annotation>
      <documentation>nicht belegter Wert</documentation>
    </annotation>
  </enumeration>
  <enumeration value="0330016">
    <annotation>
      <documentation>nicht belegter Wert</documentation>
    </annotation>
  </enumeration>
  <enumeration value="0330017">
    <annotation>
      <documentation>nicht belegter Wert</documentation>
    </annotation>
  </enumeration>
  <enumeration value="0330018">
    <annotation>
      <documentation>nicht belegter Wert</documentation>
    </annotation>
  </enumeration>
  <enumeration value="0330042">
    <annotation>
      <documentation>sonstiger Hersteller</documentation>
    </annotation>
  </enumeration>
</restriction>
</simpleType>

```

#### simpleType **enum\_0338**

namespace	http://xml.ir-d.de/emg
type	restriction of <b>string</b>

properties	base xs:string															
used by	element <a href="#">PciAortenklappeBasis/PCA PciArterienSchluessel</a>															
facets	<table border="1"> <thead> <tr> <th>Kind</th> <th>Value</th> <th>Annotation</th> </tr> </thead> <tbody> <tr> <td>enumeration</td> <td>0338001</td> <td>documentation LAD</td> </tr> <tr> <td>enumeration</td> <td>0338002</td> <td>documentation RCA</td> </tr> <tr> <td>enumeration</td> <td>0338003</td> <td>documentation RCX</td> </tr> <tr> <td>enumeration</td> <td>0338004</td> <td>documentation Hauptstamm</td> </tr> </tbody> </table>	Kind	Value	Annotation	enumeration	0338001	documentation LAD	enumeration	0338002	documentation RCA	enumeration	0338003	documentation RCX	enumeration	0338004	documentation Hauptstamm
Kind	Value	Annotation														
enumeration	0338001	documentation LAD														
enumeration	0338002	documentation RCA														
enumeration	0338003	documentation RCX														
enumeration	0338004	documentation Hauptstamm														
annotation	documentation Kat_AK_PCIArterien															
source	<pre> &lt;simpleType name="enum_0338"&gt;   &lt;annotation&gt;     &lt;documentation&gt;Kat_AK_PCIArterien&lt;/documentation&gt;   &lt;/annotation&gt;   &lt;restriction base="xs:string"&gt;     &lt;enumeration value="0338001"&gt;       &lt;annotation&gt;         &lt;documentation&gt;LAD&lt;/documentation&gt;       &lt;/annotation&gt;     &lt;/enumeration&gt;     &lt;enumeration value="0338002"&gt;       &lt;annotation&gt;         &lt;documentation&gt;RCA&lt;/documentation&gt;       &lt;/annotation&gt;     &lt;/enumeration&gt;     &lt;enumeration value="0338003"&gt;       &lt;annotation&gt;         &lt;documentation&gt;RCX&lt;/documentation&gt;       &lt;/annotation&gt;     &lt;/enumeration&gt;     &lt;enumeration value="0338004"&gt;       &lt;annotation&gt;         &lt;documentation&gt;Hauptstamm&lt;/documentation&gt;       &lt;/annotation&gt;     &lt;/enumeration&gt;   &lt;/restriction&gt; &lt;/simpleType&gt; </pre>															

### simpleType enum 0339

namespace	http://xml.ir-d.de/emg												
type	restriction of <b>string</b>												
properties	base xs:string												
used by	element <a href="#">OperationAortenklappeBasis/OAK MessmethodeSchluessel</a>												
facets	<table border="1"> <thead> <tr> <th>Kind</th> <th>Value</th> <th>Annotation</th> </tr> </thead> <tbody> <tr> <td>enumeration</td> <td>0339001</td> <td>documentation TEE</td> </tr> <tr> <td>enumeration</td> <td>0339002</td> <td>documentation CT</td> </tr> <tr> <td>enumeration</td> <td>0339042</td> <td>documentation andere</td> </tr> </tbody> </table>	Kind	Value	Annotation	enumeration	0339001	documentation TEE	enumeration	0339002	documentation CT	enumeration	0339042	documentation andere
Kind	Value	Annotation											
enumeration	0339001	documentation TEE											
enumeration	0339002	documentation CT											
enumeration	0339042	documentation andere											
annotation	documentation Kat_AK_AnnulusMessmethode												

source	<pre> &lt;simpleType name="enum_0339"&gt;   &lt;annotation&gt;     &lt;documentation&gt;Kat_AK_AnnulusMessmethode&lt;/documentation&gt;   &lt;/annotation&gt;   &lt;restriction base="xs:string"&gt;     &lt;enumeration value="0339001"&gt;       &lt;annotation&gt;         &lt;documentation&gt;TEE&lt;/documentation&gt;       &lt;/annotation&gt;     &lt;/enumeration&gt;     &lt;enumeration value="0339002"&gt;       &lt;annotation&gt;         &lt;documentation&gt;CT&lt;/documentation&gt;       &lt;/annotation&gt;     &lt;/enumeration&gt;     &lt;enumeration value="0339042"&gt;       &lt;annotation&gt;         &lt;documentation&gt;andere&lt;/documentation&gt;       &lt;/annotation&gt;     &lt;/enumeration&gt;   &lt;/restriction&gt; &lt;/simpleType&gt; </pre>
--------	---

### simpleType enum\_0341

namespace	http://xml.ir-d.de/emg		
type	restriction of <b>string</b>		
properties	base xs:string		
used by	element <a href="#">FailureGrundAortenklappeBasis/FAK FailureGrundSchluessel</a>		
facets	Kind	Value	Annotation
	enumeration	0341001	documentation intraprozedural verstorben
	enumeration	0341002	documentation Implantation von mehr als einer Prothese
	enumeration	0341003	documentation gravierende Gefäß- oder Zugangskomplikation (gemäß VARC-3)
	enumeration	0341004	documentation erforderlicher chirurgischer oder interventioneller Eingriff wegen einer Klappenfehlfunktion (gemäß VARC-3)
	enumeration	0341005	documentation &qt= große strukturelle kardiale Komplikation (gemäß VARC-3)
annotation	documentation Kat_AK_FailureGrund		
source	<pre> &lt;simpleType name="enum_0341"&gt;   &lt;annotation&gt;     &lt;documentation&gt;Kat_AK_FailureGrund&lt;/documentation&gt;   &lt;/annotation&gt;   &lt;restriction base="xs:string"&gt;     &lt;enumeration value="0341001"&gt;       &lt;annotation&gt;         &lt;documentation&gt;intraprozedural verstorben&lt;/documentation&gt;       &lt;/annotation&gt;     &lt;/enumeration&gt;     &lt;enumeration value="0341002"&gt;       &lt;annotation&gt;         &lt;documentation&gt;Implantation von mehr als einer Prothese&lt;/documentation&gt; </pre>		

	<pre> &lt;/annotation&gt; &lt;/enumeration&gt; &lt;enumeration value="0341003"&gt;   &lt;annotation&gt;     &lt;documentation&gt;gravierende Gefäß- oder Zugangskomplikation (gemäß VARC-3)&lt;/documentation&gt;   &lt;/annotation&gt; &lt;/enumeration&gt; &lt;enumeration value="0341004"&gt;   &lt;annotation&gt;     &lt;documentation&gt;erforderlicher chirurgischer oder interventioneller Eingriff wegen einer Klappenfehlfunktion (gemäß VARC-3)&lt;/documentation&gt;   &lt;/annotation&gt; &lt;/enumeration&gt; &lt;enumeration value="0341005"&gt;   &lt;annotation&gt;     &lt;documentation&gt;&amp;gt;= große strukturelle kardiale Komplikation (gemäß VARC-3)&lt;/documentation&gt;   &lt;/annotation&gt; &lt;/enumeration&gt; &lt;/restriction&gt; &lt;/simpleType&gt; </pre>
--	--

### simpleType enum 0342

namespace	http://xml.ir-d.de/emg		
type	restriction of <b>string</b>		
properties	base xs:string		
used by	element <a href="#">TaviAortenklappeBasis/TAK GrundTaviSchluessel</a>		
facets	Kind	Value	Annotation
	enumeration	0342001	documentation Alter
	enumeration	0342002	documentation Frailty
	enumeration	0342003	documentation Hochrisiko
	enumeration	0342004	documentation Prognose-limitierende Zweiterkrankung
	enumeration	0342005	documentation Porzellan-Aorta
	enumeration	0342042	documentation Sonstige
annotation	documentation Kat_AK_Tavi		
source	<pre> &lt;simpleType name="enum_0342"&gt;   &lt;annotation&gt;     &lt;documentation&gt;Kat_AK_Tavi&lt;/documentation&gt;   &lt;/annotation&gt;   &lt;restriction base="xs:string"&gt;     &lt;enumeration value="0342001"&gt;       &lt;annotation&gt;         &lt;documentation&gt;Alter&lt;/documentation&gt;       &lt;/annotation&gt;     &lt;/enumeration&gt;     &lt;enumeration value="0342002"&gt;       &lt;annotation&gt;         &lt;documentation&gt;Frailty&lt;/documentation&gt; </pre>		

```

</annotation>
</enumeration>
<enumeration value="0342003">
  <annotation>
    <documentation>Hochrisiko</documentation>
  </annotation>
</enumeration>
<enumeration value="0342004">
  <annotation>
    <documentation>Prognose-limitierende Zweiterkrankung</documentation>
  </annotation>
</enumeration>
<enumeration value="0342005">
  <annotation>
    <documentation>Porzellan-Aorta</documentation>
  </annotation>
</enumeration>
<enumeration value="0342042">
  <annotation>
    <documentation>Sonstige</documentation>
  </annotation>
</enumeration>
</restriction>
</simpleType>

```

### simpleType enum\_0343

namespace	http://xml.ir-d.de/emg		
type	restriction of <b>string</b>		
properties	base xs:string		
used by	element <a href="#">KomplikationAortenklappeBasis/KAK KomplikationTypSchluessel</a>		
facets	Kind	Value	Annotation
	enumeration	0343001	documentation Device-Fehlpositionierung
	enumeration	0343002	documentation Koronarostienverschluss
	enumeration	0343003	documentation Aortendissektion
	enumeration	0343004	documentation Aortenregurgitation &gt; = 2. Grades
	enumeration	0343005	documentation Annulus-Ruptur
	enumeration	0343006	documentation Ruptur-/Perforation einer Herzhöhle ohne Therapiebedarf
	enumeration	0343007	documentation Ruptur-/Perforation einer Herzhöhle mit Therapiebedarf
	enumeration	0343008	documentation Perikardtamponade
	enumeration	0343009	documentation kardiale Dekompensation
	enumeration	0343010	documentation Himembolie
	enumeration	0343011	documentation Rhythmusstörungen
	enumeration	0343012	documentation Device-Embolisation
	enumeration	0343013	documentation vaskuläre Komplikation

	<p>enumeration 0343014 documentation Low Cardiac Output</p> <p>enumeration 0343015 documentation schwerwiegende Blutungen (intraprozedural)</p> <p>enumeration 0343016 documentation lebensbedrohliche Blutungen (intraprozedural)</p> <p>enumeration 0343017 documentation Patient verstarb im OP/Katheterlabor</p> <p>enumeration 0343042 documentation sonstige intraprozedurale Komplikationen</p>
annotation	documentation Kat_AK_KomplikationTyp
source	<pre> &lt;simpleType name="enum_0343"&gt;   &lt;annotation&gt;     &lt;documentation&gt;Kat_AK_KomplikationTyp&lt;/documentation&gt;   &lt;/annotation&gt;   &lt;restriction base="xs:string"&gt;     &lt;enumeration value="0343001"&gt;       &lt;annotation&gt;         &lt;documentation&gt;Device-Fehlpositionierung&lt;/documentation&gt;       &lt;/annotation&gt;     &lt;/enumeration&gt;     &lt;enumeration value="0343002"&gt;       &lt;annotation&gt;         &lt;documentation&gt;Koronarostienverschluss&lt;/documentation&gt;       &lt;/annotation&gt;     &lt;/enumeration&gt;     &lt;enumeration value="0343003"&gt;       &lt;annotation&gt;         &lt;documentation&gt;Aortendissektion&lt;/documentation&gt;       &lt;/annotation&gt;     &lt;/enumeration&gt;     &lt;enumeration value="0343004"&gt;       &lt;annotation&gt;         &lt;documentation&gt;Aortenregurgitation &amp;gt; = 2. Grades&lt;/documentation&gt;       &lt;/annotation&gt;     &lt;/enumeration&gt;     &lt;enumeration value="0343005"&gt;       &lt;annotation&gt;         &lt;documentation&gt;Annulus-Ruptur&lt;/documentation&gt;       &lt;/annotation&gt;     &lt;/enumeration&gt;     &lt;enumeration value="0343006"&gt;       &lt;annotation&gt;         &lt;documentation&gt;Ruptur-/Perforation einer Herzhöhle ohne Therapiebedarf&lt;/documentation&gt;       &lt;/annotation&gt;     &lt;/enumeration&gt;     &lt;enumeration value="0343007"&gt;       &lt;annotation&gt;         &lt;documentation&gt;Ruptur-/Perforation einer Herzhöhle mit Therapiebedarf&lt;/documentation&gt;       &lt;/annotation&gt;     &lt;/enumeration&gt;     &lt;enumeration value="0343008"&gt;       &lt;annotation&gt;         &lt;documentation&gt;Perikardtamponade&lt;/documentation&gt;       &lt;/annotation&gt;     &lt;/enumeration&gt;     &lt;enumeration value="0343009"&gt; </pre>

```

    <annotation>
      <documentation>kardiale Dekompensation</documentation>
    </annotation>
  </enumeration>
  <enumeration value="0343010">
    <annotation>
      <documentation>Hirnembolie</documentation>
    </annotation>
  </enumeration>
  <enumeration value="0343011">
    <annotation>
      <documentation>Rhythmusstörungen</documentation>
    </annotation>
  </enumeration>
  <enumeration value="0343012">
    <annotation>
      <documentation>Device-Embolisation</documentation>
    </annotation>
  </enumeration>
  <enumeration value="0343013">
    <annotation>
      <documentation>vaskuläre Komplikation</documentation>
    </annotation>
  </enumeration>
  <enumeration value="0343014">
    <annotation>
      <documentation>Low Cardiac Output</documentation>
    </annotation>
  </enumeration>
  <enumeration value="0343015">
    <annotation>
      <documentation>schwerwiegende Blutungen
(intraprozedural)</documentation>
    </annotation>
  </enumeration>
  <enumeration value="0343016">
    <annotation>
      <documentation>lebensbedrohliche Blutungen
(intraprozedural)</documentation>
    </annotation>
  </enumeration>
  <enumeration value="0343017">
    <annotation>
      <documentation>Patient verstarb im OP/Katheterlabor</documentation>
    </annotation>
  </enumeration>
  <enumeration value="0343042">
    <annotation>
      <documentation>sonstige intraprozedurale
Komplikationen</documentation>
    </annotation>
  </enumeration>
</restriction>
</simpleType>

```

simpleType enum 0346

namespace	http://xml.ir-d.de/emg
-----------	------------------------

type	restriction of <b>string</b>		
properties	base xs:string		
used by	element <a href="#">OperationAortenklappeBasis/OAK TherapieLcoSchluessel</a>		
facets	Kind	Value	Annotation
	enumeration	0346001	documentation keine Therapie erforderlich
	enumeration	0346002	documentation medikamentös
	enumeration	0346003	documentation IABP
	enumeration	0346004	documentation VAD
	enumeration	0346005	documentation ECMO
	enumeration	0346042	documentation sonstige
annotation	documentation Kat_AK_TherapieLCO		
source	<pre> &lt;simpleType name="enum_0346"&gt;   &lt;annotation&gt;     &lt;documentation&gt;Kat_AK_TherapieLCO&lt;/documentation&gt;   &lt;/annotation&gt;   &lt;restriction base="xs:string"&gt;     &lt;enumeration value="0346001"&gt;       &lt;annotation&gt;         &lt;documentation&gt;keine Therapie erforderlich&lt;/documentation&gt;       &lt;/annotation&gt;     &lt;/enumeration&gt;     &lt;enumeration value="0346002"&gt;       &lt;annotation&gt;         &lt;documentation&gt;medikamentös&lt;/documentation&gt;       &lt;/annotation&gt;     &lt;/enumeration&gt;     &lt;enumeration value="0346003"&gt;       &lt;annotation&gt;         &lt;documentation&gt;IABP&lt;/documentation&gt;       &lt;/annotation&gt;     &lt;/enumeration&gt;     &lt;enumeration value="0346004"&gt;       &lt;annotation&gt;         &lt;documentation&gt;VAD&lt;/documentation&gt;       &lt;/annotation&gt;     &lt;/enumeration&gt;     &lt;enumeration value="0346005"&gt;       &lt;annotation&gt;         &lt;documentation&gt;ECMO&lt;/documentation&gt;       &lt;/annotation&gt;     &lt;/enumeration&gt;     &lt;enumeration value="0346042"&gt;       &lt;annotation&gt;         &lt;documentation&gt;sonstige&lt;/documentation&gt;       &lt;/annotation&gt;     &lt;/enumeration&gt;   &lt;/restriction&gt; &lt;/simpleType&gt; </pre>		



### simpleType enum\_0347

namespace	http://xml.ir-d.de/emg		
type	restriction of <b>string</b>		
properties	base xs:string		
used by	element <a href="#">OperationAortenklappeBasis/OAK EingriffsumfangSchluessel</a>		
facets	Kind	Value	Annotation
	enumeration	0347001	documentation Einzeleingriff
	enumeration	0347002	documentation Kombinationseingriff mit mehreren Prozeduren
annotation	documentation Kat_AK_Eingriffsumfang		
source	<pre> &lt;simpleType name="enum_0347"&gt;   &lt;annotation&gt;     &lt;documentation&gt;Kat_AK_Eingriffsumfang&lt;/documentation&gt;   &lt;/annotation&gt;   &lt;restriction base="xs:string"&gt;     &lt;enumeration value="0347001"&gt;       &lt;annotation&gt;         &lt;documentation&gt;Einzeleingriff&lt;/documentation&gt;       &lt;/annotation&gt;     &lt;/enumeration&gt;     &lt;enumeration value="0347002"&gt;       &lt;annotation&gt;         &lt;documentation&gt;Kombinationseingriff mit mehreren Prozeduren&lt;/documentation&gt;       &lt;/annotation&gt;     &lt;/enumeration&gt;   &lt;/restriction&gt; &lt;/simpleType&gt; </pre>		

### simpleType enum\_0348

namespace	http://xml.ir-d.de/emg		
type	restriction of <b>string</b>		
properties	base xs:string		
used by	element <a href="#">OperationAortenklappeBasis/OAK VorgehenSchluessel</a>		
facets	Kind	Value	Annotation
	enumeration	0348001	documentation mit HLM
	enumeration	0348002	documentation ohne HLM
	enumeration	0348003	documentation Umstieg von OP ohne HLM auf OP mit HLM
annotation	documentation Kat_AK_OPVorgehen		
source	<pre> &lt;simpleType name="enum_0348"&gt;   &lt;annotation&gt;     &lt;documentation&gt;Kat_AK_OPVorgehen&lt;/documentation&gt;   &lt;/annotation&gt;   &lt;restriction base="xs:string"&gt;     &lt;enumeration value="0348001"&gt;       &lt;annotation&gt;         &lt;documentation&gt;mit HLM&lt;/documentation&gt;       &lt;/annotation&gt;     &lt;/enumeration&gt;   &lt;/restriction&gt; &lt;/simpleType&gt; </pre>		

	<pre> &lt;/annotation&gt; &lt;/enumeration&gt; &lt;enumeration value="0348002"&gt;   &lt;annotation&gt;     &lt;documentation&gt;ohne HLM&lt;/documentation&gt;   &lt;/annotation&gt; &lt;/enumeration&gt; &lt;enumeration value="0348003"&gt;   &lt;annotation&gt;     &lt;documentation&gt;Umstieg von OP ohne HLM auf OP mit HLM&lt;/documentation&gt;   &lt;/annotation&gt; &lt;/enumeration&gt; &lt;/restriction&gt; &lt;/simpleType&gt; </pre>
--	--

### simpleType enum\_0350

namespace	http://xml.ir-d.de/emg																		
type	restriction of <b>string</b>																		
properties	base xs:string																		
used by	elements <a href="#">OperationAortenklappeBasis/OAK IntraOpMethodeSchluessel</a> <a href="#">OperationAortenklappeBasis/OAK PraeOpMethodeSchluessel</a>																		
facets	<table border="1"> <thead> <tr> <th>Kind</th> <th>Value</th> <th>Annotation</th> </tr> </thead> <tbody> <tr> <td>enumeration</td> <td>0350001</td> <td>documentation IABP</td> </tr> <tr> <td>enumeration</td> <td>0350002</td> <td>documentation Impella</td> </tr> <tr> <td>enumeration</td> <td>0350003</td> <td>documentation vv ECMO</td> </tr> <tr> <td>enumeration</td> <td>0350004</td> <td>documentation va ECMO</td> </tr> <tr> <td>enumeration</td> <td>0350042</td> <td>documentation andere</td> </tr> </tbody> </table>	Kind	Value	Annotation	enumeration	0350001	documentation IABP	enumeration	0350002	documentation Impella	enumeration	0350003	documentation vv ECMO	enumeration	0350004	documentation va ECMO	enumeration	0350042	documentation andere
Kind	Value	Annotation																	
enumeration	0350001	documentation IABP																	
enumeration	0350002	documentation Impella																	
enumeration	0350003	documentation vv ECMO																	
enumeration	0350004	documentation va ECMO																	
enumeration	0350042	documentation andere																	
annotation	documentation Kat_AK_Methode																		
source	<pre> &lt;simpleType name="enum_0350"&gt;   &lt;annotation&gt;     &lt;documentation&gt;Kat_AK_Methode&lt;/documentation&gt;   &lt;/annotation&gt;   &lt;restriction base="xs:string"&gt;     &lt;enumeration value="0350001"&gt;       &lt;annotation&gt;         &lt;documentation&gt;IABP&lt;/documentation&gt;       &lt;/annotation&gt;     &lt;/enumeration&gt;     &lt;enumeration value="0350002"&gt;       &lt;annotation&gt;         &lt;documentation&gt;Impella&lt;/documentation&gt;       &lt;/annotation&gt;     &lt;/enumeration&gt;     &lt;enumeration value="0350003"&gt;       &lt;annotation&gt;         &lt;documentation&gt;vv ECMO&lt;/documentation&gt;       &lt;/annotation&gt;     &lt;/enumeration&gt;     &lt;enumeration value="0350004"&gt;       &lt;annotation&gt; </pre>																		

	<pre> &lt;documentation&gt;va ECMO&lt;/documentation&gt; &lt;/annotation&gt; &lt;/enumeration&gt; &lt;enumeration value="0350042"&gt;   &lt;annotation&gt;     &lt;documentation&gt;andere&lt;/documentation&gt;   &lt;/annotation&gt; &lt;/enumeration&gt; &lt;/restriction&gt; &lt;/simpleType&gt; </pre>
--	---

### simpleType enum\_0351

namespace	http://xml.ir-d.de/emg		
type	restriction of <b>string</b>		
properties	base xs:string		
used by	element <a href="#">OperationAortenklappeBasis/OAK KonversionSchluessel</a>		
facets	Kind	Value	Annotation
	enumeration	0351001	documentation nein
	enumeration	0351002	documentation ja, zu Sternotomie
	enumeration	0351003	documentation ja, zu transapikal
	enumeration	0351004	documentation ja, zu transaortal
	enumeration	0351005	documentation ja, zu transfemoral
	enumeration	0351006	documentation ja, zu transaxillär
	enumeration	0351007	documentation ja, zu anderem endovaskulären Zugang
	enumeration	0351042	documentation ja, zu anderem Zugang
annotation	documentation Kat_AK_Konversion		
source	<pre> &lt;simpleType name="enum_0351"&gt;   &lt;annotation&gt;     &lt;documentation&gt;Kat_AK_Konversion&lt;/documentation&gt;   &lt;/annotation&gt;   &lt;restriction base="xs:string"&gt;     &lt;enumeration value="0351001"&gt;       &lt;annotation&gt;         &lt;documentation&gt;nein&lt;/documentation&gt;       &lt;/annotation&gt;     &lt;/enumeration&gt;     &lt;enumeration value="0351002"&gt;       &lt;annotation&gt;         &lt;documentation&gt;ja, zu Sternotomie&lt;/documentation&gt;       &lt;/annotation&gt;     &lt;/enumeration&gt;     &lt;enumeration value="0351003"&gt;       &lt;annotation&gt;         &lt;documentation&gt;ja, zu transapikal&lt;/documentation&gt;       &lt;/annotation&gt;     &lt;/enumeration&gt;     &lt;enumeration value="0351004"&gt; </pre>		

	<pre> &lt;annotation&gt;   &lt;documentation&gt;ja, zu transaortal&lt;/documentation&gt; &lt;/annotation&gt; &lt;/enumeration&gt; &lt;enumeration value="0351005"&gt;   &lt;annotation&gt;     &lt;documentation&gt;ja, zu transfemoral&lt;/documentation&gt;   &lt;/annotation&gt; &lt;/enumeration&gt; &lt;enumeration value="0351006"&gt;   &lt;annotation&gt;     &lt;documentation&gt;ja, zu transaxillär&lt;/documentation&gt;   &lt;/annotation&gt; &lt;/enumeration&gt; &lt;enumeration value="0351007"&gt;   &lt;annotation&gt;     &lt;documentation&gt;ja, zu anderem endovaskulären Zugang&lt;/documentation&gt;   &lt;/annotation&gt; &lt;/enumeration&gt; &lt;enumeration value="0351042"&gt;   &lt;annotation&gt;     &lt;documentation&gt;ja, zu anderem Zugang&lt;/documentation&gt;   &lt;/annotation&gt; &lt;/enumeration&gt; &lt;/restriction&gt; &lt;/simpleType&gt; </pre>
--	--

### simpleType enum\_0352

namespace	http://xml.ir-d.de/emg		
type	restriction of <b>string</b>		
properties	base xs:string		
used by	element	<a href="#">OperationAortenklappeBasis/OAK AnaesthesieSchluessel</a>	
facets	Kind	Value	Annotation
	enumeration	0352001	documentation nein
	enumeration	0352002	documentation ja, Intubationsnarkose
	enumeration	0352003	documentation ja, Maskenbeatmung, incl. LAMA
	enumeration	0352042	documentation ja, unbekannt welche
annotation	documentation Kat_AK_Anaesthesie		
source	<pre> &lt;simpleType name="enum_0352"&gt;   &lt;annotation&gt;     &lt;documentation&gt;Kat_AK_Anaesthesie&lt;/documentation&gt;   &lt;/annotation&gt;   &lt;restriction base="xs:string"&gt;     &lt;enumeration value="0352001"&gt;       &lt;annotation&gt;         &lt;documentation&gt;nein&lt;/documentation&gt;       &lt;/annotation&gt;     &lt;/enumeration&gt;     &lt;enumeration value="0352002"&gt;       &lt;annotation&gt; </pre>		

	<pre> &lt;documentation&gt;ja, Intubationsnarkose&lt;/documentation&gt; &lt;/annotation&gt; &lt;/enumeration&gt; &lt;enumeration value="0352003"&gt;   &lt;annotation&gt;     &lt;documentation&gt;ja, Maskenbeatmung, incl. LAMA&lt;/documentation&gt;   &lt;/annotation&gt; &lt;/enumeration&gt; &lt;enumeration value="0352042"&gt;   &lt;annotation&gt;     &lt;documentation&gt;ja, unbekannt welche&lt;/documentation&gt;   &lt;/annotation&gt; &lt;/enumeration&gt; &lt;/restriction&gt; &lt;/simpleType&gt; </pre>
--	--

### simpleType enum 0353

namespace	http://xml.ir-d.de/emg		
type	restriction of <b>string</b>		
properties	base xs:string		
used by	element <a href="#">OperationAortenklappeBasis/OAK ResidualeInsuffizienzSchluessel</a>		
facets	Kind	Value	Annotation
	enumeration	0353001	documentation keine
	enumeration	0353002	documentation leichtgradig
	enumeration	0353003	documentation mittelgradig
	enumeration	0353004	documentation hochgradig
	enumeration	0353099	documentation nicht bestimmbar
annotation	documentation Kat_AK_ResidualeAorteninsuffizienz		
source	<pre> &lt;simpleType name="enum_0353"&gt;   &lt;annotation&gt;     &lt;documentation&gt;Kat_AK_ResidualeAorteninsuffizienz&lt;/documentation&gt;   &lt;/annotation&gt;   &lt;restriction base="xs:string"&gt;     &lt;enumeration value="0353001"&gt;       &lt;annotation&gt;         &lt;documentation&gt;keine&lt;/documentation&gt;       &lt;/annotation&gt;     &lt;/enumeration&gt;     &lt;enumeration value="0353002"&gt;       &lt;annotation&gt;         &lt;documentation&gt;leichtgradig&lt;/documentation&gt;       &lt;/annotation&gt;     &lt;/enumeration&gt;     &lt;enumeration value="0353003"&gt;       &lt;annotation&gt;         &lt;documentation&gt;mittelgradig&lt;/documentation&gt;       &lt;/annotation&gt;     &lt;/enumeration&gt;     &lt;enumeration value="0353004"&gt; </pre>		

	<pre> &lt;annotation&gt;   &lt;documentation&gt;hochgradig&lt;/documentation&gt; &lt;/annotation&gt; &lt;/enumeration&gt; &lt;enumeration value="0353099"&gt;   &lt;annotation&gt;     &lt;documentation&gt;nicht bestimmbar&lt;/documentation&gt;   &lt;/annotation&gt; &lt;/enumeration&gt; &lt;/restriction&gt; &lt;/simpleType&gt; </pre>
--	---

### simpleType enum\_0354

namespace	http://xml.ir-d.de/emg		
type	restriction of <b>string</b>		
properties	base xs:string		
used by	element <a href="#">OperationAortenklappeBasis/OAK ZugangVerschlussSchlussel</a>		
facets	Kind	Value	Annotation
	enumeration	0354001	documentation chirurgisch-offen
	enumeration	0354002	documentation Verschluss-System
	enumeration	0354042	documentation sonstige
annotation	documentation Kat_AK_Zugangswegverschluss		
source	<pre> &lt;simpleType name="enum_0354"&gt;   &lt;annotation&gt;     &lt;documentation&gt;Kat_AK_Zugangswegverschluss&lt;/documentation&gt;   &lt;/annotation&gt;   &lt;restriction base="xs:string"&gt;     &lt;enumeration value="0354001"&gt;       &lt;annotation&gt;         &lt;documentation&gt;chirurgisch-offen&lt;/documentation&gt;       &lt;/annotation&gt;     &lt;/enumeration&gt;     &lt;enumeration value="0354002"&gt;       &lt;annotation&gt;         &lt;documentation&gt;Verschluss-System&lt;/documentation&gt;       &lt;/annotation&gt;     &lt;/enumeration&gt;     &lt;enumeration value="0354042"&gt;       &lt;annotation&gt;         &lt;documentation&gt;sonstige&lt;/documentation&gt;       &lt;/annotation&gt;     &lt;/enumeration&gt;   &lt;/restriction&gt; &lt;/simpleType&gt; </pre>		

### simpleType enum\_0357

namespace	http://xml.ir-d.de/emg
type	restriction of <b>string</b>

properties	base xs:string																		
used by	element <a href="#">PatientenaufnahmeAortenklappeBasis/PAA BefundSchluessel</a>																		
facets	<table border="1"> <thead> <tr> <th>Kind</th> <th>Value</th> <th>Annotation</th> </tr> </thead> <tbody> <tr> <td>enumeration</td> <td>0357001</td> <td>documentation keine KHK</td> </tr> <tr> <td>enumeration</td> <td>0357002</td> <td>documentation 1-Gefäßerkrankung</td> </tr> <tr> <td>enumeration</td> <td>0357003</td> <td>documentation 2-Gefäßerkrankung</td> </tr> <tr> <td>enumeration</td> <td>0357004</td> <td>documentation 3-Gefäßerkrankung</td> </tr> <tr> <td>enumeration</td> <td>0357005</td> <td>documentation keine koronare Bildgebung</td> </tr> </tbody> </table>	Kind	Value	Annotation	enumeration	0357001	documentation keine KHK	enumeration	0357002	documentation 1-Gefäßerkrankung	enumeration	0357003	documentation 2-Gefäßerkrankung	enumeration	0357004	documentation 3-Gefäßerkrankung	enumeration	0357005	documentation keine koronare Bildgebung
Kind	Value	Annotation																	
enumeration	0357001	documentation keine KHK																	
enumeration	0357002	documentation 1-Gefäßerkrankung																	
enumeration	0357003	documentation 2-Gefäßerkrankung																	
enumeration	0357004	documentation 3-Gefäßerkrankung																	
enumeration	0357005	documentation keine koronare Bildgebung																	
annotation	documentation Kat_AK_BefundBildgebung																		
source	<pre> &lt;simpleType name="enum_0357"&gt;   &lt;annotation&gt;     &lt;documentation&gt;Kat_AK_BefundBildgebung&lt;/documentation&gt;   &lt;/annotation&gt;   &lt;restriction base="xs:string"&gt;     &lt;enumeration value="0357001"&gt;       &lt;annotation&gt;         &lt;documentation&gt;keine KHK&lt;/documentation&gt;       &lt;/annotation&gt;     &lt;/enumeration&gt;     &lt;enumeration value="0357002"&gt;       &lt;annotation&gt;         &lt;documentation&gt;1-Gefäßerkrankung&lt;/documentation&gt;       &lt;/annotation&gt;     &lt;/enumeration&gt;     &lt;enumeration value="0357003"&gt;       &lt;annotation&gt;         &lt;documentation&gt;2-Gefäßerkrankung&lt;/documentation&gt;       &lt;/annotation&gt;     &lt;/enumeration&gt;     &lt;enumeration value="0357004"&gt;       &lt;annotation&gt;         &lt;documentation&gt;3-Gefäßerkrankung&lt;/documentation&gt;       &lt;/annotation&gt;     &lt;/enumeration&gt;     &lt;enumeration value="0357005"&gt;       &lt;annotation&gt;         &lt;documentation&gt;keine koronare Bildgebung&lt;/documentation&gt;       &lt;/annotation&gt;     &lt;/enumeration&gt;   &lt;/restriction&gt; &lt;/simpleType&gt; </pre>																		

### simpleType enum\_0358

namespace	http://xml.ir-d.de/emg			
type	restriction of <b>string</b>			
properties	base xs:string			
used by	element <a href="#">PatientenaufnahmeAortenklappeBasis/PAA AnzahlVorOpSchluessel</a>			
facets	<table border="1"> <thead> <tr> <th>Kind</th> <th>Value</th> <th>Annotation</th> </tr> </thead> <tbody> </tbody> </table>	Kind	Value	Annotation
Kind	Value	Annotation		

	<p>enumeration 0358001 documentation 0</p> <p>enumeration 0358002 documentation 1</p> <p>enumeration 0358003 documentation 2</p> <p>enumeration 0358004 documentation 3</p> <p>enumeration 0358005 documentation 4</p> <p>enumeration 0358006 documentation 5 oder mehr</p> <p>enumeration 0358098 documentation genaue Anzahl unbekannt (aber mind. 1)</p> <p>enumeration 0358099 documentation unbekannt</p>
annotation	documentation Kat_AK_AnzahlVorOP
source	<pre> &lt;simpleType name="enum_0358"&gt;   &lt;annotation&gt;     &lt;documentation&gt;Kat_AK_AnzahlVorOP&lt;/documentation&gt;   &lt;/annotation&gt;   &lt;restriction base="xs:string"&gt;     &lt;enumeration value="0358001"&gt;       &lt;annotation&gt;         &lt;documentation&gt;0&lt;/documentation&gt;       &lt;/annotation&gt;     &lt;/enumeration&gt;     &lt;enumeration value="0358002"&gt;       &lt;annotation&gt;         &lt;documentation&gt;1&lt;/documentation&gt;       &lt;/annotation&gt;     &lt;/enumeration&gt;     &lt;enumeration value="0358003"&gt;       &lt;annotation&gt;         &lt;documentation&gt;2&lt;/documentation&gt;       &lt;/annotation&gt;     &lt;/enumeration&gt;     &lt;enumeration value="0358004"&gt;       &lt;annotation&gt;         &lt;documentation&gt;3&lt;/documentation&gt;       &lt;/annotation&gt;     &lt;/enumeration&gt;     &lt;enumeration value="0358005"&gt;       &lt;annotation&gt;         &lt;documentation&gt;4&lt;/documentation&gt;       &lt;/annotation&gt;     &lt;/enumeration&gt;     &lt;enumeration value="0358006"&gt;       &lt;annotation&gt;         &lt;documentation&gt;5 oder mehr&lt;/documentation&gt;       &lt;/annotation&gt;     &lt;/enumeration&gt;     &lt;enumeration value="0358098"&gt;       &lt;annotation&gt;         &lt;documentation&gt;genaue Anzahl unbekannt (aber mind. 1)&lt;/documentation&gt;       &lt;/annotation&gt;     &lt;/enumeration&gt;     &lt;enumeration value="0358099"&gt;       &lt;annotation&gt; </pre>



	<pre> &lt;documentation&gt;unbekannt&lt;/documentation&gt; &lt;/annotation&gt; &lt;/enumeration&gt; &lt;/restriction&gt; &lt;/simpleType&gt; </pre>
--	---

### simpleType enum\_0359

namespace	http://xml.ir-d.de/emg		
type	restriction of <b>string</b>		
properties	base xs:string		
used by	element <a href="#">PatientenaufnahmeAortenklappeBasis/PAA LvotSchluessel</a>		
facets	Kind	Value	Annotation
	enumeration	0359001	documentation nein
	enumeration	0359002	documentation ja - einseitig
	enumeration	0359003	documentation ja - beidseitig
	enumeration	0359042	documentation unbekannt
annotation	documentation Kat_AK_LVOT		
source	<pre> &lt;simpleType name="enum_0359"&gt;   &lt;annotation&gt;     &lt;documentation&gt;Kat_AK_LVOT&lt;/documentation&gt;   &lt;/annotation&gt;   &lt;restriction base="xs:string"&gt;     &lt;enumeration value="0359001"&gt;       &lt;annotation&gt;         &lt;documentation&gt;nein&lt;/documentation&gt;       &lt;/annotation&gt;     &lt;/enumeration&gt;     &lt;enumeration value="0359002"&gt;       &lt;annotation&gt;         &lt;documentation&gt;ja - einseitig&lt;/documentation&gt;       &lt;/annotation&gt;     &lt;/enumeration&gt;     &lt;enumeration value="0359003"&gt;       &lt;annotation&gt;         &lt;documentation&gt;ja - beidseitig&lt;/documentation&gt;       &lt;/annotation&gt;     &lt;/enumeration&gt;     &lt;enumeration value="0359042"&gt;       &lt;annotation&gt;         &lt;documentation&gt;unbekannt&lt;/documentation&gt;       &lt;/annotation&gt;     &lt;/enumeration&gt;   &lt;/restriction&gt; &lt;/simpleType&gt; </pre>		

### simpleType enum\_0360

namespace	http://xml.ir-d.de/emg
-----------	------------------------

type	restriction of <b>string</b>																								
properties	base xs:string																								
used by	elements <a href="#">PatientenaufnahmeAortenklappeBasis/PAA TrikuspidalinsuffizienzSchluessel</a> <a href="#">PostoperationAortenklappeBasis/POA TrikuspidalinsuffizienzSchluessel</a>																								
facets	<table border="1"> <thead> <tr> <th>Kind</th> <th>Value</th> <th>Annotation</th> </tr> </thead> <tbody> <tr> <td>enumeration</td> <td>0360001</td> <td>documentation keine</td> </tr> <tr> <td>enumeration</td> <td>0360002</td> <td>documentation leichtgradig</td> </tr> <tr> <td>enumeration</td> <td>0360003</td> <td>documentation mittelgradig</td> </tr> <tr> <td>enumeration</td> <td>0360004</td> <td>documentation hochgradig</td> </tr> <tr> <td>enumeration</td> <td>0360005</td> <td>documentation massive</td> </tr> <tr> <td>enumeration</td> <td>0360006</td> <td>documentation torrential</td> </tr> <tr> <td>enumeration</td> <td>0360099</td> <td>documentation unbekannt</td> </tr> </tbody> </table>	Kind	Value	Annotation	enumeration	0360001	documentation keine	enumeration	0360002	documentation leichtgradig	enumeration	0360003	documentation mittelgradig	enumeration	0360004	documentation hochgradig	enumeration	0360005	documentation massive	enumeration	0360006	documentation torrential	enumeration	0360099	documentation unbekannt
Kind	Value	Annotation																							
enumeration	0360001	documentation keine																							
enumeration	0360002	documentation leichtgradig																							
enumeration	0360003	documentation mittelgradig																							
enumeration	0360004	documentation hochgradig																							
enumeration	0360005	documentation massive																							
enumeration	0360006	documentation torrential																							
enumeration	0360099	documentation unbekannt																							
annotation	documentation Kat_AK_TriskupidalInsuffizienz																								
source	<pre> &lt;simpleType name="enum_0360"&gt;   &lt;annotation&gt;     &lt;documentation&gt;Kat_AK_TriskupidalInsuffizienz&lt;/documentation&gt;   &lt;/annotation&gt;   &lt;restriction base="xs:string"&gt;     &lt;enumeration value="0360001"&gt;       &lt;annotation&gt;         &lt;documentation&gt;keine&lt;/documentation&gt;       &lt;/annotation&gt;     &lt;/enumeration&gt;     &lt;enumeration value="0360002"&gt;       &lt;annotation&gt;         &lt;documentation&gt;leichtgradig&lt;/documentation&gt;       &lt;/annotation&gt;     &lt;/enumeration&gt;     &lt;enumeration value="0360003"&gt;       &lt;annotation&gt;         &lt;documentation&gt;mittelgradig&lt;/documentation&gt;       &lt;/annotation&gt;     &lt;/enumeration&gt;     &lt;enumeration value="0360004"&gt;       &lt;annotation&gt;         &lt;documentation&gt;hochgradig&lt;/documentation&gt;       &lt;/annotation&gt;     &lt;/enumeration&gt;     &lt;enumeration value="0360005"&gt;       &lt;annotation&gt;         &lt;documentation&gt;massive&lt;/documentation&gt;       &lt;/annotation&gt;     &lt;/enumeration&gt;     &lt;enumeration value="0360006"&gt;       &lt;annotation&gt;         &lt;documentation&gt;torrential&lt;/documentation&gt;       &lt;/annotation&gt;     &lt;/enumeration&gt;     &lt;enumeration value="0360099"&gt;       &lt;annotation&gt;         &lt;documentation&gt;unbekannt&lt;/documentation&gt;       &lt;/annotation&gt;     &lt;/enumeration&gt;   &lt;/restriction&gt; &lt;/simpleType&gt; </pre>																								

```

</annotation>
</enumeration>
</restriction>
</simpleType>

```

### simpleType enum\_0361

namespace	http://xml.ir-d.de/emg		
type	restriction of <b>string</b>		
properties	base xs:string		
used by	elements <a href="#">PatientenaufnahmeAortenklappeBasis/PAA DekompensationSchluessel</a> <a href="#">PatientenaufnahmeAortenklappeBasis/PAA ReanimationSchluessel</a>		
facets	Kind	Value	Annotation
	enumeration	0361001	documentation nein
	enumeration	0361002	documentation ja, letzte(r) innerhalb der letzten 48 Stunden
	enumeration	0361003	documentation ja, letzte(r) innerhalb der letzten 21 Tage
	enumeration	0361004	documentation ja, letzte(r) länger als 21 Tage
	enumeration	0361098	documentation ja, letzter Zeitpunkt unbekannt
	enumeration	0361099	documentation unbekannt
annotation	documentation Kat_AK_SchockReanimation		
source	<pre> &lt;simpleType name="enum_0361"&gt;   &lt;annotation&gt;     &lt;documentation&gt;Kat_AK_SchockReanimation&lt;/documentation&gt;   &lt;/annotation&gt;   &lt;restriction base="xs:string"&gt;     &lt;enumeration value="0361001"&gt;       &lt;annotation&gt;         &lt;documentation&gt;nein&lt;/documentation&gt;       &lt;/annotation&gt;     &lt;/enumeration&gt;     &lt;enumeration value="0361002"&gt;       &lt;annotation&gt;         &lt;documentation&gt;ja, letzte(r) innerhalb der letzten 48 Stunden&lt;/documentation&gt;       &lt;/annotation&gt;     &lt;/enumeration&gt;     &lt;enumeration value="0361003"&gt;       &lt;annotation&gt;         &lt;documentation&gt;ja, letzte(r) innerhalb der letzten 21 Tage&lt;/documentation&gt;       &lt;/annotation&gt;     &lt;/enumeration&gt;     &lt;enumeration value="0361004"&gt;       &lt;annotation&gt;         &lt;documentation&gt;ja, letzte(r) länger als 21 Tage&lt;/documentation&gt;       &lt;/annotation&gt;     &lt;/enumeration&gt;     &lt;enumeration value="0361098"&gt;       &lt;annotation&gt;         &lt;documentation&gt;ja, letzter Zeitpunkt unbekannt&lt;/documentation&gt;       &lt;/annotation&gt;     &lt;/enumeration&gt;   &lt;/restriction&gt; &lt;/simpleType&gt; </pre>		

	<pre> &lt;/annotation&gt; &lt;/enumeration&gt; &lt;enumeration value="0361099"&gt;   &lt;annotation&gt;     &lt;documentation&gt;unbekannt&lt;/documentation&gt;   &lt;/annotation&gt; &lt;/enumeration&gt; &lt;/restriction&gt; &lt;/simpleType&gt; </pre>
--	---

### simpleType enum\_0362

namespace	http://xml.ir-d.de/emg		
type	restriction of <b>string</b>		
properties	base xs:string		
used by	element <a href="#">PatientenaufnahmeAortenklappeBasis/PAA_HerzrhythmusSchlüssel</a>		
facets	Kind	Value	Annotation
	enumeration	0362001	documentation Sinusrhythmus
	enumeration	0362002	documentation Vorhofflimmern
	enumeration	0362042	documentation anderer Herzrhythmus
annotation	documentation Kat_AK_Herzrhythmus		
source	<pre> &lt;simpleType name="enum_0362"&gt;   &lt;annotation&gt;     &lt;documentation&gt;Kat_AK_Herzrhythmus&lt;/documentation&gt;   &lt;/annotation&gt;   &lt;restriction base="xs:string"&gt;     &lt;enumeration value="0362001"&gt;       &lt;annotation&gt;         &lt;documentation&gt;Sinusrhythmus&lt;/documentation&gt;       &lt;/annotation&gt;     &lt;/enumeration&gt;     &lt;enumeration value="0362002"&gt;       &lt;annotation&gt;         &lt;documentation&gt;Vorhofflimmern&lt;/documentation&gt;       &lt;/annotation&gt;     &lt;/enumeration&gt;     &lt;enumeration value="0362042"&gt;       &lt;annotation&gt;         &lt;documentation&gt;anderer Herzrhythmus&lt;/documentation&gt;       &lt;/annotation&gt;     &lt;/enumeration&gt;   &lt;/restriction&gt; &lt;/simpleType&gt; </pre>		

### simpleType enum\_0363

namespace	http://xml.ir-d.de/emg		
type	restriction of <b>string</b>		
properties	base xs:string		

used by	element <a href="#">PatientenaufnahmeAortenklappeBasis/PAA_VorhofflimmernSchluessel</a>															
facets	<table border="1"> <thead> <tr> <th>Kind</th> <th>Value</th> <th>Annotation</th> </tr> </thead> <tbody> <tr> <td>enumeration</td> <td>0363001</td> <td>documentation nein</td> </tr> <tr> <td>enumeration</td> <td>0363002</td> <td>documentation paroxysmal</td> </tr> <tr> <td>enumeration</td> <td>0363003</td> <td>documentation persistierend</td> </tr> <tr> <td>enumeration</td> <td>0363004</td> <td>documentation permanent</td> </tr> </tbody> </table>	Kind	Value	Annotation	enumeration	0363001	documentation nein	enumeration	0363002	documentation paroxysmal	enumeration	0363003	documentation persistierend	enumeration	0363004	documentation permanent
Kind	Value	Annotation														
enumeration	0363001	documentation nein														
enumeration	0363002	documentation paroxysmal														
enumeration	0363003	documentation persistierend														
enumeration	0363004	documentation permanent														
annotation	documentation Kat_AK_Vorhofflimmern															
source	<pre> &lt;simpleType name="enum_0363"&gt;   &lt;annotation&gt;     &lt;documentation&gt;Kat_AK_Vorhofflimmern&lt;/documentation&gt;   &lt;/annotation&gt;   &lt;restriction base="xs:string"&gt;     &lt;enumeration value="0363001"&gt;       &lt;annotation&gt;         &lt;documentation&gt;nein&lt;/documentation&gt;       &lt;/annotation&gt;     &lt;/enumeration&gt;     &lt;enumeration value="0363002"&gt;       &lt;annotation&gt;         &lt;documentation&gt;paroxysmal&lt;/documentation&gt;       &lt;/annotation&gt;     &lt;/enumeration&gt;     &lt;enumeration value="0363003"&gt;       &lt;annotation&gt;         &lt;documentation&gt;persistierend&lt;/documentation&gt;       &lt;/annotation&gt;     &lt;/enumeration&gt;     &lt;enumeration value="0363004"&gt;       &lt;annotation&gt;         &lt;documentation&gt;permanent&lt;/documentation&gt;       &lt;/annotation&gt;     &lt;/enumeration&gt;   &lt;/restriction&gt; &lt;/simpleType&gt; </pre>															

### simpleType **enum\_0364**

namespace	http://xml.ir-d.de/emg																		
type	restriction of <b>string</b>																		
properties	base xs:string																		
used by	elements <a href="#">PatientenaufnahmeAortenklappeBasis/PAA_SchrittmacherSchluessel</a> <a href="#">PostoperationAortenklappeBasis/POA_SchrittmacherSchluessel</a>																		
facets	<table border="1"> <thead> <tr> <th>Kind</th> <th>Value</th> <th>Annotation</th> </tr> </thead> <tbody> <tr> <td>enumeration</td> <td>0364001</td> <td>documentation nein</td> </tr> <tr> <td>enumeration</td> <td>0364002</td> <td>documentation Schrittmacher ohne CRT-System</td> </tr> <tr> <td>enumeration</td> <td>0364003</td> <td>documentation Schrittmacher mit CRT-System</td> </tr> <tr> <td>enumeration</td> <td>0364004</td> <td>documentation Defibrillator ohne CRT-System</td> </tr> <tr> <td>enumeration</td> <td>0364005</td> <td>documentation</td> </tr> </tbody> </table>	Kind	Value	Annotation	enumeration	0364001	documentation nein	enumeration	0364002	documentation Schrittmacher ohne CRT-System	enumeration	0364003	documentation Schrittmacher mit CRT-System	enumeration	0364004	documentation Defibrillator ohne CRT-System	enumeration	0364005	documentation
Kind	Value	Annotation																	
enumeration	0364001	documentation nein																	
enumeration	0364002	documentation Schrittmacher ohne CRT-System																	
enumeration	0364003	documentation Schrittmacher mit CRT-System																	
enumeration	0364004	documentation Defibrillator ohne CRT-System																	
enumeration	0364005	documentation																	

	Defibrillator mit CRT-System
annotation	documentation Kat_AK_SchrittmacherDefi
source	<pre> &lt;simpleType name="enum_0364"&gt;   &lt;annotation&gt;     &lt;documentation&gt;Kat_AK_SchrittmacherDefi&lt;/documentation&gt;   &lt;/annotation&gt;   &lt;restriction base="xs:string"&gt;     &lt;enumeration value="0364001"&gt;       &lt;annotation&gt;         &lt;documentation&gt;nein&lt;/documentation&gt;       &lt;/annotation&gt;     &lt;/enumeration&gt;     &lt;enumeration value="0364002"&gt;       &lt;annotation&gt;         &lt;documentation&gt;Schrittmacher ohne CRT-System&lt;/documentation&gt;       &lt;/annotation&gt;     &lt;/enumeration&gt;     &lt;enumeration value="0364003"&gt;       &lt;annotation&gt;         &lt;documentation&gt;Schrittmacher mit CRT-System&lt;/documentation&gt;       &lt;/annotation&gt;     &lt;/enumeration&gt;     &lt;enumeration value="0364004"&gt;       &lt;annotation&gt;         &lt;documentation&gt;Defibrillator ohne CRT-System&lt;/documentation&gt;       &lt;/annotation&gt;     &lt;/enumeration&gt;     &lt;enumeration value="0364005"&gt;       &lt;annotation&gt;         &lt;documentation&gt;Defibrillator mit CRT-System&lt;/documentation&gt;       &lt;/annotation&gt;     &lt;/enumeration&gt;   &lt;/restriction&gt; &lt;/simpleType&gt; </pre>

### simpleType enum\_0365

namespace	http://xml.ir-d.de/emg		
type	restriction of <b>string</b>		
properties	base xs:string		
used by	element <a href="#">PatientenaufnahmeAortenklappeBasis/PAA RevaskularisationSchluessel</a>		
facets	Kind	Value	Annotation
	enumeration	0365001	documentation nein
	enumeration	0365002	documentation ja, operativ
	enumeration	0365003	documentation ja, interventionell
annotation	documentation Kat_AK_MyokardRevaskularisation		
source	<pre> &lt;simpleType name="enum_0365"&gt;   &lt;annotation&gt;     &lt;documentation&gt;Kat_AK_MyokardRevaskularisation&lt;/documentation&gt;   &lt;/annotation&gt;   &lt;restriction base="xs:string"&gt; </pre>		

	<pre> &lt;enumeration value="0365001"&gt;   &lt;annotation&gt;     &lt;documentation&gt;nein&lt;/documentation&gt;   &lt;/annotation&gt; &lt;/enumeration&gt; &lt;enumeration value="0365002"&gt;   &lt;annotation&gt;     &lt;documentation&gt;ja, operativ&lt;/documentation&gt;   &lt;/annotation&gt; &lt;/enumeration&gt; &lt;enumeration value="0365003"&gt;   &lt;annotation&gt;     &lt;documentation&gt;ja, interventionell&lt;/documentation&gt;   &lt;/annotation&gt; &lt;/enumeration&gt; &lt;/restriction&gt; &lt;/simpleType&gt; </pre>
--	--

### simpleType enum 0366

namespace	http://xml.ir-d.de/emg		
type	restriction of <b>string</b>		
properties	base xs:string		
used by	element <a href="#">PatientenaufnahmeAortenklappeBasis/PAA PciSchluesel</a>		
facets	Kind	Value	Annotation
	enumeration	0366001	documentation nein
	enumeration	0366002	documentation ja, &lt;= 6 Stunden
	enumeration	0366003	documentation ja, &gt; 6 Stunden bis &lt;= 3 Monate
	enumeration	0366004	documentation ja, &gt; 3 Monate
	enumeration	0366099	documentation unbekannt
annotation	documentation Kat_AK_PCI		
source	<pre> &lt;simpleType name="enum_0366"&gt;   &lt;annotation&gt;     &lt;documentation&gt;Kat_AK_PCI&lt;/documentation&gt;   &lt;/annotation&gt;   &lt;restriction base="xs:string"&gt;     &lt;enumeration value="0366001"&gt;       &lt;annotation&gt;         &lt;documentation&gt;nein&lt;/documentation&gt;       &lt;/annotation&gt;     &lt;/enumeration&gt;     &lt;enumeration value="0366002"&gt;       &lt;annotation&gt;         &lt;documentation&gt;ja, &amp;lt;= 6 Stunden&lt;/documentation&gt;       &lt;/annotation&gt;     &lt;/enumeration&gt;     &lt;enumeration value="0366003"&gt;       &lt;annotation&gt;         &lt;documentation&gt;ja, &amp;gt; 6 Stunden bis &amp;lt;= 3 Monate&lt;/documentation&gt;       &lt;/annotation&gt;     &lt;/enumeration&gt;   &lt;/restriction&gt; &lt;/simpleType&gt; </pre>		

	<pre> &lt;/enumeration&gt; &lt;enumeration value="0366004"&gt;   &lt;annotation&gt;     &lt;documentation&gt;ja, &amp;gt; 3 Monate&lt;/documentation&gt;   &lt;/annotation&gt; &lt;/enumeration&gt; &lt;enumeration value="0366099"&gt;   &lt;annotation&gt;     &lt;documentation&gt;unbekannt&lt;/documentation&gt;   &lt;/annotation&gt; &lt;/enumeration&gt; &lt;/restriction&gt; &lt;/simpleType&gt; </pre>
--	--

### simpleType enum\_0367

namespace	http://xml.ir-d.de/emg		
type	restriction of <b>string</b>		
properties	base xs:string		
used by	element <a href="#">InfektionAortenklappeBasis/IAK InfektionSchluessel</a>		
facets	Kind	Value	Annotation
	enumeration	0367001	documentation keine
	enumeration	0367002	documentation Mediastinitis
	enumeration	0367003	documentation Sepsis
	enumeration	0367004	documentation broncho-pulmonale Infektion
	enumeration	0367005	documentation oto-laryngologische Infektion
	enumeration	0367006	documentation floride Endokarditis
	enumeration	0367007	documentation Peritonitis
	enumeration	0367008	documentation Wundinfektion Thorax
	enumeration	0367009	documentation Pleuraempyem
	enumeration	0367010	documentation Venenkatheterinfektion
	enumeration	0367011	documentation Harnwegsinfektion
	enumeration	0367012	documentation Wundinfektion untere Extremitäten
	enumeration	0367013	documentation HIV-Infektion
	enumeration	0367014	documentation Hepatitis B oder C
	enumeration	0367015	documentation andere Wundinfektion
	enumeration	0367042	documentation sonstige Infektion
annotation	documentation Kat_AK_Infektion		
source	<pre> &lt;simpleType name="enum_0367"&gt;   &lt;annotation&gt;     &lt;documentation&gt;Kat_AK_Infektion&lt;/documentation&gt;   &lt;/annotation&gt; </pre>		



```
<restriction base="xs:string">
  <enumeration value="0367001">
    <annotation>
      <documentation>keine</documentation>
    </annotation>
  </enumeration>
  <enumeration value="0367002">
    <annotation>
      <documentation>Mediastinitis</documentation>
    </annotation>
  </enumeration>
  <enumeration value="0367003">
    <annotation>
      <documentation>Sepsis</documentation>
    </annotation>
  </enumeration>
  <enumeration value="0367004">
    <annotation>
      <documentation>broncho-pulmonale Infektion</documentation>
    </annotation>
  </enumeration>
  <enumeration value="0367005">
    <annotation>
      <documentation>oto-laryngologische Infektion</documentation>
    </annotation>
  </enumeration>
  <enumeration value="0367006">
    <annotation>
      <documentation>floride Endokarditis</documentation>
    </annotation>
  </enumeration>
  <enumeration value="0367007">
    <annotation>
      <documentation>Peritonitis</documentation>
    </annotation>
  </enumeration>
  <enumeration value="0367008">
    <annotation>
      <documentation>Wundinfektion Thorax</documentation>
    </annotation>
  </enumeration>
  <enumeration value="0367009">
    <annotation>
      <documentation>Pleuraempyem</documentation>
    </annotation>
  </enumeration>
  <enumeration value="0367010">
    <annotation>
      <documentation>Venenkatheterinfektion</documentation>
    </annotation>
  </enumeration>
  <enumeration value="0367011">
    <annotation>
      <documentation>Harnwegsinfektion</documentation>
    </annotation>
  </enumeration>
  <enumeration value="0367012">
    <annotation>
      <documentation>Wundinfektion untere Extremitäten</documentation>
    </annotation>
  </enumeration>
</restriction>
```

	<pre> &lt;/annotation&gt; &lt;/enumeration&gt; &lt;enumeration value="0367013"&gt;   &lt;annotation&gt;     &lt;documentation&gt;HIV-Infektion&lt;/documentation&gt;   &lt;/annotation&gt; &lt;/enumeration&gt; &lt;enumeration value="0367014"&gt;   &lt;annotation&gt;     &lt;documentation&gt;Hepatitis B oder C&lt;/documentation&gt;   &lt;/annotation&gt; &lt;/enumeration&gt; &lt;enumeration value="0367015"&gt;   &lt;annotation&gt;     &lt;documentation&gt;andere Wundinfektion&lt;/documentation&gt;   &lt;/annotation&gt; &lt;/enumeration&gt; &lt;enumeration value="0367042"&gt;   &lt;annotation&gt;     &lt;documentation&gt;sonstige Infektion&lt;/documentation&gt;   &lt;/annotation&gt; &lt;/enumeration&gt; &lt;/restriction&gt; &lt;/simpleType&gt; </pre>
--	---

### simpleType enum\_0368

namespace	http://xml.ir-d.de/emg		
type	restriction of <b>string</b>		
properties	base xs:string		
used by	element	<a href="#">PatientenaufnahmeAortenklappeBasis/PAA LungenerkrankungSchluessel</a>	
facets	Kind	Value	Annotation
	enumeration	0368001	documentation nein
	enumeration	0368002	documentation ja, COPD mit Dauermedikation
	enumeration	0368003	documentation ja, COPD ohne Dauermedikation
	enumeration	0368004	documentation ja, andere Lungenerkrankungen
	enumeration	0368099	documentation unbekannt
annotation	documentation	Kat_AK_Lungenerkrankung	
source	<pre> &lt;simpleType name="enum_0368"&gt;   &lt;annotation&gt;     &lt;documentation&gt;Kat_AK_Lungenerkrankung&lt;/documentation&gt;   &lt;/annotation&gt;   &lt;restriction base="xs:string"&gt;     &lt;enumeration value="0368001"&gt;       &lt;annotation&gt;         &lt;documentation&gt;nein&lt;/documentation&gt;       &lt;/annotation&gt;     &lt;/enumeration&gt;     &lt;enumeration value="0368002"&gt; </pre>		

	<pre> &lt;documentation&gt;ja, COPD mit Dauermedikation&lt;/documentation&gt; &lt;/annotation&gt; &lt;/enumeration&gt; &lt;enumeration value="0368003"&gt;   &lt;annotation&gt;     &lt;documentation&gt;ja, COPD ohne Dauermedikation&lt;/documentation&gt;   &lt;/annotation&gt; &lt;/enumeration&gt; &lt;enumeration value="0368004"&gt;   &lt;annotation&gt;     &lt;documentation&gt;ja, andere Lungenerkrankungen&lt;/documentation&gt;   &lt;/annotation&gt; &lt;/enumeration&gt; &lt;enumeration value="0368099"&gt;   &lt;annotation&gt;     &lt;documentation&gt;unbekannt&lt;/documentation&gt;   &lt;/annotation&gt; &lt;/enumeration&gt; &lt;/restriction&gt; &lt;/simpleType&gt; </pre>
--	---

### simpleType enum\_0369

namespace	http://xml.ir-d.de/emg		
type	restriction of <b>string</b>		
properties	base xs:string		
used by	element	<a href="#">PatientenaufnahmeKardiologieBasis/PKA_NierenersatzSchluessel</a>	
facets	Kind	Value	Annotation
	enumeration	0369001	documentation nein
	enumeration	0369002	documentation akut
	enumeration	0369003	documentation chronisch
annotation	documentation Kat_AK_Nierenersatztherapie		
source	<pre> &lt;simpleType name="enum_0369"&gt;   &lt;annotation&gt;     &lt;documentation&gt;Kat_AK_Nierenersatztherapie&lt;/documentation&gt;   &lt;/annotation&gt;   &lt;restriction base="xs:string"&gt;     &lt;enumeration value="0369001"&gt;       &lt;annotation&gt;         &lt;documentation&gt;nein&lt;/documentation&gt;       &lt;/annotation&gt;     &lt;/enumeration&gt;     &lt;enumeration value="0369002"&gt;       &lt;annotation&gt;         &lt;documentation&gt;akut&lt;/documentation&gt;       &lt;/annotation&gt;     &lt;/enumeration&gt;     &lt;enumeration value="0369003"&gt;       &lt;annotation&gt;         &lt;documentation&gt;chronisch&lt;/documentation&gt;       &lt;/annotation&gt;     &lt;/enumeration&gt;   &lt;/restriction&gt; </pre>		

	<pre> &lt;/restriction&gt; &lt;/simpleType&gt; </pre>
--	---

### simpleType enum\_0370

namespace	http://xml.ir-d.de/emg		
type	restriction of <b>string</b>		
properties	base xs:string		
used by	element <a href="#">PatientenaufnahmeAortenklappeBasis/PAA_AkoefMethodeSchluessel</a>		
facets	Kind	Value	Annotation
	enumeration	0370001	documentation Echokardiographie
	enumeration	0370002	documentation Herzkatheter
	enumeration	0370042	documentation andere
annotation	documentation Kat_AK_AKOEFMessmethode		
source	<pre> &lt;simpleType name="enum_0370"&gt;   &lt;annotation&gt;     &lt;documentation&gt;Kat_AK_AKOEFMessmethode&lt;/documentation&gt;   &lt;/annotation&gt;   &lt;restriction base="xs:string"&gt;     &lt;enumeration value="0370001"&gt;       &lt;annotation&gt;         &lt;documentation&gt;Echokardiographie&lt;/documentation&gt;       &lt;/annotation&gt;     &lt;/enumeration&gt;     &lt;enumeration value="0370002"&gt;       &lt;annotation&gt;         &lt;documentation&gt;Herzkatheter&lt;/documentation&gt;       &lt;/annotation&gt;     &lt;/enumeration&gt;     &lt;enumeration value="0370042"&gt;       &lt;annotation&gt;         &lt;documentation&gt;andere&lt;/documentation&gt;       &lt;/annotation&gt;     &lt;/enumeration&gt;   &lt;/restriction&gt; &lt;/simpleType&gt; </pre>		

### simpleType enum\_0371

namespace	http://xml.ir-d.de/emg		
type	restriction of <b>string</b>		
properties	base xs:string		
used by	element <a href="#">PatientenaufnahmeAortenklappeBasis/PAA_VerkalkungsgradSchluessel</a>		
facets	Kind	Value	Annotation
	enumeration	0371001	documentation keine
	enumeration	0371002	documentation leicht
	enumeration	0371003	documentation

	<p>enumeration 0371004 mittel documentation schwer</p> <p>enumeration 0371099 documentation unbekannt</p>
annotation	documentation Kat_AK_Verkalkungsgrad
source	<pre> &lt;simpleType name="enum_0371"&gt;   &lt;annotation&gt;     &lt;documentation&gt;Kat_AK_Verkalkungsgrad&lt;/documentation&gt;   &lt;/annotation&gt;   &lt;restriction base="xs:string"&gt;     &lt;enumeration value="0371001"&gt;       &lt;annotation&gt;         &lt;documentation&gt;keine&lt;/documentation&gt;       &lt;/annotation&gt;     &lt;/enumeration&gt;     &lt;enumeration value="0371002"&gt;       &lt;annotation&gt;         &lt;documentation&gt;leicht&lt;/documentation&gt;       &lt;/annotation&gt;     &lt;/enumeration&gt;     &lt;enumeration value="0371003"&gt;       &lt;annotation&gt;         &lt;documentation&gt;mittel&lt;/documentation&gt;       &lt;/annotation&gt;     &lt;/enumeration&gt;     &lt;enumeration value="0371004"&gt;       &lt;annotation&gt;         &lt;documentation&gt;schwer&lt;/documentation&gt;       &lt;/annotation&gt;     &lt;/enumeration&gt;     &lt;enumeration value="0371099"&gt;       &lt;annotation&gt;         &lt;documentation&gt;unbekannt&lt;/documentation&gt;       &lt;/annotation&gt;     &lt;/enumeration&gt;   &lt;/restriction&gt; &lt;/simpleType&gt; </pre>

### simpleType enum\_0372

namespace	http://xml.ir-d.de/emg		
type	restriction of <b>string</b>		
properties	base xs:string		
used by	element <a href="#">PatientenaufnahmeAortenklappeBasis/PAA_BiUnicuspideKlappeSchluessel</a>		
facets	Kind	Value	Annotation
	enumeration	0372001	documentation nein
	enumeration	0372002	documentation ja, bicuspide
	enumeration	0372003	documentation ja, unicuspide
	enumeration	0372099	documentation unbekannt
annotation	documentation Kat AK BiUnicuspideKlappe		

source	<pre> &lt;simpleType name="enum_0372"&gt;   &lt;annotation&gt;     &lt;documentation&gt;Kat_AK_BiUnicuspideKlappe&lt;/documentation&gt;   &lt;/annotation&gt;   &lt;restriction base="xs:string"&gt;     &lt;enumeration value="0372001"&gt;       &lt;annotation&gt;         &lt;documentation&gt;nein&lt;/documentation&gt;       &lt;/annotation&gt;     &lt;/enumeration&gt;     &lt;enumeration value="0372002"&gt;       &lt;annotation&gt;         &lt;documentation&gt;ja, bicuspide&lt;/documentation&gt;       &lt;/annotation&gt;     &lt;/enumeration&gt;     &lt;enumeration value="0372003"&gt;       &lt;annotation&gt;         &lt;documentation&gt;ja, unicuspide&lt;/documentation&gt;       &lt;/annotation&gt;     &lt;/enumeration&gt;     &lt;enumeration value="0372099"&gt;       &lt;annotation&gt;         &lt;documentation&gt;unbekannt&lt;/documentation&gt;       &lt;/annotation&gt;     &lt;/enumeration&gt;   &lt;/restriction&gt; &lt;/simpleType&gt; </pre>
--------	--

### simpleType enum\_0373

namespace	http://xml.lir-d.de/emg		
type	restriction of <b>string</b>		
properties	base xs:string		
used by	elements <a href="#">PatientenaufnahmeAortenklappeBasis/PAA_AorteninsuffizienzSchluessel</a> <a href="#">PatientenaufnahmeAortenklappeBasis/PAA_AortenstenoseSchluessel</a> <a href="#">PatientenaufnahmeAortenklappeBasis/PAA_MitralinsuffizienzSchluessel</a> <a href="#">PostoperationAortenklappeBasis/POA_AorteninsuffizienzSchluessel</a> <a href="#">PostoperationAortenklappeBasis/POA_MitralinsuffizienzSchluessel</a>		
facets	Kind	Value	Annotation
	enumeration	0373001	documentation keine
	enumeration	0373002	documentation leichtgradig
	enumeration	0373003	documentation mittelgradig
	enumeration	0373004	documentation hochgradig
	enumeration	0373099	documentation unbekannt
annotation	documentation Kat_AK_Grad		
source	<pre> &lt;simpleType name="enum_0373"&gt;   &lt;annotation&gt;     &lt;documentation&gt;Kat_AK_Grad&lt;/documentation&gt;   &lt;/annotation&gt;   &lt;restriction base="xs:string"&gt;     &lt;enumeration value="0373001"&gt; </pre>		

	<pre> &lt;annotation&gt;   &lt;documentation&gt;keine&lt;/documentation&gt; &lt;/annotation&gt; &lt;/enumeration&gt; &lt;enumeration value="0373002"&gt;   &lt;annotation&gt;     &lt;documentation&gt;leichtgradig&lt;/documentation&gt;   &lt;/annotation&gt; &lt;/enumeration&gt; &lt;enumeration value="0373003"&gt;   &lt;annotation&gt;     &lt;documentation&gt;mittelgradig&lt;/documentation&gt;   &lt;/annotation&gt; &lt;/enumeration&gt; &lt;enumeration value="0373004"&gt;   &lt;annotation&gt;     &lt;documentation&gt;hochgradig&lt;/documentation&gt;   &lt;/annotation&gt; &lt;/enumeration&gt; &lt;enumeration value="0373099"&gt;   &lt;annotation&gt;     &lt;documentation&gt;unbekannt&lt;/documentation&gt;   &lt;/annotation&gt; &lt;/enumeration&gt; &lt;/restriction&gt; &lt;/simpleType&gt; </pre>
--	---

#### simpleType enum\_0374

namespace	http://xml.ir-d.de/emg		
type	restriction of <b>string</b>		
properties	base xs:string		
used by	element	<a href="#">PatientenaufnahmeAortenklappeBasis/PAA MyokardinfarktSchluessel</a>	
facets	Kind	Value	Annotation
	enumeration	0374001	documentation nein
	enumeration	0374002	documentation ja, &lt;= 6 Stunden
	enumeration	0374003	documentation ja, &gt; 6 Stunden bis &lt;= 24 Stunden
	enumeration	0374004	documentation ja, &gt; 1 bis 7 Tage
	enumeration	0374005	documentation ja, &gt; 7 bis 21 Tage
	enumeration	0374006	documentation ja, &gt; 21 Tage
	enumeration	0374099	documentation unbekannt
annotation	documentation Kat_AK_InfarktAnamnese		
source	<pre> &lt;simpleType name="enum_0374"&gt;   &lt;annotation&gt;     &lt;documentation&gt;Kat_AK_InfarktAnamnese&lt;/documentation&gt;   &lt;/annotation&gt;   &lt;restriction base="xs:string"&gt;     &lt;enumeration value="0374001"&gt;       &lt;annotation&gt; </pre>		

```

    <documentation>nein</documentation>
  </annotation>
</enumeration>
<enumeration value="0374002">
  <annotation>
    <documentation>ja, &lt;= 6 Stunden</documentation>
  </annotation>
</enumeration>
<enumeration value="0374003">
  <annotation>
    <documentation>ja, &gt; 6 Stunden bis &lt;= 24 Stunden</documentation>
  </annotation>
</enumeration>
<enumeration value="0374004">
  <annotation>
    <documentation>ja, &gt; 1 bis 7 Tage</documentation>
  </annotation>
</enumeration>
<enumeration value="0374005">
  <annotation>
    <documentation>ja, &gt; 7 bis 21 Tage</documentation>
  </annotation>
</enumeration>
<enumeration value="0374006">
  <annotation>
    <documentation>ja, &gt; 21 Tage</documentation>
  </annotation>
</enumeration>
<enumeration value="0374099">
  <annotation>
    <documentation>unbekannt</documentation>
  </annotation>
</enumeration>
</restriction>
</simpleType>

```

simpleType enum 0375

namespace	http://xml.ir-d.de/emg		
type	restriction of <b>string</b>		
properties	base xs:string		
used by	element <a href="#">PatientenaufnahmeAortenklappeBasis/PAA SymptomeSchluessel</a>		
facets	Kind	Value	Annotation
	enumeration	0375001	documentation keine Symptome oder Angina
	enumeration	0375002	documentation Symptome, aber keine Ischämiezeichen
	enumeration	0375003	documentation stabile Angina
	enumeration	0375004	documentation instabile Angina
	enumeration	0375005	documentation Infarkt ohne ST-Hebung (Non-STEMI)
	enumeration	0375006	documentation Infarkt mit ST-Hebung (STEMI)
	enumeration	0375042	documentation unbekannt



annotation	documentation Kat_AK_KardialeSymptome
source	<pre> &lt;simpleType name="enum_0375"&gt;   &lt;annotation&gt;     &lt;documentation&gt;Kat_AK_KardialeSymptome&lt;/documentation&gt;   &lt;/annotation&gt;   &lt;restriction base="xs:string"&gt;     &lt;enumeration value="0375001"&gt;       &lt;annotation&gt;         &lt;documentation&gt;keine Symptome oder Angina&lt;/documentation&gt;       &lt;/annotation&gt;     &lt;/enumeration&gt;     &lt;enumeration value="0375002"&gt;       &lt;annotation&gt;         &lt;documentation&gt;Symptome, aber keine Ischämiezeichen&lt;/documentation&gt;       &lt;/annotation&gt;     &lt;/enumeration&gt;     &lt;enumeration value="0375003"&gt;       &lt;annotation&gt;         &lt;documentation&gt;stabile Angina&lt;/documentation&gt;       &lt;/annotation&gt;     &lt;/enumeration&gt;     &lt;enumeration value="0375004"&gt;       &lt;annotation&gt;         &lt;documentation&gt;instabile Angina&lt;/documentation&gt;       &lt;/annotation&gt;     &lt;/enumeration&gt;     &lt;enumeration value="0375005"&gt;       &lt;annotation&gt;         &lt;documentation&gt;Infarkt ohne ST-Hebung (Non-STEMI)&lt;/documentation&gt;       &lt;/annotation&gt;     &lt;/enumeration&gt;     &lt;enumeration value="0375006"&gt;       &lt;annotation&gt;         &lt;documentation&gt;Infarkt mit ST-Hebung (STEMI)&lt;/documentation&gt;       &lt;/annotation&gt;     &lt;/enumeration&gt;     &lt;enumeration value="0375042"&gt;       &lt;annotation&gt;         &lt;documentation&gt;unbekannt&lt;/documentation&gt;       &lt;/annotation&gt;     &lt;/enumeration&gt;   &lt;/restriction&gt; &lt;/simpleType&gt; </pre>

### simpleType enum 0376

namespace	http://xml.ir-d.de/emg		
type	restriction of <b>string</b>		
properties	base xs:string		
used by	element	<a href="#">PostoperationAortenklappeBasis/POA SchlaqanfallSchluessel</a>	
facets	Kind	Value	Annotation
	enumeration	0376001	documentation nein
	enumeration	0376002	documentation ja, ZNS, zerebrovaskuläre Blutung

	enumeration 0376003 documentation ja, ZNS, zerebrovaskuläre Ischämie enumeration 0376042 documentation ja, ZNS, andere
annotation	documentation Kat_AK_Schlaganfall
source	<pre> &lt;simpleType name="enum_0376"&gt;   &lt;annotation&gt;     &lt;documentation&gt;Kat_AK_Schlaganfall&lt;/documentation&gt;   &lt;/annotation&gt;   &lt;restriction base="xs:string"&gt;     &lt;enumeration value="0376001"&gt;       &lt;annotation&gt;         &lt;documentation&gt;nein&lt;/documentation&gt;       &lt;/annotation&gt;     &lt;/enumeration&gt;     &lt;enumeration value="0376002"&gt;       &lt;annotation&gt;         &lt;documentation&gt;ja, ZNS, zerebrovaskuläre Blutung&lt;/documentation&gt;       &lt;/annotation&gt;     &lt;/enumeration&gt;     &lt;enumeration value="0376003"&gt;       &lt;annotation&gt;         &lt;documentation&gt;ja, ZNS, zerebrovaskuläre Ischämie&lt;/documentation&gt;       &lt;/annotation&gt;     &lt;/enumeration&gt;     &lt;enumeration value="0376042"&gt;       &lt;annotation&gt;         &lt;documentation&gt;ja, ZNS, andere&lt;/documentation&gt;       &lt;/annotation&gt;     &lt;/enumeration&gt;   &lt;/restriction&gt; &lt;/simpleType&gt; </pre>

### simpleType enum 0377

namespace	http://xml.ir-d.de/emg		
type	restriction of <b>string</b>		
properties	base xs:string		
used by	element <a href="#">PostoperationAortenklappeBasis/POA_NihssSchluessel</a>		
facets	Kind	Value	Annotation
	enumeration	0377001	documentation ja, mild neurological dysfunction: NIHSS 0-5
	enumeration	0377002	documentation ja, moderate neurological dysfunction: NIHSS 6-14
	enumeration	0377003	documentation ja, severe neurological dysfunction: NIHSS >=15
annotation	documentation Kat_AK_Nihss		
source	<pre> &lt;simpleType name="enum_0377"&gt;   &lt;annotation&gt;     &lt;documentation&gt;Kat_AK_Nihss&lt;/documentation&gt;   &lt;/annotation&gt;   &lt;restriction base="xs:string"&gt;     &lt;enumeration value="0377001"&gt;       &lt;annotation&gt; </pre>		

	<pre> &lt;documentation&gt;ja, mild neurological dysfunction: NIHSS 0-5&lt;/documentation&gt; &lt;/annotation&gt; &lt;/enumeration&gt; &lt;enumeration value="0377002"&gt; &lt;annotation&gt; &lt;documentation&gt;ja, moderate neurological dysfunction: NIHSS 6-14&lt;/documentation&gt; &lt;/annotation&gt; &lt;/enumeration&gt; &lt;enumeration value="0377003"&gt; &lt;annotation&gt; &lt;documentation&gt; ja, severe neurological dysfunction: NIHSS &amp;gt;=15&lt;/documentation&gt; &lt;/annotation&gt; &lt;/enumeration&gt; &lt;/restriction&gt; &lt;/simpleType&gt; </pre>
--	--

### simpleType **enum\_0378**

namespace	http://xml.ir-d.de/emg		
type	restriction of <b>string</b>		
properties	base xs:string		
used by	element	<a href="#">PostoperationAortenklappeBasis/POA MyokardinfarktSchluessel</a>	
facets	Kind	Value	Annotation
	enumeration	0378001	documentation nein
	enumeration	0378002	documentation ja, &lt; 48h gemäss VARC-3-Definition
	enumeration	0378003	documentation ja, &gt;= 48h - &lt;= 72h gemäß VARC-3-Definition
	enumeration	0378004	documentation ja, &gt; 72 h gemäß VARC-3 Definition
annotation	documentation Kat_AK_Myokardinfarkt		
source	<pre> &lt;simpleType name="enum_0378"&gt; &lt;annotation&gt; &lt;documentation&gt;Kat_AK_Myokardinfarkt&lt;/documentation&gt; &lt;/annotation&gt; &lt;restriction base="xs:string"&gt; &lt;enumeration value="0378001"&gt; &lt;annotation&gt; &lt;documentation&gt;nein&lt;/documentation&gt; &lt;/annotation&gt; &lt;/enumeration&gt; &lt;enumeration value="0378002"&gt; &lt;annotation&gt; &lt;documentation&gt;ja, &amp;lt; 48h gemäss VARC-3-Definition&lt;/documentation&gt; &lt;/annotation&gt; &lt;/enumeration&gt; &lt;enumeration value="0378003"&gt; &lt;annotation&gt; &lt;documentation&gt;ja, &amp;gt;= 48h - &amp;lt;= 72h gemäß VARC-3-Definition&lt;/documentation&gt; &lt;/annotation&gt; </pre>		

	<pre> &lt;/enumeration&gt; &lt;enumeration value="0378004"&gt;   &lt;annotation&gt;     &lt;documentation&gt;ja, &amp;gt; 72 h gemäß VARC-3 Definition&lt;/documentation&gt;   &lt;/annotation&gt; &lt;/enumeration&gt; &lt;/restriction&gt; &lt;/simpleType&gt; </pre>
--	---

### simpleType enum\_0379

namespace	http://xml.ir-d.de/emg		
type	restriction of <b>string</b>		
properties	base xs:string		
used by	element	<a href="#">PostoperationAortenklappeBasis/POA ZugangKomplikationenSchlüssel</a>	
facets	Kind	Value	Annotation
	enumeration	0379001	documentation Keine gefäss- oder zugangsassozierte Komplikationen
	enumeration	0379002	documentation Versagen des perkutanen Verschlusssystems
	enumeration	0379003	documentation Geringfügige Gefäßkomplikationen
	enumeration	0379004	documentation Erhebliche Gefäßkomplikationen
annotation	documentation Kat_AK_ZugangKomplikationen		
source	<pre> &lt;simpleType name="enum_0379"&gt;   &lt;annotation&gt;     &lt;documentation&gt;Kat_AK_ZugangKomplikationen&lt;/documentation&gt;   &lt;/annotation&gt;   &lt;restriction base="xs:string"&gt;     &lt;enumeration value="0379001"&gt;       &lt;annotation&gt;         &lt;documentation&gt;Keine gefäss- oder zugangsassozierte Komplikationen&lt;/documentation&gt;       &lt;/annotation&gt;     &lt;/enumeration&gt;     &lt;enumeration value="0379002"&gt;       &lt;annotation&gt;         &lt;documentation&gt;Versagen des perkutanen Verschlusssystems&lt;/documentation&gt;       &lt;/annotation&gt;     &lt;/enumeration&gt;     &lt;enumeration value="0379003"&gt;       &lt;annotation&gt;         &lt;documentation&gt;Geringfügige Gefäßkomplikationen&lt;/documentation&gt;       &lt;/annotation&gt;     &lt;/enumeration&gt;     &lt;enumeration value="0379004"&gt;       &lt;annotation&gt;         &lt;documentation&gt;Erhebliche Gefäßkomplikationen&lt;/documentation&gt;       &lt;/annotation&gt;     &lt;/enumeration&gt;   &lt;/restriction&gt; &lt;/simpleType&gt; </pre>		

### simpleType enum\_0380

namespace	http://xml.ir-d.de/emg		
type	restriction of <b>string</b>		
properties	base xs:string		
used by	element <a href="#">PostoperationAortenklappeBasis/POA_ReanimationSchluessel</a>		
facets	Kind	Value	Annotation
	enumeration	0380001	documentation nein
	enumeration	0380002	documentation ja, intraprozedural
	enumeration	0380003	documentation ja, postprozedural
	enumeration	0380004	documentation ja, Zeitpunkt nicht bekannt
annotation	documentation Kat_AK_Reanimation		
source	<pre> &lt;simpleType name="enum_0380"&gt;   &lt;annotation&gt;     &lt;documentation&gt;Kat_AK_Reanimation&lt;/documentation&gt;   &lt;/annotation&gt;   &lt;restriction base="xs:string"&gt;     &lt;enumeration value="0380001"&gt;       &lt;annotation&gt;         &lt;documentation&gt;nein&lt;/documentation&gt;       &lt;/annotation&gt;     &lt;/enumeration&gt;     &lt;enumeration value="0380002"&gt;       &lt;annotation&gt;         &lt;documentation&gt;ja, intraprozedural&lt;/documentation&gt;       &lt;/annotation&gt;     &lt;/enumeration&gt;     &lt;enumeration value="0380003"&gt;       &lt;annotation&gt;         &lt;documentation&gt;ja, postprozedural&lt;/documentation&gt;       &lt;/annotation&gt;     &lt;/enumeration&gt;     &lt;enumeration value="0380004"&gt;       &lt;annotation&gt;         &lt;documentation&gt;ja, Zeitpunkt nicht bekannt&lt;/documentation&gt;       &lt;/annotation&gt;     &lt;/enumeration&gt;   &lt;/restriction&gt; &lt;/simpleType&gt; </pre>		

### simpleType enum\_0381

namespace	http://xml.ir-d.de/emg		
type	restriction of <b>string</b>		
properties	base xs:string		
used by	element <a href="#">PostoperationAortenklappeBasis/POA_MassnahmenSchluessel</a>		
facets	Kind	Value	Annotation
	enumeration	0381001	documentation nein

	enumeration 0381002 documentation Thorakotomie/Rethorakotomie enumeration 0381003 documentation kathetergestützte Reintervention enumeration 0381004 documentation lokale Reinterventionen enumeration 0381005 documentation andere Reintervention
annotation	documentation Kat_AK_Massnahmen
source	<pre> &lt;simpleType name="enum_0381"&gt;   &lt;annotation&gt;     &lt;documentation&gt;Kat_AK_Massnahmen&lt;/documentation&gt;   &lt;/annotation&gt;   &lt;restriction base="xs:string"&gt;     &lt;enumeration value="0381001"&gt;       &lt;annotation&gt;         &lt;documentation&gt;nein&lt;/documentation&gt;       &lt;/annotation&gt;     &lt;/enumeration&gt;     &lt;enumeration value="0381002"&gt;       &lt;annotation&gt;         &lt;documentation&gt;Thorakotomie/Rethorakotomie&lt;/documentation&gt;       &lt;/annotation&gt;     &lt;/enumeration&gt;     &lt;enumeration value="0381003"&gt;       &lt;annotation&gt;         &lt;documentation&gt;kathetergestützte Reintervention&lt;/documentation&gt;       &lt;/annotation&gt;     &lt;/enumeration&gt;     &lt;enumeration value="0381004"&gt;       &lt;annotation&gt;         &lt;documentation&gt;lokale Reinterventionen&lt;/documentation&gt;       &lt;/annotation&gt;     &lt;/enumeration&gt;     &lt;enumeration value="0381005"&gt;       &lt;annotation&gt;         &lt;documentation&gt;andere Reintervention&lt;/documentation&gt;       &lt;/annotation&gt;     &lt;/enumeration&gt;   &lt;/restriction&gt; &lt;/simpleType&gt; </pre>

### simpleType enum\_0382

namespace	http://xml.ir-d.de/emg		
type	restriction of <b>string</b>		
properties	base xs:string		
used by	element <a href="#">PostoperationAortenklappeBasis/POA_GrundMassnahmeSchluessel</a>		
facets	Kind	Value	Annotation
	enumeration	0382001	documentation keine Rethorakotomie / kein weiterer Grund
	enumeration	0382002	documentation Blutung/Hämatom
	enumeration	0382003	documentation Low Cardiac Output
	enumeration	0382004	documentation

	<p>enumeration 0382005 Tamponade documentation Graftprobleme, Ischämie</p> <p>enumeration 0382006 documentation Wundinfektion, Mediastinitis</p> <p>enumeration 0382007 documentation Dissektion</p> <p>enumeration 0382008 documentation Prothesendysfunktion</p> <p>enumeration 0382009 documentation instabiles Sternum</p> <p>enumeration 0382010 documentation Chylothorax</p> <p>enumeration 0382011 documentation lokale Revision im Bereich des Zugangsweges</p> <p>enumeration 0382042 documentation anderer Grund</p>
annotation	documentation Kat AK Komplikation
source	<pre> &lt;simpleType name="enum_0382"&gt;   &lt;annotation&gt;     &lt;documentation&gt;Kat_AK_Komplikation&lt;/documentation&gt;   &lt;/annotation&gt;   &lt;restriction base="xs:string"&gt;     &lt;enumeration value="0382001"&gt;       &lt;annotation&gt;         &lt;documentation&gt;keine Rethorakotomie / kein weiterer Grund&lt;/documentation&gt;       &lt;/annotation&gt;     &lt;/enumeration&gt;     &lt;enumeration value="0382002"&gt;       &lt;annotation&gt;         &lt;documentation&gt;Blutung/Hämatom&lt;/documentation&gt;       &lt;/annotation&gt;     &lt;/enumeration&gt;     &lt;enumeration value="0382003"&gt;       &lt;annotation&gt;         &lt;documentation&gt;Low Cardiac Output&lt;/documentation&gt;       &lt;/annotation&gt;     &lt;/enumeration&gt;     &lt;enumeration value="0382004"&gt;       &lt;annotation&gt;         &lt;documentation&gt;Tamponade&lt;/documentation&gt;       &lt;/annotation&gt;     &lt;/enumeration&gt;     &lt;enumeration value="0382005"&gt;       &lt;annotation&gt;         &lt;documentation&gt;Graftprobleme, Ischämie&lt;/documentation&gt;       &lt;/annotation&gt;     &lt;/enumeration&gt;     &lt;enumeration value="0382006"&gt;       &lt;annotation&gt;         &lt;documentation&gt;Wundinfektion, Mediastinitis&lt;/documentation&gt;       &lt;/annotation&gt;     &lt;/enumeration&gt;     &lt;enumeration value="0382007"&gt;       &lt;annotation&gt;         &lt;documentation&gt;Dissektion&lt;/documentation&gt;       &lt;/annotation&gt;     &lt;/enumeration&gt;   &lt;/restriction&gt; &lt;/simpleType&gt; </pre>

	<pre> &lt;enumeration value="0382008"&gt;   &lt;annotation&gt;     &lt;documentation&gt;Prothesendysfunktion&lt;/documentation&gt;   &lt;/annotation&gt; &lt;/enumeration&gt; &lt;enumeration value="0382009"&gt;   &lt;annotation&gt;     &lt;documentation&gt;instabiles Sternum&lt;/documentation&gt;   &lt;/annotation&gt; &lt;/enumeration&gt; &lt;enumeration value="0382010"&gt;   &lt;annotation&gt;     &lt;documentation&gt;Chylothorax&lt;/documentation&gt;   &lt;/annotation&gt; &lt;/enumeration&gt; &lt;enumeration value="0382011"&gt;   &lt;annotation&gt;     &lt;documentation&gt;lokale Revision im Bereich des Zugangsweges&lt;/documentation&gt;   &lt;/annotation&gt; &lt;/enumeration&gt; &lt;enumeration value="0382042"&gt;   &lt;annotation&gt;     &lt;documentation&gt;anderer Grund&lt;/documentation&gt;   &lt;/annotation&gt; &lt;/enumeration&gt; &lt;/restriction&gt; &lt;/simpleType&gt; </pre>
--	--

### simpleType enum\_0383

namespace	http://xml.ir-d.de/emg		
type	restriction of <b>string</b>		
properties	base xs:string		
used by	element	<a href="#">PostoperationAortenklappeBasis/POA AtemInsuffizienzSchluessel</a>	
facets	Kind	Value	Annotation
	enumeration	0383001	documentation nein
	enumeration	0383002	documentation ja, mit forcierter Atemtherapie
	enumeration	0383003	documentation ja, Reintubation oder längerfristige Beatmung
	enumeration	0383004	documentation ja, Tracheotomie
annotation	documentation	Kat_AK_RespiratorischeInsuffizienz	
source	<pre> &lt;simpleType name="enum_0383"&gt;   &lt;annotation&gt;     &lt;documentation&gt;Kat_AK_RespiratorischeInsuffizienz&lt;/documentation&gt;   &lt;/annotation&gt;   &lt;restriction base="xs:string"&gt;     &lt;enumeration value="0383001"&gt;       &lt;annotation&gt;         &lt;documentation&gt;nein&lt;/documentation&gt;       &lt;/annotation&gt;     &lt;/enumeration&gt;   &lt;/restriction&gt; &lt;/simpleType&gt; </pre>		



	<pre> &lt;enumeration value="0383002"&gt;   &lt;annotation&gt;     &lt;documentation&gt;ja, mit forcierter Atemtherapie&lt;/documentation&gt;   &lt;/annotation&gt; &lt;/enumeration&gt; &lt;enumeration value="0383003"&gt;   &lt;annotation&gt;     &lt;documentation&gt;ja, Reintubation oder längerfristige Beatmung&lt;/documentation&gt;   &lt;/annotation&gt; &lt;/enumeration&gt; &lt;enumeration value="0383004"&gt;   &lt;annotation&gt;     &lt;documentation&gt;ja, Tracheotomie&lt;/documentation&gt;   &lt;/annotation&gt; &lt;/enumeration&gt; &lt;/restriction&gt; &lt;/simpleType&gt; </pre>
--	---

### simpleType enum\_0384

namespace	http://xml.ir-d.de/emg		
type	restriction of <b>string</b>		
properties	base xs:string		
used by	element <a href="#">PostoperationAortenklappeBasis/POA BlutungSchlüssel</a>		
facets	Kind	Value	Annotation
	enumeration	0384001	documentation keine Blutungskomplikationen
	enumeration	0384002	documentation Geringfügige Blutung (Minor Bleeding - BARC type 2 or 3a)
	enumeration	0384003	documentation Starke Blutung (Major Bleeding - BARC type 3a)
	enumeration	0384004	documentation Lebensbedrohliche Blutung (Life-threatening or disabling bleeding - BARC type 3b or 3c or type 5)
annotation	documentation Kat_AK_Blutungskomplikation		
source	<pre> &lt;simpleType name="enum_0384"&gt;   &lt;annotation&gt;     &lt;documentation&gt;Kat_AK_Blutungskomplikation&lt;/documentation&gt;   &lt;/annotation&gt;   &lt;restriction base="xs:string"&gt;     &lt;enumeration value="0384001"&gt;       &lt;annotation&gt;         &lt;documentation&gt;keine Blutungskomplikationen&lt;/documentation&gt;       &lt;/annotation&gt;     &lt;/enumeration&gt;     &lt;enumeration value="0384002"&gt;       &lt;annotation&gt;         &lt;documentation&gt;Geringfügige Blutung (Minor Bleeding - BARC type 2 or 3a)&lt;/documentation&gt;       &lt;/annotation&gt;     &lt;/enumeration&gt;     &lt;enumeration value="0384003"&gt;       &lt;annotation&gt;         &lt;documentation&gt;Starke Blutung (Major Bleeding - BARC type </pre>		

	<pre> 3a) &lt;/documentation&gt;     &lt;/annotation&gt;   &lt;/enumeration&gt;   &lt;enumeration value="0384004"&gt;     &lt;annotation&gt;       &lt;documentation&gt;Lebensbedrohliche Blutung (Life-threatening or disabling bleeding - BARC type 3b or 3c or type 5)&lt;/documentation&gt;     &lt;/annotation&gt;   &lt;/enumeration&gt; &lt;/restriction&gt; &lt;/simpleType&gt; </pre>
--	--

### simpleType enum\_0385

namespace	http://xml.ir-d.de/emg		
type	restriction of <b>string</b>		
properties	base xs:string		
used by	element	<a href="#">PostoperationAortenklappeBasis/POA HerzrhythmusSchluessel</a>	
facets	Kind	Value	Annotation
	enumeration	0385001	documentation Sinusrhythmus
	enumeration	0385002	documentation Vorhofflimmern
	enumeration	0385003	documentation Patient verstorben (kein Herzrhythmus)
	enumeration	0385042	documentation anderer Rhythmus
annotation	documentation Kat_AK_HerzrhythmusEntlassung		
source	<pre> &lt;simpleType name="enum_0385"&gt;   &lt;annotation&gt;     &lt;documentation&gt;Kat_AK_HerzrhythmusEntlassung&lt;/documentation&gt;   &lt;/annotation&gt;   &lt;restriction base="xs:string"&gt;     &lt;enumeration value="0385001"&gt;       &lt;annotation&gt;         &lt;documentation&gt;Sinusrhythmus&lt;/documentation&gt;       &lt;/annotation&gt;     &lt;/enumeration&gt;     &lt;enumeration value="0385002"&gt;       &lt;annotation&gt;         &lt;documentation&gt;Vorhofflimmern&lt;/documentation&gt;       &lt;/annotation&gt;     &lt;/enumeration&gt;     &lt;enumeration value="0385003"&gt;       &lt;annotation&gt;         &lt;documentation&gt;Patient verstorben (kein Herzrhythmus)&lt;/documentation&gt;       &lt;/annotation&gt;     &lt;/enumeration&gt;     &lt;enumeration value="0385042"&gt;       &lt;annotation&gt;         &lt;documentation&gt;anderer Rhythmus&lt;/documentation&gt;       &lt;/annotation&gt;     &lt;/enumeration&gt;   &lt;/restriction&gt; &lt;/simpleType&gt; </pre>		

### simpleType enum 0388

namespace	http://xml.ir-d.de/emg		
type	restriction of <b>string</b>		
properties	base xs:string		
used by	element <a href="#">PostoperationAortenklappeBasis/POA AggregationshemmerSchluessel</a>		
facets	Kind	Value	Annotation
	enumeration	0388001	documentation nein
	enumeration	0388002	documentation ASS
	enumeration	0388003	documentation ADP-Rezeptor-Antagonist
	enumeration	0388004	documentation Kombination ASS und ADP-Rezeptor-Antagonist
	enumeration	0388042	documentation ja, andere
	enumeration	0388099	documentation unbekannt
annotation	documentation Kat_AK_Plaettchenaggregationshemmer		
source	<pre> &lt;simpleType name="enum_0388"&gt;   &lt;annotation&gt;     &lt;documentation&gt;Kat_AK_Plaettchenaggregationshemmer&lt;/documentation&gt;   &lt;/annotation&gt;   &lt;restriction base="xs:string"&gt;     &lt;enumeration value="0388001"&gt;       &lt;annotation&gt;         &lt;documentation&gt;nein&lt;/documentation&gt;       &lt;/annotation&gt;     &lt;/enumeration&gt;     &lt;enumeration value="0388002"&gt;       &lt;annotation&gt;         &lt;documentation&gt;ASS&lt;/documentation&gt;       &lt;/annotation&gt;     &lt;/enumeration&gt;     &lt;enumeration value="0388003"&gt;       &lt;annotation&gt;         &lt;documentation&gt;ADP-Rezeptor-Antagonist&lt;/documentation&gt;       &lt;/annotation&gt;     &lt;/enumeration&gt;     &lt;enumeration value="0388004"&gt;       &lt;annotation&gt;         &lt;documentation&gt;Kombination ASS und ADP-Rezeptor-Antagonist&lt;/documentation&gt;       &lt;/annotation&gt;     &lt;/enumeration&gt;     &lt;enumeration value="0388042"&gt;       &lt;annotation&gt;         &lt;documentation&gt;ja, andere&lt;/documentation&gt;       &lt;/annotation&gt;     &lt;/enumeration&gt;     &lt;enumeration value="0388099"&gt;       &lt;annotation&gt;         &lt;documentation&gt;unbekannt&lt;/documentation&gt;       &lt;/annotation&gt;     &lt;/enumeration&gt;   &lt;/restriction&gt; </pre>		

	<pre> &lt;/enumeration&gt; &lt;/restriction&gt; &lt;/simpleType&gt; </pre>
--	--

### simpleType enum\_0389

namespace	http://xml.ir-d.de/emg		
type	restriction of <b>string</b>		
properties	base xs:string		
used by	element <a href="#">AntikoagulansAortenklappeBasis/AKA AntikoagulansSchluessel</a>		
facets	Kind	Value	Annotation
	enumeration	0389001	documentation nein
	enumeration	0389002	documentation Cumarin-Derivate
	enumeration	0389003	documentation Heparinoide
	enumeration	0389004	documentation orale Thrombinantagonisten
	enumeration	0389005	documentation Kombination Heparinoide und Cumarin-Derivate
	enumeration	0389006	documentation Direkte orale Antikoagulantien (DOAK / NOAK)
	enumeration	0389042	documentation ja, andere
	enumeration	0389099	documentation unbekannt
annotation	documentation Kat_AK_Antikoagulantien		
source	<pre> &lt;simpleType name="enum_0389"&gt;   &lt;annotation&gt;     &lt;documentation&gt;Kat_AK_Antikoagulantien&lt;/documentation&gt;   &lt;/annotation&gt;   &lt;restriction base="xs:string"&gt;     &lt;enumeration value="0389001"&gt;       &lt;annotation&gt;         &lt;documentation&gt;nein&lt;/documentation&gt;       &lt;/annotation&gt;     &lt;/enumeration&gt;     &lt;enumeration value="0389002"&gt;       &lt;annotation&gt;         &lt;documentation&gt;Cumarin-Derivate&lt;/documentation&gt;       &lt;/annotation&gt;     &lt;/enumeration&gt;     &lt;enumeration value="0389003"&gt;       &lt;annotation&gt;         &lt;documentation&gt;Heparinoide&lt;/documentation&gt;       &lt;/annotation&gt;     &lt;/enumeration&gt;     &lt;enumeration value="0389004"&gt;       &lt;annotation&gt;         &lt;documentation&gt;orale Thrombinantagonisten&lt;/documentation&gt;       &lt;/annotation&gt;     &lt;/enumeration&gt;     &lt;enumeration value="0389005"&gt;       &lt;annotation&gt;         &lt;documentation&gt;Kombination Heparinoide und </pre>		

	<pre> Cumarin-Derivate&lt;/documentation&gt;   &lt;/annotation&gt; &lt;/enumeration&gt; &lt;enumeration value="0389006"&gt;   &lt;annotation&gt;     &lt;documentation&gt;Direkte orale Antikoagulantien (DOAK / NOAK)&lt;/documentation&gt;   &lt;/annotation&gt; &lt;/enumeration&gt; &lt;enumeration value="0389042"&gt;   &lt;annotation&gt;     &lt;documentation&gt;ja, andere&lt;/documentation&gt;   &lt;/annotation&gt; &lt;/enumeration&gt; &lt;enumeration value="0389099"&gt;   &lt;annotation&gt;     &lt;documentation&gt;unbekannt&lt;/documentation&gt;   &lt;/annotation&gt; &lt;/enumeration&gt; &lt;/restriction&gt; &lt;/simpleType&gt; </pre>
--	--

### simpleType enum 0390

namespace	http://xml.ir-d.de/emg		
type	restriction of <b>string</b>		
properties	base xs:string		
used by	element <a href="#">ArtikelAortenklappeBasis/AAK ArtikelTypSchluessel</a>		
facets	Kind	Value	Annotation
	enumeration	0390001	documentation biologisches Klappenmodell
	enumeration	0390002	documentation mechanisches Klappenmodell
annotation	documentation Kat_AK_Artikeltyp		
source	<pre> &lt;simpleType name="enum_0390"&gt;   &lt;annotation&gt;     &lt;documentation&gt;Kat_AK_Artikeltyp&lt;/documentation&gt;   &lt;/annotation&gt;   &lt;restriction base="xs:string"&gt;     &lt;enumeration value="0390001"&gt;       &lt;annotation&gt;         &lt;documentation&gt;biologisches Klappenmodell&lt;/documentation&gt;       &lt;/annotation&gt;     &lt;/enumeration&gt;     &lt;enumeration value="0390002"&gt;       &lt;annotation&gt;         &lt;documentation&gt;mechanisches Klappenmodell&lt;/documentation&gt;       &lt;/annotation&gt;     &lt;/enumeration&gt;   &lt;/restriction&gt; &lt;/simpleType&gt; </pre>		

### simpleType enum\_0398

namespace	http://xml.ir-d.de/emg		
type	restriction of <b>string</b>		
properties	base xs:string		
used by	element <a href="#">PostoperationAortenklappeBasis/POA TodesursacheSchluessel</a>		
facets	Kind	Value	Annotation
	enumeration	0398001	documentation kardiovaskuläre Ursache
	enumeration	0398002	documentation nicht-kardiovaskuläre Ursache
	enumeration	0398099	documentation Todesursache unbekannt
annotation	documentation Kat_AK_Todesursache		
source	<pre> &lt;simpleType name="enum_0398"&gt;   &lt;annotation&gt;     &lt;documentation&gt;Kat_AK_Todesursache&lt;/documentation&gt;   &lt;/annotation&gt;   &lt;restriction base="xs:string"&gt;     &lt;enumeration value="0398001"&gt;       &lt;annotation&gt;         &lt;documentation&gt;kardiovaskuläre Ursache&lt;/documentation&gt;       &lt;/annotation&gt;     &lt;/enumeration&gt;     &lt;enumeration value="0398002"&gt;       &lt;annotation&gt;         &lt;documentation&gt;nicht-kardiovaskuläre Ursache&lt;/documentation&gt;       &lt;/annotation&gt;     &lt;/enumeration&gt;     &lt;enumeration value="0398099"&gt;       &lt;annotation&gt;         &lt;documentation&gt;Todesursache unbekannt&lt;/documentation&gt;       &lt;/annotation&gt;     &lt;/enumeration&gt;   &lt;/restriction&gt; &lt;/simpleType&gt; </pre>		

### simpleType enum\_0399

namespace	http://xml.ir-d.de/emg		
type	restriction of <b>string</b>		
properties	base xs:string		
used by	element <a href="#">PostoperationAortenklappeBasis/POA VitalstatusSchluessel</a>		
facets	Kind	Value	Annotation
	enumeration	0399001	documentation Patient lebt
	enumeration	0399002	documentation Patient im Krankenhaus verstorben
annotation	documentation Kat_AK_Vitalstatus		
source	<pre> &lt;simpleType name="enum_0399"&gt;   &lt;annotation&gt;     &lt;documentation&gt;Kat_AK_Vitalstatus&lt;/documentation&gt;   &lt;/annotation&gt; </pre>		

	<pre> &lt;restriction base="xs:string"&gt;   &lt;enumeration value="0399001"&gt;     &lt;annotation&gt;       &lt;documentation&gt;Patient lebt&lt;/documentation&gt;     &lt;/annotation&gt;   &lt;/enumeration&gt;   &lt;enumeration value="0399002"&gt;     &lt;annotation&gt;       &lt;documentation&gt;Patient im Krankenhaus verstorben&lt;/documentation&gt;     &lt;/annotation&gt;   &lt;/enumeration&gt; &lt;/restriction&gt; &lt;/simpleType&gt; </pre>
--	---

### complexType **PatientenaufnahmeBasis**

diagram	
namespace	http://xml.ir-d.de/emg
children	<a href="#">PAT_Alter</a> <a href="#">PAT_Groesse</a> <a href="#">PAT_Gewicht</a> <a href="#">PAT_GeschlechtSchluessel</a>
used by	complexType <a href="#">Patientenaufnahme</a>
source	<pre> &lt;complexType name="PatientenaufnahmeBasis"&gt;   &lt;sequence&gt;     &lt;element name="PAT_Alter" type="xs:integer"/&gt;     &lt;element name="PAT_Groesse" type="xs:integer" minOccurs="0"/&gt;     &lt;element name="PAT_Gewicht" type="xs:integer" minOccurs="0"/&gt;     &lt;element name="PAT_GeschlechtSchluessel" type="enum_0070"/&gt;   &lt;/sequence&gt; &lt;/complexType&gt; </pre>

### element **PatientenaufnahmeBasis/PAT\_Alter**

diagram	
type	<b>integer</b>
properties	content simple
source	<pre>&lt;element name="PAT_Alter" type="xs:integer"/&gt;</pre>

element **PatientenaufnahmeBasis/PAT\_Groesse**

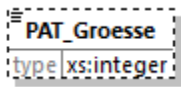
diagram	
type	<b>integer</b>
properties	minOcc 0 maxOcc 1 content simple
source	<code>&lt;element name="PAT_Groesse" type="xs:integer" minOccurs="0"/&gt;</code>

element **PatientenaufnahmeBasis/PAT\_Gewicht**

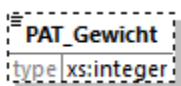
diagram	
type	<b>integer</b>
properties	minOcc 0 maxOcc 1 content simple
source	<code>&lt;element name="PAT_Gewicht" type="xs:integer" minOccurs="0"/&gt;</code>

element **PatientenaufnahmeBasis/PAT\_GeschlechtSchluessel**

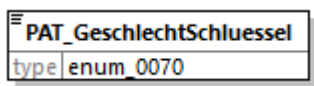
diagram																
type	<b>enum 0070</b>															
properties	content simple															
facets	<table border="1"> <thead> <tr> <th>Kind</th> <th>Value</th> <th>Annotation</th> </tr> </thead> <tbody> <tr> <td>enumeration</td> <td>0070001</td> <td>documentation weiblich</td> </tr> <tr> <td>enumeration</td> <td>0070002</td> <td>documentation männlich</td> </tr> <tr> <td>enumeration</td> <td>0070003</td> <td>documentation divers</td> </tr> <tr> <td>enumeration</td> <td>0070042</td> <td>documentation unbestimmt</td> </tr> </tbody> </table>	Kind	Value	Annotation	enumeration	0070001	documentation weiblich	enumeration	0070002	documentation männlich	enumeration	0070003	documentation divers	enumeration	0070042	documentation unbestimmt
Kind	Value	Annotation														
enumeration	0070001	documentation weiblich														
enumeration	0070002	documentation männlich														
enumeration	0070003	documentation divers														
enumeration	0070042	documentation unbestimmt														
source	<code>&lt;element name="PAT_GeschlechtSchluessel" type="enum_0070"/&gt;</code>															

complexType **PatientenaufnahmeBrustimplantatBasis**

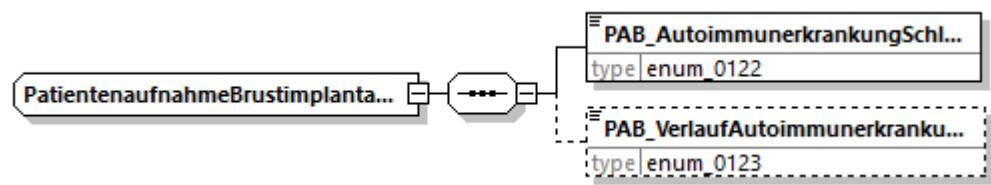
diagram	
namespace	http://xml.ir-d.de/emg
children	<a href="#">PAB AutoimmunerkrankungSchluessel</a> <a href="#">PAB VerlaufAutoimmunerkrankungSchluessel</a>



used by	element <a href="#">Patientenaufnahme/patientenaufnahmeBrustimplantat</a>
source	<pre>&lt;complexType name="PatientenaufnahmeBrustimplantatBasis"&gt;   &lt;sequence&gt;     &lt;element name="PAB_AutoimmunerkrankungSchluessel" type="enum_0122"/&gt;     &lt;element name="PAB_VerlaufAutoimmunerkrankungSchluessel" type="enum_0123" minOccurs="0"/&gt;   &lt;/sequence&gt; &lt;/complexType&gt;</pre>

element [PatientenaufnahmeBrustimplantatBasis/PAB\\_AutoimmunerkrankungSchluessel](#)

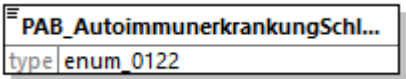
diagram													
type	<a href="#">enum 0122</a>												
properties	content simple												
facets	<table border="1"> <thead> <tr> <th>Kind</th> <th>Value</th> <th>Annotation</th> </tr> </thead> <tbody> <tr> <td>enumeration</td> <td>0122001</td> <td>documentation ja, ärztlich nachgewiesen</td> </tr> <tr> <td>enumeration</td> <td>0122002</td> <td>documentation nein</td> </tr> <tr> <td>enumeration</td> <td>0122042</td> <td>documentation unbekannt</td> </tr> </tbody> </table>	Kind	Value	Annotation	enumeration	0122001	documentation ja, ärztlich nachgewiesen	enumeration	0122002	documentation nein	enumeration	0122042	documentation unbekannt
Kind	Value	Annotation											
enumeration	0122001	documentation ja, ärztlich nachgewiesen											
enumeration	0122002	documentation nein											
enumeration	0122042	documentation unbekannt											
source	<pre>&lt;element name="PAB_AutoimmunerkrankungSchluessel" type="enum_0122"/&gt;</pre>												

element [PatientenaufnahmeBrustimplantatBasis/PAB\\_VerlaufAutoimmunerkrankungSchluessel](#)

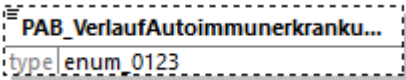
diagram																			
type	<a href="#">enum 0123</a>																		
properties	minOcc 0 maxOcc 1 content simple																		
facets	<table border="1"> <thead> <tr> <th>Kind</th> <th>Value</th> <th>Annotation</th> </tr> </thead> <tbody> <tr> <td>enumeration</td> <td>0123001</td> <td>documentation neu aufgetreten</td> </tr> <tr> <td>enumeration</td> <td>0123002</td> <td>documentation verschlechtert</td> </tr> <tr> <td>enumeration</td> <td>0123003</td> <td>documentation keine Veränderung</td> </tr> <tr> <td>enumeration</td> <td>0123004</td> <td>documentation nicht relevant, da Primäreingriff</td> </tr> <tr> <td>enumeration</td> <td>0123042</td> <td>documentation unbekannt</td> </tr> </tbody> </table>	Kind	Value	Annotation	enumeration	0123001	documentation neu aufgetreten	enumeration	0123002	documentation verschlechtert	enumeration	0123003	documentation keine Veränderung	enumeration	0123004	documentation nicht relevant, da Primäreingriff	enumeration	0123042	documentation unbekannt
Kind	Value	Annotation																	
enumeration	0123001	documentation neu aufgetreten																	
enumeration	0123002	documentation verschlechtert																	
enumeration	0123003	documentation keine Veränderung																	
enumeration	0123004	documentation nicht relevant, da Primäreingriff																	
enumeration	0123042	documentation unbekannt																	
source	<pre>&lt;element name="PAB_VerlaufAutoimmunerkrankungSchluessel" type="enum_0123" minOccurs="0"/&gt;</pre>																		

complexType **PatientenaufnahmeKardiologie**

<p>diagram</p>	
<p>namespace</p>	<p>http://xml.ir-d.de/emg</p>
<p>type</p>	<p>extension of <a href="#">PatientenaufnahmeKardiologieBasis</a></p>
<p>properties</p>	<p>base <a href="#">PatientenaufnahmeKardiologieBasis</a></p>
<p>children</p>	<p><a href="#">PKA_NyhaSchluessel</a> <a href="#">PKA_Lvef</a> <a href="#">PKA_LvefUnbekannt</a> <a href="#">PKA_DiabetesSchluessel</a> <a href="#">PKA_NierenersatzSchluessel</a> <a href="#">PKA_KreatininwertMgdl</a> <a href="#">PKA_KreatininwertMikromol</a> <a href="#">PKA_KreatininwertUnbekannt</a> <a href="#">patientenaufnahmeAortenklappe</a></p>
<p>used by</p>	<p>element <a href="#">Patientenaufnahme/patientenaufnahmeKardiologie</a></p>
<p>source</p>	<pre> &lt;complexType name="PatientenaufnahmeKardiologie"&gt;   &lt;complexContent&gt;     &lt;extension base="PatientenaufnahmeKardiologieBasis"&gt;       &lt;sequence&gt;         &lt;element name="patientenaufnahmeAortenklappe" type="PatientenaufnahmeAortenkla..."/&gt;       &lt;/sequence&gt;     &lt;/extension&gt;   &lt;/complexContent&gt; &lt;/complexType&gt; </pre>

element **PatientenaufnahmeKardiologie/patientenaufnahmeAortenklappe**

diagram

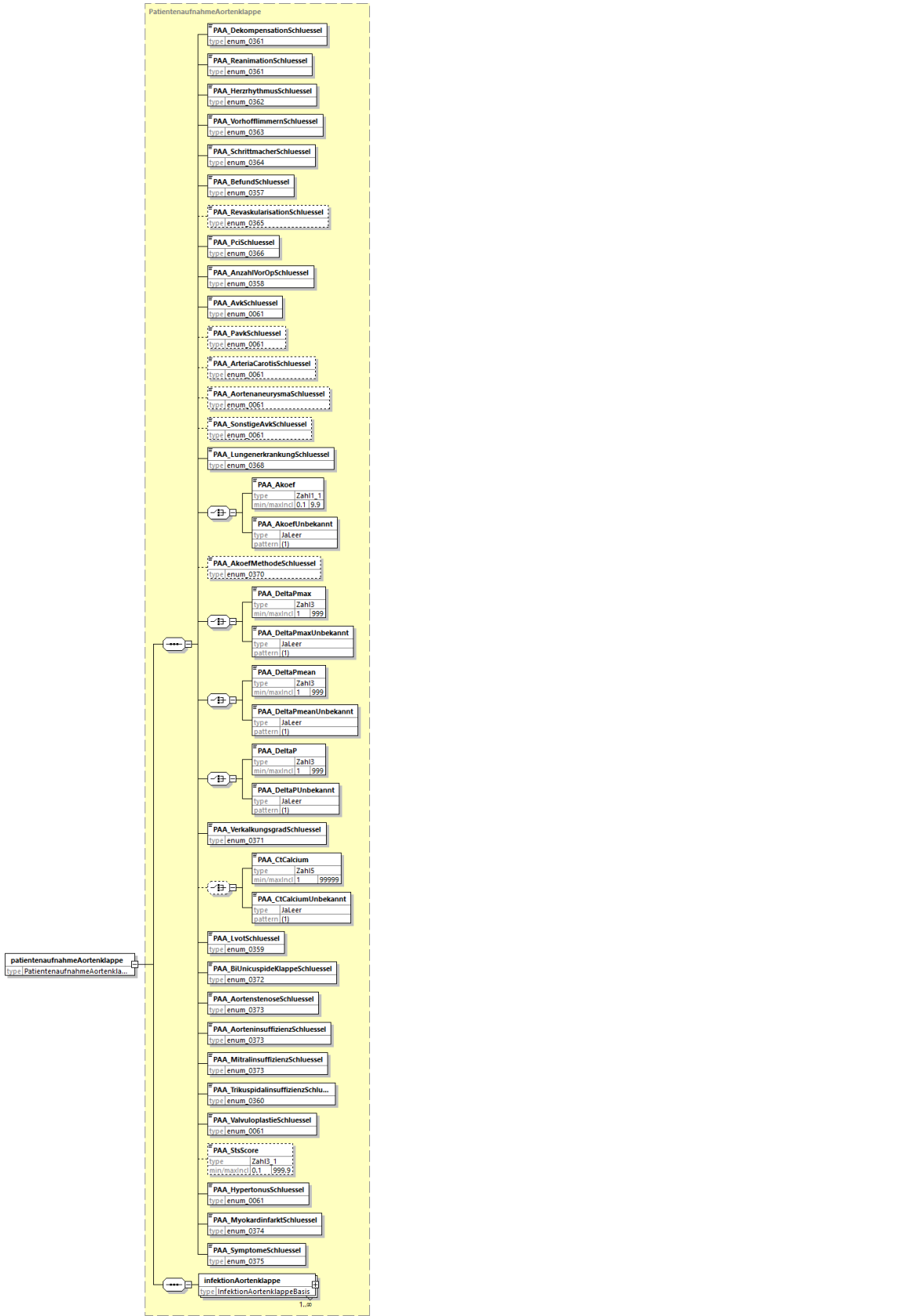

patientenaufnahmeAortenklappe  
type PatientenaufnahmeAortenkla...

type **PatientenaufnahmeAortenklappe**

properties content complex

children	<a href="#">PAA DekompensationSchluessel</a> <a href="#">PAA ReanimationSchluessel</a> <a href="#">PAA HerzrhythmusSchluessel</a> <a href="#">PAA VorhofflimmernSchluessel</a> <a href="#">PAA SchrittmacherSchluessel</a> <a href="#">PAA BefundSchluessel</a> <a href="#">PAA RevaskularisationSchluessel</a> <a href="#">PAA PciSchluessel</a> <a href="#">PAA AnzahlVorOpSchluessel</a> <a href="#">PAA AvkSchluessel</a> <a href="#">PAA PavkSchluessel</a> <a href="#">PAA ArteriaCarotisSchluessel</a> <a href="#">PAA AortenaneurysmaSchluessel</a> <a href="#">PAA SonstigeAvkSchluessel</a> <a href="#">PAA LungenerkrankungSchluessel</a> <a href="#">PAA Akoef</a> <a href="#">PAA AkoefUnbekannt</a> <a href="#">PAA AkoefMethodeSchluessel</a> <a href="#">PAA DeltaPmax</a> <a href="#">PAA DeltaPmaxUnbekannt</a> <a href="#">PAA DeltaPmean</a> <a href="#">PAA DeltaPmeanUnbekannt</a> <a href="#">PAA DeltaP</a> <a href="#">PAA DeltaPUnbekannt</a> <a href="#">PAA VerkalkungsgradSchluessel</a> <a href="#">PAA CtCalcium</a> <a href="#">PAA CtCalciumUnbekannt</a> <a href="#">PAA LvotSchluessel</a> <a href="#">PAA BiUnicuspideKlappeSchluessel</a> <a href="#">PAA AortenstenoseSchluessel</a> <a href="#">PAA AorteninsuffizienzSchluessel</a> <a href="#">PAA MitralinsuffizienzSchluessel</a> <a href="#">PAA TrikuspidalinsuffizienzSchluessel</a> <a href="#">PAA ValvuloplastieSchluessel</a> <a href="#">PAA StsScore</a> <a href="#">PAA HypertonusSchluessel</a> <a href="#">PAA MyokardinfarktSchluessel</a> <a href="#">PAA SymptomeSchluessel</a> <a href="#">infektionAortenklappe</a>
source	<pre>&lt;element name="patientenaufnahmeAortenklappe" type="PatientenaufnahmeAortenklappe"/&gt;</pre>

### complexType **OperationBasis**

diagram	
namespace	http://xml.ir-d.de/emg
children	<a href="#">OPE LaufendeNumer</a> <a href="#">OPE Datum</a> <a href="#">OPE SeitenLokalisationSchluessel</a> <a href="#">OPE AsaSchluessel</a> <a href="#">OPE ImplantattypSchluessel</a>
used by	complexType <a href="#">Operation</a>
source	<pre>&lt;complexType name="OperationBasis"&gt;   &lt;sequence&gt;     &lt;element name="OPE_LaufendeNumer" type="Zahl3"/&gt;     &lt;element name="OPE_Datum" type="xs:date"/&gt;     &lt;element name="OPE_SeitenLokalisationSchluessel" type="enum_0050" minOccurs="0"/&gt;     &lt;element name="OPE_AsaSchluessel" type="enum_0044"/&gt;     &lt;element name="OPE_ImplantattypSchluessel" type="enum_0080"/&gt;   &lt;/sequence&gt; &lt;/complexType&gt;</pre>

### element **OperationBasis/OPE\_LaufendeNumer**

diagram	
---------	--

type	<a href="#">Zahl3</a>									
properties	content simple									
facets	<table border="1"> <thead> <tr> <th>Kind</th> <th>Value</th> <th>Annotation</th> </tr> </thead> <tbody> <tr> <td>minInclusive</td> <td>1</td> <td></td> </tr> <tr> <td>maxInclusive</td> <td>999</td> <td></td> </tr> </tbody> </table>	Kind	Value	Annotation	minInclusive	1		maxInclusive	999	
Kind	Value	Annotation								
minInclusive	1									
maxInclusive	999									
source	<code>&lt;element name="OPE_LaufendeNummer" type="Zahl3"/&gt;</code>									

#### element **OperationBasis/OPE\_Datum**

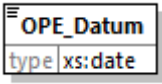
diagram	
type	<b>date</b>
properties	content simple
source	<code>&lt;element name="OPE_Datum" type="xs:date"/&gt;</code>

#### element **OperationBasis/OPE\_SeitenLokalisationSchluessel**

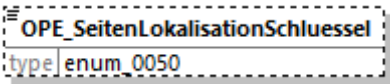
diagram										
type	<a href="#">enum_0050</a>									
properties	<table border="1"> <tbody> <tr> <td>minOcc</td> <td>0</td> </tr> <tr> <td>maxOcc</td> <td>1</td> </tr> <tr> <td>content</td> <td>simple</td> </tr> </tbody> </table>	minOcc	0	maxOcc	1	content	simple			
minOcc	0									
maxOcc	1									
content	simple									
facets	<table border="1"> <thead> <tr> <th>Kind</th> <th>Value</th> <th>Annotation</th> </tr> </thead> <tbody> <tr> <td>enumeration</td> <td>0050001</td> <td>documentation rechts</td> </tr> <tr> <td>enumeration</td> <td>0050002</td> <td>documentation links</td> </tr> </tbody> </table>	Kind	Value	Annotation	enumeration	0050001	documentation rechts	enumeration	0050002	documentation links
Kind	Value	Annotation								
enumeration	0050001	documentation rechts								
enumeration	0050002	documentation links								
source	<code>&lt;element name="OPE_SeitenLokalisationSchluessel" type="enum_0050" minOccurs="0"/&gt;</code>									

#### element **OperationBasis/OPE\_AsaSchluessel**

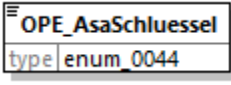
diagram																
type	<a href="#">enum_0044</a>															
properties	content simple															
facets	<table border="1"> <thead> <tr> <th>Kind</th> <th>Value</th> <th>Annotation</th> </tr> </thead> <tbody> <tr> <td>enumeration</td> <td>0044001</td> <td>documentation 1= normaler, sonst gesunder Patient</td> </tr> <tr> <td>enumeration</td> <td>0044002</td> <td>documentation 2= Patient mit leichter Allgemeinerkrankung</td> </tr> <tr> <td>enumeration</td> <td>0044003</td> <td>documentation 3= Patient mit schwerer Allgemeinerkrankung</td> </tr> <tr> <td>enumeration</td> <td>0044004</td> <td>documentation 4= Patient mit schwerer Allgemeinerkrankung, die eine ständige Lebensbedrohung darstellt</td> </tr> </tbody> </table>	Kind	Value	Annotation	enumeration	0044001	documentation 1= normaler, sonst gesunder Patient	enumeration	0044002	documentation 2= Patient mit leichter Allgemeinerkrankung	enumeration	0044003	documentation 3= Patient mit schwerer Allgemeinerkrankung	enumeration	0044004	documentation 4= Patient mit schwerer Allgemeinerkrankung, die eine ständige Lebensbedrohung darstellt
Kind	Value	Annotation														
enumeration	0044001	documentation 1= normaler, sonst gesunder Patient														
enumeration	0044002	documentation 2= Patient mit leichter Allgemeinerkrankung														
enumeration	0044003	documentation 3= Patient mit schwerer Allgemeinerkrankung														
enumeration	0044004	documentation 4= Patient mit schwerer Allgemeinerkrankung, die eine ständige Lebensbedrohung darstellt														

	enumeration 0044005 documentation 5= moribunder Patient, der ohne die Operation voraussichtlich nicht überleben wird
source	<element name="OPE_AsaSchluessel" type="enum_0044"/>

element **OperationBasis/OPE\_ImplantattypSchluessel**

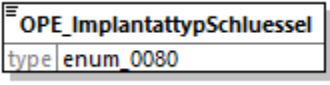
diagram			
type	<a href="#">enum_0080</a>		
properties	content simple		
facets	Kind	Value	Annotation
	enumeration	0080001	documentation Endoprothese Hüfte/Knie
	enumeration	0080002	documentation Brustimplantat
	enumeration	0080003	documentation Aortenklappenprothese
source	<element name="OPE_ImplantattypSchluessel" type="enum_0080"/>		

complexType **OperationBrustimplantat**

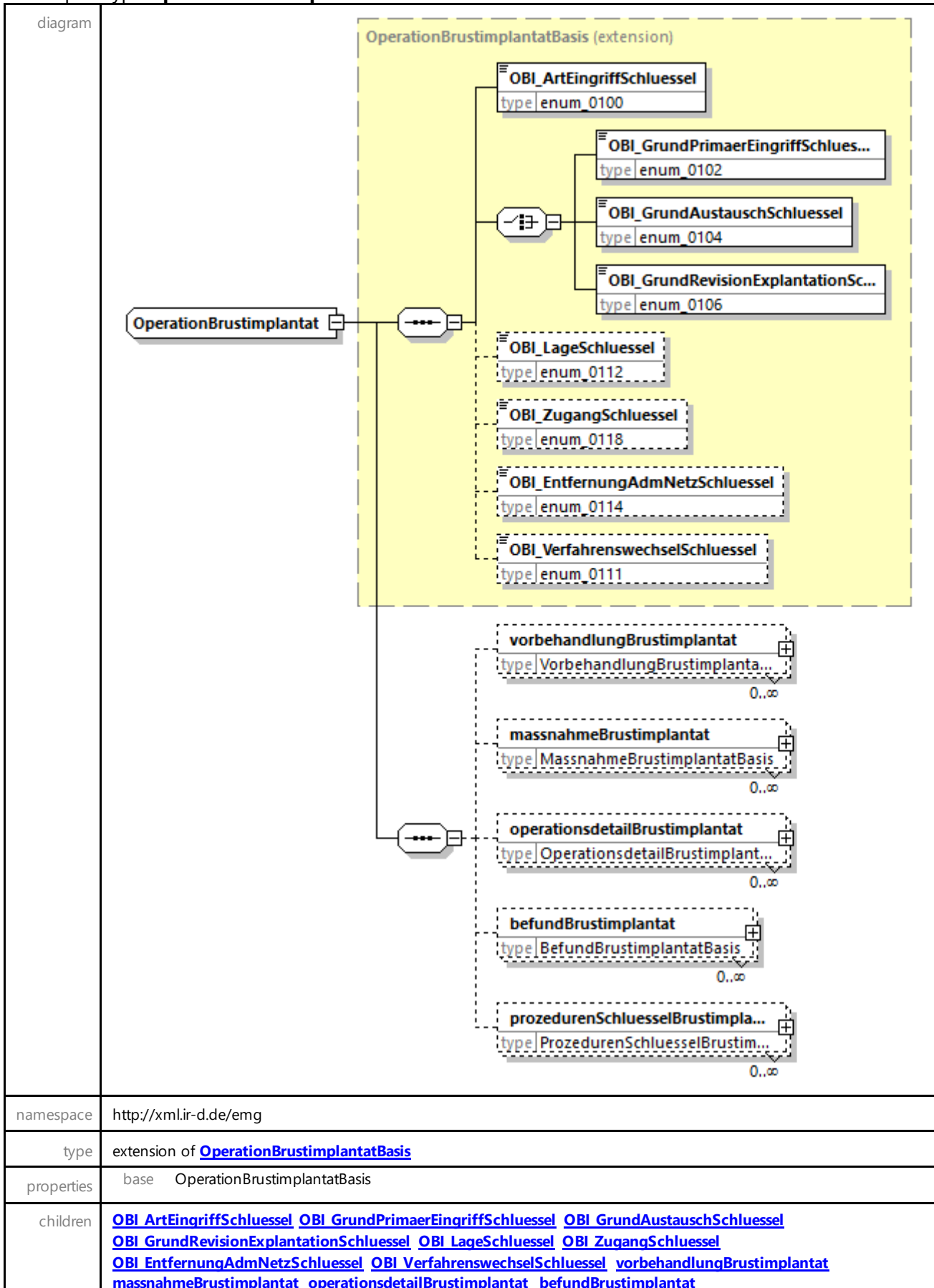

	<a href="#">prozedurenSchluesselBrustimplantat</a>
used by	element <a href="#">Operation/operationBrustimplantat</a>
source	<pre> &lt;complexType name="OperationBrustimplantat"&gt;   &lt;complexContent&gt;     &lt;extension base="OperationBrustimplantatBasis"&gt;       &lt;sequence&gt;         &lt;element name="vorbehandlungBrustimplantat" type="VorbehandlungBrustimplantatBasis" minOccurs="0" maxOccurs="unbounded"/&gt;         &lt;element name="massnahmeBrustimplantat" type="MassnahmeBrustimplantatBasis" minOccurs="0" maxOccurs="unbounded"/&gt;         &lt;element name="operationsdetailBrustimplantat" type="OperationsdetailBrustimplantatBasis" minOccurs="0" maxOccurs="unbounded"/&gt;         &lt;element name="befundBrustimplantat" type="BefundBrustimplantatBasis" minOccurs="0" maxOccurs="unbounded"/&gt;         &lt;element name="prozedurenSchluesselBrustimplantat" type="ProzedurenSchluesselBrustimplantatBasis" minOccurs="0" maxOccurs="unbounded"/&gt;       &lt;/sequence&gt;     &lt;/extension&gt;   &lt;/complexContent&gt; &lt;/complexType&gt; </pre>

element **OperationBrustimplantat/vorbehandlungBrustimplantat**

diagram	
type	<a href="#">VorbehandlungBrustimplantatBasis</a>
properties	minOcc 0 maxOcc unbounded content complex
children	<a href="#">VBI BehandlungLokalSchluessel</a> <a href="#">VBI BehandlungSystemischSchluessel</a>
source	<pre> &lt;element name="vorbehandlungBrustimplantat" type="VorbehandlungBrustimplantatBasis" minOccurs="0" maxOccurs="unbounded"/&gt; </pre>

element **OperationBrustimplantat/massnahmeBrustimplantat**

diagram	
type	<a href="#">MassnahmeBrustimplantatBasis</a>
properties	minOcc 0 maxOcc unbounded



	content complex
children	<a href="#">MAB MassnahmeSchluessel</a>
source	<code>&lt;element name="massnahmeBrustimplantat" type="MassnahmeBrustimplantatBasis" minOccurs="0" maxOccurs="unbounded"/&gt;</code>

### element **OperationBrustimplantat/operationsdetailBrustimplantat**

diagram	
type	<a href="#">OperationsdetailBrustimplantatBasis</a>
properties	minOcc 0 maxOcc unbounded content complex
children	<a href="#">ODB_OperationsdetailPrimaerEingriffSchluessel</a> <a href="#">ODB_OperationsdetailAustauschSchluessel</a> <a href="#">ODB_OperationsdetailRevisionSchluessel</a>
source	<code>&lt;element name="operationsdetailBrustimplantat" type="OperationsdetailBrustimplantatBasis" minOccurs="0" maxOccurs="unbounded"/&gt;</code>

### element **OperationBrustimplantat/befundBrustimplantat**

diagram	
type	<a href="#">BefundBrustimplantatBasis</a>
properties	minOcc 0 maxOcc unbounded content complex
children	<a href="#">BEB_BefundSchluessel</a> <a href="#">BEB_BefundAustauschSchluessel</a>
source	<code>&lt;element name="befundBrustimplantat" type="BefundBrustimplantatBasis" minOccurs="0" maxOccurs="unbounded"/&gt;</code>

element **OperationBrustimplantat/prozedurenSchluesselBrustimplantat**

diagram	
type	<a href="#">ProzedurenSchluesselBrustimplantatBasis</a>
properties	minOcc 0 maxOcc unbounded content complex
children	<a href="#">PBI_ProzedurenSchluessel</a>
source	<pre>&lt;element name="prozedurenSchluesselBrustimplantat"   type="ProzedurenSchluesselBrustimplantatBasis" minOccurs="0"   maxOccurs="unbounded"/&gt;</pre>

complexType **OperationEndoprothese**

diagram

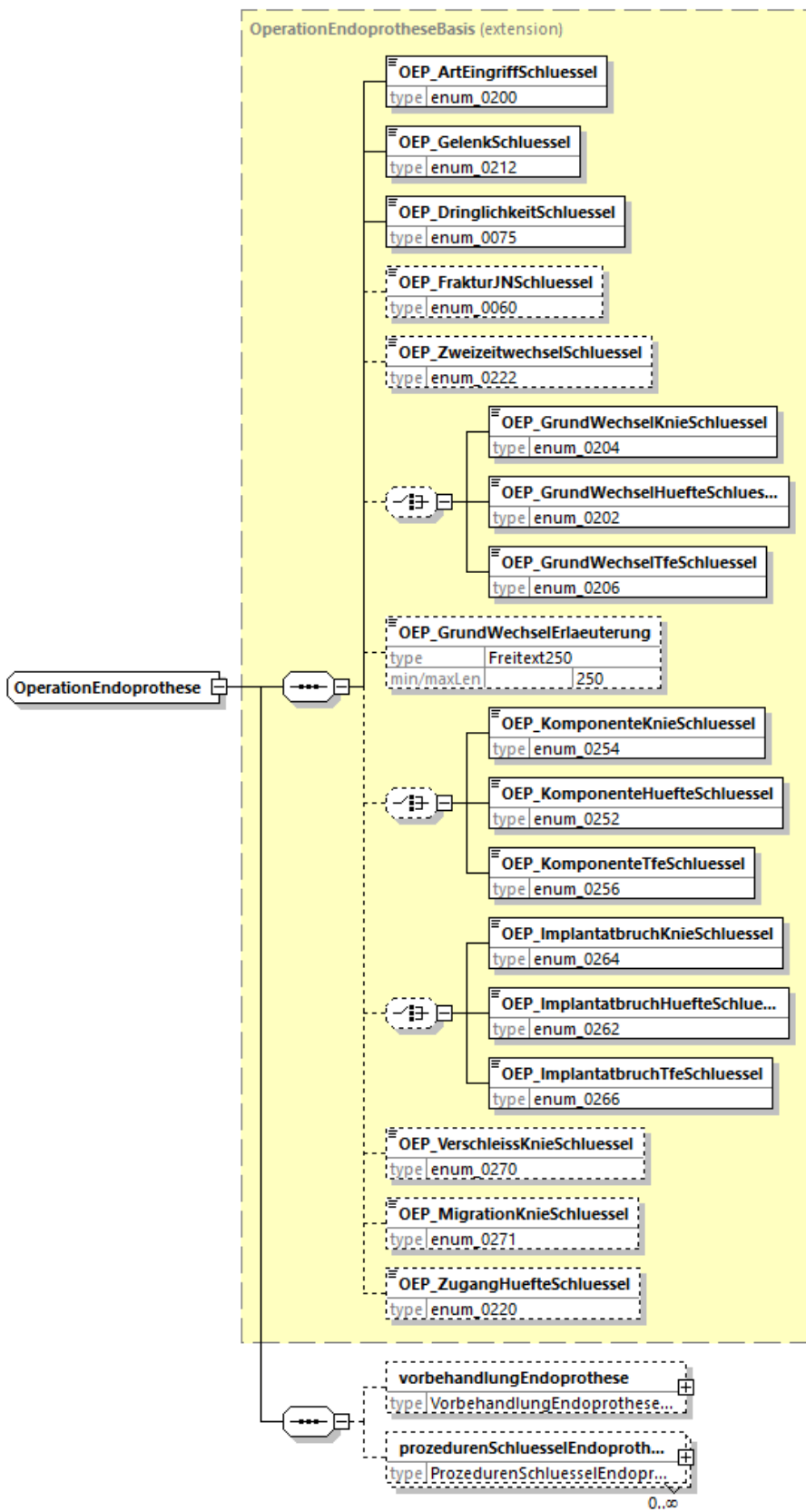

namespace	http://xml.ir-d.de/emg
type	extension of <a href="#">OperationEndoprotheseBasis</a>

properties	base <a href="#">OperationEndoprotheseBasis</a>
children	<a href="#">OEP ArtEingriffSchluessel</a> <a href="#">OEP GelenkSchluessel</a> <a href="#">OEP DringlichkeitSchluessel</a> <a href="#">OEP FrakturJNSchluessel</a> <a href="#">OEP ZweizeitwechselSchluessel</a> <a href="#">OEP GrundWechselKnieSchluessel</a> <a href="#">OEP GrundWechselHuefteSchluessel</a> <a href="#">OEP GrundWechselTfeSchluessel</a> <a href="#">OEP GrundWechselErlaeuterung</a> <a href="#">OEP KomponenteKnieSchluessel</a> <a href="#">OEP KomponenteHuefteSchluessel</a> <a href="#">OEP KomponenteTfeSchluessel</a> <a href="#">OEP ImplantatbruchKnieSchluessel</a> <a href="#">OEP ImplantatbruchHuefteSchluessel</a> <a href="#">OEP ImplantatbruchTfeSchluessel</a> <a href="#">OEP VerschleissKnieSchluessel</a> <a href="#">OEP MigrationKnieSchluessel</a> <a href="#">OEP ZugangHuefteSchluessel</a> <a href="#">vorbehandlungEndoprothese</a> <a href="#">prozedurenSchluesselEndoprothese</a>
used by	element <a href="#">Operation/operationEndoprothese</a>
source	<pre> &lt;complexType name="OperationEndoprothese"&gt;   &lt;complexContent&gt;     &lt;extension base="OperationEndoprotheseBasis"&gt;       &lt;sequence&gt;         &lt;element name="vorbehandlungEndoprothese" type="VorbehandlungEndoprotheseBasis" minOccurs="0"/&gt;         &lt;element name="prozedurenSchluesselEndoprothese" type="ProzedurenSchluesselEndoprotheseBasis" minOccurs="0" maxOccurs="unbounded"/&gt;       &lt;/sequence&gt;     &lt;/extension&gt;   &lt;/complexContent&gt; &lt;/complexType&gt; </pre>

element **OperationEndoprothese/vorbehandlungEndoprothese**

diagram	
type	<a href="#">VorbehandlungEndoprotheseBasis</a>
properties	minOcc 0 maxOcc 1 content complex
children	<a href="#">VEP_VorOpKnieSchluessel</a> <a href="#">VEP_VorOpHuefteSchluessel</a> <a href="#">VEP_VorOpErlaeuterung</a>
source	<pre> &lt;element name="vorbehandlungEndoprothese" type="VorbehandlungEndoprotheseBasis" minOccurs="0"/&gt; </pre>

element **OperationEndoprothese/prozedurenSchluesselEndoprothese**

<p>diagram</p>	<p>The diagram shows a class 'prozedurenSchluesselEndoproth...' with a multiplicity of '0..∞' connected to a class 'PEP_ProzedurenSchluessel' with a multiplicity of '1'. The 'PEP_ProzedurenSchluessel' class has properties: type 'OPS' and pattern '(((135689)\-[0-9]){2}){([a-zA-Z0-9]...'.</p>
<p>type</p>	<p><a href="#">ProzedurenSchluesselEndoprotheseBasis</a></p>
<p>properties</p>	<p>minOcc 0 maxOcc unbounded content complex</p>
<p>children</p>	<p><a href="#">PEP_ProzedurenSchluessel</a></p>
<p>source</p>	<pre>&lt;element name="prozedurenSchluesselEndoprothese" type="ProzedurenSchluesselEndoprotheseBasis" minOccurs="0" maxOccurs="unbounded"/&gt;</pre>



properties	base <a href="#">OperationAortenklappeBasis</a>
children	<a href="#">OAK NummerEingriff</a> <a href="#">OAK ArtEingriffSchluessel</a> <a href="#">OAK GrundEingriffSchluessel</a> <a href="#">OAK DringlichkeitSchluessel</a> <a href="#">OAK ExplantationSchluessel</a> <a href="#">OAK IsoliertSchluessel</a> <a href="#">OAK ZugangKonventionellSchluessel</a> <a href="#">OAK ZugangKatheterSchluessel</a> <a href="#">OAK KomplikationenSchluessel</a> <a href="#">OAK TherapieLcoSchluessel</a> <a href="#">OAK Durchleuchtungszeit</a> <a href="#">OAK BeatmungSchluessel</a> <a href="#">OAK TroponinSchluessel</a> <a href="#">OAK InotropeSchluessel</a> <a href="#">OAK Eingriffsdauer</a> <a href="#">OAK EingriffsumfangSchluessel</a> <a href="#">OAK ProzedurenAnzahl</a> <a href="#">OAK VorgehenSchluessel</a> <a href="#">OAK Bypasszeit</a> <a href="#">OAK BypasszeitUnbekannt</a> <a href="#">OAK Abklemmzeit</a> <a href="#">OAK AbklemmzeitUnbekannt</a> <a href="#">OAK AortaThorakalSchluessel</a> <a href="#">OAK NeuroprotektionSchluessel</a> <a href="#">OAK KreislaufunterstuetzungSchluessel</a> <a href="#">OAK PraeOpUnterstuetzungSchluessel</a> <a href="#">OAK PraeOpMethodeSchluessel</a> <a href="#">OAK IntraOpUnterstuetzungSchluessel</a> <a href="#">OAK IntraOpMethodeSchluessel</a> <a href="#">OAK AortenklappenOpAnzahl</a> <a href="#">OAK ValvelnValveSchluessel</a> <a href="#">OAK ZugangsGefaessdiameter</a> <a href="#">OAK ZugangsGefaessUnbekannt</a> <a href="#">OAK ZugangVerkalkungSchluessel</a> <a href="#">OAK Aortenklappenannulus</a> <a href="#">OAK MessmethodeSchluessel</a> <a href="#">OAK DistanzRca</a> <a href="#">OAK DistanzRcaUnbekannt</a> <a href="#">OAK DistanzLca</a> <a href="#">OAK DistanzLcaUnbekannt</a> <a href="#">OAK PtcaVorSchluessel</a> <a href="#">OAK PtcaVorDurchmesser</a> <a href="#">OAK PtcaVorDurchmesserUnbekannt</a> <a href="#">OAK PtcaVorAnzahl</a> <a href="#">OAK RapidPacingVorSchluessel</a> <a href="#">OAK RapidPacingIntraSchluessel</a> <a href="#">OAK PtcaNachSchluessel</a> <a href="#">OAK PtcaNachDurchmesser</a> <a href="#">OAK PtcaNachDurchmesserUnbekannt</a> <a href="#">OAK PtcaNachAnzahl</a> <a href="#">OAK RapidPacingNachSchluessel</a> <a href="#">OAK KonversionSchluessel</a> <a href="#">OAK SuccessSchluessel</a> <a href="#">OAK AnaesthesieSchluessel</a> <a href="#">OAK DeltaPmeanNachOp</a> <a href="#">OAK DeltaPmeanNachOpUnbekannt</a> <a href="#">OAK ResidualeInsuffizienzSchluessel</a> <a href="#">OAK ZugangVerschlussSchluessel</a> <a href="#">OAK ZusätzlichePciSchluessel</a> <a href="#">OAK PciWegenKhkSchluessel</a> <a href="#">OAK PciWegenKomplikationSchluessel</a> <a href="#">OAK LaesionenAnzahl</a> <a href="#">komplikationAortenklappe</a> <a href="#">taviAortenklappe</a> <a href="#">pciAortenklappe</a> <a href="#">failureGrundAortenklappe</a> <a href="#">prozedurenSchluesselAortenklappe</a>
used by	element <a href="#">Operation/operationAortenklappe</a>
source	<pre> &lt;complexType name="OperationAortenklappe"&gt;   &lt;complexContent&gt;     &lt;extension base="OperationAortenklappeBasis"&gt;       &lt;sequence&gt;         &lt;element name="komplikationAortenklappe" type="KomplikationAortenklappeBasis" minOccurs="0" maxOccurs="unbounded"/&gt;         &lt;element name="taviAortenklappe" type="TaviAortenklappeBasis" minOccurs="0" maxOccurs="unbounded"/&gt;         &lt;element name="pciAortenklappe" type="PciAortenklappeBasis" minOccurs="0" maxOccurs="unbounded"/&gt;         &lt;element name="failureGrundAortenklappe" type="FailureGrundAortenklappeBasis" minOccurs="0" maxOccurs="unbounded"/&gt;         &lt;element name="prozedurenSchluesselAortenklappe" type="ProzedurenSchluesselAortenklappeBasis" minOccurs="0" maxOccurs="unbounded"/&gt;       &lt;/sequence&gt;     &lt;/extension&gt;   &lt;/complexContent&gt; &lt;/complexType&gt; </pre>

element **OperationAortenklappe/komplikationAortenklappe**

diagram	
type	<a href="#">KomplikationAortenklappeBasis</a>
properties	minOcc 0 maxOcc unbounded content complex
children	<a href="#">KAK KomplikationTypSchluessel</a>

source	<code>&lt;element name="komplikationAortenklappe" type="KomplikationAortenklappeBasis" minOccurs="0" maxOccurs="unbounded"/&gt;</code>
--------	--

#### element **OperationAortenklappe/taviAortenklappe**

diagram	
type	<a href="#">TaviAortenklappeBasis</a>
properties	minOcc 0 maxOcc unbounded content complex
children	<a href="#">TAK GrundTaviSchlüssel</a>
source	<code>&lt;element name="taviAortenklappe" type="TaviAortenklappeBasis" minOccurs="0" maxOccurs="unbounded"/&gt;</code>

#### element **OperationAortenklappe/pciAortenklappe**

diagram	
type	<a href="#">PciAortenklappeBasis</a>
properties	minOcc 0 maxOcc unbounded content complex
children	<a href="#">PCA PciArterienSchlüssel</a>
source	<code>&lt;element name="pciAortenklappe" type="PciAortenklappeBasis" minOccurs="0" maxOccurs="unbounded"/&gt;</code>

#### element **OperationAortenklappe/failureGrundAortenklappe**

diagram	
type	<a href="#">FailureGrundAortenklappeBasis</a>
properties	minOcc 0 maxOcc unbounded content complex
children	<a href="#">FAK FailureGrundSchlüssel</a>
source	<code>&lt;element name="failureGrundAortenklappe" type="FailureGrundAortenklappeBasis" minOccurs="0" maxOccurs="unbounded"/&gt;</code>



`minOccurs="0" maxOccurs="unbounded"/>`

element **OperationAortenklappe/prozedurenSchluesselAortenklappe**

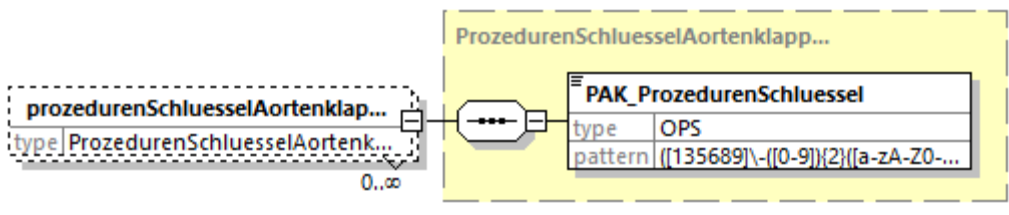
diagram	
type	<a href="#">ProzedurenSchluesselAortenklappeBasis</a>
properties	minOcc 0 maxOcc unbounded content complex
children	<a href="#">PAK ProzedurenSchluessel</a>
source	<code>&lt;element name="prozedurenSchluesselAortenklappe" type="ProzedurenSchluesselAortenklappeBasis" minOccurs="0" maxOccurs="unbounded"/&gt;</code>

## complexType Artikelidentifikation

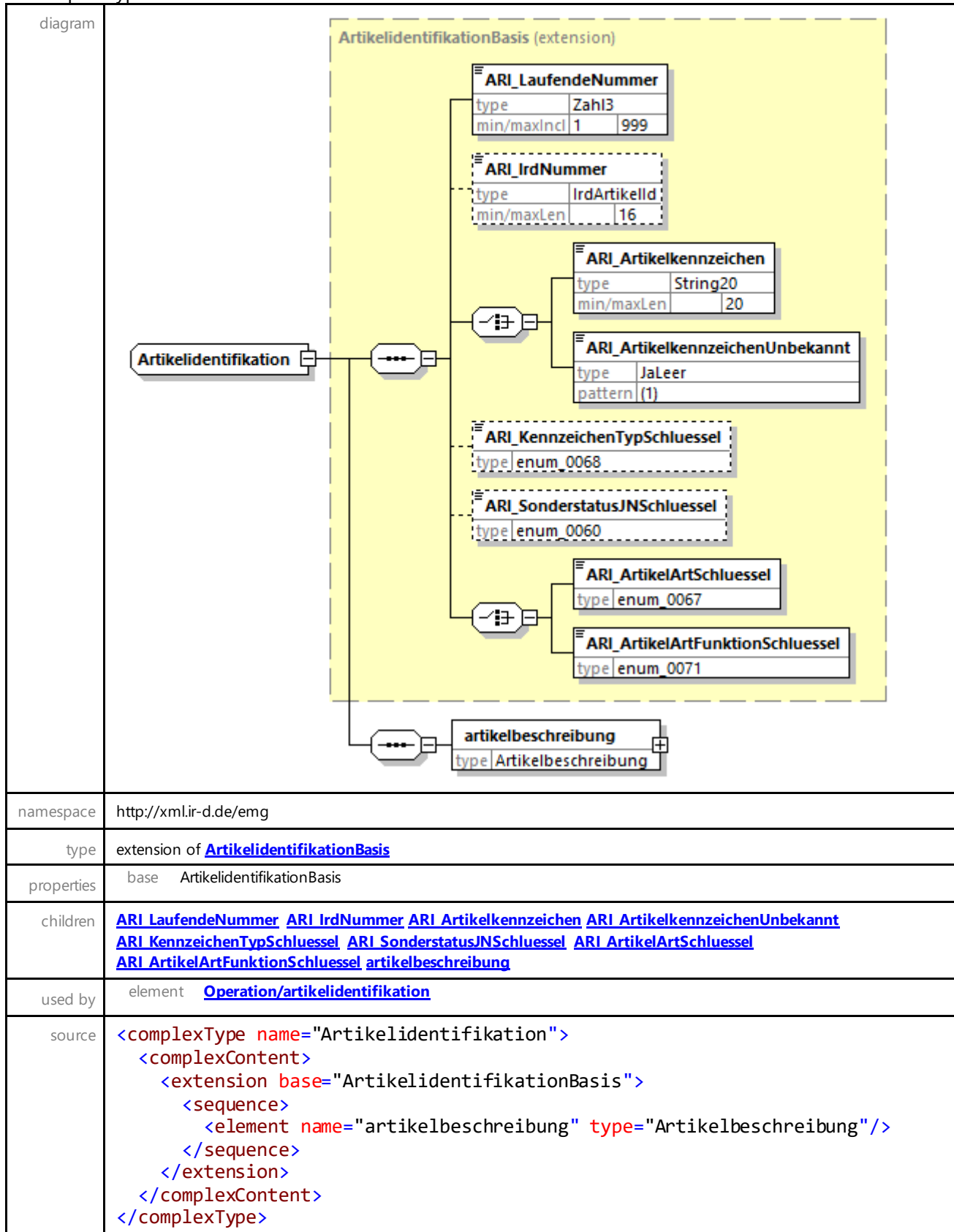

element **Artikelidentifikation/artikelbeschreibung**

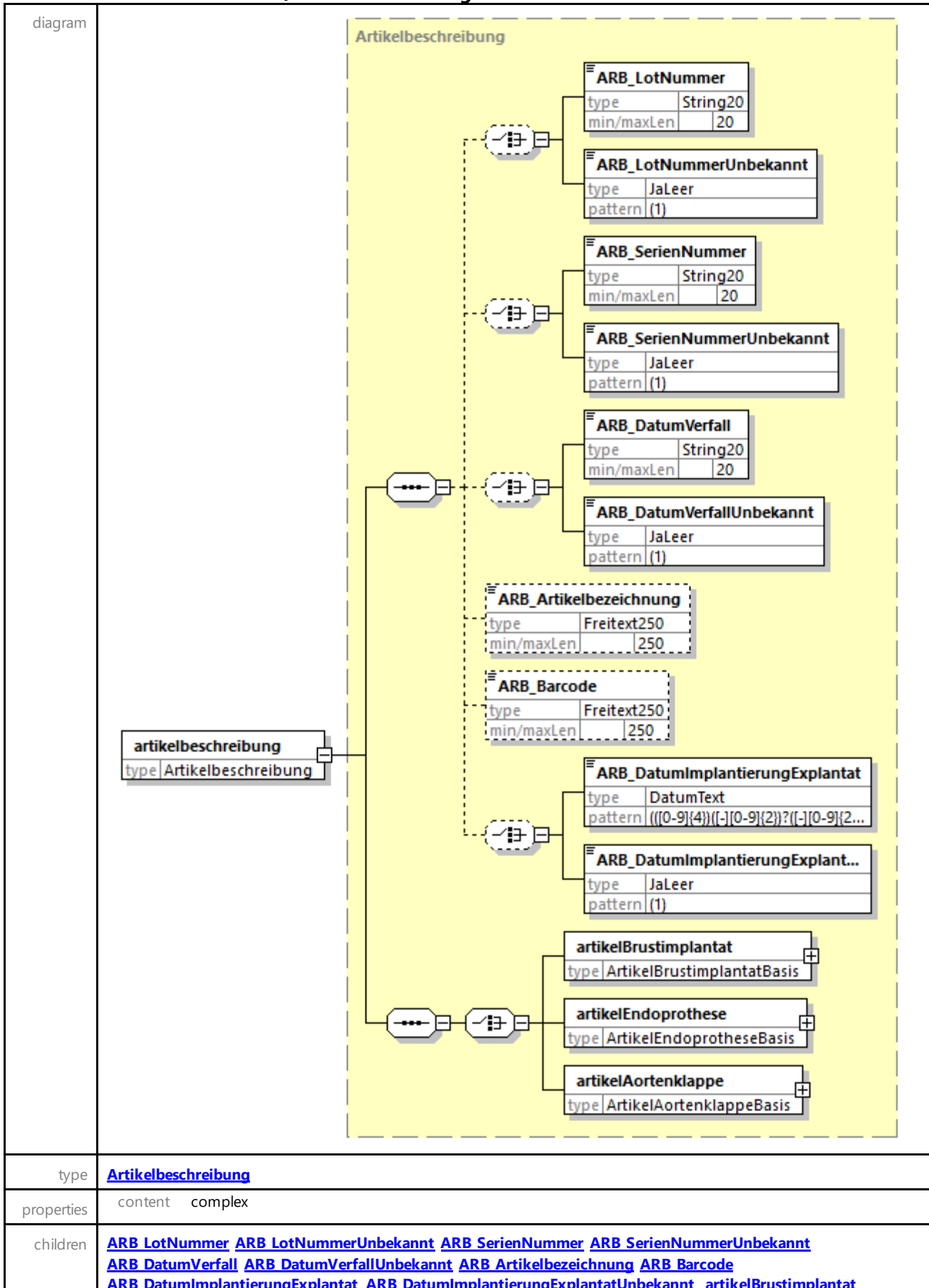

	<a href="#">artikelEndoprothese</a> <a href="#">artikelAortenklappe</a>
source	<element name="artikelbeschreibung" type="Artikelbeschreibung"/>

complexType **Zubehoer**

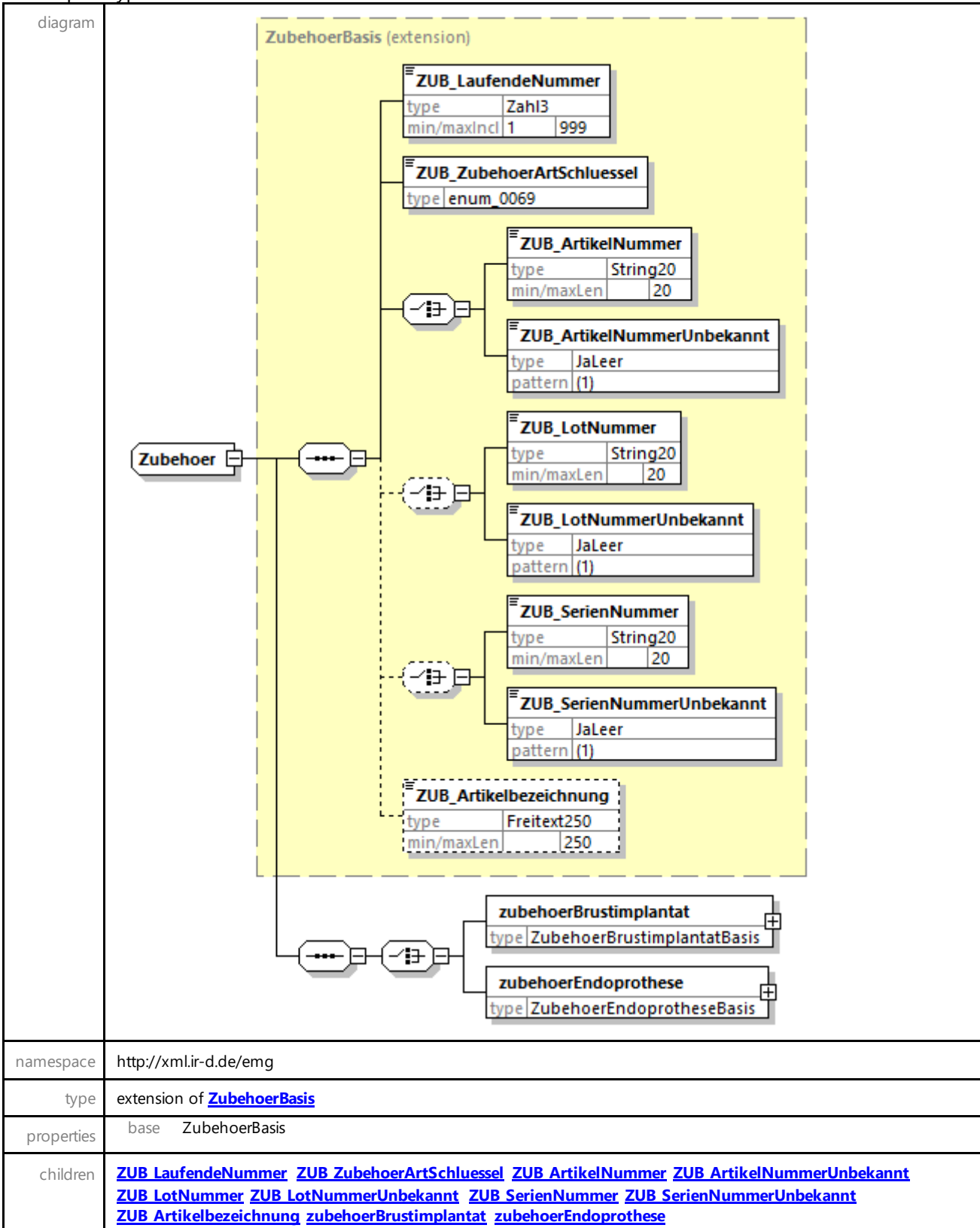

used by	element <a href="#">Operation/zubehoer</a>
source	<pre> &lt;complexType name="Zubehoer"&gt;   &lt;complexContent&gt;     &lt;extension base="ZubehoerBasis"&gt;       &lt;sequence&gt;         &lt;choice&gt;           &lt;element name="zubehoerBrustimplantat" type="ZubehoerBrustimplantatBasis"/&gt;           &lt;element name="zubehoerEndoprothese" type="ZubehoerEndoprotheseBasis"/&gt;         &lt;/choice&gt;       &lt;/sequence&gt;     &lt;/extension&gt;   &lt;/complexContent&gt; &lt;/complexType&gt; </pre>

element **Zubehoer/zubehoerBrustimplantat**

diagram	
type	<a href="#">ZubehoerBrustimplantatBasis</a>
properties	content complex
children	<a href="#">ZBI_HerstellerSchluessel</a> <a href="#">ZBI_HerstellerUnbekannt</a> <a href="#">ZBI_HerstellerSonstiger</a> <a href="#">ZBI_ZubehoerTypSchluessel</a>
source	<code>&lt;element name="zubehoerBrustimplantat" type="ZubehoerBrustimplantatBasis"/&gt;</code>

element **Zubehoer/zubehoerEndoprothese**

diagram	
type	<a href="#">ZubehoerEndoprotheseBasis</a>
properties	content complex
children	<a href="#">ZEP HerstellerSchluessel</a> <a href="#">ZEP HerstellerUnbekannt</a> <a href="#">ZEP HerstellerSonstiger</a> <a href="#">ZEP ZubehoerTypSchluessel</a> <a href="#">ZEP Menge</a> <a href="#">ZEP EinheitSchluessel</a>
source	<code>&lt;element name="zubehoerEndoprothese" type="ZubehoerEndoprotheseBasis"/&gt;</code>

complexType **EntlassungBasis**

diagram	
namespace	http://xml.ir-d.de/emg
children	<a href="#">ENT Datum</a> <a href="#">ENT GrundSchluessel</a>
used by	complexType <a href="#">Entlassung</a>
source	<pre> &lt;complexType name="EntlassungBasis"&gt;   &lt;sequence&gt;     &lt;element name="ENT_Datum" type="xs:date"/&gt;     &lt;element name="ENT_GrundSchluessel" type="String2" minOccurs="0"/&gt;   &lt;/sequence&gt; &lt;/complexType&gt; </pre>

element **EntlassungBasis/ENT\_Datum**

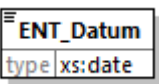
diagram	
type	<b>date</b>
properties	content simple
source	<code>&lt;element name="ENT_Datum" type="xs:date"/&gt;</code>

element **EntlassungBasis/ENT\_GrundSchluessel**

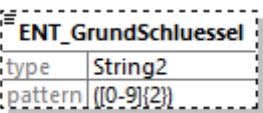
diagram	
type	<b>String2</b>
properties	minOcc 0 maxOcc 1 content simple
facets	Kind Value Annotation pattern ([0-9]{2})
source	<code>&lt;element name="ENT_GrundSchluessel" type="String2" minOccurs="0"/&gt;</code>

complexType **DiagnoseBrustimplantatBasis**

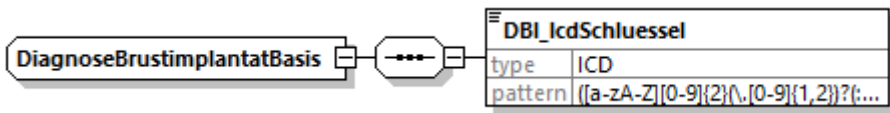
diagram	
namespace	http://xml.ir-d.de/emg
children	<a href="#">DBI_IcdSchluessel</a>
used by	element <a href="#">Entlassung/diagnoseBrustimplantat</a>
source	<pre>&lt;complexType name="DiagnoseBrustimplantatBasis"&gt;   &lt;sequence&gt;     &lt;element name="DBI_IcdSchluessel" type="ICD"/&gt;   &lt;/sequence&gt; &lt;/complexType&gt;</pre>

element **DiagnoseBrustimplantatBasis/DBI\_IcdSchluessel**

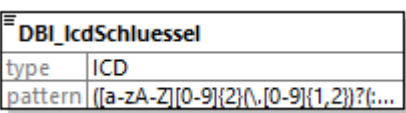
diagram	
type	<b>ICD</b>
properties	content simple
facets	Kind Value Annotation pattern ([a-zA-Z][0-9]{2}(\.[0-9]{1,2})?)?;...

source	<code>&lt;element name="DBI_IcdSchluessel" type="ICD"/&gt;</code>
--------	---

### complexType DiagnoseEndoprotheseBasis

diagram	
namespace	http://xml.ir-d.de/emg
children	<a href="#">DEP_IcdSchluessel</a>
used by	element <a href="#">Entlassung/diagnoseEndoprothese</a>
source	<pre> &lt;complexType name="DiagnoseEndoprotheseBasis"&gt;   &lt;sequence&gt;     &lt;element name="DEP_IcdSchluessel" type="ICD"/&gt;   &lt;/sequence&gt; &lt;/complexType&gt; </pre>

### element DiagnoseEndoprotheseBasis/DEP\_IcdSchluessel

diagram							
type	<a href="#">ICD</a>						
properties	content simple						
facets	<table border="1"> <thead> <tr> <th>Kind</th> <th>Value</th> <th>Annotation</th> </tr> </thead> <tbody> <tr> <td>pattern</td> <td>([a-zA-Z][0-9]{2}\.[0-9]{1,2})?;(:[RLB])?</td> <td></td> </tr> </tbody> </table>	Kind	Value	Annotation	pattern	([a-zA-Z][0-9]{2}\.[0-9]{1,2})?;(:[RLB])?	
Kind	Value	Annotation					
pattern	([a-zA-Z][0-9]{2}\.[0-9]{1,2})?;(:[RLB])?						
source	<code>&lt;element name="DEP_IcdSchluessel" type="ICD"/&gt;</code>						

### complexType DiagnoseAortenklappeBasis

diagram	
namespace	http://xml.ir-d.de/emg
children	<a href="#">DAK_IcdSchluessel</a>
used by	element <a href="#">Entlassung/diagnoseAortenklappe</a>
source	<pre> &lt;complexType name="DiagnoseAortenklappeBasis"&gt;   &lt;sequence&gt;     &lt;element name="DAK_IcdSchluessel" type="ICD"/&gt;   &lt;/sequence&gt; &lt;/complexType&gt; </pre>

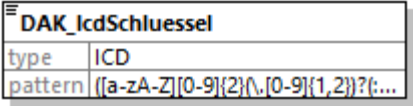

element **DiagnoseAortenklappeBasis/DAK\_IcdSchluessel**

diagram	 <pre> DAK_IcdSchluessel type ICD pattern ([a-zA-Z][0-9]{2}(\.[0-9]{1,2})?:(... </pre>						
type	<a href="#">ICD</a>						
properties	content simple						
facets	<table border="1"> <thead> <tr> <th>Kind</th> <th>Value</th> <th>Annotation</th> </tr> </thead> <tbody> <tr> <td>pattern</td> <td>([a-zA-Z][0-9]{2}(\.[0-9]{1,2})?:(RLB))?</td> <td></td> </tr> </tbody> </table>	Kind	Value	Annotation	pattern	([a-zA-Z][0-9]{2}(\.[0-9]{1,2})?:(RLB))?	
Kind	Value	Annotation					
pattern	([a-zA-Z][0-9]{2}(\.[0-9]{1,2})?:(RLB))?						
source	<code>&lt;element name="DAK_IcdSchluessel" type="ICD"/&gt;</code>						

# complexType PostoperationAortenklappeBasis

diagram



namespace	http://xml.ir-d.de/emg
children	<a href="#">POA_IntraOpVerstorbenSchluessel</a> <a href="#">POA_ReanimationSchluessel</a> <a href="#">POA_SchlaganfallSchluessel</a> <a href="#">POA_NihssSchluessel</a> <a href="#">POA_DatumSchlaganfall</a> <a href="#">POA_MyokardinfarktSchluessel</a> <a href="#">POA_DatumMyokardinfarkt</a>

	<a href="#">POA MassnahmenSchluessel</a> <a href="#">POA GrundMassnahmeSchluessel</a> <a href="#">POA IntensivDauer</a> <a href="#">POA AtemInsuffizienzSchluessel</a> <a href="#">POA NierenersatzSchluessel</a> <a href="#">POA MaxKreatininMikromol</a> <a href="#">POA MaxKreatininMgDI</a> <a href="#">POA MaxKreatininUnbekannt</a> <a href="#">POA BlutungSchluessel</a> <a href="#">POA ZugangKomplikationenSchluessel</a> <a href="#">POA HerzrhythmusSchluessel</a> <a href="#">POA VorhofflimmernSchluessel</a> <a href="#">POA AvBlockSchluessel</a> <a href="#">POA SchrittmacherSchluessel</a> <a href="#">POA SepsisSchluessel</a> <a href="#">POA EndokarditisSchluessel</a> <a href="#">POA DeltaPmax</a> <a href="#">POA DeltaPmaxUnbekannt</a> <a href="#">POA DeltaPmean</a> <a href="#">POA DeltaPmeanUnbekannt</a> <a href="#">POA Akoef</a> <a href="#">POA AkoefUnbekannt</a> <a href="#">POA AorteninsuffizienzSchluessel</a> <a href="#">POA MitralinsuffizienzSchluessel</a> <a href="#">POA TrikuspidalinsuffizienzSchluessel</a> <a href="#">POA Lvef</a> <a href="#">POA LvefUnbekannt</a> <a href="#">POA VitalstatusSchluessel</a> <a href="#">POA TodesursacheSchluessel</a> <a href="#">POA AggregationshemmerSchluessel</a>
used by	complexType <a href="#">PostoperationAortenklappe</a>
source	<pre> &lt;complexType name="PostoperationAortenklappeBasis"&gt;   &lt;sequence&gt;     &lt;element name="POA_IntraOpVerstorbenSchluessel" type="enum_0060"/&gt;     &lt;element name="POA_ReanimationSchluessel" type="enum_0380"/&gt;     &lt;element name="POA_SchlaganfallSchluessel" type="enum_0376"/&gt;     &lt;element name="POA_NihssSchluessel" type="enum_0377" minOccurs="0"/&gt;     &lt;element name="POA_DatumSchlaganfall" type="xs:date" minOccurs="0"/&gt;     &lt;element name="POA_MyokardinfarktSchluessel" type="enum_0378"/&gt;     &lt;element name="POA_DatumMyokardinfarkt" type="xs:date" minOccurs="0"/&gt;     &lt;element name="POA_MassnahmenSchluessel" type="enum_0381"/&gt;     &lt;element name="POA_GrundMassnahmeSchluessel" type="enum_0382" minOccurs="0"/&gt;     &lt;element name="POA_IntensivDauer" type="Zahl3" minOccurs="0"/&gt;     &lt;element name="POA_AtemInsuffizienzSchluessel" type="enum_0383" minOccurs="0"/&gt;     &lt;element name="POA_NierenersatzSchluessel" type="enum_0060" minOccurs="0"/&gt;     &lt;choice minOccurs="0"&gt;       &lt;element name="POA_MaxKreatininMikromol" type="Zahl14"/&gt;       &lt;element name="POA_MaxKreatininMgDI" type="Zahl2_1"/&gt;       &lt;element name="POA_MaxKreatininUnbekannt" type="JaLeer"/&gt;     &lt;/choice&gt;     &lt;element name="POA_BlutungSchluessel" type="enum_0384"/&gt;     &lt;element name="POA_ZugangKomplikationenSchluessel" type="enum_0379"/&gt;     &lt;element name="POA_HerzrhythmusSchluessel" type="enum_0385" minOccurs="0"/&gt;     &lt;element name="POA_VorhofflimmernSchluessel" type="enum_0060" minOccurs="0"/&gt;     &lt;element name="POA_AvBlockSchluessel" type="enum_0060" minOccurs="0"/&gt;     &lt;element name="POA_SchrittmacherSchluessel" type="enum_0364" minOccurs="0"/&gt;     &lt;element name="POA_SepsisSchluessel" type="enum_0060" minOccurs="0"/&gt;     &lt;element name="POA_EndokarditisSchluessel" type="enum_0060" minOccurs="0"/&gt;     &lt;choice minOccurs="0"&gt;       &lt;element name="POA_DeltaPmax" type="Zahl3"/&gt;       &lt;element name="POA_DeltaPmaxUnbekannt" type="JaLeer"/&gt;     &lt;/choice&gt;     &lt;choice minOccurs="0"&gt;       &lt;element name="POA_DeltaPmean" type="Zahl3"/&gt;       &lt;element name="POA_DeltaPmeanUnbekannt" type="JaLeer"/&gt;     &lt;/choice&gt;     &lt;choice minOccurs="0"&gt;       &lt;element name="POA_Akoef" type="Zahl1_1"/&gt;       &lt;element name="POA_AkoefUnbekannt" type="JaLeer"/&gt;     &lt;/choice&gt;     &lt;element name="POA_AorteninsuffizienzSchluessel" type="enum_0373" minOccurs="0"/&gt;     &lt;element name="POA MitralinsuffizienzSchluessel" type="enum_0373" </pre>

	<pre> minOccurs="0"/&gt;   &lt;element name="POA_TrikuspidalinsuffizienzSchluessel" type="enum_0360" minOccurs="0"/&gt;   &lt;choice minOccurs="0"&gt;     &lt;element name="POA_Lvef" type="Zahl3"/&gt;     &lt;element name="POA_LvefUnbekannt" type="JaLeer"/&gt;   &lt;/choice&gt;   &lt;element name="POA_VitalstatusSchluessel" type="enum_0399"/&gt;   &lt;element name="POA_TodesursacheSchluessel" type="enum_0398" minOccurs="0"/&gt;   &lt;element name="POA_AggregationshemmerSchluessel" type="enum_0388" minOccurs="0"/&gt;   &lt;/sequence&gt; &lt;/complexType&gt; </pre>
--	---

element **PostoperationAortenklappeBasis/POA\_IntraOpVerstorbenSchluessel**

diagram										
type	<a href="#">enum_0060</a>									
properties	content simple									
facets	<table border="1"> <thead> <tr> <th>Kind</th> <th>Value</th> <th>Annotation</th> </tr> </thead> <tbody> <tr> <td>enumeration</td> <td>0060001</td> <td>documentation ja</td> </tr> <tr> <td>enumeration</td> <td>0060002</td> <td>documentation nein</td> </tr> </tbody> </table>	Kind	Value	Annotation	enumeration	0060001	documentation ja	enumeration	0060002	documentation nein
Kind	Value	Annotation								
enumeration	0060001	documentation ja								
enumeration	0060002	documentation nein								
source	<code>&lt;element name="POA_IntraOpVerstorbenSchluessel" type="enum_0060"/&gt;</code>									

element **PostoperationAortenklappeBasis/POA\_ReanimationSchluessel**

diagram																
type	<a href="#">enum_0380</a>															
properties	content simple															
facets	<table border="1"> <thead> <tr> <th>Kind</th> <th>Value</th> <th>Annotation</th> </tr> </thead> <tbody> <tr> <td>enumeration</td> <td>0380001</td> <td>documentation nein</td> </tr> <tr> <td>enumeration</td> <td>0380002</td> <td>documentation ja, intraprozedural</td> </tr> <tr> <td>enumeration</td> <td>0380003</td> <td>documentation ja, postprozedural</td> </tr> <tr> <td>enumeration</td> <td>0380004</td> <td>documentation ja, Zeitpunkt nicht bekannt</td> </tr> </tbody> </table>	Kind	Value	Annotation	enumeration	0380001	documentation nein	enumeration	0380002	documentation ja, intraprozedural	enumeration	0380003	documentation ja, postprozedural	enumeration	0380004	documentation ja, Zeitpunkt nicht bekannt
Kind	Value	Annotation														
enumeration	0380001	documentation nein														
enumeration	0380002	documentation ja, intraprozedural														
enumeration	0380003	documentation ja, postprozedural														
enumeration	0380004	documentation ja, Zeitpunkt nicht bekannt														
source	<code>&lt;element name="POA_ReanimationSchluessel" type="enum_0380"/&gt;</code>															

element **PostoperationAortenklappeBasis/POA\_SchlaganfallSchluessel**

diagram	
---------	--

type	<a href="#">enum_0376</a>															
properties	content simple															
facets	<table border="1"> <thead> <tr> <th>Kind</th> <th>Value</th> <th>Annotation</th> </tr> </thead> <tbody> <tr> <td>enumeration</td> <td>0376001</td> <td>documentation nein</td> </tr> <tr> <td>enumeration</td> <td>0376002</td> <td>documentation ja, ZNS, zerebrovaskuläre Blutung</td> </tr> <tr> <td>enumeration</td> <td>0376003</td> <td>documentation ja, ZNS, zerebrovaskuläre Ischämie</td> </tr> <tr> <td>enumeration</td> <td>0376042</td> <td>documentation ja, ZNS, andere</td> </tr> </tbody> </table>	Kind	Value	Annotation	enumeration	0376001	documentation nein	enumeration	0376002	documentation ja, ZNS, zerebrovaskuläre Blutung	enumeration	0376003	documentation ja, ZNS, zerebrovaskuläre Ischämie	enumeration	0376042	documentation ja, ZNS, andere
Kind	Value	Annotation														
enumeration	0376001	documentation nein														
enumeration	0376002	documentation ja, ZNS, zerebrovaskuläre Blutung														
enumeration	0376003	documentation ja, ZNS, zerebrovaskuläre Ischämie														
enumeration	0376042	documentation ja, ZNS, andere														
source	<code>&lt;element name="POA_SchlaganfallSchluessel" type="enum_0376"/&gt;</code>															

#### element **PostoperationAortenklappeBasis/POA\_NihssSchluessel**

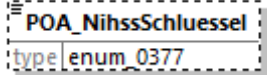
diagram													
type	<a href="#">enum_0377</a>												
properties	minOcc 0 maxOcc 1 content simple												
facets	<table border="1"> <thead> <tr> <th>Kind</th> <th>Value</th> <th>Annotation</th> </tr> </thead> <tbody> <tr> <td>enumeration</td> <td>0377001</td> <td>documentation ja, mild neurological dysfunction: NIHSS 0-5</td> </tr> <tr> <td>enumeration</td> <td>0377002</td> <td>documentation ja, moderate neurological dysfunction: NIHSS 6-14</td> </tr> <tr> <td>enumeration</td> <td>0377003</td> <td>documentation ja, severe neurological dysfunction: NIHSS &amp;gt;=15</td> </tr> </tbody> </table>	Kind	Value	Annotation	enumeration	0377001	documentation ja, mild neurological dysfunction: NIHSS 0-5	enumeration	0377002	documentation ja, moderate neurological dysfunction: NIHSS 6-14	enumeration	0377003	documentation ja, severe neurological dysfunction: NIHSS &gt;=15
Kind	Value	Annotation											
enumeration	0377001	documentation ja, mild neurological dysfunction: NIHSS 0-5											
enumeration	0377002	documentation ja, moderate neurological dysfunction: NIHSS 6-14											
enumeration	0377003	documentation ja, severe neurological dysfunction: NIHSS &gt;=15											
source	<code>&lt;element name="POA_NihssSchluessel" type="enum_0377" minOccurs="0"/&gt;</code>												

#### element **PostoperationAortenklappeBasis/POA\_DatumSchlaganfall**

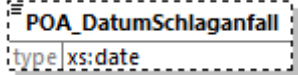
diagram	
type	<b>date</b>
properties	minOcc 0 maxOcc 1 content simple
source	<code>&lt;element name="POA_DatumSchlaganfall" type="xs:date" minOccurs="0"/&gt;</code>

#### element **PostoperationAortenklappeBasis/POA\_MyokardinfarktSchluessel**

diagram							
type	<a href="#">enum_0378</a>						
properties	content simple						
facets	<table border="1"> <thead> <tr> <th>Kind</th> <th>Value</th> <th>Annotation</th> </tr> </thead> <tbody> <tr> <td>enumeration</td> <td>0378001</td> <td>documentation</td> </tr> </tbody> </table>	Kind	Value	Annotation	enumeration	0378001	documentation
Kind	Value	Annotation					
enumeration	0378001	documentation					

	enumeration	0378002	nein documentation ja, &lt; 48h gemäss VARC-3-Definition
	enumeration	0378003	documentation ja, &gt;= 48h - &lt;= 72h gemäß VARC-3-Definition
	enumeration	0378004	documentation ja, &gt; 72 h gemäß VARC-3 Definition
source	<code>&lt;element name="POA_MyokardinfarktSchluessel" type="enum_0378"/&gt;</code>		

#### element **PostoperationAortenklappeBasis/POA\_DatumMyokardinfarkt**

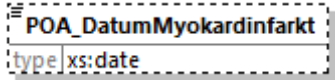
diagram			
type	<b>date</b>		
properties	minOcc	0	
	maxOcc	1	
	content	simple	
source	<code>&lt;element name="POA_DatumMyokardinfarkt" type="xs:date" minOccurs="0"/&gt;</code>		

#### element **PostoperationAortenklappeBasis/POA\_MassnahmenSchluessel**

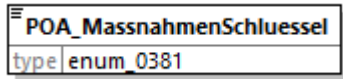
diagram			
type	<a href="#">enum 0381</a>		
properties	content	simple	
facets	Kind	Value	Annotation
	enumeration	0381001	documentation nein
	enumeration	0381002	documentation Thorakotomie/Rethorakotomie
	enumeration	0381003	documentation kathetergestützte Reintervention
	enumeration	0381004	documentation lokale Reinterventionen
	enumeration	0381005	documentation andere Reintervention
source	<code>&lt;element name="POA_MassnahmenSchluessel" type="enum_0381"/&gt;</code>		

#### element **PostoperationAortenklappeBasis/POA\_GrundMassnahmeSchluessel**

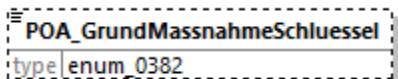
diagram			
type	<a href="#">enum 0382</a>		
properties	minOcc	0	
	maxOcc	1	
	content	simple	
facets	Kind	Value	Annotation
	enumeration	0382001	documentation keine Rethorakotomie / kein weiterer Grund
	enumeration	0382002	documentation

	enumeration	0382003	Blutung/Hämatom documentation
	enumeration	0382004	Low Cardiac Output documentation
	enumeration	0382005	Tamponade documentation
	enumeration	0382006	Graftprobleme, Ischämie documentation
	enumeration	0382007	Wundinfektion, Mediastinitis documentation
	enumeration	0382008	Dissektion documentation
	enumeration	0382009	Prothesendysfunktion documentation
	enumeration	0382010	instabiles Sternum documentation
	enumeration	0382011	Chylothorax documentation
	enumeration	0382042	lokale Revision im Bereich des Zugangsweges documentation
			anderer Grund
source	<code>&lt;element name="POA_GrundMassnahmeSchluessel" type="enum_0382" minOccurs="0"/&gt;</code>		

#### element **PostoperationAortenklappeBasis/POA\_IntensivDauer**

diagram			
type	<a href="#">Zahl3</a>		
properties	minOcc	0	
	maxOcc	1	
	content	simple	
facets	Kind	Value	Annotation
	minInclusive	1	
	maxInclusive	999	
source	<code>&lt;element name="POA_IntensivDauer" type="Zahl3" minOccurs="0"/&gt;</code>		

#### element **PostoperationAortenklappeBasis/POA\_AtemInsuffizienzSchluessel**

diagram			
type	<a href="#">enum 0383</a>		
properties	minOcc	0	
	maxOcc	1	
	content	simple	
facets	Kind	Value	Annotation
	enumeration	0383001	documentation nein
	enumeration	0383002	documentation ja, mit forcierter Atemtherapie
	enumeration	0383003	documentation ja, Reintubation oder längerfristige Beatmung
	enumeration	0383004	documentation ja, Tracheotomie

source	<code>&lt;element name="POA_AtemInsuffizienzSchluessel" type="enum_0383" minOccurs="0"/&gt;</code>
--------	--

element **PostoperationAortenklappeBasis/POA\_NierenersatzSchluessel**

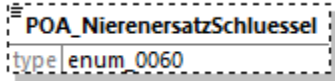
diagram										
type	<a href="#">enum 0060</a>									
properties	minOcc 0 maxOcc 1 content simple									
facets	<table border="1"> <thead> <tr> <th>Kind</th> <th>Value</th> <th>Annotation</th> </tr> </thead> <tbody> <tr> <td>enumeration</td> <td>0060001</td> <td>documentation ja</td> </tr> <tr> <td>enumeration</td> <td>0060002</td> <td>documentation nein</td> </tr> </tbody> </table>	Kind	Value	Annotation	enumeration	0060001	documentation ja	enumeration	0060002	documentation nein
Kind	Value	Annotation								
enumeration	0060001	documentation ja								
enumeration	0060002	documentation nein								
source	<code>&lt;element name="POA_NierenersatzSchluessel" type="enum_0060" minOccurs="0"/&gt;</code>									

element **PostoperationAortenklappeBasis/POA\_MaxKreatininMikromol**

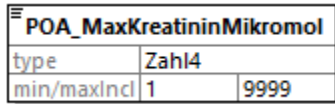
diagram										
type	<a href="#">Zahl4</a>									
properties	content simple									
facets	<table border="1"> <thead> <tr> <th>Kind</th> <th>Value</th> <th>Annotation</th> </tr> </thead> <tbody> <tr> <td>minInclusive</td> <td>1</td> <td></td> </tr> <tr> <td>maxInclusive</td> <td>9999</td> <td></td> </tr> </tbody> </table>	Kind	Value	Annotation	minInclusive	1		maxInclusive	9999	
Kind	Value	Annotation								
minInclusive	1									
maxInclusive	9999									
source	<code>&lt;element name="POA_MaxKreatininMikromol" type="Zahl4"/&gt;</code>									

element **PostoperationAortenklappeBasis/POA\_MaxKreatininMgDI**

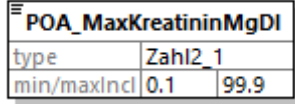
diagram																
type	<a href="#">Zahl2_1</a>															
properties	content simple															
facets	<table border="1"> <thead> <tr> <th>Kind</th> <th>Value</th> <th>Annotation</th> </tr> </thead> <tbody> <tr> <td>minInclusive</td> <td>0.1</td> <td></td> </tr> <tr> <td>maxInclusive</td> <td>99.9</td> <td></td> </tr> <tr> <td>totalDigits</td> <td>3</td> <td></td> </tr> <tr> <td>fractionDigits</td> <td>1</td> <td></td> </tr> </tbody> </table>	Kind	Value	Annotation	minInclusive	0.1		maxInclusive	99.9		totalDigits	3		fractionDigits	1	
Kind	Value	Annotation														
minInclusive	0.1															
maxInclusive	99.9															
totalDigits	3															
fractionDigits	1															
source	<code>&lt;element name="POA_MaxKreatininMgDI" type="Zahl2_1"/&gt;</code>															



element **PostoperationAortenklappeBasis/POA\_MaxKreatininUnbekannt**

diagram							
type	<a href="#">JaLeer</a>						
properties	content simple						
facets	<table border="1"> <thead> <tr> <th>Kind</th> <th>Value</th> <th>Annotation</th> </tr> </thead> <tbody> <tr> <td>pattern</td> <td>(1)</td> <td></td> </tr> </tbody> </table>	Kind	Value	Annotation	pattern	(1)	
Kind	Value	Annotation					
pattern	(1)						
source	<code>&lt;element name="POA_MaxKreatininUnbekannt" type="JaLeer"/&gt;</code>						

element **PostoperationAortenklappeBasis/POA\_BlutungSchluessel**

diagram																
type	<a href="#">enum_0384</a>															
properties	content simple															
facets	<table border="1"> <thead> <tr> <th>Kind</th> <th>Value</th> <th>Annotation</th> </tr> </thead> <tbody> <tr> <td>enumeration</td> <td>0384001</td> <td>documentation keine Blutungskomplikationen</td> </tr> <tr> <td>enumeration</td> <td>0384002</td> <td>documentation Geringfügige Blutung (Minor Bleeding - BARC type 2 or 3a)</td> </tr> <tr> <td>enumeration</td> <td>0384003</td> <td>documentation Starke Blutung (Major Bleeding - BARC type 3a)</td> </tr> <tr> <td>enumeration</td> <td>0384004</td> <td>documentation Lebensbedrohliche Blutung (Life-threatening or disabling bleeding - BARC type 3b or 3c or type 5)</td> </tr> </tbody> </table>	Kind	Value	Annotation	enumeration	0384001	documentation keine Blutungskomplikationen	enumeration	0384002	documentation Geringfügige Blutung (Minor Bleeding - BARC type 2 or 3a)	enumeration	0384003	documentation Starke Blutung (Major Bleeding - BARC type 3a)	enumeration	0384004	documentation Lebensbedrohliche Blutung (Life-threatening or disabling bleeding - BARC type 3b or 3c or type 5)
Kind	Value	Annotation														
enumeration	0384001	documentation keine Blutungskomplikationen														
enumeration	0384002	documentation Geringfügige Blutung (Minor Bleeding - BARC type 2 or 3a)														
enumeration	0384003	documentation Starke Blutung (Major Bleeding - BARC type 3a)														
enumeration	0384004	documentation Lebensbedrohliche Blutung (Life-threatening or disabling bleeding - BARC type 3b or 3c or type 5)														
source	<code>&lt;element name="POA_BlutungSchluessel" type="enum_0384"/&gt;</code>															

element **PostoperationAortenklappeBasis/POA\_ZugangKomplikationenSchluessel**

diagram																
type	<a href="#">enum_0379</a>															
properties	content simple															
facets	<table border="1"> <thead> <tr> <th>Kind</th> <th>Value</th> <th>Annotation</th> </tr> </thead> <tbody> <tr> <td>enumeration</td> <td>0379001</td> <td>documentation Keine gefäss- oder zugangsassoziierte Komplikationen</td> </tr> <tr> <td>enumeration</td> <td>0379002</td> <td>documentation Versagen des perkutanen Verschlusssystems</td> </tr> <tr> <td>enumeration</td> <td>0379003</td> <td>documentation Geringfügige Gefäßkomplikationen</td> </tr> <tr> <td>enumeration</td> <td>0379004</td> <td>documentation Erhebliche Gefäßkomplikationen</td> </tr> </tbody> </table>	Kind	Value	Annotation	enumeration	0379001	documentation Keine gefäss- oder zugangsassoziierte Komplikationen	enumeration	0379002	documentation Versagen des perkutanen Verschlusssystems	enumeration	0379003	documentation Geringfügige Gefäßkomplikationen	enumeration	0379004	documentation Erhebliche Gefäßkomplikationen
Kind	Value	Annotation														
enumeration	0379001	documentation Keine gefäss- oder zugangsassoziierte Komplikationen														
enumeration	0379002	documentation Versagen des perkutanen Verschlusssystems														
enumeration	0379003	documentation Geringfügige Gefäßkomplikationen														
enumeration	0379004	documentation Erhebliche Gefäßkomplikationen														
source	<code>&lt;element name="POA_ZugangKomplikationenSchluessel" type="enum_0379"/&gt;</code>															

element **PostoperationAortenklappeBasis/POA\_HerzrhythmusSchluessel**

diagram																
type	<a href="#">enum 0385</a>															
properties	minOcc 0 maxOcc 1 content simple															
facets	<table border="1"> <thead> <tr> <th>Kind</th> <th>Value</th> <th>Annotation</th> </tr> </thead> <tbody> <tr> <td>enumeration</td> <td>0385001</td> <td>documentation Sinusrhythmus</td> </tr> <tr> <td>enumeration</td> <td>0385002</td> <td>documentation Vorhofflimmern</td> </tr> <tr> <td>enumeration</td> <td>0385003</td> <td>documentation Patient verstorben (kein Herzrhythmus)</td> </tr> <tr> <td>enumeration</td> <td>0385042</td> <td>documentation anderer Rhythmus</td> </tr> </tbody> </table>	Kind	Value	Annotation	enumeration	0385001	documentation Sinusrhythmus	enumeration	0385002	documentation Vorhofflimmern	enumeration	0385003	documentation Patient verstorben (kein Herzrhythmus)	enumeration	0385042	documentation anderer Rhythmus
Kind	Value	Annotation														
enumeration	0385001	documentation Sinusrhythmus														
enumeration	0385002	documentation Vorhofflimmern														
enumeration	0385003	documentation Patient verstorben (kein Herzrhythmus)														
enumeration	0385042	documentation anderer Rhythmus														
source	<code>&lt;element name="POA_HerzrhythmusSchluessel" type="enum_0385" minOccurs="0"/&gt;</code>															

element **PostoperationAortenklappeBasis/POA\_VorhofflimmernSchluessel**

diagram										
type	<a href="#">enum 0060</a>									
properties	minOcc 0 maxOcc 1 content simple									
facets	<table border="1"> <thead> <tr> <th>Kind</th> <th>Value</th> <th>Annotation</th> </tr> </thead> <tbody> <tr> <td>enumeration</td> <td>0060001</td> <td>documentation ja</td> </tr> <tr> <td>enumeration</td> <td>0060002</td> <td>documentation nein</td> </tr> </tbody> </table>	Kind	Value	Annotation	enumeration	0060001	documentation ja	enumeration	0060002	documentation nein
Kind	Value	Annotation								
enumeration	0060001	documentation ja								
enumeration	0060002	documentation nein								
source	<code>&lt;element name="POA_VorhofflimmernSchluessel" type="enum_0060" minOccurs="0"/&gt;</code>									

element **PostoperationAortenklappeBasis/POA\_AvBlockSchluessel**

diagram										
type	<a href="#">enum 0060</a>									
properties	minOcc 0 maxOcc 1 content simple									
facets	<table border="1"> <thead> <tr> <th>Kind</th> <th>Value</th> <th>Annotation</th> </tr> </thead> <tbody> <tr> <td>enumeration</td> <td>0060001</td> <td>documentation ja</td> </tr> <tr> <td>enumeration</td> <td>0060002</td> <td>documentation nein</td> </tr> </tbody> </table>	Kind	Value	Annotation	enumeration	0060001	documentation ja	enumeration	0060002	documentation nein
Kind	Value	Annotation								
enumeration	0060001	documentation ja								
enumeration	0060002	documentation nein								
source	<code>&lt;element name="POA_AvBlockSchluessel" type="enum_0060" minOccurs="0"/&gt;</code>									

element **PostoperationAortenklappeBasis/POA\_SchrittmacherSchluessel**

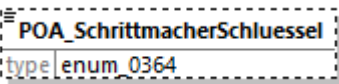
diagram																			
type	<a href="#">enum 0364</a>																		
properties	minOcc 0 maxOcc 1 content simple																		
facets	<table border="1"> <thead> <tr> <th>Kind</th> <th>Value</th> <th>Annotation</th> </tr> </thead> <tbody> <tr> <td>enumeration</td> <td>0364001</td> <td>documentation nein</td> </tr> <tr> <td>enumeration</td> <td>0364002</td> <td>documentation Schrittmacher ohne CRT-System</td> </tr> <tr> <td>enumeration</td> <td>0364003</td> <td>documentation Schrittmacher mit CRT-System</td> </tr> <tr> <td>enumeration</td> <td>0364004</td> <td>documentation Defibrillator ohne CRT-System</td> </tr> <tr> <td>enumeration</td> <td>0364005</td> <td>documentation Defibrillator mit CRT-System</td> </tr> </tbody> </table>	Kind	Value	Annotation	enumeration	0364001	documentation nein	enumeration	0364002	documentation Schrittmacher ohne CRT-System	enumeration	0364003	documentation Schrittmacher mit CRT-System	enumeration	0364004	documentation Defibrillator ohne CRT-System	enumeration	0364005	documentation Defibrillator mit CRT-System
Kind	Value	Annotation																	
enumeration	0364001	documentation nein																	
enumeration	0364002	documentation Schrittmacher ohne CRT-System																	
enumeration	0364003	documentation Schrittmacher mit CRT-System																	
enumeration	0364004	documentation Defibrillator ohne CRT-System																	
enumeration	0364005	documentation Defibrillator mit CRT-System																	
source	<code>&lt;element name="POA_SchrittmacherSchluessel" type="enum_0364" minOccurs="0"/&gt;</code>																		

element **PostoperationAortenklappeBasis/POA\_SepsisSchluessel**

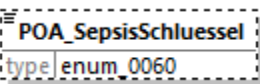
diagram										
type	<a href="#">enum 0060</a>									
properties	minOcc 0 maxOcc 1 content simple									
facets	<table border="1"> <thead> <tr> <th>Kind</th> <th>Value</th> <th>Annotation</th> </tr> </thead> <tbody> <tr> <td>enumeration</td> <td>0060001</td> <td>documentation ja</td> </tr> <tr> <td>enumeration</td> <td>0060002</td> <td>documentation nein</td> </tr> </tbody> </table>	Kind	Value	Annotation	enumeration	0060001	documentation ja	enumeration	0060002	documentation nein
Kind	Value	Annotation								
enumeration	0060001	documentation ja								
enumeration	0060002	documentation nein								
source	<code>&lt;element name="POA_SepsisSchluessel" type="enum_0060" minOccurs="0"/&gt;</code>									

element **PostoperationAortenklappeBasis/POA\_EndokarditisSchluessel**

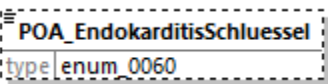
diagram										
type	<a href="#">enum 0060</a>									
properties	minOcc 0 maxOcc 1 content simple									
facets	<table border="1"> <thead> <tr> <th>Kind</th> <th>Value</th> <th>Annotation</th> </tr> </thead> <tbody> <tr> <td>enumeration</td> <td>0060001</td> <td>documentation ja</td> </tr> <tr> <td>enumeration</td> <td>0060002</td> <td>documentation nein</td> </tr> </tbody> </table>	Kind	Value	Annotation	enumeration	0060001	documentation ja	enumeration	0060002	documentation nein
Kind	Value	Annotation								
enumeration	0060001	documentation ja								
enumeration	0060002	documentation nein								
source	<code>&lt;element name="POA_EndokarditisSchluessel" type="enum_0060" minOccurs="0"/&gt;</code>									

element **PostoperationAortenklappeBasis/POA\_DeltaPmax**

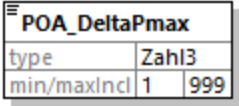
diagram										
type	<a href="#">Zahl3</a>									
properties	content simple									
facets	<table border="1"> <thead> <tr> <th>Kind</th> <th>Value</th> <th>Annotation</th> </tr> </thead> <tbody> <tr> <td>minInclusive</td> <td>1</td> <td></td> </tr> <tr> <td>maxInclusive</td> <td>999</td> <td></td> </tr> </tbody> </table>	Kind	Value	Annotation	minInclusive	1		maxInclusive	999	
Kind	Value	Annotation								
minInclusive	1									
maxInclusive	999									
source	<code>&lt;element name="POA_DeltaPmax" type="Zahl3"/&gt;</code>									

element **PostoperationAortenklappeBasis/POA\_DeltaPmaxUnbekannt**

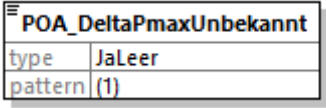
diagram							
type	<a href="#">JaLeer</a>						
properties	content simple						
facets	<table border="1"> <thead> <tr> <th>Kind</th> <th>Value</th> <th>Annotation</th> </tr> </thead> <tbody> <tr> <td>pattern</td> <td>(1)</td> <td></td> </tr> </tbody> </table>	Kind	Value	Annotation	pattern	(1)	
Kind	Value	Annotation					
pattern	(1)						
source	<code>&lt;element name="POA_DeltaPmaxUnbekannt" type="JaLeer"/&gt;</code>						

element **PostoperationAortenklappeBasis/POA\_DeltaPmean**

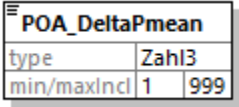
diagram										
type	<a href="#">Zahl3</a>									
properties	content simple									
facets	<table border="1"> <thead> <tr> <th>Kind</th> <th>Value</th> <th>Annotation</th> </tr> </thead> <tbody> <tr> <td>minInclusive</td> <td>1</td> <td></td> </tr> <tr> <td>maxInclusive</td> <td>999</td> <td></td> </tr> </tbody> </table>	Kind	Value	Annotation	minInclusive	1		maxInclusive	999	
Kind	Value	Annotation								
minInclusive	1									
maxInclusive	999									
source	<code>&lt;element name="POA_DeltaPmean" type="Zahl3"/&gt;</code>									

element **PostoperationAortenklappeBasis/POA\_DeltaPmeanUnbekannt**

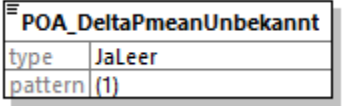
diagram							
type	<a href="#">JaLeer</a>						
properties	content simple						
facets	<table border="1"> <thead> <tr> <th>Kind</th> <th>Value</th> <th>Annotation</th> </tr> </thead> <tbody> <tr> <td>pattern</td> <td>(1)</td> <td></td> </tr> </tbody> </table>	Kind	Value	Annotation	pattern	(1)	
Kind	Value	Annotation					
pattern	(1)						

source	<code>&lt;element name="POA_DeltaPmeanUnbekannt" type="JaLeer"/&gt;</code>
--------	--

element **PostoperationAortenklappeBasis/POA\_Akoef**

diagram																
type	<a href="#">Zahl1_1</a>															
properties	content simple															
facets	<table border="1"> <thead> <tr> <th>Kind</th> <th>Value</th> <th>Annotation</th> </tr> </thead> <tbody> <tr> <td>minInclusive</td> <td>0.1</td> <td></td> </tr> <tr> <td>maxInclusive</td> <td>9.9</td> <td></td> </tr> <tr> <td>totalDigits</td> <td>2</td> <td></td> </tr> <tr> <td>fractionDigits</td> <td>1</td> <td></td> </tr> </tbody> </table>	Kind	Value	Annotation	minInclusive	0.1		maxInclusive	9.9		totalDigits	2		fractionDigits	1	
Kind	Value	Annotation														
minInclusive	0.1															
maxInclusive	9.9															
totalDigits	2															
fractionDigits	1															
source	<code>&lt;element name="POA_Akoef" type="Zahl1_1"/&gt;</code>															

element **PostoperationAortenklappeBasis/POA\_AkoefUnbekannt**

diagram							
type	<a href="#">JaLeer</a>						
properties	content simple						
facets	<table border="1"> <thead> <tr> <th>Kind</th> <th>Value</th> <th>Annotation</th> </tr> </thead> <tbody> <tr> <td>pattern</td> <td>(1)</td> <td></td> </tr> </tbody> </table>	Kind	Value	Annotation	pattern	(1)	
Kind	Value	Annotation					
pattern	(1)						
source	<code>&lt;element name="POA_AkoefUnbekannt" type="JaLeer"/&gt;</code>						

element **PostoperationAortenklappeBasis/POA\_AorteninsuffizienzSchluessel**

diagram																			
type	<a href="#">enum_0373</a>																		
properties	<table border="1"> <tbody> <tr> <td>minOcc</td> <td>0</td> </tr> <tr> <td>maxOcc</td> <td>1</td> </tr> <tr> <td>content</td> <td>simple</td> </tr> </tbody> </table>	minOcc	0	maxOcc	1	content	simple												
minOcc	0																		
maxOcc	1																		
content	simple																		
facets	<table border="1"> <thead> <tr> <th>Kind</th> <th>Value</th> <th>Annotation</th> </tr> </thead> <tbody> <tr> <td>enumeration</td> <td>0373001</td> <td>documentation keine</td> </tr> <tr> <td>enumeration</td> <td>0373002</td> <td>documentation leichtgradig</td> </tr> <tr> <td>enumeration</td> <td>0373003</td> <td>documentation mittelgradig</td> </tr> <tr> <td>enumeration</td> <td>0373004</td> <td>documentation hochgradig</td> </tr> <tr> <td>enumeration</td> <td>0373099</td> <td>documentation unbekannt</td> </tr> </tbody> </table>	Kind	Value	Annotation	enumeration	0373001	documentation keine	enumeration	0373002	documentation leichtgradig	enumeration	0373003	documentation mittelgradig	enumeration	0373004	documentation hochgradig	enumeration	0373099	documentation unbekannt
Kind	Value	Annotation																	
enumeration	0373001	documentation keine																	
enumeration	0373002	documentation leichtgradig																	
enumeration	0373003	documentation mittelgradig																	
enumeration	0373004	documentation hochgradig																	
enumeration	0373099	documentation unbekannt																	
source	<code>&lt;element name="POA_AorteninsuffizienzSchluessel" type="enum_0373"/&gt;</code>																		

	<code>minOccurs="0"/&gt;</code>
--	---------------------------------

element **PostoperationAortenklappeBasis/POA\_MitralinsuffizienzSchluessel**

diagram																			
type	<a href="#">enum 0373</a>																		
properties	minOcc 0 maxOcc 1 content simple																		
facets	<table border="1"> <thead> <tr> <th>Kind</th> <th>Value</th> <th>Annotation</th> </tr> </thead> <tbody> <tr> <td>enumeration</td> <td>0373001</td> <td>documentation keine</td> </tr> <tr> <td>enumeration</td> <td>0373002</td> <td>documentation leichtgradig</td> </tr> <tr> <td>enumeration</td> <td>0373003</td> <td>documentation mittelgradig</td> </tr> <tr> <td>enumeration</td> <td>0373004</td> <td>documentation hochgradig</td> </tr> <tr> <td>enumeration</td> <td>0373099</td> <td>documentation unbekannt</td> </tr> </tbody> </table>	Kind	Value	Annotation	enumeration	0373001	documentation keine	enumeration	0373002	documentation leichtgradig	enumeration	0373003	documentation mittelgradig	enumeration	0373004	documentation hochgradig	enumeration	0373099	documentation unbekannt
Kind	Value	Annotation																	
enumeration	0373001	documentation keine																	
enumeration	0373002	documentation leichtgradig																	
enumeration	0373003	documentation mittelgradig																	
enumeration	0373004	documentation hochgradig																	
enumeration	0373099	documentation unbekannt																	
source	<code>&lt;element name="POA_MitralinsuffizienzSchluessel" type="enum_0373" minOccurs="0"/&gt;</code>																		

element **PostoperationAortenklappeBasis/POA\_TrikuspidalinsuffizienzSchluessel**

diagram																									
type	<a href="#">enum 0360</a>																								
properties	minOcc 0 maxOcc 1 content simple																								
facets	<table border="1"> <thead> <tr> <th>Kind</th> <th>Value</th> <th>Annotation</th> </tr> </thead> <tbody> <tr> <td>enumeration</td> <td>0360001</td> <td>documentation keine</td> </tr> <tr> <td>enumeration</td> <td>0360002</td> <td>documentation leichtgradig</td> </tr> <tr> <td>enumeration</td> <td>0360003</td> <td>documentation mittelgradig</td> </tr> <tr> <td>enumeration</td> <td>0360004</td> <td>documentation hochgradig</td> </tr> <tr> <td>enumeration</td> <td>0360005</td> <td>documentation massive</td> </tr> <tr> <td>enumeration</td> <td>0360006</td> <td>documentation torrential</td> </tr> <tr> <td>enumeration</td> <td>0360099</td> <td>documentation unbekannt</td> </tr> </tbody> </table>	Kind	Value	Annotation	enumeration	0360001	documentation keine	enumeration	0360002	documentation leichtgradig	enumeration	0360003	documentation mittelgradig	enumeration	0360004	documentation hochgradig	enumeration	0360005	documentation massive	enumeration	0360006	documentation torrential	enumeration	0360099	documentation unbekannt
Kind	Value	Annotation																							
enumeration	0360001	documentation keine																							
enumeration	0360002	documentation leichtgradig																							
enumeration	0360003	documentation mittelgradig																							
enumeration	0360004	documentation hochgradig																							
enumeration	0360005	documentation massive																							
enumeration	0360006	documentation torrential																							
enumeration	0360099	documentation unbekannt																							
source	<code>&lt;element name="POA_TrikuspidalinsuffizienzSchluessel" type="enum_0360" minOccurs="0"/&gt;</code>																								

element **PostoperationAortenklappeBasis/POA\_Lvef**

diagram										
type	<a href="#">Zahl3</a>									
properties	content simple									
facets	<table border="1"> <thead> <tr> <th>Kind</th> <th>Value</th> <th>Annotation</th> </tr> </thead> <tbody> <tr> <td>minInclusive</td> <td>1</td> <td></td> </tr> <tr> <td>maxInclusive</td> <td>999</td> <td></td> </tr> </tbody> </table>	Kind	Value	Annotation	minInclusive	1		maxInclusive	999	
Kind	Value	Annotation								
minInclusive	1									
maxInclusive	999									
source	<code>&lt;element name="POA_Lvef" type="Zahl3"/&gt;</code>									

element **PostoperationAortenklappeBasis/POA\_LvefUnbekannt**

diagram							
type	<a href="#">JaLeer</a>						
properties	content simple						
facets	<table border="1"> <thead> <tr> <th>Kind</th> <th>Value</th> <th>Annotation</th> </tr> </thead> <tbody> <tr> <td>pattern</td> <td>(1)</td> <td></td> </tr> </tbody> </table>	Kind	Value	Annotation	pattern	(1)	
Kind	Value	Annotation					
pattern	(1)						
source	<code>&lt;element name="POA_LvefUnbekannt" type="JaLeer"/&gt;</code>						

element **PostoperationAortenklappeBasis/POA\_VitalstatusSchluessel**

diagram										
type	<a href="#">enum 0399</a>									
properties	content simple									
facets	<table border="1"> <thead> <tr> <th>Kind</th> <th>Value</th> <th>Annotation</th> </tr> </thead> <tbody> <tr> <td>enumeration</td> <td>0399001</td> <td>documentation Patient lebt</td> </tr> <tr> <td>enumeration</td> <td>0399002</td> <td>documentation Patient im Krankenhaus verstorben</td> </tr> </tbody> </table>	Kind	Value	Annotation	enumeration	0399001	documentation Patient lebt	enumeration	0399002	documentation Patient im Krankenhaus verstorben
Kind	Value	Annotation								
enumeration	0399001	documentation Patient lebt								
enumeration	0399002	documentation Patient im Krankenhaus verstorben								
source	<code>&lt;element name="POA_VitalstatusSchluessel" type="enum_0399"/&gt;</code>									

element **PostoperationAortenklappeBasis/POA\_TodesursacheSchluessel**

diagram							
type	<a href="#">enum 0398</a>						
properties	<table border="1"> <tbody> <tr> <td>minOcc</td> <td>0</td> </tr> <tr> <td>maxOcc</td> <td>1</td> </tr> <tr> <td>content</td> <td>simple</td> </tr> </tbody> </table>	minOcc	0	maxOcc	1	content	simple
minOcc	0						
maxOcc	1						
content	simple						

facets	Kind enumeration	Value 0398001	Annotation documentation kardiovaskuläre Ursache
	enumeration	0398002	documentation nicht-kardiovaskuläre Ursache
	enumeration	0398099	documentation Todesursache unbekannt
source	<code>&lt;element name="POA_TodesursacheSchluessel" type="enum_0398" minOccurs="0"/&gt;</code>		

### element **PostoperationAortenklappeBasis/POA\_AggregationshemmerSchluessel**

diagram			
type	<a href="#">enum 0388</a>		
properties	minOcc	0	
	maxOcc	1	
	content	simple	
facets	Kind enumeration	Value 0388001	Annotation documentation nein
	enumeration	0388002	documentation ASS
	enumeration	0388003	documentation ADP-Rezeptor-Antagonist
	enumeration	0388004	documentation Kombination ASS und ADP-Rezeptor-Antagonist
	enumeration	0388042	documentation ja, andere
	enumeration	0388099	documentation unbekannt
source	<code>&lt;element name="POA_AggregationshemmerSchluessel" type="enum_0388" minOccurs="0"/&gt;</code>		

### complexType **AntikoagulansAortenklappeBasis**

diagram			
namespace	http://xml.ir-d.de/emg		
children	<a href="#">AKA_AntikoagulansSchluessel</a>		
used by	element	<a href="#">PostoperationAortenklappe/antikoagulansAortenklappe</a>	
source	<pre>&lt;complexType name="AntikoagulansAortenklappeBasis"&gt;   &lt;sequence&gt;     &lt;element name="AKA_AntikoagulansSchluessel" type="enum_0389"/&gt;   &lt;/sequence&gt; &lt;/complexType&gt;</pre>		



element **AntikoagulansAortenklappeBasis/AKA\_AntikoagulansSchluessel**

diagram			
type	<a href="#">enum 0389</a>		
properties	content simple		
facets	Kind	Value	Annotation
	enumeration	0389001	documentation nein
	enumeration	0389002	documentation Cumarin-Derivate
	enumeration	0389003	documentation Heparinoide
	enumeration	0389004	documentation orale Thrombinantagonisten
	enumeration	0389005	documentation Kombination Heparinoide und Cumarin-Derivate
	enumeration	0389006	documentation Direkte orale Antikoagulantien (DOAK / NOAK)
	enumeration	0389042	documentation ja, andere
	enumeration	0389099	documentation unbekannt
source	<code>&lt;element name="AKA_AntikoagulansSchluessel" type="enum_0389"/&gt;</code>		

complexType **PatientenaufnahmeKardiologieBasis**

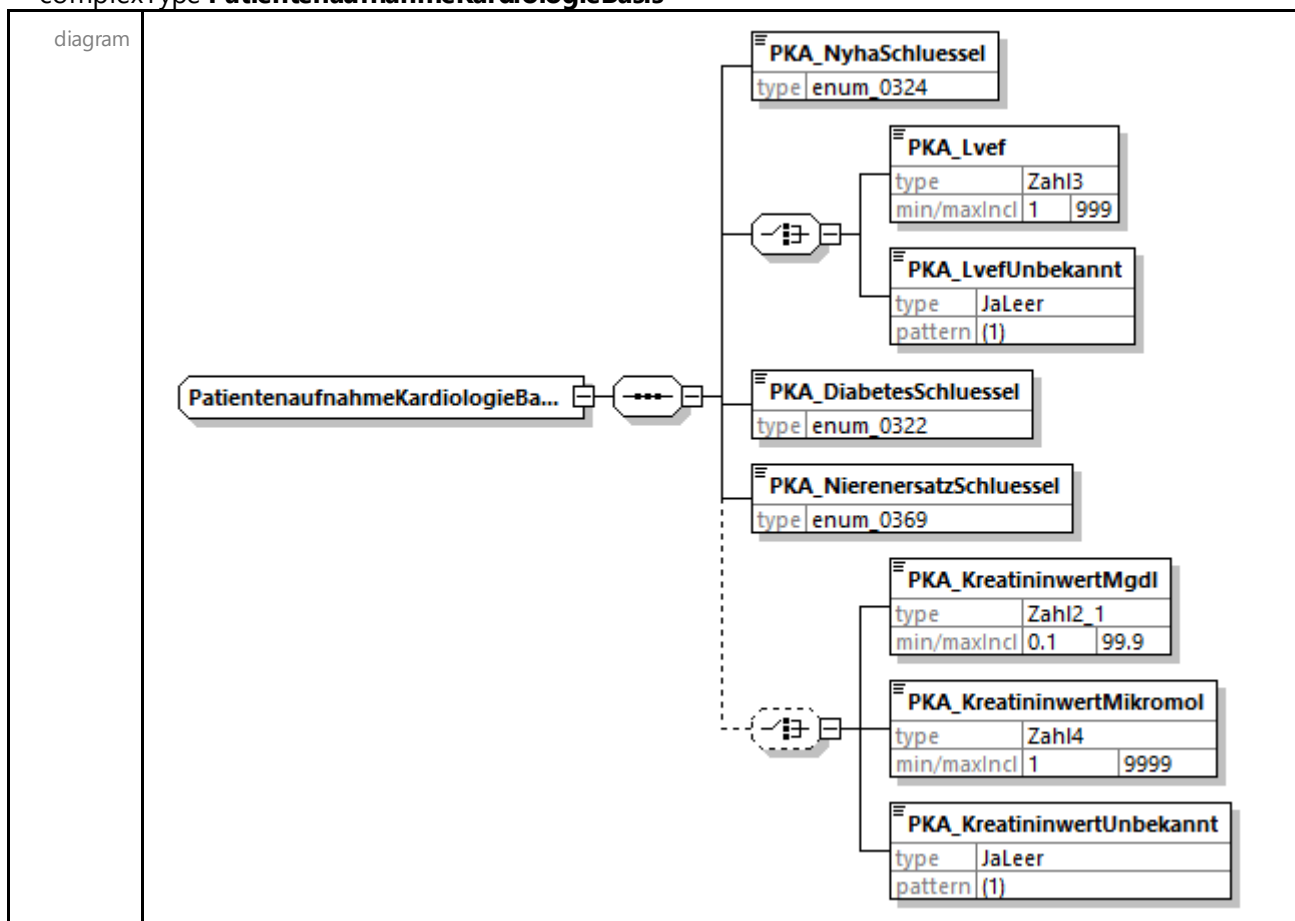

namespace	http://xml.ir-d.de/emg
children	<a href="#">PKA NyhaSchluessel</a> <a href="#">PKA Lvef</a> <a href="#">PKA LvefUnbekannt</a> <a href="#">PKA DiabetesSchluessel</a> <a href="#">PKA NierenersatzSchluessel</a> <a href="#">PKA KreatininwertMgdl</a> <a href="#">PKA KreatininwertMikromol</a> <a href="#">PKA KreatininwertUnbekannt</a>
used by	complexType <a href="#">PatientenaufnahmeKardiologie</a>
source	<pre> &lt;complexType name="PatientenaufnahmeKardiologieBasis"&gt;   &lt;sequence&gt;     &lt;element name="PKA_NyhaSchluessel" type="enum_0324"/&gt;     &lt;choice&gt;       &lt;element name="PKA_Lvef" type="Zahl3"/&gt;       &lt;element name="PKA_LvefUnbekannt" type="JaLeer"/&gt;     &lt;/choice&gt;     &lt;element name="PKA_DiabetesSchluessel" type="enum_0322"/&gt;     &lt;element name="PKA_NierenersatzSchluessel" type="enum_0369"/&gt;     &lt;choice minOccurs="0"&gt;       &lt;element name="PKA_KreatininwertMgdl" type="Zahl2_1"/&gt;       &lt;element name="PKA_KreatininwertMikromol" type="Zahl14"/&gt;       &lt;element name="PKA_KreatininwertUnbekannt" type="JaLeer"/&gt;     &lt;/choice&gt;   &lt;/sequence&gt; &lt;/complexType&gt; </pre>

#### element [PatientenaufnahmeKardiologieBasis/PKA\\_NyhaSchluessel](#)

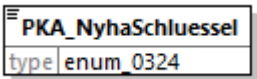
diagram																
type	<a href="#">enum 0324</a>															
properties	content simple															
facets	<table border="1"> <thead> <tr> <th>Kind</th> <th>Value</th> <th>Annotation</th> </tr> </thead> <tbody> <tr> <td>enumeration</td> <td>0324001</td> <td>documentation (I): Beschwerdefreiheit, normale körperliche Belastbarkeit</td> </tr> <tr> <td>enumeration</td> <td>0324002</td> <td>documentation (II): Beschwerden bei stärkerer körperlicher Belastung</td> </tr> <tr> <td>enumeration</td> <td>0324003</td> <td>documentation (III): Beschwerden bei leichter körperlicher Belastung</td> </tr> <tr> <td>enumeration</td> <td>0324004</td> <td>documentation (IV): Beschwerden in Ruhe</td> </tr> </tbody> </table>	Kind	Value	Annotation	enumeration	0324001	documentation (I): Beschwerdefreiheit, normale körperliche Belastbarkeit	enumeration	0324002	documentation (II): Beschwerden bei stärkerer körperlicher Belastung	enumeration	0324003	documentation (III): Beschwerden bei leichter körperlicher Belastung	enumeration	0324004	documentation (IV): Beschwerden in Ruhe
Kind	Value	Annotation														
enumeration	0324001	documentation (I): Beschwerdefreiheit, normale körperliche Belastbarkeit														
enumeration	0324002	documentation (II): Beschwerden bei stärkerer körperlicher Belastung														
enumeration	0324003	documentation (III): Beschwerden bei leichter körperlicher Belastung														
enumeration	0324004	documentation (IV): Beschwerden in Ruhe														
source	<code>&lt;element name="PKA_NyhaSchluessel" type="enum_0324"/&gt;</code>															

#### element [PatientenaufnahmeKardiologieBasis/PKA\\_Lvef](#)

diagram										
type	<a href="#">Zahl3</a>									
properties	content simple									
facets	<table border="1"> <thead> <tr> <th>Kind</th> <th>Value</th> <th>Annotation</th> </tr> </thead> <tbody> <tr> <td>minInclusive</td> <td>1</td> <td></td> </tr> <tr> <td>maxInclusive</td> <td>999</td> <td></td> </tr> </tbody> </table>	Kind	Value	Annotation	minInclusive	1		maxInclusive	999	
Kind	Value	Annotation								
minInclusive	1									
maxInclusive	999									
source	<code>&lt;element name="PKA_Lvef" type="Zahl3"/&gt;</code>									

element **PatientenaufnahmeKardiologieBasis/PKA\_LvefUnbekannt**

diagram							
type	<a href="#">JaLeer</a>						
properties	content simple						
facets	<table border="1"> <thead> <tr> <th>Kind</th> <th>Value</th> <th>Annotation</th> </tr> </thead> <tbody> <tr> <td>pattern</td> <td>(1)</td> <td></td> </tr> </tbody> </table>	Kind	Value	Annotation	pattern	(1)	
Kind	Value	Annotation					
pattern	(1)						
source	<code>&lt;element name="PKA_LvefUnbekannt" type="JaLeer"/&gt;</code>						

element **PatientenaufnahmeKardiologieBasis/PKA\_DiabetesSchluessel**

diagram																						
type	<a href="#">enum_0322</a>																					
properties	content simple																					
facets	<table border="1"> <thead> <tr> <th>Kind</th> <th>Value</th> <th>Annotation</th> </tr> </thead> <tbody> <tr> <td>enumeration</td> <td>0322001</td> <td>documentation nein</td> </tr> <tr> <td>enumeration</td> <td>0322002</td> <td>documentation ja, diätetisch behandelt</td> </tr> <tr> <td>enumeration</td> <td>0322003</td> <td>documentation ja, orale Medikation</td> </tr> <tr> <td>enumeration</td> <td>0322004</td> <td>documentation ja, mit Insulin behandelt</td> </tr> <tr> <td>enumeration</td> <td>0322005</td> <td>documentation ja, unbehandelt</td> </tr> <tr> <td>enumeration</td> <td>0322099</td> <td>documentation unbekannt</td> </tr> </tbody> </table>	Kind	Value	Annotation	enumeration	0322001	documentation nein	enumeration	0322002	documentation ja, diätetisch behandelt	enumeration	0322003	documentation ja, orale Medikation	enumeration	0322004	documentation ja, mit Insulin behandelt	enumeration	0322005	documentation ja, unbehandelt	enumeration	0322099	documentation unbekannt
Kind	Value	Annotation																				
enumeration	0322001	documentation nein																				
enumeration	0322002	documentation ja, diätetisch behandelt																				
enumeration	0322003	documentation ja, orale Medikation																				
enumeration	0322004	documentation ja, mit Insulin behandelt																				
enumeration	0322005	documentation ja, unbehandelt																				
enumeration	0322099	documentation unbekannt																				
source	<code>&lt;element name="PKA_DiabetesSchluessel" type="enum_0322"/&gt;</code>																					

element **PatientenaufnahmeKardiologieBasis/PKA\_NierenersatzSchluessel**

diagram													
type	<a href="#">enum_0369</a>												
properties	content simple												
facets	<table border="1"> <thead> <tr> <th>Kind</th> <th>Value</th> <th>Annotation</th> </tr> </thead> <tbody> <tr> <td>enumeration</td> <td>0369001</td> <td>documentation nein</td> </tr> <tr> <td>enumeration</td> <td>0369002</td> <td>documentation akut</td> </tr> <tr> <td>enumeration</td> <td>0369003</td> <td>documentation chronisch</td> </tr> </tbody> </table>	Kind	Value	Annotation	enumeration	0369001	documentation nein	enumeration	0369002	documentation akut	enumeration	0369003	documentation chronisch
Kind	Value	Annotation											
enumeration	0369001	documentation nein											
enumeration	0369002	documentation akut											
enumeration	0369003	documentation chronisch											
source	<code>&lt;element name="PKA_NierenersatzSchluessel" type="enum_0369"/&gt;</code>												

element **PatientenaufnahmeKardiologieBasis/PKA\_KreatininwertMgdl**

diagram	<pre> PKA_KreatininwertMgdl type      Zahl2_1 min/maxIncl 0.1 99.9         </pre>															
type	<a href="#">Zahl2_1</a>															
properties	content simple															
facets	<table border="1"> <thead> <tr> <th>Kind</th> <th>Value</th> <th>Annotation</th> </tr> </thead> <tbody> <tr> <td>minInclusive</td> <td>0.1</td> <td></td> </tr> <tr> <td>maxInclusive</td> <td>99.9</td> <td></td> </tr> <tr> <td>totalDigits</td> <td>3</td> <td></td> </tr> <tr> <td>fractionDigits</td> <td>1</td> <td></td> </tr> </tbody> </table>	Kind	Value	Annotation	minInclusive	0.1		maxInclusive	99.9		totalDigits	3		fractionDigits	1	
Kind	Value	Annotation														
minInclusive	0.1															
maxInclusive	99.9															
totalDigits	3															
fractionDigits	1															
source	<code>&lt;element name="PKA_KreatininwertMgdl" type="Zahl2_1"/&gt;</code>															

element **PatientenaufnahmeKardiologieBasis/PKA\_KreatininwertMikromol**

diagram	<pre> PKA_KreatininwertMikromol type      Zahl4 min/maxIncl 1 9999         </pre>									
type	<a href="#">Zahl4</a>									
properties	content simple									
facets	<table border="1"> <thead> <tr> <th>Kind</th> <th>Value</th> <th>Annotation</th> </tr> </thead> <tbody> <tr> <td>minInclusive</td> <td>1</td> <td></td> </tr> <tr> <td>maxInclusive</td> <td>9999</td> <td></td> </tr> </tbody> </table>	Kind	Value	Annotation	minInclusive	1		maxInclusive	9999	
Kind	Value	Annotation								
minInclusive	1									
maxInclusive	9999									
source	<code>&lt;element name="PKA_KreatininwertMikromol" type="Zahl4"/&gt;</code>									

element **PatientenaufnahmeKardiologieBasis/PKA\_KreatininwertUnbekannt**

diagram	<pre> PKA_KreatininwertUnbekannt type      JaLeer pattern  (1)         </pre>						
type	<a href="#">JaLeer</a>						
properties	content simple						
facets	<table border="1"> <thead> <tr> <th>Kind</th> <th>Value</th> <th>Annotation</th> </tr> </thead> <tbody> <tr> <td>pattern</td> <td>(1)</td> <td></td> </tr> </tbody> </table>	Kind	Value	Annotation	pattern	(1)	
Kind	Value	Annotation					
pattern	(1)						
source	<code>&lt;element name="PKA_KreatininwertUnbekannt" type="JaLeer"/&gt;</code>						

# complexType PatientenaufnahmeAortenklappe

diagram

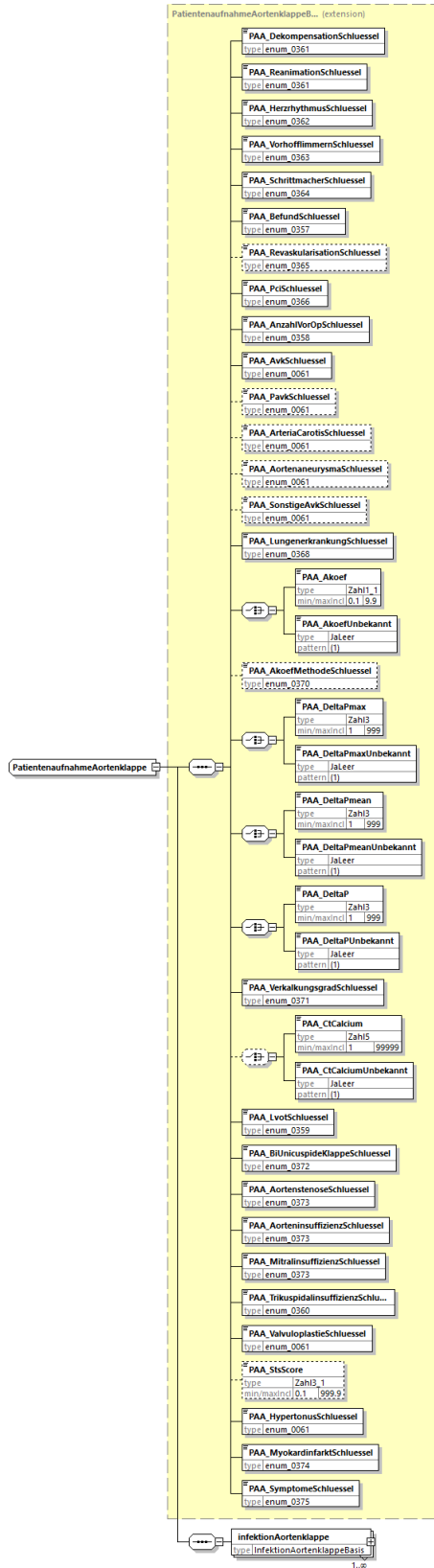

namespace	http://xml.ir-d.de/emg
type	extension of <a href="#">PatientenaufnahmeAortenklappeBasis</a>
properties	base PatientenaufnahmeAortenklappeBasis

children	<a href="#">PAA DekompensationSchluessel</a> <a href="#">PAA ReanimationSchluessel</a> <a href="#">PAA HerzrhythmusSchluessel</a> <a href="#">PAA VorhofflimmernSchluessel</a> <a href="#">PAA SchrittmacherSchluessel</a> <a href="#">PAA BefundSchluessel</a> <a href="#">PAA RevaskularisationSchluessel</a> <a href="#">PAA PciSchluessel</a> <a href="#">PAA AnzahlVorOpSchluessel</a> <a href="#">PAA AvkSchluessel</a> <a href="#">PAA PavkSchluessel</a> <a href="#">PAA ArteriaCarotisSchluessel</a> <a href="#">PAA AortenaneurysmaSchluessel</a> <a href="#">PAA SonstigeAvkSchluessel</a> <a href="#">PAA LungenerkrankungSchluessel</a> <a href="#">PAA Akoef</a> <a href="#">PAA AkoefUnbekannt</a> <a href="#">PAA AkoefMethodeSchluessel</a> <a href="#">PAA DeltaPmax</a> <a href="#">PAA DeltaPmaxUnbekannt</a> <a href="#">PAA DeltaPmean</a> <a href="#">PAA DeltaPmeanUnbekannt</a> <a href="#">PAA DeltaP</a> <a href="#">PAA DeltaPUnbekannt</a> <a href="#">PAA VerkalkungsgradSchluessel</a> <a href="#">PAA CtCalcium</a> <a href="#">PAA CtCalciumUnbekannt</a> <a href="#">PAA LvotSchluessel</a> <a href="#">PAA BiUnicuspideKlappeSchluessel</a> <a href="#">PAA AortenstenoseSchluessel</a> <a href="#">PAA AorteninsuffizienzSchluessel</a> <a href="#">PAA MitralsuffizienzSchluessel</a> <a href="#">PAA TrikuspidalinsuffizienzSchluessel</a> <a href="#">PAA ValvuloplastieSchluessel</a> <a href="#">PAA StsScore</a> <a href="#">PAA HypertonusSchluessel</a> <a href="#">PAA MyokardinfarktSchluessel</a> <a href="#">PAA SymptomeSchluessel</a> <a href="#">infektionAortenklappe</a>
used by	element <a href="#">PatientenaufnahmeKardiologie/patientenaufnahmeAortenklappe</a>
source	<pre> &lt;complexType name="PatientenaufnahmeAortenklappe"&gt;   &lt;complexContent&gt;     &lt;extension base="PatientenaufnahmeAortenklappeBasis"&gt;       &lt;sequence&gt;         &lt;element name="infektionAortenklappe" type="InfektionAortenklappeBasis" maxOccurs="unbounded"/&gt;       &lt;/sequence&gt;     &lt;/extension&gt;   &lt;/complexContent&gt; &lt;/complexType&gt; </pre>

element **PatientenaufnahmeAortenklappe/infektionAortenklappe**

diagram	
type	<a href="#">InfektionAortenklappeBasis</a>
properties	minOcc 1 maxOcc unbounded content complex
children	<a href="#">IAK InfektionSchluessel</a>
source	<pre> &lt;element name="infektionAortenklappe" type="InfektionAortenklappeBasis" maxOccurs="unbounded"/&gt; </pre>

complexType **OperationBrustimplantatBasis**

diagram	
namespace	http://xml.ir-d.de/emg
children	<a href="#">OBI_ArtEingriffSchluessel</a> <a href="#">OBI_GrundPrimaerEingriffSchluessel</a> <a href="#">OBI_GrundAustauschSchluessel</a> <a href="#">OBI_GrundRevisionExplantationSchluessel</a> <a href="#">OBI_LageSchluessel</a> <a href="#">OBI_ZugangSchluessel</a> <a href="#">OBI_EntfernungAdmNetzSchluessel</a> <a href="#">OBI_VerfahrenswechselSchluessel</a>
used by	complexType <a href="#">OperationBrustimplantat</a>
source	<pre> &lt;complexType name="OperationBrustimplantatBasis"&gt;   &lt;sequence&gt;     &lt;element name="OBI_ArtEingriffSchluessel" type="enum_0100"/&gt;     &lt;choice&gt;       &lt;element name="OBI_GrundPrimaerEingriffSchluessel" type="enum_0102"/&gt;       &lt;element name="OBI_GrundAustauschSchluessel" type="enum_0104"/&gt;       &lt;element name="OBI_GrundRevisionExplantationSchluessel" type="enum_0106"/&gt;     &lt;/choice&gt;     &lt;element name="OBI_LageSchluessel" type="enum_0112" minOccurs="0"/&gt;     &lt;element name="OBI_ZugangSchluessel" type="enum_0118" minOccurs="0"/&gt;     &lt;element name="OBI_EntfernungAdmNetzSchluessel" type="enum_0114" minOccurs="0"/&gt;     &lt;element name="OBI_VerfahrenswechselSchluessel" type="enum_0111" minOccurs="0"/&gt;   &lt;/sequence&gt; &lt;/complexType&gt; </pre>

element **OperationBrustimplantatBasis/OBI\_ArtEingriffSchluessel**

diagram	
type	<a href="#">enum 0100</a>

properties	content simple		
facets	Kind	Value	Annotation
	enumeration	0100001	documentation Primäreingriff
	enumeration	0100002	documentation Austausch Expander gegen dauerhaftes Brustimplantat
	enumeration	0100003	documentation Revision
	enumeration	0100004	documentation Nur Explantation
source	<code>&lt;element name="OBI_ArtEingriffSchluessel" type="enum_0100"/&gt;</code>		

#### element **OperationBrustimplantatBasis/OBI\_GrundPrimaerEingriffSchluessel**

diagram			
type	<a href="#">enum 0102</a>		
properties	content simple		
facets	Kind	Value	Annotation
	enumeration	0102001	documentation kosmetische Augmentation
	enumeration	0102002	documentation Rekonstruktion, benigne
	enumeration	0102003	documentation Rekonstruktion nach Mastektomie aufgrund eines Karzinoms
	enumeration	0102004	documentation Rekonstruktion nach risikoreduzierender Mastektomie
source	<code>&lt;element name="OBI_GrundPrimaerEingriffSchluessel" type="enum_0102"/&gt;</code>		

#### element **OperationBrustimplantatBasis/OBI\_GrundAustauschSchluessel**

diagram			
type	<a href="#">enum 0104</a>		
properties	content simple		
facets	Kind	Value	Annotation
	enumeration	0104001	documentation Austausch Expander gegen dauerhaftes Brustimplantat
source	<code>&lt;element name="OBI_GrundAustauschSchluessel" type="enum_0104"/&gt;</code>		

#### element **OperationBrustimplantatBasis/OBI\_GrundRevisionExplantationSchluessel**

diagram			
type	<a href="#">enum 0106</a>		
properties	content simple		
facets	Kind	Value	Annotation
	enumeration	0106001	documentation



	enumeration 0106002	Patientenwunsch documentation asymptomatisch
	enumeration 0106003	documentation Komplikation
source	<element name="OBI_GrundRevisionExplantationSchluessel" type="enum_0106"/>	

### element **OperationBrustimplantatBasis/OBI\_LageSchluessel**

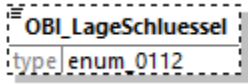
diagram			
type	<a href="#">enum 0112</a>		
properties	minOcc 0 maxOcc 1 content simple		
facets	Kind	Value	Annotation
	enumeration	0112001	documentation subglandulär / epipektoral
	enumeration	0112002	documentation subpektoral
	enumeration	0112003	documentation subfaszial
	enumeration	0112004	documentation sub-flap
	enumeration	0112005	documentation subkutan
	enumeration	0112006	documentation dual plane
	enumeration	0112042	documentation andere
source	<element name="OBI_LageSchluessel" type="enum_0112" minOccurs="0"/>		

### element **OperationBrustimplantatBasis/OBI\_ZugangSchluessel**

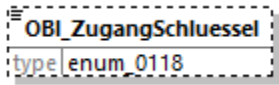
diagram			
type	<a href="#">enum 0118</a>		
properties	minOcc 0 maxOcc 1 content simple		
facets	Kind	Value	Annotation
	enumeration	0118001	documentation axillär
	enumeration	0118002	documentation periareolär
	enumeration	0118003	documentation inframammär
	enumeration	0118004	documentation Mastektomienarbe
	enumeration	0118042	documentation anderer
source	<element name="OBI_ZugangSchluessel" type="enum_0118" minOccurs="0"/>		

element **OperationBrustimplantatBasis/OBI\_EntfernungAdmNetzSchluessel**

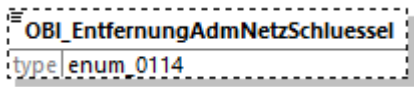
diagram																
type	<a href="#">enum 0114</a>															
properties	minOcc 0 maxOcc 1 content simple															
facets	<table border="1"> <thead> <tr> <th>Kind</th> <th>Value</th> <th>Annotation</th> </tr> </thead> <tbody> <tr> <td>enumeration</td> <td>0114001</td> <td>documentation vollständig</td> </tr> <tr> <td>enumeration</td> <td>0114002</td> <td>documentation nein</td> </tr> <tr> <td>enumeration</td> <td>0114003</td> <td>documentation teilweise</td> </tr> <tr> <td>enumeration</td> <td>0114004</td> <td>documentation nicht vorhanden</td> </tr> </tbody> </table>	Kind	Value	Annotation	enumeration	0114001	documentation vollständig	enumeration	0114002	documentation nein	enumeration	0114003	documentation teilweise	enumeration	0114004	documentation nicht vorhanden
Kind	Value	Annotation														
enumeration	0114001	documentation vollständig														
enumeration	0114002	documentation nein														
enumeration	0114003	documentation teilweise														
enumeration	0114004	documentation nicht vorhanden														
source	<code>&lt;element name="OBI_EntfernungAdmNetzSchluessel" type="enum_0114" minOccurs="0"/&gt;</code>															

element **OperationBrustimplantatBasis/OBI\_VerfahrenswechselSchluessel**

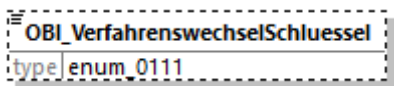
diagram													
type	<a href="#">enum 0111</a>												
properties	minOcc 0 maxOcc 1 content simple												
facets	<table border="1"> <thead> <tr> <th>Kind</th> <th>Value</th> <th>Annotation</th> </tr> </thead> <tbody> <tr> <td>enumeration</td> <td>0111001</td> <td>documentation nein</td> </tr> <tr> <td>enumeration</td> <td>0111002</td> <td>documentation Lipofilling</td> </tr> <tr> <td>enumeration</td> <td>0111003</td> <td>documentation Eigengewebstrekonstruktion</td> </tr> </tbody> </table>	Kind	Value	Annotation	enumeration	0111001	documentation nein	enumeration	0111002	documentation Lipofilling	enumeration	0111003	documentation Eigengewebstrekonstruktion
Kind	Value	Annotation											
enumeration	0111001	documentation nein											
enumeration	0111002	documentation Lipofilling											
enumeration	0111003	documentation Eigengewebstrekonstruktion											
source	<code>&lt;element name="OBI_VerfahrenswechselSchluessel" type="enum_0111" minOccurs="0"/&gt;</code>												

complexType **VorbehandlungBrustimplantatBasis**

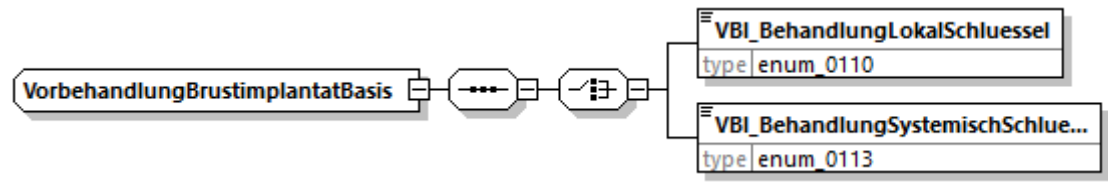
diagram	
namespace	http://xml.ir-d.de/emg
children	<a href="#">VBI_BehandlungLokalSchluessel</a> <a href="#">VBI_BehandlungSystemischSchluessel</a>
used by	element <a href="#">OperationBrustimplantat/vorbehandlungBrustimplantat</a>
source	<code>&lt;complexType name="VorbehandlungBrustimplantatBasis"&gt; &lt;sequence&gt;</code>

	<pre> &lt;choice&gt;   &lt;element name="VBI_BehandlungLokalSchluessel" type="enum_0110"/&gt;   &lt;element name="VBI_BehandlungSystemischSchluessel" type="enum_0113"/&gt; &lt;/choice&gt; &lt;/sequence&gt; &lt;/complexType&gt; </pre>
--	---

element **VorbehandlungBrustimplantatBasis/VBI\_BehandlungLokalSchluessel**

diagram							
type	<a href="#">enum 0110</a>						
properties	content simple						
facets	<table border="1"> <thead> <tr> <th>Kind</th> <th>Value</th> <th>Annotation</th> </tr> </thead> <tbody> <tr> <td>enumeration</td> <td>0110001</td> <td>documentation Bestrahlung</td> </tr> </tbody> </table>	Kind	Value	Annotation	enumeration	0110001	documentation Bestrahlung
Kind	Value	Annotation					
enumeration	0110001	documentation Bestrahlung					
source	<code>&lt;element name="VBI_BehandlungLokalSchluessel" type="enum_0110"/&gt;</code>						

element **VorbehandlungBrustimplantatBasis/VBI\_BehandlungSystemischSchluessel**

diagram							
type	<a href="#">enum 0113</a>						
properties	content simple						
facets	<table border="1"> <thead> <tr> <th>Kind</th> <th>Value</th> <th>Annotation</th> </tr> </thead> <tbody> <tr> <td>enumeration</td> <td>0113001</td> <td>documentation Chemotherapie innerhalb der letzten drei Monate</td> </tr> </tbody> </table>	Kind	Value	Annotation	enumeration	0113001	documentation Chemotherapie innerhalb der letzten drei Monate
Kind	Value	Annotation					
enumeration	0113001	documentation Chemotherapie innerhalb der letzten drei Monate					
source	<code>&lt;element name="VBI_BehandlungSystemischSchluessel" type="enum_0113"/&gt;</code>						

complexType **MassnahmeBrustimplantatBasis**

diagram	
namespace	http://xml.ir-d.de/emg
children	<a href="#">MAB_MassnahmeSchluessel</a>
used by	element <a href="#">OperationBrustimplantat/massnahmeBrustimplantat</a>
source	<pre> &lt;complexType name="MassnahmeBrustimplantatBasis"&gt;   &lt;sequence&gt;     &lt;element name="MAB_MassnahmeSchluessel" type="enum_0116"/&gt;   &lt;/sequence&gt; &lt;/complexType&gt; </pre>

element **MassnahmeBrustimplantatBasis/MAB\_MassnahmeSchluessel**

diagram			
type	<a href="#">enum 0116</a>		
properties	content simple		
facets	Kind	Value	Annotation
	enumeration	0116001	documentation Spülung, antibiotisch
	enumeration	0116002	documentation Spülung, antiseptisch
	enumeration	0116003	documentation Spülung, wirkstofffrei
	enumeration	0116004	documentation Spülung, andere
	enumeration	0116005	documentation prä-/perioperative Antibiotika
	enumeration	0116006	documentation postoperative Antibiotika
	enumeration	0116007	documentation Handschuhwechsel vor Implantation
	enumeration	0116008	documentation Implantationshilfe
source	<pre>&lt;element name="MAB_MassnahmeSchluessel" type="enum_0116"/&gt;</pre>		

complexType **OperationsdetailBrustimplantatBasis**

diagram			
namespace	http://xml.ir-d.de/emg		
children	<a href="#">ODB_OperationsdetailPrimaerEingriffSchluessel</a> <a href="#">ODB_OperationsdetailAustauschSchluessel</a> <a href="#">ODB_OperationsdetailRevisionSchluessel</a>		
used by	element	<a href="#">OperationBrustimplantat/operationsdetailBrustimplantat</a>	
source	<pre>&lt;complexType name="OperationsdetailBrustimplantatBasis"&gt;   &lt;sequence&gt;     &lt;choice&gt;       &lt;element name="ODB_OperationsdetailPrimaerEingriffSchluessel" type="enum_0103"/&gt;       &lt;element name="ODB_OperationsdetailAustauschSchluessel" type="enum_0105"/&gt;       &lt;element name="ODB_OperationsdetailRevisionSchluessel" type="enum_0107"/&gt;     &lt;/choice&gt;   &lt;/sequence&gt; &lt;/complexType&gt;</pre>		

element **OperationsdetailBrustimplantatBasis/ODB\_OperationsdetailPrimaerEingriffSchluessel**

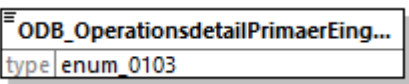
diagram			
type	<a href="#">enum 0103</a>		
properties	content simple		
facets	Kind	Value	Annotation
	enumeration	0103001	documentation simultane Lappendeckung
	enumeration	0103002	documentation simultane Eigenfetttransplantation
	enumeration	0103003	documentation simultane Mastopexie
	enumeration	0103005	documentation simultane Mastektomie, Ablatio / hautsparend
	enumeration	0103006	documentation simultane Mastektomie, nippelerhaltend
	enumeration	0103007	documentation Axilla-Dissektion
	enumeration	0103008	documentation Drainage
source	<pre>&lt;element name="ODB_OperationsdetailPrimaerEingriffSchluessel" type="enum_0103"/&gt;</pre>		

element **OperationsdetailBrustimplantatBasis/ODB\_OperationsdetailAustauschSchluessel**

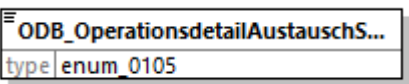
diagram			
type	<a href="#">enum 0105</a>		
properties	content simple		
facets	Kind	Value	Annotation
	enumeration	0105001	documentation simultane Lappendeckung
	enumeration	0105002	documentation simultane Eigenfetttransplantation
	enumeration	0105003	documentation simultane Mastopexie
	enumeration	0105008	documentation Drainage
	enumeration	0105009	documentation Kapsulektomie, komplett
	enumeration	0105010	documentation Kapsulektomie, partiell
	enumeration	0105011	documentation Neopocket
source	<pre>&lt;element name="ODB_OperationsdetailAustauschSchluessel" type="enum_0105"/&gt;</pre>		

element **OperationsdetailBrustimplantatBasis/ODB\_OperationsdetailRevisionSchluessel**

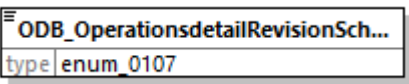
diagram			
type	<a href="#">enum 0107</a>		

properties	content simple		
facets	Kind	Value	Annotation
	enumeration	0107001	documentation simultane Lappendeckung
	enumeration	0107002	documentation simultane Eigenfetttransplantation
	enumeration	0107003	documentation simultane Mastopexie
	enumeration	0107005	documentation simultane Mastektomie, Ablatio / hautsparend
	enumeration	0107006	documentation simultane Mastektomie, nippelerhaltend
	enumeration	0107007	documentation Axilla-Dissektion
	enumeration	0107008	documentation Drainage
	enumeration	0107009	documentation Kapsulektomie, komplett
	enumeration	0107010	documentation Kapsulektomie, partiell
	enumeration	0107011	documentation Neopocket
source	<code>&lt;element name="ODB_OperationsdetailRevisionSchluessel" type="enum_0107"/&gt;</code>		

### complexType **BefundBrustimplantatBasis**

diagram	
namespace	http://xml.ir-d.de/emg
children	<a href="#">BEB_BefundSchluessel</a> <a href="#">BEB_BefundAustauschSchluessel</a>
used by	element <a href="#">OperationBrustimplantat/befundBrustimplantat</a>
source	<pre> &lt;complexType name="BefundBrustimplantatBasis"&gt;   &lt;sequence&gt;     &lt;choice&gt;       &lt;element name="BEB_BefundSchluessel" type="enum_0121"/&gt;       &lt;element name="BEB_BefundAustauschSchluessel" type="enum_0120"/&gt;     &lt;/choice&gt;   &lt;/sequence&gt; &lt;/complexType&gt; </pre>

### element **BefundBrustimplantatBasis/BEB\_BefundSchluessel**

diagram							
type	<a href="#">enum 0121</a>						
properties	content simple						
facets	<table border="1"> <tr> <td>Kind</td> <td>Value</td> <td>Annotation</td> </tr> <tr> <td>enumeration</td> <td>0121001</td> <td>documentation</td> </tr> </table>	Kind	Value	Annotation	enumeration	0121001	documentation
Kind	Value	Annotation					
enumeration	0121001	documentation					

	enumeration	0121002	Infektion documentation Serom
	enumeration	0121003	documentation Hämatom
	enumeration	0121004	documentation Kapsel fibrose
	enumeration	0121005	documentation Implantatruptur
	enumeration	0121006	documentation Fehlpositionierung/Rotation
	enumeration	0121007	documentation BIA-ALCL/-SCC, Verdacht
	enumeration	0121008	documentation BIA-ALCL/-SCC, pathologisch bestätigt
	enumeration	0121009	documentation Brustschmerzen
	enumeration	0121010	documentation Doppelkapsel
	enumeration	0121011	documentation Netz-/ADM-bedingte Komplikation, Non-Integration
	enumeration	0121012	documentation Netz-/ADM-bedingte Komplikation, andere
	enumeration	0121013	documentation Hautnekrose/exponiertes Implantat
	enumeration	0121014	documentation BII/ASIA (Brustimplantat assoziierte Symptome), Verdacht
	enumeration	0121015	documentation Lymphadenopathie
	enumeration	0121016	documentation Brustkrebs, neu aufgetreten/Rezidiv
source	<code>&lt;element name="BEB_BefundSchluessel" type="enum_0121"/&gt;</code>		

#### element **BefundBrustimplantatBasis/BEB\_BefundAustauschSchluessel**

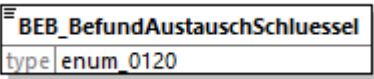
diagram			
type	<a href="#">enum 0120</a>		
properties	content simple		
facets	Kind	Value	Annotation
	enumeration	0120001	documentation Expander defekt
source	<code>&lt;element name="BEB_BefundAustauschSchluessel" type="enum_0120"/&gt;</code>		

#### complexType **ProzedurenSchluesselBrustimplantatBasis**

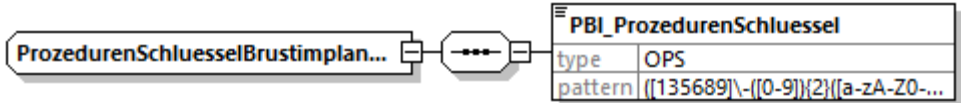
diagram			
namespace	http://xml.ir-d.de/emg		
children	<a href="#">PBI_ProzedurenSchluessel</a>		
used by	element	<a href="#">OperationBrustimplantat/prozedurenSchluesselBrustimplantat</a>	

source	<pre>&lt;complexType name="ProzedurenSchluesselBrustimplantatBasis"&gt;   &lt;sequence&gt;     &lt;element name="PBI_ProzedurenSchluessel" type="OPS"/&gt;   &lt;/sequence&gt; &lt;/complexType&gt;</pre>
--------	---

element **ProzedurenSchluesselBrustimplantatBasis/PBI\_ProzedurenSchluessel**

diagram							
type	<a href="#">OPS</a>						
properties	content simple						
facets	<table border="1"> <thead> <tr> <th>Kind</th> <th>Value</th> <th>Annotation</th> </tr> </thead> <tbody> <tr> <td>pattern</td> <td>(([135689]\-[0-9]){2}([a-zA-Z0-9]{1}\.[a-zA-Z0-9]{1,2}))*(:[RLBrlb])?</td> <td></td> </tr> </tbody> </table>	Kind	Value	Annotation	pattern	(([135689]\-[0-9]){2}([a-zA-Z0-9]{1}\.[a-zA-Z0-9]{1,2}))*(:[RLBrlb])?	
Kind	Value	Annotation					
pattern	(([135689]\-[0-9]){2}([a-zA-Z0-9]{1}\.[a-zA-Z0-9]{1,2}))*(:[RLBrlb])?						
source	<pre>&lt;element name="PBI_ProzedurenSchluessel" type="OPS"/&gt;</pre>						



complexType **OperationEndoprotheseBasis**

diagram

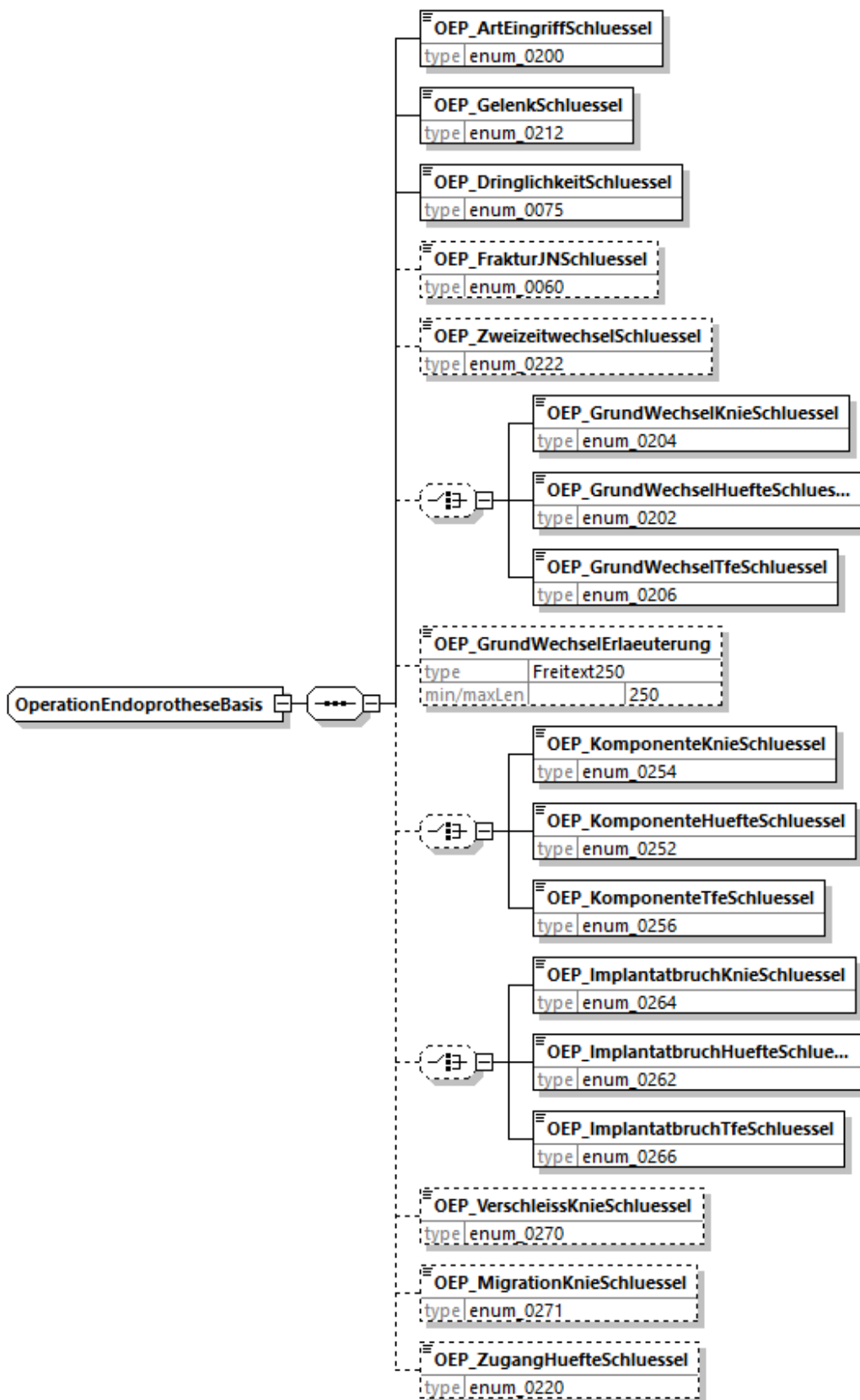

namespace <http://xml.ir-d.de/emg>

children [OEP\\_ArtEingriffSchluessel](#) [OEP\\_GelenkSchluessel](#) [OEP\\_DringlichkeitSchluessel](#) [OEP\\_FrakturJNSchluessel](#) [OEP\\_ZweizeitwechselSchluessel](#) [OEP\\_GrundWechselKnieSchluessel](#) [OEP\\_GrundWechselHuefteSchluessel](#)

	<a href="#">OEP GrundWechselTfeSchluessel</a> <a href="#">OEP GrundWechselErlaeuterung</a> <a href="#">OEP KomponenteKnieSchluessel</a> <a href="#">OEP KomponenteHuefteSchluessel</a> <a href="#">OEP KomponenteTfeSchluessel</a> <a href="#">OEP ImplantatbruchKnieSchluessel</a> <a href="#">OEP ImplantatbruchHuefteSchluessel</a> <a href="#">OEP ImplantatbruchTfeSchluessel</a> <a href="#">OEP VerschleissKnieSchluessel</a> <a href="#">OEP MigrationKnieSchluessel</a> <a href="#">OEP ZugangHuefteSchluessel</a>
used by	complexType <a href="#">OperationEndoprothese</a>
source	<pre> &lt;complexType name="OperationEndoprotheseBasis"&gt;   &lt;sequence&gt;     &lt;element name="OEP_ArtEingriffSchluessel" type="enum_0200"/&gt;     &lt;element name="OEP_GelenkSchluessel" type="enum_0212"/&gt;     &lt;element name="OEP_DringlichkeitSchluessel" type="enum_0075"/&gt;     &lt;element name="OEP_FrakturJNSchluessel" type="enum_0060" minOccurs="0"/&gt;     &lt;element name="OEP_ZweizeitwechselSchluessel" type="enum_0222" minOccurs="0"/&gt;     &lt;choice minOccurs="0"&gt;       &lt;element name="OEP_GrundWechselKnieSchluessel" type="enum_0204"/&gt;       &lt;element name="OEP_GrundWechselHuefteSchluessel" type="enum_0202"/&gt;       &lt;element name="OEP_GrundWechselTfeSchluessel" type="enum_0206"/&gt;     &lt;/choice&gt;     &lt;element name="OEP_GrundWechselErlaeuterung" type="Freitext250" minOccurs="0"/&gt;     &lt;choice minOccurs="0"&gt;       &lt;element name="OEP_KomponenteKnieSchluessel" type="enum_0254"/&gt;       &lt;element name="OEP_KomponenteHuefteSchluessel" type="enum_0252"/&gt;       &lt;element name="OEP_KomponenteTfeSchluessel" type="enum_0256"/&gt;     &lt;/choice&gt;     &lt;choice minOccurs="0"&gt;       &lt;element name="OEP_ImplantatbruchKnieSchluessel" type="enum_0264"/&gt;       &lt;element name="OEP_ImplantatbruchHuefteSchluessel" type="enum_0262"/&gt;       &lt;element name="OEP_ImplantatbruchTfeSchluessel" type="enum_0266"/&gt;     &lt;/choice&gt;     &lt;element name="OEP_VerschleissKnieSchluessel" type="enum_0270" minOccurs="0"/&gt;     &lt;element name="OEP_MigrationKnieSchluessel" type="enum_0271" minOccurs="0"/&gt;     &lt;element name="OEP_ZugangHuefteSchluessel" type="enum_0220" minOccurs="0"/&gt;   &lt;/sequence&gt; &lt;/complexType&gt; </pre>

element **OperationEndoprotheseBasis/OEP\_ArtEingriffSchluessel**

diagram										
type	<a href="#">enum 0200</a>									
properties	content simple									
facets	<table border="1"> <thead> <tr> <th>Kind</th> <th>Value</th> <th>Annotation</th> </tr> </thead> <tbody> <tr> <td>enumeration</td> <td>0200001</td> <td>documentation Erst-OP</td> </tr> <tr> <td>enumeration</td> <td>0200002</td> <td>documentation Folgeeingriff</td> </tr> </tbody> </table>	Kind	Value	Annotation	enumeration	0200001	documentation Erst-OP	enumeration	0200002	documentation Folgeeingriff
Kind	Value	Annotation								
enumeration	0200001	documentation Erst-OP								
enumeration	0200002	documentation Folgeeingriff								
source	<pre>&lt;element name="OEP_ArtEingriffSchluessel" type="enum_0200"/&gt;</pre>									

element **OperationEndoprotheseBasis/OEP\_GelenkSchluessel**

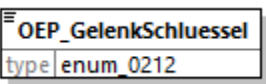
diagram													
type	<a href="#">enum 0212</a>												
properties	content simple												
facets	<table border="1"> <thead> <tr> <th>Kind</th> <th>Value</th> <th>Annotation</th> </tr> </thead> <tbody> <tr> <td>enumeration</td> <td>0212001</td> <td>documentation Hüfte</td> </tr> <tr> <td>enumeration</td> <td>0212002</td> <td>documentation Knie</td> </tr> <tr> <td>enumeration</td> <td>0212003</td> <td>documentation Totaler Femurersatz inkl. Durchsteck-Prothese</td> </tr> </tbody> </table>	Kind	Value	Annotation	enumeration	0212001	documentation Hüfte	enumeration	0212002	documentation Knie	enumeration	0212003	documentation Totaler Femurersatz inkl. Durchsteck-Prothese
Kind	Value	Annotation											
enumeration	0212001	documentation Hüfte											
enumeration	0212002	documentation Knie											
enumeration	0212003	documentation Totaler Femurersatz inkl. Durchsteck-Prothese											
source	<code>&lt;element name="OEP_GelenkSchluessel" type="enum_0212"/&gt;</code>												

element **OperationEndoprotheseBasis/OEP\_DringlichkeitSchluessel**

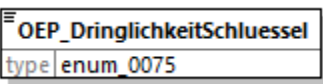
diagram													
type	<a href="#">enum 0075</a>												
properties	content simple												
facets	<table border="1"> <thead> <tr> <th>Kind</th> <th>Value</th> <th>Annotation</th> </tr> </thead> <tbody> <tr> <td>enumeration</td> <td>0075001</td> <td>documentation elektiv</td> </tr> <tr> <td>enumeration</td> <td>0075002</td> <td>documentation dringlich</td> </tr> <tr> <td>enumeration</td> <td>0075003</td> <td>documentation Notfall</td> </tr> </tbody> </table>	Kind	Value	Annotation	enumeration	0075001	documentation elektiv	enumeration	0075002	documentation dringlich	enumeration	0075003	documentation Notfall
Kind	Value	Annotation											
enumeration	0075001	documentation elektiv											
enumeration	0075002	documentation dringlich											
enumeration	0075003	documentation Notfall											
source	<code>&lt;element name="OEP_DringlichkeitSchluessel" type="enum_0075"/&gt;</code>												

element **OperationEndoprotheseBasis/OEP\_FrakturJNSchluessel**

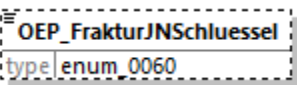
diagram										
type	<a href="#">enum 0060</a>									
properties	minOcc 0 maxOcc 1 content simple									
facets	<table border="1"> <thead> <tr> <th>Kind</th> <th>Value</th> <th>Annotation</th> </tr> </thead> <tbody> <tr> <td>enumeration</td> <td>0060001</td> <td>documentation ja</td> </tr> <tr> <td>enumeration</td> <td>0060002</td> <td>documentation nein</td> </tr> </tbody> </table>	Kind	Value	Annotation	enumeration	0060001	documentation ja	enumeration	0060002	documentation nein
Kind	Value	Annotation								
enumeration	0060001	documentation ja								
enumeration	0060002	documentation nein								
source	<code>&lt;element name="OEP_FrakturJNSchluessel" type="enum_0060" minOccurs="0"/&gt;</code>									

element **OperationEndoprotheseBasis/OEP\_ZweizeitwechselSchluessel**

diagram													
type	<a href="#">enum 0222</a>												
properties	minOcc 0 maxOcc 1 content simple												
facets	<table border="1"> <thead> <tr> <th>Kind</th> <th>Value</th> <th>Annotation</th> </tr> </thead> <tbody> <tr> <td>enumeration</td> <td>0222001</td> <td>documentation nein</td> </tr> <tr> <td>enumeration</td> <td>0222002</td> <td>documentation ja- Ausbau</td> </tr> <tr> <td>enumeration</td> <td>0222003</td> <td>documentation ja- Einbau</td> </tr> </tbody> </table>	Kind	Value	Annotation	enumeration	0222001	documentation nein	enumeration	0222002	documentation ja- Ausbau	enumeration	0222003	documentation ja- Einbau
Kind	Value	Annotation											
enumeration	0222001	documentation nein											
enumeration	0222002	documentation ja- Ausbau											
enumeration	0222003	documentation ja- Einbau											
source	<code>&lt;element name="OEP_ZweizeitwechselSchluessel" type="enum_0222" minOccurs="0"/&gt;</code>												

element **OperationEndoprotheseBasis/OEP\_GrundWechselKnieSchluessel**

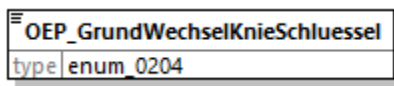
diagram																																																				
type	<a href="#">enum 0204</a>																																																			
properties	content simple																																																			
facets	<table border="1"> <thead> <tr> <th>Kind</th> <th>Value</th> <th>Annotation</th> </tr> </thead> <tbody> <tr> <td>enumeration</td> <td>0204001</td> <td>documentation Lockerung</td> </tr> <tr> <td>enumeration</td> <td>0204002</td> <td>documentation Infektion, Verdacht auf</td> </tr> <tr> <td>enumeration</td> <td>0204003</td> <td>documentation Infektion, gesichert</td> </tr> <tr> <td>enumeration</td> <td>0204006</td> <td>documentation Periprothetische Fraktur</td> </tr> <tr> <td>enumeration</td> <td>0204007</td> <td>documentation Verschleiß</td> </tr> <tr> <td>enumeration</td> <td>0204008</td> <td>documentation Implantatbruch</td> </tr> <tr> <td>enumeration</td> <td>0204009</td> <td>documentation Implantatfehlage/Malalignent</td> </tr> <tr> <td>enumeration</td> <td>0204010</td> <td>documentation Osteolysen bei festem Implantat</td> </tr> <tr> <td>enumeration</td> <td>0204011</td> <td>documentation Progression der Grunderkrankung</td> </tr> <tr> <td>enumeration</td> <td>0204012</td> <td>documentation ARMD</td> </tr> <tr> <td>enumeration</td> <td>0204013</td> <td>documentation Verdacht auf allergische Reaktion</td> </tr> <tr> <td>enumeration</td> <td>0204014</td> <td>documentation Dislokation/Migration von Komponenten</td> </tr> <tr> <td>enumeration</td> <td>0204015</td> <td>documentation Bandinstabilität</td> </tr> <tr> <td>enumeration</td> <td>0204016</td> <td>documentation Bewegungseinschränkung</td> </tr> <tr> <td>enumeration</td> <td>0204021</td> <td>documentation Zustand nach Prothesenentfernung</td> </tr> <tr> <td>enumeration</td> <td>0204042</td> <td>documentation andere Gründe</td> </tr> </tbody> </table>	Kind	Value	Annotation	enumeration	0204001	documentation Lockerung	enumeration	0204002	documentation Infektion, Verdacht auf	enumeration	0204003	documentation Infektion, gesichert	enumeration	0204006	documentation Periprothetische Fraktur	enumeration	0204007	documentation Verschleiß	enumeration	0204008	documentation Implantatbruch	enumeration	0204009	documentation Implantatfehlage/Malalignent	enumeration	0204010	documentation Osteolysen bei festem Implantat	enumeration	0204011	documentation Progression der Grunderkrankung	enumeration	0204012	documentation ARMD	enumeration	0204013	documentation Verdacht auf allergische Reaktion	enumeration	0204014	documentation Dislokation/Migration von Komponenten	enumeration	0204015	documentation Bandinstabilität	enumeration	0204016	documentation Bewegungseinschränkung	enumeration	0204021	documentation Zustand nach Prothesenentfernung	enumeration	0204042	documentation andere Gründe
Kind	Value	Annotation																																																		
enumeration	0204001	documentation Lockerung																																																		
enumeration	0204002	documentation Infektion, Verdacht auf																																																		
enumeration	0204003	documentation Infektion, gesichert																																																		
enumeration	0204006	documentation Periprothetische Fraktur																																																		
enumeration	0204007	documentation Verschleiß																																																		
enumeration	0204008	documentation Implantatbruch																																																		
enumeration	0204009	documentation Implantatfehlage/Malalignent																																																		
enumeration	0204010	documentation Osteolysen bei festem Implantat																																																		
enumeration	0204011	documentation Progression der Grunderkrankung																																																		
enumeration	0204012	documentation ARMD																																																		
enumeration	0204013	documentation Verdacht auf allergische Reaktion																																																		
enumeration	0204014	documentation Dislokation/Migration von Komponenten																																																		
enumeration	0204015	documentation Bandinstabilität																																																		
enumeration	0204016	documentation Bewegungseinschränkung																																																		
enumeration	0204021	documentation Zustand nach Prothesenentfernung																																																		
enumeration	0204042	documentation andere Gründe																																																		

source	<code>&lt;element name="OEP_GrundWechselKnieSchluessel" type="enum_0204"/&gt;</code>
--------	--

element **OperationEndoprotheseBasis/OEP\_GrundWechselHuefteSchluessel**

diagram			
type	<a href="#">enum 0202</a>		
properties	content simple		
facets	Kind	Value	Annotation
	enumeration	0202001	documentation Lockerung
	enumeration	0202002	documentation Infektion, Verdacht auf
	enumeration	0202003	documentation Infektion, gesichert
	enumeration	0202004	documentation Luxation, Inlay aus der Pfanne
	enumeration	0202005	documentation Luxation, Kopf aus Pfanne/Inlay
	enumeration	0202006	documentation Periprothetische Fraktur
	enumeration	0202007	documentation Verschleiß des PE-Inlays
	enumeration	0202008	documentation Implantatbruch
	enumeration	0202009	documentation Implantatfehlage/Malalignent
	enumeration	0202010	documentation Osteolysen bei festem Implantat
	enumeration	0202011	documentation Progression der Grunderkrankung
	enumeration	0202012	documentation ARMD
	enumeration	0202013	documentation Verdacht auf allergische Reaktion
	enumeration	0202021	documentation Zustand nach Prothesenentfernung
	enumeration	0202042	documentation andere Gründe
source	<code>&lt;element name="OEP_GrundWechselHuefteSchluessel" type="enum_0202"/&gt;</code>		

element **OperationEndoprotheseBasis/OEP\_GrundWechselTfeSchluessel**

diagram			
type	<a href="#">enum 0206</a>		
properties	content simple		
facets	Kind	Value	Annotation
	enumeration	0206001	documentation Lockerung
	enumeration	0206002	documentation Infektion, Verdacht auf
	enumeration	0206003	documentation Infektion, gesichert

	enumeration	0206004	documentation Luxation, Inlay aus der Pfanne
	enumeration	0206005	documentation Luxation, Kopf aus Pfanne/Inlay
	enumeration	0206006	documentation Periprothetische Fraktur
	enumeration	0206007	documentation Verschleiß
	enumeration	0206008	documentation Implantatbruch
	enumeration	0206009	documentation Implantatfehlage/Malalignement
	enumeration	0206010	documentation Osteolysen bei festem Implantat
	enumeration	0206011	documentation Progression der Grunderkrankung
	enumeration	0206012	documentation ARMD
	enumeration	0206013	documentation Verdacht auf allergische Reaktion
	enumeration	0206014	documentation Dislokation/Migration von Komponenten
	enumeration	0206015	documentation Bandinstabilität
	enumeration	0206016	documentation Bewegungseinschränkung
	enumeration	0206021	documentation Zustand nach Prothesenentfernung
	enumeration	0206042	documentation andere Gründe
source	<code>&lt;element name="OEP_GrundWechselTfSchlüssel" type="enum_0206"/&gt;</code>		

#### element **OperationEndoprotheseBasis/OEP\_GrundWechselErlaeuterung**

diagram			
type	<a href="#">Freitext250</a>		
properties	minOcc	0	
	maxOcc	1	
	content	simple	
facets	Kind	Value	Annotation
	maxLength	250	
source	<code>&lt;element name="OEP_GrundWechselErlaeuterung" type="Freitext250" minOccurs="0"/&gt;</code>		

#### element **OperationEndoprotheseBasis/OEP\_KomponenteKnieSchlüssel**

diagram			
type	<a href="#">enum_0254</a>		
properties	content	simple	
facets	Kind	Value	Annotation
	enumeration	0254001	documentation Femur

	enumeration	0254002	documentation Tibia
	enumeration	0254003	documentation Patella
	enumeration	0254004	documentation mehrere
source	<code>&lt;element name="OEP_KomponenteKnieSchluessel" type="enum_0254"/&gt;</code>		

element **OperationEndoprotheseBasis/OEP\_KomponenteHuefteSchluessel**

diagram			
type	<a href="#">enum 0252</a>		
properties	content simple		
facets	Kind	Value	Annotation
	enumeration	0252001	documentation Pfanne
	enumeration	0252002	documentation Schaft
	enumeration	0252003	documentation beides
source	<code>&lt;element name="OEP_KomponenteHuefteSchluessel" type="enum_0252"/&gt;</code>		

element **OperationEndoprotheseBasis/OEP\_KomponenteTfeSchluessel**

diagram			
type	<a href="#">enum 0256</a>		
properties	content simple		
facets	Kind	Value	Annotation
	enumeration	0256001	documentation Pfanne
	enumeration	0256002	documentation Schaft
	enumeration	0256003	documentation Pfanne und Schaft
	enumeration	0256004	documentation Femur
	enumeration	0256005	documentation Tibia
	enumeration	0256006	documentation Patella
	enumeration	0256007	documentation mehrere
source	<code>&lt;element name="OEP_KomponenteTfeSchluessel" type="enum_0256"/&gt;</code>		

element **OperationEndoprotheseBasis/OEP\_ImplantatbruchKnieSchluessel**

diagram			
---------	--	--	--

type	<a href="#">enum_0264</a>		
properties	content simple		
facets	Kind	Value	Annotation
	enumeration	0264001	documentation Femur
	enumeration	0264002	documentation Tibia
	enumeration	0264003	documentation Inlay
	enumeration	0264004	documentation Adapter
	enumeration	0264005	documentation Verlängerung
	enumeration	0264006	documentation Schrauben
	enumeration	0264007	documentation mehrere
	enumeration	0264042	documentation andere
source	<code>&lt;element name="OEP_ImplantatbruchKnieSchluessel" type="enum_0264"/&gt;</code>		

#### element **OperationEndoprotheseBasis/OEP\_ImplantatbruchHuefteSchluessel**

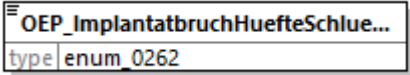
diagram			
type	<a href="#">enum_0262</a>		
properties	content simple		
facets	Kind	Value	Annotation
	enumeration	0262001	documentation Pfanne
	enumeration	0262002	documentation Schaft
	enumeration	0262003	documentation Kopf
	enumeration	0262004	documentation Inlay
	enumeration	0262005	documentation Adapter
	enumeration	0262006	documentation mehrere
source	<code>&lt;element name="OEP_ImplantatbruchHuefteSchluessel" type="enum_0262"/&gt;</code>		

#### element **OperationEndoprotheseBasis/OEP\_ImplantatbruchTfeSchluessel**

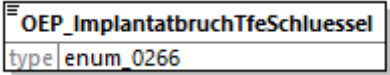
diagram			
type	<a href="#">enum_0266</a>		
properties	content simple		
facets	Kind	Value	Annotation
	enumeration	0266001	documentation Pfanne
	enumeration	0266002	documentation



	enumeration	0266003	Schaft documentation
	enumeration	0266004	Kopf documentation
	enumeration	0266005	Inlay documentation
	enumeration	0266006	Adapter documentation
	enumeration	0266007	Femur documentation
	enumeration	0266008	Tibia documentation
	enumeration	0266009	Verlängerung documentation
	enumeration	0266010	Schrauben documentation
	enumeration	0266042	mehrere documentation andere
source	<code>&lt;element name="OEP_ImplantatbruchTfeSchluessel" type="enum_0266"/&gt;</code>		

#### element **OperationEndoprotheseBasis/OEP\_VerschleissKnieSchluessel**

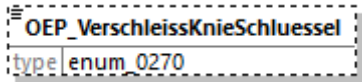
diagram			
type	<a href="#">enum 0270</a>		
properties	minOcc 0 maxOcc 1 content simple		
facets	Kind	Value	Annotation
	enumeration	0270001	documentation PE-Inlay
	enumeration	0270002	documentation patellare Komponente
	enumeration	0270003	documentation beides
source	<code>&lt;element name="OEP_VerschleissKnieSchluessel" type="enum_0270" minOccurs="0"/&gt;</code>		

#### element **OperationEndoprotheseBasis/OEP\_MigrationKnieSchluessel**

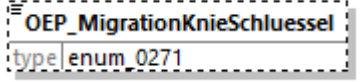
diagram			
type	<a href="#">enum 0271</a>		
properties	minOcc 0 maxOcc 1 content simple		
facets	Kind	Value	Annotation
	enumeration	0271001	documentation Schraube
	enumeration	0271002	documentation Inlay
	enumeration	0271003	documentation patellare Komponente
	enumeration	0271004	documentation Kopplung

	enumeration 0271005	documentation mehrere
	enumeration 0271042	documentation andere
source	<code>&lt;element name="OEP_MigrationKnieSchluessel" type="enum_0271" minOccurs="0"/&gt;</code>	

### element **OperationEndoprotheseBasis/OEP\_ZugangHuefteSchluessel**

diagram			
type	<a href="#">enum 0220</a>		
properties	minOcc	0	
	maxOcc	1	
	content	simple	
facets	Kind	Value	Annotation
	enumeration	0220001	documentation anterior
	enumeration	0220002	documentation anterolateral
	enumeration	0220003	documentation lateral
	enumeration	0220004	documentation posterior
	enumeration	0220005	documentation posterolateral
	enumeration	0220006	documentation 2-Inzisionen-Zugang
	enumeration	0220042	documentation sonstiges/unbekannt
source	<code>&lt;element name="OEP_ZugangHuefteSchluessel" type="enum_0220" minOccurs="0"/&gt;</code>		

### complexType **VorbehandlungEndoprotheseBasis**

diagram			
namespace	http://xml.ir-d.de/emg		
children	<a href="#">VEP_VorOpKnieSchluessel</a> <a href="#">VEP_VorOpHuefteSchluessel</a> <a href="#">VEP_VorOpErlaeuterung</a>		
used by	element	<a href="#">OperationEndoprothese/vorbehandlungEndoprothese</a>	
source	<pre> &lt;complexType name="VorbehandlungEndoprotheseBasis"&gt;   &lt;sequence&gt;     &lt;choice minOccurs="0"&gt;       &lt;element name="VEP_VorOpKnieSchluessel" type="enum_0211"/&gt;       &lt;element name="VEP_VorOpHuefteSchluessel" type="enum_0210"/&gt;     &lt;/choice&gt;     &lt;element name="VEP_VorOpErlaeuterung" type="Freitext250" minOccurs="0"/&gt;   &lt;/sequence&gt; </pre>		

```

</sequence>
</complexType>

```

element **VorbehandlungEndoprotheseBasis/VEP\_VorOpKnieSchluessel**

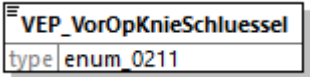
diagram			
type	<a href="#">enum 0211</a>		
properties	content simple		
facets	Kind	Value	Annotation
	enumeration	0211001	documentation keine relevante Voroperation
	enumeration	0211002	documentation Osteosynthese/Osteotomie (Femur)
	enumeration	0211003	documentation Osteosynthese/Osteotomie (Tibia)
	enumeration	0211004	documentation Osteosynthese/Osteotomie (Patella)
	enumeration	0211005	documentation Osteosynthese/Osteotomie (mehrere)
	enumeration	0211006	documentation Kapsel-/Bandapparat
	enumeration	0211007	documentation Arthrodese
	enumeration	0211042	documentation andere
source	<code>&lt;element name="VEP_VorOpKnieSchluessel" type="enum_0211"/&gt;</code>		

element **VorbehandlungEndoprotheseBasis/VEP\_VorOpHuefteSchluessel**

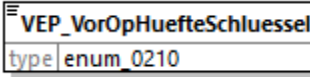
diagram			
type	<a href="#">enum 0210</a>		
properties	content simple		
facets	Kind	Value	Annotation
	enumeration	0210001	documentation keine relevante Voroperation
	enumeration	0210002	documentation Osteosynthese/Osteotomie (Becken)
	enumeration	0210003	documentation Osteosynthese/Osteotomie (Femur)
	enumeration	0210004	documentation Osteosynthese/Osteotomie (beides)
	enumeration	0210005	documentation Operation bei Hüftkopfnekrose
	enumeration	0210006	documentation Arthrodese
	enumeration	0210042	documentation andere
source	<code>&lt;element name="VEP_VorOpHuefteSchluessel" type="enum_0210"/&gt;</code>		

element **VorbehandlungEndoprotheseBasis/VEP\_VorOpErlaeuterung**

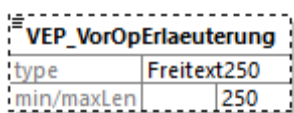
diagram	
type	<a href="#">Freitext250</a>
properties	minOcc 0 maxOcc 1 content simple
facets	Kind Value Annotation maxLength 250
source	<code>&lt;element name="VEP_VorOpErlaeuterung" type="Freitext250" minOccurs="0"/&gt;</code>

complexType **ProzedurenSchluesselEndoprotheseBasis**

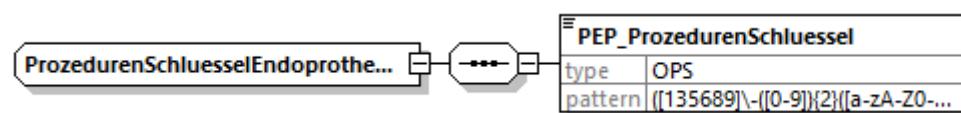
diagram	
namespace	http://xml.ir-d.de/emg
children	<a href="#">PEP_ProzedurenSchluessel</a>
used by	element <a href="#">OperationEndoprothese/prozedurenSchluesselEndoprothese</a>
source	<code>&lt;complexType name="ProzedurenSchluesselEndoprotheseBasis"&gt;   &lt;sequence&gt;     &lt;element name="PEP_ProzedurenSchluessel" type="OPS"/&gt;   &lt;/sequence&gt; &lt;/complexType&gt;</code>

element **ProzedurenSchluesselEndoprotheseBasis/PEP\_ProzedurenSchluessel**

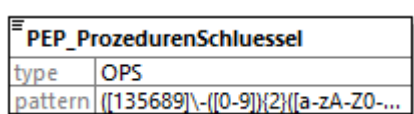
diagram	
type	<a href="#">OPS</a>
properties	content simple
facets	Kind Value Annotation pattern (([135689]\-([0-9]){2})([a-zA-Z0-9]){1}\.([a-zA-Z0-9]{1,2}))*(:[RLBrlb])?
source	<code>&lt;element name="PEP_ProzedurenSchluessel" type="OPS"/&gt;</code>

# complexType OperationAortenklappeBasis

diagram

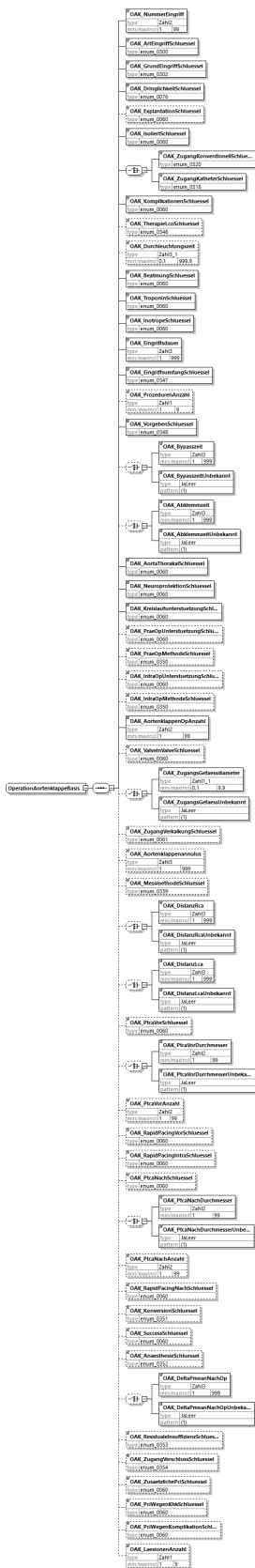

namespace	http://xml.ir-d.de/emg
children	<a href="#">OAK NummerEingriff</a> <a href="#">OAK ArtEingriffSchlüssel</a> <a href="#">OAK GrundEingriffSchlüssel</a> <a href="#">OAK DringlichkeitSchlüssel</a> <a href="#">OAK ExplantationSchlüssel</a> <a href="#">OAK IsoliertSchlüssel</a> <a href="#">OAK ZugangKonventionellSchlüssel</a>

	<p> <a href="#">OAK ZugangKatheterSchluessel</a> <a href="#">OAK KomplikationenSchluessel</a> <a href="#">OAK TherapieLcoSchluessel</a>  <a href="#">OAK Durchleuchtungszeit</a> <a href="#">OAK BeatmungSchluessel</a> <a href="#">OAK TroponinSchluessel</a> <a href="#">OAK InotropeSchluessel</a>  <a href="#">OAK Eingriffsdauer</a> <a href="#">OAK EingriffsumfangSchluessel</a> <a href="#">OAK ProzedurenAnzahl</a> <a href="#">OAK VorgehenSchluessel</a>  <a href="#">OAK Bypasszeit</a> <a href="#">OAK BypasszeitUnbekannt</a> <a href="#">OAK Abklemmzeit</a> <a href="#">OAK AbklemmzeitUnbekannt</a>  <a href="#">OAK AortaThorakalSchluessel</a> <a href="#">OAK NeuroprotektionSchluessel</a> <a href="#">OAK KreislaufunterstuetzungSchluessel</a>  <a href="#">OAK PraeOpUnterstuetzungSchluessel</a> <a href="#">OAK PraeOpMethodeSchluessel</a> <a href="#">OAK IntraOpUnterstuetzungSchluessel</a>  <a href="#">OAK IntraOpMethodeSchluessel</a> <a href="#">OAK AortenklappenOpAnzahl</a> <a href="#">OAK ValvelnValveSchluessel</a>  <a href="#">OAK ZugangsGefaessdiameter</a> <a href="#">OAK ZugangsGefaessUnbekannt</a> <a href="#">OAK ZugangVerkalkungSchluessel</a>  <a href="#">OAK Aortenklappenannulus</a> <a href="#">OAK MessmethodeSchluessel</a> <a href="#">OAK DistanzRca</a> <a href="#">OAK DistanzRcaUnbekannt</a>  <a href="#">OAK DistanzLca</a> <a href="#">OAK DistanzLcaUnbekannt</a> <a href="#">OAK PtcaVorSchluessel</a> <a href="#">OAK PtcaVorDurchmesser</a>  <a href="#">OAK PtcaVorDurchmesserUnbekannt</a> <a href="#">OAK PtcaVorAnzahl</a> <a href="#">OAK RapidPacingVorSchluessel</a>  <a href="#">OAK RapidPacingIntraSchluessel</a> <a href="#">OAK PtcaNachSchluessel</a> <a href="#">OAK PtcaNachDurchmesser</a>  <a href="#">OAK PtcaNachDurchmesserUnbekannt</a> <a href="#">OAK PtcaNachAnzahl</a> <a href="#">OAK RapidPacingNachSchluessel</a>  <a href="#">OAK KonversionSchluessel</a> <a href="#">OAK SuccessSchluessel</a> <a href="#">OAK AnaesthesieSchluessel</a> <a href="#">OAK DeltaPmeanNachOp</a>  <a href="#">OAK DeltaPmeanNachOpUnbekannt</a> <a href="#">OAK ResidualeinsuffizienzSchluessel</a> <a href="#">OAK ZugangVerschlussSchluessel</a>  <a href="#">OAK ZusaetzlichePciSchluessel</a> <a href="#">OAK PciWegenKhkSchluessel</a> <a href="#">OAK PciWegenKomplikationSchluessel</a>  <a href="#">OAK LaesionenAnzahl</a> </p>
used by	<p>complexType <a href="#">OperationAortenklappe</a></p>
source	<pre> &lt;complexType name="OperationAortenklappeBasis"&gt;   &lt;sequence&gt;     &lt;element name="OAK_NummerEingriff" type="Zahl2"/&gt;     &lt;element name="OAK_ArtEingriffSchluessel" type="enum_0300"/&gt;     &lt;element name="OAK_GrundEingriffSchluessel" type="enum_0302"/&gt;     &lt;element name="OAK_DringlichkeitSchluessel" type="enum_0076"/&gt;     &lt;element name="OAK_ExplantationSchluessel" type="enum_0060" minOccurs="0"/&gt;     &lt;element name="OAK_IsoliertSchluessel" type="enum_0060"/&gt;     &lt;choice&gt;       &lt;element name="OAK_ZugangKonventionellSchluessel" type="enum_0320"/&gt;       &lt;element name="OAK_ZugangKatheterSchluessel" type="enum_0318"/&gt;     &lt;/choice&gt;     &lt;element name="OAK_KomplikationenSchluessel" type="enum_0060"/&gt;     &lt;element name="OAK_TherapieLcoSchluessel" type="enum_0346" minOccurs="0"/&gt;     &lt;element name="OAK_Durchleuchtungszeit" type="Zahl3_1" minOccurs="0"/&gt;     &lt;element name="OAK_BeatmungSchluessel" type="enum_0060"/&gt;     &lt;element name="OAK_TroponinSchluessel" type="enum_0060"/&gt;     &lt;element name="OAK_InotropeSchluessel" type="enum_0060"/&gt;     &lt;element name="OAK_Eingriffsdauer" type="Zahl3"/&gt;     &lt;element name="OAK_EingriffsumfangSchluessel" type="enum_0347"/&gt;     &lt;element name="OAK_ProzedurenAnzahl" type="Zahl1" minOccurs="0"/&gt;     &lt;element name="OAK_VorgehenSchluessel" type="enum_0348"/&gt;     &lt;choice minOccurs="0"&gt;       &lt;element name="OAK_Bypasszeit" type="Zahl3"/&gt;       &lt;element name="OAK_BypasszeitUnbekannt" type="JaLeer"/&gt;     &lt;/choice&gt;     &lt;choice minOccurs="0"&gt;       &lt;element name="OAK_Abklemmzeit" type="Zahl3"/&gt;       &lt;element name="OAK_AbklemmzeitUnbekannt" type="JaLeer"/&gt;     &lt;/choice&gt;     &lt;element name="OAK_AortaThorakalSchluessel" type="enum_0060"/&gt;     &lt;element name="OAK_NeuroprotektionSchluessel" type="enum_0060"/&gt;     &lt;element name="OAK_KreislaufunterstuetzungSchluessel" type="enum_0060"/&gt;     &lt;element name="OAK_PraeOpUnterstuetzungSchluessel" type="enum_0060" minOccurs="0"/&gt;     &lt;element name="OAK_PraeOpMethodeSchluessel" type="enum_0350" minOccurs="0"/&gt;     &lt;element name="OAK_IntraOpUnterstuetzungSchluessel" type="enum_0060" minOccurs="0"/&gt;     &lt;element name="OAK_IntraOpMethodeSchluessel" type="enum_0350" </pre>

```

minOccurs="0"/>
  <element name="OAK_AortenklappenOpAnzahl" type="Zahl2"/>
  <element name="OAK_ValveInValveSchluessel" type="enum_0060"
minOccurs="0"/>
  <choice minOccurs="0">
    <element name="OAK_ZugangsGefaessdiameter" type="Zahl1_1"/>
    <element name="OAK_ZugangsGefaessUnbekannt" type="JaLeer"/>
  </choice>
  <element name="OAK_ZugangVerkalkungSchluessel" type="enum_0061"
minOccurs="0"/>
  <element name="OAK_Aortenklappenannulus" type="Zahl3" minOccurs="0"/>
  <element name="OAK_MessmethodeSchluessel" type="enum_0339" minOccurs="0"/>
  <choice minOccurs="0">
    <element name="OAK_DistanzRca" type="Zahl3"/>
    <element name="OAK_DistanzRcaUnbekannt" type="JaLeer"/>
  </choice>
  <choice minOccurs="0">
    <element name="OAK_DistanzLca" type="Zahl3"/>
    <element name="OAK_DistanzLcaUnbekannt" type="JaLeer"/>
  </choice>
  <element name="OAK_PtcaVorSchluessel" type="enum_0060" minOccurs="0"/>
  <choice minOccurs="0">
    <element name="OAK_PtcaVorDurchmesser" type="Zahl2"/>
    <element name="OAK_PtcaVorDurchmesserUnbekannt" type="JaLeer"/>
  </choice>
  <element name="OAK_PtcaVorAnzahl" type="Zahl2" minOccurs="0"/>
  <element name="OAK_RapidPacingVorSchluessel" type="enum_0060"
minOccurs="0"/>
  <element name="OAK_RapidPacingIntraSchluessel" type="enum_0060"
minOccurs="0"/>
  <element name="OAK_PtcaNachSchluessel" type="enum_0060" minOccurs="0"/>
  <choice minOccurs="0">
    <element name="OAK_PtcaNachDurchmesser" type="Zahl2"/>
    <element name="OAK_PtcaNachDurchmesserUnbekannt" type="JaLeer"/>
  </choice>
  <element name="OAK_PtcaNachAnzahl" type="Zahl2" minOccurs="0"/>
  <element name="OAK_RapidPacingNachSchluessel" type="enum_0060"
minOccurs="0"/>
  <element name="OAK_KonversionSchluessel" type="enum_0351" minOccurs="0"/>
  <element name="OAK_SuccessSchluessel" type="enum_0060" minOccurs="0"/>
  <element name="OAK_AnaesthesieSchluessel" type="enum_0352" minOccurs="0"/>
  <choice minOccurs="0">
    <element name="OAK_DeltaPmeanNachOp" type="Zahl3"/>
    <element name="OAK_DeltaPmeanNachOpUnbekannt" type="JaLeer"/>
  </choice>
  <element name="OAK_ResidualeInsuffizienzSchluessel" type="enum_0353"
minOccurs="0"/>
  <element name="OAK_ZugangVerschlussSchluessel" type="enum_0354"
minOccurs="0"/>
  <element name="OAK_ZusaetzlichePciSchluessel" type="enum_0060"
minOccurs="0"/>
  <element name="OAK_PciWegenKhkSchluessel" type="enum_0060" minOccurs="0"/>
  <element name="OAK_PciWegenKomplikationSchluessel" type="enum_0060"
minOccurs="0"/>
  <element name="OAK_LaesionenAnzahl" type="Zahl1" minOccurs="0"/>
</sequence>
</complexType>

```

element **OperationAortenklappeBasis/OAK\_NummerEingriff**

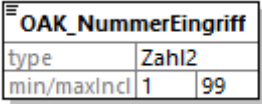
diagram										
type	<a href="#">Zahl2</a>									
properties	content simple									
facets	<table border="1"> <thead> <tr> <th>Kind</th> <th>Value</th> <th>Annotation</th> </tr> </thead> <tbody> <tr> <td>minInclusive</td> <td>1</td> <td></td> </tr> <tr> <td>maxInclusive</td> <td>99</td> <td></td> </tr> </tbody> </table>	Kind	Value	Annotation	minInclusive	1		maxInclusive	99	
Kind	Value	Annotation								
minInclusive	1									
maxInclusive	99									
source	<code>&lt;element name="OAK_NummerEingriff" type="Zahl2"/&gt;</code>									

element **OperationAortenklappeBasis/OAK\_ArtEingriffSchluessel**

diagram										
type	<a href="#">enum_0300</a>									
properties	content simple									
facets	<table border="1"> <thead> <tr> <th>Kind</th> <th>Value</th> <th>Annotation</th> </tr> </thead> <tbody> <tr> <td>enumeration</td> <td>0300001</td> <td>documentation konventioneller Aortenklappenersatz</td> </tr> <tr> <td>enumeration</td> <td>0300002</td> <td>documentation kathetergestützte Aortenklappenimplantation (TAVI)</td> </tr> </tbody> </table>	Kind	Value	Annotation	enumeration	0300001	documentation konventioneller Aortenklappenersatz	enumeration	0300002	documentation kathetergestützte Aortenklappenimplantation (TAVI)
Kind	Value	Annotation								
enumeration	0300001	documentation konventioneller Aortenklappenersatz								
enumeration	0300002	documentation kathetergestützte Aortenklappenimplantation (TAVI)								
source	<code>&lt;element name="OAK_ArtEingriffSchluessel" type="enum_0300"/&gt;</code>									

element **OperationAortenklappeBasis/OAK\_GrundEingriffSchluessel**

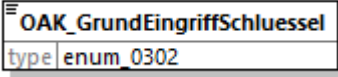
diagram													
type	<a href="#">enum_0302</a>												
properties	content simple												
facets	<table border="1"> <thead> <tr> <th>Kind</th> <th>Value</th> <th>Annotation</th> </tr> </thead> <tbody> <tr> <td>enumeration</td> <td>0302001</td> <td>documentation Stenose</td> </tr> <tr> <td>enumeration</td> <td>0302002</td> <td>documentation Insuffizienz</td> </tr> <tr> <td>enumeration</td> <td>0302003</td> <td>documentation Stenose und Insuffizienz</td> </tr> </tbody> </table>	Kind	Value	Annotation	enumeration	0302001	documentation Stenose	enumeration	0302002	documentation Insuffizienz	enumeration	0302003	documentation Stenose und Insuffizienz
Kind	Value	Annotation											
enumeration	0302001	documentation Stenose											
enumeration	0302002	documentation Insuffizienz											
enumeration	0302003	documentation Stenose und Insuffizienz											
source	<code>&lt;element name="OAK_GrundEingriffSchluessel" type="enum_0302"/&gt;</code>												

element **OperationAortenklappeBasis/OAK\_DringlichkeitSchluessel**

diagram	
---------	---



type	<a href="#">enum_0076</a>															
properties	content simple															
facets	<table border="1"> <thead> <tr> <th>Kind</th> <th>Value</th> <th>Annotation</th> </tr> </thead> <tbody> <tr> <td>enumeration</td> <td>0076001</td> <td>documentation elektiv</td> </tr> <tr> <td>enumeration</td> <td>0076002</td> <td>documentation dringlich</td> </tr> <tr> <td>enumeration</td> <td>0076003</td> <td>documentation Notfall</td> </tr> <tr> <td>enumeration</td> <td>0076004</td> <td>documentation Notfall (Reanimation / ultima ratio)</td> </tr> </tbody> </table>	Kind	Value	Annotation	enumeration	0076001	documentation elektiv	enumeration	0076002	documentation dringlich	enumeration	0076003	documentation Notfall	enumeration	0076004	documentation Notfall (Reanimation / ultima ratio)
Kind	Value	Annotation														
enumeration	0076001	documentation elektiv														
enumeration	0076002	documentation dringlich														
enumeration	0076003	documentation Notfall														
enumeration	0076004	documentation Notfall (Reanimation / ultima ratio)														
source	<code>&lt;element name="OAK_DringlichkeitSchluessel" type="enum_0076"/&gt;</code>															

#### element **OperationAortenklappeBasis/OAK\_ExplantationSchluessel**

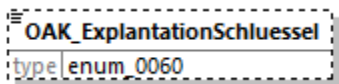
diagram										
type	<a href="#">enum_0060</a>									
properties	minOcc 0 maxOcc 1 content simple									
facets	<table border="1"> <thead> <tr> <th>Kind</th> <th>Value</th> <th>Annotation</th> </tr> </thead> <tbody> <tr> <td>enumeration</td> <td>0060001</td> <td>documentation ja</td> </tr> <tr> <td>enumeration</td> <td>0060002</td> <td>documentation nein</td> </tr> </tbody> </table>	Kind	Value	Annotation	enumeration	0060001	documentation ja	enumeration	0060002	documentation nein
Kind	Value	Annotation								
enumeration	0060001	documentation ja								
enumeration	0060002	documentation nein								
source	<code>&lt;element name="OAK_ExplantationSchluessel" type="enum_0060" minOccurs="0"/&gt;</code>									

#### element **OperationAortenklappeBasis/OAK\_IsoliertSchluessel**

diagram										
type	<a href="#">enum_0060</a>									
properties	content simple									
facets	<table border="1"> <thead> <tr> <th>Kind</th> <th>Value</th> <th>Annotation</th> </tr> </thead> <tbody> <tr> <td>enumeration</td> <td>0060001</td> <td>documentation ja</td> </tr> <tr> <td>enumeration</td> <td>0060002</td> <td>documentation nein</td> </tr> </tbody> </table>	Kind	Value	Annotation	enumeration	0060001	documentation ja	enumeration	0060002	documentation nein
Kind	Value	Annotation								
enumeration	0060001	documentation ja								
enumeration	0060002	documentation nein								
source	<code>&lt;element name="OAK_IsoliertSchluessel" type="enum_0060"/&gt;</code>									

#### element **OperationAortenklappeBasis/OAK\_ZugangKonventionellSchluessel**

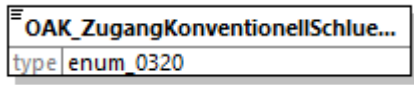
diagram	
type	<a href="#">enum_0320</a>
properties	content simple

facets	Kind enumeration	Value 0320001	Annotation documentation konventionelle Sternotomie
	enumeration	0320002	documentation partielle Sternotomie
	enumeration	0320003	documentation parasternaler Zugang
	enumeration	0320042	documentation anderer Zugangsweg
source	<code>&lt;element name="OAK_ZugangKonventionellSchluessel" type="enum_0320"/&gt;</code>		

#### element **OperationAortenklappeBasis/OAK\_ZugangKatheterSchluessel**

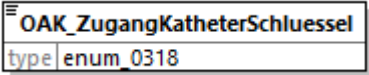
diagram			
type	<a href="#">enum 0318</a>		
properties	content simple		
facets	Kind enumeration	Value 0318001	Annotation documentation transapikal
	enumeration	0318002	documentation transaortal
	enumeration	0318003	documentation transfemoral
	enumeration	0318004	documentation transaxillär
	enumeration	0318042	documentation anderer Zugangsweg
source	<code>&lt;element name="OAK_ZugangKatheterSchluessel" type="enum_0318"/&gt;</code>		

#### element **OperationAortenklappeBasis/OAK\_KomplikationenSchluessel**

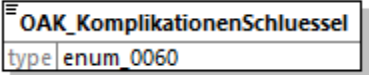
diagram			
type	<a href="#">enum 0060</a>		
properties	content simple		
facets	Kind enumeration	Value 0060001	Annotation documentation ja
	enumeration	0060002	documentation nein
source	<code>&lt;element name="OAK_KomplikationenSchluessel" type="enum_0060"/&gt;</code>		

#### element **OperationAortenklappeBasis/OAK\_TherapieLcoSchluessel**

diagram			
type	<a href="#">enum 0346</a>		

properties	minOcc 0 maxOcc 1 content simple																					
facets	<table border="1"> <thead> <tr> <th>Kind</th> <th>Value</th> <th>Annotation</th> </tr> </thead> <tbody> <tr> <td>enumeration</td> <td>0346001</td> <td>documentation keine Therapie erforderlich</td> </tr> <tr> <td>enumeration</td> <td>0346002</td> <td>documentation medikamentös</td> </tr> <tr> <td>enumeration</td> <td>0346003</td> <td>documentation IABP</td> </tr> <tr> <td>enumeration</td> <td>0346004</td> <td>documentation VAD</td> </tr> <tr> <td>enumeration</td> <td>0346005</td> <td>documentation ECMO</td> </tr> <tr> <td>enumeration</td> <td>0346042</td> <td>documentation sonstige</td> </tr> </tbody> </table>	Kind	Value	Annotation	enumeration	0346001	documentation keine Therapie erforderlich	enumeration	0346002	documentation medikamentös	enumeration	0346003	documentation IABP	enumeration	0346004	documentation VAD	enumeration	0346005	documentation ECMO	enumeration	0346042	documentation sonstige
Kind	Value	Annotation																				
enumeration	0346001	documentation keine Therapie erforderlich																				
enumeration	0346002	documentation medikamentös																				
enumeration	0346003	documentation IABP																				
enumeration	0346004	documentation VAD																				
enumeration	0346005	documentation ECMO																				
enumeration	0346042	documentation sonstige																				
source	<code>&lt;element name="OAK_TherapieLcoSchluessel" type="enum_0346" minOccurs="0"/&gt;</code>																					

### element **OperationAortenklappeBasis/OAK\_Durchleuchtungszeit**

diagram																
type	<a href="#">Zahl3_1</a>															
properties	minOcc 0 maxOcc 1 content simple															
facets	<table border="1"> <thead> <tr> <th>Kind</th> <th>Value</th> <th>Annotation</th> </tr> </thead> <tbody> <tr> <td>minInclusive</td> <td>0.1</td> <td></td> </tr> <tr> <td>maxInclusive</td> <td>999.9</td> <td></td> </tr> <tr> <td>totalDigits</td> <td>4</td> <td></td> </tr> <tr> <td>fractionDigits</td> <td>1</td> <td></td> </tr> </tbody> </table>	Kind	Value	Annotation	minInclusive	0.1		maxInclusive	999.9		totalDigits	4		fractionDigits	1	
Kind	Value	Annotation														
minInclusive	0.1															
maxInclusive	999.9															
totalDigits	4															
fractionDigits	1															
source	<code>&lt;element name="OAK_Durchleuchtungszeit" type="Zahl3_1" minOccurs="0"/&gt;</code>															

### element **OperationAortenklappeBasis/OAK\_BeatmungSchluessel**

diagram										
type	<a href="#">enum_0060</a>									
properties	content simple									
facets	<table border="1"> <thead> <tr> <th>Kind</th> <th>Value</th> <th>Annotation</th> </tr> </thead> <tbody> <tr> <td>enumeration</td> <td>0060001</td> <td>documentation ja</td> </tr> <tr> <td>enumeration</td> <td>0060002</td> <td>documentation nein</td> </tr> </tbody> </table>	Kind	Value	Annotation	enumeration	0060001	documentation ja	enumeration	0060002	documentation nein
Kind	Value	Annotation								
enumeration	0060001	documentation ja								
enumeration	0060002	documentation nein								
source	<code>&lt;element name="OAK_BeatmungSchluessel" type="enum_0060"/&gt;</code>									

element **OperationAortenklappeBasis/OAK\_TroponinSchluessel**

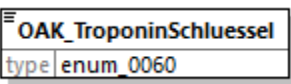
diagram										
type	<a href="#">enum_0060</a>									
properties	content simple									
facets	<table border="1"> <thead> <tr> <th>Kind</th> <th>Value</th> <th>Annotation</th> </tr> </thead> <tbody> <tr> <td>enumeration</td> <td>0060001</td> <td>documentation ja</td> </tr> <tr> <td>enumeration</td> <td>0060002</td> <td>documentation nein</td> </tr> </tbody> </table>	Kind	Value	Annotation	enumeration	0060001	documentation ja	enumeration	0060002	documentation nein
Kind	Value	Annotation								
enumeration	0060001	documentation ja								
enumeration	0060002	documentation nein								
source	<code>&lt;element name="OAK_TroponinSchluessel" type="enum_0060"/&gt;</code>									

element **OperationAortenklappeBasis/OAK\_InotropeSchluessel**

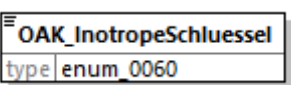
diagram										
type	<a href="#">enum_0060</a>									
properties	content simple									
facets	<table border="1"> <thead> <tr> <th>Kind</th> <th>Value</th> <th>Annotation</th> </tr> </thead> <tbody> <tr> <td>enumeration</td> <td>0060001</td> <td>documentation ja</td> </tr> <tr> <td>enumeration</td> <td>0060002</td> <td>documentation nein</td> </tr> </tbody> </table>	Kind	Value	Annotation	enumeration	0060001	documentation ja	enumeration	0060002	documentation nein
Kind	Value	Annotation								
enumeration	0060001	documentation ja								
enumeration	0060002	documentation nein								
source	<code>&lt;element name="OAK_InotropeSchluessel" type="enum_0060"/&gt;</code>									

element **OperationAortenklappeBasis/OAK\_Eingriffsdauer**

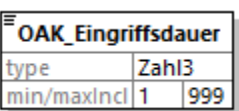
diagram										
type	<a href="#">Zahl3</a>									
properties	content simple									
facets	<table border="1"> <thead> <tr> <th>Kind</th> <th>Value</th> <th>Annotation</th> </tr> </thead> <tbody> <tr> <td>minInclusive</td> <td>1</td> <td></td> </tr> <tr> <td>maxInclusive</td> <td>999</td> <td></td> </tr> </tbody> </table>	Kind	Value	Annotation	minInclusive	1		maxInclusive	999	
Kind	Value	Annotation								
minInclusive	1									
maxInclusive	999									
source	<code>&lt;element name="OAK_Eingriffsdauer" type="Zahl3"/&gt;</code>									

element **OperationAortenklappeBasis/OAK\_EingriffsumfangSchluessel**

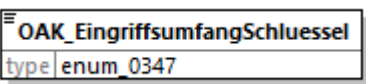
diagram	
type	<a href="#">enum_0347</a>
properties	content simple

facets	Kind	Value	Annotation
	enumeration	0347001	documentation Einzeleingriff
	enumeration	0347002	documentation Kombinationseingriff mit mehreren Prozeduren
source	<element name="OAK_EingriffsumfangSchluessel" type="enum_0347"/>		

#### element **OperationAortenklappeBasis/OAK\_ProzedurenAnzahl**

diagram			
type	<a href="#">Zahl1</a>		
properties	minOcc 0 maxOcc 1 content simple		
facets	Kind	Value	Annotation
	minInclusive	1	
	maxInclusive	9	
source	<element name="OAK_ProzedurenAnzahl" type="Zahl1" minOccurs="0"/>		

#### element **OperationAortenklappeBasis/OAK\_VorgehenSchluessel**

diagram			
type	<a href="#">enum_0348</a>		
properties	content simple		
facets	Kind	Value	Annotation
	enumeration	0348001	documentation mit HLM
	enumeration	0348002	documentation ohne HLM
	enumeration	0348003	documentation Umstieg von OP ohne HLM auf OP mit HLM
source	<element name="OAK_VorgehenSchluessel" type="enum_0348"/>		

#### element **OperationAortenklappeBasis/OAK\_Bypasszeit**

diagram			
type	<a href="#">Zahl3</a>		
properties	content simple		
facets	Kind	Value	Annotation
	minInclusive	1	
	maxInclusive	999	
source	<element name="OAK_Bypasszeit" type="Zahl3"/>		

element **OperationAortenklappeBasis/OAK\_BypasszeitUnbekannt**

diagram							
type	<a href="#">JaLeer</a>						
properties	content simple						
facets	<table border="1"> <thead> <tr> <th>Kind</th> <th>Value</th> <th>Annotation</th> </tr> </thead> <tbody> <tr> <td>pattern</td> <td>(1)</td> <td></td> </tr> </tbody> </table>	Kind	Value	Annotation	pattern	(1)	
Kind	Value	Annotation					
pattern	(1)						
source	<code>&lt;element name="OAK_BypasszeitUnbekannt" type="JaLeer"/&gt;</code>						

element **OperationAortenklappeBasis/OAK\_Abklemmzeit**

diagram										
type	<a href="#">Zahl3</a>									
properties	content simple									
facets	<table border="1"> <thead> <tr> <th>Kind</th> <th>Value</th> <th>Annotation</th> </tr> </thead> <tbody> <tr> <td>minInclusive</td> <td>1</td> <td></td> </tr> <tr> <td>maxInclusive</td> <td>999</td> <td></td> </tr> </tbody> </table>	Kind	Value	Annotation	minInclusive	1		maxInclusive	999	
Kind	Value	Annotation								
minInclusive	1									
maxInclusive	999									
source	<code>&lt;element name="OAK_Abklemmzeit" type="Zahl3"/&gt;</code>									

element **OperationAortenklappeBasis/OAK\_AbklemmzeitUnbekannt**

diagram							
type	<a href="#">JaLeer</a>						
properties	content simple						
facets	<table border="1"> <thead> <tr> <th>Kind</th> <th>Value</th> <th>Annotation</th> </tr> </thead> <tbody> <tr> <td>pattern</td> <td>(1)</td> <td></td> </tr> </tbody> </table>	Kind	Value	Annotation	pattern	(1)	
Kind	Value	Annotation					
pattern	(1)						
source	<code>&lt;element name="OAK_AbklemmzeitUnbekannt" type="JaLeer"/&gt;</code>						

element **OperationAortenklappeBasis/OAK\_AortaThorakalSchluessel**

diagram							
type	<a href="#">enum_0060</a>						
properties	content simple						
facets	<table border="1"> <thead> <tr> <th>Kind</th> <th>Value</th> <th>Annotation</th> </tr> </thead> <tbody> <tr> <td>enumeration</td> <td>0060001</td> <td>documentation</td> </tr> </tbody> </table>	Kind	Value	Annotation	enumeration	0060001	documentation
Kind	Value	Annotation					
enumeration	0060001	documentation					

	enumeration 0060002 ja documentation nein
source	<code>&lt;element name="OAK_AortaThorakalSchluessel" type="enum_0060"/&gt;</code>

element **OperationAortenklappeBasis/OAK\_NeuroprotektionSchluessel**

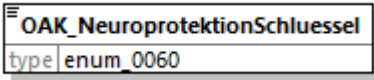
diagram										
type	<a href="#">enum_0060</a>									
properties	content simple									
facets	<table border="1"> <thead> <tr> <th>Kind</th> <th>Value</th> <th>Annotation</th> </tr> </thead> <tbody> <tr> <td>enumeration</td> <td>0060001</td> <td>documentation ja</td> </tr> <tr> <td>enumeration</td> <td>0060002</td> <td>documentation nein</td> </tr> </tbody> </table>	Kind	Value	Annotation	enumeration	0060001	documentation ja	enumeration	0060002	documentation nein
Kind	Value	Annotation								
enumeration	0060001	documentation ja								
enumeration	0060002	documentation nein								
source	<code>&lt;element name="OAK_NeuroprotektionSchluessel" type="enum_0060"/&gt;</code>									

element **OperationAortenklappeBasis/OAK\_KreislaufunterstuetzungSchluessel**

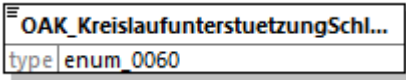
diagram										
type	<a href="#">enum_0060</a>									
properties	content simple									
facets	<table border="1"> <thead> <tr> <th>Kind</th> <th>Value</th> <th>Annotation</th> </tr> </thead> <tbody> <tr> <td>enumeration</td> <td>0060001</td> <td>documentation ja</td> </tr> <tr> <td>enumeration</td> <td>0060002</td> <td>documentation nein</td> </tr> </tbody> </table>	Kind	Value	Annotation	enumeration	0060001	documentation ja	enumeration	0060002	documentation nein
Kind	Value	Annotation								
enumeration	0060001	documentation ja								
enumeration	0060002	documentation nein								
source	<code>&lt;element name="OAK_KreislaufunterstuetzungSchluessel" type="enum_0060"/&gt;</code>									

element **OperationAortenklappeBasis/OAK\_PraeOpUnterstuetzungSchluessel**

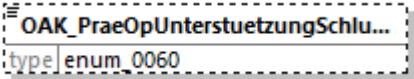
diagram										
type	<a href="#">enum_0060</a>									
properties	minOcc 0 maxOcc 1 content simple									
facets	<table border="1"> <thead> <tr> <th>Kind</th> <th>Value</th> <th>Annotation</th> </tr> </thead> <tbody> <tr> <td>enumeration</td> <td>0060001</td> <td>documentation ja</td> </tr> <tr> <td>enumeration</td> <td>0060002</td> <td>documentation nein</td> </tr> </tbody> </table>	Kind	Value	Annotation	enumeration	0060001	documentation ja	enumeration	0060002	documentation nein
Kind	Value	Annotation								
enumeration	0060001	documentation ja								
enumeration	0060002	documentation nein								
source	<code>&lt;element name="OAK_PraeOpUnterstuetzungSchluessel" type="enum_0060" minOccurs="0"/&gt;</code>									

element **OperationAortenklappeBasis/OAK\_PraeOpMethodeSchluessel**

diagram																			
type	<a href="#">enum 0350</a>																		
properties	minOcc 0 maxOcc 1 content simple																		
facets	<table border="1"> <thead> <tr> <th>Kind</th> <th>Value</th> <th>Annotation</th> </tr> </thead> <tbody> <tr> <td>enumeration</td> <td>0350001</td> <td>documentation IABP</td> </tr> <tr> <td>enumeration</td> <td>0350002</td> <td>documentation Impella</td> </tr> <tr> <td>enumeration</td> <td>0350003</td> <td>documentation vv ECMO</td> </tr> <tr> <td>enumeration</td> <td>0350004</td> <td>documentation va ECMO</td> </tr> <tr> <td>enumeration</td> <td>0350042</td> <td>documentation andere</td> </tr> </tbody> </table>	Kind	Value	Annotation	enumeration	0350001	documentation IABP	enumeration	0350002	documentation Impella	enumeration	0350003	documentation vv ECMO	enumeration	0350004	documentation va ECMO	enumeration	0350042	documentation andere
Kind	Value	Annotation																	
enumeration	0350001	documentation IABP																	
enumeration	0350002	documentation Impella																	
enumeration	0350003	documentation vv ECMO																	
enumeration	0350004	documentation va ECMO																	
enumeration	0350042	documentation andere																	
source	<code>&lt;element name="OAK_PraeOpMethodeSchluessel" type="enum_0350" minOccurs="0"/&gt;</code>																		

element **OperationAortenklappeBasis/OAK\_IntraOpUnterstuetzungSchluessel**

diagram										
type	<a href="#">enum 0060</a>									
properties	minOcc 0 maxOcc 1 content simple									
facets	<table border="1"> <thead> <tr> <th>Kind</th> <th>Value</th> <th>Annotation</th> </tr> </thead> <tbody> <tr> <td>enumeration</td> <td>0060001</td> <td>documentation ja</td> </tr> <tr> <td>enumeration</td> <td>0060002</td> <td>documentation nein</td> </tr> </tbody> </table>	Kind	Value	Annotation	enumeration	0060001	documentation ja	enumeration	0060002	documentation nein
Kind	Value	Annotation								
enumeration	0060001	documentation ja								
enumeration	0060002	documentation nein								
source	<code>&lt;element name="OAK_IntraOpUnterstuetzungSchluessel" type="enum_0060" minOccurs="0"/&gt;</code>									

element **OperationAortenklappeBasis/OAK\_IntraOpMethodeSchluessel**

diagram													
type	<a href="#">enum 0350</a>												
properties	minOcc 0 maxOcc 1 content simple												
facets	<table border="1"> <thead> <tr> <th>Kind</th> <th>Value</th> <th>Annotation</th> </tr> </thead> <tbody> <tr> <td>enumeration</td> <td>0350001</td> <td>documentation IABP</td> </tr> <tr> <td>enumeration</td> <td>0350002</td> <td>documentation Impella</td> </tr> <tr> <td>enumeration</td> <td>0350003</td> <td>documentation vv ECMO</td> </tr> </tbody> </table>	Kind	Value	Annotation	enumeration	0350001	documentation IABP	enumeration	0350002	documentation Impella	enumeration	0350003	documentation vv ECMO
Kind	Value	Annotation											
enumeration	0350001	documentation IABP											
enumeration	0350002	documentation Impella											
enumeration	0350003	documentation vv ECMO											



	enumeration 0350004 documentation va ECMO
	enumeration 0350042 documentation andere
source	<code>&lt;element name="OAK_IntraOpMethodeSchluessel" type="enum_0350" minOccurs="0"/&gt;</code>

#### element **OperationAortenklappeBasis/OAK\_AortenklappenOpAnzahl**

diagram										
type	<a href="#">Zahl2</a>									
properties	content simple									
facets	<table border="1"> <thead> <tr> <th>Kind</th> <th>Value</th> <th>Annotation</th> </tr> </thead> <tbody> <tr> <td>minInclusive</td> <td>1</td> <td></td> </tr> <tr> <td>maxInclusive</td> <td>99</td> <td></td> </tr> </tbody> </table>	Kind	Value	Annotation	minInclusive	1		maxInclusive	99	
Kind	Value	Annotation								
minInclusive	1									
maxInclusive	99									
source	<code>&lt;element name="OAK_AortenklappenOpAnzahl" type="Zahl2"/&gt;</code>									

#### element **OperationAortenklappeBasis/OAK\_ValveInValveSchluessel**

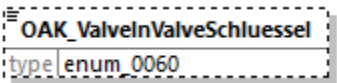
diagram										
type	<a href="#">enum_0060</a>									
properties	minOcc 0 maxOcc 1 content simple									
facets	<table border="1"> <thead> <tr> <th>Kind</th> <th>Value</th> <th>Annotation</th> </tr> </thead> <tbody> <tr> <td>enumeration</td> <td>0060001</td> <td>documentation ja</td> </tr> <tr> <td>enumeration</td> <td>0060002</td> <td>documentation nein</td> </tr> </tbody> </table>	Kind	Value	Annotation	enumeration	0060001	documentation ja	enumeration	0060002	documentation nein
Kind	Value	Annotation								
enumeration	0060001	documentation ja								
enumeration	0060002	documentation nein								
source	<code>&lt;element name="OAK_ValveInValveSchluessel" type="enum_0060" minOccurs="0"/&gt;</code>									

#### element **OperationAortenklappeBasis/OAK\_ZugangsGefaessdiameter**

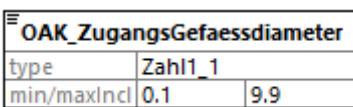
diagram																
type	<a href="#">Zahl1_1</a>															
properties	content simple															
facets	<table border="1"> <thead> <tr> <th>Kind</th> <th>Value</th> <th>Annotation</th> </tr> </thead> <tbody> <tr> <td>minInclusive</td> <td>0.1</td> <td></td> </tr> <tr> <td>maxInclusive</td> <td>9.9</td> <td></td> </tr> <tr> <td>totalDigits</td> <td>2</td> <td></td> </tr> <tr> <td>fractionDigits</td> <td>1</td> <td></td> </tr> </tbody> </table>	Kind	Value	Annotation	minInclusive	0.1		maxInclusive	9.9		totalDigits	2		fractionDigits	1	
Kind	Value	Annotation														
minInclusive	0.1															
maxInclusive	9.9															
totalDigits	2															
fractionDigits	1															
source	<code>&lt;element name="OAK_ZugangsGefaessdiameter" type="Zahl1_1"/&gt;</code>															

element **OperationAortenklappeBasis/OAK\_ZugangsGefaessUnbekannt**

diagram							
type	<a href="#">JaLeer</a>						
properties	content simple						
facets	<table border="1"> <thead> <tr> <th>Kind</th> <th>Value</th> <th>Annotation</th> </tr> </thead> <tbody> <tr> <td>pattern</td> <td>(1)</td> <td></td> </tr> </tbody> </table>	Kind	Value	Annotation	pattern	(1)	
Kind	Value	Annotation					
pattern	(1)						
source	<code>&lt;element name="OAK_ZugangsGefaessUnbekannt" type="JaLeer"/&gt;</code>						

element **OperationAortenklappeBasis/OAK\_ZugangVerkalkungSchluessel**

diagram													
type	<a href="#">enum_0061</a>												
properties	<table border="1"> <tbody> <tr> <td>minOcc</td> <td>0</td> </tr> <tr> <td>maxOcc</td> <td>1</td> </tr> <tr> <td>content</td> <td>simple</td> </tr> </tbody> </table>	minOcc	0	maxOcc	1	content	simple						
minOcc	0												
maxOcc	1												
content	simple												
facets	<table border="1"> <thead> <tr> <th>Kind</th> <th>Value</th> <th>Annotation</th> </tr> </thead> <tbody> <tr> <td>enumeration</td> <td>0061001</td> <td>documentation ja</td> </tr> <tr> <td>enumeration</td> <td>0061002</td> <td>documentation nein</td> </tr> <tr> <td>enumeration</td> <td>0061099</td> <td>documentation unbekannt</td> </tr> </tbody> </table>	Kind	Value	Annotation	enumeration	0061001	documentation ja	enumeration	0061002	documentation nein	enumeration	0061099	documentation unbekannt
Kind	Value	Annotation											
enumeration	0061001	documentation ja											
enumeration	0061002	documentation nein											
enumeration	0061099	documentation unbekannt											
source	<code>&lt;element name="OAK_ZugangVerkalkungSchluessel" type="enum_0061" minOccurs="0"/&gt;</code>												

element **OperationAortenklappeBasis/OAK\_Aortenklappenannulus**

diagram										
type	<a href="#">Zahl3</a>									
properties	<table border="1"> <tbody> <tr> <td>minOcc</td> <td>0</td> </tr> <tr> <td>maxOcc</td> <td>1</td> </tr> <tr> <td>content</td> <td>simple</td> </tr> </tbody> </table>	minOcc	0	maxOcc	1	content	simple			
minOcc	0									
maxOcc	1									
content	simple									
facets	<table border="1"> <thead> <tr> <th>Kind</th> <th>Value</th> <th>Annotation</th> </tr> </thead> <tbody> <tr> <td>minInclusive</td> <td>1</td> <td></td> </tr> <tr> <td>maxInclusive</td> <td>999</td> <td></td> </tr> </tbody> </table>	Kind	Value	Annotation	minInclusive	1		maxInclusive	999	
Kind	Value	Annotation								
minInclusive	1									
maxInclusive	999									
source	<code>&lt;element name="OAK_Aortenklappenannulus" type="Zahl3" minOccurs="0"/&gt;</code>									

element **OperationAortenklappeBasis/OAK\_MessmethodeSchluessel**

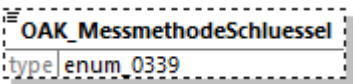
diagram													
type	<a href="#">enum_0339</a>												
properties	minOcc 0 maxOcc 1 content simple												
facets	<table border="1"> <thead> <tr> <th>Kind</th> <th>Value</th> <th>Annotation</th> </tr> </thead> <tbody> <tr> <td>enumeration</td> <td>0339001</td> <td>documentation TEE</td> </tr> <tr> <td>enumeration</td> <td>0339002</td> <td>documentation CT</td> </tr> <tr> <td>enumeration</td> <td>0339042</td> <td>documentation andere</td> </tr> </tbody> </table>	Kind	Value	Annotation	enumeration	0339001	documentation TEE	enumeration	0339002	documentation CT	enumeration	0339042	documentation andere
Kind	Value	Annotation											
enumeration	0339001	documentation TEE											
enumeration	0339002	documentation CT											
enumeration	0339042	documentation andere											
source	<code>&lt;element name="OAK_MessmethodeSchluessel" type="enum_0339" minOccurs="0"/&gt;</code>												

element **OperationAortenklappeBasis/OAK\_DistanzRca**

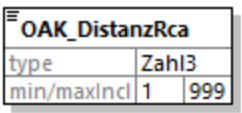
diagram										
type	<a href="#">Zahl3</a>									
properties	content simple									
facets	<table border="1"> <thead> <tr> <th>Kind</th> <th>Value</th> <th>Annotation</th> </tr> </thead> <tbody> <tr> <td>minInclusive</td> <td>1</td> <td></td> </tr> <tr> <td>maxInclusive</td> <td>999</td> <td></td> </tr> </tbody> </table>	Kind	Value	Annotation	minInclusive	1		maxInclusive	999	
Kind	Value	Annotation								
minInclusive	1									
maxInclusive	999									
source	<code>&lt;element name="OAK_DistanzRca" type="Zahl3"/&gt;</code>									

element **OperationAortenklappeBasis/OAK\_DistanzRcaUnbekannt**

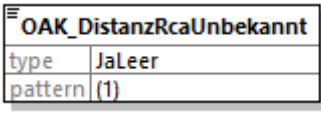
diagram							
type	<a href="#">JaLeer</a>						
properties	content simple						
facets	<table border="1"> <thead> <tr> <th>Kind</th> <th>Value</th> <th>Annotation</th> </tr> </thead> <tbody> <tr> <td>pattern</td> <td>(1)</td> <td></td> </tr> </tbody> </table>	Kind	Value	Annotation	pattern	(1)	
Kind	Value	Annotation					
pattern	(1)						
source	<code>&lt;element name="OAK_DistanzRcaUnbekannt" type="JaLeer"/&gt;</code>						

element **OperationAortenklappeBasis/OAK\_DistanzLca**

diagram	
type	<a href="#">Zahl3</a>

properties	content simple									
facets	<table border="1"> <thead> <tr> <th>Kind</th> <th>Value</th> <th>Annotation</th> </tr> </thead> <tbody> <tr> <td>minInclusive</td> <td>1</td> <td></td> </tr> <tr> <td>maxInclusive</td> <td>999</td> <td></td> </tr> </tbody> </table>	Kind	Value	Annotation	minInclusive	1		maxInclusive	999	
Kind	Value	Annotation								
minInclusive	1									
maxInclusive	999									
source	<code>&lt;element name="OAK_DistanzLca" type="Zahl13"/&gt;</code>									

#### element **OperationAortenklappeBasis/OAK\_DistanzLcaUnbekannt**

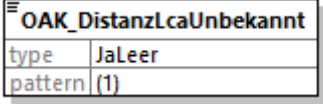
diagram							
type	<a href="#">JaLeer</a>						
properties	content simple						
facets	<table border="1"> <thead> <tr> <th>Kind</th> <th>Value</th> <th>Annotation</th> </tr> </thead> <tbody> <tr> <td>pattern</td> <td>(1)</td> <td></td> </tr> </tbody> </table>	Kind	Value	Annotation	pattern	(1)	
Kind	Value	Annotation					
pattern	(1)						
source	<code>&lt;element name="OAK_DistanzLcaUnbekannt" type="JaLeer"/&gt;</code>						

#### element **OperationAortenklappeBasis/OAK\_PtcaVorSchluessel**

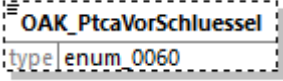
diagram										
type	<a href="#">enum_0060</a>									
properties	<table border="1"> <tbody> <tr> <td>minOcc</td> <td>0</td> </tr> <tr> <td>maxOcc</td> <td>1</td> </tr> <tr> <td>content</td> <td>simple</td> </tr> </tbody> </table>	minOcc	0	maxOcc	1	content	simple			
minOcc	0									
maxOcc	1									
content	simple									
facets	<table border="1"> <thead> <tr> <th>Kind</th> <th>Value</th> <th>Annotation</th> </tr> </thead> <tbody> <tr> <td>enumeration</td> <td>0060001</td> <td>documentation ja</td> </tr> <tr> <td>enumeration</td> <td>0060002</td> <td>documentation nein</td> </tr> </tbody> </table>	Kind	Value	Annotation	enumeration	0060001	documentation ja	enumeration	0060002	documentation nein
Kind	Value	Annotation								
enumeration	0060001	documentation ja								
enumeration	0060002	documentation nein								
source	<code>&lt;element name="OAK_PtcaVorSchluessel" type="enum_0060" minOccurs="0"/&gt;</code>									

#### element **OperationAortenklappeBasis/OAK\_PtcaVorDurchmesser**

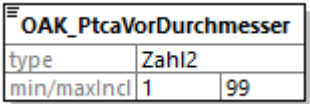
diagram										
type	<a href="#">Zahl2</a>									
properties	content simple									
facets	<table border="1"> <thead> <tr> <th>Kind</th> <th>Value</th> <th>Annotation</th> </tr> </thead> <tbody> <tr> <td>minInclusive</td> <td>1</td> <td></td> </tr> <tr> <td>maxInclusive</td> <td>99</td> <td></td> </tr> </tbody> </table>	Kind	Value	Annotation	minInclusive	1		maxInclusive	99	
Kind	Value	Annotation								
minInclusive	1									
maxInclusive	99									
source	<code>&lt;element name="OAK_PtcaVorDurchmesser" type="Zahl2"/&gt;</code>									

element **OperationAortenklappeBasis/OAK\_PtcaVorDurchmesserUnbekannt**

diagram							
type	<a href="#">JaLeer</a>						
properties	content simple						
facets	<table border="1"> <thead> <tr> <th>Kind</th> <th>Value</th> <th>Annotation</th> </tr> </thead> <tbody> <tr> <td>pattern</td> <td>(1)</td> <td></td> </tr> </tbody> </table>	Kind	Value	Annotation	pattern	(1)	
Kind	Value	Annotation					
pattern	(1)						
source	<code>&lt;element name="OAK_PtcaVorDurchmesserUnbekannt" type="JaLeer"/&gt;</code>						

element **OperationAortenklappeBasis/OAK\_PtcaVorAnzahl**

diagram										
type	<a href="#">Zahl2</a>									
properties	<table border="1"> <tbody> <tr> <td>minOcc</td> <td>0</td> </tr> <tr> <td>maxOcc</td> <td>1</td> </tr> <tr> <td>content</td> <td>simple</td> </tr> </tbody> </table>	minOcc	0	maxOcc	1	content	simple			
minOcc	0									
maxOcc	1									
content	simple									
facets	<table border="1"> <thead> <tr> <th>Kind</th> <th>Value</th> <th>Annotation</th> </tr> </thead> <tbody> <tr> <td>minInclusive</td> <td>1</td> <td></td> </tr> <tr> <td>maxInclusive</td> <td>99</td> <td></td> </tr> </tbody> </table>	Kind	Value	Annotation	minInclusive	1		maxInclusive	99	
Kind	Value	Annotation								
minInclusive	1									
maxInclusive	99									
source	<code>&lt;element name="OAK_PtcaVorAnzahl" type="Zahl2" minOccurs="0"/&gt;</code>									

element **OperationAortenklappeBasis/OAK\_RapidPacingVorSchluessel**

diagram										
type	<a href="#">enum_0060</a>									
properties	<table border="1"> <tbody> <tr> <td>minOcc</td> <td>0</td> </tr> <tr> <td>maxOcc</td> <td>1</td> </tr> <tr> <td>content</td> <td>simple</td> </tr> </tbody> </table>	minOcc	0	maxOcc	1	content	simple			
minOcc	0									
maxOcc	1									
content	simple									
facets	<table border="1"> <thead> <tr> <th>Kind</th> <th>Value</th> <th>Annotation</th> </tr> </thead> <tbody> <tr> <td>enumeration</td> <td>0060001</td> <td>documentation ja</td> </tr> <tr> <td>enumeration</td> <td>0060002</td> <td>documentation nein</td> </tr> </tbody> </table>	Kind	Value	Annotation	enumeration	0060001	documentation ja	enumeration	0060002	documentation nein
Kind	Value	Annotation								
enumeration	0060001	documentation ja								
enumeration	0060002	documentation nein								
source	<code>&lt;element name="OAK_RapidPacingVorSchluessel" type="enum_0060" minOccurs="0"/&gt;</code>									

element **OperationAortenklappeBasis/OAK\_RapidPacingIntraSchluessel**

diagram					
type	<a href="#">enum_0060</a>				
properties	<table border="1"> <tbody> <tr> <td>minOcc</td> <td>0</td> </tr> <tr> <td>maxOcc</td> <td>1</td> </tr> </tbody> </table>	minOcc	0	maxOcc	1
minOcc	0				
maxOcc	1				

	content simple									
facets	<table border="1"> <thead> <tr> <th>Kind</th> <th>Value</th> <th>Annotation</th> </tr> </thead> <tbody> <tr> <td>enumeration</td> <td>0060001</td> <td>documentation ja</td> </tr> <tr> <td>enumeration</td> <td>0060002</td> <td>documentation nein</td> </tr> </tbody> </table>	Kind	Value	Annotation	enumeration	0060001	documentation ja	enumeration	0060002	documentation nein
Kind	Value	Annotation								
enumeration	0060001	documentation ja								
enumeration	0060002	documentation nein								
source	<element name="OAK_RapidPacingIntraSchluessel" type="enum_0060" minOccurs="0"/>									

#### element OperationAortenklappeBasis/OAK\_PtcaNachSchluessel

diagram										
type	<a href="#">enum_0060</a>									
properties	minOcc 0 maxOcc 1 content simple									
facets	<table border="1"> <thead> <tr> <th>Kind</th> <th>Value</th> <th>Annotation</th> </tr> </thead> <tbody> <tr> <td>enumeration</td> <td>0060001</td> <td>documentation ja</td> </tr> <tr> <td>enumeration</td> <td>0060002</td> <td>documentation nein</td> </tr> </tbody> </table>	Kind	Value	Annotation	enumeration	0060001	documentation ja	enumeration	0060002	documentation nein
Kind	Value	Annotation								
enumeration	0060001	documentation ja								
enumeration	0060002	documentation nein								
source	<element name="OAK_PtcaNachSchluessel" type="enum_0060" minOccurs="0"/>									

#### element OperationAortenklappeBasis/OAK\_PtcaNachDurchmesser

diagram										
type	<a href="#">Zahl2</a>									
properties	content simple									
facets	<table border="1"> <thead> <tr> <th>Kind</th> <th>Value</th> <th>Annotation</th> </tr> </thead> <tbody> <tr> <td>minInclusive</td> <td>1</td> <td></td> </tr> <tr> <td>maxInclusive</td> <td>99</td> <td></td> </tr> </tbody> </table>	Kind	Value	Annotation	minInclusive	1		maxInclusive	99	
Kind	Value	Annotation								
minInclusive	1									
maxInclusive	99									
source	<element name="OAK_PtcaNachDurchmesser" type="Zahl2"/>									

#### element OperationAortenklappeBasis/OAK\_PtcaNachDurchmesserUnbekannt

diagram							
type	<a href="#">JaLeer</a>						
properties	content simple						
facets	<table border="1"> <thead> <tr> <th>Kind</th> <th>Value</th> <th>Annotation</th> </tr> </thead> <tbody> <tr> <td>pattern</td> <td>(1)</td> <td></td> </tr> </tbody> </table>	Kind	Value	Annotation	pattern	(1)	
Kind	Value	Annotation					
pattern	(1)						
source	<element name="OAK_PtcaNachDurchmesserUnbekannt" type="JaLeer"/>						

element **OperationAortenklappeBasis/OAK\_PtcaNachAnzahl**

diagram										
type	<a href="#">Zahl2</a>									
properties	minOcc 0 maxOcc 1 content simple									
facets	<table border="1"> <thead> <tr> <th>Kind</th> <th>Value</th> <th>Annotation</th> </tr> </thead> <tbody> <tr> <td>minInclusive</td> <td>1</td> <td></td> </tr> <tr> <td>maxInclusive</td> <td>99</td> <td></td> </tr> </tbody> </table>	Kind	Value	Annotation	minInclusive	1		maxInclusive	99	
Kind	Value	Annotation								
minInclusive	1									
maxInclusive	99									
source	<code>&lt;element name="OAK_PtcaNachAnzahl" type="Zahl2" minOccurs="0"/&gt;</code>									

element **OperationAortenklappeBasis/OAK\_RapidPacingNachSchluessel**

diagram										
type	<a href="#">enum_0060</a>									
properties	minOcc 0 maxOcc 1 content simple									
facets	<table border="1"> <thead> <tr> <th>Kind</th> <th>Value</th> <th>Annotation</th> </tr> </thead> <tbody> <tr> <td>enumeration</td> <td>0060001</td> <td>documentation ja</td> </tr> <tr> <td>enumeration</td> <td>0060002</td> <td>documentation nein</td> </tr> </tbody> </table>	Kind	Value	Annotation	enumeration	0060001	documentation ja	enumeration	0060002	documentation nein
Kind	Value	Annotation								
enumeration	0060001	documentation ja								
enumeration	0060002	documentation nein								
source	<code>&lt;element name="OAK_RapidPacingNachSchluessel" type="enum_0060" minOccurs="0"/&gt;</code>									

element **OperationAortenklappeBasis/OAK\_KonversionSchluessel**

diagram																									
type	<a href="#">enum_0351</a>																								
properties	minOcc 0 maxOcc 1 content simple																								
facets	<table border="1"> <thead> <tr> <th>Kind</th> <th>Value</th> <th>Annotation</th> </tr> </thead> <tbody> <tr> <td>enumeration</td> <td>0351001</td> <td>documentation nein</td> </tr> <tr> <td>enumeration</td> <td>0351002</td> <td>documentation ja, zu Stenotomie</td> </tr> <tr> <td>enumeration</td> <td>0351003</td> <td>documentation ja, zu transapikal</td> </tr> <tr> <td>enumeration</td> <td>0351004</td> <td>documentation ja, zu transaortal</td> </tr> <tr> <td>enumeration</td> <td>0351005</td> <td>documentation ja, zu transfemorale</td> </tr> <tr> <td>enumeration</td> <td>0351006</td> <td>documentation ja, zu transaxillär</td> </tr> <tr> <td>enumeration</td> <td>0351007</td> <td>documentation ja, zu anderem endovaskulären Zugang</td> </tr> </tbody> </table>	Kind	Value	Annotation	enumeration	0351001	documentation nein	enumeration	0351002	documentation ja, zu Stenotomie	enumeration	0351003	documentation ja, zu transapikal	enumeration	0351004	documentation ja, zu transaortal	enumeration	0351005	documentation ja, zu transfemorale	enumeration	0351006	documentation ja, zu transaxillär	enumeration	0351007	documentation ja, zu anderem endovaskulären Zugang
Kind	Value	Annotation																							
enumeration	0351001	documentation nein																							
enumeration	0351002	documentation ja, zu Stenotomie																							
enumeration	0351003	documentation ja, zu transapikal																							
enumeration	0351004	documentation ja, zu transaortal																							
enumeration	0351005	documentation ja, zu transfemorale																							
enumeration	0351006	documentation ja, zu transaxillär																							
enumeration	0351007	documentation ja, zu anderem endovaskulären Zugang																							

	enumeration 0351042 documentation ja, zu anderem Zugang
source	<element name="OAK_KonversionSchluessel" type="enum_0351" minOccurs="0"/>

#### element **OperationAortenklappeBasis/OAK\_SuccessSchluessel**

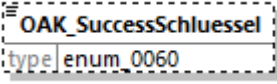
diagram										
type	<a href="#">enum_0060</a>									
properties	minOcc 0 maxOcc 1 content simple									
facets	<table border="1"> <thead> <tr> <th>Kind</th> <th>Value</th> <th>Annotation</th> </tr> </thead> <tbody> <tr> <td>enumeration</td> <td>0060001</td> <td>documentation ja</td> </tr> <tr> <td>enumeration</td> <td>0060002</td> <td>documentation nein</td> </tr> </tbody> </table>	Kind	Value	Annotation	enumeration	0060001	documentation ja	enumeration	0060002	documentation nein
Kind	Value	Annotation								
enumeration	0060001	documentation ja								
enumeration	0060002	documentation nein								
source	<element name="OAK_SuccessSchluessel" type="enum_0060" minOccurs="0"/>									

#### element **OperationAortenklappeBasis/OAK\_AnaesthesieSchluessel**

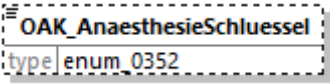
diagram																
type	<a href="#">enum_0352</a>															
properties	minOcc 0 maxOcc 1 content simple															
facets	<table border="1"> <thead> <tr> <th>Kind</th> <th>Value</th> <th>Annotation</th> </tr> </thead> <tbody> <tr> <td>enumeration</td> <td>0352001</td> <td>documentation nein</td> </tr> <tr> <td>enumeration</td> <td>0352002</td> <td>documentation ja, Intubationsnarkose</td> </tr> <tr> <td>enumeration</td> <td>0352003</td> <td>documentation ja, Maskenbeatmung, incl. LAMA</td> </tr> <tr> <td>enumeration</td> <td>0352042</td> <td>documentation ja, unbekannt welche</td> </tr> </tbody> </table>	Kind	Value	Annotation	enumeration	0352001	documentation nein	enumeration	0352002	documentation ja, Intubationsnarkose	enumeration	0352003	documentation ja, Maskenbeatmung, incl. LAMA	enumeration	0352042	documentation ja, unbekannt welche
Kind	Value	Annotation														
enumeration	0352001	documentation nein														
enumeration	0352002	documentation ja, Intubationsnarkose														
enumeration	0352003	documentation ja, Maskenbeatmung, incl. LAMA														
enumeration	0352042	documentation ja, unbekannt welche														
source	<element name="OAK_AnaesthesieSchluessel" type="enum_0352" minOccurs="0"/>															

#### element **OperationAortenklappeBasis/OAK\_DeltaPmeanNachOp**

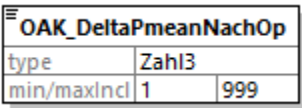
diagram										
type	<a href="#">Zahl3</a>									
properties	content simple									
facets	<table border="1"> <thead> <tr> <th>Kind</th> <th>Value</th> <th>Annotation</th> </tr> </thead> <tbody> <tr> <td>minInclusive</td> <td>1</td> <td></td> </tr> <tr> <td>maxInclusive</td> <td>999</td> <td></td> </tr> </tbody> </table>	Kind	Value	Annotation	minInclusive	1		maxInclusive	999	
Kind	Value	Annotation								
minInclusive	1									
maxInclusive	999									



source	<code>&lt;element name="OAK_DeltaPmeanNachOp" type="Zah13"/&gt;</code>
--------	--

element **OperationAortenklappeBasis/OAK\_DeltaPmeanNachOpUnbekannt**

diagram							
type	<a href="#">JaLeer</a>						
properties	content simple						
facets	<table border="1"> <thead> <tr> <th>Kind</th> <th>Value</th> <th>Annotation</th> </tr> </thead> <tbody> <tr> <td>pattern</td> <td>(1)</td> <td></td> </tr> </tbody> </table>	Kind	Value	Annotation	pattern	(1)	
Kind	Value	Annotation					
pattern	(1)						
source	<code>&lt;element name="OAK_DeltaPmeanNachOpUnbekannt" type="JaLeer"/&gt;</code>						

element **OperationAortenklappeBasis/OAK\_ResidualeInsuffizienzSchluessel**

diagram																			
type	<a href="#">enum_0353</a>																		
properties	<table border="1"> <tbody> <tr> <td>minOcc</td> <td>0</td> </tr> <tr> <td>maxOcc</td> <td>1</td> </tr> <tr> <td>content</td> <td>simple</td> </tr> </tbody> </table>	minOcc	0	maxOcc	1	content	simple												
minOcc	0																		
maxOcc	1																		
content	simple																		
facets	<table border="1"> <thead> <tr> <th>Kind</th> <th>Value</th> <th>Annotation</th> </tr> </thead> <tbody> <tr> <td>enumeration</td> <td>0353001</td> <td>documentation keine</td> </tr> <tr> <td>enumeration</td> <td>0353002</td> <td>documentation leichtgradig</td> </tr> <tr> <td>enumeration</td> <td>0353003</td> <td>documentation mittelgradig</td> </tr> <tr> <td>enumeration</td> <td>0353004</td> <td>documentation hochgradig</td> </tr> <tr> <td>enumeration</td> <td>0353099</td> <td>documentation nicht bestimmbar</td> </tr> </tbody> </table>	Kind	Value	Annotation	enumeration	0353001	documentation keine	enumeration	0353002	documentation leichtgradig	enumeration	0353003	documentation mittelgradig	enumeration	0353004	documentation hochgradig	enumeration	0353099	documentation nicht bestimmbar
Kind	Value	Annotation																	
enumeration	0353001	documentation keine																	
enumeration	0353002	documentation leichtgradig																	
enumeration	0353003	documentation mittelgradig																	
enumeration	0353004	documentation hochgradig																	
enumeration	0353099	documentation nicht bestimmbar																	
source	<code>&lt;element name="OAK_ResidualeInsuffizienzSchluessel" type="enum_0353" minOccurs="0"/&gt;</code>																		

element **OperationAortenklappeBasis/OAK\_ZugangVerschlussSchluessel**

diagram													
type	<a href="#">enum_0354</a>												
properties	<table border="1"> <tbody> <tr> <td>minOcc</td> <td>0</td> </tr> <tr> <td>maxOcc</td> <td>1</td> </tr> <tr> <td>content</td> <td>simple</td> </tr> </tbody> </table>	minOcc	0	maxOcc	1	content	simple						
minOcc	0												
maxOcc	1												
content	simple												
facets	<table border="1"> <thead> <tr> <th>Kind</th> <th>Value</th> <th>Annotation</th> </tr> </thead> <tbody> <tr> <td>enumeration</td> <td>0354001</td> <td>documentation chirurgisch-offen</td> </tr> <tr> <td>enumeration</td> <td>0354002</td> <td>documentation Verschluss-System</td> </tr> <tr> <td>enumeration</td> <td>0354042</td> <td>documentation</td> </tr> </tbody> </table>	Kind	Value	Annotation	enumeration	0354001	documentation chirurgisch-offen	enumeration	0354002	documentation Verschluss-System	enumeration	0354042	documentation
Kind	Value	Annotation											
enumeration	0354001	documentation chirurgisch-offen											
enumeration	0354002	documentation Verschluss-System											
enumeration	0354042	documentation											

	sonstige
source	<code>&lt;element name="OAK_ZugangVerschlussSchluessel" type="enum_0354" minOccurs="0"/&gt;</code>

element **OperationAortenklappeBasis/OAK\_ZusaetzlichePciSchluessel**

diagram										
type	<a href="#">enum 0060</a>									
properties	minOcc 0 maxOcc 1 content simple									
facets	<table border="1"> <thead> <tr> <th>Kind</th> <th>Value</th> <th>Annotation</th> </tr> </thead> <tbody> <tr> <td>enumeration</td> <td>0060001</td> <td>documentation ja</td> </tr> <tr> <td>enumeration</td> <td>0060002</td> <td>documentation nein</td> </tr> </tbody> </table>	Kind	Value	Annotation	enumeration	0060001	documentation ja	enumeration	0060002	documentation nein
Kind	Value	Annotation								
enumeration	0060001	documentation ja								
enumeration	0060002	documentation nein								
source	<code>&lt;element name="OAK_ZusaetzlichePciSchluessel" type="enum_0060" minOccurs="0"/&gt;</code>									

element **OperationAortenklappeBasis/OAK\_PciWegenKhkSchluessel**

diagram										
type	<a href="#">enum 0060</a>									
properties	minOcc 0 maxOcc 1 content simple									
facets	<table border="1"> <thead> <tr> <th>Kind</th> <th>Value</th> <th>Annotation</th> </tr> </thead> <tbody> <tr> <td>enumeration</td> <td>0060001</td> <td>documentation ja</td> </tr> <tr> <td>enumeration</td> <td>0060002</td> <td>documentation nein</td> </tr> </tbody> </table>	Kind	Value	Annotation	enumeration	0060001	documentation ja	enumeration	0060002	documentation nein
Kind	Value	Annotation								
enumeration	0060001	documentation ja								
enumeration	0060002	documentation nein								
source	<code>&lt;element name="OAK_PciWegenKhkSchluessel" type="enum_0060" minOccurs="0"/&gt;</code>									

element **OperationAortenklappeBasis/OAK\_PciWegenKomplikationSchluessel**

diagram										
type	<a href="#">enum 0060</a>									
properties	minOcc 0 maxOcc 1 content simple									
facets	<table border="1"> <thead> <tr> <th>Kind</th> <th>Value</th> <th>Annotation</th> </tr> </thead> <tbody> <tr> <td>enumeration</td> <td>0060001</td> <td>documentation ja</td> </tr> <tr> <td>enumeration</td> <td>0060002</td> <td>documentation nein</td> </tr> </tbody> </table>	Kind	Value	Annotation	enumeration	0060001	documentation ja	enumeration	0060002	documentation nein
Kind	Value	Annotation								
enumeration	0060001	documentation ja								
enumeration	0060002	documentation nein								
source	<code>&lt;element name="OAK_PciWegenKomplikationSchluessel" type="enum_0060" minOccurs="0"/&gt;</code>									

### element **OperationAortenklappeBasis/OAK\_LaesionenAnzahl**

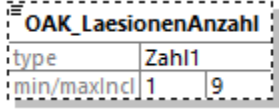
diagram										
type	<a href="#">Zahl1</a>									
properties	minOcc 0 maxOcc 1 content simple									
facets	<table border="1"> <thead> <tr> <th>Kind</th> <th>Value</th> <th>Annotation</th> </tr> </thead> <tbody> <tr> <td>minInclusive</td> <td>1</td> <td></td> </tr> <tr> <td>maxInclusive</td> <td>9</td> <td></td> </tr> </tbody> </table>	Kind	Value	Annotation	minInclusive	1		maxInclusive	9	
Kind	Value	Annotation								
minInclusive	1									
maxInclusive	9									
source	<code>&lt;element name="OAK_LaesionenAnzahl" type="Zahl1" minOccurs="0"/&gt;</code>									

### complexType **TaviAortenklappeBasis**

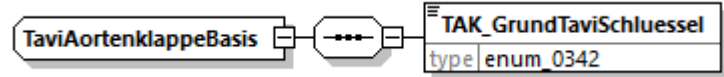
diagram	
namespace	http://xml.ir-d.de/emg
children	<a href="#">TAK_GrundTaviSchluessel</a>
used by	element <a href="#">OperationAortenklappe/taviAortenklappe</a>
source	<code>&lt;complexType name="TaviAortenklappeBasis"&gt;   &lt;sequence&gt;     &lt;element name="TAK_GrundTaviSchluessel" type="enum_0342"/&gt;   &lt;/sequence&gt; &lt;/complexType&gt;</code>

### element **TaviAortenklappeBasis/TAK\_GrundTaviSchluessel**

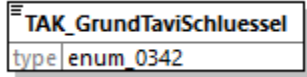
diagram																						
type	<a href="#">enum_0342</a>																					
properties	content simple																					
facets	<table border="1"> <thead> <tr> <th>Kind</th> <th>Value</th> <th>Annotation</th> </tr> </thead> <tbody> <tr> <td>enumeration</td> <td>0342001</td> <td>documentation Alter</td> </tr> <tr> <td>enumeration</td> <td>0342002</td> <td>documentation Frailty</td> </tr> <tr> <td>enumeration</td> <td>0342003</td> <td>documentation Hochrisiko</td> </tr> <tr> <td>enumeration</td> <td>0342004</td> <td>documentation Prognose-limitierende Zweiterkrankung</td> </tr> <tr> <td>enumeration</td> <td>0342005</td> <td>documentation Porzellan-Aorta</td> </tr> <tr> <td>enumeration</td> <td>0342042</td> <td>documentation Sonstige</td> </tr> </tbody> </table>	Kind	Value	Annotation	enumeration	0342001	documentation Alter	enumeration	0342002	documentation Frailty	enumeration	0342003	documentation Hochrisiko	enumeration	0342004	documentation Prognose-limitierende Zweiterkrankung	enumeration	0342005	documentation Porzellan-Aorta	enumeration	0342042	documentation Sonstige
Kind	Value	Annotation																				
enumeration	0342001	documentation Alter																				
enumeration	0342002	documentation Frailty																				
enumeration	0342003	documentation Hochrisiko																				
enumeration	0342004	documentation Prognose-limitierende Zweiterkrankung																				
enumeration	0342005	documentation Porzellan-Aorta																				
enumeration	0342042	documentation Sonstige																				
source	<code>&lt;element name="TAK_GrundTaviSchluessel" type="enum_0342"/&gt;</code>																					

complexType **ProzedurenSchluesselAortenklappeBasis**

diagram	
namespace	http://xml.ir-d.de/emg
children	<a href="#">PAK_ProzedurenSchluessel</a>
used by	element <a href="#">OperationAortenklappe/prozedurenSchluesselAortenklappe</a>
source	<pre>&lt;complexType name="ProzedurenSchluesselAortenklappeBasis"&gt;   &lt;sequence&gt;     &lt;element name="PAK_ProzedurenSchluessel" type="OPS"/&gt;   &lt;/sequence&gt; &lt;/complexType&gt;</pre>

element **ProzedurenSchluesselAortenklappeBasis/PAK\_ProzedurenSchluessel**

diagram							
type	<a href="#">OPS</a>						
properties	content simple						
facets	<table border="1"> <thead> <tr> <th>Kind</th> <th>Value</th> <th>Annotation</th> </tr> </thead> <tbody> <tr> <td>pattern</td> <td>(([135689]\-([0-9]){2}([a-zA-Z0-9]){1}\.([a-zA-Z0-9]{1,2}))*(:[RLBrlb])?)</td> <td></td> </tr> </tbody> </table>	Kind	Value	Annotation	pattern	(([135689]\-([0-9]){2}([a-zA-Z0-9]){1}\.([a-zA-Z0-9]{1,2}))*(:[RLBrlb])?)	
Kind	Value	Annotation					
pattern	(([135689]\-([0-9]){2}([a-zA-Z0-9]){1}\.([a-zA-Z0-9]{1,2}))*(:[RLBrlb])?)						
source	<pre>&lt;element name="PAK_ProzedurenSchluessel" type="OPS"/&gt;</pre>						

complexType **FailureGrundAortenklappeBasis**

diagram	
namespace	http://xml.ir-d.de/emg
children	<a href="#">FAK_FailureGrundSchluessel</a>
used by	element <a href="#">OperationAortenklappe/failureGrundAortenklappe</a>
source	<pre>&lt;complexType name="FailureGrundAortenklappeBasis"&gt;   &lt;sequence&gt;     &lt;element name="FAK_FailureGrundSchluessel" type="enum_0341"/&gt;   &lt;/sequence&gt; &lt;/complexType&gt;</pre>

element **FailureGrundAortenklappeBasis/FAK\_FailureGrundSchluessel**

diagram	
---------	--

type	<a href="#">enum 0341</a>		
properties	content simple		
facets	Kind	Value	Annotation
	enumeration	0341001	documentation intraprozedural verstorben
	enumeration	0341002	documentation Implantation von mehr als einer Prothese
	enumeration	0341003	documentation gravierende Gefäß- oder Zugangskomplikation (gemäß VARC-3)
	enumeration	0341004	documentation erforderlicher chirurgischer oder interventioneller Eingriff wegen einer Klappenfehlfunktion (gemäß VARC-3)
	enumeration	0341005	documentation &gt;= große strukturelle kardiale Komplikation (gemäß VARC-3)
source	<code>&lt;element name="FAK_FailureGrundSchluessel" type="enum_0341"/&gt;</code>		

### complexType **PciAortenklappeBasis**

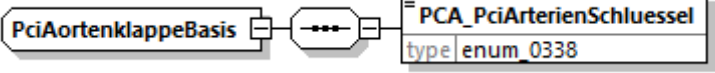
diagram	
namespace	http://xml.ir-d.de/emg
children	<a href="#">PCA_PciArterienSchluessel</a>
used by	element <a href="#">OperationAortenklappe/pciAortenklappe</a>
source	<code>&lt;complexType name="PciAortenklappeBasis"&gt;   &lt;sequence&gt;     &lt;element name="PCA_PciArterienSchluessel" type="enum_0338"/&gt;   &lt;/sequence&gt; &lt;/complexType&gt;</code>

### element **PciAortenklappeBasis/PCA\_PciArterienSchluessel**

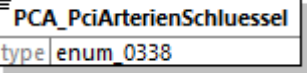
diagram			
type	<a href="#">enum 0338</a>		
properties	content simple		
facets	Kind	Value	Annotation
	enumeration	0338001	documentation LAD
	enumeration	0338002	documentation RCA
	enumeration	0338003	documentation RCX
	enumeration	0338004	documentation Hauptstamm
source	<code>&lt;element name="PCA_PciArterienSchluessel" type="enum_0338"/&gt;</code>		

### complexType **KomplikationAortenklappeBasis**

diagram	
namespace	http://xml.ir-d.de/emg
children	<a href="#">KAK_KomplikationTypSchluessel</a>
used by	element <a href="#">OperationAortenklappe/komplikationAortenklappe</a>
source	<pre>&lt;complexType name="KomplikationAortenklappeBasis"&gt;   &lt;sequence&gt;     &lt;element name="KAK_KomplikationTypSchluessel" type="enum_0343"/&gt;   &lt;/sequence&gt; &lt;/complexType&gt;</pre>

### element **KomplikationAortenklappeBasis/KAK\_KomplikationTypSchluessel**

diagram																																																										
type	<a href="#">enum 0343</a>																																																									
properties	content simple																																																									
facets	<table border="1"> <thead> <tr> <th>Kind</th> <th>Value</th> <th>Annotation</th> </tr> </thead> <tbody> <tr> <td>enumeration</td> <td>0343001</td> <td>documentation Device-Fehlpositionierung</td> </tr> <tr> <td>enumeration</td> <td>0343002</td> <td>documentation Koronarostienverschluss</td> </tr> <tr> <td>enumeration</td> <td>0343003</td> <td>documentation Aortendissektion</td> </tr> <tr> <td>enumeration</td> <td>0343004</td> <td>documentation Aortenregurgitation &amp;gt; = 2. Grades</td> </tr> <tr> <td>enumeration</td> <td>0343005</td> <td>documentation Annulus-Ruptur</td> </tr> <tr> <td>enumeration</td> <td>0343006</td> <td>documentation Ruptur-/Perforation einer Herzhöhle ohne Therapiebedarf</td> </tr> <tr> <td>enumeration</td> <td>0343007</td> <td>documentation Ruptur-/Perforation einer Herzhöhle mit Therapiebedarf</td> </tr> <tr> <td>enumeration</td> <td>0343008</td> <td>documentation Perikardtamponade</td> </tr> <tr> <td>enumeration</td> <td>0343009</td> <td>documentation kardiale Dekompensation</td> </tr> <tr> <td>enumeration</td> <td>0343010</td> <td>documentation Hirnembolie</td> </tr> <tr> <td>enumeration</td> <td>0343011</td> <td>documentation Rhythmusstörungen</td> </tr> <tr> <td>enumeration</td> <td>0343012</td> <td>documentation Device-Embolisation</td> </tr> <tr> <td>enumeration</td> <td>0343013</td> <td>documentation vaskuläre Komplikation</td> </tr> <tr> <td>enumeration</td> <td>0343014</td> <td>documentation Low Cardiac Output</td> </tr> <tr> <td>enumeration</td> <td>0343015</td> <td>documentation schwerwiegende Blutungen (intraprozedural)</td> </tr> <tr> <td>enumeration</td> <td>0343016</td> <td>documentation lebensbedrohliche Blutungen (intraprozedural)</td> </tr> <tr> <td>enumeration</td> <td>0343017</td> <td>documentation Patient verstarb im OP/Katheterlabor</td> </tr> <tr> <td>enumeration</td> <td>0343042</td> <td>documentation</td> </tr> </tbody> </table>	Kind	Value	Annotation	enumeration	0343001	documentation Device-Fehlpositionierung	enumeration	0343002	documentation Koronarostienverschluss	enumeration	0343003	documentation Aortendissektion	enumeration	0343004	documentation Aortenregurgitation &gt; = 2. Grades	enumeration	0343005	documentation Annulus-Ruptur	enumeration	0343006	documentation Ruptur-/Perforation einer Herzhöhle ohne Therapiebedarf	enumeration	0343007	documentation Ruptur-/Perforation einer Herzhöhle mit Therapiebedarf	enumeration	0343008	documentation Perikardtamponade	enumeration	0343009	documentation kardiale Dekompensation	enumeration	0343010	documentation Hirnembolie	enumeration	0343011	documentation Rhythmusstörungen	enumeration	0343012	documentation Device-Embolisation	enumeration	0343013	documentation vaskuläre Komplikation	enumeration	0343014	documentation Low Cardiac Output	enumeration	0343015	documentation schwerwiegende Blutungen (intraprozedural)	enumeration	0343016	documentation lebensbedrohliche Blutungen (intraprozedural)	enumeration	0343017	documentation Patient verstarb im OP/Katheterlabor	enumeration	0343042	documentation
Kind	Value	Annotation																																																								
enumeration	0343001	documentation Device-Fehlpositionierung																																																								
enumeration	0343002	documentation Koronarostienverschluss																																																								
enumeration	0343003	documentation Aortendissektion																																																								
enumeration	0343004	documentation Aortenregurgitation &gt; = 2. Grades																																																								
enumeration	0343005	documentation Annulus-Ruptur																																																								
enumeration	0343006	documentation Ruptur-/Perforation einer Herzhöhle ohne Therapiebedarf																																																								
enumeration	0343007	documentation Ruptur-/Perforation einer Herzhöhle mit Therapiebedarf																																																								
enumeration	0343008	documentation Perikardtamponade																																																								
enumeration	0343009	documentation kardiale Dekompensation																																																								
enumeration	0343010	documentation Hirnembolie																																																								
enumeration	0343011	documentation Rhythmusstörungen																																																								
enumeration	0343012	documentation Device-Embolisation																																																								
enumeration	0343013	documentation vaskuläre Komplikation																																																								
enumeration	0343014	documentation Low Cardiac Output																																																								
enumeration	0343015	documentation schwerwiegende Blutungen (intraprozedural)																																																								
enumeration	0343016	documentation lebensbedrohliche Blutungen (intraprozedural)																																																								
enumeration	0343017	documentation Patient verstarb im OP/Katheterlabor																																																								
enumeration	0343042	documentation																																																								

sonstige intraprozedurale Komplikationen

source `<element name="KAK_KomplikationTypSchluessel" type="enum_0343"/>`

### complexType ArtikelidentifikationBasis

diagram

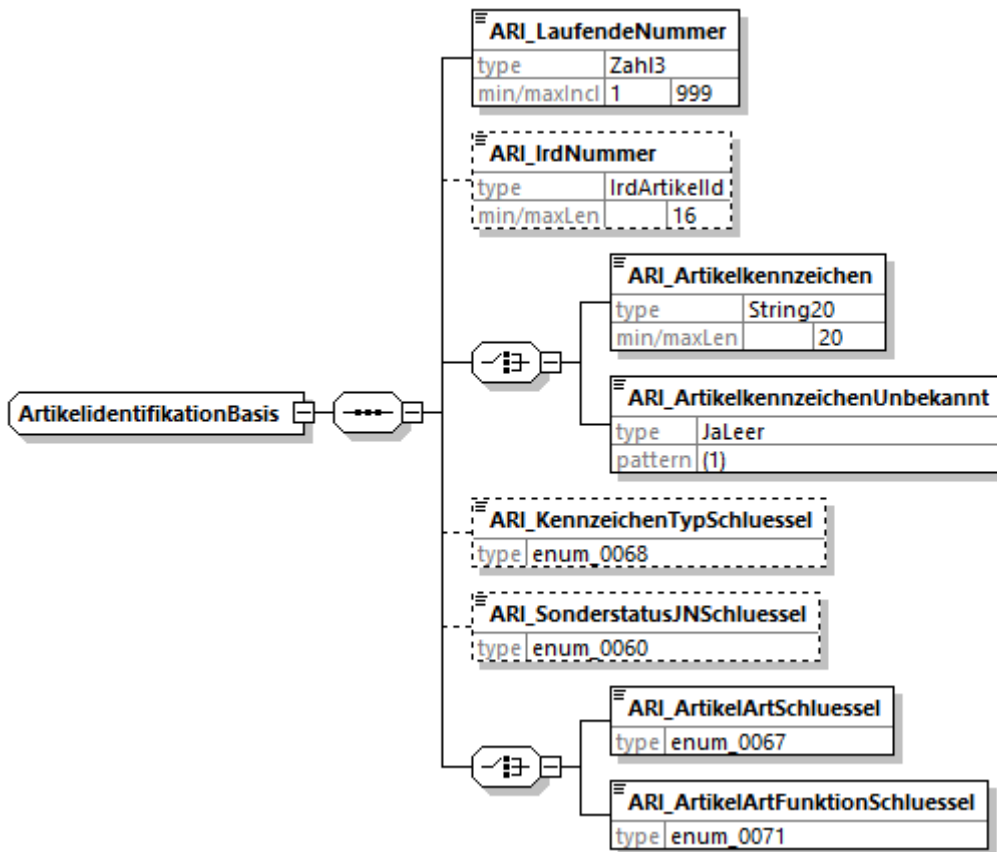

namespace `http://xml.ir-d.de/emg`

children [ARI LaufendeNummer](#) [ARI IrdNummer](#) [ARI Artikelkennzeichen](#) [ARI ArtikelkennzeichenUnbekannt](#) [ARI KennzeichenTypSchluessel](#) [ARI SonderstatusJNSchluessel](#) [ARI ArtikelArtSchluessel](#) [ARI ArtikelArtFunktionSchluessel](#)

used by complexType [Artikelidentifikation](#)

```
<complexType name="ArtikelidentifikationBasis">
  <sequence>
    <element name="ARI_LaufendeNummer" type="Zahl3"/>
    <element name="ARI_IrdNummer" type="IrdArtikelId" minOccurs="0"/>
    <choice>
      <element name="ARI_Artikelkennzeichen" type="String20"/>
      <element name="ARI_ArtikelkennzeichenUnbekannt" type="JaLeer"/>
    </choice>
    <element name="ARI_KennzeichenTypSchluessel" type="enum_0068"
minOccurs="0"/>
    <element name="ARI_SonderstatusJNSchluessel" type="enum_0060"
minOccurs="0"/>
    <choice>
      <element name="ARI_ArtikelArtSchluessel" type="enum_0067"/>
      <element name="ARI_ArtikelArtFunktionSchluessel" type="enum_0071"/>
    </choice>
  </sequence>
```

	<code>&lt;/complexType&gt;</code>
--	-----------------------------------

element **ArtikelidentifikationBasis/ARI\_LaufendeNummer**

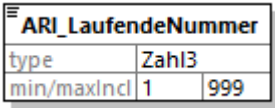
diagram										
type	<a href="#">Zahl3</a>									
properties	content simple									
facets	<table border="1"><thead><tr><th>Kind</th><th>Value</th><th>Annotation</th></tr></thead><tbody><tr><td>minInclusive</td><td>1</td><td></td></tr><tr><td>maxInclusive</td><td>999</td><td></td></tr></tbody></table>	Kind	Value	Annotation	minInclusive	1		maxInclusive	999	
Kind	Value	Annotation								
minInclusive	1									
maxInclusive	999									
source	<code>&lt;element name="ARI_LaufendeNummer" type="Zahl3"/&gt;</code>									

element **ArtikelidentifikationBasis/ARI\_IrdNummer**

diagram							
type	<a href="#">IrdArtikelId</a>						
properties	minOcc 0 maxOcc 1 content simple						
facets	<table border="1"><thead><tr><th>Kind</th><th>Value</th><th>Annotation</th></tr></thead><tbody><tr><td>maxLength</td><td>16</td><td></td></tr></tbody></table>	Kind	Value	Annotation	maxLength	16	
Kind	Value	Annotation					
maxLength	16						
source	<code>&lt;element name="ARI_IrdNummer" type="IrdArtikelId" minOccurs="0"/&gt;</code>						

element **ArtikelidentifikationBasis/ARI\_Artikelkennzeichen**

diagram							
type	<a href="#">String20</a>						
properties	content simple						
facets	<table border="1"><thead><tr><th>Kind</th><th>Value</th><th>Annotation</th></tr></thead><tbody><tr><td>maxLength</td><td>20</td><td></td></tr></tbody></table>	Kind	Value	Annotation	maxLength	20	
Kind	Value	Annotation					
maxLength	20						
source	<code>&lt;element name="ARI_Artikelkennzeichen" type="String20"/&gt;</code>						

element **ArtikelidentifikationBasis/ARI\_ArtikelkennzeichenUnbekannt**

diagram	
---------	---



type	<a href="#">JaLeer</a>						
properties	content simple						
facets	<table border="1"> <thead> <tr> <th>Kind</th> <th>Value</th> <th>Annotation</th> </tr> </thead> <tbody> <tr> <td>pattern</td> <td>(1)</td> <td></td> </tr> </tbody> </table>	Kind	Value	Annotation	pattern	(1)	
Kind	Value	Annotation					
pattern	(1)						
source	<code>&lt;element name="ARI_ArtikelkennzeichenUnbekannt" type="JaLeer"/&gt;</code>						

#### element ArtikelidentifikationBasis/ARI\_KennzeichenTypSchluessel

diagram																
type	<a href="#">enum_0068</a>															
properties	<table border="1"> <tr> <td>minOcc</td> <td>0</td> </tr> <tr> <td>maxOcc</td> <td>1</td> </tr> <tr> <td>content</td> <td>simple</td> </tr> </table>	minOcc	0	maxOcc	1	content	simple									
minOcc	0															
maxOcc	1															
content	simple															
facets	<table border="1"> <thead> <tr> <th>Kind</th> <th>Value</th> <th>Annotation</th> </tr> </thead> <tbody> <tr> <td>enumeration</td> <td>0068001</td> <td>documentation UDI</td> </tr> <tr> <td>enumeration</td> <td>0068002</td> <td>documentation Referenz (REF)</td> </tr> <tr> <td>enumeration</td> <td>0068003</td> <td>documentation Katalognummer</td> </tr> <tr> <td>enumeration</td> <td>0068042</td> <td>documentation sonstiger</td> </tr> </tbody> </table>	Kind	Value	Annotation	enumeration	0068001	documentation UDI	enumeration	0068002	documentation Referenz (REF)	enumeration	0068003	documentation Katalognummer	enumeration	0068042	documentation sonstiger
Kind	Value	Annotation														
enumeration	0068001	documentation UDI														
enumeration	0068002	documentation Referenz (REF)														
enumeration	0068003	documentation Katalognummer														
enumeration	0068042	documentation sonstiger														
source	<code>&lt;element name="ARI_KennzeichenTypSchluessel" type="enum_0068" minOccurs="0"/&gt;</code>															

#### element ArtikelidentifikationBasis/ARI\_SonderstatusJNSchluessel

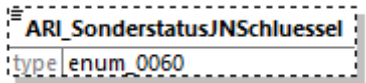
diagram										
type	<a href="#">enum_0060</a>									
properties	<table border="1"> <tr> <td>minOcc</td> <td>0</td> </tr> <tr> <td>maxOcc</td> <td>1</td> </tr> <tr> <td>content</td> <td>simple</td> </tr> </table>	minOcc	0	maxOcc	1	content	simple			
minOcc	0									
maxOcc	1									
content	simple									
facets	<table border="1"> <thead> <tr> <th>Kind</th> <th>Value</th> <th>Annotation</th> </tr> </thead> <tbody> <tr> <td>enumeration</td> <td>0060001</td> <td>documentation ja</td> </tr> <tr> <td>enumeration</td> <td>0060002</td> <td>documentation nein</td> </tr> </tbody> </table>	Kind	Value	Annotation	enumeration	0060001	documentation ja	enumeration	0060002	documentation nein
Kind	Value	Annotation								
enumeration	0060001	documentation ja								
enumeration	0060002	documentation nein								
source	<code>&lt;element name="ARI_SonderstatusJNSchluessel" type="enum_0060" minOccurs="0"/&gt;</code>									

#### element ArtikelidentifikationBasis/ARI\_ArtikelArtSchluessel

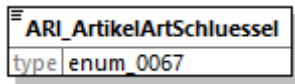
diagram							
type	<a href="#">enum_0067</a>						
properties	content simple						
facets	<table border="1"> <thead> <tr> <th>Kind</th> <th>Value</th> <th>Annotation</th> </tr> </thead> <tbody> <tr> <td>enumeration</td> <td>0067001</td> <td>documentation</td> </tr> </tbody> </table>	Kind	Value	Annotation	enumeration	0067001	documentation
Kind	Value	Annotation					
enumeration	0067001	documentation					

	enumeration 0067002 Implantat documentation Explantat
source	<element name="ARI_ArtikelArtSchluessel" type="enum_0067"/>

element **ArtikelidentifikationBasis/ARI\_ArtikelArtFunktionSchluessel**

diagram													
type	<a href="#">enum 0071</a>												
properties	content simple												
facets	<table border="1"> <thead> <tr> <th>Kind</th> <th>Value</th> <th>Annotation</th> </tr> </thead> <tbody> <tr> <td>enumeration</td> <td>0071001</td> <td>documentation Implantat</td> </tr> <tr> <td>enumeration</td> <td>0071002</td> <td>documentation Explantat</td> </tr> <tr> <td>enumeration</td> <td>0071003</td> <td>documentation Degeneriertes/defektes Produkt, das funktionslos im Körper verbleibt</td> </tr> </tbody> </table>	Kind	Value	Annotation	enumeration	0071001	documentation Implantat	enumeration	0071002	documentation Explantat	enumeration	0071003	documentation Degeneriertes/defektes Produkt, das funktionslos im Körper verbleibt
Kind	Value	Annotation											
enumeration	0071001	documentation Implantat											
enumeration	0071002	documentation Explantat											
enumeration	0071003	documentation Degeneriertes/defektes Produkt, das funktionslos im Körper verbleibt											
source	<element name="ARI_ArtikelArtFunktionSchluessel" type="enum_0071"/>												

# complexType Artikelbeschreibung

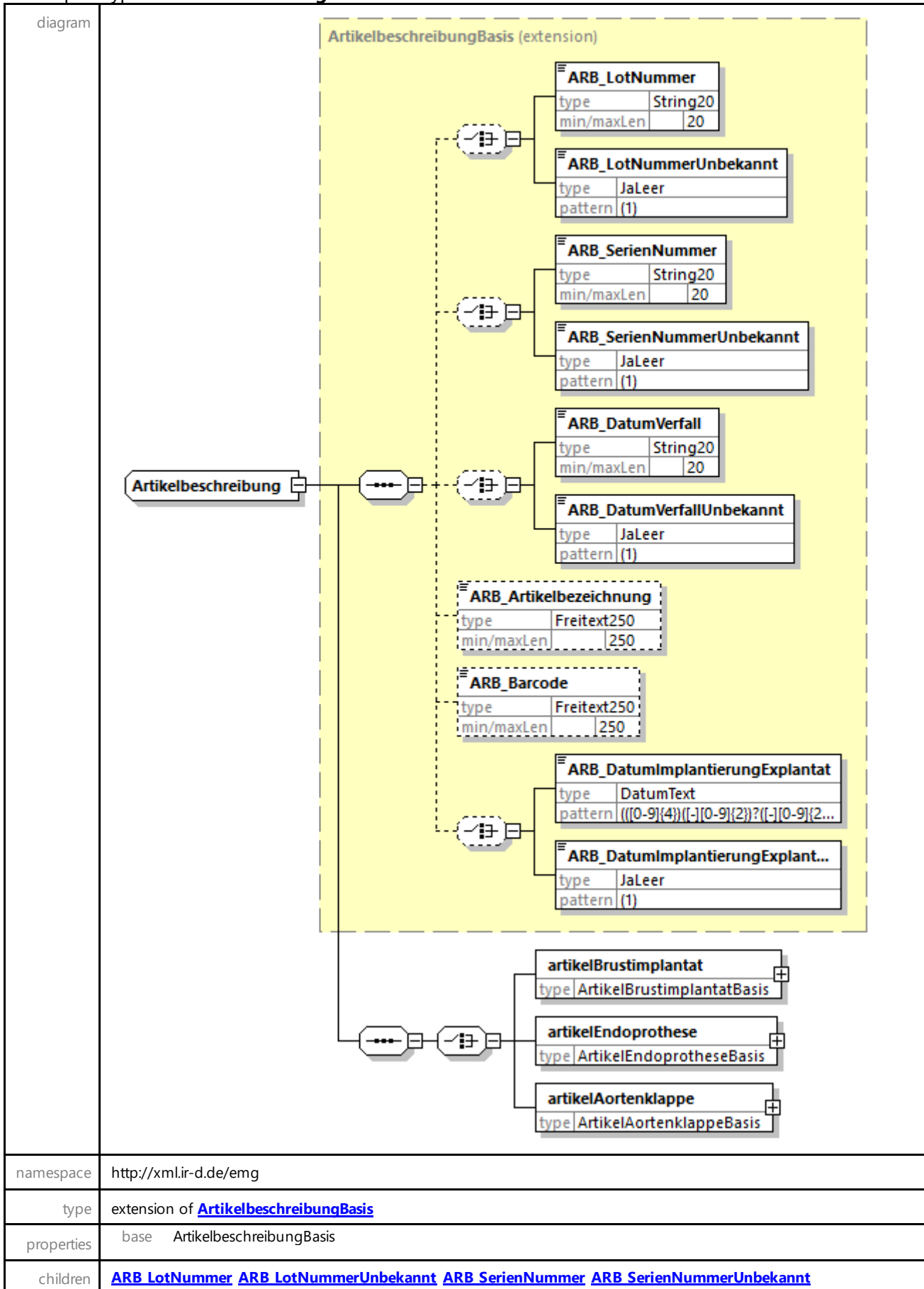

	<a href="#">ARB DatumVerfall</a> <a href="#">ARB DatumVerfallUnbekannt</a> <a href="#">ARB Artikelbezeichnung</a> <a href="#">ARB Barcode</a> <a href="#">ARB DatumImplantierungExplantat</a> <a href="#">ARB DatumImplantierungExplantatUnbekannt</a> <a href="#">artikelBrustimplantat</a> <a href="#">artikelEndoprothese</a> <a href="#">artikelAortenklappe</a>
used by	element <a href="#">Artikelidentifikation/artikelbeschreibung</a>
source	<pre> &lt;complexType name="Artikelbeschreibung"&gt;   &lt;complexContent&gt;     &lt;extension base="ArtikelbeschreibungBasis"&gt;       &lt;sequence&gt;         &lt;choice&gt;           &lt;element name="artikelBrustimplantat" type="ArtikelBrustimplantatBasis"/&gt;           &lt;element name="artikelEndoprothese" type="ArtikelEndoprotheseBasis"/&gt;           &lt;element name="artikelAortenklappe" type="ArtikelAortenklappeBasis"/&gt;         &lt;/choice&gt;       &lt;/sequence&gt;     &lt;/extension&gt;   &lt;/complexContent&gt; &lt;/complexType&gt; </pre>

element **Artikelbeschreibung/artikelBrustimplantat**

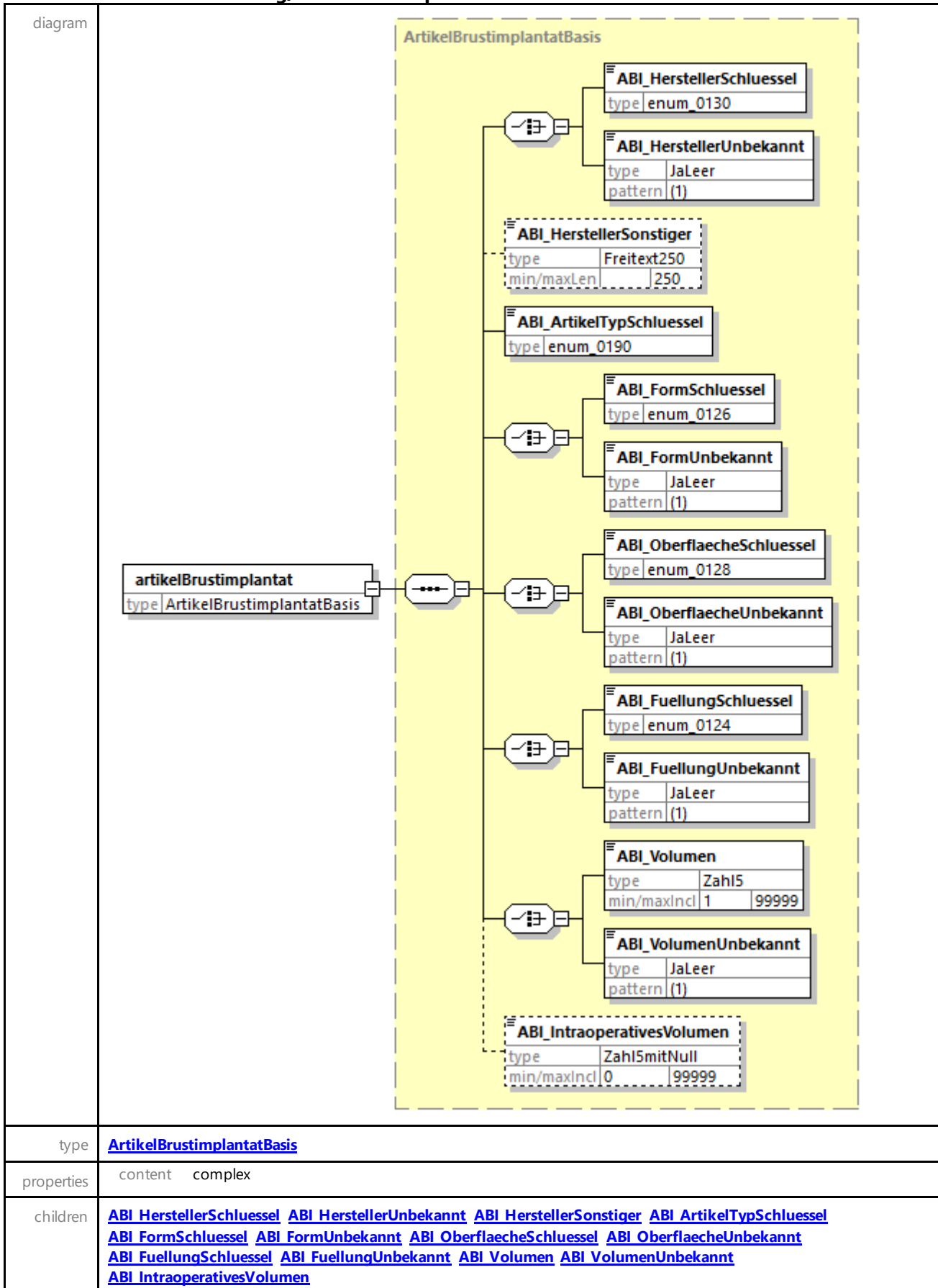

source	<code>&lt;element name="artikelBrustimplantat" type="ArtikelBrustimplantatBasis"/&gt;</code>
--------	--

element **Artikelbeschreibung/artikelEndoprothese**

diagram	
type	<a href="#">ArtikelEndoprotheseBasis</a>
properties	content complex
children	<a href="#">AEP_HerstellerSchluessel</a> <a href="#">AEP_HerstellerUnbekannt</a> <a href="#">AEP_HerstellerSonstiger</a> <a href="#">AEP_ArtikelTypSchluessel</a>
source	<code>&lt;element name="artikelEndoprothese" type="ArtikelEndoprotheseBasis"/&gt;</code>

element **Artikelbeschreibung/artikelAortenklappe**

<p>diagram</p>	<p>The diagram illustrates the structure of the <b>artikelAortenklappe</b> element. It is a simple class that inherits from the <b>ArtikelAortenklappeBasis</b> class. The <b>ArtikelAortenklappeBasis</b> class is a complex class containing several child elements:</p> <ul style="list-style-type: none"> <li><b>AAK_ArtikelTypSchluessel</b>: type enum_0390</li> <li><b>AAK_HerstellerSchluessel</b>: type enum_0330</li> <li><b>AAK_HerstellerUnbekannt</b>: type JaLeer, pattern (1)</li> <li><b>AAK_HerstellerSonstiger</b>: type Freitext250, min/maxLen 250</li> <li><b>AAK_ProthesenGroesse</b>: type Zahl2, min/maxIncl 1 99</li> <li><b>AAK_ProthesenGroesseUnbekannt</b>: type JaLeer, pattern (1)</li> <li><b>AAK_Dislokation</b>: type JaLeer, pattern (1)</li> </ul>
<p>type</p>	<p><a href="#">ArtikelAortenklappeBasis</a></p>
<p>properties</p>	<p>content complex</p>
<p>children</p>	<p><a href="#">AAK ArtikelTypSchluessel</a> <a href="#">AAK HerstellerSchluessel</a> <a href="#">AAK HerstellerUnbekannt</a> <a href="#">AAK HerstellerSonstiger</a> <a href="#">AAK ProthesenGroesse</a> <a href="#">AAK ProthesenGroesseUnbekannt</a> <a href="#">AAK Dislokation</a></p>
<p>source</p>	<p><code>&lt;element name="artikelAortenklappe" type="ArtikelAortenklappeBasis"/&gt;</code></p>

complexType **ZubehoerBasis**

<p>diagram</p>	
<p>namespace</p>	<p>http://xml.ir-d.de/emg</p>
<p>children</p>	<p><a href="#">ZUB LaufendeNummer</a> <a href="#">ZUB ZubehoerArtSchluessel</a> <a href="#">ZUB ArtikelNummer</a> <a href="#">ZUB ArtikelNummerUnbekannt</a>  <a href="#">ZUB LotNummer</a> <a href="#">ZUB LotNummerUnbekannt</a> <a href="#">ZUB SerienNummer</a> <a href="#">ZUB SerienNummerUnbekannt</a>  <a href="#">ZUB Artikelbezeichnung</a></p>
<p>used by</p>	<p>complexType <a href="#">Zubehoer</a></p>
<p>source</p>	<pre>&lt;complexType name="ZubehoerBasis"&gt;   &lt;sequence&gt;     &lt;element name="ZUB_LaufendeNummer" type="Zahl3"/&gt;     &lt;element name="ZUB_ZubehoerArtSchluessel" type="enum_0069"/&gt;     &lt;choice&gt;       &lt;element name="ZUB_ArtikelNummer" type="String20"/&gt;       &lt;element name="ZUB_ArtikelNummerUnbekannt" type="JaLeer"/&gt;     &lt;/choice&gt;     &lt;choice minOccurs="0"&gt;       &lt;element name="ZUB_LotNummer" type="String20"/&gt;       &lt;element name="ZUB_LotNummerUnbekannt" type="JaLeer"/&gt;     &lt;/choice&gt;     &lt;choice minOccurs="0"&gt;       &lt;element name="ZUB_SerienNummer" type="String20"/&gt;       &lt;element name="ZUB_SerienNummerUnbekannt" type="JaLeer"/&gt;     &lt;/choice&gt;   &lt;/sequence&gt; &lt;/complexType&gt;</pre>



	<pre>&lt;element name="ZUB_Artikelbezeichnung" type="Freitext250" minOccurs="0"/&gt; &lt;/sequence&gt; &lt;/complexType&gt;</pre>
--	---

element **ZubehoerBasis/ZUB\_LaufendeNummer**

diagram										
type	<a href="#">Zahl3</a>									
properties	content simple									
facets	<table border="1"> <thead> <tr> <th>Kind</th> <th>Value</th> <th>Annotation</th> </tr> </thead> <tbody> <tr> <td>minInclusive</td> <td>1</td> <td></td> </tr> <tr> <td>maxInclusive</td> <td>999</td> <td></td> </tr> </tbody> </table>	Kind	Value	Annotation	minInclusive	1		maxInclusive	999	
Kind	Value	Annotation								
minInclusive	1									
maxInclusive	999									
source	<pre>&lt;element name="ZUB_LaufendeNummer" type="Zahl3"/&gt;</pre>									

element **ZubehoerBasis/ZUB\_ZubehoerArtSchluessel**

diagram										
type	<a href="#">enum_0069</a>									
properties	content simple									
facets	<table border="1"> <thead> <tr> <th>Kind</th> <th>Value</th> <th>Annotation</th> </tr> </thead> <tbody> <tr> <td>enumeration</td> <td>0069001</td> <td>documentation Implantat</td> </tr> <tr> <td>enumeration</td> <td>0069002</td> <td>documentation Explantat</td> </tr> </tbody> </table>	Kind	Value	Annotation	enumeration	0069001	documentation Implantat	enumeration	0069002	documentation Explantat
Kind	Value	Annotation								
enumeration	0069001	documentation Implantat								
enumeration	0069002	documentation Explantat								
source	<pre>&lt;element name="ZUB_ZubehoerArtSchluessel" type="enum_0069"/&gt;</pre>									

element **ZubehoerBasis/ZUB\_ArtikelNummer**

diagram							
type	<a href="#">String20</a>						
properties	content simple						
facets	<table border="1"> <thead> <tr> <th>Kind</th> <th>Value</th> <th>Annotation</th> </tr> </thead> <tbody> <tr> <td>maxLength</td> <td>20</td> <td></td> </tr> </tbody> </table>	Kind	Value	Annotation	maxLength	20	
Kind	Value	Annotation					
maxLength	20						
source	<pre>&lt;element name="ZUB_ArtikelNummer" type="String20"/&gt;</pre>						

element **ZubehoerBasis/ZUB\_ArtikelNummerUnbekannt**

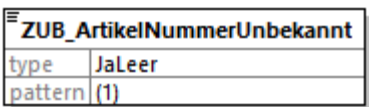
diagram	
type	<a href="#">JaLeer</a>
properties	content simple
facets	Kind Value Annotation pattern (1)
source	<code>&lt;element name="ZUB_ArtikelNummerUnbekannt" type="JaLeer"/&gt;</code>

element **ZubehoerBasis/ZUB\_LotNummer**

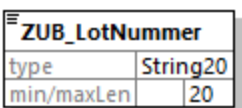
diagram	
type	<a href="#">String20</a>
properties	content simple
facets	Kind Value Annotation maxLength 20
source	<code>&lt;element name="ZUB_LotNummer" type="String20"/&gt;</code>

element **ZubehoerBasis/ZUB\_LotNummerUnbekannt**

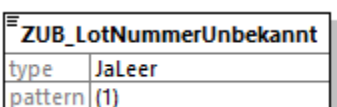
diagram	
type	<a href="#">JaLeer</a>
properties	content simple
facets	Kind Value Annotation pattern (1)
source	<code>&lt;element name="ZUB_LotNummerUnbekannt" type="JaLeer"/&gt;</code>

element **ZubehoerBasis/ZUB\_SerienNummer**

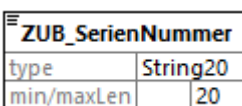
diagram	
type	<a href="#">String20</a>
properties	content simple
facets	Kind Value Annotation maxLength 20
source	<code>&lt;element name="ZUB_SerienNummer" type="String20"/&gt;</code>

element **ZubehoerBasis/ZUB\_SerienNummerUnbekannt**

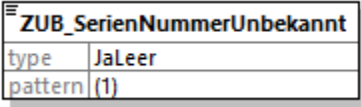
diagram							
type	<a href="#">JaLeer</a>						
properties	content simple						
facets	<table border="1"> <thead> <tr> <th>Kind</th> <th>Value</th> <th>Annotation</th> </tr> </thead> <tbody> <tr> <td>pattern</td> <td>(1)</td> <td></td> </tr> </tbody> </table>	Kind	Value	Annotation	pattern	(1)	
Kind	Value	Annotation					
pattern	(1)						
source	<code>&lt;element name="ZUB_SerienNummerUnbekannt" type="JaLeer"/&gt;</code>						

element **ZubehoerBasis/ZUB\_Artikelbezeichnung**

diagram							
type	<a href="#">Freitext250</a>						
properties	<table border="1"> <tbody> <tr> <td>minOcc</td> <td>0</td> </tr> <tr> <td>maxOcc</td> <td>1</td> </tr> <tr> <td>content</td> <td>simple</td> </tr> </tbody> </table>	minOcc	0	maxOcc	1	content	simple
minOcc	0						
maxOcc	1						
content	simple						
facets	<table border="1"> <thead> <tr> <th>Kind</th> <th>Value</th> <th>Annotation</th> </tr> </thead> <tbody> <tr> <td>maxLength</td> <td>250</td> <td></td> </tr> </tbody> </table>	Kind	Value	Annotation	maxLength	250	
Kind	Value	Annotation					
maxLength	250						
source	<code>&lt;element name="ZUB_Artikelbezeichnung" type="Freitext250" minOccurs="0"/&gt;</code>						

complexType **ZubehoerBrustimplantatBasis**

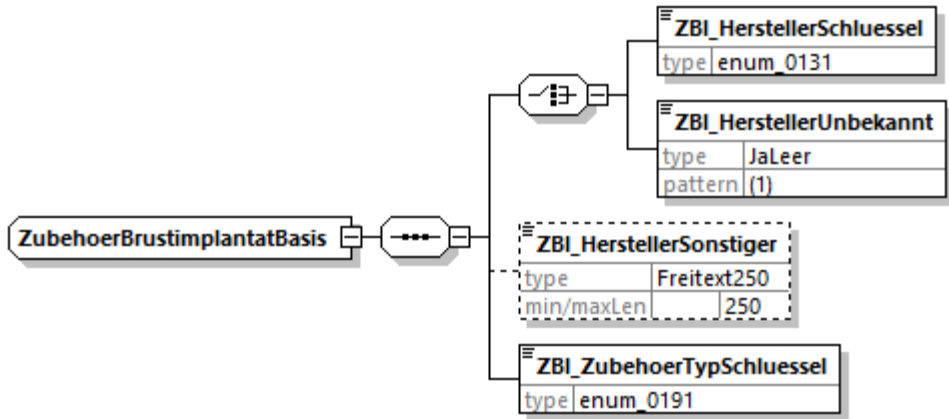
diagram	
namespace	http://xml.ir-d.de/emg
children	<a href="#">ZBI_HerstellerSchluessel</a> <a href="#">ZBI_HerstellerUnbekannt</a> <a href="#">ZBI_HerstellerSonstiger</a> <a href="#">ZBI_ZubehoerTypSchluessel</a>
used by	element <a href="#">Zubehoer/zubehoerBrustimplantat</a>
source	<pre> &lt;complexType name="ZubehoerBrustimplantatBasis"&gt;   &lt;sequence&gt;     &lt;choice&gt;       &lt;element name="ZBI_HerstellerSchluessel" type="enum_0131"/&gt;     </pre>

```

<element name="ZBI_HerstellerUnbekannt" type="JaLeer"/>
</choice>
<element name="ZBI_HerstellerSonstiger" type="Freitext250" minOccurs="0"/>
<element name="ZBI_ZubehoerTypSchluessel" type="enum_0191"/>
</sequence>
</complexType>

```

element **ZubehoerBrustimplantatBasis/ZBI\_HerstellerSchluessel**

diagram			
type	<a href="#">enum 0131</a>		
properties	content simple		
facets	Kind	Value	Annotation
	enumeration	0131001	documentation Allergan
	enumeration	0131002	documentation Establishment labs
	enumeration	0131003	documentation Eurosilicone
	enumeration	0131004	documentation Galatea
	enumeration	0131005	documentation Integra
	enumeration	0131006	documentation Lifecell
	enumeration	0131007	documentation MBP (Medical Biomaterial Products)
	enumeration	0131008	documentation Mentor
	enumeration	0131009	documentation Novus Scientific
	enumeration	0131010	documentation pfmMedical
	enumeration	0131011	documentation nicht belegter Wert
	enumeration	0131012	documentation nicht belegter Wert
	enumeration	0131013	documentation nicht belegter Wert
	enumeration	0131014	documentation nicht belegter Wert
	enumeration	0131015	documentation nicht belegter Wert
	enumeration	0131042	documentation sonstiger
source	<code>&lt;element name="ZBI_HerstellerSchluessel" type="enum_0131"/&gt;</code>		

element **ZubehoerBrustimplantatBasis/ZBI\_HerstellerUnbekannt**

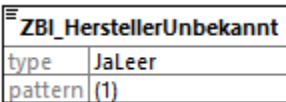
diagram			
type	<a href="#">JaLeer</a>		

properties	content simple
facets	Kind Value Annotation pattern (1)
source	<element name="ZBI_HerstellerUnbekannt" type="JaLeer"/>

element **ZubehoerBrustimplantatBasis/ZBI\_HerstellerSonstiger**

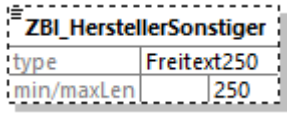
diagram	
type	<a href="#">Freitext250</a>
properties	minOcc 0 maxOcc 1 content simple
facets	Kind Value Annotation maxLength 250
source	<element name="ZBI_HerstellerSonstiger" type="Freitext250" minOccurs="0"/>

element **ZubehoerBrustimplantatBasis/ZBI\_ZubehoerTypSchluessel**

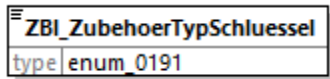
diagram	
type	<a href="#">enum 0191</a>
properties	content simple
facets	Kind Value Annotation enumeration 0191001 documentation Netz enumeration 0191002 documentation ADM
source	<element name="ZBI_ZubehoerTypSchluessel" type="enum_0191"/>

complexType **ZubehoerEndoprotheseBasis**

diagram	
namespace	http://xml.ir-d.de/emg
children	<a href="#">ZEP_HerstellerSchluessel</a> <a href="#">ZEP_HerstellerUnbekannt</a> <a href="#">ZEP_HerstellerSonstiger</a> <a href="#">ZEP_ZubehoerTypSchluessel</a> <a href="#">ZEP_Menge</a> <a href="#">ZEP_EinheitSchluessel</a>
used by	element <a href="#">Zubehoer/zubehoerEndoprothese</a>
source	<pre> &lt;complexType name="ZubehoerEndoprotheseBasis"&gt;   &lt;sequence&gt;     &lt;choice&gt;       &lt;element name="ZEP_HerstellerSchluessel" type="enum_0230"/&gt;       &lt;element name="ZEP_HerstellerUnbekannt" type="JaLeer"/&gt;     &lt;/choice&gt;     &lt;element name="ZEP_HerstellerSonstiger" type="Freitext250" minOccurs="0"/&gt;     &lt;element name="ZEP_ZubehoerTypSchluessel" type="enum_0291"/&gt;     &lt;element name="ZEP_Menge" type="Zahl5"/&gt;     &lt;element name="ZEP_EinheitSchluessel" type="enum_0062"/&gt;   &lt;/sequence&gt; &lt;/complexType&gt; </pre>

element **ZubehoerEndoprotheseBasis/ZEP\_HerstellerSchluessel**

diagram																
type	<a href="#">enum 0230</a>															
properties	content simple															
facets	<table border="1"> <thead> <tr> <th>Kind</th> <th>Value</th> <th>Annotation</th> </tr> </thead> <tbody> <tr> <td>enumeration</td> <td>0230001</td> <td>documentation Smith &amp; Nephew GmbH</td> </tr> <tr> <td>enumeration</td> <td>0230002</td> <td>documentation Mathys Orthopädie GmbH</td> </tr> <tr> <td>enumeration</td> <td>0230003</td> <td>documentation Ceramtec AG</td> </tr> <tr> <td>enumeration</td> <td>0230004</td> <td>documentation</td> </tr> </tbody> </table>	Kind	Value	Annotation	enumeration	0230001	documentation Smith & Nephew GmbH	enumeration	0230002	documentation Mathys Orthopädie GmbH	enumeration	0230003	documentation Ceramtec AG	enumeration	0230004	documentation
Kind	Value	Annotation														
enumeration	0230001	documentation Smith & Nephew GmbH														
enumeration	0230002	documentation Mathys Orthopädie GmbH														
enumeration	0230003	documentation Ceramtec AG														
enumeration	0230004	documentation														

	enumeration	0230005	Biomet documentation Peter Brehm GmbH
	enumeration	0230006	documentation Amplitude GmbH
	enumeration	0230007	documentation Exactech Deutschland
	enumeration	0230008	documentation Globus Medical
	enumeration	0230009	documentation Implantcast GmbH
	enumeration	0230010	documentation DePuy Orthopädie GmbH (J&J)
	enumeration	0230011	documentation IO-International Orthopaedics
	enumeration	0230012	documentation Joint Replacement Ltd. Instrumentation
	enumeration	0230013	documentation Merete
	enumeration	0230014	documentation S&G Implants GmbH
	enumeration	0230015	documentation Speetec Implantate GmbH
	enumeration	0230016	documentation Stemcup Medical Products GmbH
	enumeration	0230017	documentation Symbios Deutschland GmbH
	enumeration	0230018	documentation Tantum AG
	enumeration	0230019	documentation Tomier GmbH
	enumeration	0230020	documentation MicroPort Orthopedics GmbH
	enumeration	0230021	documentation aap Implanate AG
	enumeration	0230022	documentation AQImplants
	enumeration	0230023	documentation ESKA Orthodynamics GmbH
	enumeration	0230024	documentation Ateos medical AG
	enumeration	0230025	documentation Chiropro GmbH
	enumeration	0230026	documentation Medacta
	enumeration	0230027	documentation OHST Medizintechnik AG
	enumeration	0230028	documentation Lima Deutschland GmbH
	enumeration	0230029	documentation alloPlus GmbH
	enumeration	0230030	documentation Heraeus Medical GmbH
	enumeration	0230031	documentation ImplanTec Deutschland GmbH
	enumeration	0230032	documentation Falcon Medical GmbH
	enumeration	0230033	documentation Meril GmbH
	enumeration	0230034	documentation Zimmer Germany GmbH
	enumeration	0230035	documentation Stryker GmbH & Co. KG
	enumeration	0230036	documentation Aesculap AG

	enumeration	0230037	documentation Waldemar Link GmbH & Co. KG
	enumeration	0230038	documentation Corin Germany GmbH
	enumeration	0230039	documentation ARTIQO
	enumeration	0230040	documentation EuromedImplants
	enumeration	0230041	documentation EvolutisGroup
	enumeration	0230042	documentation sonstige
	enumeration	0230043	documentation TEKNIMED SAS
	enumeration	0230044	documentation HiPer Medical AG
	enumeration	0230045	documentation Link Italia S.p.A.
	enumeration	0230046	documentation Johnson & Johnson Medical GmbH
	enumeration	0230047	documentation MatOrtho Limited
	enumeration	0230048	documentation Adler Ortho S.P.A.
	enumeration	0230049	documentation Lincotek Bologna SRL
	enumeration	0230050	documentation Materialise
	enumeration	0230051	documentation Maxx Orthopedics Inc.
	enumeration	0230052	documentation JRI Orthopaedics
	enumeration	0230053	documentation nicht belegter Wert
	enumeration	0230054	documentation nicht belegter Wert
	enumeration	0230055	documentation nicht belegter Wert
	enumeration	0230056	documentation nicht belegter Wert
	enumeration	0230057	documentation nicht belegter Wert
	enumeration	0230058	documentation nicht belegter Wert
	enumeration	0230059	documentation nicht belegter Wert
source	<code>&lt;element name="ZEP_HerstellerSchluesse1" type="enum_0230"/&gt;</code>		

element **ZubehoerEndoprotheseBasis/ZEP\_HerstellerUnbekannt**

diagram	 <pre> graph TD     ZEP_HerstellerUnbekannt[ZEP_HerstellerUnbekannt]     ZEP_HerstellerUnbekannt -- type --&gt; JaLeer[JaLeer]     ZEP_HerstellerUnbekannt -- pattern --&gt; P1["(1)"]   </pre>						
type	<a href="#">JaLeer</a>						
properties	content simple						
facets	<table border="1"> <tr> <td>Kind</td> <td>Value</td> <td>Annotation</td> </tr> <tr> <td>pattern</td> <td>(1)</td> <td></td> </tr> </table>	Kind	Value	Annotation	pattern	(1)	
Kind	Value	Annotation					
pattern	(1)						
source	<code>&lt;element name="ZEP_HerstellerUnbekannt" type="JaLeer"/&gt;</code>						



element **ZubehoerEndprotheseBasis/ZEP\_HerstellerSonstiger**

diagram	
type	<a href="#">Freitext250</a>
properties	minOcc 0 maxOcc 1 content simple
facets	Kind Value Annotation maxLength 250
source	<code>&lt;element name="ZEP_HerstellerSonstiger" type="Freitext250" minOccurs="0"/&gt;</code>

element **ZubehoerEndprotheseBasis/ZEP\_ZubehoerTypSchluessel**

diagram	
type	<a href="#">enum 0291</a>
properties	content simple
facets	Kind Value Annotation enumeration 0291001 documentation Knochen-Zement enumeration 0291002 documentation sonstiges Zubehör
source	<code>&lt;element name="ZEP_ZubehoerTypSchluessel" type="enum_0291"/&gt;</code>

element **ZubehoerEndprotheseBasis/ZEP\_Menge**

diagram	
type	<a href="#">Zahl5</a>
properties	content simple
facets	Kind Value Annotation minInclusive 1 maxInclusive 99999
source	<code>&lt;element name="ZEP_Menge" type="Zahl5"/&gt;</code>

element **ZubehoerEndprotheseBasis/ZEP\_EinheitSchluessel**

diagram	
type	<a href="#">enum 0062</a>

properties	content simple		
facets	Kind	Value	Annotation
	enumeration	0062001	documentation Stück
	enumeration	0062002	documentation g
	enumeration	0062003	documentation mg
	enumeration	0062004	documentation l
	enumeration	0062005	documentation ml
	enumeration	0062006	documentation cm <sup>3</sup>
	enumeration	0062007	documentation mm
	enumeration	0062008	documentation cm
	enumeration	0062009	documentation dm
	enumeration	0062010	documentation m
	enumeration	0062042	documentation andere
source	<code>&lt;element name="ZEP_EinheitSchluesel" type="enum_0062"/&gt;</code>		

# complexType PatientenaufnahmeAortenklappeBasis

diagram

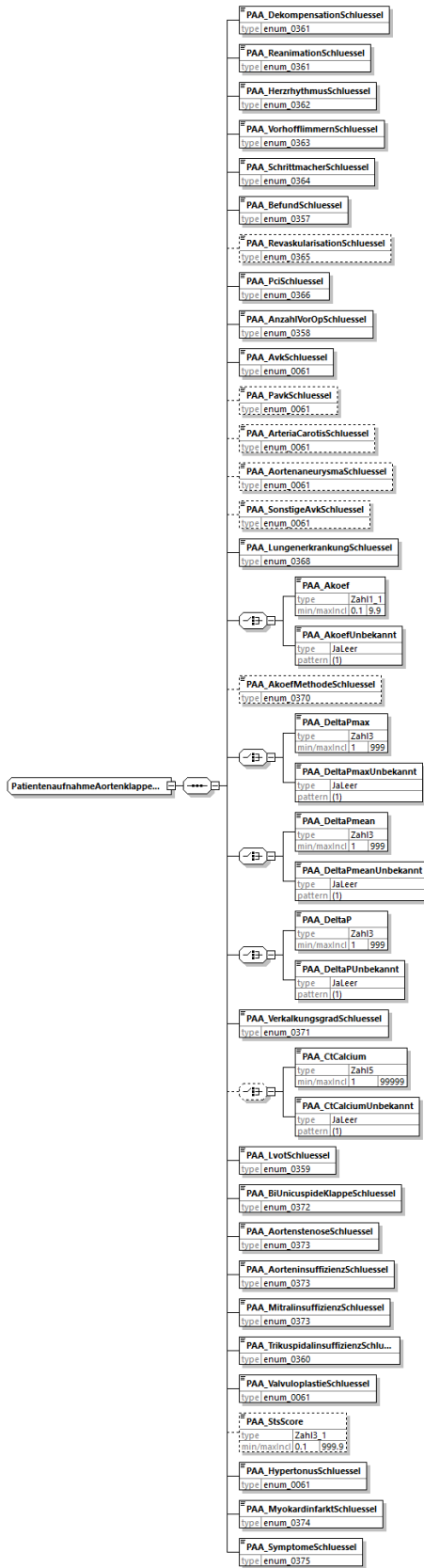

namespace http://xml.ir-d.de/emg

children [PAA DekompensationSchlüssel](#) [PAA ReanimationSchlüssel](#) [PAA HerzrhythmusSchlüssel](#) [PAA VorhofflimmernSchlüssel](#) [PAA SchrittmacherSchlüssel](#) [PAA BefundSchlüssel](#)

	<a href="#">PAA RevaskularisationSchluessel</a> <a href="#">PAA PciSchluessel</a> <a href="#">PAA AnzahlVorOpSchluessel</a> <a href="#">PAA AvkSchluessel</a> <a href="#">PAA PavkSchluessel</a> <a href="#">PAA ArteriaCarotisSchluessel</a> <a href="#">PAA AortenaneurysmaSchluessel</a> <a href="#">PAA SonstigeAvkSchluessel</a> <a href="#">PAA LungenerkrankungSchluessel</a> <a href="#">PAA Akoef</a> <a href="#">PAA AkoefUnbekannt</a> <a href="#">PAA AkoefMethodeSchluessel</a> <a href="#">PAA DeltaPmax</a> <a href="#">PAA DeltaPmaxUnbekannt</a> <a href="#">PAA DeltaPmean</a> <a href="#">PAA DeltaPmeanUnbekannt</a> <a href="#">PAA DeltaP</a> <a href="#">PAA DeltaPUnbekannt</a> <a href="#">PAA VerkalkungsgradSchluessel</a> <a href="#">PAA CtCalcium</a> <a href="#">PAA CtCalciumUnbekannt</a> <a href="#">PAA LvotSchluessel</a> <a href="#">PAA BiUnicuspideKlappeSchluessel</a> <a href="#">PAA AortenstenoseSchluessel</a> <a href="#">PAA AorteninsuffizienzSchluessel</a> <a href="#">PAA MitralinsuffizienzSchluessel</a> <a href="#">PAA TrikuspidalinsuffizienzSchluessel</a> <a href="#">PAA ValvuloplastieSchluessel</a> <a href="#">PAA StsScore</a> <a href="#">PAA HypertonusSchluessel</a> <a href="#">PAA MyokardinfarktSchluessel</a> <a href="#">PAA SymptomeSchluessel</a>
used by	complexType <a href="#">PatientenaufnahmeAortenklappe</a>
source	<pre> &lt;complexType name="PatientenaufnahmeAortenklappeBasis"&gt;   &lt;sequence&gt;     &lt;element name="PAA_DekompensationSchluessel" type="enum_0361"/&gt;     &lt;element name="PAA_ReanimationSchluessel" type="enum_0361"/&gt;     &lt;element name="PAA_HerzrhythmusSchluessel" type="enum_0362"/&gt;     &lt;element name="PAA_VorhofflimmernSchluessel" type="enum_0363"/&gt;     &lt;element name="PAA_SchrittmacherSchluessel" type="enum_0364"/&gt;     &lt;element name="PAA_BefundSchluessel" type="enum_0357"/&gt;     &lt;element name="PAA_RevaskularisationSchluessel" type="enum_0365" minOccurs="0"/&gt;     &lt;element name="PAA_PciSchluessel" type="enum_0366"/&gt;     &lt;element name="PAA_AnzahlVorOpSchluessel" type="enum_0358"/&gt;     &lt;element name="PAA_AvkSchluessel" type="enum_0061"/&gt;     &lt;element name="PAA_PavkSchluessel" type="enum_0061" minOccurs="0"/&gt;     &lt;element name="PAA_ArteriaCarotisSchluessel" type="enum_0061" minOccurs="0"/&gt;     &lt;element name="PAA_AortenaneurysmaSchluessel" type="enum_0061" minOccurs="0"/&gt;     &lt;element name="PAA_SonstigeAvkSchluessel" type="enum_0061" minOccurs="0"/&gt;     &lt;element name="PAA_LungenerkrankungSchluessel" type="enum_0368"/&gt;     &lt;choice&gt;       &lt;element name="PAA_Akoef" type="Zahl1_1"/&gt;       &lt;element name="PAA_AkoefUnbekannt" type="JaLeer"/&gt;     &lt;/choice&gt;     &lt;element name="PAA_AkoefMethodeSchluessel" type="enum_0370" minOccurs="0"/&gt;     &lt;choice&gt;       &lt;element name="PAA_DeltaPmax" type="Zahl3"/&gt;       &lt;element name="PAA_DeltaPmaxUnbekannt" type="JaLeer"/&gt;     &lt;/choice&gt;     &lt;choice&gt;       &lt;element name="PAA_DeltaPmean" type="Zahl3"/&gt;       &lt;element name="PAA_DeltaPmeanUnbekannt" type="JaLeer"/&gt;     &lt;/choice&gt;     &lt;choice&gt;       &lt;element name="PAA_DeltaP" type="Zahl3"/&gt;       &lt;element name="PAA_DeltaPUnbekannt" type="JaLeer"/&gt;     &lt;/choice&gt;     &lt;element name="PAA_VerkalkungsgradSchluessel" type="enum_0371"/&gt;     &lt;choice minOccurs="0"&gt;       &lt;element name="PAA_CtCalcium" type="Zahl15"/&gt;       &lt;element name="PAA_CtCalciumUnbekannt" type="JaLeer"/&gt;     &lt;/choice&gt;     &lt;element name="PAA_LvotSchluessel" type="enum_0359"/&gt;     &lt;element name="PAA_BiUnicuspideKlappeSchluessel" type="enum_0372"/&gt;     &lt;element name="PAA_AortenstenoseSchluessel" type="enum_0373"/&gt;     &lt;element name="PAA_AorteninsuffizienzSchluessel" type="enum_0373"/&gt;     &lt;element name="PAA_MitralinsuffizienzSchluessel" type="enum_0373"/&gt;     &lt;element name="PAA_TrikuspidalinsuffizienzSchluessel" type="enum_0360"/&gt; </pre>

	<pre> &lt;element name="PAA_ValvuloplastieSchluessel" type="enum_0061"/&gt; &lt;element name="PAA_StsScore" type="Zahl3_1" minOccurs="0"/&gt; &lt;element name="PAA_HypertonusSchluessel" type="enum_0061"/&gt; &lt;element name="PAA_MyokardinfarktSchluessel" type="enum_0374"/&gt; &lt;element name="PAA_SymptomeSchluessel" type="enum_0375"/&gt; &lt;/sequence&gt; &lt;/complexType&gt; </pre>
--	---

element **PatientenaufnahmeAortenklappeBasis/PAA\_DekompensationSchluessel**

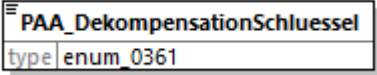
diagram			
type	<a href="#">enum 0361</a>		
properties	content simple		
facets	Kind	Value	Annotation
	enumeration	0361001	documentation nein
	enumeration	0361002	documentation ja, letzte(r) innerhalb der letzten 48 Stunden
	enumeration	0361003	documentation ja, letzte(r) innerhalb der letzten 21 Tage
	enumeration	0361004	documentation ja, letzte(r) länger als 21 Tage
	enumeration	0361098	documentation ja, letzter Zeitpunkt unbekannt
	enumeration	0361099	documentation unbekannt
source	<code>&lt;element name="PAA_DekompensationSchluessel" type="enum_0361"/&gt;</code>		

element **PatientenaufnahmeAortenklappeBasis/PAA\_ReanimationSchluessel**

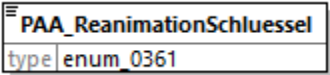
diagram			
type	<a href="#">enum 0361</a>		
properties	content simple		
facets	Kind	Value	Annotation
	enumeration	0361001	documentation nein
	enumeration	0361002	documentation ja, letzte(r) innerhalb der letzten 48 Stunden
	enumeration	0361003	documentation ja, letzte(r) innerhalb der letzten 21 Tage
	enumeration	0361004	documentation ja, letzte(r) länger als 21 Tage
	enumeration	0361098	documentation ja, letzter Zeitpunkt unbekannt
	enumeration	0361099	documentation unbekannt
source	<code>&lt;element name="PAA_ReanimationSchluessel" type="enum_0361"/&gt;</code>		

element **PatientenaufnahmeAortenklappeBasis/PAA\_HerzrhythmusSchluessel**

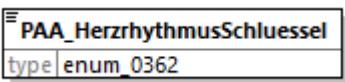
diagram			
type	<a href="#">enum 0362</a>		
properties	content simple		
facets	Kind	Value	Annotation
	enumeration	0362001	documentation Sinusrhythmus
	enumeration	0362002	documentation Vorhofflimmern
	enumeration	0362042	documentation anderer Herzrhythmus
source	<code>&lt;element name="PAA_HerzrhythmusSchluessel" type="enum_0362"/&gt;</code>		

element **PatientenaufnahmeAortenklappeBasis/PAA\_VorhofflimmernSchluessel**

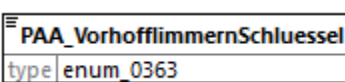
diagram			
type	<a href="#">enum 0363</a>		
properties	content simple		
facets	Kind	Value	Annotation
	enumeration	0363001	documentation nein
	enumeration	0363002	documentation paroxysmal
	enumeration	0363003	documentation persistierend
	enumeration	0363004	documentation permanent
source	<code>&lt;element name="PAA_VorhofflimmernSchluessel" type="enum_0363"/&gt;</code>		

element **PatientenaufnahmeAortenklappeBasis/PAA\_SchrittmacherSchluessel**

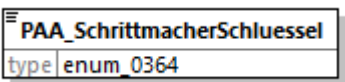
diagram			
type	<a href="#">enum 0364</a>		
properties	content simple		
facets	Kind	Value	Annotation
	enumeration	0364001	documentation nein
	enumeration	0364002	documentation Schrittmacher ohne CRT-System
	enumeration	0364003	documentation Schrittmacher mit CRT-System
	enumeration	0364004	documentation Defibrillator ohne CRT-System
	enumeration	0364005	documentation Defibrillator mit CRT-System
source	<code>&lt;element name="PAA_SchrittmacherSchluessel" type="enum_0364"/&gt;</code>		

element **PatientenaufnahmeAortenklappeBasis/PAA\_BefundSchluessel**

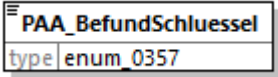
diagram																			
type	<a href="#">enum 0357</a>																		
properties	content simple																		
facets	<table border="1"> <thead> <tr> <th>Kind</th> <th>Value</th> <th>Annotation</th> </tr> </thead> <tbody> <tr> <td>enumeration</td> <td>0357001</td> <td>documentation keine KHK</td> </tr> <tr> <td>enumeration</td> <td>0357002</td> <td>documentation 1-Gefäßerkrankung</td> </tr> <tr> <td>enumeration</td> <td>0357003</td> <td>documentation 2-Gefäßerkrankung</td> </tr> <tr> <td>enumeration</td> <td>0357004</td> <td>documentation 3-Gefäßerkrankung</td> </tr> <tr> <td>enumeration</td> <td>0357005</td> <td>documentation keine koronare Bildgebung</td> </tr> </tbody> </table>	Kind	Value	Annotation	enumeration	0357001	documentation keine KHK	enumeration	0357002	documentation 1-Gefäßerkrankung	enumeration	0357003	documentation 2-Gefäßerkrankung	enumeration	0357004	documentation 3-Gefäßerkrankung	enumeration	0357005	documentation keine koronare Bildgebung
Kind	Value	Annotation																	
enumeration	0357001	documentation keine KHK																	
enumeration	0357002	documentation 1-Gefäßerkrankung																	
enumeration	0357003	documentation 2-Gefäßerkrankung																	
enumeration	0357004	documentation 3-Gefäßerkrankung																	
enumeration	0357005	documentation keine koronare Bildgebung																	
source	<code>&lt;element name="PAA_BefundSchluessel" type="enum_0357"/&gt;</code>																		

element **PatientenaufnahmeAortenklappeBasis/PAA\_RevaskularisationSchluessel**

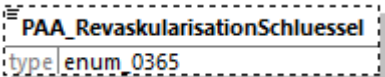
diagram													
type	<a href="#">enum 0365</a>												
properties	minOcc 0 maxOcc 1 content simple												
facets	<table border="1"> <thead> <tr> <th>Kind</th> <th>Value</th> <th>Annotation</th> </tr> </thead> <tbody> <tr> <td>enumeration</td> <td>0365001</td> <td>documentation nein</td> </tr> <tr> <td>enumeration</td> <td>0365002</td> <td>documentation ja, operativ</td> </tr> <tr> <td>enumeration</td> <td>0365003</td> <td>documentation ja, interventionell</td> </tr> </tbody> </table>	Kind	Value	Annotation	enumeration	0365001	documentation nein	enumeration	0365002	documentation ja, operativ	enumeration	0365003	documentation ja, interventionell
Kind	Value	Annotation											
enumeration	0365001	documentation nein											
enumeration	0365002	documentation ja, operativ											
enumeration	0365003	documentation ja, interventionell											
source	<code>&lt;element name="PAA_RevaskularisationSchluessel" type="enum_0365" minOccurs="0"/&gt;</code>												

element **PatientenaufnahmeAortenklappeBasis/PAA\_PciSchluessel**

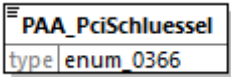
diagram													
type	<a href="#">enum 0366</a>												
properties	content simple												
facets	<table border="1"> <thead> <tr> <th>Kind</th> <th>Value</th> <th>Annotation</th> </tr> </thead> <tbody> <tr> <td>enumeration</td> <td>0366001</td> <td>documentation nein</td> </tr> <tr> <td>enumeration</td> <td>0366002</td> <td>documentation ja, &amp;lt;= 6 Stunden</td> </tr> <tr> <td>enumeration</td> <td>0366003</td> <td>documentation</td> </tr> </tbody> </table>	Kind	Value	Annotation	enumeration	0366001	documentation nein	enumeration	0366002	documentation ja, &lt;= 6 Stunden	enumeration	0366003	documentation
Kind	Value	Annotation											
enumeration	0366001	documentation nein											
enumeration	0366002	documentation ja, &lt;= 6 Stunden											
enumeration	0366003	documentation											

	enumeration 0366004	ja, &gt; 6 Stunden bis &lt;= 3 Monate documentation
	enumeration 0366099	ja, &gt; 3 Monate documentation unbekannt
source	<code>&lt;element name="PAA_PciSchluessel" type="enum_0366"/&gt;</code>	

element **PatientenaufnahmeAortenklappeBasis/PAA\_AnzahlVorOpSchluessel**

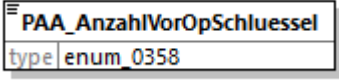
diagram			
type	<a href="#">enum 0358</a>		
properties	content simple		
facets	Kind	Value	Annotation
	enumeration	0358001	documentation 0
	enumeration	0358002	documentation 1
	enumeration	0358003	documentation 2
	enumeration	0358004	documentation 3
	enumeration	0358005	documentation 4
	enumeration	0358006	documentation 5 oder mehr
	enumeration	0358098	documentation genaue Anzahl unbekannt (aber mind. 1)
	enumeration	0358099	documentation unbekannt
source	<code>&lt;element name="PAA_AnzahlVorOpSchluessel" type="enum_0358"/&gt;</code>		

element **PatientenaufnahmeAortenklappeBasis/PAA\_AvkSchluessel**

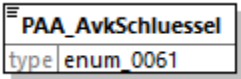
diagram			
type	<a href="#">enum 0061</a>		
properties	content simple		
facets	Kind	Value	Annotation
	enumeration	0061001	documentation ja
	enumeration	0061002	documentation nein
	enumeration	0061099	documentation unbekannt
source	<code>&lt;element name="PAA_AvkSchluessel" type="enum_0061"/&gt;</code>		



element **PatientenaufnahmeAortenklappeBasis/PAA\_PavkSchluessel**

diagram													
type	<a href="#">enum 0061</a>												
properties	minOcc 0 maxOcc 1 content simple												
facets	<table border="1"> <thead> <tr> <th>Kind</th> <th>Value</th> <th>Annotation</th> </tr> </thead> <tbody> <tr> <td>enumeration</td> <td>0061001</td> <td>documentation ja</td> </tr> <tr> <td>enumeration</td> <td>0061002</td> <td>documentation nein</td> </tr> <tr> <td>enumeration</td> <td>0061099</td> <td>documentation unbekannt</td> </tr> </tbody> </table>	Kind	Value	Annotation	enumeration	0061001	documentation ja	enumeration	0061002	documentation nein	enumeration	0061099	documentation unbekannt
Kind	Value	Annotation											
enumeration	0061001	documentation ja											
enumeration	0061002	documentation nein											
enumeration	0061099	documentation unbekannt											
source	<code>&lt;element name="PAA_PavkSchluessel" type="enum_0061" minOccurs="0"/&gt;</code>												

element **PatientenaufnahmeAortenklappeBasis/PAA\_ArteriaCarotisSchluessel**

diagram													
type	<a href="#">enum 0061</a>												
properties	minOcc 0 maxOcc 1 content simple												
facets	<table border="1"> <thead> <tr> <th>Kind</th> <th>Value</th> <th>Annotation</th> </tr> </thead> <tbody> <tr> <td>enumeration</td> <td>0061001</td> <td>documentation ja</td> </tr> <tr> <td>enumeration</td> <td>0061002</td> <td>documentation nein</td> </tr> <tr> <td>enumeration</td> <td>0061099</td> <td>documentation unbekannt</td> </tr> </tbody> </table>	Kind	Value	Annotation	enumeration	0061001	documentation ja	enumeration	0061002	documentation nein	enumeration	0061099	documentation unbekannt
Kind	Value	Annotation											
enumeration	0061001	documentation ja											
enumeration	0061002	documentation nein											
enumeration	0061099	documentation unbekannt											
source	<code>&lt;element name="PAA_ArteriaCarotisSchluessel" type="enum_0061" minOccurs="0"/&gt;</code>												

element **PatientenaufnahmeAortenklappeBasis/PAA\_AortenaneurysmaSchluessel**

diagram													
type	<a href="#">enum 0061</a>												
properties	minOcc 0 maxOcc 1 content simple												
facets	<table border="1"> <thead> <tr> <th>Kind</th> <th>Value</th> <th>Annotation</th> </tr> </thead> <tbody> <tr> <td>enumeration</td> <td>0061001</td> <td>documentation ja</td> </tr> <tr> <td>enumeration</td> <td>0061002</td> <td>documentation nein</td> </tr> <tr> <td>enumeration</td> <td>0061099</td> <td>documentation unbekannt</td> </tr> </tbody> </table>	Kind	Value	Annotation	enumeration	0061001	documentation ja	enumeration	0061002	documentation nein	enumeration	0061099	documentation unbekannt
Kind	Value	Annotation											
enumeration	0061001	documentation ja											
enumeration	0061002	documentation nein											
enumeration	0061099	documentation unbekannt											
source	<code>&lt;element name="PAA_AortenaneurysmaSchluessel" type="enum_0061" minOccurs="0"/&gt;</code>												

element **PatientenaufnahmeAortenklappeBasis/PAA\_SonstigeAvkSchluessel**

diagram													
type	<a href="#">enum_0061</a>												
properties	minOcc 0 maxOcc 1 content simple												
facets	<table border="1"> <thead> <tr> <th>Kind</th> <th>Value</th> <th>Annotation</th> </tr> </thead> <tbody> <tr> <td>enumeration</td> <td>0061001</td> <td>documentation ja</td> </tr> <tr> <td>enumeration</td> <td>0061002</td> <td>documentation nein</td> </tr> <tr> <td>enumeration</td> <td>0061099</td> <td>documentation unbekannt</td> </tr> </tbody> </table>	Kind	Value	Annotation	enumeration	0061001	documentation ja	enumeration	0061002	documentation nein	enumeration	0061099	documentation unbekannt
Kind	Value	Annotation											
enumeration	0061001	documentation ja											
enumeration	0061002	documentation nein											
enumeration	0061099	documentation unbekannt											
source	<code>&lt;element name="PAA_SonstigeAvkSchluessel" type="enum_0061" minOccurs="0"/&gt;</code>												

element **PatientenaufnahmeAortenklappeBasis/PAA\_LungenerkrankungSchluessel**

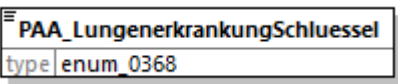
diagram																			
type	<a href="#">enum_0368</a>																		
properties	content simple																		
facets	<table border="1"> <thead> <tr> <th>Kind</th> <th>Value</th> <th>Annotation</th> </tr> </thead> <tbody> <tr> <td>enumeration</td> <td>0368001</td> <td>documentation nein</td> </tr> <tr> <td>enumeration</td> <td>0368002</td> <td>documentation ja, COPD mit Dauermedikation</td> </tr> <tr> <td>enumeration</td> <td>0368003</td> <td>documentation ja, COPD ohne Dauermedikation</td> </tr> <tr> <td>enumeration</td> <td>0368004</td> <td>documentation ja, andere Lungenerkrankungen</td> </tr> <tr> <td>enumeration</td> <td>0368099</td> <td>documentation unbekannt</td> </tr> </tbody> </table>	Kind	Value	Annotation	enumeration	0368001	documentation nein	enumeration	0368002	documentation ja, COPD mit Dauermedikation	enumeration	0368003	documentation ja, COPD ohne Dauermedikation	enumeration	0368004	documentation ja, andere Lungenerkrankungen	enumeration	0368099	documentation unbekannt
Kind	Value	Annotation																	
enumeration	0368001	documentation nein																	
enumeration	0368002	documentation ja, COPD mit Dauermedikation																	
enumeration	0368003	documentation ja, COPD ohne Dauermedikation																	
enumeration	0368004	documentation ja, andere Lungenerkrankungen																	
enumeration	0368099	documentation unbekannt																	
source	<code>&lt;element name="PAA_LungenerkrankungSchluessel" type="enum_0368"/&gt;</code>																		

element **PatientenaufnahmeAortenklappeBasis/PAA\_Akoef**

diagram																
type	<a href="#">Zahl1_1</a>															
properties	content simple															
facets	<table border="1"> <thead> <tr> <th>Kind</th> <th>Value</th> <th>Annotation</th> </tr> </thead> <tbody> <tr> <td>minInclusive</td> <td>0.1</td> <td></td> </tr> <tr> <td>maxInclusive</td> <td>9.9</td> <td></td> </tr> <tr> <td>totalDigits</td> <td>2</td> <td></td> </tr> <tr> <td>fractionDigits</td> <td>1</td> <td></td> </tr> </tbody> </table>	Kind	Value	Annotation	minInclusive	0.1		maxInclusive	9.9		totalDigits	2		fractionDigits	1	
Kind	Value	Annotation														
minInclusive	0.1															
maxInclusive	9.9															
totalDigits	2															
fractionDigits	1															
source	<code>&lt;element name="PAA_Akoef" type="Zahl1_1"/&gt;</code>															

element **PatientenaufnahmeAortenklappeBasis/PAA\_AkoefUnbekannt**

diagram							
type	<a href="#">JaLeer</a>						
properties	content simple						
facets	<table border="1"> <thead> <tr> <th>Kind</th> <th>Value</th> <th>Annotation</th> </tr> </thead> <tbody> <tr> <td>pattern</td> <td>(1)</td> <td></td> </tr> </tbody> </table>	Kind	Value	Annotation	pattern	(1)	
Kind	Value	Annotation					
pattern	(1)						
source	<code>&lt;element name="PAA_AkoefUnbekannt" type="JaLeer"/&gt;</code>						

element **PatientenaufnahmeAortenklappeBasis/PAA\_AkoefMethodeSchluessel**

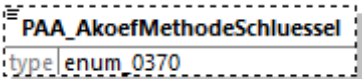
diagram													
type	<a href="#">enum_0370</a>												
properties	<table border="1"> <tbody> <tr> <td>minOcc</td> <td>0</td> </tr> <tr> <td>maxOcc</td> <td>1</td> </tr> <tr> <td>content</td> <td>simple</td> </tr> </tbody> </table>	minOcc	0	maxOcc	1	content	simple						
minOcc	0												
maxOcc	1												
content	simple												
facets	<table border="1"> <thead> <tr> <th>Kind</th> <th>Value</th> <th>Annotation</th> </tr> </thead> <tbody> <tr> <td>enumeration</td> <td>0370001</td> <td>documentation Echokardiographie</td> </tr> <tr> <td>enumeration</td> <td>0370002</td> <td>documentation Herzkatheter</td> </tr> <tr> <td>enumeration</td> <td>0370042</td> <td>documentation andere</td> </tr> </tbody> </table>	Kind	Value	Annotation	enumeration	0370001	documentation Echokardiographie	enumeration	0370002	documentation Herzkatheter	enumeration	0370042	documentation andere
Kind	Value	Annotation											
enumeration	0370001	documentation Echokardiographie											
enumeration	0370002	documentation Herzkatheter											
enumeration	0370042	documentation andere											
source	<code>&lt;element name="PAA_AkoefMethodeSchluessel" type="enum_0370" minOccurs="0"/&gt;</code>												

element **PatientenaufnahmeAortenklappeBasis/PAA\_DeltaPmax**

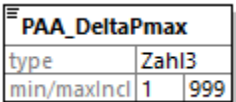
diagram										
type	<a href="#">Zahl3</a>									
properties	content simple									
facets	<table border="1"> <thead> <tr> <th>Kind</th> <th>Value</th> <th>Annotation</th> </tr> </thead> <tbody> <tr> <td>minInclusive</td> <td>1</td> <td></td> </tr> <tr> <td>maxInclusive</td> <td>999</td> <td></td> </tr> </tbody> </table>	Kind	Value	Annotation	minInclusive	1		maxInclusive	999	
Kind	Value	Annotation								
minInclusive	1									
maxInclusive	999									
source	<code>&lt;element name="PAA_DeltaPmax" type="Zahl3"/&gt;</code>									

element **PatientenaufnahmeAortenklappeBasis/PAA\_DeltaPmaxUnbekannt**

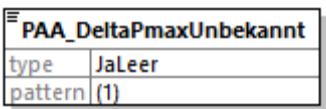
diagram							
type	<a href="#">JaLeer</a>						
properties	content simple						
facets	<table border="1"> <thead> <tr> <th>Kind</th> <th>Value</th> <th>Annotation</th> </tr> </thead> <tbody> <tr> <td>pattern</td> <td>(1)</td> <td></td> </tr> </tbody> </table>	Kind	Value	Annotation	pattern	(1)	
Kind	Value	Annotation					
pattern	(1)						
source	<code>&lt;element name="PAA_DeltaPmaxUnbekannt" type="JaLeer"/&gt;</code>						

element **PatientenaufnahmeAortenklappeBasis/PAA\_DeltaPmean**

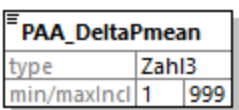
diagram										
type	<a href="#">Zahl3</a>									
properties	content simple									
facets	<table border="1"> <thead> <tr> <th>Kind</th> <th>Value</th> <th>Annotation</th> </tr> </thead> <tbody> <tr> <td>minInclusive</td> <td>1</td> <td></td> </tr> <tr> <td>maxInclusive</td> <td>999</td> <td></td> </tr> </tbody> </table>	Kind	Value	Annotation	minInclusive	1		maxInclusive	999	
Kind	Value	Annotation								
minInclusive	1									
maxInclusive	999									
source	<code>&lt;element name="PAA_DeltaPmean" type="Zahl3"/&gt;</code>									

element **PatientenaufnahmeAortenklappeBasis/PAA\_DeltaPmeanUnbekannt**

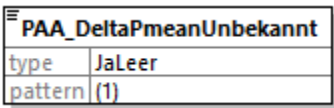
diagram							
type	<a href="#">JaLeer</a>						
properties	content simple						
facets	<table border="1"> <thead> <tr> <th>Kind</th> <th>Value</th> <th>Annotation</th> </tr> </thead> <tbody> <tr> <td>pattern</td> <td>(1)</td> <td></td> </tr> </tbody> </table>	Kind	Value	Annotation	pattern	(1)	
Kind	Value	Annotation					
pattern	(1)						
source	<code>&lt;element name="PAA_DeltaPmeanUnbekannt" type="JaLeer"/&gt;</code>						

element **PatientenaufnahmeAortenklappeBasis/PAA\_DeltaP**

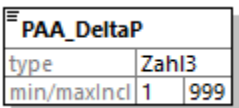
diagram										
type	<a href="#">Zahl3</a>									
properties	content simple									
facets	<table border="1"> <thead> <tr> <th>Kind</th> <th>Value</th> <th>Annotation</th> </tr> </thead> <tbody> <tr> <td>minInclusive</td> <td>1</td> <td></td> </tr> <tr> <td>maxInclusive</td> <td>999</td> <td></td> </tr> </tbody> </table>	Kind	Value	Annotation	minInclusive	1		maxInclusive	999	
Kind	Value	Annotation								
minInclusive	1									
maxInclusive	999									

source	<code>&lt;element name="PAA_DeltaP" type="Zahl3"/&gt;</code>
--------	--

element **PatientenaufnahmeAortenklappeBasis/PAA\_DeltaPUnbekannt**

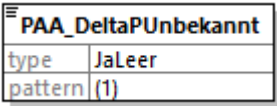
diagram							
type	<a href="#">JaLeer</a>						
properties	content simple						
facets	<table border="1"> <thead> <tr> <th>Kind</th> <th>Value</th> <th>Annotation</th> </tr> </thead> <tbody> <tr> <td>pattern</td> <td>(1)</td> <td></td> </tr> </tbody> </table>	Kind	Value	Annotation	pattern	(1)	
Kind	Value	Annotation					
pattern	(1)						
source	<code>&lt;element name="PAA_DeltaPUnbekannt" type="JaLeer"/&gt;</code>						

element **PatientenaufnahmeAortenklappeBasis/PAA\_VerkalkungsgradSchluessel**

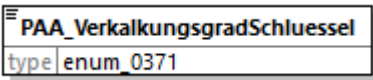
diagram																			
type	<a href="#">enum 0371</a>																		
properties	content simple																		
facets	<table border="1"> <thead> <tr> <th>Kind</th> <th>Value</th> <th>Annotation</th> </tr> </thead> <tbody> <tr> <td>enumeration</td> <td>0371001</td> <td>documentation keine</td> </tr> <tr> <td>enumeration</td> <td>0371002</td> <td>documentation leicht</td> </tr> <tr> <td>enumeration</td> <td>0371003</td> <td>documentation mittel</td> </tr> <tr> <td>enumeration</td> <td>0371004</td> <td>documentation schwer</td> </tr> <tr> <td>enumeration</td> <td>0371099</td> <td>documentation unbekannt</td> </tr> </tbody> </table>	Kind	Value	Annotation	enumeration	0371001	documentation keine	enumeration	0371002	documentation leicht	enumeration	0371003	documentation mittel	enumeration	0371004	documentation schwer	enumeration	0371099	documentation unbekannt
Kind	Value	Annotation																	
enumeration	0371001	documentation keine																	
enumeration	0371002	documentation leicht																	
enumeration	0371003	documentation mittel																	
enumeration	0371004	documentation schwer																	
enumeration	0371099	documentation unbekannt																	
source	<code>&lt;element name="PAA_VerkalkungsgradSchluessel" type="enum_0371"/&gt;</code>																		

element **PatientenaufnahmeAortenklappeBasis/PAA\_CtCalcium**

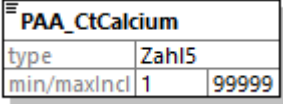
diagram										
type	<a href="#">Zahl5</a>									
properties	content simple									
facets	<table border="1"> <thead> <tr> <th>Kind</th> <th>Value</th> <th>Annotation</th> </tr> </thead> <tbody> <tr> <td>minInclusive</td> <td>1</td> <td></td> </tr> <tr> <td>maxInclusive</td> <td>99999</td> <td></td> </tr> </tbody> </table>	Kind	Value	Annotation	minInclusive	1		maxInclusive	99999	
Kind	Value	Annotation								
minInclusive	1									
maxInclusive	99999									
source	<code>&lt;element name="PAA_CtCalcium" type="Zahl5"/&gt;</code>									

element **PatientenaufnahmeAortenklappeBasis/PAA\_CtCalciumUnbekannt**

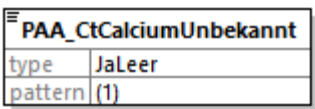
diagram							
type	<a href="#">JaLeer</a>						
properties	content simple						
facets	<table border="1"> <thead> <tr> <th>Kind</th> <th>Value</th> <th>Annotation</th> </tr> </thead> <tbody> <tr> <td>pattern</td> <td>(1)</td> <td></td> </tr> </tbody> </table>	Kind	Value	Annotation	pattern	(1)	
Kind	Value	Annotation					
pattern	(1)						
source	<code>&lt;element name="PAA_CtCalciumUnbekannt" type="JaLeer"/&gt;</code>						

element **PatientenaufnahmeAortenklappeBasis/PAA\_LvotSchluessel**

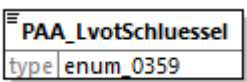
diagram																
type	<a href="#">enum_0359</a>															
properties	content simple															
facets	<table border="1"> <thead> <tr> <th>Kind</th> <th>Value</th> <th>Annotation</th> </tr> </thead> <tbody> <tr> <td>enumeration</td> <td>0359001</td> <td>documentation nein</td> </tr> <tr> <td>enumeration</td> <td>0359002</td> <td>documentation ja - einseitig</td> </tr> <tr> <td>enumeration</td> <td>0359003</td> <td>documentation ja - beidseitig</td> </tr> <tr> <td>enumeration</td> <td>0359042</td> <td>documentation unbekannt</td> </tr> </tbody> </table>	Kind	Value	Annotation	enumeration	0359001	documentation nein	enumeration	0359002	documentation ja - einseitig	enumeration	0359003	documentation ja - beidseitig	enumeration	0359042	documentation unbekannt
Kind	Value	Annotation														
enumeration	0359001	documentation nein														
enumeration	0359002	documentation ja - einseitig														
enumeration	0359003	documentation ja - beidseitig														
enumeration	0359042	documentation unbekannt														
source	<code>&lt;element name="PAA_LvotSchluessel" type="enum_0359"/&gt;</code>															

element **PatientenaufnahmeAortenklappeBasis/PAA\_BiUnicuspideKlappeSchluessel**

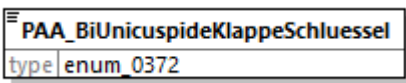
diagram																
type	<a href="#">enum_0372</a>															
properties	content simple															
facets	<table border="1"> <thead> <tr> <th>Kind</th> <th>Value</th> <th>Annotation</th> </tr> </thead> <tbody> <tr> <td>enumeration</td> <td>0372001</td> <td>documentation nein</td> </tr> <tr> <td>enumeration</td> <td>0372002</td> <td>documentation ja, bicuspide</td> </tr> <tr> <td>enumeration</td> <td>0372003</td> <td>documentation ja, unicuspide</td> </tr> <tr> <td>enumeration</td> <td>0372099</td> <td>documentation unbekannt</td> </tr> </tbody> </table>	Kind	Value	Annotation	enumeration	0372001	documentation nein	enumeration	0372002	documentation ja, bicuspide	enumeration	0372003	documentation ja, unicuspide	enumeration	0372099	documentation unbekannt
Kind	Value	Annotation														
enumeration	0372001	documentation nein														
enumeration	0372002	documentation ja, bicuspide														
enumeration	0372003	documentation ja, unicuspide														
enumeration	0372099	documentation unbekannt														
source	<code>&lt;element name="PAA_BiUnicuspideKlappeSchluessel" type="enum_0372"/&gt;</code>															

element **PatientenaufnahmeAortenklappeBasis/PAA\_AortenstenoseSchluessel**

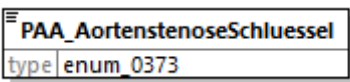
diagram			
type	<a href="#">enum 0373</a>		
properties	content simple		
facets	Kind	Value	Annotation
	enumeration	0373001	documentation keine
	enumeration	0373002	documentation leichtgradig
	enumeration	0373003	documentation mittelgradig
	enumeration	0373004	documentation hochgradig
	enumeration	0373099	documentation unbekannt
source	<code>&lt;element name="PAA_AortenstenoseSchluessel" type="enum_0373"/&gt;</code>		

element **PatientenaufnahmeAortenklappeBasis/PAA\_AorteninsuffizienzSchluessel**

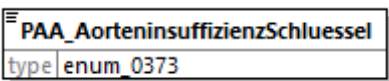
diagram			
type	<a href="#">enum 0373</a>		
properties	content simple		
facets	Kind	Value	Annotation
	enumeration	0373001	documentation keine
	enumeration	0373002	documentation leichtgradig
	enumeration	0373003	documentation mittelgradig
	enumeration	0373004	documentation hochgradig
	enumeration	0373099	documentation unbekannt
source	<code>&lt;element name="PAA_AorteninsuffizienzSchluessel" type="enum_0373"/&gt;</code>		

element **PatientenaufnahmeAortenklappeBasis/PAA\_MitralinsuffizienzSchluessel**

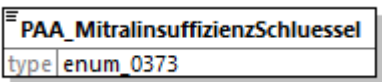
diagram			
type	<a href="#">enum 0373</a>		
properties	content simple		
facets	Kind	Value	Annotation
	enumeration	0373001	documentation keine
	enumeration	0373002	documentation leichtgradig
	enumeration	0373003	documentation mittelgradig

	enumeration 0373004 documentation hochgradig
	enumeration 0373099 documentation unbekannt
source	<code>&lt;element name="PAA_MitralinsuffizienzSchluessel" type="enum_0373"/&gt;</code>

element **PatientenaufnahmeAortenklappeBasis/PAA\_TrikuspidalinsuffizienzSchluessel**

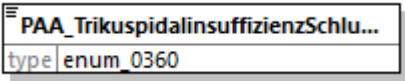
diagram			
type	<a href="#">enum 0360</a>		
properties	content simple		
facets	Kind	Value	Annotation
	enumeration	0360001	documentation keine
	enumeration	0360002	documentation leichtgradig
	enumeration	0360003	documentation mittelgradig
	enumeration	0360004	documentation hochgradig
	enumeration	0360005	documentation massive
	enumeration	0360006	documentation torrential
	enumeration	0360099	documentation unbekannt
source	<code>&lt;element name="PAA_TrikuspidalinsuffizienzSchluessel" type="enum_0360"/&gt;</code>		

element **PatientenaufnahmeAortenklappeBasis/PAA\_ValvuloplastieSchluessel**

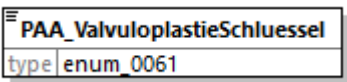
diagram			
type	<a href="#">enum 0061</a>		
properties	content simple		
facets	Kind	Value	Annotation
	enumeration	0061001	documentation ja
	enumeration	0061002	documentation nein
	enumeration	0061099	documentation unbekannt
source	<code>&lt;element name="PAA_ValvuloplastieSchluessel" type="enum_0061"/&gt;</code>		

element **PatientenaufnahmeAortenklappeBasis/PAA\_StsScore**

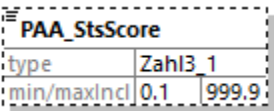
diagram			
---------	---	--	--



type	<a href="#">Zahl3_1</a>															
properties	minOcc 0 maxOcc 1 content simple															
facets	<table border="1"> <thead> <tr> <th>Kind</th> <th>Value</th> <th>Annotation</th> </tr> </thead> <tbody> <tr> <td>minInclusive</td> <td>0.1</td> <td></td> </tr> <tr> <td>maxInclusive</td> <td>999.9</td> <td></td> </tr> <tr> <td>totalDigits</td> <td>4</td> <td></td> </tr> <tr> <td>fractionDigits</td> <td>1</td> <td></td> </tr> </tbody> </table>	Kind	Value	Annotation	minInclusive	0.1		maxInclusive	999.9		totalDigits	4		fractionDigits	1	
Kind	Value	Annotation														
minInclusive	0.1															
maxInclusive	999.9															
totalDigits	4															
fractionDigits	1															
source	<code>&lt;element name="PAA_StsScore" type="Zahl3_1" minOccurs="0"/&gt;</code>															

#### element **PatientenaufnahmeAortenklappeBasis/PAA\_HypertonusSchluessel**

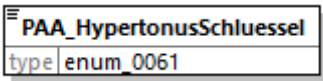
diagram													
type	<a href="#">enum 0061</a>												
properties	content simple												
facets	<table border="1"> <thead> <tr> <th>Kind</th> <th>Value</th> <th>Annotation</th> </tr> </thead> <tbody> <tr> <td>enumeration</td> <td>0061001</td> <td>documentation ja</td> </tr> <tr> <td>enumeration</td> <td>0061002</td> <td>documentation nein</td> </tr> <tr> <td>enumeration</td> <td>0061099</td> <td>documentation unbekannt</td> </tr> </tbody> </table>	Kind	Value	Annotation	enumeration	0061001	documentation ja	enumeration	0061002	documentation nein	enumeration	0061099	documentation unbekannt
Kind	Value	Annotation											
enumeration	0061001	documentation ja											
enumeration	0061002	documentation nein											
enumeration	0061099	documentation unbekannt											
source	<code>&lt;element name="PAA_HypertonusSchluessel" type="enum_0061"/&gt;</code>												

#### element **PatientenaufnahmeAortenklappeBasis/PAA\_MyokardinfarktSchluessel**

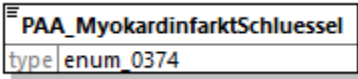
diagram																									
type	<a href="#">enum 0374</a>																								
properties	content simple																								
facets	<table border="1"> <thead> <tr> <th>Kind</th> <th>Value</th> <th>Annotation</th> </tr> </thead> <tbody> <tr> <td>enumeration</td> <td>0374001</td> <td>documentation nein</td> </tr> <tr> <td>enumeration</td> <td>0374002</td> <td>documentation ja, &amp;lt;= 6 Stunden</td> </tr> <tr> <td>enumeration</td> <td>0374003</td> <td>documentation ja, &amp;gt; 6 Stunden bis &amp;lt;= 24 Stunden</td> </tr> <tr> <td>enumeration</td> <td>0374004</td> <td>documentation ja, &amp;gt; 1 bis 7 Tage</td> </tr> <tr> <td>enumeration</td> <td>0374005</td> <td>documentation ja, &amp;gt; 7 bis 21 Tage</td> </tr> <tr> <td>enumeration</td> <td>0374006</td> <td>documentation ja, &amp;gt; 21 Tage</td> </tr> <tr> <td>enumeration</td> <td>0374099</td> <td>documentation unbekannt</td> </tr> </tbody> </table>	Kind	Value	Annotation	enumeration	0374001	documentation nein	enumeration	0374002	documentation ja, &lt;= 6 Stunden	enumeration	0374003	documentation ja, &gt; 6 Stunden bis &lt;= 24 Stunden	enumeration	0374004	documentation ja, &gt; 1 bis 7 Tage	enumeration	0374005	documentation ja, &gt; 7 bis 21 Tage	enumeration	0374006	documentation ja, &gt; 21 Tage	enumeration	0374099	documentation unbekannt
Kind	Value	Annotation																							
enumeration	0374001	documentation nein																							
enumeration	0374002	documentation ja, &lt;= 6 Stunden																							
enumeration	0374003	documentation ja, &gt; 6 Stunden bis &lt;= 24 Stunden																							
enumeration	0374004	documentation ja, &gt; 1 bis 7 Tage																							
enumeration	0374005	documentation ja, &gt; 7 bis 21 Tage																							
enumeration	0374006	documentation ja, &gt; 21 Tage																							
enumeration	0374099	documentation unbekannt																							
source	<code>&lt;element name="PAA_MyokardinfarktSchluessel" type="enum_0374"/&gt;</code>																								

element **PatientenaufnahmeAortenklappeBasis/PAA\_SymptomeSchluessel**

diagram			
type	<a href="#">enum 0375</a>		
properties	content simple		
facets	Kind	Value	Annotation
	enumeration	0375001	documentation keine Symptome oder Angina
	enumeration	0375002	documentation Symptome, aber keine Ischämiezeichen
	enumeration	0375003	documentation stabile Angina
	enumeration	0375004	documentation instabile Angina
	enumeration	0375005	documentation Infarkt ohne ST-Hebung (Non-STEMI)
	enumeration	0375006	documentation Infarkt mit ST-Hebung (STEMI)
	enumeration	0375042	documentation unbekannt
source	<pre>&lt;element name="PAA_SymptomeSchluessel" type="enum_0375"/&gt;</pre>		

complexType **InfektionAortenklappeBasis**

diagram			
namespace	http://xml.ir-d.de/emg		
children	<a href="#">IAK_InfektionSchluessel</a>		
used by	element	<a href="#">PatientenaufnahmeAortenklappe/infektionAortenklappe</a>	
source	<pre>&lt;complexType name="InfektionAortenklappeBasis"&gt;   &lt;sequence&gt;     &lt;element name="IAK_InfektionSchluessel" type="enum_0367"/&gt;   &lt;/sequence&gt; &lt;/complexType&gt;</pre>		

element **InfektionAortenklappeBasis/IAK\_InfektionSchluessel**

diagram			
type	<a href="#">enum 0367</a>		
properties	content simple		
facets	Kind	Value	Annotation
	enumeration	0367001	documentation keine
	enumeration	0367002	documentation Mediastinitis
	enumeration	0367003	documentation Sepsis
	enumeration	0367004	documentation

	enumeration	0367005	broncho-pulmonale Infektion documentation
	enumeration	0367006	oto-laryngologische Infektion documentation
	enumeration	0367007	floride Endokarditis documentation
	enumeration	0367008	Peritonitis documentation
	enumeration	0367009	Wundinfektion Thorax documentation
	enumeration	0367010	Pleuraempyem documentation
	enumeration	0367011	Venenkatheterinfektion documentation
	enumeration	0367012	Hamwegsinfektion documentation
	enumeration	0367013	Wundinfektion untere Extremitäten documentation
	enumeration	0367014	HIV-Infektion documentation
	enumeration	0367015	Hepatitis B oder C documentation
	enumeration	0367042	andere Wundinfektion documentation
	enumeration		sonstige Infektion
source	<code>&lt;element name="IAK_InfektionSchluessel" type="enum_0367"/&gt;</code>		

complexType **ArtikelbeschreibungBasis**

<p>diagram</p>	
<p>namespace</p>	<p>http://xml.ir-d.de/emg</p>
<p>children</p>	<p><a href="#">ARB LotNumber</a> <a href="#">ARB LotNumberUnbekannt</a> <a href="#">ARB SerienNumber</a> <a href="#">ARB SerienNumberUnbekannt</a>  <a href="#">ARB DatumVerfall</a> <a href="#">ARB DatumVerfallUnbekannt</a> <a href="#">ARB Artikelbezeichnung</a> <a href="#">ARB Barcode</a>  <a href="#">ARB DatumImplantierungExplantat</a> <a href="#">ARB DatumImplantierungExplantatUnbekannt</a></p>
<p>used by</p>	<p>complexType <a href="#">Artikelbeschreibung</a></p>
<p>source</p>	<pre>&lt;complexType name="ArtikelbeschreibungBasis"&gt;   &lt;sequence&gt;     &lt;choice minOccurs="0"&gt;       &lt;element name="ARB_LotNumber" type="String20"/&gt;       &lt;element name="ARB_LotNumberUnbekannt" type="JaLeer"/&gt;     &lt;/choice&gt;     &lt;choice minOccurs="0"&gt;       &lt;element name="ARB_SerienNumber" type="String20"/&gt;       &lt;element name="ARB_SerienNumberUnbekannt" type="JaLeer"/&gt;     &lt;/choice&gt;     &lt;choice minOccurs="0"&gt;</pre>

	<pre> &lt;element name="ARB_DatumVerfall" type="String20"/&gt; &lt;element name="ARB_DatumVerfallUnbekannt" type="JaLeer"/&gt; &lt;/choice&gt; &lt;element name="ARB_Artikelbezeichnung" type="Freitext250" minOccurs="0"/&gt; &lt;element name="ARB_Barcode" type="Freitext250" minOccurs="0"/&gt; &lt;choice minOccurs="0"&gt;   &lt;element name="ARB_DatumImplantierungExplantat" type="DatumText"/&gt;   &lt;element name="ARB_DatumImplantierungExplantatUnbekannt" type="JaLeer"/&gt; &lt;/choice&gt; &lt;/sequence&gt; &lt;/complexType&gt; </pre>
--	--

element **ArtikelbeschreibungBasis/ARB\_LotNumer**

diagram							
type	<a href="#">String20</a>						
properties	content simple						
facets	<table border="1"> <thead> <tr> <th>Kind</th> <th>Value</th> <th>Annotation</th> </tr> </thead> <tbody> <tr> <td>maxLength</td> <td>20</td> <td></td> </tr> </tbody> </table>	Kind	Value	Annotation	maxLength	20	
Kind	Value	Annotation					
maxLength	20						
source	<code>&lt;element name="ARB_LotNumer" type="String20"/&gt;</code>						

element **ArtikelbeschreibungBasis/ARB\_LotNumerUnbekannt**

diagram							
type	<a href="#">JaLeer</a>						
properties	content simple						
facets	<table border="1"> <thead> <tr> <th>Kind</th> <th>Value</th> <th>Annotation</th> </tr> </thead> <tbody> <tr> <td>pattern</td> <td>(1)</td> <td></td> </tr> </tbody> </table>	Kind	Value	Annotation	pattern	(1)	
Kind	Value	Annotation					
pattern	(1)						
source	<code>&lt;element name="ARB_LotNumerUnbekannt" type="JaLeer"/&gt;</code>						

element **ArtikelbeschreibungBasis/ARB\_SerienNumer**

diagram							
type	<a href="#">String20</a>						
properties	content simple						
facets	<table border="1"> <thead> <tr> <th>Kind</th> <th>Value</th> <th>Annotation</th> </tr> </thead> <tbody> <tr> <td>maxLength</td> <td>20</td> <td></td> </tr> </tbody> </table>	Kind	Value	Annotation	maxLength	20	
Kind	Value	Annotation					
maxLength	20						
source	<code>&lt;element name="ARB_SerienNumer" type="String20"/&gt;</code>						

element **ArtikelbeschreibungBasis/ARB\_SerienNummerUnbekannt**

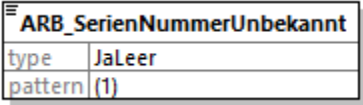
diagram	
type	<a href="#">JaLeer</a>
properties	content simple
facets	Kind Value Annotation pattern (1)
source	<code>&lt;element name="ARB_SerienNummerUnbekannt" type="JaLeer"/&gt;</code>

element **ArtikelbeschreibungBasis/ARB\_DatumVerfall**

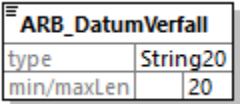
diagram	
type	<a href="#">String20</a>
properties	content simple
facets	Kind Value Annotation maxLength 20
source	<code>&lt;element name="ARB_DatumVerfall" type="String20"/&gt;</code>

element **ArtikelbeschreibungBasis/ARB\_DatumVerfallUnbekannt**

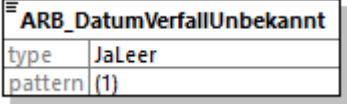
diagram	
type	<a href="#">JaLeer</a>
properties	content simple
facets	Kind Value Annotation pattern (1)
source	<code>&lt;element name="ARB_DatumVerfallUnbekannt" type="JaLeer"/&gt;</code>

element **ArtikelbeschreibungBasis/ARB\_Artikelbezeichnung**

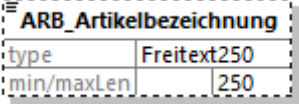
diagram	
type	<a href="#">Freitext250</a>
properties	minOcc 0 maxOcc 1 content simple
facets	Kind Value Annotation maxLength 250

source	<code>&lt;element name="ARB_Artikelbezeichnung" type="Freitext250" minOccurs="0"/&gt;</code>
--------	--

element **ArtikelbeschreibungBasis/ARB\_Barcode**

diagram							
type	<a href="#">Freitext250</a>						
properties	minOcc 0 maxOcc 1 content simple						
facets	<table border="1"> <thead> <tr> <th>Kind</th> <th>Value</th> <th>Annotation</th> </tr> </thead> <tbody> <tr> <td>maxLength</td> <td>250</td> <td></td> </tr> </tbody> </table>	Kind	Value	Annotation	maxLength	250	
Kind	Value	Annotation					
maxLength	250						
source	<code>&lt;element name="ARB_Barcode" type="Freitext250" minOccurs="0"/&gt;</code>						

element **ArtikelbeschreibungBasis/ARB\_DatumImplantierungExplantat**

diagram							
type	<a href="#">DatumText</a>						
properties	content simple						
facets	<table border="1"> <thead> <tr> <th>Kind</th> <th>Value</th> <th>Annotation</th> </tr> </thead> <tbody> <tr> <td>pattern</td> <td>((([0-9]{4})([0-9]{2})?)([0-9]{2})?)</td> <td></td> </tr> </tbody> </table>	Kind	Value	Annotation	pattern	((([0-9]{4})([0-9]{2})?)([0-9]{2})?)	
Kind	Value	Annotation					
pattern	((([0-9]{4})([0-9]{2})?)([0-9]{2})?)						
source	<code>&lt;element name="ARB_DatumImplantierungExplantat" type="DatumText"/&gt;</code>						

element **ArtikelbeschreibungBasis/ARB\_DatumImplantierungExplantatUnbekannt**

diagram							
type	<a href="#">JaLeer</a>						
properties	content simple						
facets	<table border="1"> <thead> <tr> <th>Kind</th> <th>Value</th> <th>Annotation</th> </tr> </thead> <tbody> <tr> <td>pattern</td> <td>(1)</td> <td></td> </tr> </tbody> </table>	Kind	Value	Annotation	pattern	(1)	
Kind	Value	Annotation					
pattern	(1)						
source	<code>&lt;element name="ARB_DatumImplantierungExplantatUnbekannt" type="JaLeer"/&gt;</code>						

complexType **ArtikelBrustimplantatBasis**

<p>diagram</p>	
<p>namespace</p>	<p>http://xml.ir-d.de/emg</p>
<p>children</p>	<p><a href="#">ABI_HerstellerSchluessel</a> <a href="#">ABI_HerstellerUnbekannt</a> <a href="#">ABI_HerstellerSonstiger</a> <a href="#">ABI_ArtikelTypSchluessel</a> <a href="#">ABI_FormSchluessel</a> <a href="#">ABI_FormUnbekannt</a> <a href="#">ABI_OberflaecheSchluessel</a> <a href="#">ABI_OberflaecheUnbekannt</a> <a href="#">ABI_FuellungSchluessel</a> <a href="#">ABI_FuellungUnbekannt</a> <a href="#">ABI_Volumen</a> <a href="#">ABI_VolumenUnbekannt</a> <a href="#">ABI_IntraoperativesVolumen</a></p>
<p>used by</p>	<p>element <a href="#">Artikelbeschreibung/artikelBrustimplantat</a></p>
<p>source</p>	<pre>&lt;complexType name="ArtikelBrustimplantatBasis"&gt;   &lt;sequence&gt;     &lt;choice&gt;</pre>



```

<element name="ABI_HerstellerSchluessel" type="enum_0130"/>
<element name="ABI_HerstellerUnbekannt" type="JaLeer"/>
</choice>
<element name="ABI_HerstellerSonstiger" type="Freitext250" minOccurs="0"/>
<element name="ABI_ArtikelTypSchluessel" type="enum_0190"/>
<choice>
  <element name="ABI_FormSchluessel" type="enum_0126"/>
  <element name="ABI_FormUnbekannt" type="JaLeer"/>
</choice>
<choice>
  <element name="ABI_OberflaecheSchluessel" type="enum_0128"/>
  <element name="ABI_OberflaecheUnbekannt" type="JaLeer"/>
</choice>
<choice>
  <element name="ABI_FuellungSchluessel" type="enum_0124"/>
  <element name="ABI_FuellungUnbekannt" type="JaLeer"/>
</choice>
<choice>
  <element name="ABI_Volumen" type="Zahl5"/>
  <element name="ABI_VolumenUnbekannt" type="JaLeer"/>
</choice>
<element name="ABI_IntraoperativesVolumen" type="Zahl5mitNull"
minOccurs="0"/>
</sequence>
</complexType>

```

#### element ArtikelBrustimplantatBasis/ABI\_HerstellerSchluessel

diagram			
type	<a href="#">enum 0130</a>		
properties	content simple		
facets	Kind	Value	Annotation
	enumeration	0130001	documentation Allergan
	enumeration	0130002	documentation Cereplas
	enumeration	0130003	documentation CUI (Cox Uphoff Implants)
	enumeration	0130004	documentation EMSI Biomedical
	enumeration	0130005	documentation Establishment labs
	enumeration	0130006	documentation Eurosilicone
	enumeration	0130007	documentation Nagor
	enumeration	0130008	documentation Groupe Sebbin
	enumeration	0130009	documentation Laboratoires Arion
	enumeration	0130010	documentation Mentor
	enumeration	0130011	documentation Pérouse Plastie SAS
	enumeration	0130012	documentation PIP M-Implants

	enumeration	0130013	documentation	Polytech Health & Aesthetics
	enumeration	0130014	documentation	Silimed
	enumeration	0130015	documentation	Surgitek
	enumeration	0130016	documentation	G&G Biotechnology
	enumeration	0130017	documentation	nicht belegter Wert
	enumeration	0130018	documentation	nicht belegter Wert
	enumeration	0130019	documentation	nicht belegter Wert
	enumeration	0130020	documentation	nicht belegter Wert
	enumeration	0130021	documentation	nicht belegter Wert
	enumeration	0130042	documentation	sonstiger
source	<code>&lt;element name="ABI_HerstellerSchluessel" type="enum_0130"/&gt;</code>			

element **ArtikelBrustimplantatBasis/ABI\_HerstellerUnbekannt**

diagram	
type	<a href="#">JaLeer</a>
properties	content simple
facets	Kind Value Annotation pattern (1)
source	<code>&lt;element name="ABI_HerstellerUnbekannt" type="JaLeer"/&gt;</code>

element **ArtikelBrustimplantatBasis/ABI\_HerstellerSonstiger**

diagram	
type	<a href="#">Freitext250</a>
properties	minOcc 0 maxOcc 1 content simple
facets	Kind Value Annotation maxLength 250
source	<code>&lt;element name="ABI_HerstellerSonstiger" type="Freitext250" minOccurs="0"/&gt;</code>

element **ArtikelBrustimplantatBasis/ABI\_ArtikelTypSchluessel**

diagram	
---------	--

type	<a href="#">enum_0190</a>									
properties	content simple									
facets	<table border="1"> <thead> <tr> <th>Kind</th> <th>Value</th> <th>Annotation</th> </tr> </thead> <tbody> <tr> <td>enumeration</td> <td>0190001</td> <td>documentation Brustimplantat</td> </tr> <tr> <td>enumeration</td> <td>0190003</td> <td>documentation Brustexpander</td> </tr> </tbody> </table>	Kind	Value	Annotation	enumeration	0190001	documentation Brustimplantat	enumeration	0190003	documentation Brustexpander
Kind	Value	Annotation								
enumeration	0190001	documentation Brustimplantat								
enumeration	0190003	documentation Brustexpander								
source	<code>&lt;element name="ABI_ArtikelTypSchluessel" type="enum_0190"/&gt;</code>									

#### element ArtikelBrustimplantatBasis/ABI\_FormSchluessel

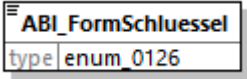
diagram													
type	<a href="#">enum_0126</a>												
properties	content simple												
facets	<table border="1"> <thead> <tr> <th>Kind</th> <th>Value</th> <th>Annotation</th> </tr> </thead> <tbody> <tr> <td>enumeration</td> <td>0126001</td> <td>documentation anatomisch (tropfenförmig)</td> </tr> <tr> <td>enumeration</td> <td>0126002</td> <td>documentation rund (punktsymmetrisch)</td> </tr> <tr> <td>enumeration</td> <td>0126042</td> <td>documentation sonstige</td> </tr> </tbody> </table>	Kind	Value	Annotation	enumeration	0126001	documentation anatomisch (tropfenförmig)	enumeration	0126002	documentation rund (punktsymmetrisch)	enumeration	0126042	documentation sonstige
Kind	Value	Annotation											
enumeration	0126001	documentation anatomisch (tropfenförmig)											
enumeration	0126002	documentation rund (punktsymmetrisch)											
enumeration	0126042	documentation sonstige											
source	<code>&lt;element name="ABI_FormSchluessel" type="enum_0126"/&gt;</code>												

#### element ArtikelBrustimplantatBasis/ABI\_FormUnbekannt

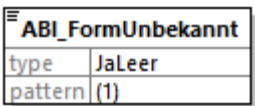
diagram							
type	<a href="#">JaLeer</a>						
properties	content simple						
facets	<table border="1"> <thead> <tr> <th>Kind</th> <th>Value</th> <th>Annotation</th> </tr> </thead> <tbody> <tr> <td>pattern</td> <td>(1)</td> <td></td> </tr> </tbody> </table>	Kind	Value	Annotation	pattern	(1)	
Kind	Value	Annotation					
pattern	(1)						
source	<code>&lt;element name="ABI_FormUnbekannt" type="JaLeer"/&gt;</code>						

#### element ArtikelBrustimplantatBasis/ABI\_OberflaecheSchluessel

diagram													
type	<a href="#">enum_0128</a>												
properties	content simple												
facets	<table border="1"> <thead> <tr> <th>Kind</th> <th>Value</th> <th>Annotation</th> </tr> </thead> <tbody> <tr> <td>enumeration</td> <td>0128001</td> <td>documentation glattwandig</td> </tr> <tr> <td>enumeration</td> <td>0128002</td> <td>documentation beschichtet</td> </tr> <tr> <td>enumeration</td> <td>0128003</td> <td>documentation</td> </tr> </tbody> </table>	Kind	Value	Annotation	enumeration	0128001	documentation glattwandig	enumeration	0128002	documentation beschichtet	enumeration	0128003	documentation
Kind	Value	Annotation											
enumeration	0128001	documentation glattwandig											
enumeration	0128002	documentation beschichtet											
enumeration	0128003	documentation											

	texturiert
source	<code>&lt;element name="ABI_OberflaecheSchluesse1" type="enum_0128"/&gt;</code>

element **ArtikelBrustimplantatBasis/ABI\_OberflaecheUnbekannt**

diagram	
type	<a href="#">JaLeer</a>
properties	content simple
facets	Kind Value Annotation pattern (1)
source	<code>&lt;element name="ABI_OberflaecheUnbekannt" type="JaLeer"/&gt;</code>

element **ArtikelBrustimplantatBasis/ABI\_FuellungSchluesse1**

diagram	
type	<a href="#">enum 0124</a>
properties	content simple
facets	Kind Value Annotation enumeration 0124001 documentation Salzlösung enumeration 0124002 documentation Silikongel enumeration 0124003 documentation Kombination Silikongel und Salzlösung enumeration 0124042 documentation sonstige
source	<code>&lt;element name="ABI_FuellungSchluesse1" type="enum_0124"/&gt;</code>

element **ArtikelBrustimplantatBasis/ABI\_FuellungUnbekannt**

diagram	
type	<a href="#">JaLeer</a>
properties	content simple
facets	Kind Value Annotation pattern (1)
source	<code>&lt;element name="ABI_FuellungUnbekannt" type="JaLeer"/&gt;</code>

element **ArtikelBrustimplantatBasis/ABI\_Volumen**

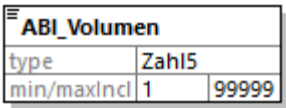
diagram										
type	<a href="#">Zahl5</a>									
properties	content simple									
facets	<table border="1"> <thead> <tr> <th>Kind</th> <th>Value</th> <th>Annotation</th> </tr> </thead> <tbody> <tr> <td>minInclusive</td> <td>1</td> <td></td> </tr> <tr> <td>maxInclusive</td> <td>99999</td> <td></td> </tr> </tbody> </table>	Kind	Value	Annotation	minInclusive	1		maxInclusive	99999	
Kind	Value	Annotation								
minInclusive	1									
maxInclusive	99999									
source	<code>&lt;element name="ABI_Volumen" type="Zahl5"/&gt;</code>									

element **ArtikelBrustimplantatBasis/ABI\_VolumenUnbekannt**

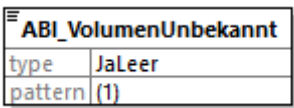
diagram							
type	<a href="#">JaLeer</a>						
properties	content simple						
facets	<table border="1"> <thead> <tr> <th>Kind</th> <th>Value</th> <th>Annotation</th> </tr> </thead> <tbody> <tr> <td>pattern</td> <td>(1)</td> <td></td> </tr> </tbody> </table>	Kind	Value	Annotation	pattern	(1)	
Kind	Value	Annotation					
pattern	(1)						
source	<code>&lt;element name="ABI_VolumenUnbekannt" type="JaLeer"/&gt;</code>						

element **ArtikelBrustimplantatBasis/ABI\_IntraoperativesVolumen**

diagram										
type	<a href="#">Zahl5mitNull</a>									
properties	<table border="1"> <tbody> <tr> <td>minOcc</td> <td>0</td> </tr> <tr> <td>maxOcc</td> <td>1</td> </tr> <tr> <td>content</td> <td>simple</td> </tr> </tbody> </table>	minOcc	0	maxOcc	1	content	simple			
minOcc	0									
maxOcc	1									
content	simple									
facets	<table border="1"> <thead> <tr> <th>Kind</th> <th>Value</th> <th>Annotation</th> </tr> </thead> <tbody> <tr> <td>minInclusive</td> <td>0</td> <td></td> </tr> <tr> <td>maxInclusive</td> <td>99999</td> <td></td> </tr> </tbody> </table>	Kind	Value	Annotation	minInclusive	0		maxInclusive	99999	
Kind	Value	Annotation								
minInclusive	0									
maxInclusive	99999									
source	<code>&lt;element name="ABI_IntraoperativesVolumen" type="Zahl5mitNull" minOccurs="0"/&gt;</code>									

complexType **ArtikelEndoprotheseBasis**

diagram	
namespace	http://xml.ir-d.de/emg
children	<a href="#">AEP HerstellerSchluessel</a> <a href="#">AEP HerstellerUnbekannt</a> <a href="#">AEP HerstellerSonstiger</a> <a href="#">AEP ArtikelTypSchluessel</a>
used by	element <a href="#">Artikelbeschreibung/artikelEndoprothese</a>
source	<pre> &lt;complexType name="ArtikelEndoprotheseBasis"&gt;   &lt;sequence&gt;     &lt;choice&gt;       &lt;element name="AEP_HerstellerSchluessel" type="enum_0230"/&gt;       &lt;element name="AEP_HerstellerUnbekannt" type="JaLeer"/&gt;     &lt;/choice&gt;     &lt;element name="AEP_HerstellerSonstiger" type="Freitext250" minOccurs="0"/&gt;     &lt;element name="AEP_ArtikelTypSchluessel" type="enum_0290"/&gt;   &lt;/sequence&gt; &lt;/complexType&gt; </pre>

element **ArtikelEndoprotheseBasis/AEP\_HerstellerSchluessel**

diagram																															
type	<a href="#">enum 0230</a>																														
properties	content simple																														
facets	<table border="1"> <thead> <tr> <th>Kind</th> <th>Value</th> <th>Annotation</th> </tr> </thead> <tbody> <tr> <td>enumeration</td> <td>0230001</td> <td>documentation Smith &amp; Nephew GmbH</td> </tr> <tr> <td>enumeration</td> <td>0230002</td> <td>documentation Mathys Orthopädie GmbH</td> </tr> <tr> <td>enumeration</td> <td>0230003</td> <td>documentation Ceramtec AG</td> </tr> <tr> <td>enumeration</td> <td>0230004</td> <td>documentation Biomet</td> </tr> <tr> <td>enumeration</td> <td>0230005</td> <td>documentation Peter Brehm GmbH</td> </tr> <tr> <td>enumeration</td> <td>0230006</td> <td>documentation Amplitude GmbH</td> </tr> <tr> <td>enumeration</td> <td>0230007</td> <td>documentation Exactech Deutschland</td> </tr> <tr> <td>enumeration</td> <td>0230008</td> <td>documentation Globus Medical</td> </tr> <tr> <td>enumeration</td> <td>0230009</td> <td>documentation Implantcast GmbH</td> </tr> </tbody> </table>	Kind	Value	Annotation	enumeration	0230001	documentation Smith & Nephew GmbH	enumeration	0230002	documentation Mathys Orthopädie GmbH	enumeration	0230003	documentation Ceramtec AG	enumeration	0230004	documentation Biomet	enumeration	0230005	documentation Peter Brehm GmbH	enumeration	0230006	documentation Amplitude GmbH	enumeration	0230007	documentation Exactech Deutschland	enumeration	0230008	documentation Globus Medical	enumeration	0230009	documentation Implantcast GmbH
Kind	Value	Annotation																													
enumeration	0230001	documentation Smith & Nephew GmbH																													
enumeration	0230002	documentation Mathys Orthopädie GmbH																													
enumeration	0230003	documentation Ceramtec AG																													
enumeration	0230004	documentation Biomet																													
enumeration	0230005	documentation Peter Brehm GmbH																													
enumeration	0230006	documentation Amplitude GmbH																													
enumeration	0230007	documentation Exactech Deutschland																													
enumeration	0230008	documentation Globus Medical																													
enumeration	0230009	documentation Implantcast GmbH																													

enumeration	0230010	documentation DePuy Orthopädie GmbH (J&J)
enumeration	0230011	documentation IO-International Orthopaedics
enumeration	0230012	documentation Joint Replacement Ltd. Instrumentation
enumeration	0230013	documentation Merete
enumeration	0230014	documentation S&G Implants GmbH
enumeration	0230015	documentation Speetec Implantate GmbH
enumeration	0230016	documentation Stemcup Medical Products GmbH
enumeration	0230017	documentation Symbios Deutschland GmbH
enumeration	0230018	documentation Tantum AG
enumeration	0230019	documentation Tomier GmbH
enumeration	0230020	documentation MicroPort Orthopedics GmbH
enumeration	0230021	documentation aap Implanate AG
enumeration	0230022	documentation AQImplants
enumeration	0230023	documentation ESKA Orthodynamics GmbH
enumeration	0230024	documentation Atesos medical AG
enumeration	0230025	documentation Chiropro GmbH
enumeration	0230026	documentation Medacta
enumeration	0230027	documentation OHST Medizintechnik AG
enumeration	0230028	documentation Lima Deutschland GmbH
enumeration	0230029	documentation alloPlus GmbH
enumeration	0230030	documentation Heraeus Medical GmbH
enumeration	0230031	documentation ImplanTec Deutschland GmbH
enumeration	0230032	documentation Falcon Medical GmbH
enumeration	0230033	documentation Meril GmbH
enumeration	0230034	documentation Zimmer Germany GmbH
enumeration	0230035	documentation Stryker GmbH & Co. KG
enumeration	0230036	documentation Aesculap AG
enumeration	0230037	documentation Waldemar Link GmbH & Co. KG
enumeration	0230038	documentation Corin Germany GmbH
enumeration	0230039	documentation ARTIQO
enumeration	0230040	documentation EuromedImplants
enumeration	0230041	documentation EvolutisGroup
enumeration	0230042	documentation

	enumeration	0230043	sonstige documentation TEKNIMED SAS
	enumeration	0230044	documentation HiPer Medical AG
	enumeration	0230045	documentation Link Italia S.p.A.
	enumeration	0230046	documentation Johnson & Johnson Medical GmbH
	enumeration	0230047	documentation MatOrtho Limited
	enumeration	0230048	documentation Adler Ortho S.P.A.
	enumeration	0230049	documentation Lincotek Bologna SRL
	enumeration	0230050	documentation Materialise
	enumeration	0230051	documentation Maxx Orthopedics Inc.
	enumeration	0230052	documentation JRI Orthopaedics
	enumeration	0230053	documentation nicht belegter Wert
	enumeration	0230054	documentation nicht belegter Wert
	enumeration	0230055	documentation nicht belegter Wert
	enumeration	0230056	documentation nicht belegter Wert
	enumeration	0230057	documentation nicht belegter Wert
	enumeration	0230058	documentation nicht belegter Wert
	enumeration	0230059	documentation nicht belegter Wert
source	<code>&lt;element name="AEP_HerstellerSchluessel" type="enum_0230"/&gt;</code>		

#### element ArtikelEndoprotheseBasis/AEP\_HerstellerUnbekannt

diagram			
type	<a href="#">JaLeer</a>		
properties	content	simple	
facets	Kind	Value	Annotation
	pattern	(1)	
source	<code>&lt;element name="AEP_HerstellerUnbekannt" type="JaLeer"/&gt;</code>		

#### element ArtikelEndoprotheseBasis/AEP\_HerstellerSonstiger

diagram			
type	<a href="#">Freitext250</a>		



properties	minOcc 0 maxOcc 1 content simple
facets	Kind Value Annotation maxLength 250
source	<element name="AEP_HerstellerSonstiger" type="Freitext250" minOccurs="0"/>

element **ArtikelEndoprotheseBasis/AEP\_ArtikelTypSchluessel**

diagram													
type	<a href="#">enum 0290</a>												
properties	content simple												
facets	<table border="1"> <thead> <tr> <th>Kind</th> <th>Value</th> <th>Annotation</th> </tr> </thead> <tbody> <tr> <td>enumeration</td> <td>0290001</td> <td>documentation Hüft-Komponente</td> </tr> <tr> <td>enumeration</td> <td>0290002</td> <td>documentation Knie-Komponente</td> </tr> <tr> <td>enumeration</td> <td>0290003</td> <td>documentation Modulare Komponente (Hüfte/Knie)</td> </tr> </tbody> </table>	Kind	Value	Annotation	enumeration	0290001	documentation Hüft-Komponente	enumeration	0290002	documentation Knie-Komponente	enumeration	0290003	documentation Modulare Komponente (Hüfte/Knie)
Kind	Value	Annotation											
enumeration	0290001	documentation Hüft-Komponente											
enumeration	0290002	documentation Knie-Komponente											
enumeration	0290003	documentation Modulare Komponente (Hüfte/Knie)											
source	<element name="AEP_ArtikelTypSchluessel" type="enum_0290"/>												

complexType **ArtikelAortenklappeBasis**

diagram	
namespace	http://xml.ir-d.de/emg
children	<a href="#">AAK ArtikelTypSchluessel</a> <a href="#">AAK HerstellerSchluessel</a> <a href="#">AAK HerstellerUnbekannt</a> <a href="#">AAK HerstellerSonstiger</a> <a href="#">AAK ProthesenGrosse</a> <a href="#">AAK ProthesenGrosseUnbekannt</a> <a href="#">AAK Dislokation</a>

used by	element <a href="#">Artikelbeschreibung/artikelAortenklappe</a>
source	<pre>&lt;complexType name="ArtikelAortenklappeBasis"&gt;   &lt;sequence&gt;     &lt;element name="AAK_ArtikelTypSchluessel" type="enum_0390" minOccurs="0"/&gt;     &lt;choice&gt;       &lt;element name="AAK_HerstellerSchluessel" type="enum_0330"/&gt;       &lt;element name="AAK_HerstellerUnbekannt" type="JaLeer"/&gt;     &lt;/choice&gt;     &lt;element name="AAK_HerstellerSonstiger" type="Freitext250" minOccurs="0"/&gt;     &lt;choice&gt;       &lt;element name="AAK_ProthesenGroesse" type="Zahl2"/&gt;       &lt;element name="AAK_ProthesenGroesseUnbekannt" type="JaLeer"/&gt;     &lt;/choice&gt;     &lt;element name="AAK_Dislokation" type="JaLeer" minOccurs="0"/&gt;   &lt;/sequence&gt; &lt;/complexType&gt;</pre>

#### element [ArtikelAortenklappeBasis/AAK\\_ArtikelTypSchluessel](#)

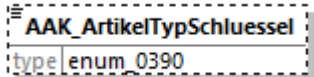
diagram										
type	<a href="#">enum_0390</a>									
properties	minOcc 0 maxOcc 1 content simple									
facets	<table border="1"> <thead> <tr> <th>Kind</th> <th>Value</th> <th>Annotation</th> </tr> </thead> <tbody> <tr> <td>enumeration</td> <td>0390001</td> <td>documentation biologisches Klappenmodell</td> </tr> <tr> <td>enumeration</td> <td>0390002</td> <td>documentation mechanisches Klappenmodell</td> </tr> </tbody> </table>	Kind	Value	Annotation	enumeration	0390001	documentation biologisches Klappenmodell	enumeration	0390002	documentation mechanisches Klappenmodell
Kind	Value	Annotation								
enumeration	0390001	documentation biologisches Klappenmodell								
enumeration	0390002	documentation mechanisches Klappenmodell								
source	<pre>&lt;element name="AAK_ArtikelTypSchluessel" type="enum_0390" minOccurs="0"/&gt;</pre>									

#### element [ArtikelAortenklappeBasis/AAK\\_HerstellerSchluessel](#)

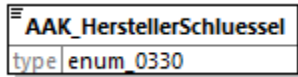
diagram																									
type	<a href="#">enum_0330</a>																								
properties	content simple																								
facets	<table border="1"> <thead> <tr> <th>Kind</th> <th>Value</th> <th>Annotation</th> </tr> </thead> <tbody> <tr> <td>enumeration</td> <td>0330001</td> <td>documentation ATS Medical</td> </tr> <tr> <td>enumeration</td> <td>0330002</td> <td>documentation Edwards Lifesciences</td> </tr> <tr> <td>enumeration</td> <td>0330003</td> <td>documentation Medtronic</td> </tr> <tr> <td>enumeration</td> <td>0330004</td> <td>documentation JenaValve</td> </tr> <tr> <td>enumeration</td> <td>0330005</td> <td>documentation Corcym</td> </tr> <tr> <td>enumeration</td> <td>0330006</td> <td>documentation Abbott Medical / St. Jude</td> </tr> <tr> <td>enumeration</td> <td>0330007</td> <td>documentation Symetis</td> </tr> </tbody> </table>	Kind	Value	Annotation	enumeration	0330001	documentation ATS Medical	enumeration	0330002	documentation Edwards Lifesciences	enumeration	0330003	documentation Medtronic	enumeration	0330004	documentation JenaValve	enumeration	0330005	documentation Corcym	enumeration	0330006	documentation Abbott Medical / St. Jude	enumeration	0330007	documentation Symetis
Kind	Value	Annotation																							
enumeration	0330001	documentation ATS Medical																							
enumeration	0330002	documentation Edwards Lifesciences																							
enumeration	0330003	documentation Medtronic																							
enumeration	0330004	documentation JenaValve																							
enumeration	0330005	documentation Corcym																							
enumeration	0330006	documentation Abbott Medical / St. Jude																							
enumeration	0330007	documentation Symetis																							

	enumeration	0330008	documentation Direct Flow Medical
	enumeration	0330009	documentation Boston Scientific
	enumeration	0330010	documentation Artivion
	enumeration	0330011	documentation Biosensors
	enumeration	0330012	documentation LivaNova
	enumeration	0330013	documentation Meril
	enumeration	0330014	documentation Sahajanand Medical Technologies
	enumeration	0330015	documentation nicht belegter Wert
	enumeration	0330016	documentation nicht belegter Wert
	enumeration	0330017	documentation nicht belegter Wert
	enumeration	0330018	documentation nicht belegter Wert
	enumeration	0330042	documentation sonstiger Hersteller
source	<code>&lt;element name="AAK_HerstellerSchluesel" type="enum_0330"/&gt;</code>		

#### element ArtikelAortenklappeBasis/AAK\_HerstellerUnbekannt

diagram							
type	<a href="#">JaLeer</a>						
properties	content simple						
facets	<table border="1"> <thead> <tr> <th>Kind</th> <th>Value</th> <th>Annotation</th> </tr> </thead> <tbody> <tr> <td>pattern</td> <td>(1)</td> <td></td> </tr> </tbody> </table>	Kind	Value	Annotation	pattern	(1)	
Kind	Value	Annotation					
pattern	(1)						
source	<code>&lt;element name="AAK_HerstellerUnbekannt" type="JaLeer"/&gt;</code>						

#### element ArtikelAortenklappeBasis/AAK\_HerstellerSonstiger

diagram							
type	<a href="#">Freitext250</a>						
properties	<table border="1"> <tbody> <tr> <td>minOcc</td> <td>0</td> </tr> <tr> <td>maxOcc</td> <td>1</td> </tr> <tr> <td>content</td> <td>simple</td> </tr> </tbody> </table>	minOcc	0	maxOcc	1	content	simple
minOcc	0						
maxOcc	1						
content	simple						
facets	<table border="1"> <thead> <tr> <th>Kind</th> <th>Value</th> <th>Annotation</th> </tr> </thead> <tbody> <tr> <td>maxLength</td> <td>250</td> <td></td> </tr> </tbody> </table>	Kind	Value	Annotation	maxLength	250	
Kind	Value	Annotation					
maxLength	250						
source	<code>&lt;element name="AAK_HerstellerSonstiger" type="Freitext250" minOccurs="0"/&gt;</code>						

element **ArtikelAortenklappeBasis/AAK\_ProthesenGrosse**

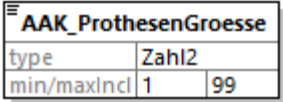
diagram										
type	<a href="#">Zahl2</a>									
properties	content simple									
facets	<table border="1"> <thead> <tr> <th>Kind</th> <th>Value</th> <th>Annotation</th> </tr> </thead> <tbody> <tr> <td>minInclusive</td> <td>1</td> <td></td> </tr> <tr> <td>maxInclusive</td> <td>99</td> <td></td> </tr> </tbody> </table>	Kind	Value	Annotation	minInclusive	1		maxInclusive	99	
Kind	Value	Annotation								
minInclusive	1									
maxInclusive	99									
source	<code>&lt;element name="AAK_ProthesenGrosse" type="Zahl2"/&gt;</code>									

element **ArtikelAortenklappeBasis/AAK\_ProthesenGrosseUnbekannt**

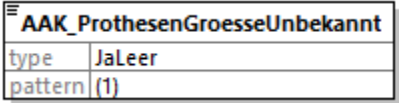
diagram							
type	<a href="#">JaLeer</a>						
properties	content simple						
facets	<table border="1"> <thead> <tr> <th>Kind</th> <th>Value</th> <th>Annotation</th> </tr> </thead> <tbody> <tr> <td>pattern</td> <td>(1)</td> <td></td> </tr> </tbody> </table>	Kind	Value	Annotation	pattern	(1)	
Kind	Value	Annotation					
pattern	(1)						
source	<code>&lt;element name="AAK_ProthesenGrosseUnbekannt" type="JaLeer"/&gt;</code>						

element **ArtikelAortenklappeBasis/AAK\_Dislokation**

diagram							
type	<a href="#">JaLeer</a>						
properties	<table border="1"> <tbody> <tr> <td>minOcc</td> <td>0</td> </tr> <tr> <td>maxOcc</td> <td>1</td> </tr> <tr> <td>content</td> <td>simple</td> </tr> </tbody> </table>	minOcc	0	maxOcc	1	content	simple
minOcc	0						
maxOcc	1						
content	simple						
facets	<table border="1"> <thead> <tr> <th>Kind</th> <th>Value</th> <th>Annotation</th> </tr> </thead> <tbody> <tr> <td>pattern</td> <td>(1)</td> <td></td> </tr> </tbody> </table>	Kind	Value	Annotation	pattern	(1)	
Kind	Value	Annotation					
pattern	(1)						
source	<code>&lt;element name="AAK_Dislokation" type="JaLeer" minOccurs="0"/&gt;</code>						